

ISSN 1800-8003

**CRNOGORSKI
GLASNIK
INTELEKTUALNE
SVOJINE**

INTELLECTUAL PROPERTY GAZETTE OF MONTENEGRO

33/2020

Službeni glasnik intelektualne svojine Crne Gore
Official Gazette of the Montenegrin Intellectual Property

MINISTARSTVO EKONOMIJE
Direktorat za unutrašnje tržište i konkurenciju
Direkcija za intelektualnu svojinu
Bulevar Mihaila Lalića br. 1,
Podgorica, Crna Gora

CRNOGORSKI GLASNIK INTELEKTUALNE SVOJINE

Godina XI

Datum objavljivanja 20.01.2020.

Izdavač:

MINISTARSTVO EKONOMIJE

Direktorat za unutrašnje tržište i konkurenciju

Direkcija za intelektualnu svojinu

Bulevar Mihaila Lalića br. 1,

Podgorica, Crna Gora

Za izdavača:

Dragica Sekulić

Glavni i odgovorni urednik:

Biljana Jakić

Urednički odbor:

Anica Zindović

Vesna Nikčević

Lidija Martić

Tehnički urednik:

Vladimir Mugoša

Crnogorski glasnik intelektualne svojine službeno je glasilo za intelektualnu svojinu Crne Gore. U Glasniku se objavljuju sve relevantnim zakonima i pravilnicima propisane informacije iz postupka dodjele prava industrijskog vlasništva, informacije o dodijeljenim pravima te o kasnijim promjenama u vezi s tim pravima, kao i ostale službene informacije.

The Montenegrin intellectual property gazette is the official gazette of the Intellectual Property of the Montenegro. The Gazette publishes all the information, prescribed by the relevant laws and regulations, relating to the industrial property granting procedure concerning granted rights and subsequent changes made in connection with such right, as well as other official information.

SADRŽAJ

DVOSLOVNE OZNAKE ZEMALJA, TERITORIJA I MEĐUNARODNIH ORGANIZACIJA / TWO LETTER CODE COUNTRIES, TERRITORIES AND INTERNATIONAL ORGANIZATIONS

PATENTI / PATENTS.....

MEĐUNARODNI KODOVI ZA IDENTIFIKACIJU BIBLIOGRAFSKIH PODATAKA O PATENTIMA PREMA WIPO STANDARDU ST. 9 / RECOMMENDATION CONCERNING BIBLIOGRAFIC DATA ON AND RELATING TO PATENTS- WIPO-ST. 9

OBJAVE PRIJAVA PATENATA / PUBLICATION OF PATENT APPLICATIONS

OBJAVA PROŠIRENIH EVROPSKIH PATENATA /PUBLICATION OF EXTENDED EUROPEAN PATENTS

OBJAVE ZAHTJEVA ZA PROŠIRENJE EVROPSKIH PRIJAVA PATENATA/ PUBLICATION OF REQUEST FOR THE EXTENSION OF THE EFFECTS OF EUROPEAN PATENT APPLICATIONS

INDEKS BROJEVA ZAHTJEVA ZA PROŠIRENJE EVROPSKIH PRIJAVA PATENTA /INDEX ON NUMBER OF REQUESTS FOR EXTENSION ON EUROPEAN PATENT APPLICATION.

INDEKS KLASIFIKACIJSKIH OZNAKA BROJEVA ZAHTJEVA ZA PROŠIRENJE EVROPSKIH PRIJAVA PATENTA PREMA MKP/INDEX ON CLASSIFICATION MARKS ON REQUESTS FOR EXTENSION OF EUROPEAN PATENT APPLICATION IN ACCORDANCE WITH THE INTERNATIONAL PATENT CLASSIFICATION

INDEKS PODNOSITELJA ZAHTJEVA ZA PROŠIRENJE EVROPSKIH PRIJAVA PATENTA / INDEX ON NUMBER OF APPLICATIONS FOR EXTENSION OF EUROPEAN PATENT APPLICATION

ŽIGOVI / TRADEMARKS.....

MEĐUNARODNI KODOVI ZA IDENTIFIKACIJU BIBLIOGRAFSKIH PODATAKA O ŽIGOVIMA PREMA WIPO ST 60/ RECOMMENDATION CONCERNING BIBLIOGRAFIC DATA RELATING TO TRADEMARKS- WIPO-ST. 60

OBJAVA PRIJAVA ŽIGOVA / PUBLICATION OF TRADEMARK APPLICATIONS

OBJAVA ŽIGOVA / PUBLICATION OF TRADEMARKS

OBJAVA UPISA PROMJENA U REGISTAR ŽIGOVA / PUBLICATION OF RECORD OF CHANGES TO THE TRADEMARK REGISTER

OBJAVA ISPRAVKI / CORRECTIONS

DIZAJN/DESIGN.....

MEĐUNARODNI KODOVI ZA IDENTIFIKACIJU BIBLIOGRAFSKIH PODATAKA O DIZAJNU PREMA WIPO ST 80/ RECOMMENDATION CONCERNING BIBLIOGRAFIC DATA RELATING TO INDUSTRIAL DESIGN- WIPO-ST. 80

OBJAVA DIZAJNA / PUBLICATION OF INDUSTRIAL DESIGN

OBJAVA UPISA PROMJENA U REGISTAR INDUSTRIJSKOG DIZAJNA / PUBLICATION OF RECORD OF CHANGES TO THE INDUSTRIAL DESIGN

DVOSLOVNE OZNAKE ZEMALJA, TERITORIJA I MEĐUNARODNIH ORGANIZACIJA (prema WIPO standardu ST. 3)

AD Andora	CG Kongo	Zaliva (GCC)
AE Ujedinjeni Arapski Emirati	CH Švajcarska	GD Grenada
AF Afganistan	CI Obala Bjelokosti	GE Gruzija
AG Antigva i Barbuda	CK Kukova ostrva	GG Guernsey
AI Angvila	CL Čile	GH Gana
AL Albanija	CM Kamerun	GI Gibraltar
AM Armenija	CN Kina	GL Grenland
AN Holandski Antili	CO Kolumbija	GM Gambija
AO Angola	CR Kostarika	GN Gvineja
AP Afrička regionalna organizacija za industrijsko vlasništvo (ARIPO)	CU Kuba	GQ Ekvatorska Gvineja
AR Argentina	CV Kabo Verde	GR Grčka
AT Austrija	CY Kipar	GS Južna Džordžija i Ostrva Južni Sendvič
AU Australija	CZ Češka Republika	GT Gvatemala
AW Aruba	DE Njemačka	GW Gvineja-Bisao
AZ Azerbejdžan	DJ Džibuti	GY Gvajana
BA Bosna i Hercegovina	DK Danska	HK Hongkong – Posebna administrativna regija
BB Barbados	DM Dominika	NR Kine
BD Bangladeš	DO Dominikanska Republika	HN Honduras
BE Belgija	DZ Alžir	HR Hrvatska
BF Burkina Faso	EA Evroazijska patentna organizacija (EAPO)	HT Haiti
BG Bugarska	EC Ekvador	HU Mađarska
BH Bahrein	EE Estonija	IB Međunarodna kancelarija Svjetske organizacije za intelektualno vlasništvo (WIPO)
BI Burundi	EG Egipat	ID Indonezija
BJ Benin	EH Zapadna Sahara	IE Irska
BM Bermudi	EM Kancelarija za harmonizaciju Unutrašnjeg tržišta (žigovi i dizajn) (OHIM)	IL Izrael
BN Brunej Darussalam	EP Evropska patentna kancelarija (EPO)	IM Ostrvo Man
BO Bolivija	ER Eritreja	IN Indija
BR Brazil	ES Španija	IQ Irak
BS Bahami	ET Etiopija	IR Iran (Islamska Republika)
BT Butan	FI Finska	IS Island
BV Ostrvo Buve	FJ Fidži	IT Italija
BW Bocvana	FK Foklandska ostrva (Malvini)	JE Džersi
BX Kancelarija za intelektualno vlasništvo Beneluksa (BOIP)	FO Farska Ostrva	JM Jamajka
BY Bjelorusija	FR Francuska	JO Jordan
BZ Belize	GA Gabon	JP Japan
CA Kanada	GB Velika Britanija	KE Kenija
CD Demokratska Republika Kongo	GC Patentna kancelarija Savjeta za saradnju država Arapskog	KG Kirgistan
CF Centralna Afrička Republika		KH Kambodža
		KI Kiribati
		KM Komori

KN Sveti Kristofor i Nevis
KP Demokratska Narodna
Republika Koreja
KR Republika Koreja
KW Kuvajt
KY Kajmanska Ostrva
KZ Kazahstan
LA Narodna Demokratska
Republika Laos
LB Libanon
LC Sveta Lucija
LI Lihtenštajn
LK Šri Lanka
LR Liberija
LS Lesoto
LT Litva
LU Luksemburg
LV Latvija
LY Libijska Arapska
Džamahirija
MA Maroko
MC Monako
MD Republika Moldavija
ME Crna Gora
MG Madagaskar
MK Sjeverna Makedonija
ML Mali
MM Mianmar
MN Mongolija
MO Makao
MP Sjeverna Marijanska
Ostrva
MR Mauritanija
MS Montserrat
MT Malta
MU Mauricijus
MV Maldivi
MW Malavi
MX Meksiko
MY Malezija
MZ Mozambik
NA Namibija
NE Niger
NG Nigerija
NI Nikaragva
NL Holandija
NO Norveška
NP Nepal
NR Nauru
NZ Novi Zeland
OA Afrička organizacija
za intelektualno
vlasništvo (OAPI)

OM Oman
PA Panama
PE Peru
PG Papuanska Nova
Gvineja
PH Filipini
PK Pakistan
PL Poljska
PT Portugal
PW Palau
PY Paragvaj
QA Katar
QZ Kancelarija Zajednice
za biljne sorte
(Evropska Unija)
(CPVO)
RO Rumunija
RS Srbija
RU Ruska Federacija
RW Ruanda
SA Saudijska Arabija
SB Solomonska Ostrva
SC Sejšeli
SD Sudan
SE Švedska
SG Singapur
SH Sveta Jelena
SI Slovenija
SK Slovačka
SL Sijera Leone
SM San Marino
SN Senegal
SO Somalija
SR Surinam
ST Sveti Toma i Princip
SV Salvador
SY Sirijska Arapska
Republika
SZ Svazi
TC Turska i Kajkoska
Ostrva
TD Čad
TG Togo
TH Tajland
TJ Tadžikistan
TL Istočni Timor
TM Turkmenistan
TN Tunis
TO Tonga
TR Turska
TT Trinidad i Tobago
TV Tuvalu
TW Tajvan, Kineska

Pokrajina
TZ Ujedinjena Republika
Tanzanija
UA Ukrajina
UG Uganda
US Sjedinjene Američke
Države
UY Urugvaj
UZ Uzbekistan
VA Sveta Stolica (Vatikan)
VC Sveti Vincent i
Grenadini
VE Venecuela
VG Britanska Djevičanska
Ostrva
VN Vijetnam
VU Vanuatu
WO Svjetska organizacije
za intelektualno
vlasništvo (WIPO)
(Međunarodna
kancelarija)
WS Samoa
XN Nordijski institut za
patente (NPI)
YE Jemen
ZA Južnoafrička
Republika
ZM Zambija
ZW Zimbabve

PATENTI
PATENTS

MEĐUNARODNI KODOVI ZA IDENTIFIKACIJU BIBLIOGRAFSKIH PODATAKA O PATENTIMA PREMA
WIPO STANDARDU ST. 9 / RECOMMENDATION CONCERNING BIBLIOGRAFIC DATA ON AND
RELATING TO PATENTS- WIPO-ST. 9

CRNOGORSKI	MDK	ENGLESKI
IDENTIFIKATOR DOKUMENTA	10	IDENTIFICATION OF THE PATENT
BROJ DOKUMENTA	11	NUMBER OF THE PATENT
VRSTA DOKUMENTA	13	KIND-OF-DOCUMENT CODE ACCORDING TO WIPO STANDARD
BROJ PRIJAVE	21	NUMBER(S) ASSIGNED TO THE APPLICATION(S)
DATUM PODNOŠENJA PRIJAVE	22	DATE(S) OF FILING THE APPLICATION(S)
DATUM IZLAGANJA NA MEĐUNARODNOJ IZLOŽBI	23	DATE OF EXHIBITING AT THE INTERNATIONAL EXHIBITION
PODACI O PRAVU PRVJENSTVA	30	PRIORITY DATA
DATUM OBJAVLJIVANJA PRIJAVE	43	PUBLICATION DATE OF THE UNEXAMINED APPLICATION
DATUM OBJAVLJIVANJA PATENTA	45	PUBLICATION DATE OF REGISTERED PATENT
MEĐUNARODNA KLASIFIKACIJA PATENATA	51	INTERNATIONAL PATENT CLASSIFICATION CODE
NAZIV PRONALASKA	54	TITLE OF THE INVENTION
APSTRAKT ILI PATENTNI ZAHTEJEV	57	ABSTRACT OR CLAIM
BROJ OSNOVNE PRIJAVE (ILI PATENTA) ZA KOJI SE PODNOSI DOPUNSKA PRIJAVA	61	NUMBER OF THE EARLIER APPLICATION (OR PATENT) TO WHICH THE PRESENT DOCUMENT IS AN ADDITION
BROJ PRVOBITNE PRIJAVE IZ KOJE JE PRIJAVA IZDVOJENA	62	NUMBER OF THE EARLIER APPLICATION FROM WHICH THE PRESENT DOCUMENT HAS BEEN DIVIDED UP
IME PODNOSIOCA PRIJAVE	71	NAME OF THE APPLICANT
IME PRONALAZAČA	72	NAME OF THE INVENTOR
IME NOSIOCA PATENTA	73	NAME OF THE OWNER OF PATENT
IME PUNOMOĆNIKA	74	NAME OF THE REPRESENTATIVE
BROJ I DATUM PODNOŠENJA MEĐUNARODNE PRIJAVE	86	NUMBER AND FILING DATE OF THE INTERNATIONAL APPLICATION
BROJ I DATUM MEĐUNARODNE OBJAVE	87	NUMBER AND DATE OF THE PUBLICATION OF THE INTERNATIONAL APPLICATION

OBJAVE PRIJAVA PATENATA
PUBLICATION OF PATENT APPLICATIONS

(11) **03496** (13) **B**

(51) **A01N 3/00**^(2006.01)

(21) P-2019-204

(22) 12.07.2019

(54) me **DERIVAT PIRAZOLA I NJEGOV KOBALTOV KOMPLEKS ZA SUZBIJANJE GLJIVE PHOMOPSIS VITICOLA SACC. BIOEXTRA PZ**
en **PYRAZOLE DERIVATIVE AND ITS COBALT COMPLEX FOR THE CONTROL OF FUNGI PHOMOPSIS VITICOLA SACC. BIOEXTRA PZ**

(73) JAĆIMOVIĆ, Željko

Studentska bb, lamela 2, stan 10, Podgorica, 81000/ ME

(72) JAĆIMOVIĆ, Željko

Studentska bb, lamela 2, stan 10, Podgorica, 81000/ ME

LATINOVIĆ, Nedeljko

Studentska bb, lamela 2, 36/IV, Podgorica, 81000/ ME

Latinović, Jelena

Studentska bb, lamela 2, 36/IV, Podgorica, 81000/ ME

KOSOVIĆ PERUTOVIĆ, Milica

ul. Dr Vukašina Markovića 72, Podgorica, 81000/ ME

(57)

Patent spada u obast očuvanja ljudskih ili životinjskih ili biljnih organizama ili njihovih djelova, odnosno pesticida. Namijenjen je za suzbljanje prouzrokovača crne pjegavosti vinove loze Phomopsis viticola. Navedena jedinjenja su jednako efikasna kao i komercijalni fungicid.

Korišćenje navedenih jedinjenja i rastvora koncentracija sa podacima prema uticaju na porast micelije gljive Phomopsis viticola i njihova poređenje sa komercijalnim fungicidom, dati su u tabelama 01, 02 i 03.

OBJAVA PROŠIRENIH EUROPSKIH PATENATA
PUBLICATION OF EXTENDED EUROPEAN PATENTS

(11) **03434** (13) **B**

(51) **A47K 10/38**^(2006.01)

A47K 10/32^(2006.01)

(21) P-2018-121

(22) 12.05.2015

(30) 3992014 23.05.2014 AT

(96) 15730378.5/12.05.2015

(86) AT PCT/AT2015/000072/12.05.2015

(87) WO 2015/176085/26.11.2015/2015/47

(97) EP 3145378/29.03.2017/2017/13

EP 3145378/07.03.2018/2018/10

(54) me **NOSEĆA ŠIPKA**

en **SUPPORTING ROD**

(73) HAGLEITNER, Hans Georg

Lindenallee 11, Zell am See, 5700/ AT

(72) Hagleitner, Hans Georg

Lindenallee 11, 5700 Zell am See/ AT

(57)

1. Noseća šipka sa dva ležišna rukavca (4, 5) za u rolnu (3) bez jezgra namotanu traku materijala (26), koja obuhvata dva dela (6, 7) koja se sužavaju i mogu sa suprotnih strana aksijalno da se uvuku u rolnu (3), koji su različito dugački i svaki ima po jednu prirubnicu (I, II), koja čini graničnik za dubinu uvlačenja, prvi deo (6) čini deo jezgra i u stanju upotrebe viri sa obe strane iz rolne (3), pri čemu krajevi koji vire čine oba ležišna rukavca (4, 5), a drugi deo (7) je napravljen kao čaura, što deo za uvlačenje prvog dela (6) viri kao prvi ležišni rukavac (4) iz prirubnice (II) čaure, **naznačen time**, što je drugi deo (7) navučen na prvi deo (6) i zabavljen.

Patent sadrži još 6 patentnih zahtjeva

(11) **03445** (13) **B**

(51) **C07K14/47**^(2006.01)

A61K39/395^(2006.01)

C07K16/30^(2006.01)

A61P35/00^(2006.01)

(21) P-2018-170

(22) 18.05.2005

(30) 20041024617 18.05.2004 DE

(96) 11002013.8/18.05.2005

(97) EP 2371848/05.10.2011/2011/40

EP 2371848/18.04.2018/2018/16

(54) me **GENSKI PROIZVODI KOJI SU DIFERENCIJALNO IZRAŽENI U TUMORIMA I NJIHOVA PRIMENA**

en **Differential in tumour gene products and use of same**

(73) Astellas Pharma Inc.

5-1, Nihonbashi-Honcho 2-chome, Chuo-ku, Tokyo 103-8411/ JP

(72) TÜRECI, Özlem

Philipp-von-Zabern-Platz 1, 55116 Mainz/ DE

SAHIN, Ugur

Philipp-von-Zabern Platz 1, Mainz, 55116 / DE

KOSLOWSKI, Michael

Autogenstrasse 50, Frankfurt, 65933 / DE

FRITZ, Stefan

Geisterweg 35, Flonheim, 55237/ DE

GEPPERT, Harald-Gerhard

Grünstrasse 46, Solingen, 42697/ DE

(57)

1. Primjena antitijela u postupku detekcije tumorskih ćelija koje izražavaju antigen povezan sa tumorom, pri čemu se antitijelo vezuje za antigen povezan sa tumorom, pri čemu se antitijelo može dobiti imunizacijom sapeptidomilipolipeptidom koji ima aminokiselinsku sekvencu izabrana iz grupe koja se sastoji od SEQ ID NOs: 142-148, i pri čemu antigen povezan sa tumorom koji se izražava u tumorsko tkivu ima amino kiselinsku sekvencu prema SEQ ID NO: 16 i u poređenju sa zdravim tkivom je deglikozilovana varijanta antigena povezanog sa tumorom, pri čemu je glikozilacija N-glikozilacijai tumor je tumor želuca ili tumor pluća, i postupak sadrži detekciju deglikozila van varijante antigena povezanog sa tumorom u biološkom uzorku.

Patent sadrži još 3 patentnih zahtjeva

(11) **03444** (13) **B**

(51) **C07D407/12**^(2006.01)

A61K31/351^(2006.01)

C07D309/10^(2006.01)

A61P3/10^(2006.01)

(21) P-2018-7

(22) 22.08.2008

(30) 20070957625P 23.08.2007 US

(96) 08798514.9/22.08.2008

(86) US PCT/2008US/074058/22.08.2008

(87) WO 2009/026537 A1/26.02.2009/2009/09

(97) EP 2187742/26.05.2010/2010/21

EP 2187742/25.10.2017/2017/43

(54) me **DERIVATI (2S , 3R, 4R, 5S, 6R)-2 - (4 - H LORO-3 - BENZILFENIL)-6-
(HIDROKSIMETIL)TETRAHIDRO - 2H-PIRAN-3,4, 5-TRIOLA ZA UPOTREBU ZA LEČENJE
DIJABETESA**

en **(2S,3R,4R,5S,6R)-2-(4-CHLORO-3-BENZYLPHENYL)-6-(HYDROXYMETHYL)TETRAHYDRO-
2H-PYRAN-3,4,5-TRIOL DERIVATIVES FOR USE IN THE TREATMENT OF DIABETES**

(73) THERACOS SUB, LLC

225 Cedar Hill Street, Suite 200, Marlborough MA 01752/ US

(72) SONG, Yanli

Room 401, Building 11, 1166 Guanglan Rd . Pudong New District, Shanghai 201210/ CN

CHEN, Yuanwei

15 Blue Ridge Lane, North Haven, Connecticut 06473/ US

CHENG, Huawei

Room 901, 4, 2000 DongLu Road, Pudong New District, Shanghai 201206/ CN

LI, Shengbin

Room 303, Building 28 2000 Lingshan Rd . Pudong New District, Shanghai 200136/ CN

WU, Yuelin

Room 502, 2169 South Pudong Rd.Pudong New District, Shanghai 200127/ CN

FENG, Yan

850 Elizabeth Street, 2nd Floor, Ridgefield,, New Jersey 07657/ US

LV, Binhua

Room 1303, Building 42 825 Chenhui Rd ., Shanghai 201203/ CN

XU, Baihua

Room 502, Bui lding 9, 1152 East Huaxia Rd . Pudong New Area, Shanghai 201200/ CN

SEED, Brian

2 Hawthorne Place Apt. 2J,Boston, Massachusetts 02114/ US

HADD, Michael J.

4510 Brighton Ave.San Diego,, California 92107/ US

DU, Jiyan

Room 102, Building 49, 420 Qinghe Rd. , Shanghai 201800 , CN Jiading District, Shanghai 201800/ CN

WANG, Congna

Room 301, Building 3 785 Xinde Rd. Chuansha Town, Pudong New District, Shanghai 201203/ CN

ROBERGE, Jacques Y.

Unit 19, No.301 Shimao Lakeside, Lane 188 M1ng Yue Road ., Shanghai 200135/ CN

(74) Advokat RAIČEVIĆ, Dejan

Vojvode Boža 1, Cetinje , 81250 / ME

(57)

1. Jedinjenje koje ima formulu kao što je izneto dolje ili njegovu farmaceutski prihvatljivu so:

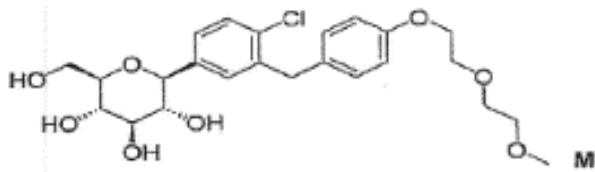

(2S,3R,4R,5S,6R)-2-(4-hloro-3-(4-(2-(2-metoksitoksi)etoksi)benzil)fenil)-6-(hidroksimetil)tetrahidro-2H- piran-3,4,5-triol;

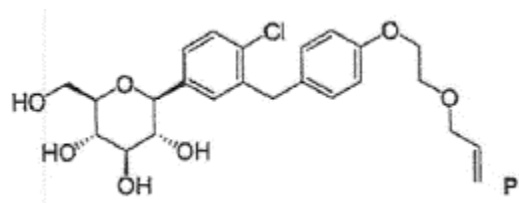

(2S,3R,4R,5S,6R)-2-(3-(4-(2-(aliloksi)etoksi)benzil)-4-hlorofenil)-6-(hiroksimetil)tetrahidro-2H- piran-3,4,5-triol;

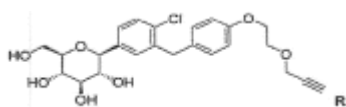

(2S,3R,4R,5S,6R)-2-(4-hloro-3-(4-(2-(prop-2-iniloksi)etoksi)benzil)fenil)-6-(hidroksimetil)tetrahidro-2H- piran-3,4,5-triol;

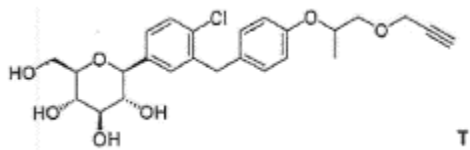

(2S,3R,4R,5S,6R)-2-(4-hloro-3-(4-(1-(prop-2-iniloksi)propan-2-ioksi)benzil)fenil)-6-(hidroksimetil)tetrahidro-2H-piran-3,4,5-triol;

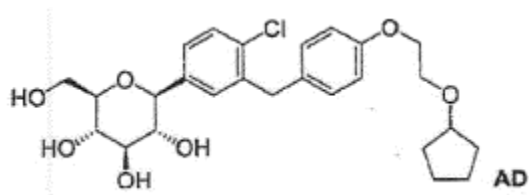

(2S,3R,4R,5S,6R)-2-(4-hloro-3-(4-(2-(ciklopentiloksi)etoksi)benzil)fenil)-6-(hidroksimetil)tetrahidro-2H-piran-3,4,5-triol;

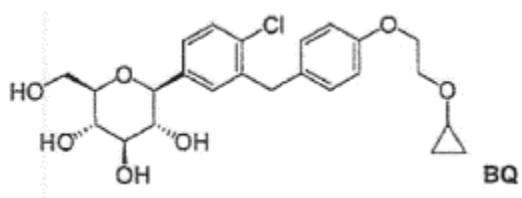

(2S,3R,4R,5S,6R)-2-(4-hloro-3-(4-(2-(2,2,2-trifluoroetoksi)etoksi)benzil)fenil)-6-(hidroksimetil)tetrahidro-2H-piran-3,4,5-triol;

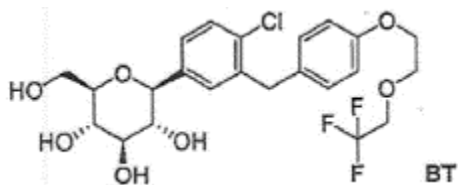

(2S,3R,4R,5S,6R)-2-(4-hloro-3-(4-(2-(2,2,2-trifluoroetoksi)etoksi)benzil)fenil)-6-(hidroksimetil)tetrahidro-2H-piran-3,4,5-triol;

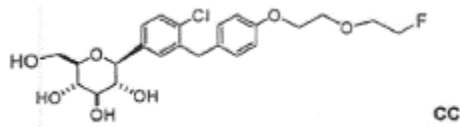

(2S,3R,4R,5S,6R)-2-(4-hloro-3-(4-(2-(2-fluoroetoksi)etoksi)benzil)fenil)-6-(hidroksimetil)tetrahidro-2H- piran-3,4,5-triol;

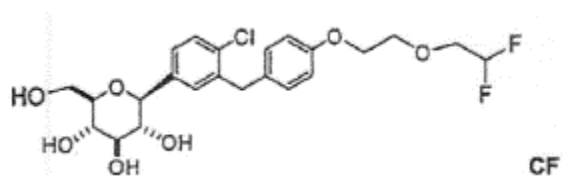

(2S,3R,4R,5S,6R)-2-(4-hloro-3-(4-(2-(2,2-difluoroetoksi)etoksi)benzil)fenil)-6-(hidroksimetil)tetrahidro-2H-piran-3,4,5-triol;

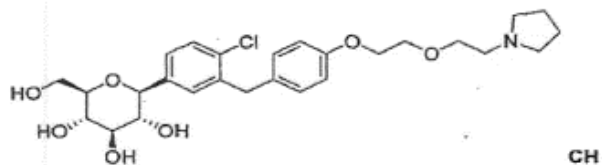

(2S,3R,4R,5S,6R)-2-(4-hloro-3-(4-(2-(2-(pirolidin-1-il)etoksi)etoksi)benzil)fenil)-6-(hidroksimetil)tetrahidro-2H-piran-3,4,5-triol;

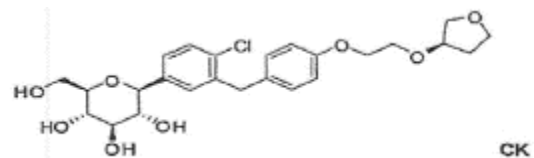

(2S,3R,4R,5S,6R)-2-(4-hloro-3-(4-(2-((R)-(tetrahidrofuran-3-iloksi)etoksi)benzil)fenil)-6-(hidroksimetil)tetrahidro-2H-piran-3,4,5-triol;

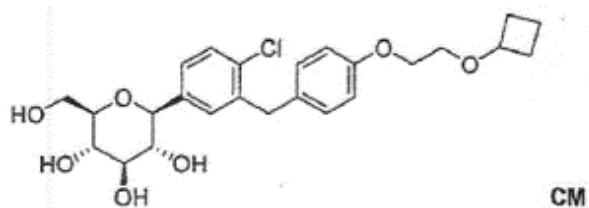

(2S,3R,4R,5S,6R)-2-(4-hloro-3-(4-(2-ciklobutoksietoksi)benzil)fenil)-6-(hidroksimetil)tetrahidro-2H- piran-3,4,5-triol;

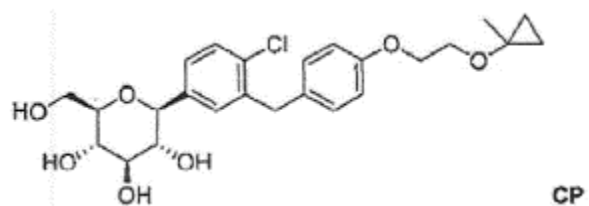

(2S,3R,4R,5S,6R)-2-(4-hloro-3-(4-(2-(1-metilciklopropoksi)etoksi))benzil)fenil)-6-(hidroksimetil)tetrahidro-2H-piran-3,4,5-triol;

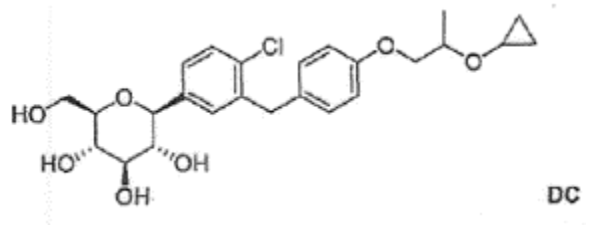

(2S,3R,4R,5S,6R)-2-(4-hloro-3-(4-(2-ciklopropoksi)propoksi)benzil)fenil)-6-(hidroksimetil)tetrahidro-2H- piran-3,4,5-triol.

Patent sadrži još 8 patentnih zahtjeva

(11) **03380** (13) **B**

(51) **A61K 35/74**^(2006.01)

A61K 9/19^(2006.01)

A23L 33/135^(2006.01)

A61P 1/12^(2006.01)

A61K 9/00^(2006.01)

A61K 9/48^(2006.01)

A61P 1/10^(2006.01)

A61P 31/04^(2006.01)

(21) P-2019-100

(22) 13.07.2017

(30) 201612190 13.07.2016 GB

201616016 20.09.2016 GB

201616018 20.09.2016 GB

201703552 06.03.2017 GB

201703548 06.03.2017 GB

(96) 17742524.6/13.07.2017

(86) GB PCT/GB2017/052077/13.07.2017

(87) WO 2018/011594/18.01.2018/2018/03

(97) EP 3313422/02.05.2018/2018/18

EP 3313422/06.03.2019/2019/10

(54) me **KOMPOZICIJE KOJE SADRŽE BAKTERIJSKI SOJ BLAUTIA HIDROGENOTROPHICA ZA UPOTREBU U LEČENJU ILI PREVENCIJI DIJAREJE ILI KONSTIPACIJE**
en **COMPOSITIONS COMPRISING A BACTERIAL STRAIN OF BLAUTIA HYDROGENOTROPHICA FOR USE IN THE TREATMENT OR PREVENTION OF DIARRHEA OR CONSTIPATION**

(73) 4D PHARMA PLC

5th floor, 9 Bond Court, Leeds, LS1 2JZ/ GB

(72) BERNALIER-DONADILLE, Annick

16 impasse les Ormes, 63670 La Roche Blanc/ FR

CROUZET, Laureen

c/o 4D Pharma PLC, Third Floor, 9 Bond Court,, Leeds, LS1 2JZ/ GB

HABOUZIT, Chloe

3 rue Bertholet, 63400 Chamalieres/ FR

(57)

1. Kompozicija koja obuhvata bakterijski soj iz roda *Blautia hydrogenotrophica* koji ima sekvencu 16s rRNK koja je najmanje 95% identična sa SEQ ID N0:5, za upotrebu u postupku lečenja ili prevencije dijareje i/ili konstipacije.

Patent sadrži još 14 patentnih zahtjeva

(11) **03457** (13) **B**

(51) **A61K 47/68**^(2017.01)

A61K 9/19^(2006.01)

A61P 35/00^(2006.01)

(21) P-2019-102

(22) 14.03.2014

(30) 201361790490 P 15.03.2013 US

(96) 14722450.5/14.03.2014

(86) US PCT/US2014/027868/14.03.2014

(87) WO 2014/143765/18.09.2014/2014/38

(97) EP 2968588/20.01.2016/2016/03

EP 2968588/09.01.2019/2019/02

(54) me **FORMULACIJE KONJUGATA LEKA ANTI-EGFR ANTITELA**
en **ANTI-EGFR ANTIBODY DRUG CONJUGATE FORMULATIONS**

(73) Abbvie Deutschland GmbH & Co. KG

Max-Planck-Ring 2a, 65205 Wiesbaden/ DE

AbbVie Inc.

1 North Waukegan Road, North Chicago, IL 60064/ US

(72) TSCHOEPE, Markus

Lindenweg 4, 67258 Hessheim/ DE

KALETA, Katharina

Adolf-Diesterweg-Strasse 107, 67071 Ludwigshafen/ DE

KUMAR, Vineet

126 Courtyard Lane, Storrs, CT 06268/ US

(57)

I. Liofilizovana formulacija koja sadrži anti-receptor epidennalnog faktora rasta (EGFR) konjugat antitelo-lek (ADC), šećer, histidin i surfaktant, gde navedeni anti-EGFR ADC sadrži anti-EGFR antitelo konjugovano za auristatin, gde anti-EGFR antitelo sadrži varijabilni region teškog lanca koji sadrži regione domena komplementarnosti (CDR) koji sadrže aminokiselinske sekvence prikazane u SEQ ID NO: 15, 16 i 17, i sadrži varijabilni region lakog lanca koji sadrži CDR koji sadrže aminokiselinske sekvence prikazane u SEQ ID NO: 20, 21 i 22.

Patent sadrži još 25 patentnih zahtjeva

(11) **03433** (13) **B**

(51) **A61K 39/12**^(2006.01)

(21) P-2019-103

(22) 29.11.2012

(30) 201161564877 P 30.11.2011 US

201261694957 P 30.08.2012 US

(96) 12805843.5/29.11.2012

(86) US PCT/US2012/067123/29.11.2012

(87) WO 2013/082317/06.06.2013/2013/23

(97) EP 2785374/08.10.2014/2014/41

EP 2785374/09.01.2019/2019/02

(54) me **REKOMBINANTNI VEKTORI GALLID HERPEŠVIRUSA 3 (MDV SEROTIP 2) KOJI EKSPRIMIRAJU ANTIGENE PTIČJIH PATHOGENA I NJIHOVE UPOTREBE**
en **RECOMBINANT GALLID HERPEŠVIRUS 3 (MDV SEROTYPE 2) VECTORS EXPRESSING ANTIGENS OF AVIAN PATHOGENS AND USES THEREOF**

(73) Merial, Inc.

3239 Satellite Boulevard, Bldg. 500, Duluth, GA 30096/ US

(72) BUBLLOT, Michel

3 rue Favre Garin, 69630 Chaponost/ FR

MEBATION, Teshome

2670 Bent Tree Lane, Watkinsville, GA 30677/ US

PRITCHARD, Joyce

3804 Princeton Court, Gainesville, GA 30504/ US

LINZ, Perry

2286 Cotton Gin Row, Jefferson, GA 30549/ US

(57)

1. Kompozicija ili vakcina za upotrebu u postupku za indukovanje imunogenog ili zaštitnog odgovora kod životinje protiv jednog ili više ptičjih patogena, pri čemu navedena kompozicija ili vakcina sadrži rekombinantni vektor na bazi soja SB-I Gallid herpesvirusa 3 (MDV-2), gde navedeni vektor sadrži jedan ili više heterologih polinukleotida koji kodiraju i ekspimiraju najmanje jedan antigen ptičjeg patogena, naznačena time što heterologi polinukleotid kodira protein NOV-F virusa Njukastl bolesti, pri čemu navedeni postupak obuhvata najmanje jednu primenu navedene kompozicije ili vakcine.

Patent sadrži još 13 patentnih zahtjeva

(11) **03456** (13) **B**

(51) **A61K 9/00**^(2006.01)

A61K 31/465^(2006.01)

A61K 47/36^(2006.01)

A61K 9/70^(2006.01)

A61K 47/02^(2006.01)

(21) P-2019-104

(22) 15.03.2013

(30) 20120161483 27.03.2012 EP
201261615997 P 27.03.2012 US

(96) 13712730.4/15.03.2013

(86) EP PCT/EP2013/055456/15.03.2013

(87) WO 2013/143891/03.10.2013/2013/40

(97) EP 2830589/04.02.2015/2015/06
EP 2830589/13.02.2019/2019/07

(54) me **FORMULACIJA NIKOTINA**
en **NICOTINE FORMULATION**

(73) NICOCCINO AB

Lahällsvägen 48, 18330 Täby/ SE

(72) HÜBINETTE, Fredrik

Herrhagsvägen 223 G, S-75067 Uppsala/ SE

(57)

1. Mukoadhezivni film koji sadrži nikotin, koji se može dobiti

-pripremanjem vodenog rastvara pri pH od 9.5 do 13, umešavanjem

(i) soli nikotina,

(ii) alkalnog agensa za regulisanje pH, i

(iii) agensa za formiranje filma kojiobuhvata alginatnu so monovalentnog katjona ili me avinu alginatnih soli monovalentnih katjona, pri čemu taj agens za formiranje filma ima srednjisadržaj guluronata (G) od 50 do 85mas.%,srednji sadržaj manuronata (M) od 15 do 50mas.%,srednju molekulsku masu od 30,000 g/mol do 90,000 g/mol ikoji je takav da njegov 10% vodenirastvor na temperaturi od 20°C ima viskozitet od 100-1000 mPas,kako je izmereno pri brzini smicanja od 20 o/min upotrebom Brookfield viskozimetra sa vretenom Br. 2;

- raspoređivanjem rastvara na čvrstu površinu; i

-ostavljanjem tog rastvara da se osuši na pomenutoj površini.

Patent sadrži još 13 patentnih zahtjeva

(11) **03397** (13) **B**

(51) **C07D 487/04**^(2006.01)

A61P 35/00^(2006.01)

A61P 27/00^(2006.01)

A61P 1/00^(2006.01)

A61K 31/519^(2006.01)

A61P 29/00^(2006.01)

A61P 19/00^(2006.01)

A61P 17/00^(2006.01)

(21) P-2019-105

(22) 31.08.2012

(30) 201161530866 P 02.09.2011 US

201261594882 P 03.02.2012 US

201261677445 P 30.07.2012 US

(96) 16199883.6/31.08.2012

(97) EP 3196202/26.07.2017/2017/30

EP 3196202/27.02.2019/2019/09

(54) me **HETEROCIKLILAMINI KAO INHIBITORI PI3K**
en **HETEROCYCLYLAMINES AS PI3K INHIBITORS**

(73) INCYTE HOLDINGS CORPORATION

1801 Augustine Cut-Off, Wilmington, DE 19803/ US

(72) LI, Yun-Long

1 Pin Oak Drive,, Chadds Ford, PA Pennsylvania 19317/ US

YAO, Wenqing

748 Meadowbank Road,, Kennett Square, PA Pennsylvania 19348/ US

COMBS, Andrew P.

329 East Doe Run Road,, Kennett Square, PA Pennsylvania 19348/ US

YUE, Eddy W.

9 Altemus Drive,, Landenberg, PA Pennsylvania 19350/ US

MEI, Song

151 Monet Circle, , Wilmington, DE Delaware 19808/ US

ZHU, Wenyu

30 Diemer Drive,, Media, PA 19063/ US

GLENN, Joseph

103 Deer Horn Drive,, Mount Royal, NJ New Jersey 08061/ US

MADUSKUIE, Thomas P. Jr.

613 Foulkstone Road,, Wilmington, DE Delaware 19803/ US

SPARKS, Richard B.

3316 Englewood Road,, Wilmington, DE Delaware 19810/ US

DOUTY, Brent

3420 Strasburg Road East, , Fallowfield, PA Pennsylvania 19320/ US

HE, Chunhong

40 Magnolia Way,, Chadds Ford, PA Pennsylvania 19317/ US

(57)

1. Jedinjenje koje je izabrano između:

(5R)-{3-[1-(R)-(4-amino-3-metil-1H-pirazolo[3,4-d]pirimidin-1-il)etil]-5-hloro-2-etoksi-6-fluorofenil}-1,3-oksazolidin-2-on;

(5R)-{3-[1-(S)-(4-amino-3-metil-1H-pirazolo[3,4-d]pirimidin-1-il)etil]-5-hloro-2-etoksi-6-fluorofenil}-1,3-oksazolidin-2-on;

(5S)-{3-[1-(R)-(4-amino-3-metil-1H-pirazolo[3,4-d]pirimidin-1-il)etil]-5-hloro-2-etoksi-6-fluorofenil}-1,3-oksazolidin-2-on; i

(5S)-{3-[1-(S)-(4-amino-3-metil-1H-pirazolo[3,4-d]pirimidin-1-il)etil]-5-hloro-2-etoksi-6-fluorofenil}-1,3-oksazolidin-2-on;

ili njegova farmaceutski prihvatljiva so.

Patent sadrži još 5 patentnih zahtjeva

(11) **03398** (13) **B**

(51) **C07C235/42**^(2006.01)

C07D213/81^(2006.01)

C07D401/12^(2006.01)

C07C233/81^(2006.01)

C07D215/52^(2006.01)

C07D405/04^(2006.01)

(21) P-2019-106

(22) 11.12.2014

(30) 201361916824P 17.12.2013 US

(96) 14827908.6/11.12.2014

(86) US PCT/US2014/069783/11.12.2014

(87) WO 2015/094912/25.06.2015/2015/25

(97) EP 3083554/26.10.2016/2016/43

EP 3083554/13.03.2019/2019/11

(54) me **SPOJEVI DIMETILBENZOJEVE KISELINE**
en **DIMETHYLBENZOIC ACID COMPOUNDS**

(73) ELI LILLY & COMPANY

Lilly Corporate Center, Indianapolis, IN 46285/ US

(72) BLANCO-PILLADO, Maria-Jesus

P.O. Box 6288, Indianapolis, Indiana 46206-6288/ US

MANNINEN, Peter Rudolph

P.O. Box 6288 , Indianapolis, Indiana 46206-6288/ US

SCHIFFLER, Matthew Allen

P.O. Box 6288 , Indianapolis, Indiana 46206-6288/ US

VETMAN, Tatiana Natali

P.O. Box 6288 , Indianapolis, Indiana 46206-6288/ US

WARSHAWSKY, Alan M.

P.O. Box 6288 , Indianapolis, Indiana 46206-6288/ US

YORK, Jeremy Schulenburg

P.O. Box 6288 , Indianapolis, Indiana 46206-6288/ US

(57)

1. Spoj, **naznačen time** što ga se bira između:

3-[[6-(1,3-benzodioksol-5-il)-3-metilpiridin-2-karbonil]amino]-2,4-dimetilbenzojeve kiseline;

3-[[6-[3-(hidroksimetil)fenil]-3-metilpiridin-2-karbonil]amino]-2,4-dimetilbenzojeve kiseline; i

3-[[3-(3-klorfenil)naftalen-1-karbonil]amino]-2,4-dimetilbenzojeve kiseline;

ili njihovih farmaceutski prihvatljivih soli.

Patent sadrži još 8 patentnih zahtjeva

(11) **03399** (13) **B**

(51) **C07D 417/04**^(2006.01)

A61K 31/426^(2006.01)

C07D 263/42^(2006.01)

A61P 29/00^(2006.01)

(21) P-2019-110

(22) 23.06.2015

(30) 14173502 23.06.2014 EP

(96) 15730801.6/23.06.2015

(86) EP PCT/EP2015/064146/23.06.2015

(87) WO 2015/197640/30.12.2015/2015/52

(97) EP 3157918/26.04.2017/2017/17

EP 3157918/27.03.2019/2019/13

(54) me **DERIVATI 2-ARIL-4-HIDROKSI-1,3-TIAZOLA KORISNI KAO INHIBITORI TRPM8 U LEĆENJU NEURALGIJE, BOLA, COPD I ASTME**

en **2-ARYL-4-HYDROXY-1,3-THIAZOLE DERIVATIVES USEFUL AS TRPM8-INHIBITORS IN TREATMENT OF NEURALGIA, PAIN, COPD AND ASTHMA**

(73) Dompé farmaceutici S.p.A.

Via S. Martino Della Battaglia 12, 20122 Milan/ IT

(72) ARAMINI, Andrea

Via S.Martino Della Battaglia 12, 20122 Milano/ IT

BIANCHINI, Gianluca

Via S.Martino Della Battaglia 12, 20122 Milano/ IT

BRANDOLINI, Laura

Via S.Martino Della Battaglia 12, 20122 Milano/ IT

BECCARI, Andrea

Via S.Martino Della Battaglia 12, 20122 Milano/ IT

LILLINI, Samuele

Via S.Martino Della Battaglia 12, 20122 Milano/ IT

NANO, Giuseppe

Via S.Martino Della Battaglia 12, 20122 Milano/ IT

(57)

1. Jedinjenje formule (I):

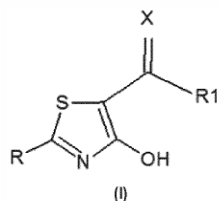

gde

X je kiseonik, sumpor, NH, NOH ili NOME;

R je grupa izabrana od arila i heteroarila, izborno supstituisana sa jednim ili više supstituenata izabranih od

- vodonika,
- halogena,
- CF₃,
- linearnog ili granatog C₁-C₆ alkila,
- OR₅ i
- NR₆R₇, gde su R₅, R₆ i R₇ nezavisno vodonik ili linearni ili granati C₁-C₆ alkil;

R₁ je grupa izabrana od

- linearnog ili granatog C₁-C₆ alkila,
- (CH₂)_m-OR₂, gde je m ceo broj između 1 i 3 i R₂ je izabran od vodonika i linearnog C₁-C₃ alkila,
- C₃-C₆ cikloalkila i
- N(R₃)OR₄, gde su R₃ i R₄ nezavisno vodonik ili linearni ili granati C₁-C₃ alil, i njegove farmaceutski prihvatljive soli, za upotrebu kao lek.

Patent sadrži još 15 patentnih zahtjeva

(11) **03423** (13) **B**

(51) **A61K 31/341**^(2006.01)

A61K 31/675^(2006.01)

A61P 31/18^(2006.01)

C07F 9/6561^(2006.01)

A61K 31/513^(2006.01)

A61K 31/683^(2006.01)

C07H 19/16^(2006.01)

(21) P-2019-115

(22) 26.07.2005

(30) 20040591811P 27.07.2004 US

(96) 10178348.8/26.07.2005

(97) EP 2258376/08.12.2010/2010/49

EP 2258376/27.02.2019/2019/09

(54) me **FOSFONATNI ANALOZI JEDINJENJA HIV INHIBITORA**
en **PHOSPHONATE ANALOGS OF HIV INHIBITOR COMPOUNDS**

(73) GILEAD SCIENCES, INC.

333 Lakeside Drive, Foster City, CA 94404/ US

(72) Markevitch, David, Y.

3165 Sepulveda Blvd, apt. 308, Los Angeles California 90034/ US

BOOJAMRA, Constantine, G.

1 Worth Street, San Francisco, California 94114/ US

Lin, Kuei-Ying

1441 Ramon Drive, Sunnyvale California 94087/ US

ZHANG, Lijun

4033 Middlefield Road, Palo Alto, California 94303/ US

MACKMAN, Richard, L.

360 Ashton Avenue, Millbrae, California 94030/ US

Petrakovsky, Oleg, V.

1301 Palos Verdes, Apt. 6, San Mateo California 94403/ US

Ray, Adrian, S.

19 Pilot Circle, Redwood City, California 94065 / US

(74) Advokat LUTOVAC, Branislav

Bulevar Ivana Crnojevica 93 , Podgorica , 81000 / ME

(57)

1. 1. Jedinjenje, uključujući njegove enantiomere, Formule 1J, ili njegova farmaceutska prihvatljiva so ili njegov solvat,

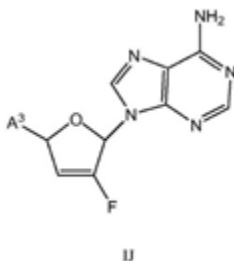

pri čemu:

A³ je izabran od

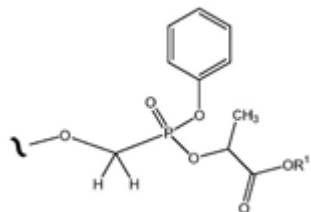
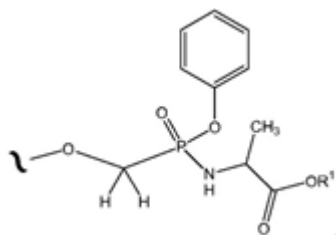

ili

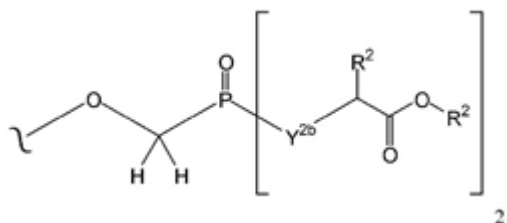

pri čemu

R¹ je nezavisno H ili alkil izabran od metil, etil, 1-propil, 2-propil, 1-butil, 2-metil-1-propil, 2-butil, 2-metil-2-propil, 1-pentil, 2-pentil, 3-pentil, 2-metil-2-butil, 3-metil-2-butil, 3-metil-1-butil, 2-metil-1-butil, 1-heksil, 2-heksil, 3-heksil, 2-metil-2-pentil, 3-metil-2-pentil, 4-metil-2-pentil, 3-metil-3-pentil, 2-metil-3-pentil, 2,3-dimetil-2-butil, and 3,3-dimetil-2-butil;

R² je H ili alkil izabran od metil, etil, 1-propil, 2-propil, 1-butil, 2-metil-1-propil, 2-butil, 2-metil-2-propil, 1-pentil, 2-pentil, 3-pentil, 2-metil-2-butil, 3-metil-2-butil, 3-metil-1-butil, 2-metil-1-butil, 1-heksil, 2-heksil, 3-heksil, 2-metil-2-pentil, 3-metil-2-pentil, 4-metil-2-pentil, 3-metil-3-pentil, 2-metil-3-pentil, 2,3-dimetil-2-butil, i 3,3-dimetil-2-butil; i

Y^{2b} je O ili N(R²).

Patent sadrži još 8 patentnih zahtjeva

(11) **03424** (13) **B**

(51) **A61K 35/74**^(2015.01)

A61K 9/19^(2006.01)

A23L 33/135^(2016.01)

A61P 1/12^(2006.01)

A61K 9/00^(2006.01)

A61K 9/48^(2006.01)

A61P 1/10^(2006.01)

A61P 31/04^(2006.01)

(21) P-2019-116

(22) 13.07.2017

(30) 20160012190 13.07.2016 GB

20160016018 20.09.2016 GB

20160016016 20.09.2016 GB

20170003548 06.03.2017 GB

20170003552 06.03.2017 GB

(96) 17742523.8/13.07.2017

(86) GB PCT/GB2017/052076/13.07.2017

(87) WO 2018/011593/18.01.2018/2018/03

(97) EP 3313421/02.05.2018/2018/18

EP 3313421/06.03.2019/2019/10

(54) me **KOMPOZICIJE KOJE SADRŽE BAKTERIJSKI SOJ BLAUTIA HYDROGENOTROPHICA ZA UPOTREBU U LIJEČENJU BAKTERISJKIH INFEKCIJA GASTROINTESTINALNOG TRAKTA**
en **COMPOSITIONS COMPRISING A BACTERIAL STRAIN OF BLAUTIA HYDROGENOTROPHICA FOR USE IN THE TREATMENT OF BACTERIAL INFECTIONS OF THE GASTROINTESTINAL TRACT**

(73) 4D Pharma PLC

5th floor, 9 Bond Court, Leeds, LS1 2JZ/ GB

(72) CROUZET, Laureen

Third Floor 9 Bond Court, Leeds LS1 2JZ / GB

HABOUZIT, Chloe

3 rue Bertholet, Chamaliere, 63400 / FR

BERNALIER-DONADILLE, Annick

16 impasse les Ormes, La Roche Blanc, 63670 / FR

(74) Advokat LUTOVAC, Branislav

Bulevar Ivana Crnojevica 93 , Podgorica , 81000 / ME

(57)

1. Kompozicija koja obuhvata bakterijski soj roda *Blautia hydrogenotrophica* koji ima 16s rRNK sekvencu koja je najmanje 95% identična sa SEQ ID NO:5, za upotrebu u postupku smanjenja nivoa patogenih *Enterobacteriaceae* u gastrointestinalnom traktu.

Patent sadrži još 14 patentnih zahtjeva

(11) **03425** (13) **B**

(51) **C07D 401/14**^(2006.01)

C07D 413/14^(2006.01)

C07D 409/14^(2006.01)

C07D 471/04^(2006.01)

A61K 31/4709^(2006.01)

A61P 35/00^(2006.01)

C07D 405/14^(2006.01)

C07D 401/12^(2006.01)

C07D 417/14^(2006.01)

C07D 495/04^(2006.01)

A61P 29/00^(2006.01)

(21) P-2019-117

(22) 30.06.2016

(30) 201562189158P 06.07.2015 US

201562269060P 17.12.2015 US

(96) 16738976.6/30.06.2016

(86) US PCT/US2016/040520/30.06.2016

(87) WO 2017/007689/12.01.2017/2017/02

(97) EP 3191470/19.07.2017/2017/29

EP 3191470/27.02.2019/2019/09

(54) me **COT MODULATORI I POSTUPCI ZA NJIHOVU UPOTREBU**
en **COT MODULATORS AND METHODS OF USE THEREOF**

(73) GILEAD SCIENCES, INC.

333 Lakeside Drive, Foster City, CA 94404/ US

(72) BACON, Elizabeth, M.

333 Lakeside Drive, Foster City, CA 94404/ US

BALAN, Gayatri

333 Lakeside Drive, Foster City, CA 94404/ US

CHOU, Chien-Hung

333 Lakeside Drive, Foster City, CA 94404/ US

CLARK, Christopher, T.

333 Lakeside Drive, Foster City, CA 94404/ US

COTTELL, Jeromy, J.

333 Lakeside Drive, Foster City, CA 94404/ US

KIM, Musong

333 Lakeside Drive, Foster City, CA 94404/ US

KIRSCHBERG, Thorsten, A.

333 Lakeside Drive, Foster City, CA 94404/ US

LINK, John, O.

333 Lakeside Drive, Foster City, CA 94404/ US

PHILLIPS, Gary

333 Lakeside Drive, Foster City, CA 94404/ US

SCHROEDER, Scott, D.

333 Lakeside Drive, Foster City, CA 94404/ US

SQUIRES, Neil, H.

333 Lakeside Drive, Foster City, CA 94404/ US

STEVENS, Kirk, L.

333 Lakeside Drive, Foster City, CA 94404/ US

TAYLOR, James, G.

333 Lakeside Drive, Foster City, CA 94404/ US

WATKINS, William, J.

333 Lakeside Drive, Foster City, CA 94404/ US

WRIGHT, Nathan, E.

333 Lakeside Drive, Foster City, CA 94404/ US

ZIPFEL, Sheila, M.

333 Lakeside Drive, Foster City, CA 94404/ US

(74) Advokat LUTOVAC, Branislav

Bulevar Ivana Crnojevicica 93 , Podgorica , 81000 / ME

(57)

1. Jedinjenje formule I:

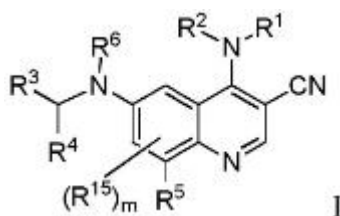

gde

R1 je vodonik, -O-R7, -N(R8)(R9), -C(O)-R7, -S(O)2-R7, -C1-9 alkil, C2-6 alkenil, C2-6 alkinil, C3-15 cikloalkil, heterociklil, aril, ili heteroaril;

gde svaki C1-9 alkil, C2-6 alkenil, C2-6 alkinil, C3-15 cikloalkil, heterociklil, aril, i heteroaril može biti opciono supstituisan sa jednim do četiri Z1;

R2 je vodonik, -C(O)-R7, -C(O)O-R7, -C(O)N(R7)2, C1-9 alkil, C2-6 alkenil, C2-6 alkinil, C1-6 haloalkil, C3-15 cikloalkil, aril, heterociklil, ili heteroaril;

gde svaki C1-9 alkil, C2-6 alkenil, C2-6 alkinil, C1-6 haloalkil, C3-15 cikloalkil, aril, heterociklil, i heteroaril može biti opciono supstituisan sa jednim do četiri Z2;

ili R1 i R2 zajedno sa azotom za koji su vezani obrazuju heterociklil ili heteroaril, gde svaki heterociklil ili heteroaril je opciono supstituisan sa jedan do četiri Z2;

R3 je heterociklil ili heteroaril, gde svaki heterociklil ili heteroaril je opciono supstituisan sa jedan do četiri Z3;

R4 je heterociklil ili heteroaril, gde svaki heterociklil ili heteroaril je opciono supstituisan sa jedan do četiri Z4;

R5 je vodonik, halo, -CN, -NO2, -O-R7, -N(R8)(R9), -S(O)-R7, -S(O)2R7, -S(O)2N(R7)2, -C(O)R7, -OC(O)-R7, -C(O)O-R7, -OC(O)O-R7, -OC(O)N(R10)(R11), -C(O)N(R7)2, -N(R7)C(O)(R7), C1-9 alkil, C2-6 alkenil, C2-6 alkinil, C1-9 alkiltio, C1-6 haloalkil, C3-15 cikloalkil, aril, heterociklil, ili heteroaril;

gde svaki C1-9 alkil, C2-6 alkenil, C2-6 alkinil, C1-9 alkiltio, C1-6 haloalkil, C3-15 cikloalkil, aril, hetero-ciklil, i heteroaril može biti opciono supstituisan sa jednim do četiri Z5;

R6 je vodonik, -C(O)-R7, -C(O)O-R7, -C(O)N(R7)2, C1-9 alkil, C2-6 alkenil, C2-6 alkinil, C1-6 haloalkil, C3-15 cikloalkil, aril, heterociklil, ili heteroaril;

gde svaki C1-9 alkil, C2-6 alkenil, C2-6 alkinil, C1-6 haloalkil, C3-15 cikloalkil, aril, heterociklil, i heteroaril može biti opciono supstituisan sa jednim do četiri Z6;

svaki R7 je nezavisno vodonik, C1-9 alkil, C2-6 alkenil, C2-6 alkinil, C1-6 haloalkil, C3-15 cikloalkil, aril, heterociklil, ili heteroaril;

gde svaki C1-9 alkil, C2-6 alkenil, C2-6 alkinil, C1-6 haloalkil, C3-15 cikloalkil, aril, heterociklil, i heteroaril može biti opciono supstituisan sa jednim do četiri Z7;

R8 i R9 u svakom javljanju su nezavisno vodonik, -S(O)2R10, -C(O)-R10, -C(O)O-R10,

-C(O)N(R10)(R11), C1-9 alkil, C2-6 alkenil, C2-6 alkinil, C1-6 haloalkil, C3-15 cikloalkil, aril, heterociklil, ili heteroaril;

gde svaki C1-9 alkil, C2-6 alkenil, C2-6 alkinil, C1-6 haloalkil, C3-15 cikloalkil, aril, heterociklil, ili heteroaril može biti opciono supstituisan sa jednim do četiri Z8;

R10 i R11 u svakom javljanju su nezavisno vodonik, C1-9 alkil, C2-6 alkenil, C2-6 alkinil, C1-6 haloalkil, C3-15 cikloalkil, aril, heterociklil, ili heteroaril,

gde svaki C1-9 alkil, C2-6 alkenil, C2-6 alkinil, C1-6 haloalkil, C3-15 cikloalkil, aril, heterociklil, i heteroaril opciono je supstituisan sa jedan do četiri Z1b;

svaki Z1, Z2, Z3, Z4, Z5, Z6, Z7, i Z8 je nezavisno vodonik, okso, halo, -NO₂, -N₃, -CN, tiokso, C1-9 alkil, C2-6 alkenil, C2-6 alkinil, C3-15 cikloalkil, C1-8 haloalkil, aril, heteroaril, heterociklil, -O-R12,

-C(O)-R12, -C(O)O-R12, -C(O)-N(R13)(R14), -N(R13)(R14), -N(R13)2(R14)+, -N(R12)C(O)-R12,

-N(R12)C(O)O-R12, -N(R12)C(O)N(R13)(R14), -N(R12)S(O)2(R12), -NR12S(O)2N(R13)(R14),

-NR12S(O)2O(R12), -OC(O)R12, -OC(O)-N(R13)(R14), -P(O)(OR12)2, -OP(O)(OR12)2, -CH2P(O)(OR12)2,

-OCH2P(O)(OR12)2, -C(O)OCH2P(O)(OR12)2, -P(O)(R12)(OR12), -OP(O)(R12)(OR12),

-CH2P(O)(R12)(OR12), -OCH2P(O)(R12)(OR12), -C(O)OCH2P(O)(R12)(OR12), -P(O)(N(R12)2)2,

-OP(O)(N(R12)2)2, -CH2P(O)(N(R12)2)2, -OCH2P(O)(N(R12)2)2, -C(O)OCH2P(O)(N(R12)2)2,

-P(O)(N(R12)2)(OR12), -OP(O)(N(R12)2)(OR12), -CH2P(O)(N(R12)2)(OR12), -OCH2P(O)(N(R12)2)(OR12), -

C(O)OCH2P(O)(N(R12)2)(OR12), -P(O)(R12)(N(R12)2), -OP(O)(R12)(N(R12)2), -CH2P(O)(R12)(N(R12)2), -

OCH2P(O)(R12)(N(R12)2), -C(O)OCH2P(O)(R12)(N(R12)2), -Si(R12)3, -S-R12, -S(O)R12, -S(O)(NH)R12,

-S(O)2R12 ili -S(O)2N(R13)(R14);

gde bilo koji alkil, alkenil, alkinil, cikloalkil, haloalkil, aril, heteroaril ili heterociklil je opciono supstituisan sa jedan do četiri Z1a grupe;

svaki Z1a je nezavisno okso, halo, tiokso, -NO₂, -CN, -N₃, C1-9 alkil, C2-6 alkenil, C2-6 alkinil, C3-15 cikloalkil, C1-8 haloalkil, aril, heteroaril, heterociklil, -O-R12, -C(O)R12, -C(O)O-R12,

-C(O)N(R13)(R14), -N(R13)(R14), -N(R13)2(R14)+, -N(R12)-C(O)R12, -N(R12)C(O)O(R12),

-N(R12)C(O)N(R13)(R14), -N(R12)S(O)2(R12), -N(R12)S(O)2-N(R13)(R14), -N(R12)S(O)2O(R12),

-OC(O)R12, -OC(O)OR12, -OC(O)-N(R13)(R14), -Si(R12)3, -S-R12, -S(O)R12, -S(O)(NH)R12, -S(O)2R12 ili

-S(O)2N(R13)(R14);

gde bilo koji alkil, alkenil, alkinil, cikloalkil, aril, heteroaril ili heterociklil je opciono supstituisan sa jedan do četiri Z1b grupe;

svaki R12 je nezavisno vodonik, C1-9 alkil, C2-6 alkenil, C2-6 alkinil, C3-15 cikloalkil, aril, heteroaril ili heterociklil,

gde bilo koji alkil, alkenil, alkinil, cikloalkil, aril, heteroaril ili heterociklil je opciono supstituisan sa jedan do četiri Z1b grupe;

R13 i R14 u svakom javljanju su svaki nezavisno vodonik, C1-9 alkil, C2-6 alkenil, C2-6 alkinil, C3-15 cikloalkil, aril, heteroaril ili heterociklil;

gde bilo koji alkil, alkenil, alkinil, cikloalkil, aril, heteroaril ili heterociklil je opciono supstituisan sa jedan do četiri Z1b grupe, ili R13 i R14 zajedno sa azotom za koji su vezani obrazuju heterociklil, gde pomenuti heterociklil je opciono supstituisan sa jedan do četiri Z1b grupe;

svaki R15 je nezavisno halo, -CN, -NO₂, -O-R7, -N(R8)(R9), -S(O)-R7, -S(O)2R7, -S(O)2N(R7)2,

-C(O)R7, -OC(O)-R7, -C(O)O-R7, -OC(O)O-R7, -OC(O)N(R10)(R11), -C(O)N(R7)2, -N(R7)C(O)(R7), C1-9 alkil, C2-6 alkenil, C2-6 alkinil, C1-9 alkiltio, C1-6 haloalkil, C3-15 cikloalkil, aril, heterociklil, ili heteroaril; i

svaki Z1b je nezavisno okso, tiokso, hidroksi, halo, -NO₂, -N₃, -CN, C1-9 alkil, C2-6 alkenil, C2-6 alkinil, C3-15 cikloalkil, C1-8 haloalkil, aril, heteroaril, heterociklil, -O(C1-9 alkil), -O(C2-6 alkenil),

-O(C2-6 alkinil), -O(C3-15 cikloalkil), -O(C1-8 haloalkil), -O(aril), -O(heteroaril), -O(heterociklil),

-NH₂, -NH(C1-9 alkil), -NH(C2-6 alkenil), -NH(C2-6 alkinil), -NH(C3-15 cikloalkil), -NH(C1-8 haloalkil),

-NH(aril), -NH(heteroaril), -NH(heterociklil), -N(C1-9 alkil)2, -N(C2-6 alkenil)2, -N(C2-6 alkinil)2,

-N(C3-15 cikloalkil)2, -N(C1-8 haloalkil)2, -N(aril)2, -N(heteroaril)2, -N(heterociklil)2, -N(C1-9 alkil)(C2-6 alkenil), -N(C1-9 alkil)(C2-6 alkinil), -N(C1-9 alkil)(C3-15 cikloalkil), -N(C1-9 alkil)(C1-8 haloalkil), -N(C1-9 alkil)(aril), -N(C1-9 alkil)(heteroaril), -N(C1-9 alkil)(heterociklil), -C(O)(C1-9 alkil), -C(O)(C2-6 alkenil), -C(O)(C2-6 alkinil), -C(O)(C3-15 cikloalkil), -C(O)(C1-8 haloalkil), -C(O)(aril), -C(O)(heteroaril), -C(O)(heterociklil), -C(O)O(C1-9 alkil), -C(O)O(C2-6 alkenil), -C(O)O(C2-6 alkinil), -C(O)O(C3-15 cikloalkil), -C(O)O(C1-8 haloalkil), -C(O)O(aril), -C(O)O(heteroaril), -C(O)O(heterociklil), -C(O)NH2, -C(O)NH(C1-9 alkil), -C(O)NH(C2-6 alkenil), -C(O)NH(C2-6 alkinil), -C(O)NH(C3-15 cikloalkil), -C(O)NH(C1-8 haloalkil), -C(O)NH(aril), -C(O)NH(heteroaril), -C(O)NH(heterociklil), -C(O)N(C1-9 alkil)2, -C(O)N(C2-6 alkenil)2, -C(O)N(C2-6 alkinil)2, -C(O)N(C3-15 cikloalkil)2, -C(O)N(C1-8 haloalkil)2, -C(O)N(aril)2, -C(O)N(heteroaril)2, -C(O)N(heterociklil)2, -NHC(O)(C1-9 alkil), -NHC(O)(C2-6 alkenil), -NHC(O)(C2-6 alkinil), -NHC(O)(C3-15 cikloalkil), -NHC(O)(C1-8 haloalkil), -NHC(O)(aril), -NHC(O)(heteroaril), -NHC(O)(heterociklil), -NHC(O)O(C1-9 alkil), -NHC(O)O(C2-6 alkenil), -NHC(O)O(C2-6 alkinil), -NHC(O)O(C3-15 cikloalkil), -NHC(O)O(C1-8 haloalkil), -NHC(O)O(aril), -NHC(O)O(heteroaril), -NHC(O)O(heterociklil), -NHC(O)NH(C1-9 alkil), -NHC(O)NH(C2-6 alkenil), -NHC(O)NH(C2-6 alkinil), -NHC(O)NH(C3-15 cikloalkil), -NHC(O)NH(C1-8 haloalkil), -NHC(O)NH(aril), -NHC(O)NH(heteroaril), -NHC(O)NH(heterociklil), -SH, -S(C1-9 alkil), -S(C2-6 alkenil), -S(C2-6 alkinil), -S(C3-15 cikloalkil), -S(C1-8 haloalkil), -S(aril), -S(heteroaril), -S(heterociklil), -NHS(O)(C1-9 alkil), -N(C1-9 alkil)S(O)(C1-9 alkil), -S(O)N(C1-9 alkil)2, -S(O)(C1-9 alkil), -S(O)(NH)(C1-9 alkil), -S(O)(C2-6 alkenil), -S(O)(C2-6 alkinil), -S(O)(C3-15 cikloalkil), -S(O)(C1-8 haloalkil), -S(O)(aril), -S(O)(heteroaril), -S(O)(heterociklil), -S(O)2(C1-9 alkil), -S(O)2(C2-6 alkenil), -S(O)2(C2-6 alkinil), -S(O)2(C3-15 cikloalkil), -S(O)2(C1-8 haloalkil), -S(O)2(aril), -S(O)2(heteroaril), -S(O)2(heterociklil), -S(O)2NH(C1-9 alkil), ili -S(O)2N(C1-9 alkil)2; gde bilo koji alkil, cikloalkil, aril, heteroaril, ili heterociklil je opciono supstituisan sa jedan do četiri halo, C1-9 alkil, C1-8 haloalkil, -OH, -NH2, -NH(C1-9 alkil), -NH(C3-15 cikloalkil), -NH(C1-8 haloalkil), -NH(aril), -NH(heteroaril), -NH(heterociklil), -N(C1-9 alkil)2, -N(C3-15 cikloalkil)2, -NHC(O)(C3-15 cikloalkil), -NHC(O)(C1-8 haloalkil), -NHC(O)(aril), -NHC(O)(heteroaril), -NHC(O)(heterociklil), -NHC(O)O(C1-9 alkil), -NHC(O)O(C2-6 alkinil), -NHC(O)O(C3-15 cikloalkil), -NHC(O)O(C1-8 haloalkil), -NHC(O)O(aril), -NHC(O)O(heteroaril), -NHC(O)O(heterociklil), -NHC(O)NH(C1-9 alkil), -S(O)(NH)(C1-9 alkil), S(O)2(C1-9 alkil), -S(O)2(C3-15 cikloalkil), -S(O)2(C1-8 haloalkil), -S(O)2(aril), -S(O)2(heteroaril), -S(O)2(heterociklil), -S(O)2NH(C1-9 alkil), -S(O)2N(C1-9 alkil)2, -O(C3-15 cikloalkil), -O(C1-8 haloalkil), -O(aril), -O(heteroaril), -O(heterociklil), ili -O(C1-9 alkil); m je 0,1, ili 2;

ili njegova farmaceutski prihvatljiva so, stereoizomer, smeša stereoizomera, ili deuterisanih analoga.

Patent sadrži još 20 patentnih zahtjeva

(11) **03426** (13) **B**

(51) **C07D 417/06**^(2006.01)

C07D 487/08^(2006.01)

A61K 31/427^(2006.01)

A61P 17/06^(2006.01)

A61P 37/00^(2006.01)

C07D 417/14^(2006.01)

C07D 277/56^(2006.01)

A61P 3/10^(2006.01)

A61P 19/02^(2006.01)

(21) P-2019-118

(22) 30.10.2015

(30) 201462072563P 30.10.2014 US

(96) 15802227.7/30.10.2015

(86) US PCT/US2015/058193/30.10.2015

(87) WO 2016/069974/06.05.2016/2016/18

(97) EP 3212643/06.09.2017/2017/36

EP 3212643/20.03.2019/2019/12

(54) me **TRIFLUOROMETIL ALKOHOLI KAO MODULATORI ROR-GAMA-T**
en **TRIFLUOROMETHYL ALCOHOLS AS MODULATORS OF ROR-GAMMA-T**

(73) Janssen Pharmaceutica NV

Turnhoutseweg 30, Beerse, 2340/ BE

(72) VENKATESAN, Hariharan

3210 Merryfield Row, San Diego, CA 92121/ US

TANIS, Virginia

3210 Merryfield Row, San Diego, CA 92121/ US

KINZEL, Olaf

Donnersbergweg 1, Ludwigshafen, 67059 / DE

GEGE, Christian

Donnersbergweg 1, Ludwigshafen, 67059 / DE

STEENECK, Christoph

Donnersbergweg 1, Ludwigshafen, 67059 / DE

KLEYMANN, Gerald

Donnersbergweg 1, Ludwigshafen, 67059 / DE

HOFFMANN, Thomas

Donnersbergweg 1, Ludwigshafen, 67059/ DE

GOLDBERG, Steven

3210 Merryfield Row, San Diego, California 92121/ US

FOURIE, Anne, M.

3210 Merryfield Row, San Diego, CA 92121/ US

XUE, Xiaohua

3210 Merryfield Row, San Diego, California 92121/ US

(74) Advokat LUTOVAC, Branislav

Bulevar Ivana Crnojevica 93 , Podgorica , 81000 / ME

(57)

1. 1. Jedinjenje Formule I.

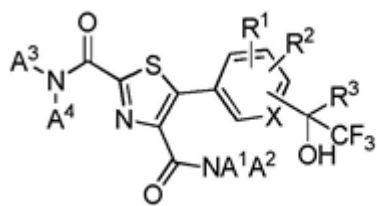

Formula I

pri čemu

X je CH, CR¹, ili N;

A¹ je C₍₁₋₂₎alkil;

A² je ciklobutil, ili C₍₁₋₄₎alkil, pri čemu pomenuti C₍₁₋₄₎alkil je po potrebi supstituisan sa OCH₃ ili do tri atoma fluora;

ili A¹ i A² se uzimaju zajedno sa njihovim vezanim azotom da se obrazuje prsten koji je izabran iz grupe koja obuhvata azetidini, piperidini, pirolidini,

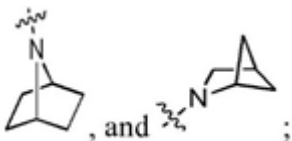

pri čemu pomenuti prsten je po potrebi supstituisan sa do tri supstituenata nezavisno izabranih iz grupe koja obuhvata F, CF₃, CH₃, -CN, i CH₂OH;

R¹ je Cl, C(CH₃)₃, CH₂CH₃, OCF₃, CF₃, OCH(CH₃)₂, CHF₂, OCHF₂, OCH₃, F, CH₃, ili -CN;

R² je H, F, ili Cl;

ili R¹ i R² mogu da se uzmu zajedno sa njihovim vezanim fenilom da se obrazuje naftalenil, ili hinolinil grupa;

R³ je CF₃, ili CH₂CH₃;

A³ je H

A⁴ je H, C₍₁₋₅₎alkil,

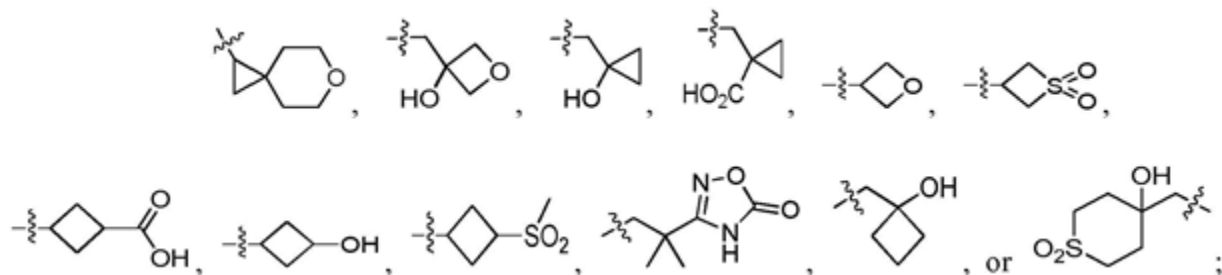

pri čemu pomenuti C₍₁₋₅₎alkil je po potrebi supstituisan sa jednim do dva supstituenata nezavisno izabranih od COOH, CONH₂, -CN, i OH;

ili A³ i A⁴ mogu da se uzmu zajedno sa njihovim vezanim azotom da se dobije prsten izabran iz grupe koja obuhvata

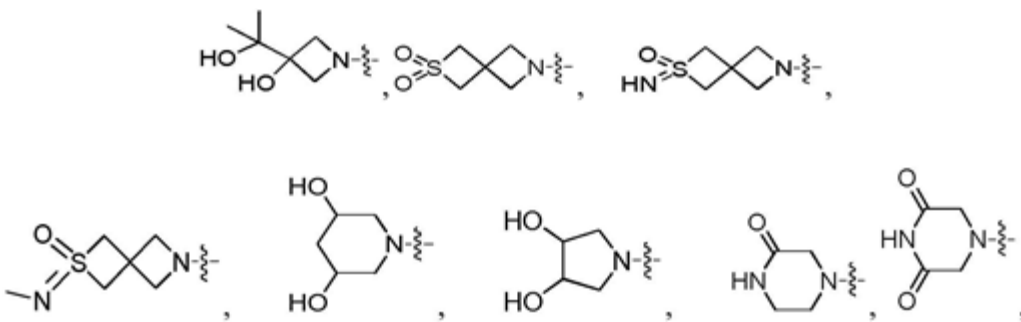

i

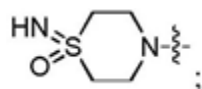

i njegove farmaceutski prihvatljive soli.

Patent sadrži još 29 patentnih zahtjeva

(11) **03427** (13) **B**

(51) **C07D 487/04**^(2006.01)

A61K 31/519^(2006.01)

A61P 35/00^(2006.01)

(21) P-2019-119

(22) 20.02.2015

(30) 20140003093 21.02.2014 GB

(96) 15706282.9/20.02.2015

(86) GB PCT/GB2015/050494/20.02.2015

(87) WO 2015/124941/27.08.2015/2015/34

(97) EP 3107914/28.12.2016/2016/52

EP 3107914/30.01.2019/2019/05

(54) me **PIRAZOLO[1,5-A]PIRIMIDIN-5,7-DIAMIN JEDINJENJA KAO CDK INHIBITORI I NJIHOVA TERAPEUTSKA PRIMJENA**

en **PYRAZOLO[1,5-A]PYRIMIDINE-5,7-DIAMINE COMPOUNDS AS CDK INHIBITORS AND THEIR THERAPEUTIC USE**

(73) CANCER RESEARCH TECHNOLOGY LIMITED

Angel Building 407 St. John Street, London, Greater London EC1V 4AD/ GB

IP2IPO Innovations Limited

Top Floor, The Walbrook Building, 25 Walbrook, London EC4N 8AF/ GB

Emory University

1599 Clifton Rd., 4th Floor, Atlanta, GA 30322/ US

(72) BONDKE, Alexander

Kastanienallee 10, Caputh, 14548 / DE

KROLL, Sebastian

Department of Chemistry Imperial College London South Kensington Campus Imperial College Road, London Greater London SW7 2AZ/ GB

BARRETT, Anthony

Department of Chemistry Imperial College London South Kensington Campus Imperial College Road, London Greater London SW7 2AZ / GB

FUCHTER, Matthew

Department of Chemistry Imperial College London South Kensington Campus Imperial College Road, London Greater London SW7 2AZ/ GB

SLAFER, Brian

9 Norton Ave., Lemont, IL 60439/ US

ALI, Simak

Department of Surgery & Cancer Imperial College London Hammersmith Campus Du Cane Road, London Greater London W12 0NN/ GB

COOMBES, Charles

Department of Surgery & Cancer Imperial College London Hammersmith Campus Du Cane Road, London Greater London W12 0NN/ GB

SNYDER, James Patrick

1086 Rosedale Drive, Atlanta, GA 30329/ US

(74) Advokat RADULOVIĆ, Božidar S.

Studentska bb, Lamela 3/18 , Podgorica, 81000 / ME

(57)

1. Jedinjenje formule:

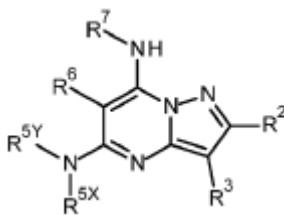

ili njegova farmaceutski prihvatljiva so ili solvat;

gde:

-R5X je -L5X-Q;

-L5X- je nezavisno kovalentna jednostruka veza ili -L5XA-;

-L5XA- je nezavisno ravni ili razgranati zasićeni C1-6alkilen, i opciono je supstituisan sa jednom ili više grupa izabranim od -OH i -ORL5X, gde je svaki -RL5X je nezavisno ravni ili razgranati zasićeni C1-6alkil ili zasićeni C3-6cikloalkil;

je -Q ne-aromatični heterociklični prsten koji ima od 5 do 7 atoma prstena, uključujući barem jedan atom azota prstena, i supstituisan je sa „n“ grupom -J, i supstituisan je sa „m“ grupom -RQ;

"n" je 1, 2, ili 3;

"m" je 0, 1, 2, ili 3;

svaki -J je nezavisno -OH;

svaki -RQ je nezavisno nezavisno -F, -Cl, -Br, -I, -RQA, -CF3, -OCF3, -NH2, -NHRQA, -NRQA2, piroolidino, piperidino, morfolino, piperazino, N-(RQA)-piperazino, -SH, -SRQA, ili -CN;

svaki -RQA je nezavisno ravni ili razgranati zasićeni C1-6alkil ili zasićeni C3-6cikloalkil;

-R5Y je nezavisno -H ili -R5YA;

-R5YA je nezavisnoravni ili razgranati zasićeni C1-6alkil;

-R7 je nezavisno -R7X ili -C(=O)R7X;

svaki -R7X je nezavisno:

-R7A, -R7B, -R7C, -R7D, -R7E,

-L7-R7B, -L7-R7C, -L7-R7D, ili -L7-R7E;

svaki -L7- je nezavisno ravni ili razgranati zasićeni C1-6alkilen;

svaki -R7A je nezavisno ravni ili razgranati zasićeni C1-6alkil, i opciono je supstituisan sa jednim ili više supstituenata -W1;

svaki -R7B je zasićeni C3-6cikloalkil, i opciono je supstituisan sa jednim ili više supstituenata -W2;

svaki -R7C je ne-aromatični C3-7heterociklil, i opciono je supstituisan sa jednim ili više supstituenata -W2;

svaki -R7D je fenil ili naftil, i opciono je supstituisan sa jednim ili više supstituenata -W3;

svaki -R7E je C5-12heteroaril, i opciono je supstituisan sa jednim ili više supstituenata -W3;

svaki -W1 je nezavisno:

-F, -Cl, -Br, -I, -CF₃, -OH, -ORW1, -OCF₃, -NH₂, -NHRW1, -NRW12, pirolidino, piperidino, morfolino, piperazino, N-(RW1)-piperazino, -C(=O)OH, -C(=O)ORW1, -C(=O)NH₂, -C(=O)NHRW1, -C(=O)NRW12, -C(=O)-pirolidino, -C(=O)-piperidino, -C(=O)-morfolino, -C(=O)-piperazino, -C(=O)-N-(RW1)-piperazino, -S(=O)RW1, -S(=O)2RW1, -S(=O)2NH₂, -S(=O)2NHRW1, -S(=O)2NRW12, -S(=O)2pirolidino, -S(=O)2-piperidino, -S(=O)2-morfolino, -S(=O)2-piperazino, -S(=O)2-N-(RW1)-piperazino, -CN, ili -NO₂;

gde svaki -RW1 je nezavisno ravni ili razgranati zasićeni C1-6alkil, fenil, ili -CH₂-fenil, gde je svaki fenil opciono je supstituisan sa jednom ili više grupa izabranim od -F, -Cl, -Br, -I, -RW11, -CF₃, -OH, -ORW11, i -OCF₃, gde je svaki -RW11 je nezavisno ravni ili razgranati zasićeni C1-6alkil;

svaki -W2 je nezavisno:

-F, -Cl, -Br, -I, -RW2, -CF₃, -OH, -ORW2, -OCF₃, -NH₂, -NHRW2, -NRW22, pirolidino, piperidino, morfolino, piperazino, N-(RW2)-piperazino, -C(=O)OH, -C(=O)ORW2, -C(=O)NH₂, -C(=O)NHRW2, -C(=O)NRW22, -C(=O)-pirolidino, -C(=O)-piperidino, -C(=O)-morfolino, -C(=O)-piperazino, -C(=O)-N-(RW2)-piperazino, -S(=O)RW2, -S(=O)2RW2, -S(=O)2NH₂, -S(=O)2NHRW2, -S(=O)2NRW22, -S(=O)2pirolidino, -S(=O)2-piperidino, -S(=O)2-morfolino, -S(=O)2-piperazino, -S(=O)2-N-(RW2)-piperazino, -CN, ili -NO₂;

gde svaki -RW2 je nezavisno ravni ili razgranati zasićeni C1-6alkil, fenil, ili -CH₂-fenil, gde je svaki fenil opciono je supstituisan sa jednom ili više grupa izabranim od -F, -Cl, -Br, -I, -RW22, -CF₃, -OH, -ORW22, i -OCF₃, gde je svaki -RW22 je nezavisno ravni ili razgranati zasićeni C1-6alkil;

svaki -W3 je nezavisno:

-F, -Cl, -Br, -I, -RW3, -CF₃, -OH, -ORW3, -OCF₃, -NH₂, -NHRW3, -NRW32, pirolidino, piperidino, morfolino, piperazino, N-(RW3)-piperazino, -C(=O)OH, -C(=O)ORW3, -C(=O)NH₂, -C(=O)NHRW3, -C(=O)NRW32, -C(=O)-pirolidino, -C(=O)-piperidino, -C(=O)-morfolino, -C(=O)-piperazino, -C(=O)-N-(RW3)-piperazino, -S(=O)RW3, -S(=O)2RW3, -S(=O)2NH₂, -S(=O)2NHRW3, -S(=O)2NRW32, -S(=O)2pirolidino, -S(=O)2-piperidino, -S(=O)2-morfolino, -S(=O)2-piperazino, -S(=O)2-N-(RW3)-piperazino, -CN, ili -NO₂;

gde svaki -RW3 je nezavisno ravni ili razgranati zasićeni C1-6alkil, fenil, ili -CH₂-fenil, gde je svaki fenil opciono je supstituisan sa jednom ili više grupa izabranim od -F, -Cl, -Br, -I, -RW33, -CF₃, -OH, -ORW33, i -OCF₃, gde je svaki -RW33 je nezavisno ravni ili razgranati zasićeni C1-6alkil;

-R3 je nezavisno -R3A ili -R3B;

-R3A je nezavisno ravni ili razgranati zasićeni C1-6alkil;

-R3B je nezavisno zasićeni C3-7cikloalkil;

-R2 je nezavisno -H ili -R2A;

-R2A je nezavisno -F, -Cl, -Br, -I, -R2AA, -CF₃, -OH, -OR2AA, -OCF₃, -NH₂, -NHR2AA, -NR2AA2, pirolidino, piperidino, morfolino, piperazino, N-(R2AA)-piperazino, -SH, -SR2AA, ili -CN;

svaki -R2AA je nezavisno ravni ili razgranati zasićeni C1-6alkil;

-R6 je nezavisno -H ili -R6A;

-R6A je nezavisno -F, -Cl, -Br, -I, -R6AA, -CF₃, -OH, -OR6AA, -OCF₃, -NH₂, -NHR6AA, -NR6AA2, pirolidino, piperidino, morfolino, piperazino, N-(R6AA)-piperazino, -SH, -SR6AA, ili -CN; i

svaki -R6AA je nezavisno ravni ili razgranati zasićeni C1-6alkil.

Patent sadrži još 29 patentnih zahtjeva

(11) **03428** (13) **B**

(51) **C07D 295/096**^(2006.01)

(21) P-2019-120

(22) 20.12.2012

(30) 20120000006 03.01.2012 DK
201261582527P 03.01.2012 US

(96) 12815676.7/20.12.2012

(86) EP PCT/EP2012/076377/20.12.2012

(87) WO 2013/102573/11.07.2013/2013/28

(97) EP 2800746/12.11.2014/2014/46
EP 2800746/17.04.2019/2019/16

(54) me **POSTUPAK ZA PROIZVODNJU 1-[2-(2,4-DIMETIL-FENILSULFANIL)-FENIL]-PIPERAZINA**
en **PROCESS FOR THE MANUFACTURE OF 1-[2-(2,4-DIMETHYL-PHENYLSULFANYL)-**
PHENYL]-PIPERAZINE

(73) H. Lundbeck A/S

Ottiliavej 9, Valby, 2500 / DK

(72) CHRISTENSEN, Kim Lasse

Holmstrupvej 73, DK-4200 Slagelse/ DK

(74) Advokat RADULOVIĆ, Božidar S.

Studentska bb, Lamela 3/18, Podgorica, 81000 / ME

(57)

1. Postupak za proizvodnju

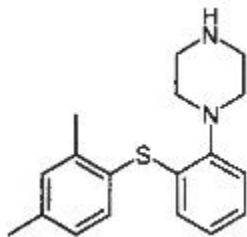

ili njegovih farmaceutski prihvatljivih soli (Jedinjenje I), pri čemu pomenuti postupak obuhvata reagovanje jedinjenja formule II

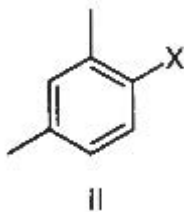

u kojoj X predstavlja Br ili I, sa jedinjenjem formule III

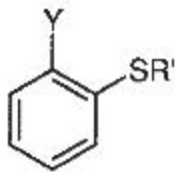

III

u kojoj Y predstavlja Cl ili Br, a R' predstavlja vodonik ili jon metala, i jedinjenjem formule IV

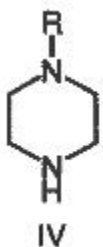

IV

u kojoj R predstavlja vodonik ili zaštitnu grupu, u prisustvu rastvarača, baze i paladijumskeg katalizatora koji se sastoji od izvora paladijuma i fosfinskog liganda na temperaturi između 50°C i 130°C, gde kada R predstavlja zaštitnu grupu, pomenuta zaštitna grupa uklanja se u narednoj fazi.

Patent sadrži još 17 patentnih zahtjeva

(11) **03381** (13) **B**

(51) **C07D 405/14**^(2006.01)

C07D 405/04^(2006.01)

A61P 13/12^(2006.01)

A61P 9/10^(2006.01)

C07D 413/14^(2006.01)

C07D 417/14^(2006.01)

A61P 9/12^(2006.01)

A61K 31/43^(2006.01)

(21) P-2019-121

(22) 14.10.2015

(30) 201462064234 P 15.10.2014 US

(96) 15785014.0/14.10.2015

(86) US PCT/US2015/055421/14.10.2015

(87) WO 2016/061161/21.04.2016/2016/16

(97) EP 3207039/23.08.2017/2017/34

EP 3207039/06.03.2019/2019/10

(54) me **INHIBITORI ALDOSTERON SINTAZE**
en **ALDOSTERONE SYNTHASE INHIBITORS**

(73) Boehringer Ingelheim International GmbH

Binger Strasse 173, Ingelheim am Rhein, 55216/ DE

(72) HORNBERGER, Keith R.

c/o VP IP Legal Boehringer Ingelheim USA Corp. 900 Ridgebury Road PO Box 368, Ridgefield, Connecticut 06877/ US

MEYERS, Kenneth Michael

c/o VP IP Legal Boehringer Ingelheim USA Corp. 900 Ridgebury Rd. P.O. Box 368, Ridgefield, Connecticut 06877/ US

NEMOTO, Peter Allen

c/o VP IP Legal Boehringer Ingelheim USA Corp. 900 Ridgebury Rd. P.O. Box 368, Ridgefield, Connecticut 06877/ US

SURPRENANT, Simon

C/o VP IP Legal Boehringer Ingelheim USA Corp., Ridgefield, Connecticut 06877/ US

YU, Hui

c/o VP IP Legal Boehringer Ingelheim USA Corp. 900 Ridgebury Rd. P.O. Box 368, Ridgefield, Connecticut 06877/ US

(57)

1. Jedinjenje formule I

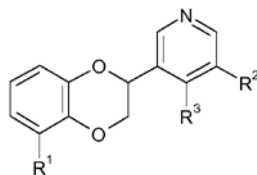

I

gdje:

R1 je odabran između -C(O)NH₂, -C(O)NH(CH₃) i -CN;

R2 je -(X)-R4, gdje

-(X)- je veza, -CH₂-, ili -O-; i
R₄ je odabran između
-H;
C₁-3 alkil, opciono supstituisan sa jednom do četiri grupe odabrane između -F, -OH, i -SO₂C₁₋₃ alkil;
halogen;
-CN;
-SO₂C₁₋₃ alkil;
-C(O)N(C₁₋₃ alkil)₂, obezbeđen -(X)- nije -O-;
-NHC(O)R₅ ili -N(CH₃)C(O)R₅, obzbeđuje da -(X)- je -CH₂- i gdje R₅ je odabran između C₃₋₆ cikloalkil i
C₁₋₃ alkil opciono supstituisan sa jednom do tri -F grupe;
-NHSO₂C₁₋₃ alkil;
-CH(ciklopropil)NHSO₂C₁₋₃ alkil;
-OCH₂C(O)N(C₁₋₃ alkil)₂, obezbeđen da -(X)- je -CH₂-;
-S(=O)(=NH)CH₃, obezbeđen da -(X)- je -CH₂-;
heterociklil odabran između tetrahidropirani, tetrahidrofuranil, pirolidinil, 1,1-diokso[1,2]-tiazin, morfolinil,
oksazolidinil, piperidinil, azetidinil, gdje navedeni heterociklil je opciono supstituisan sa jednom do tri grupe
odabrane između -C(O)C₁₋₃ alkil, halogen, -OH, okso i C₁₋₃ alkil;
-C(O)-heterociklil, obezbeđen da -(X)- je -CH₂-, gdje navedeni heterociklil je odabran između morfolin-4-il,
pirolidin-1-il i piperidin-1-il, opciono supstituisan sa jednom ili dvije grupe odabrane između -F i -OH ;
C₃₋₆ cikloalkil opciono supstituisan sa -CN ili -OH; i
fenil, opciono supstituisan sa -SO₂NH₂; i
R₃ je H, ili C₁₋₃ alkil opciono supstituisan sa -OH; ili
R₂ i R₃ zajedno obrazuju anelirani petočlani cikloalkilni prsten opciono supstituisan sa -OH;
ili njegova so ili stereioizomer.

Patent sadrži još 20 patentnih zahtjeva

(11) **03440** (13) **B**

(51) **C07K 16/00**^(2006.01)

(21) P-2019-122

(22) 16.05.2012

(30) 201161488716 P 21.05.2011 US

201161530353 P 01.09.2011 US

(96) 12790075.1/16.05.2012

(86) US PCT/US2012/038219/16.05.2012

(87) WO 2012/162067/29.11.2012/2012/48

(97) EP 2714733/09.04.2014/2014/15

EP 2714733/23.01.2019/2019/04

(54) me **CD3-VEZUJUĆI MOLEKULI SPOSOBNI ZA VEZIVANJE ZA HUMANI I NEHUMANI CD3**
en **CD3-BINDING MOLECULES CAPABLE OF BINDING TO HUMAN AND NON-HUMAN CD3**

(73) MacroGenics, Inc.

9704 Medical Center Drive, Rockville, MD 20850/ US

(72) HUANG, Ling

8210 Moorland Lane, Bethesda, MD 20817/ US

JOHNSON, Leslie S.

14411 Poplar Hill Road, Darnestown, MD 20874/ US

(57)

1. CD3-vezujući molekul koji sadrži antigen-vezujući fragment antitela, naznačen time što navedeni antigen-vezujući fragment sadrži CD3-specifičan VL domen antitela i CD3-specifičan VH domen antitela, pri čemu navedeni CD3-specifičan VL domen i navedeni CD3-specifičan VH domen formiraju antigen-vezujući domen sposoban za imunospecifično vezivanje za oba, epitop humanog CD3 i epitop CD3 nehumanog sisara, gde:

(I) navedeni CD3-specifičan VL domen je izabran iz grupe koja se sastoji od h-mab2

VL-4 koji ima aminokiselinsku sekvencu SEQ ID N0:22, h-mab2 VL-6 koji ima aminokiselinsku sekvencu SEQ ID N0:26, h-mab2 VL-7 koji ima aminokiselinsku sekvencu SEQ ID N0:28, h-mab2 VL-8 koji ima aminokiselinsku sekvencu SEQ ID N0:30, h-mab2 VL-9 koji ima aminokiselinsku sekvencu SEQ ID N0:32 i h-mab2 VL-10 koji ima aminokiselinsku sekvencu SEQ ID N0:34, i

(II) navedeni CD3-specifičan VH domen je izabran iz grupe koja se sastoji od h-mab2

VH-1 koji ima aminokiselinsku sekvencu SEQ ID N0:36, h-mab2 VH-2 koji ima aminokiselinsku sekvencu SEQ ID N0:38, h-mab2 VH-3 koji ima aminokiselinsku sekvencu SEQ ID N0:40, h-mab2 VH-4 koji ima aminokiselinsku sekvencu SEQ ID N0:42, h-mab2 VH-5 koji ima aminokiselinsku sekvencu SEQ ID N0:44, h-mab2

VH-6 koji ima aminokiselinsku sekvencu SEQ ID N0:46, h-mab2 VH-7 koji ima aminokiselinsku sekvencu SEQ ID N0:48 i h-mab2 VH-8 koji ima aminokiselinsku sekvencu SEQ ID N0:SO.

Patent sadrži još 18 patentnih zahtjeva

(11) **03382** (13) **B**

(51) **A61K 35/74**^(2006.01)

A61P 1/00^(2006.01)

A61P 37/00^(2006.01)

(21) P-2019-124

(22) 08.10.2012

(30) 201117313 07.10.2011 GB

(96) 16166001.4/08.10.2012

(97) EP 3097919/30.11.2016/2016/48

EP 3097919/13.03.2019/2019/11

(54) me **BAKTERIJA ZA UPOTREBU KAO PROBIOTIK ZA NUTRITIVNE I MEDICINSKE PRIMENE**
en **BACTERIUM FOR USE AS A PROBIOTIC FOR NUTRITIONAL AND MEDICAL**
APPLICATIONS

(73) 4D PHARMA RESEARCH LIMITED

Life Sciences Innovation Building Cornhill Road, Aberdeen AB25 2ZS/ GB

(72) KELLY, Denise

GT Biologics Ltd c/o Rowett Research Institute Greenburn Road Aberdeen, Aberdeenshire, AB21 9SB/
GB

MULDER, Imke

c/o 4D Pharma Research Limited Life Sciences Innovation Building Cornhill Road, Aberdeen, AB25 2ZS/
GB

(57)

1. Bakterijskisoj kojiima

(a) 16S rRNK indentitet bar 99.5% sa sojem koji pripada vrsti *Roseburia hominis* deponovanoj pod pristupnim brojem NCIMB 14029, ili

(b) DNK-DNK homologiju bar 95% identičnu sa bakterijskim sojem koji pripada vrsti *Roseburia hominis* deponovanoj pod pristupnim brojem NCIMB 14029

za upotrebu u medicini.

Patent sadrži još 17 patentnih zahtjeva

(11) **03384** (13) **B**

(51) **A61P 3/10**^(2006.01)

A61K 38/28^(2006.01)

A61K 31/5585^(2006.01)

(21) P-2019-126

(22) 04.05.2015

(30) 201461990402 P 08.05.2014 US

(96) 15723388.3/04.05.2015

(86) US PCT/US2015/029010/04.05.2015

(87) WO 2015/171484/12.11.2015/2015/45

(97) EP 3140008/15.03.2017/2017/11

EP 3140008/17.04.2019/2019/16

(54) me **BRZODJELUJUĆI PRIPRAVCI INZULINA**
en **RAPID-ACTING INSULIN COMPOSITIONS**

(73) Eli Lilly and Company

Lilly Corporate Center, Indianapolis, IN 46285/ US

(72) CHRISTE, Michael Edward

c/o Eli Lilly and Company P.O. Box 6288, Indianapolis, Indiana 46206-6288/ US

HARDY, Thomas Andrew

c/o Eli Lilly and Company P.O. Box 6288, Indianapolis, Indiana 46206-6288/ US

(57)

1. Farmaceutski pripravak, naznačen time što sadrži inzulin i treprostiniol, gdje se koncentracija treprostiniola kreće od 0,0 l do 30 flM.

Patent sadrži još 29 patentnih zahtjeva

(11) **03386** (13) **B**

(51) **C12N 15/85**^(2006.01)

C07K 16/00^(2006.01)

C07K 16/18^(2006.01)

A01K 67/027^(2006.01)

C07K 16/46^(2006.01)

C12N 15/10^(2006.01)

(21) P-2019-128

(22) 22.06.2011

(30) 357317 P 22.06.2010 US

357314 P 22.06.2010 US

(96) 16154526.4/22.06.2011

(97) EP 3034608/22.06.2016/2016/25

EP 3034608/30.01.2019/2019/05

(54) me **HIBRIDNI LAKI LANAC IMUNOGLOBULINA KOJI ISPOLJAVAJU MIŠEVI**
en **MICE EXPRESSING AN IMMUNOGLOBULIN HYBRID LIGHT CHAIN WITH A HUMAN**
VAEiable REGION

(73) REGENERON PHARMACEUTICALS, INC.

777 Old Saw Mill River Road, Tarrytown, NY 10591/ US

(72) MACDONALD, Lynn

16 Gedney Way, White Plains, NY 10605/ US

STEVENS, Sean

355 Berry Street 413, San Francisco, CA 94158/ US

GURER, Cagan

8 Pamela Lane, Valhalla, NY 10595/ US

MURPHY, Andrew J.

10 Newton Court, Croton-on-Hudson, NY 10520/ US

HOSIAWA, Karolina A.

14 Church Street 2nd Floor, Tarrytown, NY 10591/ US

(57)

1. Miš, koji obuhvata nepreraspoređeni ljudski segment promenljivog gena teskog lanca imunoglobulina (hVH) i nepreraspoređeni ljudski segment promenljivog gena imunoglobulina (hDH) i nepreraspoređeni ljudski segment spojnog gena (hJH) koji su funkcionalno povezani na mišji gen nepromenljivi teskog lanca imunoglobulina (CH). i

nepreraspoređeni ljudski A. segment gena promenljivog lakog lanca imunoglobulina (hVA.) i ljudski spojni segment gena kod čoveka (hJA.) koji su funkcionalno povezani na *K* konstantni segment gena lakog lanca imunoglobulina (CK) na endogenom mišjem *K* lokusu lakog lanca imunoglobulina, pri čemu se održavaju na pomenutom lokusu *K* gde se održavaju na pomenutom lokusu *K* intronski element pojačavača uzvodno od *CK* segmenta gena (označen sa *EK*_i) i 3' *K* pojačavač nizvodno od *CK* segmenta gena (označen sa *EK*_{3'}),

pri čemu miš ispoljava antitelo koje obuhvata teski lanac koji obuhvata preraspoređenu ljudsku VH- DH-JH sekvencu i mišju CH sekvencu i laki lanac koji obuhvata preraspoređenu ljudsku VA. i JA. sekvencu, i mišju *CK* sekvencu.

Patent sadrži još 18 patentnih zahtjeva

(11) **03400** (13) **B**

(51) **C07J 31/00**^(2006.01)

A61K 31/567^(2006.01)

A61K 31/573^(2006.01)

C07J 41/00^(2006.01)

A61P 5/36^(2006.01)

(21) P-2019-131

(22) 07.07.2010

(30) 20091034362 20.07.2009 DE

(96) 17176264.4/07.07.2010

(97) EP 3252069/06.12.2017/2017/49

EP 3252069/03.04.2019/2019/14

(54) me **(11BETA, 17BETA)-17-HDROKSI-11-[4-(METILSULFONIL)FENIL]-17-(PENTALFUOROMETIL)ESTRA-4,9-DIEN-3-ON ZA UPOTREBU ZA LEČENJE BOLESTI en (11.BETA.,17.BETA.)-17-HYDROXY-11-[4-(METHYLSULFONYL)PHENYL]-17-(PENTALFUOROMETHYL)ESTRA-4,9-DIEN-3-ONE FOR USE IN THE TREATMENT OF DISEASES**

(73) BAYER PHARMA AKTIENGESELLSCHAFT

Müllerstrasse 178, Berlin, 13353 / DE

(72) Schwede, Wolfgang

Magdeburger Str. 41a, Glienicke, 16548/ DE

Klar, Ulrich

Isegrimsteig 8a, Berlin, 13503/ DE

Möller, Carsten

Gaillardstr. 14B, Berlin, 13187/ DE

Rotgeri, Andrea

Damwildsteig 21, Berlin, 13503/ DE

Bone, Wilhelm

Drewitzer Str. 46, Berlin, 13467/ DE

(57)

1. Jedinjenje (11 β , 17 β)-17 -hidroksi-11-[4-(metilsulfonil)fenil]-17 -(pentafluoroetil) estra-4 , 9-dien-3-on

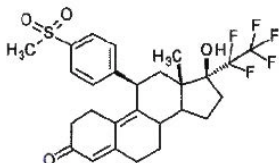

naznačeno time sto je za lečenje i profilaksu bolesti.

Patent sadrži još 10 patentnih zahtjeva

(11) **03401** (13) **B**

(51) **C02F 9/00**^(2006.01)
E02B 15/04^(2006.01)
E02B 15/08^(2006.01)
B01D 21/00^(2006.01)
C02F 1/56^(2006.01)
C02F 1/78^(2006.01)
C02F 103/00^(2006.01)
C02F 103/42^(2006.01)
C02F 1/44^(2006.01)
C02F 1/467^(2006.01)

E04H 4/12^(2006.01)
E02B 15/06^(2006.01)
E04H 4/00^(2006.01)
B01D 21/01^(2006.01)
C02F 1/76^(2006.01)
C02F 1/72^(2006.01)
C02F 103/02^(2006.01)
C02F 1/00^(2006.01)
C02F 1/52^(2006.01)

(21) P-2019-132

(22) 16.09.2019

(30) 201361900308 P 05.11.2013 US
201414531395 03.11.2014 US

(96) 14841384.2/04.11.2014

(86) IB PCT/IB2014/002991/04.11.2014

(87) WO 2015/068042/14.05.2015/2015/19

(97) EP 3066056/14.09.2016/2016/37
EP 3066056/27.02.2019/2019/09

(54) me **PLUTAJUĆE JEZERO I METODE PREČIŠĆAVANJA VODE U PLUTAJUĆEM JEZERU**
en **FLOATING LAKE AND METHODS OF TREATING WATER WITHIN A FLOATING LAKE**

(73) Crystal Lagoons (Curaçao) B.V.

Kaya W.F.G. (Jombi), Mensing 14/ CW

(72) FISCHMANN, Fernando Benjamin

Avenida Kennedy 9070, 12th Floor, Vitacura, Santiago/ CL

(57)

I. Metoda za tretiranje vode u veštačkom plutajućem jezeru (I), gde plutajuće jezero ima površinu vodenog ogleдала od bar 5.000 m² i koje je pogodno da pluta u većem vodenom telu koje ga okružuje i koje je postavljeno u većem vodenom telu kao što je okean, reka, jezero, rezervoar, laguna, bara, kanal, estuar, vodotok, zaliv, rečno ušće, pribranska akumulacija, bara, luka ili zaliv, plutajuće jezero (I) sastoji se od zidova (3) i dna (2), gde zidovi (3) imaju obod (4), gde obod (4) sadrži sistemi za plutanje (5) i gde je dno (2) plutajućeg jezera (I) konstruisano od fleksibilnog materijala koji ima Jangov moduo elastičnosti do 20 GPa, gde metoda obuhvata:

a. dodavanje oksidansa u vodu kako bi se održavao nivo ORP od bar 550 mV u minimalnom periodu od 10 do 20 sati u okviru ciklusa od 52 sata;

b. dodavanje flokulanta u vodu u plutajućem jezeru pre nego što zamućenost vode prede 5 NTU;

c. pokretanje rada jednog ili više pokretnog uređaja za crpljenje (42) pre nego što komponenta boje na dnu (2) plutajućeg jezera (I) prede 30% na CMYK skali, gde pokretni uređaj za crpljenje crpi deo vode sa dna (2) koje sadrži istaložene čestice;

d. filtriranje vode crpljene sa pokretnim uređajem za crpljenje (42) i vraćanje filtrirane vode u plutajuće jezero (I), time pružajući uklanjanje istaloženih čestica iz vode u plutajućem jezeru (I) bez filtriranja ukupne zapremine u plutajućem jezeru (I); i

e. dovođenje vode do plutajućeg jezera (I) radi održavanja pozitivnog pritiska od bar 20 Njutna po kvadratnom metru na površini vodenog ogledala plutajućeg jezera (I), gde dovedena voda ima stvarnu boju do 35 Pt-Co i bakterijski sadržaj manji od 2.000 CFU/ml i gde se pozitivni pritisak održava bar 50% vremena u intervalima od 7 d dana i gde je voda dovedena do plutajućeg jezera (I) pri brzini zamenjivanja prema sledećoj jednačini:

$$\textit{Brzina zamenjivanja} \sim \textit{Brzina isparavanja} + \textit{Brzina čišćenja} + \textit{Brzina procurivanja}$$

gde su sredstva za koordinisanje postavljena i konfigurisana da prime informaciju koja se odnosi na parametre kvaliteta vode, da obrade informaciju i da pokrenu sistem za primenu hemikalija (30), pokretni uređaj za crpljenje (42) i sistem za filtraciju (40).

Patent sadrži još 41 patentnih zahtjeva

(11) **03402** (13) **B**

(51) **B01J 21/00**^(2006.01)

B01J 35/04^(2006.01)

B01J 37/12^(2006.01)

B01D 53/94^(2006.01)

B01J 35/00^(2006.01)

B01J 23/755^(2006.01)

B01J 37/02^(2006.01)

B01J 37/18^(2006.01)

B01J 23/889^(2006.01)

C23C 8/00^(2006.01)

(21) P-2019-133

(22) 05.06.2014

(30) 20130404146 05.06.2013 PL

(96) 14745245.2/05.06.2014

(86) PL PCT/PL2014/050035/05.06.2014

(87) WO 2014/196883/11.12.2014/2014/50

(97) EP 2986374/24.02.2016/2016/08

EP 2986374/06.02.2019/2019/06

(54) me **POSTUPAK PROIZVODNJE MONOLITNOG KATALIZATORA ZA SIMULTANO UKLANJANJE NOX ČESTICA I ČESTICA UGLJENIKA, POSEBNO OTPADNIH GASOVA TERMOELEKTRANA NA FOSILNA GORIVA**
en **METHOD FOR MANUFACTURING A MONOLITHIC CATALYST FOR SIMULTANEOUS REMOVAL OF NOX AND CARBONPARTICLES, ESPECIALLY FROM OFF-GASES OF CARBON POWER PLANTS**

(73) Uniwersytet Jagiellonski

ul. Golebia 24, 31-007 Krakow/ PL

(72) NAJBAR, Mieczysława

Luzycka, 57/45, PL-30-658 Krakow/ PL

DUTKIEWICZ, Jarosław

Bohaterow Wietnamu, 3/26, PL-31-477 Krakow/ PL

WILKOSZ, Tomasz

Grota Roweckiego, 41/1, PL-30-348 Krakow/ PL

BIELANSKA, Elzbieta

Jaskolcza 6, PL-30-105 Krakow/ PL

WESELUCHA-BIRCZYNSKA, Aleksandra

Długa 43/4, PL-31-147 Krakow/ PL

CAMRA, Jozef

Krzywa 6/6, PL-31-149 Krakow/ PL

DANKO, Janusz

Solki 12A/9, PL-30-513 Krakow/ PL

BARTYZEL, Jakub

Wiedenska 80, PL-30-147 Krakow/ PL

(57)

1. Postupak za proizvodnju monolitnog katalizatora za istovremeno uklanjanje NOx čestica i čestica ugljenika, posebno iz otpadnih gasova termoelektrana na fosilna goriva, gde je monolit napravljen od čelične folije 1H18N9T/1.4541, i katalizator je dvofazni katalizator koji sadrži NiFe₂O₄ i Fe₂O₃ (maghemit) faze sa špinelnom strukturom, i ove faze formiraju mikrokristalite, **naznačen time što** se monolit oksiduje zagrevanjem pri brzini od 2 - 6 stepeni u minuti do temperaturnog raspona od 700-800°C, i zatim se žari na konačnoj temperaturi tokom 2-6 sati u atmosferi koja sadrži kiseonik; zatim se monolit hladi na sobnu temperaturu i sloj kiseonika formiran na površini monolitnih kanala se ispira

rastvorom niklove soli, nakon sušenja na vazduhu na sobnoj temperaturi tokom 2 - 6 sati, monolit se zagreva u struji vazduha do temperature od 700 -800°C, i ponovo se žari na konačnoj temperaturi tokom 2-6 sati, nakon hlađenja do sobne temperature konačno dobijeni oksidni slojevi podležu redukciji propuštanjem vodonika brzinom od 200 -300 cm³/min tokom 1 sata, zatim se katalizator zagreva u struji vodonika (90-250 cm³/min) pri brzini od 2-6°C/min do temperature od 500°C, i održava se na ovoj temperaturi tokom 0,5-1,5 sati.

Patent sadrži još 2 patentnih zahtjeva

(11) **03450** (13) **B**

(51) **B01J 3/04**^(2006.01)
C01B 11/02^(2006.01)

B01J 4/02^(2006.01)

(21) P-2019-134

(22) 22.12.2011

(30) 102010055982 23.12.2010 DE

(96) 11805787.6/22.12.2011

(86) EP PCT/EP2011/006510/22.12.2011

(87) WO 2012/084247/28.06.2012/2012/26

(97) EP 2654940/30.10.2013/2013/44

EP 2654940/13.02.2019/2019/07

(54) me **POSTUPAK ZA PROIZVODNJU VODENOG STABILNOG RASTVORA HLOR DIOKSIDA**
en **METHOD FOR PRODUCING AN AQUEOUS STABLE CHLORINE DIOXIDE SOLUTION**

(73) A.P.F. Aqua System AG

Friedrich-Ebert-Str. 143 d-e, 42117 Wuppertal/ DE

(72) UHLMANN, Helmut

Friedrich-Ebert-Str. 143 d-e, 42117 Wuppertal/ DE

(57)

1. Postupak za proizvodnju vodenog rastvora hlor dioksida sa koncentracijom hlor dioksida u opsegu od 0,3 do 4,5 tež. %, koji sadrži korake:

(a) priprema hlorita,

(b) priprema peroksodisulfata,

(c) sjedinjavanje hlorita i peroksodisulfata u vodenom sistemu i u molskom odnosu peroksodisulfata prema hloritu $[S_2O_8^{2-}] / [ClO_2]$ većem od 1 uz formiranje vodenog rastvora hlor dioksida, pri čemu se za proizvodnju vodenog rastvora hlor dioksida ne dodaje dodatni pufer.

Patent sadrži još 12 patentnih zahtjeva

(11) **03432** (13) **B**

(51) **C07D 213/69**^(2006.01)

A61P 35/00^(2006.01)

A61K 31/4412^(2006.01)

(21) P-2019-136

(22) 09.09.2015

(30) WO2014CN86197 10.09.2014 WO

WO2015CN86995 14.08.2019 WO

(96) 15767599.2/09.09.2015

(86) US PCT/IB2015/056905/09.09.2015

(87) WO 2016/038552/17.03.2016/2016/11

(97) EP 3191450/19.07.2017/2017/29

EP 3191450/10.04.2019/2019/15

(54) me **PIRIDONSKI DERIVATI KORIŠĆENI KAO INHIBITORI KINAZE REORGANIZOVANE TOKOM TRANSFEKCIJE (RET)**

en **PYRIDONE DERIVATIVES AS REARRANGED DURING TRANSFECTION (RET) KINASE INHIBITORS**

(73) GlaxoSmithKline Intellectual Property Development Limited

980 Great West Road, Brentford, Middlesex TW8 9GS/ GB

(72) DEMARTINO, Michael P.

709 Swedeland Road, King of Prussia, Pennsylvania 19406/ US

GUAN, Huiping Amy

No 3 Building, 898 Halei Road, Zhangjiang Hi-Tech Park, Pudong, , Shanghai/ CN

(57)

1. Jedinjenje koje je N-(2-(dimetilamino) etil)-3-(2-(4-(4-etoksi-6-okso-1,6-dihidropiridin-3-il)-2-fluorofenil) acetamido)-5-(trifluorometil) benzamid, predstavljeno Formulom (1):

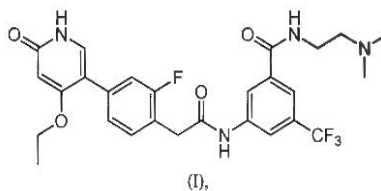

ili njegova farmaceutski prihvatljiva so.

Patent sadrži još 14 patentnih zahtjeva

(11) **03403** (13) **B**

(51) **A61K 39/00**^(2006.01)

A61K 39/395^(2006.01)

G01N 33/48^(2006.01)

(21) P-2019-137

(22) 07.08.2014

(30) 201361864948 P 12.08.2013 US

(96) 14836725.3/07.08.2014

(86) US PCT/US2014/050119/07.08.2014

(87) WO 2015/023507/19.02.2015/2015/07

(97) EP 3033104/22.06.2016/2016/25

EP 3033104/03.04.2019/2019/14

(54) me **POSTUPCI ZA POVEĆANJE FORSIRANOG EKSPIRATORNOG VOLUMENA KOD
ASMATIČARA KORIŠĆENJEM BENRALIZUMABA**

en **METHODS FOR INCREASING FORCED EXPIRATORY VOLUME IN ASTHMATICS USING
BENRALIZUMAB**

(73) ASTRAZENECA AB

, 151 85 Södertälje/ SE

(72) WARD, Christine

One MedImmune Way, Gaithersburg, MD 20878/ US

ROSKOS, Lorin

One MedImmune Way, Gaithersburg, MD 20878/ US

WANG, Bing

One MedImmune Way, Gaithersburg, MD 20878/ US

RAIBLE, Donald

317 Lenape Drive, Berwyn, PA 19312/ US

(57)

1. Efikasna količina benralizumaba za upotrebu u postupku lečenja astme povećanjem forsiranog ekspiratomog volumena u jednoj sekundi (FEV1) kod pacijenta sa astmom, pri čemu primena povećava pacijentov FEV1, pri čemu se benralizumab daje u dozi od 30 mg jednom na četiri nedelje dvanaest nedelja i onda jednom na svakih osam nedelja.

Patent sadrži još 11 patentnih zahtjeva

(11) **03404** (13) **B**

(51) **C07D 471/04**^(2006.01)

C07D 498/04^(2006.01)

A61P 35/00^(2006.01)

C07D 487/04^(2006.01)

A61K 31/437^(2006.01)

(21) P-2019-138

(22) 27.06.2016

(30) 201562185852 P 29.06.2015 US

(96) 16733459.8/27.06.2016

(86) EP PCT/EP2016/064899/27.06.2016

(87) WO 2017/001354/05.01.2017/2017/01

(97) EP 3313838/02.05.2018/2018/18

EP 3313838/03.04.2019/2019/14

(54) me **DERIVATI POLICIKLIČNIH AMIDA KAO CDK9 INHIBITORI**
en **POLYCYCLIC AMIDE DERIVATIVES AS CDK9 INHIBITORS**

(73) ASTRAZENECA AB

, Södertälje, 151 85 / SE

(72) PIKE, Kurt Gordon

Darwin Building, Cambridge Science Park, Milton Road, Cambridge CB4 0WG/ GB

BARLAAM, Bernard Christophe

Alderley Park, Macclesfield Cheshire SK10 4TG/ GB

HAWKINS, Janet

Alderley Park Cheshire, Macclesfield Cheshire SK10 4TG/ GB

DE SAVI, Christopher

35 Gatehouse Drive, Waltham, MA 02451/ US

VASBINDER, Melissa Marie

35 Gatehouse Drive, Waltham, MA 02451/ US

HIRD, Alexander

35 Gatehouse Drive, Waltham, MA 02451/ US

LAMB, Michelle

35 Gatehouse Drive, Waltham, MA 02451/ US

(57)

1. Jedinjenje Formule I:

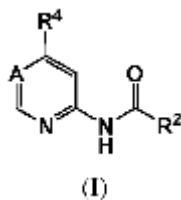

gde:

A je C(**R**₅) ili N;

R₅ je H, C₁₋₃ alkil, CN ili halogen;

R₂ je 3-7-člani heterocikloalkil ili 3-7-člani cikloalkil;

opciono supstituisan sa jednim do tri supstituenta nezavisno izabrana iz grupe koja se sastoji iz **R**₁₀, **OR**₁₀, **SR**₁₀, **S(O)R**₁₀, **S(O)₂R**₁₀, **C(O)R**₁₀, **C(O)OR**₁₀, **OC(O)R**₁₀, **OC(O)O R**₁₀, **NH₂**, **NH R**₁₀,

$N(R_{10})_2$, $NHC(O)H$, $NHC(O)R_{10}$, $NR_{10}C(O)H$, $NR_{10}C(O)R_{10}$, $NHS(O)_2R_{10}$, $NR_{10}S(O)_2R_{10}$, $NHC(O)OR_{10}$, $NR_{10}C(O)OR_{10}$, $NHC(O)NH_2$, $NHC(O)NHR_{10}$, $NHC(O)N(R_{10})_2$, $NR_{10}C(O)NH_2$, $NR_{10}C(O)NHR_{10}$, $NR_{10}C(O)N(R_{10})_2$, $C(O)NH_2$, $C(O)NHR_{10}$, $C(O)N(R_{10})_2$, $C(O)NHOH$, $C(O)NHOR_{10}$, $C(O)NHS(O)_2R_{10}$, $C(O)NR_{10}S(O)_2R_{10}$, $S(O)_2NH_2$, $S(O)_2NHR_{10}$, $S(O)_2N(R_{10})_2$, $S(O)_2NHC(O)OR_{10}$, $S(O)_2NR_{10}C(O)OR_{10}$, $C(O)H$, $C(O)OH$, OH , CN , NO_2 , F , Cl , Br i I ; pri čemu jedna ili više CH_2 grupa u prstenu može opciono biti zamjenjena odgovarajućim brojem $-C(O)$ grupa, jedan ili više atoma sumpora ili azota u prstenu mogu biti opciono oksidovani da formiraju S-oksidge ili N-oksidge;

R_{10} , pri svakom pojavljivanju, je nezavisno izabran iz grupe koja se sastoji iz 3 do 6-članova cikloalkilne ili heterocikloalkilne grupe, C_{1-6} alkil, $-O-C_{1-6}$ alkil, C_{1-6} alkil- $O-C_{1-6}$ alkil, NH_2 , $C(O)NH_2$, $C(O)H$, $C(O)OH$, OH , CN , NO_2 , F , Cl , Br i I ; gde dve R_{10} grupe zajedno sa atomima na koje su vezane mogu da formiraju 3 do 6-članu cikloalkil ili heterocikloalkil grupu; i svaka gore pomenuta R_{10} alkil, cikloalkil i heterocikloalkil grupa može biti dalje supstituisana sa jednim ili dva supstituenta nezavisno izabrana iz grupe koju čine CN , OH , halogen, C_{1-3} alkil, $-O-C_{1-3}$ alkil, NH_2 , $NH-C_{1-3}$ alkil i $NHC(O)-C_{1-3}$ alkil.

R_4 je

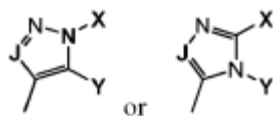

gde X i Y zajedno sa atomima na koje su vezani, formiraju 5-do 7-člani heterocikloalkilni prsten koji, pored azota za mostove, može da sadrži jedan ili dva heteroatoma izabrana od N , O i S koji prsten može biti zasićen ili delimično zasićen; gde jedna ili dve prstenaste CH_2 grupe mogu opciono biti zamjenjene odgovarajućim brojem $-C(O)$ grupa, jedan ili više atoma sumpora ili azota u prstenu koji mogu biti opciono oksidovani da formiraju S-oksidge ili N-oksidge i gde prsten može biti supstituisan na ugljeniku prstena sa jednim ili dva R_{10} supstituenta ili na azotu prstena sa supstituentom R_{12} ;

J je N ili CR_{11} ; i

R_{11} je H , C_{1-3} alkil;

R_{12} pri svakom pojavljivanju se nezavisno bira iz grupe koja se sastoji iz 3 do 6-člane cikloalkilne ili heterocikloalkilne grupe, C_{1-6} alkil, C_{1-6} alkil- $O-C_{1-6}$ alkil, $C(O)NH_2$, $C(O)H$; gde R_{12} alkil, cikloalkil i heterocikloalkil grupa mogu biti dalje supstituisane sa jednim ili dva supstituenta nezavisno izabrana iz CN , OH , i halogena, C_{1-3} alkil, NH_2 i $NH-C_{1-3}$ alkil, $NHC(O)-C_{1-3}$ alkil, ili njegovih farmaceutski prihvatljivih soli.

Patent sadrži još 15 patentnih zahtjeva

(11) **03405** (13) **B**

(51) **A01G 31/02**^(2006.01)

A01G 31/00^(2018.01)

(21) P-2019-139

(22) 11.08.2014

(30) 2013169317 19.08.2013 JP

(96) 14837962.1/11.08.2014

(86) US PCT/JP2014/071141/11.08.2014

(87) WO 2015/025752/26.02.2015/2015/08

(97) EP 3036988/29.06.2016/2016/26

EP 3036988/24.04.2019/2019/17

(54) me **SISTEM ZA GAJENJE BILJAKA I POSTUPAK ZA GAJENJE BILJAKA**
en **PLANT CULTIVATION SYSTEM AND PLANT CULTIVATION METHOD**

(73) MEBIOL INC.

1-25-8 Nakahara, Hiratsuka-shi, Kanagawa 254-0075/ JP

(72) YOSHIOKA, Hiroshi

11-1 shimo-ochiai, Hadano-shi, Kanagawa 257-0026/ JP

MORI, Yuichi

3-21-2-4 Kamariyaminami, Kanazawa-ku, Yokohama-shi, Kanagawa 236-0045/ JP

OKAMOTO, Akihiro

53-2-707 Nakano-cho, Sakae-ku, Yokohama-shi, Kanagawa 247-0015/ JP

MIURA, Shigeki

1-4 Kobushi-cho, Tokorozawa-shi, Saitama 359-0033/ JP

MIZUTANI, Tomoyoshi

2-4 Komatsubara-cho, Kita-ku, Osaka-shi, Osaka 530-0018/ JP

(57)

1.Sistem za gajenje biljaka koji obuhvata:

polivinilni alkoholni (PVA) film (1) za gajenje biljkaka (4) na njemu, i

sredstvo (2) za zadržavanje hranljivog fluida postavljenog kako bi bio u kontaktu sa donjom površinom PVA filma, i

gde pomenuti PVA film ima ravnotežni stepen bubrenja u opsegu od 125 do 250% mereno u vodi na 30 ° C

n a z n a č e n t i m e, što pomenut PVA film ima tangentu gubitka ($\tan \delta$) u opsegu od 0,005 do 0.2 mereno u ravnotežnom nabubrenom stanju u vodi na 30 ° C.

Patent sadrži još 6 patentnih zahtjeva

(11) **03475** (13) **B**

(51) **C07D 471/04**^(2006.01)

A61K 31/437^(2006.01)

A01P 7/04^(2006.01)

A01N 43/80^(2006.01)

A61K 38/05^(2006.01)

A01N 43/90^(2006.01)

A01P 5/00^(2006.01)

A61P 33/00^(2006.01)

A61K 45/06^(2006.01)

(21) P-2019-141

(22) 16.12.2010

(30) 20090287545P 17.12.2009 US

(96) 15200600.3/16.12.2010

(97) EP 3078664/12.10.2016/2016/41

EP 3078664/20.02.2019/2019/08

(54) me **ANTIPARAZITSKE KOMPOZICIJE DIHIDROAZOLA**
en **ANTIPARASITIC DIHYDROAZOLE COMPOSITIONS**

(73) Merial Inc.

3239 Satellite Boulevard, Duluth GA 30096-4640/ US

(72) LE HIR DE FALLOIS, Loic, Patrick

2259 Fairhaven Circle NE, Atlanta, Georgia 30305/ US

LEE, Hyoung Lk

103 Roundtop Road, Cary NC 27519/ US

Boehringer Ingelheim Animal Health USA Inc.

3239 Satellite Boulevard, Bldg. 500 Duluth,, GA 30096/ US

BECK, Brent Christopher

710 Straywhite Avenue, Apex NC 27539/ US

(74) Advokat POPOVIĆ, Miladin

Đoka Miraševića 21/III , Podgorica , 81000 / ME

(57)

1. Veterinarska ili poljoprivredna kompozicija za borbu protiv štetočina i parazita koja sadrži:

a) jedinjenje dihidroazola formule (I) ili njegovu veterinarski ili poljoprivredno prihvatljivu so:

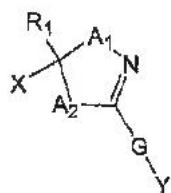

(I)

u kome:

R₁ je vodonik, halogen, -CN, ili alkil, haloalkil, alkenil, haloalkenil, alkinil, haloalkinil, cikloalkil, halocikloalkil, alkilcikloalkil ili cikloalkilalkil, od kojih je svaki nesupstituisan ili supstituisan sa jednim ili više od halogena, hidroksi, amino, alkil- ili di(alkil)amino, alkil, cikloalkil, haloalkil, alkenil, haloalkenil, alkinil, haloalkinil, alkoksi,

haloalkoksi, alkiltio, haloalkiltio, $R_7S(O)-$, $R_7S(O)_2-$, $R_7C(O)-$, $R_7R_8NC(O)-$, $R_7OC(O)-$, $R_7C(O)O-$, $R_7C(O)NR_8-$, -CN ili NO_2 ;

X je aril ili heteroaril, koji mogu biti nesupstituisani ili supstituisani sa jednim ili više od halogen, hidroksi, amino, alkil- ili di(alkil)amino, alkil, cikloalkil, haloalkil, alkenil, haloalkenil, alkinil, haloalkinil, alkoksi, haloalkoksi, alkiltio, haloalkiltio, $R_7S(O)-$, $R_7S(O)_2-$, $R_7C(O)-$, $R_7R_8NC(O)-$, $R_7OC(O)-$, $R_7C(O)O-$, $R_7C(O)NR_8-$, -CN ili NO_2 ;

A_1 i A_2 su nezavisno kiseonik, NR_2 ili CR_7R_8 ;

G je G-1 ili G-2;

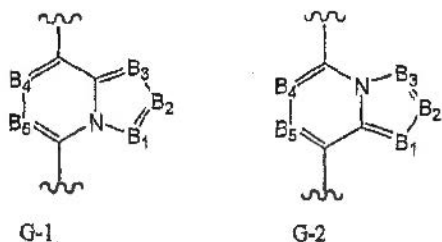

B_1 , B_2 , B_3 , B_4 i B_5 su nezavisno N ili C- R_9 ;

Y je vodonik, halogen, -CN; ili Y je alkil, haloalkil, alkenil, haloalkenil, alkinil, haloalkinil, cikloalkil, alkilcikloalkil, cikloalkilalkil, aril ili heterociklil ili heteroaril od kojih je svaki nesupstituisan ili supstituisan sa jednim ili više od halogena, hidroksi, amino, alkil- ili di(alkil)amino, alkil, cikloalkil, haloalkil, alkenil, haloalkenil, alkinil, haloalkinil, alkoksi, haloalkoksi, alkiltio, haloalkiltio, $R_7S(O)-$, $R_7S(O)_2-$, $R_7C(O)-$, $R_7R_8NC(O)-$, $R_7OC(O)-$, $R_7C(O)O-$, $R_7C(O)NR_8-$, -CN ili $-NO_2$; ili Y je Y-1, Y-2, Y-3, Y-4, Y-5, Y-6, Y-7, Y-8, Y-9, Y-10, Y-11, Y-12 ili Y-13;

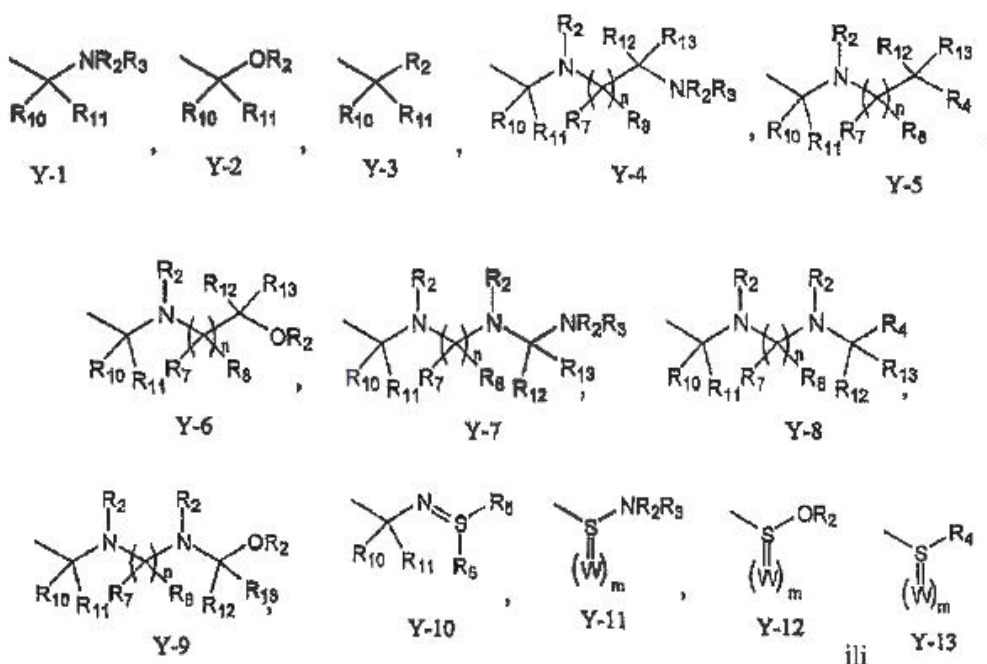

R_2, R_3 su nezavisno vodonik, alkil, haloalkil, tioalkil, alkiltioalkil, hidroksialkil, alkoksialkil, alkenil, haloalkenil, alkinil, haloalkinil, cikloalkil, $R_{10}S(O)-$, $R_{10}S(O)_2-$, $R_{10}C(O)-$, $R_{10}C(S)-$, $R_{10}R_{11}NC(O)-$, $R_{10}R_{11}NC(S)-$, $R_{10}OC(O)-$;

R_4, R_5 i R_6 su nezavisno vodonik, alkil, haloalkil, tioalkil, alkiltioalkil, hidroksialkil, alkoksialkil, alkenil, haloalkenil, alkinil, haloalkinil, cikloalkil, aril ili heteroaril;

R_7 i R_8 su nezavisno vodonik, alkil, haloalkil, tioalkil, alkiltioalkil, hidroksialkil, alkoksialkil, alkenil, haloalkenil, alkinil ili haloalkinil;

R_9 je vodonik, halogen, -CN ili alkil, haloalkil, alkenil, haloalkenil, alkinil, haloalkinil, cikloalkil, halocikloalkil, alkilcikloalkil ili cikloalkilalkil, od kojih je svaki nesupstituisan ili supstituisan sa jednim ili više od halogena, hidroksi, amino, alkil- ili di(alkil)amino, alkil, cikloalkil, haloalkil, alkenil, haloalkenil, alkinil, haloalkinil, alkoksi, haloalkoksi, alkiltio, haloalkiltio, $R_7S(O)-$, $R_7S(O)_2-$, $R_7C(O)-$, $R_7R_8NC(O)-$, $R_7OC(O)-$, $R_7C(O)O-$, $R_7C(O)NR_8-$, -CN ili $-NO_2$;

R_{10}, R_{11}, R_{12} i R_{13} su svaki nezavisno vodonik, alkil, haloalkil, tioalkil, alkiltioalkil, hidroksialkil, alkoksialkil, alkenil, haloalkenil, alkinil ili haloalkinil; ili R_{10} zajedno sa R_{11} formiraju =O, =S ili =NR₂; ili

R_{12} zajedno sa R_{13} formiraju =O, =S ili =NR₂;

W je O, S ili NR₂;

n je 1-4; i

m je 0,1 ili 2;

b) jedan ili više dodatnih aktivnih sredstava; i

veterinarski ili poljoprivredno prihvatljiv nosač ili razblaživač.

Patent sadrži još 35 patentnih zahtjeva

(11) **03476** (13) **B**

(51) **A61K 39/395**^(2006.01)

A61K 31/337^(2006.01)

C07K 16/28^(2006.01)

A61K 39/00^(2006.01)

A61K 45/06^(2006.01)

A61K 33/24^(2018.01)

A61K 31/513^(2006.01)

(21) P-2019-142

(22) 31.07.2014

(30) 201361861198P 01.08.2013 US

201361901732P 08.11.2013 US

201461933632P 30.01.2014 US

(96) 14752705.5/31.07.2014

(86) US PCT/US2014/049008/31.07.2019

(87) WO 2015017600/05.02.2015/2015/05

(97) EP 3027651/08.06.2016/2016/23

EP 3027651/27.02.2019/2019/09

(54) me **NEFU KOZILISANA ANTI-FGFR2IIIB ANTITIJELA**
en **AFUCOSYLATED ANTI-FGFR2IIIB ANTIBODIES**

(73) Five Prime Therapeutics, Inc.

111 Oyster Point Boulevard South , San Francisco, CA 94080 / US

(72) HARDING, Thomas

Two Corporate Drive, South San Francisco California 94080 / US

PIERCE, Kristen

Two Corporate Drive, South San Francisco California 94080/ US

PATIL, Namrata

Two Corporate Drive, South San Francisco California 94080/ US

BRENNAN, Thomas

Two Corporate Drive, South San Francisco California 94080 / US

HAMBLETON, Julie

Two Corporate Drive, South San Francisco California 94080 / US

(74) Advokat POPOVIĆ, Miladin

Đoka Miraševića 21/III , Podgorica , 81000 / ME

(57)

1. Kompozicija koja sadrži nekoliko anti-FGFR2IIIb antitela, u kojoj svako anti-FGFR2IIIb antitelo sadrži varijabilne regione teškog lanca i lakog lanca, naznačena time, što varijabilni region teškog lanca sadrži:

(i) HVR-H1 koji sadrži aminokiselinsku sekvencu SEQ ID NO: 6;

(ii) HVR-H2 koji sadrži aminokiselinsku sekvencu SEQ ID NO: 7; i

(iii) HVR-H3 koji sadrži aminokiselinsku sekvencu SEQ ID NO: 8;

i varijabilni region lakog lanca sadrži:

(iv) HVR-L1 koji sadrži aminokiselinsku sekvencu SEQ ID NO: 9;

(v) HVR-L2 koji sadrži aminokiselinsku sekvencu SEQ ID NO: 10; i

(vi) HVR-L3 koji sadrži aminokiselinsku sekvencu SEQ ID NO: 11;

pri čemu je najmanje 95% anti-FGFR2IIIb antitela u kompoziciji nefukozilisano;
za upotrebu u postupku za lečenje kancera kod pojedinca, gde kancer prekomerno eksprimira FGFR2IIIb.

Patent sadrži još 17 patentnih zahtjeva

(11) **03477** (13) **B**

(51) **A01K 67/027**^(2006.01)

C12N 9/64^(2006.01)

C07K 16/46^(2006.01)

(21) P-2019-143

(22) 17.12.2012

(30) 201161578097P 20.12.2011 US

(96) 12809955.3/17.12.2012

(86) US PCT/US2012/069981/17.12.2012

(87) WO 2013/096142/27.06.2013/2013/26

(97) EP 2793567/29.10.2014/2014/44

EP 2793567/27.02.2019/2019/09

(54) me **MIŠEVI SA HUMANIZOVANIM LAKIM LANCEM**
en **HUMANIZED LIGHT CHAIN MICE**

(73) Regeneron Pharmaceuticals, Inc.

777 Old Saw Mill River Road, Tarrytown, NY 10591-6707/ US

(72) MACDONALD, Lynn

16 Gedney Way, White Plains, NY 10605/ US

GURER, Cagan

8 Pamela Lane, Valhalla, NY 10595 / US

HOSIAWA, Karolina, A.

14 Church Street, 2nd Floor, Tarrytown, NY 10591 / US

STEVENS, Sean

355 Berry Street 413, San Francisco, CA 94158/ US

MURPHY, Andrew, J.

10 Newton Court, Croton-on-Hudson, NY New York 10520/ US

(74) Advokat RAIČEVIĆ, Dejan

Vojvode Boža br.1 , Cetinje , 81250 / ME

(57)

1. Miš koji sadrži:

(a) jedan ili više nerearanžiranih humanih Vλ genskih segmenata i jedan ili više nerearanžiranih humanih Jλ genskih segmenata na endogenom imunoglobulinskom lokusu kapa lakog lanca miša, pri čemu imunoglobulinski lokus kapa lakog lanca sadrži mišji Ck region;

(b) jedan ili više humanih Vh genskih segmenata, jedan ili više humanih Dh genskih segmenata i jedan ili više humanih Jh genskih segmenata na endogenom imunoglobulinskom lokusu teškog lanca miša; i

(c) modifikaciju imunoglobulinskog lokusa teškog lanca, pri čemu modifikacija eliminiše endogenu ADAM6 funkciju, koja je povezana sa smanjenjem plodnosti kod mužjaka miševa, pri čemu miš dalje sadrži sekvencu nukleinske kiseline koja kodira mišji ADAM6a protein ili njegov ortolog ili homolog ili funkcionalni fragment, od kojih je svaki funkcionalan za poboljšanje pomenutog smanjenja ili ponovno uspostavljanje plodnosti kod mužjaka miša, i sekvencu nukleinske kiseline koja kodira mišji ADAM6b protein, ili njegov ortolog ili homolog ili funkcionalni fragment, od kojih je svaki funkcionalan za poboljšanje pomenutog smanjenja ili ponovno uspostavljanje plodnosti kod mužjaka miša, pri čemu su sekvence nukleinskih kiselina koje kodiraju ADAM6 proteine, njihove ortologe, homologe, ili funkcionalne

fragmente prisutne u okviru humanih genskih segmenata teškog lanca.

Patent sadrži još 11 patentnih zahtjeva

(11) **03478** (13) **B**

(51) **A47L 9/06**^(2006.01)

E04H 4/16^(2006.01)

E02F 3/88^(2006.01)

E02F 3/92^(2006.01)

(21) P-2019-144

(22) 12.11.2014

(96) 14905887.7/12.11.2014

(86) IB PCT/IB2014/065981/12.11.2014

(87) WO 2016/075513/19.05.2016/2016/20

(97) EP 3217854/20.09.2017/2017/38

EP 3217854/20.03.2019/2019/12

(54) me **USISNI UREĐAJ ZA VELIKA VJEŠTAČKA VODENA TIJELA**
en **SUCTIONING DEVICE FOR LARGE ARTIFICIAL WATER BODIES**

(73) Crystal Lagoons (Curaçao) B.V.

Kaya W.F.G. (Jombi), Mensing 14/ CW

(72) FISCHMANN TORRES, Fernando Benjamin

Avenida Kennedy 9070, 10th Floor, Vitacura Santiago 7650382/ CL

PRIETO DOMINGUEZ, Jorge Eduardo

Padre Damian de Veuster 1885, Vitacura Santiago 7640794 / CL

(74) Advokat RADULOVIĆ, Božidar S.

Studentska bb, Lamela 3/18 , Podgorica, 81000 / ME

(57)

1. Usisni uređaj za usisavanje zapremine vode sa dna velikih veštačkih vodenih tela, sa površinama većim od 10.000 m², bez centralizovanih sistema za filtraciju, gde je usisni uređaj u stanju da vrši čišćenje pri površinskoj brzini od 325.000 stopa² za 24 sata (30.000 m² za 24 sata) ili većoj, gde uređaj sadrži:

- fleksibilnu ploču (1) predviđenu da obezbedi konstruktivni ram za povezivanje ili pričvršćivanje različitih komada i delova usisnog uređaja;

- više prvih četkica (2) u zavisnosti od ploče;

- više srednjih četkica (3) predviđenih da preusmere protok sa dna ka prvim četkicama (2);

- više bočnih četkica (5) predviđenih da sakupe protok iz usisnog uređaja i za izbegavanje ponovnog suspendovanja u protoku sa dna u okolini usisnog uređaja;

- više usisnih tačkica predviđenih da sabiraju kapacitet usisavanja kako bi se povećala snaga usisavanja na usisnim tačkama;

- više sigurnosnih točkova (6) predviđenih da pruže sekundarni oslonac i za izbegavanje oštećenja usisnog uređaja kada se prve četkice (2), srednje četkice (3) i/ili bočne četkice (5) istroše i više ne budu u stanju da pruže odgovarajući oslonac ili visinu usisavanja usisnog uređaja;

više sredstava za sakupljanje predviđenih da sakupe usisani protok sa dna i da saberu usisani protok sa dna u jednu ili više spoljašnjih usisnih linija;

- više unutrašnjih usisnih linija (9) predviđenih da sprovode usisani protok sa dna od više usisnih tačaka (4) ka više kolektora (7); i

- uređaj za spajanje (10) koji povezuje unutrašnje usisne linije (9) i kolektor, gde je vrednost protoka sa dna koji ulazi u usisni uređaj ista ili veća od one za protok usisan sa spoljašnjim sistemom za crpljenje (14).

Patent sadrži još 31 patentnih zahtjeva

(11) **03479** (13) **B**

(51) **A61K 39/395**^(2006.01)

A61K 51/00^(2006.01)

A61K 47/68^(2017.01)

(21) P-2019-145

(22) 02.06.2010

(30) 20090183774P 03.06.2009 US

(96) 10783998.7/02.06.2010

(86) US PCT/US2010/037046/02.06.2010

(87) WO 2010/141566/09.12.2010/2010/49

(97) EP 2437790/11.04.2012/2012/15

EP 2437790/20.02.2019/2019/08

(54) me **METODI KONJUGACIJE**
en **CONJUGATION METHODS**

(73) Immunogen, Inc.

830 Winter Street, Waltham, MA 02451/ US

(72) KELLOGG, Brenda A.

54 Greenleaf Avenue, Medford Massachusetts 02155 / US

SINGH, Rajeeva

40 Lanewood Avenue, Framingham Massachusetts 01701 / US

CHARI, Ravi V.J.

174 Winchester Street, Newton Massachusetts 02461/ US

(74) Advokat RADULOVIĆ, Božidar S.

Studentska bb, Lamela 3/18 , Podgorica, 81000 / ME

(57)

1. Proces pripremanja prečišćenog konjugata u rastvoru, **naznačen time**, što konjugat uključuje majtanzinoid koji sadrži tiol grupu vezanu za antitelo, proces uključuje korake: (a) dovođenje u kontakt majtanzinoida sa bifunkcionalnim poveziivačkim reagensom da bi se poveziivač kovalentno prikačio za majtanzinoid i time pripremila neprečišćena prva mešavina koja sadrži majtanzinoid sa poveziivačima vezanim za njega, (b) konjugacija antitela sa majtanzinoidom koji ima za sebe vezane poveziivače, reakcijom neprečišćene prve mešavine sa antitelom, da se pripremi druga mešavina, i (c) izlaganje druge mešavine filtraciji sa tangencijalnim protokom, dijalizi, gel filtraciji, adsorptivnoj hromatografiji, selektivnoj precipitaciji ili njihovoj kombinaciji da bi se time pripremio prečišćeni konjugat.

Patent sadrži još 15 patentnih zahtjeva

(11) **03480** (13) **B**

(51) **C07K 16/28**^(2006.01)

C07K 16/46^(2006.01)

A61P 35/02^(2006.01)

(21) P-2019-146

(22) 06.11.2009

(30) 20080112323P 07.11.2008 US

20090183291P 02.06.2009 US

(96) 15185767.9/06.11.2009

(97) EP 2982696/10.02.2016/2016/06

EP 2982696/27.03.2019/2019/13

(54) me **TRETIRANJE AKUTNE LIMFOBLASTNE LEUKEMIJE**
en **TREATMENT OF ACUTE LYMPHOBLASTIC LEUKEMIA**

(73) Amgen Research (Munich) GmbH

Staffelseestrasse 2, München, 81477 / DE

(72) ZUGMAIER, Gerhard

Staffelseestrasse 2 , München, 81477 / DE

DEGENHARD, Evelyn

Lenzfrieder Strasse 14, München, 80637/ DE

(74) Advokat RADULOVIĆ, Božidar S.

Studentska bb, Lamela 3/18 , Podgorica, 81000 / ME

(57)

1. CD19xCD3 bispecifičnog jednolančanog antitela za upotrebu u postupku lečenja, poboljšanja ili eliminaciju akutne limfoblastne leukemije (ALL) kod odraslog ispitanika, pri čemu je navedeni ispitanik pozitivan na Filadelfija hromozom (Ph+).

Patent sadrži još 17 patentnih zahtjeva

(11) **03481** (13) **B**

(51) **C07D 401/10**^(2006.01)
A61P 35/00^(2006.01)

A61K 31/4439^(2006.01)
A61P 29/00^(2006.01)

(21) P-2019-147

(22) 08.01.2008

(30) 20070000432 10.01.2007 GB
20070921310P 02.04.2007 US

(96) 14176452.2/08.01.2008

(97) EP 2805945/26.11.2014/2014/48
EP 2805945/03.04.2019/2019/14

(54) me **INDAZOLI SUPSTITUISANI AMIDOM KAO INHIBITORI POLI(ADP-RIBOZA)POLIMERAZE (PARP)**
en **AMIDE SUBSTITUTED INDAZOLES AS POLY(ADP-RIBOSE)POLYMERASE (PARP) INHIBITORS**

(73) MSD ITALIA S.R.L.

Via Vitorchiano, 151, Rome, 00189/ IT

(72) Ontoria Ontoria, Jesus Maria

Via Vitorchiano 151 , Rome , CAP 00189 / IT
Scarpeli, Rita

Via Vitorchiano 151 , Rome, CAP 00189/ IT

Schultz-Fademrecht, Carsten

Via Vitorchiano 151 , Rome , CAP 00189 / IT

Jones, Philip

33 Avenue Louis Pasteur , Boston, MA 02115-5727 / US

(74) Advokat POPOVIĆ, Miladin

Đoka Miraševića 21/III , Podgorica , 81000 / ME

(57)

1. Kombinacija koja sadrži jedinjenje formule I:

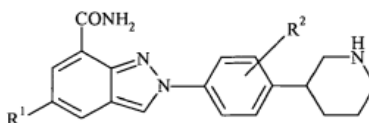

(I)

pri čemu:

R₁ je vodonik ili fluor; i

R₂ je vodonik ili fluor;

ili njegova farmaceutski prihvatljiva so, stereoizomer ili tautomer i jedno ili više sredstava protiv kancera.

Patent sadrži još 19 patentnih zahtjeva

(11) **03482** (13) **B**

(51) **C07K 14/55**^(2006.01)

A61K 38/20^(2006.01)

C07K 16/00^(2006.01)

(21) P-2019-148

(22) 14.03.2014

(30) 201361784669 P 14.03.2013 US

(96) 14769541.5/14.03.2014

(86) US PCT/US2014/028913/14.03.2014

(87) WO 2014/153063/25.09.2014/2014/39

(97) EP 2970441/20.01.2016/2016/03

EP 2970441/06.03.2019/2019/10

(54) me **POLIPETPIDI KOJI SADRŽE NEGLIKOZILISANI Fc**
en **AGLYCOSYLATED Fc-CONTAINING POLYPEPTIDES**

(73) Amgen, Inc.

One Amgen Center Drive Thousand Oaks, California 91320-1799/ US

(72) KANNAN, Gunasekaran

1056 Amberton Lane, Newbury Park, California 91320/ US

(74) Advokat POPOVIĆ, Miladin

Đoka Miraševića 21/III , Podgorica , 81000 / ME

(57)

1. Polipeptid koji sadrži Fc region humanog IgG1 antitela naznačen time, što navedeni Fc region sadrži mutaciju N297G, upotrebom EU šeme numeracije, i navedeni Fc region humanog IgG1 ima najmanje 90% identičnosti sa aminokiselinskom sekvencom prikazanom u SEQ ID NO:3 ili sadrži aminokiselinsku sekvencu prikazanu u SEQ ID NO:4; i u kome su dalje A287 i L306; V259 i L306; R292 i V302; ili V323 i I332, upotrebom EU šeme numeracije, u aminokiselinskoj sekvenci prikazanoj u SEQ ID NO:3 ili SEQ ID NO:4 supstituisani cisteinom.

Patent sadrži još 6 patentnih zahtjeva

(11) **03483** (13) **B**

(51) **C07D 239/84**^(2006.01)

A61K 31/517^(2006.01)

A61P 31/22^(2006.01)

(21) P-2019-149

(22) 19.06.2014

(30) 20130003120 19.06.2013 EP

20140165027 16.04.2014 EP

(96) 14732545.0/19.06.2014

(86) EP PCT/EP2014/062974/19.06.2014

(87) WO 2014/202737/24.12.2014/2014/52

(97) EP 3010891/27.04.2016/2016/17

EP 3010891/10.04.2019/2019/15

(54) me **AMORFNI LETERMOVIR I NJEGOVE ČVRSTE FARMACEUTSKE FORMULACIJE ZA ORALNO DAVANJE**
en **AMORPHOUS LETERMOVIR AND SOLID PHARMACEUTICAL FORMULATIONS THEREOF FOR ORAL ADMINISTRATION****LETERMOVIR**

(73) AiCuris Anti-infective Cures GmbH

Friedrich-Ebert-Strasse 475, Wuppertal, 42117/ DE

(72) SCHWAB, Wilfried

An den Hainbuchen 12, Werder (Havel), 14542 / DE

JUNG, Dirk

Herbststrasse 11, Dresden, 01139/ DE

SCHICKANEDER, Christian

Welserstrasse 3, Lauf an der Pegnitz, 91207/ DE

MÄRTENS, Welljanne

Mohnstrasse 20, Dresden, 01127/ DE

LIMMERT, Michael

Bärensteinerstrasse 17, Dresden, 01277/ DE

BOTHE, Clemens

Richard Wagnerstrasse 24, Leverkusen, 51375/ DE

BERWE, Mathias

Brunsberge 10, Sprockhövel, 45549 / DE

RINDERMANN, Nicole

Eschenweg 26, Bad Laer, 49196/ DE

(74) Advokat RADULOVIĆ, Božidar S.

Studentska bb, Lamela 3/18, Podgorica, 81000 / ME

(57)

1. Letermovir prema Formuli (I),

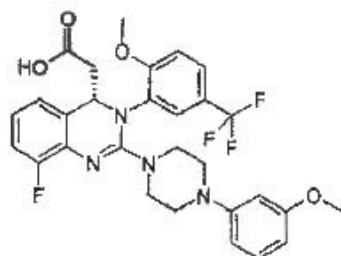

Formula (I),

koji je u amorfnom stanju, koji se dobija postupkom taloženja radi izolovanja amorfnog Letermovira, **način time, što** obuhvata taloženje pomenutog amorfnog Letermovira iz rastvarača mešljivih sa vodom, acetona ili acetonitrila, u višak umešavane vode, praćeno izolovanjem putem filtriranja ili centrifugiranja dobijenog Letermovira.

Patent sadrži još 14 patentnih zahtjeva

(11) **03484** (13) **B**

(51) **A61K 39/00**^(2006.01)

C12N 15/63^(2006.01)

C12N 15/67^(2006.01)

(21) P-2019-150

(22) 15.02.2013

(30) 2012EP00674 15.02.2012 WO

(96) 16001897.4/15.02.2013

(97) EP 3178488/14.06.2017/2017/24

EP 3178488/01.05.2019/2019/18

(54) me **NUKLEINSKA KISJELINA KOJA SADRŽI ILI KODIRA ZA HISTONSKU MATIČNU PETLJU I POLI(A) SEKVENCU ILI POLIADENILACIONI SIGNAL ZA POVEĆANJE EKSPRESIJE ENKODIRAJUĆEG TUMORSKOG ANTIGENA**

en **NUCLEIC ACID COMPRISING OR CODING FOR A HISTONE STEM-LOOP AND A POLY(A) SEQUENCE OR A POLYADENYLATION SIGNAL FOR INCREASING THE EXPRESSION OF AN ENCODED TUMOUR ANTIGEN**

(73) CureVac AG

Paul-Ehrlich-Str. 15, Tübingen, 72076/ DE

(72) Theß, Andreas

Hindenburgstr. 9, Kusterdingen , 72127 / DE

Schlake, Thomas

Gartenweg 1, Gundelfingen , 79194/ DE

Probst, Jochen

In den Kirchhofländern 19, Wolfschlugen , DE-72649/ DE

(74) Advokat RADULOVIĆ, Božidar S.

Studentska bb, Lamela 3/18 , Podgorica, 81000 / ME

(57)

1. Komplet ili komplet delova koji sadrži:

A) nukleinske kiseline koja sadrži ili kodira za kodirajući region, pri čemu kodirajući region kodira najmanje jedan peptid ili protein, koji sadrži tumorski antigen NY-ESO-1 ili njegov fragment;

B) nukleinske kiseline koja sadrži ili kodira za kodirajući region, pri čemu kodirajući region kodira najmanje jedan peptid ili protein, koji sadrži tumorski antigen 5T4 ili njegov fragment;

C) nukleinske kiseline koja sadrži ili kodira za kodirajući region, pri čemu kodirajući region kodira najmanje jedan peptid ili protein, koji sadrži tumorski antigen survivin ili njegov fragment;

D) nukleinske kiseline koja sadrži ili kodira za kodirajući region, pri čemu kodirajući region kodira najmanje jedan peptid ili protein, koji sadrži tumorski antigen MAGE-C1 ili njegov fragment; i

E) nukleinske kiseline koja sadrži ili kodira za kodirajući region, pri čemu kodirajući region kodira najmanje jedan peptid ili protein, koji sadrži tumorski antigen MAGE-C2 ili njegov fragment.

pri čemu fragment NY-ESO-1, 5T4, survivin, MAGE-C1 ili MAGE-C2 ima dužinu od najmanje šest aminokiselinskih ostataka;

pri čemu svaka nukleinska kiselina A, B, C, D ili E - u pravcu 5' do 3' sadrži ili kodira za

i) a) kodirajući region,

b) najmanje jednu histonsku matičnu petlju, i

c) poli(A) sekvencu;

ili

ii) a) kodirajući region,

b) poli(A) sekvencu, i

c) najmanje jednu histonsku matičnu petlju;

gde je najmanje jedna histonska matična petlja u i) ili ii) izabrana iz sledećih formula (I) ili (II):

formula (I) (sekvenca matične petlje bez elemenata matične petlje):

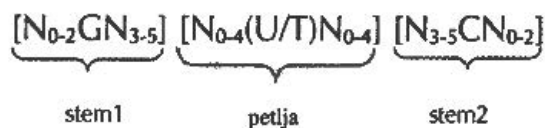

formula (II) (sekvenca matične petlje sa elementima matične petlje):

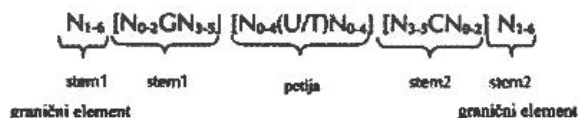

gde:

stem 1 ili stem 2 granični elementi N_{1-6} je uzastopna sekvenca od 1 do 6, poželjno od 2 do 6, poželjnije od 2 do 5, čak poželjnije od 3 do 5, najpoželjnije od 4 do 5 ili 5 N, pri čemu je svako N nezavisno od drugog izabrano iz nukleotida odabranog iz A, U, T, G i C ili njihovog nukleotidnog analoga;

stem1 $[N_{0-2}GN_{3-5}]$ je reverzno komplementaran ili delimično reverzno komplementaran sa elementom stem2, i predstavlja uzastopnu sekvencu 5 do 7 nukleotida;

gde je N_{0-2} uzastopna sekvenca od 0 do 2, poželjno od 0 do 1, poželjnije od 1 N, pri čemu je svako N nezavisno od drugog izabrano iz nukleotida odabranog iz A, U, T, G i C ili njihovog nukleotidnog analoga;

gde je N_{3-5} uzastopna sekvenca od 3 do 5, poželjno od 4 do 5, poželjnije od 4 N, pri čemu je svako N nezavisno od drugog izabrano iz nukleotida odabranog iz A, U, T, G i C ili njihovog nukleotidnog analoga; i

gde G je guanozin ili njegov analog, i može se po izboru zameniti citidinom ili njegovim analogom, pod uslovom da je njegov komplementarni nukleotid citidin u stem2 zamenjen guanozinom;

sekvenca petlje $[N_{0-4}(U/T)N_{0-4}]$ se nalazi između elemenata stem1 i stem2, i predstavlja uzastopnu sekvencu od 3 do 5 nukleotida, poželjnije od 4 nukleotida;

gde je N_{0-4} nezavisna od druge uzastopne sekvence od 0 do 4, poželjno od 1 do 3, poželjnije od 1 do 2 N, pri čemu je svako N nezavisno od drugog izabrano iz nukleotida odabranog iz A, U, T, G i C ili njihovog nukleotidnog analoga; i

gde U/T predstavlja uridin, ili opciono timidin;

stem2 $[N_{3-5}CN_{0-2}]$ je reverzno komplementaran ili delimično reverzno komplementaran sa elementom stem1, i predstavlja uzastopnu sekvencu 5 do 7 nukleotida;

gde je N_{3-5} uzastopna sekvenca od 3 do 5, poželjno od 4 do 5, poželjnije od 4 N, pri čemu je svako N nezavisno od drugog izabrano iz nukleotida odabranog iz A, U, T, G i C ili njihovog nukleotidnog analoga;

gde je N_{0-2} uzastopna sekvenca od 0 do 2, poželjno od 0 do 1, poželjnije od 1 N, pri čemu je svako N nezavisno od drugog izabrano iz nukleotida odabranog iz A, U, T, G i C ili njihovog nukleotidnog analoga; i

gde C je citidin ili njegov analog, i može se po izboru zameniti guanozinom ili njegovim analogom, pod uslovom da je njegov komplementarni nukleotid guanozin u stem1 zamenjen citidinom;

gde

stem1 i stem2 su sposobni za uparivanje baza

formiranje reverzne komplementarne sekvence, pri čemu se uparivanje baza može desiti između stem1 i stem2, ili

formiranje delimično reverzne komplementarne sekvence, pri čemu se uparivanje nekompletnih baza može desiti između stem1 i stem2; i

gde se najmanje jedna histonska matična petlja vezuje za vezni protein matične petlje (SLBP); i

pri čemu svaka nukleinska kiselina A, B, C, D ili E dalje sadrži ili kodira poli(C) sekvencu koja sadrži najmanje 10 nukleotida citidina.

Patent sadrži još 20 patentnih zahtjeva

(11) **03410** (13) **B**

(51) **C07D 495/04**^(2006.01)

A61K 31/5377^(2006.01)

A61P 35/00^(2006.01)

A61P 35/04^(2006.01)

C07D 519/00^(2006.01)

A61K 31/519^(2006.01)

A61K 31/541^(2006.01)

A61P 35/02^(2006.01)

A61P 43/00^(2006.01)

(21) P-2019-152

(22) 16.02.2011

(30) 2010131950 09.06.2010 JP

2010031899 17.02.2010 JP

(96) 11744685.6/16.02.2011

(86) JP PCT/JP2011/053303/16.02.2011

(87) WO 2011/102399/25.08.2011/2011/34

(97) EP 2540728/02.01.2013/2013/01

EP 2540728/10.04.2019/2019/15

(54) me **HETEROCIKLIČNA JEDINJENJA**

en **HETEROCYCLIC COMPOUND**

(73) Takeda Pharmaceutical Company Limited

1-1 Doshomachi 4-chome Chuo-ku, Osaka-shi, Osaka 541-0045/ JP

(72) HOMMA, Misaki

c/o Takeda Pharmaceutical Company Limited 26-1 Muraoka-Higashi 2-chrome, Fujisawa; Kanagawa 251-0012/ JP

MIYAZAKI, Toru

c/o Takeda Pharmaceutical Company Limited 26-1 Muraoka-Higashi 2-chrome, Fujisawa; Kanagawa 251-0012/ JP

OGURO, Yuya

c/o Takeda Pharmaceutical Company Limited 26-1 Muraoka-Higashi 2-chrome, Fujisawa; Kanagawa 251-0012/ JP

KURASAWA, Osamu

c/o Takeda Pharmaceutical Company Limited 26-1 Muraoka-Higashi 2-chrome, Fujisawa; Kanagawa 251-0012/ JP

Jedinjenje predstavljeno formulom:

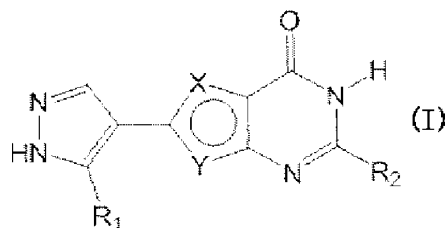

gde

X je atom sumpora;

Y je CH,

R₁ je C₁₋₆ alkil grupa opciono supstituisana sa atomom (atomima) halogena,

R₂ je,

(1) C_{1-6} alkil grupa opciono supstituisana sa 1 do 3 supstituenta izabrana od

(a) 4-7 člane monociklične alifatične heterociklične grupe koja sadrži, kao sastavni atom prstena pored atoma ugljenika, 1 do 4 hetero atoma izabrana od atoma kiseonika, atoma sumpora i atoma azota opciono supstituisanih sa 1 do 3 supstituenta izabrana od

(i) atoma halogena,

(ii) hidroksi grupe,

(iii) C_{1-6} alkil grupe opciono supstituisane sa 1 do 3 supstituenta izabrana od

(aa) atoma halogena,

(bb) hidroksi grupe,

(cc) C_{1-6} alkoksi grupe i

(dd) C_{6-14} aril grupe opciono supstituisane sa 1 do 3 C_{1-6} alkil grupe,

(iv) C_{1-6} alkoksi grupe,

(v) C_{6-14} aril grupe opciono supstituisane sa 1 do 3 atoma halogena,

(vi) C_{6-14} ariloksi grupe,

(vii) C_{1-6} alkoksi-karbonil grupe,

(viii) C_{1-6} alkil-karbonil grupe,

(ix) cijano grupe,

(x) C_{6-14} arilsulfonil grupe,

(xi) karboksi grupe,

(xii) amino grupe opciono mono-ili di-supstituisane sa C_{1-6} alkil grupom(ama),

(xiii) 4-7 člane monociklične alifatične heterociklične grupe koja sadrži, kao sastavni atom prstena pored atoma ugljenika, 1 do 4 hetero atoma izabrana od atoma kiseonika, atoma sumpora i atoma azota opciono supstituisanih sa okso grupom i

(xiv) okso grupe,

(b) C₁₋₆ alkoksi grupe,

(c) amino grupe opciono mono-ili di-supstutuisane sa supstutientom(ima) izabranim od

(i) C₁₋₆ alkil grupe opciono supstutuisane sa 1 do 3 supstutienta izabrana od

(aa) C₆₋₁₄ aril grupe opciono supstutuisane sa 1 do 3 C₁₋₆ alkoksi grupe,

(bb) C₁₋₆ alkoksi-karbonil grupe,

(cc) 4-7 člane monociklične aromatične heterociklične grupe koja sadrži, kao sastavni atom prstena pored atoma ugljenika, 1 do 4 hetero atoma izabrana od atoma kiseonika, atoma sumpora i atoma azota,

(dd) C₃₋₈ cikloalkil grupe opciono supstutuisane sa 4-7 članom monocikličnom aromatičnom heterocikličnom grupom koja sadrži, kao sastavne atome prstena pored atoma ugljenika, 1 do 4 hetero atoma izabrana od atoma kiseonika, atoma sumpora i atoma azota i

(ee) hidroksi grupe,

(ii) 4-7 člane monociklične alifatične heterociklične grupe koja sadrži, kao sastavni atom prstena pored atoma ugljenika, 1 do 4 hetero atoma izabrana od atoma kiseonika, atoma sumpora i atoma azota opciono supstutuisanih sa 1 do 3 C₇₋₁₃ aralkil grupe,

(iii) C₆₋₁₄ aril grupe opciono supstutuisane sa 1 do 3 C₁₋₆ alkoksi grupe i

(iv) C₃₋₈ cikloalkil grupe,

(d) 5-ili 6-člane aromatične heterociklične grupe,

(e) C₆₋₁₄ aril grupe i

(f) C₃₋₈ cikloalkil grupe opciono supstutuisane sa amino grupom;

(2) C₆₋₁₄ aril grupa opciono supstutuisana sa 1 do 3 atoma halogena;

(3) 4-7 člana monociklična alifatična heterociklična grupa koja sadrži, kao sastavni atom prstena pored atoma ugljenika, 1 do 4 hetero atoma izabrana od atoma kiseonika, atoma sumpora i atoma azota, premoštena alifatična heterociklična grupa ili spirociklična alifatična heterociklična grupa,

pri čemu je alifatična heterociklična grupa opciono supstituisana sa 1 do 3 supstituenta izabrana od

(a) atoma halogena,

(b) C₁₋₆ alkil grupe opciono supstituisane sa 1 do 3 supstituenta izabrana od

(i) hidroksi grupe,

(ii) C₁₋₆ alkoksi-karbonil grupe i

(iii) karbamoil grupe,

(c) C₆₋₁₄ ariloksi grupe,

(d) C₁₋₆ alkoksi-karbonil grupe,

(e) C₁₋₆ alkil-karbonil grupe,

(f) C₆₋₁₄ aril grupe opciono supstituisane sa C₁₋₆ alkilsulfonil grupom,

(g) C₇₋₁₃ aralkil grupe opciono supstituisane sa 1 do 3 atoma halogena,

(h) hidroksi grupe,

(i) karbamoil grupe i

(j) 4-7 člane monociklične alifatične heterociklične grupe koja sadrži, kao sastavni atom prstena pored atoma ugljenika, 1 do 4 hetero atoma izabrana od atoma kiseonika, atoma sumpora i atoma azota;

(4) C₂₋₆ alkenil grupa opciono supstituisana sa 1 do 3 C₆₋₁₄ aril grupe;

(5) 5-ili 6-člana aromatična heterociklična grupa;

(6) alifatična heterociklil-karbonil grupa izabrana od pirolidinilkarbonil grupe, ili

(7) C₃₋₈ cikloalkil grupa opciono supstituisana sa amino grupom

ili njegova so.

Patent sadrži još 18 patentnih zahtjeva

(11) **03388** (13) **B**

(51) **C07C 303/32**^(2006.01)

C07C 233/18^(2006.01)

(21) P-2019-153

(22) 30.07.2014

(30) WO2013CN80472 31.07.2013 WO
20130060121 17.10.2013 FR

(96) 14749937.0/30.07.2014

(86) US PCT/FR2014/051972/30.07.2014

(87) WO 2015/015118/05.02.2015/2015/05

(97) EP 3036218/29.06.2016/2016/26

EP 3036218/10.04.2019/2019/15

(54) me **KO-KRISTALI AGOMELTINA I P-TOLUENSULFONSKE KISELINEI, NAČIN PRIPREME I I FARMACEUTSKI PRIPRAVCI KOJI SADRŽAVAJU ISTE**
en **CO-CRYSTALS OF AGOMELATINE AND P-TOLUENESULPHONIC ACID1 ?????D FOR PREPARING SAME AND ??? PHARMACEU?ICAL COMPOSI?IONS CONTAINING SAME**

(73) Les Laboratoires Servier

35, Rue de Verdun, 92284 Suresnes/ FR

Shanghai Institute Of Pharmaceutical Industry

No.1320 West Beijing Road, Jing'an District/ CN

(72) SHAN, Hanbin

24 Dongfangxincun, Gaoan Jiangsu 330800 Jiangxi Province/ CN

SHEN, Yuhui

Room 603, N° 30, Lane 358, Sanmen Road,, Shanghai 200439/ CN

LUO, Ying

Room 803, Unit 4, J1 Building XianShi Garden,, Nanchang City Jiangxi Province, Jiangxi 300006/ CN

LETELLIER, Philippe

25 Rue du Faubourg Saint Jean, F-45000 Orléans/ FR

LYNCH, Michael

74 Rue des Chaises, F-45140 Saint Jean de la Ruelle/ FR

(57)

1. Kristalni oblici ko-kristala agomelatina i p-toluensulfonske kiseline, **naznačeni time**, da imaju formulu (I):

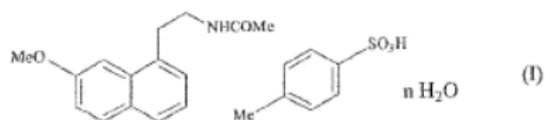

pri čemu n predstavlja 0 ili 1.

Patent sadrži još 11 patentnih zahtjeva

(11) **03411** (13) **B**

(51) **A61M5/315**^(2006.01)

(21) P-2019-154

(22) 25.03.2005

(30) 20040557545P 30.03.2004 US

20040638027P 21.12.2004 US

(96) 05736314.5/25.03.2005

(86) US PCT/US2005/010206/25.03.2005

(87) WO 2005/097233 A2/20.10.2005/2005/42

(97) EP 1732629/20.12.2006/2006/51

EP 1732629/24.04.2019/2019/17

(54) me **NAPRAVA ZA IZDAVANJE LIJEKA SA BLOKIRAJUĆOM KARAKTERISTIKOM
POGONJENOM OPRUGOM AKTIVIRANOM DAVANJEM POSLJEDNJE DOZE**
en **MEDICATION DISPENSING APPARATUS WITH SPRING-DRIVEN LOCKING FEATURE
ENABLED BY ADMINISTRATION OF FINAL DOSE**

(73) Eli Lilly and Company

Lilly Corporate Center, Indianapolis, IN 46285/ US

(72) JACOBS, Alexander, Thomas

764 Cambridge Street 7, Cambridge, MA 02141/ US

JUDSON, Jared, Alden

114 South Main Street, Topsfield, MA 01983/ US

ROW, Gordon, Davidson

47 Town Forest Road, Groton, MA 01450/ US

(57)

1. Naprava (20, 220) za izdavanje lijekova koja sadrži:

kućište (35);

pogonski element (60, 280) unutar pomenutog kućišta i koji je pomerljiv u distalnom smeru;
kontejner (28) za fluid koji definiše rezervoar (30) napunjen lekom sa pokretnim klipom (32) na jednom kraju i izlazom na drugom kraju, pri čemu se pomenuti klip može spregnuti sa pomenutim pogonskim elementom da bi bio pomeren prema pomenutom izlazu duž rastojanja jednakog distalnom pomeranju pomenutog pogonskog elementa kada se pomenuti pogonski element pomera distalno; plunžerski element (90, 260);
prenosnik (52, 270) koji sadrži prvi i drugi zupčanik (160, 166);

prvu zupčastu letvu (84) uzubljenju sa pomenutim prvim zupčanikom i aksijalno nepokretnu unutar pomenutog kućišta;

drugu zupčastu letvu (80) uzubljenju sa pomenutim drugim zupčanikom i pomerljivu unutar pomenutog kućišta na delu (62) za zahvatanje zupčanika spojenog sa pomenutim pogonskim elementom kao spojnica;

naznačena time što:

pomenuti prenosnik se može okretati na pomenutom plunžerskom elementu i može se pomerati proksimalno i distalno sa pomenutim plunžerskim elementom da bi pretvorio kretanje plunžerskog elementa u kretanje pogonskog elementa; i

pomenuta naprava dalje sadrži zaprečni element (180, 225) koji sadrži zaprečni rub (186, 240) i klizač (190, 236);

pomenuti pogonski element sadrži aksijalnu površinu (71, 71') za zahvatanje klizača duž koje može klizati pomenuti klizač dok pomenuti pogonski element prolazi distalno u toku pomeranja tokom tokom kretanja plunžerskog elementa u distalnom smeru, pri čemu pomenuta površina za zahvatanje klizača ima aksijalnu dužinu i bliži kraj, pomenuti pogonski element duž pomenute aksijalne dužine je strukturisan i postavljen/raspoređan sa pomenutim

klizačem tako da zadržava pomenuti zaprečni rub nasuprot opružne sile u prvom položaju slobodnom od elementa (117, 266) koji se može zaprečiti postavljenog na pomenutom plunžerskom elementu u toku pripreme doze i injektiranja pre administracije poslednje doze; i

pri čemu se pomenuta površina za zahvatanje klizača pomera distalno od pomenutog klizača tako da pomenuti klizač prolazi preko bližeg kraja posle administracije poslednje doze omogućavajući da pomenuti zaprečni rub bude potisnut pomoću pomenute opružne sile iz pomenutog prvog položaja u drugi položaj radi zahvatanja sa pomenutim elementom koji se može zaprečiti da bi fizički blokirali pomenuti plunžerski element radi sprečavanja dalje pripreme i injektiranja doze.

Patent sadrži još 9 patentnih zahtjeva

(11) **03389** (13) **B**

(51) **A61K 31/422**^(2006.01)

A61K 9/56^(2006.01)

A61P 33/00^(2006.01)

A61K 9/68^(2006.01)

(21) P-2019-156

(22) 31.01.2013

(30) 201261595463 P 06.02.2012 US

(96) 17152504.1/31.01.2013

(97) EP 3216448/13.09.2017/2017/37

EP 3216448/27.03.2019/2019/13

(54) me **PARAZITICIDNE ORALNE VETERINARSKJE KOMPOZICIJE KOJE SADRŽE SISTEMSKI-DELUJUĆA AKTIVNA SREDSTVA, METODI I PRIMENE ISTIH**
en **PARASITICIDAL ORAL VETERINARY COMPOSITIONS COMPRISING SYSTEMICALLY-ACTING ACTIVE AGENTS, METHODS AND USES THEREOF**

(73) Boehringer Ingelheim Animal Health USA Inc.

3239 Satellite Boulevard, Bldg. 500 Duluth,, GA 30096/ US

(72) SOLL, Mark D.

605 Newport Shore, Alpharetta, GA Georgia 30005/ US

LARSEN, Diane

2422 Waybridge Court, Buford, GA Georgia 30519/ US

CADY, Susan Mancini

1501 Revere Road, Yardley, PA Pennsylvania 19067/ US

CHEIFETZ, Peter

15 Lynnfield Drive, East Windsor, NJ New Jersey 08520/ US

GALESKA, Izabela

1725 Tristen Drive, Newtown, PA Pennsylvania 18940/ US

GONG, Saijun

5 Terrace Lane, Bridgewater, NJ New Jersey 08807/ US

(57)

1. Meka veterinarska kompozicija za žvakanje, za lečenje i/ili prevenciju parazitske infekcije ili infestacije kod životinje, **naznačena time**, što sadrži:

a) kombinaciju:

(i) najmanje jednog izoksazolinskog aktivnog sredstva Formule (I):

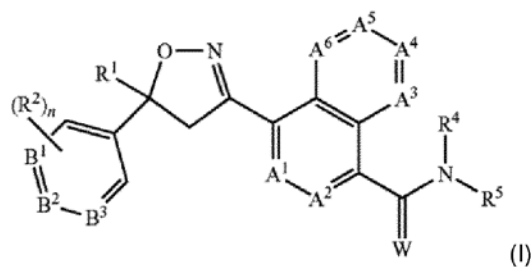

gde:

A₁, A₂, A₃, A₄, A₅ i A₆ su nezavisno odabrani iz grupe koja se sastoji od CR₃ i N, uz uslov da su najviše 3 od A₁, A₂, A₃, A₄, A₅ i A₆ are N;

B₁, B₂ i B₃ su nezavisno odabrani iz grupe koja se sastoji od CR₂ i N;

W je O ili S;

R₁ je C₁-C₆ alkil, C₂-C₆ alkenil, C₂-C₆ alkinil, C₃-C₆ cikloalkil, C₄-C₇ alkilcikloalkil ili C₄-C₇ cikloalkilalkil, svaki opciono supstituisan jednim ili većim brojem supstituenata nezavisno odabranih između R₆;

svaki R₂ je nezavisno H, halogen, C₁-C₆ alkil, C₁-C₆ haloalkil, C₁-C₆ alkoksi, C₁-C₆ haloalkoksi, C₁-C₆ alkiltio, C₁-C₆ haloalkiltio, C₁-C₆ alkilsulfinil, C₁-C₆ haloalkilsulfinil, C₁-C₆ alkilsulfonyl, C₁-C₆ haloalkilsulfonyl, C₁-C₆ alkilamino, C₂-C₆ dialkilamino, C₂-C₄ alkoksikarbonil, -CN ili -NO₂;

svaki R₃ je nezavisno H, halogen, C₁-C₆ alkil, C₁-C₆ haloalkil, C₃-C₆ cikloalkil, C₃-C₆ halocikloalkil, C₁-C₆ alkoksi, C₁-C₆ haloalkoksi, C₁-C₆ alkiltio, C₁-C₆ haloalkiltio, C₁-C₆ alkilsulfinil, C₁-C₆ haloalkilsulfinil, C₁-C₆ alkilsulfonyl, C₁-C₆ haloalkilsulfonyl, C₁-C₆ alkilamino, C₂-C₆ dialkilamino, -CN ili -NO₂;

R₄ je H, C₁-C₆ alkil, C₂-C₆ alkenil, C₂-C₆ alkinil, C₃-C₆ cikloalkil, C₄-C₇ alkilcikloalkil, C₄-C₇ cikloalkilalkil, C₂-C₇ alkilkarbonil ili C₂-C₇ alkoksikarbonil;

R₅ je H, OR₁₀, NR₁₁R₁₂ ili Q₁; ili C₁-C₆ alkil, C₂-C₆ alkenil, C₂-C₆ alkinil, C₃-C₆ cikloalkil, C₄-C₇ alkilcikloalkil ili C₄-C₇ cikloalkilalkil, svaki opciono supstituisan jednim ili većim brojem supstituenata nezavisno odabranih između R₇; ili

R₄ i R₅ zajedno sa azotom za koji su prikačeni formiraju prsten koji sadrži 2 do 6 atoma ugljenika i opciono jedan dodatni atom nezavisno odabran iz grupe koja se sastoji od C₁-C₂ alkila, halogena, -CN, -NO₂ i C₁-C₂ alkoksi;

svaki R₆ je nezavisno halogen, C₁-C₆ alkil, C₁-C₆ alkoksi, C₁-C₆ alkiltio, C₁-C₆ alkilsulfinil, C₁-C₆ alkilsulfonyl, -CN ili -NO₂;

svaki R₇ je nezavisno halogen; C₁-C₆ alkil, C₃-C₆ cikloalkil, C₁-C₆ alkoksi, C₁-C₆ alkiltio, C₁-C₆ alkilsulfinil, C₁-C₆ alkilsulfonyl, C₁-C₆ alkilamino, C₂-C₈ dialkilamino, C₃-C₆ cikloalkilamino, C₂-C₇ alkilkarbonil, C₂-C₇ alkoksikarbonil, C₂-C₇ alkilaminokarbonil, C₃-C₉ dialkilaminokarbonil, C₂-C₇ haloalkilkarbonil, C₂-C₇ haloalkoksikarbonil, C₂-C₇ haloalkilaminokarbonil, C₃-C₉ dihaloalkilaminokarbonil, hidroksi, -NH₂, -CN ili -NO₂; ili Q₂;

svaki R₈ je nezavisno halogen, C₁-C₆ alkoksi, C₁-C₆ haloalkoksi, C₁-C₆ alkiltio, C₁-C₆ haloalkiltio, C₁-C₆ alkilsulfinil, C₁-C₆ haloalkilsulfinil, C₁-C₆ alkilsulfonyl, C₁-C₆ haloalkilsulfonyl, C₁-C₆ alkilamino, C₂-C₆ dialkilamino, C₂-C₄ alkoksikarbonil, -CN ili -NO₂;

svaki R₉ je nezavisno halogen, C₁-C₆ alkil, C₁-C₆ haloalkil, C₃-C₆ cikloalkil, C₃-C₆ halocikloalkil, C₁-C₆ alkoksi, C₁-C₆ haloalkoksi, C₁-C₆ alkiltio, C₁-C₆ haloalkiltio, C₁-C₆ alkilsulfinil, C₁-C₆ haloalkilsulfinil, C₁-C₆ alkilsulfonyl, C₁-C₆ haloalkilsulfonyl, C₁-C₆ alkilamino, C₂-C₈ dialkilamino, -CN, -NO₂, fenil ili piridinil;

R₁₀ je H; ili C₁-C₆ alkil, C₂-C₆ alkenil, C₂-C₆ alkinil, C₃-C₆ cikloalkil, C₄-C₇ alkilcikloalkil ili C₄-C₇ cikloalkilalkil, svaki opciono supstituisan jednim ili većim brojem halogena;

R₁₁ je H, C₁-C₆ alkil, C₂-C₆ alkenil, C₂-C₆ alkinil, C₃-C₆ cikloalkil, C₄-C₇ alkilcikloalkil, C₄-C₇ cikloalkilalkil, C₂-C₇ alkilkarbonil ili C₂-C₇ alkoksikarbonil;

R₁₂ je H; Q₃; ili C₁-C₆ alkil, C₂-C₆ alkenil, C₂-C₆ alkinil, C₃-C₆ cikloalkil, C₄-C₇ alkilcikloalkil ili C₄-C₇ cikloalkilalkil, svaki opciono supstituisan jednim ili većim brojem supstituenata nezavisno odabranih između R₇; ili

R₁₁ i R₁₂ zajedno sa azotom za koji su prikačeni formiraju prsten koji sadrži 2 do 6 atoma ugljenika i opciono jedan dodatni atom odabran iz grupe koja se sastoji od N, S i O, pomenuti prsten je opciono supstituisan sa 1 do 4 supstituenta nezavisno odabrana iz grupe koja se sastoji od C₁-C₂ alkil, halogen, -CN, -NO₂ i C₁-C₂ alkoksi;

Q₁ je fenil prsten, 5- ili 6-člani heterociklični prsten, ili 8-, 9- ili 10-člani fuzionisani biciklični prstenasti sistem koji opciono sadrži jedan do tri heteroatoma odabrana između najviše 1 O, najviše 1 S i najviše 3 N, svaki prsten ili prstenasti sistem opciono je supstituisan jednim ili većim brojem supstituenata nezavisno odabranih između R₈;

svaki Q₂ je nezavisno fenil prsten ili 5- ili 6-člani heterociklični prsten, svaki prsten je opciono supstituisan jednim ili većim brojem supstituenata nezavisno odabranih između R₉;

Q₃ je fenil prsten ili 5- ili 6-člani heterociklični prsten, svaki prsten je opciono supstituisan jednim ili većim brojem supstituenata nezavisno odabranih između R₉; i

n je 0, 1 ili 2; i

(ii) najmanje jednog sistemski-delujućeg aktivnog sredstva, pri čemu je sistemski aktivno sredstvo jedan ili više makrocikličnih laktona, jedno ili više spinosin jedinjenja, jedno ili više spinosoid jedinjenja, jedan ili više benzimidazola, levamisol, pirantel, morantel, prazikvantel, klosantel, klorsulon, jedno ili više amino acetonitril aktivnih sredstava, jedan ili više regulatora rasta insekata, jedan ili više neonikotinoidea ili jedan ili više ariloazol-2-il cijanoetilamino aktivnih sredstava, jedan ili više arilpirazola, jedan ili više depsipectida, ili njihova kombinacija;

i

b) farmaceutski prihvatljivi nosač, pri čemu farmaceutski prihvatljivi nosač uključuje jedan ili više surfaktanata, gde se surfaktanti biraju između polietilen glikol stearata i polietilen glikol hidroksil stearata.

Patent sadrži još 34 patentnih zahtjeva

(11) **03390** (13) **B**

(51) **C12N 15/113**^(2010.01)

A61K 31/7088^(2006.01)

A61P 31/20^(2006.01)

A61K 31/713^(2006.01)

(21) P-2019-157

(22) 01.05.2014

(30) 201361818442 P 01.05.2013 US

201361823826 P 15.05.2013 US

201361843887 P 08.07.2013 US

201361871673 P 29.08.2013 US

201361880790 P 20.09.2013 US

201461976991 P 08.04.2014 US

201461986867 P 30.04.2014 US

(96) 14791344.6/01.05.2014

(86) US PCT/US2014/036463/01.05.2014

(87) WO 2014/179627/06.11.2014/2014/45

(97) EP 2992098/09.03.2016/2016/10

EP 2992098/27.03.2019/2019/13

(54) me **KOMPOZICIJE I POSTUPCI ZA MODULISANJE EKSPRESIJE HBV I TTR**
en **COMPOSITIONS AND METHODS FOR MODULATING HBV AND TTR EXPRESSION**

(73) Ionis Pharmaceuticals, Inc.

2855 Gazelle Court, Carlsbad, CA 92010/ US

(72) PRAKASH, Thazha P.

2855 Gazelle Court, Carlsbad, CA 92010/ US
SETH, Punit P.

2855 Gazelle Court, Carlsbad, CA 92010/ US
SWAYZE, Eric E.

2855 Gazelle Court, Carlsbad, CA 92010/ US

(57)

1. Jedinjenje koje sadrži modifikovani oligonukleotid i konjugatnu grupu, pri čemu se modifikovani oligonukleotid sastoji od 12 do 30 povezanih nukleozida i ima sekvencu nukleobaza najmanje 85% komplementarnu SEQ ID NO: 1 koja kodira virus hepatitisa B (HBV) i pri čemu konjugatna grupa sadrži:

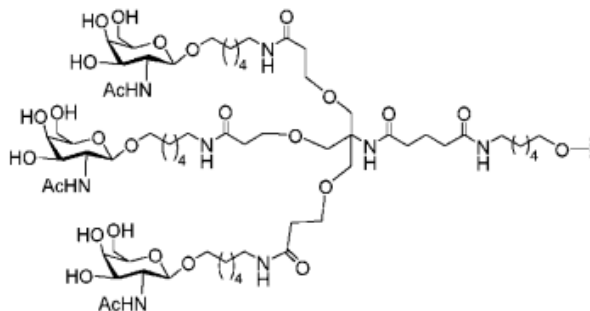

Patent sadrži još 13 patentnih zahtjeva

(11) **03391** (13) **B**

(51) **C07D 487/04**^(2006.01)

A61K 31/661^(2006.01)

A61P 35/00^(2006.01)

C07F 9/09^(2006.01)

A61K 31/53^(2006.01)

A61P 11/00^(2006.01)

A61P 43/00^(2006.01)

(21) P-2019-158

(22) 22.12.2014

(30) 2013267687 25.12.2013 JP

(96) 14873998.0/22.12.2014

(86) JP PCT/JP2014/083932/22.12.2014

(87) WO 2015/098853/02.07.2015/2015/26

(97) EP 3088401/02.11.2016/2016/44

EP 3088401/06.03.2019/2019/10

(54) me **EDINJENJ E (6S, 9AS)-N-BE NZI L-6-((4-HI DROKSIFENIL) M ETIL)-4, 7-DIOKS0-8-((6-(3-(PIPERAZIN-1- IL)AZETIDIN-1-IL) PIRIDIN-2-IL) M ETIL)-2-(PROP-2-E N- 1-I L)-OKT AHIDRO- 1 H-PIRAZINO(2, 1-C)(1,2,4)TRIAZIN-1-KARBOKSAMIDA**
en **(6S,9aS)-N-BENZYL-6-[(4-HYDROXYPHENYL)METHYL]-4,7-DIOXO-8-({6-[3-(PIPERAZINE-1-YL)AZETIDINE-1-YL]PYRIDINE-2-YL}METHYL)-2-(PROP-2-EN-1-YL)-OCTAHYDRO-1H-PYRAZINO[2,1-c][1,2,4]TRIAZINE-1-CARBOXAMIDE COMPOUND**

(73) Eisai R&D Management Co., Ltd.

4-6-10 Koishikawa Bunkyo-ku, Tokyo , 112-8088/ JP

PRISM Pharma Co., Ltd.

4259-3, Nagatsuta-cho Midori-ku Yokohama-shi, Kanagawa 226-8510/ JP

(72) , INOUE Satoshi

c/o Eisai Co. Ltd. Tsukuba Research Laboratories 5-1-3 Tokodai, Tsukuba-shi Ibaraki 300-2635/ JP , YAMAMOTO Yuji

c/o Eisai Co. Ltd. Tsukuba Research Laboratories 5-1-3 Tokodai, Tsukuba-shi Ibaraki 300-2635/ JP , ISO Kentaro

c/o Eisai Co. Ltd. Tsukuba Research Laboratories 5-1-3 Tokodai, Tsukuba-shi Ibaraki 300-2635/ JP

(57)

1. Jedinjenje prikazano sa:

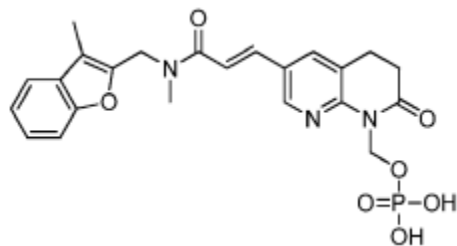

i njegove farmaceutski prihvatljive soli.

Patent sadrži još 18 patentnih zahtjeva

(11) **03406** (13) **B**

(51) **E04B 2/74**^(2006.01)

H02G 3/38^(2006.01)

E04H 3/02^(2006.01)

H01R 25/16^(2006.01)

G07F 17/32^(2006.01)

(21) P-2019-16

(22) 13.03.2015

(30) 102014103646 17.03.2014 DE

(96) 15710164.3/13.03.2015

(86) EP PCT/EP2015/055308/13.03.2015

(87) WO 2015/140067/24.09.2015/2015/38

(97) EP 3119955/25.01.2017/2017/04

EP 3119955/14.11.2018/2018/46

(54) me **ELEMENT PREGRADNOG ZIDA I PREGRADNI ZID**
en **PARTITION WALL ELEMENT AND PARTITION WALL**

(73) Novomatic AG

Wiener Strasse 158, Gumpoldskirchen , 2352 / AT

(72) ECKES, Annika

c/o IP&Legal Department Novomatic AG Wiener Strasse 158, A-2352 Gumpoldskirchen/ AT

(57)

1. Element pregradnog zida koji sadrži stojeću osnovu (3) u obliku ploče i element (4) zida koji se pruža pod pravim uglom u odnosu na njega, pri čemu element (4) zida može da se pričvrsti na stojeću osnovu (3) preklopnim spojem i/ili spojem obezbeđenim oblikom tako da element (4) zida stoji svojom krajnjom stranom na stojećoj osnovi (3), naznačen time što se pravi provodnici (21) struje za bar jedno električno kolo i/ili linije (22) za podatke magistrale za podatke pružaju kao slobodno ležeće kontaktne putanje i/ili kao pojedinačni električni provodnici/žice kabla duž cele dužine stojeće osnove (3), i pri čemu se najmanje jedan električni provodnik i/ili najmanje jedna magistrala za podatke na stojećoj osnovi (3) na odgovarajući način mogu povezati preko kontakta ili probojnog kontakta u bilo kojoj tački sa najmanje jednim električnim

provodnikom i/ili sa najmanje jednom magistralom za podatke elementa (4) zida, pri čemu element (4) zida ima žljeb (24) koji je pridružen stojećoj osnovi (3) i u kome je postavljen najmanje jedan električni kontaktni element koji povezuje električno kolo i/ili magistralu za podatke stojeće osnove (3) sa električnim kolom i/ili magistralom za podatke elementa (4) zida, pri čemu se element (4) zida sa pridruženim utičnim elementima ili navojnim elementima (27) može montirati na unapred određenom mestu na odgovarajućoj pridruženoj stojećoj osnovi (3), pri čemu se žljeb (24) sa krajnje strane elementa (4) zida pruža preko ispusta (23) stojeće osnove (3).

Patent sadrži još 11 patentnih zahtjeva

(11) **03413** (13) **B**

(51) **A61K 47/10**^(2006.01)

A61K 31/375^(2006.01)

A61K 33/14^(2006.01)

A61K 31/765^(2006.01)

A61K 47/26^(2006.01)

A61K 31/77^(2006.01)

A61K 9/08^(2006.01)

(21) P-2019-160

(22) 10.09.2013

(30) 201261699488 P 11.09.2012 US

201361787366 P 15.03.2013 US

(96) 13762101.7/10.09.2013

(86) EP PCT/EP2013/068738/10.09.2013

(87) WO 2014/040994/20.03.2014/2014/12

(97) EP 2895163/22.07.2015/2015/30

EP 2895163/06.03.2019/2019/10

(54) me **KOMPOZICIJE KOJE SADRŽE PEG I ASKORBAT**

en **COMPOSITIONS COMPRISING PEG AND ASCORBATE**

(73) Norgine BV

Hogehilweg 7, 1101 CA Amsterdam Zuid-Oost/ NL

(72) CLAYTON, Lucy

Norgine Limited Norgine House Widewater Place Moorfield Road, Harefield Uxbridge Middlesex UB9 6NS/ GB

COCKETT, Alasdair

Norgine Limited Norgine House Widewater Place Moorfield Road, Harefield Uxbridge Middlesex UB9 6NS/ GB

CHRISTODOULOU, Mark

Norgine Limited Norgine House Widewater Place Moorfield Road, Harefield Uxbridge Middlesex UB9 6NS/ GB

DAVIDSON, Ian

Norgine Limited Norgine House Widewater Place Moorfield Road, Harefield Uxbridge Middlesex UB9 6NS/ GB

FARRAG, Lynn

Norgine Limited Norgine House Widewater Place Moorfield Road, Harefield Uxbridge Middlesex UB9 6NS/ GB

HALPHEN, Marc

Norgine Limited Norgine House Widewater Place Moorfield Road, Harefield Uxbridge Middlesex UB9 6NS/ GB

JONES, Leighton

Norgine Limited Norgine House Widewater Place Moorfield Road, Harefield Uxbridge Middlesex UB9 6NS/ GB

PETROSSIAN, Vanik

Senopsys LLC 800 West Cummings Park Suite 1500, Woburn, Massachusetts 01801/ US

STEIN, Peter

Norgine BV Hogehilweg 7, NL-1101 CA Amsterdam Zuid-Oost/ NL

TISI, David

Senopsys LLC 800 West Cummings Park Suite 1500, Woburn, MA 01801/ US

UNGAR, Alex

Moorthwaite Cottage, Wigton Cumberland CA7 0LZ/ GB

WORTHINGTON, Jeffrey

Senopsys LLC 800 West Cummings Park Suite 1500, Woburn, Massachusetts 01801/ US

(57)

1. kompozicija za mešanje sa vodom, naznačena time što je kompozicija izborno prisutna u dva ili više delova i sadrži:

150 do 400 mmol askorbat anjona

obezbeđenog pomoću smeše od:

askorbinske kiseline i

jedne ili više soli askorbinske kiseline

pri čemu su komponente (i) i (ii) prisutne u molamom odnosu od 1:4.5 do 1:7.0; i

b) 5 do 100 g polietilen glikola.

Patent sadrži još 19 patentnih zahtjeva

(11) **03437** (13) **B**

(51) **C07K 14/55**^(2006.01)

A61K 38/20^(2006.01)

(21) P-2019-162

(22) 14.03.2014

(30) 201361784669 P 14.03.2013 US

(96) 14722463.8/14.03.2014

(86) US PCT/US2014/029111/14.03.2014

(87) WO 2014/153111/25.09.2014/2014/39

(97) EP 2970423/20.01.2016/2016/03

EP 2970423/24.04.2019/2019/17

(54) me **MUTEINI INTERLEUKINA-2 ZA EKSPANZIJU T-REGULATORNIH ČELIJA**
en **INTERLEUKIN-2 MUTEINS FOR THE EXPANSION OF T-REGULATORY CELLS**

(73) Amgen Inc.

One Amgen Center Drive, Thousand Oaks, California 91320-1799/ US

(72) GAVIN, Marc A.

11022 Palisades Avenue SW, Vashon, Washington 98070/ US

KANNAN, Gunasekaran

1056 Amberton Lane, Newbury Park, California 91320/ US

LI, Li

1301 247th Place SE, Sammamish, Washington 98075/ US

PEARSON, Joshua T.

1136 38th Avenue, Seattle, Washington 98122/ US

KAROW, Margaret

12655 Ridge Drive, Santa Rosa Valley, California 93012/ US

(57)

I. Fc-fuzioni protein koji sadrži Fc i mutein humanog interleukina-2 (IL-2) koji sadrži V91K supstituciju i aminokiselinsku sekvencu najmanje 90% identičnu sa aminokiselinskom sekvencom navedenom u SEQ ID NO:l, pri čemu navedeni IL-2 mutein stimulira T regulatorne ćelije.

Patent sadrži još 12 patentnih zahtjeva

(11) **03438** (13) **B**

(51) **C07D 417/14**^(2006.01)

A61P 13/02^(2006.01)

A61P 43/00^(2006.01)

A61K 31/497^(2006.01)

A61P 13/10^(2006.01)

(21) P-2019-163

(22) 05.06.2015

(30) 2014118046 06.06.2014 JP

(96) 15803484.3/05.06.2015

(86) JP PCT/JP2015/066321/05.06.2015

(87) WO 2015/186821/10.12.2015/2015/49

(97) EP 3153511/12.04.2017/2017/15

EP 3153511/15.05.2019/2019/20

(54) me **DERIVAT 2-ACILAMINOTIAZOLA ZA UPOTREBU U PREVENCIJI ILI LEČENJU OBOLJENJA BESIKE / URINARNOG TRAKTA**
 en **2-ACYLAMINOTHIAZOLE DERIVATIVE FOR USE IN THE PREVENTION OR TREATMENT OF BLADDER/URINARY TRACT DISEASES**

(73) Astellas Pharma Inc.

5-1, Nihonbashi-Honcho 2-chome, Chuo-ku, Tokyo 103-8411/ JP

(72) TAKAHASHI, Taisuke

5-1 Nihonbashi-Honcho 2-chome, Chuo-ku, Tokyo 103-8411/ JP

KOIKE, Takanori

5-1 Nihonbashi-Honcho 2-chome, Chuo-ku, Tokyo 103-8411/ JP

NEGORO, Kenji

5-1 Nihonbashi-Honcho 2-chome Chuo-ku, Tokyo 103-8411/ JP

TANAKA, Hiroaki

5-1 Nihonbashi-Honcho 2-chome, Chuo-ku, Tokyo 103-8411/ JP

MAEDA, Jun

5-1 Nihonbashi-Honcho 2-chome, Chuo-ku, Tokyo 103-8411/ JP

YOKOYAMA, Kazuhiro

5-1 Nihonbashi-Honcho 2-chome, Chuo-ku, Tokyo 103-8411/ JP

TAKAMATSU, Hajime

5-1 Nihonbashi-Honcho 2-chome, Chuo-ku, Tokyo 103-8411/ JP

(57)

1. Jedinjenje formule (I) ili njegova so:

[Chem. 9]

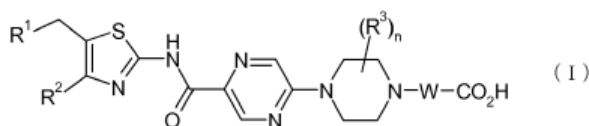

(u kojoj

R₁ je -N(-R₁₁)(-R₁₂), ili ciklična amino grupa koja se može zameniti sa 1 do 5 supstituenata izabranih iz grupe koju čine grupa G i okso,

R₁₁ je C₁₋₆ alkil,

- R_{12} je C_{1-6} alkil koji se može zameniti sa 1 do 5 supstituenata izabranih od supstituenata od (b) do (o) u grupi G, ili C_{3-8} cikloalkil koji se može zameniti sa 1 do 5 supstituenata izabranih iz grupe G,
- R_2 je aril, monociklični aromatični hetero prsten, ili biciklični aromatični hetero prsten, od kojih se svaki može zameniti sa 1 do 5 supstituenata izabranih iz grupe G,
- R_3 su isti ili različiti jedan od drugog, pri čemu je svaki C_{1-6} alkil,
- W je C_{1-6} alkilen, i
- n je ceo broj od 0 do 4), u kojem je grupa G grupa koju čine:
- (a) C_{1-6} alkil koji se može zameniti najmanje jednom grupom izabranom iz grupe koju čine -OH, -O-(C_{1-6} alkil), -CN, -SO₂-(C_{1-6} alkil), i halogen,
 - (b) -OH,
 - (c) -O-(C_{1-6} alkil koji se može zameniti najmanje jednom grupom izabranom iz grupe koju čine -OH, -O-(C_{1-6} alkil), -CN, -SO₂-(C_{1-6} alkil), i halogen),
 - (d) C_{3-8} cikloalkil,
 - (e) -O-(C_{3-8} cikloalkil),
 - (f) halogen,
 - (g) -CN,
 - (h) -SO₂-(C_{1-6} alkil),
 - (i) -CO₂-(C_{1-6} alkil) i -COOH,
 - (j) -CO-N(C_{1-6} alkil)₂, -CO-NH(C_{1-6} alkil), i -CONH₂,
 - (k) -CO-(C_{1-6} alkil),
 - (l) -SO₂-N(C_{1-6} alkil)₂, -SO₂-NH(C_{1-6} alkil), i -SO₂NH₂,
 - (m) -N(C_{1-6} alkil)₂, -NH(C_{1-6} alkil), i -NH₂,
 - (n) zasićeni hetero prsten, i
 - (o) -O-zasićeni hetero prsten.

Patent sadrži još 16 patentnih zahtjeva

(11) **03455** (13) **B**

(51) **C07D 487/04**^(2006.01)

A61K 31/519^(2006.01)

A61P 29/00^(2006.01)

C07D 519/00^(2006.01)

A61P 37/00^(2006.01)

A61P 35/00^(2006.01)

(21) P-2019-164

(22) 06.09.2013

(30) 201261699038 P 10.09.2012 US

201261728693 P 20.11.2012 US

201361782605 P 14.03.2013 US

(96) 17152898.7/06.09.2013

(97) EP 3181567/21.06.2017/2017/25

EP 3181567/20.03.2019/2019/12

(54) me **JEDINJENJA PIRAZOLOPIRIMIDINA KAO INHIBITORI KINAZE**
en **PYRAZOLOPYRIMIDINE COMPOUNDS AS KINASE INHIBITORS**

(73) Principia Biopharma Inc.

200 E. Grand Ave., S. San Francisco, CA 94080/ US

(72) Owens, Tim

800 Newport Cir., Redwood City California 94065/ US

Verner, Erik

1521 Notre Dame Avenue, Belmont, CA 94002/ US

(57)

1. Jedinjenje i/ili njegova farmaceutski prihvatljiva so, gde je jedinjenje izabrano iz grupe koju čine:

(R)-2-(3-(4-amino-3-(2-fluoro-4-fenoksifenil)-1H-pirazolo[3,4-d]pirimidin-1-il)piperidin-1-
karbonil)-4-metil-4-(4-(oksetan-3-il)piperazin-1-il)pent-2-enenitril;

(S)-2-(3-(4-amino-3-(2-fluoro-4-fenoksifenil)-1H-pirazolo[3,4-d]pirimidin-1-il)piperidin-1-
karbonil)-4-metil-4-(4-(oksetan-3-il)piperazin-1-il)pent-2-enenitril;

2-((R)-3-(4-amino-3-(2-fluoro-4-fenoksifenil)-1H-pirazolo[3,4-d]pirimidin-1-il)piperidin-1-
karbonil)-4-((R)-heksahidropirazino[2,1-c][1,4]oksazin-8(1H)-il)-4-metilpent-2-enenitril;

2-((S)-3-(4-amino-3-(2-fluoro-4-fenoksifenil)-1H-pirazolo[3,4-d]pirimidin-1-il)piperidin-1-
karbonil)-4-((R)-heksahidropirazino[2,1-c][1,4]oksazin-8(1H)-il)-4-metilpent-2-enenitril;

2-((R)-3-(4-amino-3-(2-fluoro-4-fenoksifenil)-1H-pirazolo[3,4-d]pirimidin-1-il)piperidin-1-
karbonil)-4-((S)-heksahidropirazino[2,1-c][1,4]oksazin-8(1H)-il)-4-metilpent-2-enenitril;

2-((S)-3-(4-amino-3-(2-fluoro-4-fenoksifenil)-1H-pirazolo[3,4-d]pirimidin-1-il)piperidin-1-
karbonil)-4-((S)-heksahidropirazino[2,1-c][1,4]oksazin-8(1H)-il)-4-metilpent-2-enenitril;

(R)-2-(3-(4-amino-3-(2-fluoro-4-fenoksifenil)-1H-pirazolo[3,4-d]pirimidin-1-il)piperidin-1-
karbonil)-4-(5,6-dihidroimidazo[1,2-a]pirazin-7(8H)-il)-4-metilpent-2-enenitril; i

(S)-2-(3-(4-amino-3-(2-fluoro-4-fenoksifenil)-1H-pirazolo[3,4-d]pirimidin-1-il)piperidin-1-
karbonil)-4-(5,6-dihidroimidazo[1,2-a]pirazin-7(8H)-il)-4-metilpent-2-enenitril,

ili smeša njihovih R i S izomera, ili

(E) ili (Z) izomer bilo kog gore navedenih jedinjenja.

Patent sadrži još 9 patentnih zahtjeva

(11) **03439** (13) **B**

(51) **C05C 3/00**^(2006.01)

C05C 3/08^(2006.01)

C07B 41/08^(2006.01)

C05G 1/02^(2006.01)

C07D 231/12^(2006.01)

(21) P-2019-165

(22) 12.12.2014

(30) 20131020588 13.12.2013 DE

(96) 14821540.3/12.12.2014

(86) EP PCT/EP2014/077570/12.12.2014

(87) WO 2015/086823/18.06.2015/2015/24

(97) EP 3080057/19.10.2016/2016/42

EP 3080057/20.03.2019/2019/12

(54) me **MJEŠAVINA ĐUBRIVA KOJA SADRŽI INHIBITOR NITRIFIKACIJE**
en **FERTILIZER MIXTURE CONTAINING NITRIFICATION INHIBITOR**

(73) EuroChem Agro GmbH

Reichskanzler-Müller-Str. 23, 68165 Mannheim/ DE

(72) PETERS, Nils

Wildstr. 16, 67227 Frankenthal/ DE

HÄHNDEL, Reinhardt

Schillerstr. 35, 67117 Limburgerhof/ DE

(57)

1. Mešavina đubriva, koja sadrži

A. kalcijum amonijum nitratno đubrivo, koje pored amonijum nitrata i kalcijum karbonata i/ili magnezijum karbonata i opciono vode, može sadržati do 15 tež. %, bazirano na težini kalcijum amonijum nitratnog đubriva bez vode, drugih sastojaka,

B. 100 do 10000 tež. ppm, bazirano na komponenti A bez vode, 2-(N-3,4-dimetilpirazol)ćilibarne kiseline.

Patent sadrži još 6 patentnih zahtjeva

(11) **03436** (13) **B**

(51) **B01D 53/78**^(2006.01)

B01D 53/50^(2006.01)

(21) P-2019-166

(22) 23.06.2017

(30) 201710379460 25.05.2017 CN

(96) 17177645.3/23.06.2017

(97) EP 3406321/28.11.2018/2018/48

EP 3406321/24.04.2019/2019/17

(54) me **POSTUPAK I APARATURA ZA ODSUMPORAVANJE NA BAZI AMONIJAKA PUT EM DODAVANJA AMONIJAKA U RAZLIČITE KOMORE**
en **AMMONIA-BASED DESULFURIZATION PROCESS AND APPARATUS THROUGH AMMONIA-ADDING IN DIFFERENT CHAMBERS**

(73) Jiangnan Environmental Protection Group Inc.

Harneys Fiduciary (Cayman) Limited, 4th Floor, Harbour Place, 103 South Church Street, P.O. Box 10240, Grand Cayman/ KY

(72) LOU, Jing

29 Suyuan Avenue, Jiangning District, NANJING, Jiangsu 211100/ CN
XU, Changxiang

29 Suyuan Avenue, Jiangning District, NANJING, Jiangsu 211100/ CN
XU, Xiangjun

29 Suyuan Avenue, Jiangning District, NANJING, Jiangsu 211100/ CN
LUO, Yongying

29 Suyuan Avenue, Jiangning District, NANJING, Jiangsu 211100/ CN

(57)

1. Postupak za odsumporavanje na bazi amonijaka, putem dodavanja amonijaka u različite komore, naznačen time što odeljak za oksidaciju sadrži komoru za oksidaciju i komoru za mešanje amonijaka koje su preko fluida u kontaktu jedna sa drugom, i amonijačni apsorber se dodaje u komoru za mešanje amonijaka, i

pri čemu apsorpciono-oksidativni ciklus postupka uključuje cirkulisanje tečnosti između komore za oksidaciju i sekundarnog odeljka za apsorpciju raspršivanjem, i cirkulisanje tečnosti između komore za mešanje amonijaka i primarnog odeljka za apsorpciju raspršivanjem, a između ove dve cirkulacije postoji komunikacija, najmanje komunikacija preko fluida između komore za oksidaciju

i komore za mešanje amonijaka, i

gde se primarni odeljak za apsorpciju raspršivanjem nalazi uzvodno od sekundarnog odeljka za apsorpciju raspršivanjem, u odnosu na tok struje gasa koji je potrebno obraditi.

Patent sadrži još 14 patentnih zahtjeva

(11) **03468** (13) **B**

(51) **A61K 31/4748**^(2006.01)

A61P 25/26^(2006.01)

A61K 31/485^(2006.01)

(21) P-2019-167

(22) 13.10.2010

(30) 20090266881P 04.12.2009 US

(96) 10834900.2/13.10.2010

(86) US PCT/US2010/052437/13.10.2010

(87) WO 2011/068594/09.06.2011/2011/23

(97) EP 2506712/10.10.2012/201241

EP 2506712/27.03.2019/201913

(54) me **DERIVATI MORFINANA ZA LIJEČENJE PREDOZIRANJA LIJEKOM**
en **MORPHINAN DERIVATIVES FOR THE TREATMENT OF DRUG OVERDOSE**

(73) Alkermes Pharma Ireland Limited

Connaught House, 1 Burlington Road, Dublin 4/ IE

(72) SILVERMAN, Bernard

311 Charles River Street, Needham MA 02492/ US

FEN-NI, Fu

2 Buckhill Road, Northborough MA 01532/ US

CHENGYUN, Guo

5573 Osborn Drive, Mcfarland WI 53558/ US

(57)

1. Jedinjenje koje ima formulu:

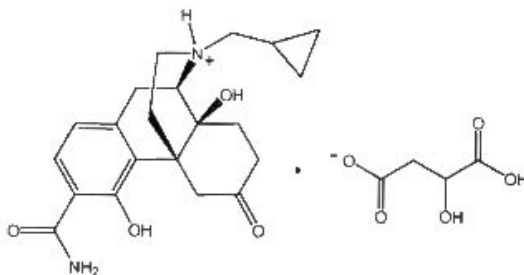

za upotrebu u postupku za lečenje toksičnosti leka ili predoziranja lekom kod subjekta kom je potrebno.

Patent sadrži još 20 patentnih zahtjeva

(11) **03469** (13) **B**

(51) **C07J 63/00**^(2006.01)

(21) P-2019-168

(22) 09.03.2012

(30) 201161452017 P 11.03.2011 US

(96) 12709768.1/09.03.2012

(86) US PCT/US2012/028569/09.03.2012

(87) WO 2012/125488/20.09.2012/2012/38

(97) EP 2683731/15.01.2014/2014/03

EP 2683731/24.04.2019/2019/17

(54) me **DERIVATI C4-MONOMETIL TRITERPENOIDA I POSTUPCI ZA NJIHOVU UPOTREBU**
en **C4-MONOMETHYL TRITERPENOID DERIVATIVES AND METHODS OF USE THEREOF**

(73) Reata Pharmaceuticals, Inc.

2801 Gateway Drive, Suite 150, Irving TX 75063-2648/ US

(72) ANDERSON, Eric

C/o 2801 Gateway Drive, Suite 150, Irving, TX 75063-2648/ US

JIANG, Xin

C/o 2801 Gateway Drive, Suite 150, Irving, TX 75063-2648/ US

VISNICK, Melean

C/o 2801 Gateway Drive, Suite 150, Irving, TX 75063-2648/ US

BENDER, Christopher F.

C/o 2801 Gateway Drive, Suite 150, Irving, TX 75063-2648/ US

LIU, Xiaofeng

C/o 2801 Gateway Drive, Suite 150, Irving, TX 75063-2648/ US

(57)

1. Jedinjenje koje ima formulu:

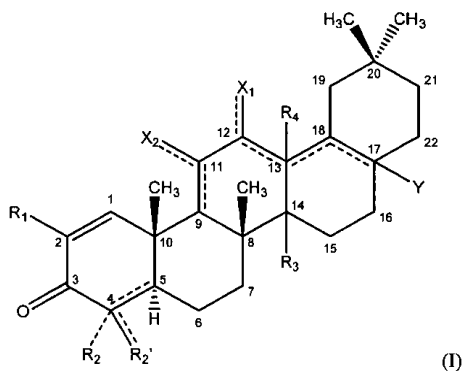

za upotrebu u postupku za lečenje toksičnosti leka ili predoziranja lekom kod subjekta kom je potrebno.

Patent sadrži još 18 patentnih zahtjeva

(11) **03454** (13) **B**

(51) **A61K 31/13**^(2006.01)

A61P 25/00^(2006.01)

(21) P-2019-169

(22) 11.08.2017

(30) 20160013829 11.08.2016 GB

20170002551 16.02.2017 GB

20170005766 10.04.2017 GB

20170006867 28.04.2017 GB

(96) 17767934.7/11.08.2017

(86) IB PCT/IB2017/054929/11.08.2017

(87) WO 2018/029658/15.02.2018/2018/07

(97) EP 3416631/26.12.2018/2018/52

EP 3416631/15.05.2019/2019/20

(54) me **TERAPEUTSKI AGENSI ZA NEURODEGENERATIVNE BOLESTI**
en **THERAPEUTIC AGENTS FOR NEURODEGENERATIVE DISEASES**

(73) INTRABIO LTD

Begbroke Science Park, Begbroke Hill, Woodstock Road, Begbroke, Oxfordshire OX5 1PF/ GB

(72) STRUPP, Michael

Campus Grosshadern Marchioninstr. 15, 81377 Munich/ DE

(57)

1. Acetil-leucin, ili njegova farmaceutski prihvatljiva so, za upotrebu u lečenju neurodegenerativne bolesti ili jednog ili visimptoma povezanih sa neurodegenerativnom bolešću kod subjekta kome je to potrebno, pri čemu je neurodegenerativna bolest odabrana od Alchajmerove bolesti, ALS, MSA-P, MSA--C, frontotemporalne demencije sa parkinsonizmom, progresivne supranuklearne paralize, kortikobazalne degeneracije, cerebralnog nistagmusa sa smerom na dole, demencije sa Levijevim telima, i ataksije telangiektazije (Louis Barr-ova bolest), i pri čemu se acetil-leucin, ili njegova farmaceutski prihvatljiva so daje se najmanje dva puta dnevno kako bi se postigla ukupna dnevna doza od oko 0,5 g do oko 15 g.

Patent sadrži još 17 patentnih zahtjeva

(11) **03453** (13) **B**

(51) **G10L 19/008**^(2013.01)

(21) P-2019-170

(22) 28.10.2015

(30) 201462073462 P 31.10.2014 US
201562167711 P 28.05.2015 US

(96) 15787573.3/28.10.2015

(86) EP PCT/EP2015/075022/28.10.2015

(87) WO 2016/066705/06.05.2016/2016/18

(97) EP 3213322/06.09.2017/2017/36
EP 3213322/03.04.2019/2019/14

(54) me **PARAMETRIČKO MIKSOVANJE AUDIO SIGNALA**
en **PARAMETRIC MIXING OF AUDIO SIGNALS**

(73) Dolby International AB

Apollo Building, 3E, Herikerbergweg 1-35, 1101 CN Amsterdam Zuid-Oost/ NL

(72) VILLEMoes, Lars

Gävlegatan 12A, 113 30 Stockholm/ SE

PURNHAGEN, Heiko

Gävlegatan 12A, 113 30 Stockholm/ SE

LEHTONEN, Heidi-Maria

Gävlegatan 12A, 113 30 Stockholm/ SE

(57)

1. Postupak (1000) za audio dekodiranje koji obuhvata:

prijem (1010) dvokanalnog downmix signala ($L1, L2$), koji je povezan sa metapodacima, pri čemu ti metapodaci obuhvataju upmix parametre (αLU) za parametričku rekonstrukciju M -kanalnog audio signala (L, LS, LB, TFL, TBL) na bazi downmix signala, gde je $M \geq 4$;

prijem (1020) najmanje dela pomenutih metapodataka;

generisanje (1040) dekokorelisanog signala (D) na bazi najmanje jednog kanala downmix signala;

određivanje (1050) skupa koeficijenata miksovanja na bazi primljenih metapodataka; i

formiranje (1060) K -kanalnog izlaznog signala $(\tilde{L}_1, \dots, \tilde{L}_K)$

kao linearne kombinacije downmix signala i dekokorelisanog signala u skladu sa koeficijentima miksovanja, gde je $2 \leq K < M$, **naznačen time, što su**

koeficijenti miksovanja utvrđeni tako da zbir koeficijenta miksovanja koji kontroliše doprinos iz prvog kanala downmix signala u kanalu izlaznog signala, i koeficijenta miksovanja koji kontroliše doprinos iz prvog kanala downmix signala u drugom kanalu izlaznog signala, ima vrednost 1,

pri čemu, ako downmix signal predstavlja M -kanalni audio signal prema prvom kodirajućem formatu ($F1$) u kojem: prvi kanal ($L1$) downmix signala odgovara određenoj lineranoj kombinaciji prve grupe (401) jednog ili više kanala M -kanalnog audio signala;

drugi kanal ($L2$) downmix signala odgovara određenoj lineranoj kombinaciji druge grupe (402) jednog ili više kanala M -kanalnog audio signala; i

prva i druga grupa obrazuju određenu particiju M kanala M -kanalnog audio signala,

onda K -kanalni izlazni signal predstavlja M -kanalni audio signal prema drugom kodirajućem formatu ($F2, F4$) u kojem:

svaki od K kanala izlaznog signala približava se linearnoj kombinaciji grupe jednog ili više kanala M -kanalnog audio signala;

grupe koje odgovaraju respektivnim kanalima izlaznog signala obrazuju partciju M kanala M -kanalnog audio signala u K grupama (501-502, 1301-1303) jednog ili više kanala; i najmanje dve od K grupa obuhvataju najmanje jedan kanal iz pomenute prve grupe.

Patent sadrži još 14 patentnih zahtjeva

(11) **03485** (13) **B**

(51) **C07D 401/14**^(2006.01)

C07D 413/14^(2006.01)

A61K 31/4439^(2006.01)

A61P 29/00^(2006.01)

A61P 37/00^(2006.01)

C07D 405/14^(2006.01)

C07D 401/04^(2006.01)

A61K 31/5377^(2006.01)

A61P 35/00^(2006.01)

(21) P-2019-171

(22) 17.03.2016

(30) 20150004689 19.03.2015 GB

(96) 16710214.4/17.03.2016

(86) EP PCT/EP2016/055792/17.03.2016

(87) WO 2016/146738/22.09.2016/2016/38

(97) EP 3271349/24.01.2018/2018/04

EP 3271349/15.05.2019/2019/20

(54) me **DERIVATI BENZIMIDAZOLA KAO INHIBITORI BROMODOMENA**
en **BENZIMIDAZOLE DERIVATIVES AS BROMODOMAIN INHIBITORS**

(73) GlaxoSmithKline Intellectual Property Development Limited

980 Great West Road, Brentford, Middlesex TW8 9GS/ GB

(72) BIT, Rino Antonio

Gunnels Wood Road, Stevenage Hertfordshire SG1 2NY / GB

BROWN, John Alexander

Gunnels Wood Road , Stevenage Hertfordshire SG1 2NY / GB/ GB

HUMPHREYS, Philip G.

Gunnels Wood Road , Stevenage Hertfordshire SG1 2NY/ GB

JONES, Katherine Louise

Gunnels Wood Road , Stevenage Hertfordshire SG1 2NY/ GB

(74) Advokat LUTOVAC, Branislav

Bulevar Ivana Crnojevica 93 , Podgorica , 81000 / ME

(57)

1. Jedinjenje formule (I), ili njegova so:

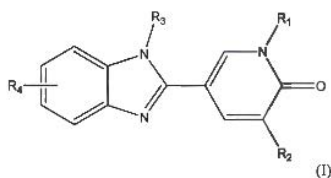

pri čemu

R₁ i R₂ su svaki nezavisno vodonik ili metil uz uslov da najmanje jedan od R₁ i R₂ je metil;

R₃ je C₁₋₆alkil, C₁₋₆alkoksi, cikloalkil, heterocikloalkil, ili -CHR₅(CH₂)_aR₆;

R₄ je vezan na položaju 5 ili 6 benzimidazola i predstavlja;

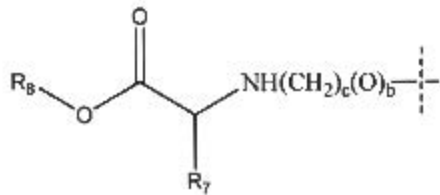

R₅ je vodik, C₁₋₃alkil, C₁₋₃alkoksi, ili -(CH₂)_dOR₉;

R₆ je vodonik, C₁₋₃alkil, C₁₋₃alkoksi, -(CH₂)_eOR₁₀, hidroksil, -NR₁₁R₁₂, halo, cikloalkil, heterocikloalkil, aril, ili heteroaril, pri čemu pomenuti C₁₋₃alkil, C₁₋₃alkoksi, -(CH₂)_eOR₁₀, cikloalkil, heterocikloalkil, aril ili heteroaril mogu opciono da budu supstituisani sa jednim ili dva supstituenata nezavisno izabranih iz grupe koja obuhvata C₁₋₃alkil, C₁₋₃alkoksi, halo, -CH₂OH, -COOH, i -COCH₃;

R₇ je vodonik, C₁₋₆alkil, -(CH₂)_gcikloalkil, -(CH₂)_hheterocikloalkil, ili -CR₁₃R₁₄R₁₅;

R₈ je vodonik, C₁₋₆alkil, cikloalkil, heterocikloalkil, ili -CHR₁₆R₁₇ pri čemu pomenuti C₁₋₆alkil je opciono supstituisan sa C₁₋₃alkoksi, i pri čemu R₁₆ je vodonik ili C₁₋₃alkil i R₁₇ je cikloalkil ili heterocikloalkil;

R₉, R₁₀, R₁₁, R₁₂, R₁₄, R₁₅, i R₁₈ su svaki nezavisno vodonik ili C₁₋₃alkil;

R₁₃ je vodonik, hidroksil, -CH₂OR₁₈, halo, -COOH, -CONH₂, 1*H*-imidazol-4-il, -SH, -SeH, C₁₋₃alkil, C₁₋₃alkoksi, fenil, ili 4-hidroksifenil pri čemu pomenuti C₁₋₃alkil ili C₁₋₃alkoksi može opciono da bude supstituisan sa halo, hidroksil, -NHC(=NH₂)NH₂, -NH₂, -COOH, -CONH₂, ili -SCH₃;

a je 0, 1, 2 ili 3;

b je 0 ili 1;

c je 1, 2 ili 3 pod uslovom da kada b je 1, c je 2 ili 3;

d i e su svaki nezavisno 1 ili 2; i

g i h su svaki nezavisno 0, 1 ili 2.

Patent sadrži još 19 patentnih zahtjeva

(11) **03486** (13) **B**

(51) **A61K 47/68**^(2017.01)

A61P 39/00^(2006.01)

C07D 487/04^(2006.01)

A61K 47/65^(2017.01)

A61P 35/00^(2006.01)

C07D 519/00^(2006.01)

(21) P-2019-172

(22) 11.10.2013

(30) 201261712928P 12.10.2012 US

(96) 14191079.4/11.10.2013

(97) EP 2839860/25.02.2015/2015/09

EP 2839860/01.05.2019/2019/18

(54) me **PIROLOBENZODIAZEPINI I NJIHOVI KONJUGATI**
en **PYRROLOBENZODIAZEPINES AND CONJUGATES THEREOF**

(73) MedImmune Limited

Milstein Building Granta Park , Cambridge CB21 6GH/ GB

(72) HOWARD, Philip Wilson

Spirogen Limited The QMB Innovation Centre

(74) Advokat RADULOVIĆ, Božidar S.

Studentska bb, Lamela 3/18 , Podgorica, 81000 / ME

(57)

1. Jedinjenje koje je A:

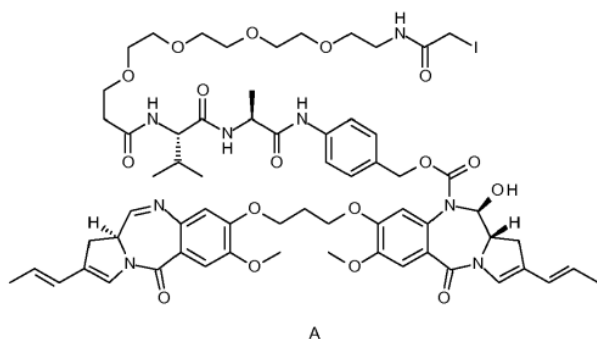

i njegove soli i solvati.

Patent sadrži još 14 patentnih zahtjeva

(11) **03487** (13) **B**

(51) **A61K 35/741**^(2015.01)

A61P 1/14^(2006.01)

A61K 9/00^(2006.01)

A61P 29/00^(2006.01)

(21) P-2019-175

(22) 06.03.2017

(30) 20160003817 04.03.2016 GB

20160012191 13.07.2016 GB

20160016022 20.09.2016 GB

(96) 17709911.6/06.03.2017

(86) EP PCT/EP2017/025038/06.03.2017

(87) WO 2017/148596/08.09.2017/2017/36

(97) EP 3313423/02.05.2018/2018/18

EP 3313423/24.04.2019/2019/17

(54) me **KOMPOZICIJE KOJE SADRŽE BLAUTIA BAKTERIJSKE SOJEVE ZA LIJEČENJE VISCERALNE HIPERSENZITIVNOSTI**
en **COMPOSITIONS COMPRISING BACTERIAL BLAUTIA STRAINS FOR TREATING VISCERAL HYPERSENSITIVITY**

(73) 4D PHARMA PLC

5th floor 9 Bond Court, Leeds, LS1 2JZ / GB

(72) BERNALIER-DONADILLE, Annick

16 impasse les Ormes, La Roche Blanc, 63670 / FR

CROUZET, Laureen

Third Floor, 9 Bond Court, Leeds LS1 2JZ/ GB

HABOUZIT, Chloe

3 rue Bertholet, Chamaliere, 63400 / FR

(74) Advokat LUTOVAC, Branislav

Bulevar Ivana Crnojevica 93 , Podgorica , 81000 / ME

(57)

1. Kompozicija koja obuhvata bakterijski soj vrste *Blautia hydrogenotrophica*, za upotrebu u postupku lečenja ili prevenciji visceralne hipersenzitivnosti.

Patent sadrži još 13 patentnih zahtjeva

(11) **03488** (13) **B**

(51) **A61K4 8/00**^(2006.01)

C07H 21/04^(2006.01)

A61K 39/12^(2006.01)

(21) P-2019-176

(22) 04.09.2012

(30) 201161532667P 09.09.2011 US

(96) 17171651.7/04.09.2012

(97) EP 3251700/06.12.2017/2017/49

EP 3251700/22.05.2019/2019/21

(54) me **USLOVNO REPLICIRAJUĆI CITOMEGALOVIRUS KAO VAKCINA ZA CMV**
en **A CONDITIONAL REPLICATING CYTOMEGALOVIRUS AS A VACCINE FOR CMV**

(73) Merck Sharp & Dohme Corp.

126 East Lincoln Avenue, Rahway, NJ 07065/ US

(72) FU, Tong-Ming

770, Sumneytown Pike, West Point, PA 19486 / US

WANG, Dai

770, Sumneytown Pike, West Point, PA 19486/ US

MEDI, Muneeswara Babu

770, Sumneytown Pike, West Point, PA 19486/ US

(74) Advokat POPOVIĆ, Miladin

Đoka Miraševića 21/III , Podgorica , 81000 / ME

(57)

1. Citomegalovirus (CMV) sa uslovno defektnom replikacijom sa destabilizovanim IE1/2 i UL51 proteinima, naznačen time što je genom CMV predstavljen sa SEQ ID NO: 14.

Patent sadrži još 14 patentnih zahtjeva

(11) **03489** (13) **B**

(51) **C07K 16/28**^(2006.01)

A61K 45/06^(2006.01)

A61K 39/395^(2006.01)

G01N 33/68^(2006.01)

(21) P-2019-177

(22) 30.01.2015

(30) 201461934469P 31.01.2014 US

201462094912P 19.12.2014 US

(96) 15705163.2/30.01.2015

(86) US PCT/US2015/013913/30.01.2015

(87) WO 2015/117002/06.08.2015/2015/31

(97) EP 3099717/07.12.2016/2016/49

EP 3099717/27.03.2019/2019/13

(54) me **MOLEKULI ANTITIJELA NA TIM-3 I NJIHOVE UPOTREBE**
en **ANTIBODY MOLECULES TO TIM-3 AND USES THEREOF**

(73) Novartis AG

Lichtstrasse 35, Basel, 4056/ CH

Children's Medical Center Corporation

55 Shattuck Street, Boston, MA 02115 / US

Dana-Farber Cancer Institute, Inc.

450 Brookline Avenue, Boston, MA 02115-5450/ US

(72) SABATOS-PEYTON, Catherine, Anne

250 Massachusetts Avenue, Cambridge, MA 02139/ US

BRANNETTI, Barbara

Lichtstrasse 35, Basel , 4056/ CH

HARRIS, Alan, S.

250 Massachusetts Avenue, Cambridge, MA 02139/ US

HUBER, Thomas

Lichtstrasse 35, Basel , 4056/ CH

PIETZONKA, Thomas

Lichtstrasse 35, Basel, 4056/ CH

MATARAZA, Jennifer, Marie

250 Massachusetts Avenue, Cambridge, MA 02139 / US

BLATTLER, Walter, A.

197 Mason Terrace, Brookline, MA 02446-2768/ US

HICKLIN, Daniel, J.

113 Clarewill Avenue, Montclair, NJ 07043 / US

VASQUEZ, Maximiliano

3813 Louis Road, Palo Alto, CA / US

DEKRUYFF, Rosemarie, H.

2 Sunhill, Portola Valley, CA 94028 / US

UMETSU, Dale, T.

2 Sunhill, Portola Valley, CA 94028/ US

FREEMAN, Gordon, James

305 Walnut Street, Brookline, MA 02445 / US

HU, Tiancen

250 Massachusetts Avenue, Cambridge, MA 02139 / US

TARASZKA, John, A.

250 Massachusetts Avenue, Cambridge, MA 02139 / US

XU, Fangmin

250 Massachusetts Avenue, Cambridge, MA 02139 / US

(74) Advokat POPOVIĆ, Miladin

Đoka Miraševića 21/III, Podgorica, 81000 / ME

(57)

1. Molekul antitela koje može da se veže za humani T-ćelijski imunoglobulinski domen i mucinski domen 3 (TIM-3), **naznačen time**, što sadrži:

(a) varijabilni region teškog lanca (VH) koji uključuje VHCDR1 aminokiselinsku sekvencu odabranu između SEQ ID NO: 9; VHCDR2 aminokiselinsku sekvencu SEQ ID NO: 10; i VHCDR3 aminokiselinsku sekvencu SEQ ID NO: 5; i varijabilni region lakog lanca (VL) koji uključuje VLCDR1 aminokiselinsku sekvencu SEQ ID NO: 12, VLCDR2 aminokiselinsku sekvencu SEQ ID NO: 13, i VLCDR3 aminokiselinsku sekvencu SEQ ID NO: 14;

(b) VH koji uključuje VHCDR1 aminokiselinsku sekvencu odabranu između SEQ ID NO: 3; VHCDR2 aminokiselinsku sekvencu SEQ ID NO: 4; i VHCDR3 aminokiselinsku sekvencu SEQ ID NO: 5; i VL koji uključuje VLCDR1 aminokiselinsku sekvencu SEQ ID NO: 6, VLCDR2 aminokiselinsku sekvencu SEQ ID NO: 7, i VLCDR3 aminokiselinsku sekvencu SEQ ID NO: 8;

(c) VH koji uključuje VHCDR1 aminokiselinsku sekvencu odabranu između SEQ ID NO: 9; VHCDR2 aminokiselinsku sekvencu SEQ ID NO: 25; i VHCDR3 aminokiselinsku sekvencu SEQ ID NO: 5; i VL koji uključuje VLCDR1 aminokiselinsku sekvencu SEQ ID NO: 12, VLCDR2 aminokiselinsku sekvencu SEQ ID NO: 13, i VLCDR3 aminokiselinsku sekvencu SEQ ID NO: 14;

(d) VH koji uključuje VHCDR1 aminokiselinsku sekvencu odabranu između SEQ ID NO: 3; VHCDR2 aminokiselinsku sekvencu SEQ ID NO: 24; i VHCDR3 aminokiselinsku sekvencu SEQ ID NO: 5; i VL koji uključuje VLCDR1 aminokiselinsku sekvencu SEQ ID NO: 6, VLCDR2 aminokiselinsku sekvencu SEQ ID NO: 7, i VLCDR3 aminokiselinsku sekvencu SEQ ID NO: 8;

(e) VH koji uključuje VHCDR1 aminokiselinsku sekvencu odabranu između SEQ ID NO: 9; VHCDR2 aminokiselinsku sekvencu SEQ ID NO: 31; i VHCDR3 aminokiselinsku sekvencu SEQ ID NO: 5; i VL koji uključuje VLCDR1 aminokiselinsku sekvencu SEQ ID NO: 12, VLCDR2 aminokiselinsku sekvencu SEQ ID NO: 13, i VLCDR3 aminokiselinsku sekvencu SEQ ID NO: 14; ili

(f) VH koji uključuje VHCDR1 aminokiselinsku sekvencu odabranu između SEQ ID NO: 3; VHCDR2 aminokiselinsku sekvencu SEQ ID NO: 30; i VHCDR3 aminokiselinsku sekvencu SEQ ID NO: 5; i VL koji uključuje VLCDR1 aminokiselinsku sekvencu SEQ ID NO: 6, VLCDR2 aminokiselinsku sekvencu SEQ ID NO: 7, i VLCDR3 aminokiselinsku sekvencu SEQ ID NO: 8.

Patent sadrži još 23 patentnih zahtjeva

(11) **03393** (13) **B**

(51) **C07K 16/40**^(2006.01)

(21) P-2019-181

(22) 24.05.2013

(30) 201209096 24.05.2012 GB

(96) 13730049.7/24.05.2013

(86) GB PCT/GB2013/051373/24.05.2013

(87) WO 2013/175229/28.11.2013/2013/48

(97) EP 2855530/08.04.2015/2015/15

EP 2855530/01.05.2019/2019/18

(54) me **ANTI-TRANSGLUTAMINAZNA 2 ANTITIJELA**
en **ANTI-TRANSGLUTAMINASE 2 ANTIBODIES**

(73) LifeArc

7th Floor Lynton House 7-12 Tavistock Square, London, Greater London WC1H 9LT/ GB

(72) JOHNSON, Tim

Academic Nephrology Unit The University of Sheffield Beech Hill Road, Sheffield S10 2RZ/ GB

WATSON, Phil

Department of Human Metabolism University of Sheffield School of Medicine and Biomedical Sciences,
Sheffield S10 2RX/ GB

MATTHEWS, David

Medical Research Council Technology 7th Floor Lynton House 7-12 Tavistock Square, London WC1H
9LT/ GB

BROWN, Alex

Medical Research Council Technology 7th Floor Lynton House 7-12 Tavistock Square, London WC1H
9LT/ GB

(57)

1. Antitelo ili njegov antigen-vezujući fragment koji se selektivno vezuje za epitop unutar regiona jezgra transglutaminaze tipa 2 (TG2) i koji inhibira humani TG2 koji unakrsno vezuje lizin i glutamin sa NE(y-glutamil)lizinom izopeptidnim vezama, pri čemu antitelo ili njegov antigen-vezujući fragment sadrži sledeće aminokiselinske sekvence:

KASQDINSYLT (LCDR1); LV
LVNRLVD (LCDR2); LQYDDFPYT
(LCDR3); THAMS (HCDR1);
TISSGGRSTYYPDSVKG (HCDR2); i

LISTY (HCDR3); ili

KASQDINSYLT (LCDR1); LT
NRLMD (LCDR2); LQYVDFPYT
(LCDR3); SSAMS (HCDR1);
TISSGGRSTYYPDSVKG (HCDR2); i

LISPY (HCDR3); ili

KASQDINSYLT (LCDR1); RT NRLFD (LCDR2); LQYDDFPYT

(LCDR3); SSAMS (HCDR1);
TISVGGGKTYYPDSVKG (HCDR2); I
LISLY (HCDR3).

Patent sadrži još 11 patentnih zahtjeva

(11) **03394** (13) **B**

(51) **A61K 47/68**^(2006.01)

(21) P-2019-182

(22) 21.02.2014

(30) 201361768368 P 22.02.2013 US

(96) 14753730.2/21.02.2014

(86) US PCT/US2014/017810/21.02.2014

(87) WO 2014/130879/28.08.2014/2014/35

(97) EP 2958944/30.12.2015/2015/53

EP 2958944/27.03.2019/2019/13

(54) me **ANTIDLL3-ANTITELO-PBD KONJUGATI I NIHOVA UPOTREBA**
en **ANTIDLL3-ANTIBODY-PBD CONJUGATES AND USES THEREOF**

(73) AbbVie Stemcentrx LLC

1 North Waukegan Road, North Chicago, IL 60064-6400/ US

MedImmune Limited

Milstein Building Granta Park, Cambridge CB21 6GH/ GB

(72) TORGOV, Michael

1188 Mission Street Apt. 1522, San Francisco, California 94103/ US

HOWARD, Philip Wilson

Medimmune Spirogen Business Unit QMB Innovation Centre 42 New Road, London Greater London E1 2AX/ GB

(57)

1. Konjugat antitela i leka (ADC) koji sadrži DLL3 agens za vezivanje ćelija kovalentno vezan preko veznika za pirolobenzodiazepin (PBD), gde je DLL3 agens za vezivanje ćelija anti-DLL3 antitelo, i gde je PBD:

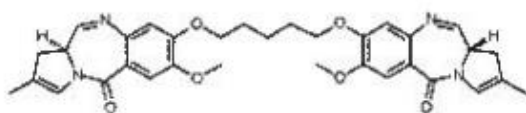

PBD 5

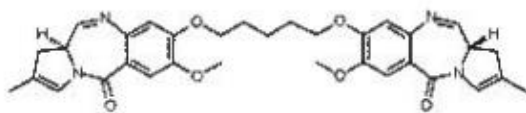

PBD 5

Patent sadrži još 29 patentnih zahtjeva

(11) **03395** (13) **B**

(51) **C07D 471/04**^(2006.01)

A61P 29/00^(2006.01)

A61P 17/00^(2006.01)

A61K 31/437^(2006.01)

A61P 3/00^(2006.01)

A61P 11/00^(2006.01)

(21) P-2019-183

(22) 28.08.2012

(30) 201161530028 P 01.09.2011 US

(96) 12756879.8/28.08.2012

(86) US PCT/US2012/052621/28.08.2012

(87) WO 2013/033070/07.03.2013/2013/10

(97) EP 2751102/09.07.2014/2014/28

EP 2751102/27.03.2019/2019/13

(54) me **JEDINJENJA I SASTAVI KAO INHIBITORI C - KIT KINAZE**
en **COMPOUNDS AND COMPOSITIONS AS C-KIT KINASE INHIBITORS**

(73) NOVARTIS AG

Lichtstrasse 35, Basel, 4056/ CH

(72) YEH, Vince

10675 John Jay Hopkins Drive, San Diego, California 92121/ US
LI, Xiaolin

10675 John Jay Hopkins Drive, San Diego, California 92121/ US
LIU, Xiaodong

10675 John Jay Hopkins Drive, San Diego, California 92121/ US
LOREN, Jon

10675 John Jay Hopkins Drive, San Diego, California 92121/ US
MOLTENI, Valentina

10675 John Jay Hopkins Drive, San Diego, California 92121/ US
NABAKKA, Juliet

10675 John Jay Hopkins Drive, San Diego, California 92121/ US
NGUYEN, Bao

10675 John Jay Hopkins Drive, San Diego, California 92121/ US
PETRASSI, Hank Michael James

10675 John Jay Hopkins Drive, San Diego, California 92121/ US

(57)

1. Jedinjenje Formule (I) ili Formule (II) ili njegova farmaceutski prihvatljiva so:

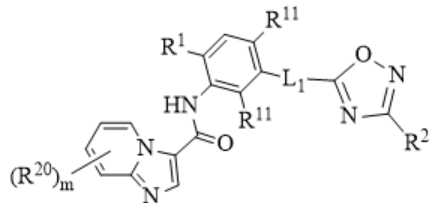

Formula (I)

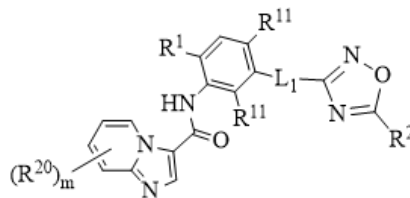

Formula (II)

gde:

m je 1 i R20 je izabran iz H, halo, C1-C6alkila, C1-C6haloalkila, C1-C6haloalkoksi, deuterijuma, deuterisanog C1-C6alkila, -CN, -(CR92)nOR4, -C(O)R4, R10, -(CR92)nR10, -((CR92)nO)tR4, -(CR92)nO(CR92)nR7, -(CR92)nC(=O)R4, -C(=O)N(R4)2, -OR4 i -(CR92)nCN;

ili m je 4 a R20 je deuterijum;

R1 je izabran iz C1-C6alkila i halo;

svaki R11 je nezavisno izabran iz H, halo i C1-C6alkila;

L1 je veza, -NH- ili -C(=O)NH-;

L2 je -(CR92)n-, -CHR6-, -(CR92)nO-, -NH-, -(CR92)nC(=O)-, -C(=O)O(CR92)n-, -(CR92)nOC(=O)NR4-, -(CR92)nNR4C(=O)(CR92)n-, -(CR92)nNR4C(=O)- ili -(CR92)nNR4C(=O)O-;

R2 je R3 ili L2R3;

R3 je izabran iz nezamenjenog C3-C8cikloalkila, ciklobutanona, ciklopentanona i zamenjenog C3-C8cikloalkila,

gde je zamenjeni C3-C8cikloalkil R3 zamenjen sa 1-4 supstituenta nezavisno izabrana iz C1-C6alkila, halo, C1-C6haloalkila, -OR4, -CN, -C(=O)OR4, -C(=O)R4, -C(=O)R7, -C(=O)OR5, -(CR92)nOR4, -C(=O)O(CR92)nOR4, -N(R4)2, =N-OR4, =N-O-(CR92)nR5, -C(=O)NR42, -NR4C(=O)OR4, -NR4C(=O)(CR92)nOR4, -NR4(CR92)nOR4, -NR4S(=O)2R4, -N(C(=O)OR4)2, =CH2, =CH(CR92)nOR4, R8, -(CR92)nR8, deuterisanog C1-C6alkoksi, -S(=O)2R4, -S(=O)2R7, -S(=O)2R8, -S(=O)2N(R4)2, -S(=O)2NHC(=O)OR4, -S(=O)2(CR92)nC(=O)OR4, -S(=O)2(CR92)nOR4, spiro povezanog dioksolana, spiro povezanog dioksolana koji je zamenjen sa C1-C6alkilom, spiro povezanog dioksana, spiro povezanog tetrahidrofuranila, spiro povezanog oksetana, spiro povezanog ciklobutanona, spiro povezanog ciklobutanola, C1 alkilnog mosta, nezamenjenog 5-6 članog heterocikloalkila sa 1-2 heteroatoma nezavisno izabrana iz N, O i S, 5-6 članog heterocikloalkila sa 1-2 heteroatoma nezavisno izabrana iz N, O i S zamenjenog sa 1-3 supstituenta nezavisno izabrana iz C1-C6alkila, halo C1-C6haloalkila, C1-C6haloalkoksi, -OR4 i R8;

svaki R4 je nezavisno izabran iz H i C1-C6alkila;

R5 je nezamenjeni C3-C8cikloalkil, nezamenjeni 5-6-člani heterocikloalkil sa 1-2 heteroatoma nezavisno izabrana iz N ili O ili C3-C8cikloalkil zamenjen sa 1-3 supstituenta nezavisno izabrana iz C1-C6alkila;

svaki R6 je nezavisno izabran iz -NHC(O)OR4, -OR4 i -(CR92)nOR4;

svaki R7 je nezavisno izabran iz C1-C6haloalkila;

R8 je izabran iz nezamenjenog fenila, nezamenjenog 5-6 članog heteroarila sa 1-3 heteroatoma nezavisno izabrana iz N, O ili S, nezamenjenog 5 članog heteroarila sa 1-4 heteroatoma izabrana iz N, nezamenjenog 4-6 članog heterocikloalkila sa 1-2 heteroatoma nezavisno izabrana iz N, O ili S, nezamenjenog C3-C8cikloalkila, zamenjenog 5-6 članog heteroarila sa 1-3 heteroatoma nezavisno izabrana iz N, O ili S, zamenjenog fenila, zamenjenog 5 članog heteroarila sa 1-4 heteroatoma izabrana iz N, zamenjenog 4-6 članog heterocikloalkila sa 1-2 heteroatoma nezavisno izabrana iz N, O ili S, zamenjenog C3-C8cikloalkila, oksazolidin-2-ona, pirolidinona i pirolidin-2-ona,

gde su zamenjeni fenil, zamenjeni 5-6-člani heteroaril sa 1-3 heteroatoma nezavisno izabrana iz N, O ili S, zamenjeni 5-člani heteroaril sa 1-4 heteroatoma izabrana iz N, zamenjeni C3-C8cikloalkil i zamenjeni 4-6-člani heterocikloalkil R8 zamenjeni sa 1-3 supstituenta nezavisno izabrana iz C1-C6alkila, $-(C(R_9)_2)_nOR_4$, $-(C(R_9)_2)_nR_5$, $-(C(R_9)_2)_nC(O)OR_4$, $-C(O)OR_4$ i $-S(O)_2R_4$;

svaki R9 je nezavisno izabran iz H i C1-C6alkila;

R10 je izabran iz nezamenjenog fenila, nezamenjenog 5-6 članog heteroarila sa 1-2 heteroatoma nezavisno izabrana iz N, O ili S, nezamenjenog 5 članog heteroarila sa 1-3 heteroatoma izabrana iz N, nezamenjenog 4-6 članog heterocikloalkila sa 1-2 heteroatoma nezavisno izabrana iz N, O ili S, nezamenjenog C3-C8cikloalkila, zamenjenog 5-6 članog heteroarila sa 1-2 heteroatoma nezavisno izabrana iz N, O ili S, zamenjenog fenila, zamenjenog 5 članog heteroarila sa 1-4 heteroatoma izabrana iz N, zamenjenog 4-6 članog heterocikloalkila sa 1-2 heteroatoma nezavisno izabrana iz N, O ili S, zamenjenog C3-C8cikloalkila, oksazolidin-2-ona, pirolidinona i pirolidin-2-ona,

gde su zamenjeni fenil, zamenjeni 5-6-člani heteroaril sa 1-2 heteroatoma nezavisno izabrana iz N, O ili S, zamenjeni 5-člani heteroaril sa 1-4 heteroatoma izabrana iz N, zamenjeni C3-C8cikloalkil i zamenjeni 4-6-člani heterocikloalkil R10 zamenjeni sa 1-3 supstituenta nezavisno izabrana iz C1-C6alkila, $-(C(R_9)_2)_nOR_4$, $-(C(R_9)_2)_nR_5$, $-(C(R_9)_2)_nC(O)OR_4$ i $-S(O)_2R_4$;

t je 1, 2 ili 3 i

svako n je nezavisno izabrano iz 1, 2, 3 i 4.

Patent sadrži još 33 patentnih zahtjeva

(11) **03396** (13) **B**

(51) **A61K 47/60**^(2006.01)

C08G 65/08^(2006.01)

C08G 65/26^(2006.01)

A61P 35/00^(2006.01)

C08G 65/14^(2006.01)

(21) P-2019-185

(22) 18.11.2010

(30) 290072 P 24.12.2009 US

262463 P 18.11.2009 US

(96) 10782159.7/18.11.2010

(86) US PCT/US2010/057289/18.11.2010

(87) WO 2011/063156/26.05.2011/2011/21

(97) EP 2501413/26.09.2012/2012/39

EP 2501413/27.03.2019/2019/13

(54) me **OBLICI KISELE SOLI KONJUGATA POLIMER-LEK**

en **ACID SALT FORMS OF POLYMER-DRUG CONJUGATES**

(73) Nektar Therapeutics

455 Mission Bay Boulevard South Suite 100, San Francisco, CA 94158/ US

(72) CHONG, Anthony O.

117 Windridge Way SW, Huntsville, AL 35824/ US

LEE, Seju

108 Alisha Circle, Madison, AL 35756/ US

JOSHI, Bhalchandra V.

1211 Willowbrook Drive 2, Huntsville, AL 35802/ US

BRAY, Brian

512 Farmingdale Road, Huntsville, AL 35802/ US

NIE, Shaoyong

922 Willowbrock Drive 6, Huntsville, AL 35802/ US

SPENCE, Patrick

110 Porch Light Place, Madison, AL 35756/ US

KOZLOWSKI, Antoni

2103 Greenslope Trail, Huntsville, AL 35811/ US

MCMANUS, Samuel

8867 Tacoma Trail, Huntsville, AL 35802/ US

TIPNIS, Sachin

12850 Whittington Drive 1506, Houston, TX 77077/ US

LAVATY, Greg

826 Bel Mar Street, Sugar Land, TX 77478/ US

SWALLOW, David

9407 Funchrch Drive, Spring, TX 77379/ US

SCHAEFER, Anthony

2208 Shades Crest Road, Huntsville, Alabama 35801/ US

HANDLEY, John

4912 Lester River Road, Duluth, MN 55804/ US

(57)

1. Kompozicija koja sadrži mešovite soli konjugata polimera rastvorljivog u vodi-aktivnog agensa, naznačena time što aktivni agens u konjugatu ima najmanje jednu baznu amino grupu, i dalje u kojoj za svaku amino

grupu unutar aktivnog agensa, amino grupa je ili protonovana ili neprotonovana, gde je bilo koja protonovana amino grupa oblik kisele soli neorganske kiseline ili trifluorosirćetne kiseline (TFA), pri čemu (i) polimer rastvorljiv u vodi je više-granati poli(etilen glikol), (ii) aktivni agens je irinotekan, (iii) neorganska kiselina je hlorovodonična kiselina (HCl), (iv) najmanje 25 mol procenata amino grupa unutar aktivnog agensa je protonovano kao TFA so, (v) 25-40 mol procenata amino grupa unutar aktivnog agensa je protonovano kao HCl so, i (vi) 5-35 mol procenata amino grupa unutar aktivnog agensa je neprotonovano.

Patent sadrži još 16 patentnih zahtjeva

(11) **03414** (13) **B**

(51) **C07D 487/04**^(2006.01)

A61K 31/4985^(2006.01)

A61P 25/00^(2006.01)

(21) P-2019-186

(22) 29.04.2016

(30) 201500261 30.04.2015 DK

201500666 29.10.2015 DK

201600202 04.04.2016 DK

(96) 16720101.1/29.04.2016

(86) EP PCT/EP2016/059583/29.04.2016

(87) WO 2016/174188/03.11.2016/2016/44

(97) EP 3288944/07.03.2018/2018/10

EP 3288944/12.06.2019/2019/24

(54) me **IMIDAZOPIRAZINONI KAO PDE1 INHIBITORI**
en **IMIDAZOPYRAZINONES AS PDE1 INHIBITORS**

(73) H. LUNDBECK A/S

Ottiliavej 9 , Valby, 2500 / DK

(72) KEHLER, Jan

Nymøllevej 28, 2800 Lyngby/ DK

RASMUSSEN, Lars Kyhn

Kaløvej 19, 2720 Vanløse/ DK

LANGGÅRD, Morten

Rågevej 20, 2600 Glostrup/ DK

JESSING, Mikkel

Fuglebo 4, 2000 Frederiksberg/ DK

VITAL, Paulo Jorge Vieira

Haderslevgade 12 2.tv., 1671 København V/ DK

JUHL, Karsten

Brydeholm 56, 2670 Greve/ DK

(57)

1. Anti-FeRn antitelo ili njegov fragment koji vezuje FeRn, gde teški lanac sadrži sekvencu navedenu u SEQ ID NO: 29 i laki lanac sadrži sekvencu navedenu u SEQ ID NO: 1S

Patent sadrži još 19 patentnih zahtjeva

(11) **03415** (13) **B**

(51) **C07K 16/28**^(2006.01)

G01N 33/53^(2006.01)

(21) P-2019-187

(22) 13.05.2013

(30) 201208370 14.05.2012 GB

(96) 13725298.7/13.05.2013

(86) EP PCT/EP2013/059802/13.05.2013

(87) WO2014/019727/06.02.2014/2014/06

(97) EP 2850101/25.03.2015/2015/13

EP 2850101/01.05.2019/2019/18

(54) me **ANTI - FCRN ANTITIJELA**
en **ANTI-FCRN ANTIBODIES**

(73) UCB BIOPHARMA SPRL

Allée de la Recherche 60, Brussels, 1070/ BE

(72) , FINNEY, Helene Margaret

c/o IPD UCB Celltech 208 Bath Road, Slough Berkshire SL1 3WE/ GB
, LAWSON, Alastair David Griffiths

c/o IPD UCB Celltech 208 Bath Road, Slough Berkshire SL1 3WE/ GB
, SHAW, Stevan Graham

c/o IPD UCB Celltech 208 Bath Road, Slough Berkshire SL1 3WE/ GB
, SMITH, Bryan John

c/o IPD UCB Celltech 208 Bath Road, Slough Berkshire SL1 3WE/ GB
, TYSON, Kerry Louise

c/o IPD UCB Celltech 208 Bath Road, Slough Berkshire SL1 3WE/ GB
, KEVORKIAN, Lara

c/o IPD UCB Celltech 208 Bath Road, Slough Berkshire SL1 3WE/ GB
, MEIER, Christoph

c/o IPD, UCB Celltech 208 Bath Road, Slough Berkshire SL1 3WE/ GB
, ATHERFOLD, Paul, Alan

208 Bath Road, Slough Berkshire SL1 3WE/ GB

, SARKAR, Kaushik

c/o IPC, UCB Celltech 208 Bath Road, Slough Berkshire SL1 3WE/ GB

(57)

1. Anti-FeRn antitelo ili njegov fragment koji vezuje FeRn, gde teški lanac sadrži sekvencu navedenu u SEQ ID NO: 29 i laki lanac sadrži sekvencu navedenu u SEQ ID NO: 1S

Patent sadrži još 19 patentnih zahtjeva

(11) **03429** (13) **B**

(51) **C08B 37/18**^(2006.01)

A61K 31/713^(2006.01)

(21) P-2019-189

(22) 21.02.2013

(30) 12159710 15.03.2012 EP

(96) 13704973.0/21.02.2013

(86) EP PCT/EP2013/053422/21.02.2013

(87) WO 2013/135471/19.09.2013/2013/38

(97) EP 2825565/21.01.2015/2015/04

EP 2825565/03.04.2019/2019/14

(54) me **KATIONSKE POLIMERE NA BAZI GLIKOGENA**
en **GLYCOGEN-BASED CATIONIC POLYMERS**

(73) Aziende Chimiche Riunite Angelini Francesco A.C.R.A.F.S.p.A.

Viale Amelia 70, Roma, 00181/ IT

(72) RUSSO, Vincenzo

Via Aurelio Saffi 64/ A, Aprilia (L T), I-04011/ IT

LIBERATI, Elisa

Via Alberese 9, Roma, I-00149/ IT

CAZZOLLA, Nicola

Via Abetonia 20/L, Albano Laziale (Roma), I-00041/ IT

(57)

1. Kationski polimer na bazi glikogena, **naznačen time, da** obuhvaća najmanje jednu ponavljajuću jedinicu odabranu iz skupine koja se sastoji od sljedećih:

(a)

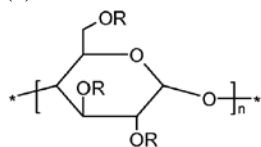

(a)

u kojoj

su skupine R koje mogu biti iste ili različite, atom vodika, karboksimetil-skupina, opcionalno u obliku soli s farmaceutski prihvatljivom organskom ili anorganskom bazom, ili skupina koja sadrži dušik odabrana od sljedećih: NH₂-(C1-C6)alkil, [N,N-di(C1-C6)alkilamino]-(C1-C6)alkil, NH₂-{[(C1-C6)alkil-di(C1-C6)alkilamonij]}-(C1-C6)alkil, {[N,N-di(C1-C6)alkilamino]-(C1-C6)alkil-di(C1-C6)alkilamonij}-(C1-C6)alkil, NH₂-[(C1-C6)alkilamino]-(C1-C6)alkil, {[N,N-di(C1-C6)alkilamino]-(C1-C6)alkilamino}-(C1-C6)alkil, [tri(C1-C6)alkilamonij]-(C1-C6)alkil, azociklil-(C1-C6)alkil, gdje su (C1-C6)alkil-lanci koji mogu biti isti ili različiti, opcionalno supstituirani s jednom ili više hidroksil-skupina, i

n je cijeli broj veći od ili jednak 1; i

(b)

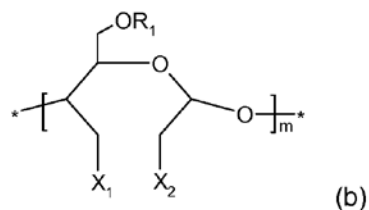

u kojoj

R1 je odabran od atoma vodika, karboksimetil-skupine, opcionalno u obliku soli s farmaceutski prihvatljivom organskom ili anorganskom bazom, ili od skupine koja sadrži dušik odabrane od sljedećih: NH₂-(C1-C6)alkil, [N,N-di(C1-C6)alkilamino]-(C1-C6)alkil,

NH₂-[(C1-C6)alkil-di(C1-C6)alkilamonij]-(C1-C6)alkil, {[N,N-di(C1-C6)alkilamino]-(C1-C6)alkil-di(C1-C6)alkilamonij}-(C1-C6)alkil, NH₂-[(C1-C6)alkilamino]-(C1-C6)alkil,

{[N,N-di(C1-C6)alkilamino]-(C1-C6)alkilamino}-(C1-C6)alkil, [tri(C1-C6)alkilamonij]-(C1-C6)alkil,

gdje su (C1-C6)alkil-lanci koji mogu biti isti ili različiti, opcionalno supstituirani s jednom ili više hidroksil-skupina; kod X1 i X2 koji mogu biti isti ili različiti, radi se o skupini -OH ili skupini koja sadrži dušik

-NHR₂, u kojoj je R₂ odabran od sljedećih: atom vodika, (C1-C6)alkil, H-[NH-(C1-C6)alkil]^{p-}, dok p je cijeli broj veći od ili jednak 1, a (C1-C6)alkil-skupine mogu biti iste ili različite; i

m je cijeli broj veći od ili jednak 1;

uz uvjet da je najmanje jedan između R, R₁, X₁ i X₂, takva skupina koja sadrži dušik kao što je definirano, odgovarajuće za svaki od R, R₁, X₁ i X₂, i

uz uvjet da je navedeni kationski polimer na bazi glikogena različit od produkta koji se dobije reakcijom glikogena s N-(3-kloro-2-hidroksipropil)-trimetil-amonij-kloridom.

Patent sadrži još 14 patentnih zahtjeva

(11) **03430** (13) **B**

(51) **C07D 405/12**^(2006.01)

A61K 31/445^(2006.01)

A61P 25/28^(2006.01)

(21) P-2019-190

(22) 07.01.2016

(30) 709CH2015 13.02.2015 IN

(96) 16711355.4/07.01.2016

(86) IN PCT/IN2016/000008/07.01.2016

(87) WO 2016/128990/18.08.2016/2016/33

(97) EP 3265459/10.01.2018/2018/02

EP 3265459/15.05.2019/2019/20

(54) me **JEDINJENJA AMIDA KAO AGONISTI 5-HT4 RECEPTORA**
en **AMIDE COMPOUNDS AS 5-HT4 RECEPTOR AGONISTS**

(73) Suven Life Sciences Limited

Serene Chambers Road No. 7 Banjara Hills, Hyderabad, Andra Pradesh 500034/ IN

(72) NIROGI, Ramakrishna

Suven Life Sciences Limited Serene Chambers Road - 5 Avenue - 7 Banjara Hills, Hyderabad - 500034
Andhra Pradesh/ IN

SHINDE, Anil Karbhari

Suven Life Sciences Limited Serene Chambers Road - 5 Avenue - 7 Banjara Hills, Hyderabad - 500034
Andhra Pradesh/ IN

MOHAMMED, Abdul Rasheed

Suven Life Sciences Limited Serene Chambers Road - 5 Avenue - 7 Banjara Hills, Hyderabad - 500034
Andhra Pradesh/ IN

SARAF, Sangram Keshari

Suven Life Sciences Limited Serene Chambers Road - 5 Avenue - 7 Banjara Hills, Hyderabad - 500034
Andhra Pradesh/ IN

BOGARAJU, Narsimha

Suven Life Sciences Limited Serene Chambers Road - 5 Avenue - 7 Banjara Hills, Hyderabad - 500034
Andhra Pradesh/ IN

SUBRAMANIAN, Ramkumar

Suven Life Sciences Limited Serene Chambers Road - 5 Avenue - 7 Banjara Hills, Hyderabad - 500034
Andhra Pradesh/ IN

JAYARAJAN, Pradeep

Suven Life Sciences Limited Serene Chambers Road - 5 Avenue - 7 Banjara Hills, Hyderabad - 500034
Andhra Pradesh/ IN

BHYRAPUNENI, Gopinadh

Suven Life Sciences Limited Serene Chambers Road - 5 Avenue - 7 Banjara Hills, Hyderabad - 500034
Andhra Pradesh/ IN

JASTI, Venkateswarlu

Suven Life Sciences Limited Serene Chambers Road - 5 Avenue - 7 Banjara Hills, Hyderabad - 500034
Andhra Pradesh/ IN

(57)

1. Jedinjenje opšte formule (I),

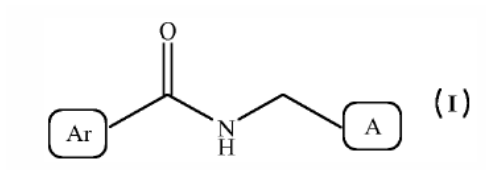

ili stereoisomer, farmaceutski prihvatljiva so tog jedinjenja, u kome,

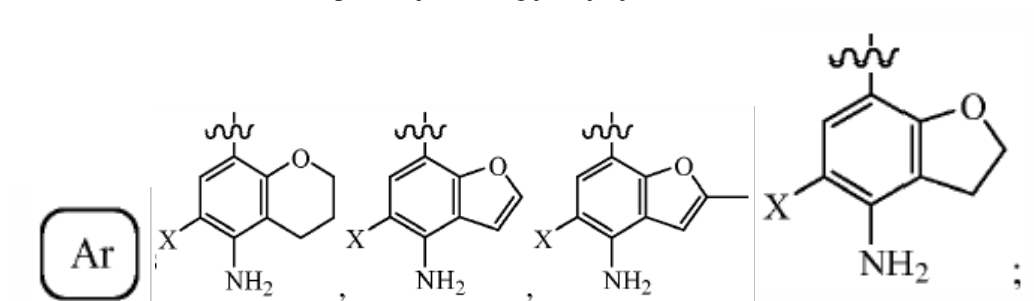

je
ili

X je halogen ili vodonik;

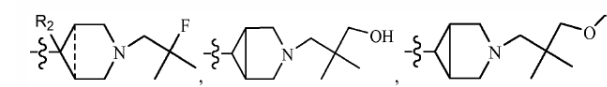
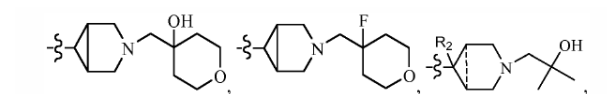
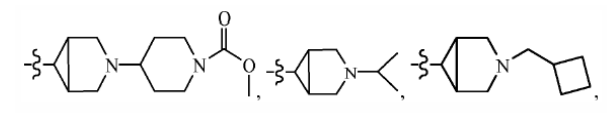
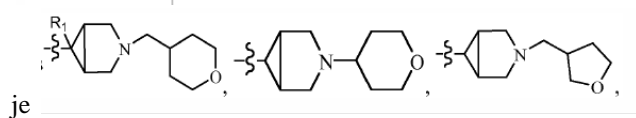

ili

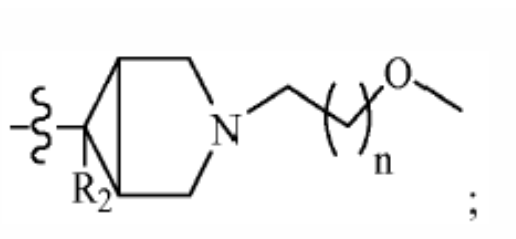

„  |

" je tačka vezivanja;

"-----" označava vezu ili da nema veze;

R1 je vodonik, fluor ili hidroksil;

R2 je vodonik ili fluor; uz uslov da je R2 jednako fluoro kada "-----" nije veza; i

"n" je 1 ili

Patent sadrži još 6 patentnih zahtjeva

(11) **03495** (13) **B**

(51) **C07D 487/04**^(2006.01)

C07D 471/14^(2006.01)

A61P 27/16^(2006.01)

C07D 487/14^(2006.01)

A61P 35/02^(2006.01)

A61K 31/55^(2006.01)

A61P 35/00^(2006.01)

(21) P-2019-191

(22) 01.07.2016

(30) 201562189393 P 07.07.2015 US

(96) 16741742.7/01.07.2016

(86) US PCT/US2016/040612/01.07.2016

(87) WO 2017/007702/12.01.2017/2017/02

(97) EP 3319967/16.05.2018/2018/20

EP 3319967/22.05.2019/2019/21

(54) me **SPOJEVI KOJI SU INHIBITORI SIGNALIZIRANJA U NOTCH PUTU**
en **NOTCH PATHWAY SIGNALING INHIBITOR COMPOUNDS**

(73) ELI LILLY AND COMPANY

Lilly Corporate Center, Indianapolis, IN 46285/ US

Audion Therapeutics B.V.

Linneausparkweg 10-2, 1098 EA Amsterdam/ NL

(72) CLAY, Julia Marie

P.O. Box 6288, Indianapolis, Indiana 46206-6288/ US

EDGE, Albert

Linneausparkweg 10-2, 1098 EA Amsterdam/ NL

HIPSKIND, Philip Arthur

P.O. Box 6288, Indianapolis, Indiana 46206-6288/ US

GILL, John C.

Linneausparkweg 10-2, 1098 EA Amsterdam/ NL

PATEL, Bharvin Kumar

P.O. Box 6288, Indianapolis, Indiana 46206-6288/ US

VAN ES, Helmuth Hendrikus Gerardus

Linneausparkweg 10-2, 1098 EA Amsterdam/ NL

WROBLESKI, Aaron D.

P.O. Box 6288, Indianapolis, Indiana 46206-6288/ US

ZHAO, Gaiying

P.O. Box 6288, Indianapolis, Indiana 46206-6288/ US

(57)

1. Spoj, **naznačen time** što ima strukturu:

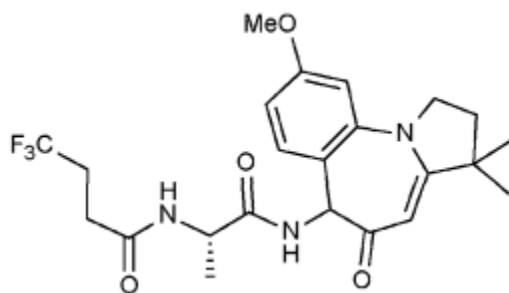

4,4,4-trifluor-*N*-((2*S*)-1-((9-metoksi-3,3-dimetil-5-okso-2,3,5,6-tetrahidro-1*H*-benzo[*f*]pirolo[1,2-*a*]azepin-6-il)amino)-1-oksopropan-2-il)butanamid, njegov dijastereomerni izomer izomerne čistoće na položaju 6 veće od 90% enantiomernog viška, ili farmaceutski prihvatljiva sol bilo kojeg od gore navedenog.

Patent sadrži još 7 patentnih zahtjeva

(11) **03435** (13) **B**

(51) **A61K 47/12**^(2006.01)

A61K 47/34^(2017.01)

A61K 9/51^(2006.01)

A61K 47/28^(2006.01)

A61K 9/107^(2006.01)

A61K 31/5377^(2006.01)

(21) P-2019-192

(22) 13.03.2015

(30) 201461953628 P 14.03.2014 US

(96) 15713285.3/13.03.2015

(86) US PCT/US2015/020343/13.03.2015

(87) WO 2015/138835/17.09.2015/2015/37

(97) EP 3116547/18.01.2017/2017/03

EP 3116547/05.06.2019/2019/23

(54) me **TERAPIJSKE NANOČESTICE KOJE SADRŽE TERAPIJSKO SREDSTVO,TE POSTUPCI NJIHOVE PROIZVODNJE I UPOTREBE**
en **THERAPEUTIC NANOPARTICLES COMPRISING A THERAPEUTIC AGENT AND METHODS OF MAKING AND USING SAME**

(73) PFIZER INC.

235 East 42nd Street, New York, NY 10017/ US

(72) BAGRODIA, Shubha

7936 Camino Tranquilo,, San Diego, CA 92122/ US

LAFONTAINE, Jennifer

13444 Montecito Glen,, San Diego, CA 92130/ US

LOVATT, Zach

41 Dayton Street,, Danvers, MA 01923/ US

SHIN, Eyoung

125 Dean Road,, Marlborough, MA 01752/ US

SONG, Young Ho

33 Bradford Road,, Natick, MA 01760/ US

TROIANO, Greg

38 Lily's Way,, Pembroke, MA 02359/ US

WANG, Hong

27 Cottage Place,, Newton, MA 02465/ US

(57)

1. Terapijska nanočestica, **naznačena time** što sadrži:

uglavnom hidrofobnu kiselinu;

terapijsko sredstvo, gdje je pKa protoniranog terapijskog sredstva u najmanju ruku otprilike 1,0 pKa jedinica veća od pKa hidrofobne kiseline; i

polimer, kojeg se bira između diblok kopolimera poli(mliječna) kiselina-poli(etilen)glikola ili diblok kopolimera poli(mliječna kiselina-ko-glikolna kiselina)-poli(etilen)glikola i njihove kombinacije;

gdje je terapijsko sredstvo 1-(4-{[4-(dimetilamino)piperidin-1-il]karbonil}fenil)-3-[4-(4,6-dimorfolin-4-il-1,3,5-triazin-2-il)fenil]urea, ili njezina farmaceutski prihvatljiva sol.

Patent sadrži još 17 patentnih zahtjeva

(11) **03458** (13) **B**

(51) **C07K 14/47**^(2006.01)

A61K 39/00^(2006.01)

C07K 7/08^(2006.01)

A61K 38/17^(2006.01)

C07K 7/06^(2006.01)

(21) P-2019-193

(22) 03.11.2014

(30) 201319446 04.11.2013 GB
201361899680 P 04.11.2013 US

(96) 14792834.5/03.11.2014

(86) EP PCT/EP2014/073588/03.11.2014

(87) WO 2015/063302/07.05.2015/2015/18

(97) EP 3066115/14.09.2016/2016/37

EP 3066115/03.04.2019/2019/14

(54) me **PERSONALIZOVANA IMUNOTERAPIJA PROTIV NEKOLIKO TUMORA NERVNIH ĆELIJA I MOZGA**
en **PERSONALIZED IMMUNOTHERAPY AGAINST SEVERAL NEURONAL AND BRAIN TUMORS**

(73) Immatix Biotechnologies GmbH
Paul-Ehrlich-Strasse 15, 72076 Tübingen/ DE

(72) WEINSCHENK, Toni
Im Morgenrain 15, Aichwald, 73773/ DE

FRITSCHKE, Jens
Lärchenweg 11, Dusslingen, 72144 / DE

WALTER, Steffen
2901 Wroxtton Road , Houston, 77005/ US

HILF, Norbert
Im Wengertacker 17, Kirchentellinsfurt, 72138/ DE

SCHORR, Oliver
Eichhaldenstrasse 19 , Tübingen , 72074 / DE

SINGH, Harpreet
Heckscherstraße 25a, Munich , 80804/ DE

KUTTRUFF-COQUI, Sabrina
Torstrasse 2-6, Filderstadt-Sielmingen, 70794/ DE

SONG, Colette
Willi Baumeisterweg 21, Ostfildern, 73760/ DE

(57)

1. Peptid koji sadrži ID BR. SEKV 28, ili njegovu farmaceutski prihvatljivu so.

Patent sadrži još 13 patentnih zahtjeva

(11) **03441** (13) **B**

(51) **A61P 35/00**^(2006.01)

C07D 413/12^(2006.01)

(21) P-2019-195

(22) 10.02.2011

(30) 20100303618P 11.02.2010 US

(96) 17157170.6/10.02.2011

(97) EP 3202460/09.08.2017/2017/32

EP 3202460/12.06.2019/2019/24

(54) me **DERIVATI ARILMETOKSI IZOINDOLINA I KOMPOZICIJE KOJE IH OBUHVATAJU I POSTUPCI NJIHOVE PRIMENE**

en **ARYLMETHOXY ISOINDOLINE DERIVATIVES AND COMPOSITIONS COMPRISING AND METHODS OF USING THE SAME**

(73) CELGENE CORPORATION

86 Morris Avenue, Summit, NJ 07901/ US

(72) Man, Hon-Wah

27 Grant Way, Princeton, NJ New Jersey 08540/ US

Muller, George W.

P.O. Box Box 3688, Rancho Santa Fe, CA California 92067/ US

Ruchelman, Alexander L

15 Cutter Court, Cream Ridge, NJ New Jersey 08514/ US

KHALIL, Ehab M.

305 Glebe Spring Lane, Yorktown, VA Virginia 23693/ US

Chen, Roger Shen-Chu

110 Christie St, Edison, NJ New Jersey 08820/ US

ZHANG, Weihong

706 South 5th Ave, Highland Park, NJ New Jersey 08904/ US

(57)

1. Jedinjenje, koje je

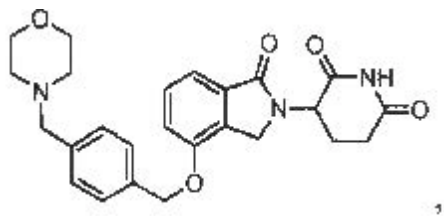

ili njegova farmaceutski prihvatljiva so ili stereoozomer.

Patent sadrži još 5 patentnih zahtjeva

(11) **03451** (13) **B**

(51) **C07D403/12**^(2006.01)
A61P35/00^(2006.01)

A61K31/4184^(2006.01)

(21) P-2019-196

(22) 28.07.2016

(30) 201562200684P 04.08.2015 US

(96) 16750326.7/28.07.2016

(86) US PCT/US2016/044410/28.07.2016

(87) WO 2017/023672/09.02.2017/2017/06

(97) EP 3331873/13.06.2018/2018/24

EP 3331873/26.06.2019/2019/26

(54) me **DERIVAT 4-(3-PIRAZOLILAMINO)BENZIMIDAZOLA KAO INHIBITOR JAK1, NAMIJENJEN LIJEČENJU RAKA**
en **A 4-(3-PYRAZOLYLAMINO)-BENZIMIDAZOLE DERIVATIVE AS JAK1 INHIBITOR FOR TREATING CANCER**

(73) Eli Lilly and Company

Lilly Corporate Center, Indianapolis, IN 46285/ US

(72) CLAYTON, Joshua Ryan

P.O. Box 6288, Indianapolis, Indiana 46206-6288 / US

(57)

1. Spoj, **naznačen time** što je spoj Formule I:

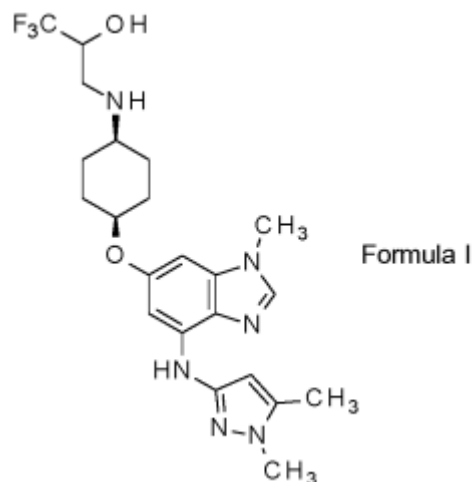

ili njegova farmaceutski prihvatljiva sol.

Patent sadrži još 11 patentnih zahtjeva

(11) **03470** (13) **B**

(51) **A61K 31/519**^(2006.01)

C07D 471/14^(2006.01)

A61P 35/00^(2006.01)

A61K 31/44^(2006.01)

A61K 45/06^(2006.01)

(21) P-2019-197

(22) 13.03.2014

(30) 201361779828 P 13.03.2013 US

201361904718 P 15.11.2013 US

(96) 14775569.8/13.03.2014

(86) US PCT/US2014/025885/13.03.2014

(87) WO 2014/160130/02.10.2014/2014/40

(97) EP 2968294/20.01.2016/2016/03

EP 2968294/01.05.2019/2019/18

(54) me **7-BENZIL-10-(2-METILBENZIL)-2,6,7,8,9,10-HEKSAHIDROIMIDAZO [1,2-A]PIRIDO[4,3-D]PIRIMIDIN-5(3H)-ON ZA UPOTREBU U LIJEČENJU KANCERA**

en **7-BENZYL-10-(2-METHYLBENZYL)-2,6,7,8,9,10-EXAHYDROIMIDAZO [1,2-A]PYRIDO[4,3-D]PYRIMIDIN-5(3H)-ON FOR USE IN THE TREATMENT OF CANCER**

(73) Oncoceutics, Inc.

3675 Market Street, Suite 200, Philadelphia, PA 19104/ US

(72) STOGNIEW, Martin

1870 Ferguson Ln., Blue Bell, PA 19422/ US

ALLEN, Joshua E.

129 Tremont St, Cambridge, MA 02139 / US

NALLAGANCHU, Bhaskara Rao

99 Norstrand Road, Hillsborough, NJ 08852/ US

POTTORF, Richard S.

7550 Prairie View Dr., Indianapolis, IN 46526/ US

OLSON, Gary L.

7 Deer Park Drive, Suite D, Monmouth Junction, NJ 08852/ US

(57)

1. Di-hidrohloridna so anti-kancer sredstva. dobijena ili koja se može dobiti postupkom koji sadrži sljedeće korake:

Korak 1 : neutralizacija N-benzil-3-karbometoksi-4-piperidon hidrohlorida Qedinjenje (3))

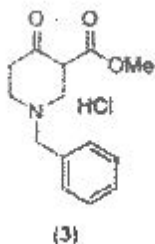

sa bazom, da bi se obrazovala sl o bodna baza N-benzil-3-karbometoksi-4-piperidona Gedinjenje (4))

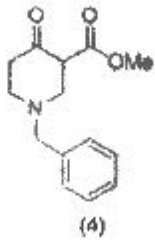

Korak 2: reakcijajedinjenja (4) sajedinjenjem (5)

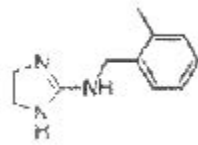

da se obrazovala anti-kancer sredstvo; i

Korak 3: obrazovanje di-hidrohlordne soli anti-kancer sredstva obrazovanog u Koraku 2, za upotrebu u lečenju kancera.

Patent sadrži još 14 patentnih zahtjeva

(11) **03452** (13) **B**

(51) **A61K 31/428**^(2006.01)

A61K 31/4709^(2006.01)

A61K 31/506^(2006.01)

A61K 31/5377^(2006.01)

A61K 31/4439^(2006.01)

A61K 31/498^(2006.01)

A61K 31/53^(2006.01)

C07D 487/04^(2006.01)

(21) P-2019-199

(22) 21.10.2010

(30) 254509 P 23.10.2009 US

(96) 16163733.5/21.10.2010

(97) EP 3093291/16.11.2016/2016/46

EP 3093291/08.05.2019/2019/19

(54) me **DISUPSTITUISANI OKTAHI-DROPIROLO[3,4-C]PIROLI KAO MODULATORI OREKSIN RECEPTORA**
en **DISUBSTITUTED OCTAHY - DROPYRROLO [3,4-C]PYRROLES AS OREXIN RECEPTOR MODULATORS**

(73) Janssen Pharmaceutica NV

Turnhoutseweg 30, 2340 Beerse/ BE

(72) CHAI, Wenying

4318 Corte Al Fresco, San Diego, CA 92130/ US

LETAVIC, Michael A.

4379 Mistral Place, San Diego, CA 92130/ US

LY, Kiev S.

P.O. Box 927992, San Diego, CA 92192/ US

PIPPEL, Daniel J.

12795 Via Cortina, Del Mar, CA 92014/ US

RUDOLPH, Dale A.

12721 Alondra Court, San Diego, CA 92128/ US

STROTHER, Kathleen C.

3429 Borreson Street, San Diego, CA 92117/ US

SAVALL, Brad M.

9512 Ronda Avenue, San Diego, CA 92123/ US

SHAH, Chandravadan R.

14213 Dalhouside Road, San Diego, CA 92129/ US

SHIREMAN, Brock T.

12625 Birchbrook Court, Poway, CA 92064/ US

SOYODE-JOHNSON, Akinola

8530 Costa Verde Blvd. 1409, San Diego, CA 92122/ US

STOCKING, Emily M.

310 Melrose Avenue, Encinitas, CA 92024/ US

SWANSON, Devin M.

3121 Morning Way, La Jolla, CA 92037/ US

(57)

1. Hemijskientitet koji je jedinjenje formule (I):

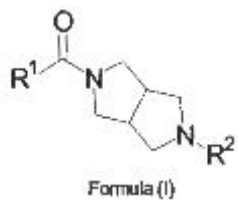

gde:

R¹ je fenil supstituisan ili nesupstituisan sa jednim ili dva Ra članova i supstituisan u arto položaju sa R^b;

R^a je halo, C₁₋₄alkil, ili C₁₋₄alkoksi;

R^b je triazol ili pirimidin supstituisan ili nesupstituisan sa halo ili C₁₋₄alkil;

R² je 6-člani heteroarilniršten koji sadrži dva atoma azota supstituisana sa jednim ili više članova izabranim iz grupe koju čine: halo, C₁₋₄alkil, CD₃, D, C₁₋₄alkoksi, ciklopropil, morfolin-2-il, CO₂C₁₋₄alkil, CO₂H, CH₂OH, C(O)N(C₁₋₄alkil)₂, CF₃, CN, OH, NO₂, N(C₁₋₄alkil)₂, fenil, furan-2-il, tiofen2-il, 1H-pirazol-4-il,

i pirolidin-1-il;

ili farmaceutski prihvatljiva so jedinjenja formule (1).

Patent sadrži još 16 patentnih zahtjeva

(11) **03461** (13) **B**

(51) **A61M 15/00**^(2006.01)

(21) P-2019-200

(22) 19.06.2015

(30) 14175021 30.06.2014 EP

(96) 15729857.1/19.06.2015

(86) EP PCT/EP2015/063803/19.06.2015

(87) WO 2016/000983/07.01.2016/2016/01

(97) EP 3160555/03.05.2017/2017/18

EP 3160555/24.04.2019/2019/17

(54) me **INHALATOR ZA SUVI PRAH I INHALACIJOM AKTIVIRANI MEHANIZAM ISTOG**
en **DRY POWDER INHALER AND INHALATION ACTUATED MECHANISM THEREOF**

(73) Chiesi Farmaceutici S.p.A.

Via Palermo 26/A, 43122 Parma/ IT

(72) TAMPIERI, Valerio

Via Palermo 26/A, 43122 Parma/ IT

ZUCCHERI, Lorenzo

Via Palermo 26/A, 43122 Parma/ IT

ILANDI, Emiliano

.Via Palermo 26/A, 43122 Parma/ IT

CAMPANINI, Alice

Via Palermo 26/A, 43122 Parma/ IT

PASQUALI, Irene

Via Palermo 26/A, 43122 Parma/ IT

LINNANE, Patrick Gerard

Via Palermo 26/A, 43122 Parma/ IT

HAWSON, Nicholas Lee

Via Palermo 26/A, 43122 Parma/ IT

GALE, David

Via Palermo 26/A, 43122 Parma/ IT

GARRAD, Joanne

Via Palermo 26/A, 43122 Parma/ IT

(57)

I. Zaklopka (20) za inhalacijom aktivirani mehanizam (18) inhalatora praha, koja sadrži:

element (29) osnove koji sadrži ravan deo (60) u obliku ploče; konstrukciju (24) ruba, gde konstrukcija (24) ruba sadrži prve delove (26B) bočnog zida, koji se suštinski protežu u uzdužnom pravcu od elementa (29) osnove, i drugi deo (26A) bočnog zida koji se proteže između prvih delova (26B) bočnog zida u pravcu širine elementa (29) osnove tako da se konstrukcija (24) ruba koja sadrži prve delove (26B) bočnog zida i drugi deo (26A) bočnog zida proteže duž obima elementa (29) osnove, ali je otvorena prema prednjem kraju elementa (29) osnove; ideo (21) za spajanje koji se povezuje sa elastičnim elementom (40') inhalacijom aktiviranog mehanizma (18), gde deo (21) za spajanje se pruža od donje površine elementa (29) osnove nadole, **naznačena time** što konstrukcija (24) ruba se pruža nagore od ravnog dela (60) u obliku ploče elementa (29) osnove.

Patent sadrži još 14 patentnih zahtjeva.

(11) **03490** (13) **B**

(51) **C07D 513/04**^(2006.01)

A61K 31/506^(2006.01)

A61P 35/00^(2006.01)

(21) P-2019-201

(22) 16.12.2015

(30) 201462095185P 22.12.2014 US

(96) 15823869.1/16.12.2015

(86) US PCT/US2015/065940/16.12.2015

(87) WO 2016/106029/30.06.2016/2016/26

(97) EP 3237423/01.11.2017/2017/44

EP 3237423/05.06.2019/2019/23

(54) me **DERIVATI TIENO[2,3-C]PIROL-4-ONA KAO INHIBITORI ERK**
en **THIENO[2,3-C]PYRROL-4-ONE DERIVATIVES AS ERK INHIBITORS**

(73) Eli Lilly and Company

Lilly Corporate Center, Indianapolis, IN 46285/ US

(72) CORTEZ, Guillermo S.

, Indianapolis, Indiana 46206-6288, P.O.Box 6288/ US

JOSEPH, Sajan

, Indianapolis, Indiana 46206-6288, P.O.Box 6288/ US

MCLEAN, Johnathan Alexander

, Indianapolis, Indiana 46206-6288, P.O.Box 6288/ US

MCMILLEN, William T.

, Indianapolis, Indiana 46206-6288, P.O.Box 6288/ US

RODRIGUEZ, Michael John

, Indianapolis, Indiana 46206-6288, P.O.Box 6288/ US

ZHAO, Gaiying

, Indianapolis, Indiana 46206-6288, P.O.Box 6288/ US

(74) Advokat ČUPIĆ, Branislav

Dalmatinska 10 , Podgorica , 81000/ ME

(57)

1. Spoj formule:

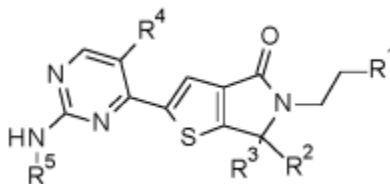

naznačen time što:

R1 je

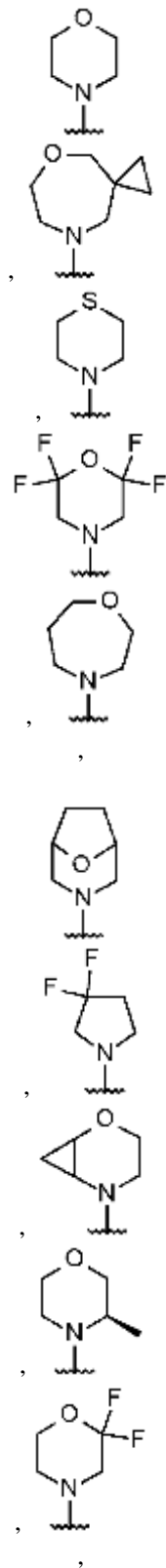

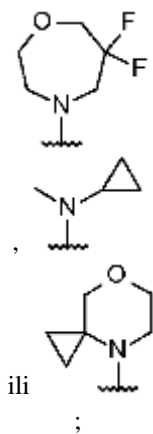

R2 i R3 su metil ili se R2 i R3 može uzeti zajedno kako bi tvorili ciklopropil;

R4 je vodik, metil, klor, fluor ili trifluormetil; i

R5 je

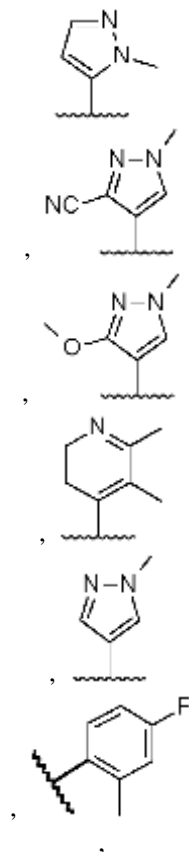

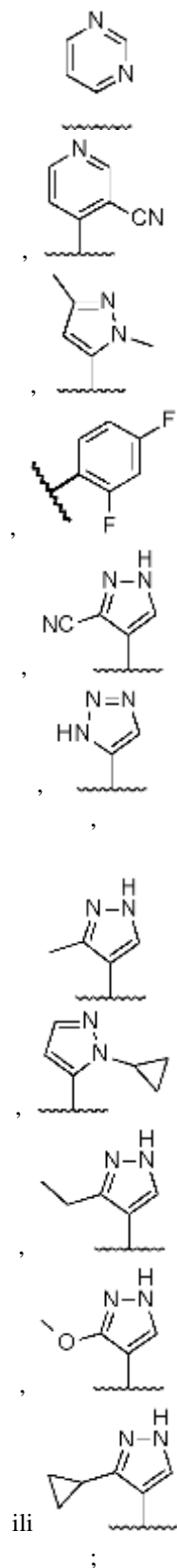

ili njegova farmaceutski prihvatljiva sol.

Patent sadrži još 15 patentnih zahtjeva

(11) **03491 (13) B**

(51) **A61K 38/00**^(2006.01)

A61K 38/43^(2006.01)

A61K 31/132^(2006.01)

A61K 31/56^(2006.01)

A61K 38/16^(2006.01)

A61K 31/131^(2006.01)

A61K 31/215^(2006.01)

(21) P-2019-205

(22) 08.06.2012

(30) 201161494881P 08.06.2011 US

(96) 12728007.1/08.06.2012

(86) US PCT/US2012/041724/08.06.2012

(87) WO 2012/170930/13.12.2012/2012/50

(97) EP 2717893/16.04.2014/2014/16

EP 2717893/08.05.2019/2019/19

(54) me **KOMPOZICIJE LIPIDNIH NANOČESTICA I POSTUPCI ZA ISPORUKU IRNK**
en **LIPID NANOPARTICLE COMPOSITIONS AND METHODS FOR MRNA DELIVERY**

(73) Translate Bio, Inc.

29 Hartwell Avenue, Lexington, MA 02421/ US

(72) GUILD, Braydon, Charles

109 Riverdale Road, Concord, MA 01742/ US

DEROSA, Frank

26 Mount Auburn Street, Chelmsford, MA 01824/ US

HEARTLEIN, Michael

167 Reed Farm Road, Boxborough, MA 01719/ US

(74) Advokat LUTOVAC, Branislav

Bulevar Ivana Crnojevica 93 , Podgorica , 81000 / ME

(57)

1. Kompozicija koja sadrži (a) najmanje jedan molekul iRNK čiji najmanje jedan deo kodira funkcionalni sekretovani polipeptid; i (b) lipozomski nosač za transfer koji sadrži lipidnu nanočesticu koja sadrži jedan ili više katjonskih lipida, jedan ili više nekatjonskih lipida i jedan ili više lipida modifikovanih sa PEG, za upotrebu u postupku lečenja subjekta sa defektom ili deficijencijom u navedenom sekretovanom polipeptidu, pri čemu je iRNK inkapsulirana u nosač za transfer i pri čemu se kompozicija primenjuje isporukom u pluća putem nebulizacije.

Patent sadrži još 13 patentnih zahtjeva

(11) **03492** (13) **B**

(51) **G03G 15/08**^(2006.01)

G03G 21/18^(2006.01)

(21) P-2019-206

(22) 13.12.2013

(30) 20120273204 14.12.2012 JP

(96) 13862540.5/13.12.2013

(86) JP PCT/JP2013/084174/13.12.2013

(87) WO 2014/092208/19.06.2014/2014/25

(97) EP 2933685/21.10.2015/2015/43

EP 2933685/08.05.2019/2019/19

(54) me **PROCESNI KERTRIDŽ I UREĐAJ ZA FORMIRANJE SLIKE**
en **PROCESS CARTRIDGE AND IMAGE FORMATION DEVICE**

(73) Canon Kabushiki Kaisha

30-2, Shimomaruko 3-chome Ohta-ku, Tokyo 146-8501 / JP

(72) MAESHIMA, Hideki

30-2 Shimomaruko 3-chome Ohta-ku, Tokyo 146-8501/ JP

HIRUKAWA, Kuniaki

30-2 Shimomaruko 3-chome Ohta-ku, Tokyo 146-8501/ JP

GOFUKU, Shuichi

30-2 Shimomaruko 3-chome Ohta-ku, Tokyo 146-8501/ JP

MITSUI, Yoshihiro

30-2 Shimomaruko 3-chome Ohta-ku, Tokyo 146-8501/ JP

(74) Advokat POPOVIĆ, Miladin

Đoka Miraševića 21/III, Podgorica, 81000 / ME

(57)

1. Procesni kertridž koji sadrži:

(i) foto-osetljivi bubanj (1);

(ii) valjak (25) za razvijanje koji može vršiti rotaciono kretanje, namenjen za razvijanje elektrostatičke nevidljive slike formirane na navedenom foto-osetljivom bubnju (1);

(iii) valjak (34) za dopremanje razvijача, koji je izveden u kontaktu sa navedenim valjkom (25) za razvijanje, gde valjak za dopremanje razvijача poseduje osovinu (34j);

(iv) prihvatni deo (23) namenjen za prihvatanje pogonske sile radi rotiranja navedenog valjka (34) za dopremanje razvijача i navedenog valjka (25) za razvijanje, gde je navedeni prihvatni deo (23) za prihvatanje pogonske sile izveden na delu završetka osovine navedenog valjka (34) za dopremanje razvijача;

(v) prvi prenosni deo (38) namenjen za prenos pogonske sile koja je prihvaćena od strane navedenog prihvatnog dela (23) za prihvatanje pogonske sile na navedeni valjak (25) za razvijanje; i

(vi) drugi prenosni deo (39) koji je izveden na završnom delu osovine navedenog valjka (25) za razvijanje radi prenošenja pogonske sile sa navedenog prvog prenosnog dela (38) na navedeni valjak (25) za razvijanje sprežanjem sa navedenim prvim delom (38) za prenos pogonske sile,

naznačen time, što se navedeni prvi prihvatni deo (23) može pokretati relativno u odnosu na navedeni valjak (34) za dopremanje razvijача u pravcu koji se ukršta sa osovinom (34j) navedenog valjka (34) za dopremanje razvijача,

što je navedeni prvi prenosni deo (38) za prenos pogonske sile izveden na završnom delu osovine navedenog valjka (34) za dopremanje razvijaača, i

što je navedeni procesni kertridž (70) prilagođen tako da je pravac rotacije navedenog valjka (25) za razvijanje suprotan u odnosu na pravac rotacije navedenog valjka (34) za dopremanje razvijaača kako bi se površine navedenog valjka (25) za razvijanje i navedenog valjka (34) za dopremanje razvijaača pomerale u istom pravcu u kontaktnoj oblasti između navedenog valjka (25) za razvijanje i navedenog valjka (34) za dopremanje razvijaača, i što je površinska brzina navedenog valjka (34) za dopremanje razvijaača veća od površinske brzine navedenog valjka (25) za razvijanje kada su navedeni valjak (34) za dopremanje razvijaača i navedeni valjak (25) za razvijanje rotirani.

Patent sadrži još 12 patentnih zahtjeva

(11) **03474** (13) **B**

(51) **C07D 413/14**^(2006.01)

C07D 401/04^(2006.01)

C07D 417/14^(2006.01)

C07D 498/04^(2006.01)

C07D 413/04^(2006.01)

(21) P-2019-211

(22) 02.06.2016

(30) 201562170215 P 03.06.2015 US

(96) 16729454.5/02.06.2016

(86) US PCT/US2016/035482/02.06.2016

(87) WO 2016/196771/08.12.2016/2016/49

(97) EP 3303330/11.04.2018/2018/15

EP 3303330/01.05.2019/2019/18

(54) me **4-HIDROKSI-3-(HETEROARIL)PIRIDIN-2-ON APJ AGONISTI ZA PRIMENU U LEČENJU KARDIOVASKULARNIH POREMEĆAJA**
en **4-HYDROXY-3-(HETEROARYL)PYRIDINE-2-ONE APJ AGONISTS FOR USE IN THE TREATMENT OF CARDIOVASCULAR DISORDERS**

(73) BRISTOL-MYERS SQUIBB COMPANY

Route 206 and Province Line Road, Princeton, NJ 08543/ US

(72) JOHNSON, James A.

c/o Bristol-Myers Squibb Company Route 206 and Province Line Road, Princeton, New Jersey 08543/ US

KIM, Soong-Hoon

c/o Bristol-Myers Squibb Company Route 206 and Province Line Road, Princeton, New Jersey 08543/ US

LAWRENCE, R. Michael

c/o Bristol-Myers Squibb Company Route 206 and Province Line Road, Princeton, New Jersey 08543/ US

MYERS, Michael C.

c/o Bristol-Myers Squibb Company Route 206 and Province Line Road, Princeton, New Jersey 08543/ US

CHAO, Hannguang J.

4 Myopia Lane, Nashua, New Hampshire 03063/ US

PHILLIPS, Monique

c/o Bristol-Myers Squibb Company Route 206 and Province Line Road, Princeton, New Jersey 08543/ US

JIANG, Ji

c/o Bristol-Myers Squibb Company Route 206 and Province Line Road, Princeton, New Jersey 08543/ US

(57)

1. Jedinjenje formule (I):

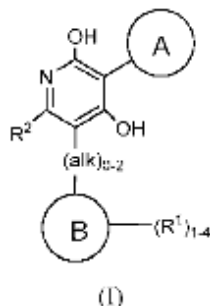

ili njegov stereoizomer, tautomer, ili farmaceutski prihvatljiva so, pri čemu:

alk je C1-6 alkil supstituisan sa 0-5 Re;

prsten A je nezavisno odabran od:

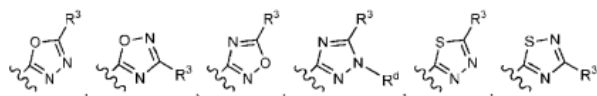

i

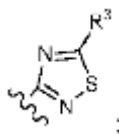

prsten B je nezavisno odabran od:

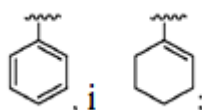

R1 je nezavisno odabrano od: H, halogen, NO₂, -(CH₂)_nOR_b,

(CH₂)_nS(O)_pR_c, -(CH₂)_nC(=O)R_b, -(CH₂)_nNR_aR_a, -(CH₂)_nCN, -(CH₂)_nC(=O)NR_aR_a, -(CH₂)_nNR_aC(=O)R_b, -(CH₂)_nNR_aC(=O)NR_aR_a, -(CH₂)_nNR_aC(=O)OR_b, -(CH₂)_nOC(=O)NR_aR_a, -(CH₂)_nC(=O)OR_b, -(CH₂)_nS(O)_pNR_aR_a, -(CH₂)_nNR_aS(O)_pNR_aR_a, -(CH₂)_nNR_aS(O)_pR_c, C1-4 alkil supstituisan sa 0-3 Re, -(CH₂)_n-C3-6 karbociklil supstituisan sa 0-3 Re, i -(CH₂)_n-heterociklil supstituisan sa 0-3 Re;

R2 je nezavisno odabrano od: C1-5 alkil supstituisan sa 0-3 Re; C2-5 alkenil supstituisan sa 0-3 Re, i C3-6 cikloalkil supstituisan sa 0-3 Re; pod uslovom da kada R2 je C1-5 alkil, atom ugljenika izuzev onog vezanog direktno za piridin prsten može biti zamenjen sa O, N, i S;

R3 je nezavisno odabrano od:

- (1) -(CR₄R₄)_rC(=O)OC1-4 alkil supstituisan sa 0-5 Re,
- (2) -(CR₄R₄)_rNR_aR_a,
- (3) -(CR₄R₄)_rC(=O)NR_aR_a,
- (4) -(CR₄R₄)_rNR_aC(=O)C1-4alkil supstituisan sa 0-5 Re,
- (5) -(CR₄R₄)_rNR_aC(=O)(CR₄R₄)_nOC1-4alkil supstituisan sa 0-5 Re,
- (6) -(CR₄R₄)_r-R₅,
- (7) -(CR₄R₄)_r-OR₅,
- (8) -(CR₄R₄)_rNR-C(=O)(CR₄R₄)_nR₅, i
- (9) -(CR₄R₄)_rC(=O)NR_a(CR₄R₄)_nR₅;

R4 je nezavisno odabrano od: H, halogen, NR_aR_a, OC1-4alkil, i C1-4 alkil; ili R4 i R4 zajedno sa atomom ugljenika za koji su oba povezana formiraju C3-6 cikloalkil supstituisan sa 0-5 Re;

R5 je nezavisno odabrano od: -(CH₂)_n-C3-10 karbociklus i -(CH₂)_n-heterociklus, svaki supstituisan sa 0-3 R₆;

R6 je nezavisno odabrano od: H, halogen, =O, $-(CH_2)_nOR_b$, $(CH_2)_nS(O)pR_c$, $-(CH_2)_nC(=O)R_b$, $-(CH_2)_nNR_aR_a$, $-(CH_2)_nCN$, $-(CH_2)_nC(=O)NR_aR_a$, $-(CH_2)_nNR_aC(=O)R_b$, $-(CH_2)_nNR_aC(=O)NR_aR_a$, $-(CH_2)_nNR_aC(=O)OR_b$, $-(CH_2)_nOC(=O)NR_aR_a$, $-(CH_2)_nC(=O)OR_b$, $-(CH_2)_nS(O)pNR_aR_a$, $-(CH_2)_nNR_aS(O)pNR_aR_a$, $-(CH_2)_nNR_aS(O)pR_c$, C1-5 alkil supstituisan sa 0-3 Re, $(CH_2)_n$ -C3-6 karbociklil supstituisan sa 0-3 Re, i $-(CH_2)_n$ -heterociklil supstituisan sa 0-3 Re;

Ra je nezavisno odabrano od H, C1-6 alkil supstituisan sa 0-5 Re, C2-6 alkenil supstituisan sa 0-5 Re, C2-6 alkinil supstituisan sa 0-5 Re, $-(CH_2)_n$ -C3-10karbociklil supstituisan sa 0-5 Re, i $-(CH_2)_n$ -heterociklil supstituisan sa 0-5 Re; ili Ra i Ra zajedno sa atomom azota za koji su oba vezana formiraju heterociklični prsten supstituisan sa 0-5 Re;

Rb je nezavisno odabrano od H, C1-6 alkil supstituisan sa 0-5 Re, C2-6 alkenil supstituisan sa 0-5 Re, C2-6 alkinil supstituisan sa 0-5 Re, $-(CH_2)_n$ -C3-10karbociklil supstituisan sa 0-5 Re, i $-(CH_2)_n$ -heterociklil supstituisan sa 0-5 Re;

Rc je nezavisno odabrano od C1-6 alkil supstituisan sa 0-5 Re, C2-6 alkenil supstituisan sa 0-5 Re, C2-6 alkinil supstituisan sa 0-5 Re, C3-6karbociklil, i heterociklil;

Rd je nezavisno odabrano od H i C1-4alkil supstituisan sa 0-5 Re;

Re je nezavisno odabrano od C1-6 alkil supstituisan sa 0-5 Rf, C2-6 alkenil, C2-6 alkinil, $-(CH_2)_n$ -C3-6 cikloalkil, $-(CH_2)_n$ -C4-6 heterociklil, $-(CH_2)_n$ -aril, $-(CH_2)_n$ -heteroaril, F, Cl, Br, CN, NO₂, =O, CO₂H, $-(CH_2)_nOR_f$, S(O)pRf, C(=O)NRfRf, NRfC(=O)Rf, S(O)pNRfRf, NRfS(O)pRf, NRfC(=O)ORf, OC(=O)NRfRf i $-(CH_2)_nNRfRf$;

Rf je nezavisno odabrano od H, F, Cl, Br, CN, OH, C1-5alkil (optimalno supstituisan sa halogen i OH), C3-6 cikloalkil, i fenil, ili Rf i Rf zajedno sa atomom azota za koji su oba vezana formiraju heterociklični prsten po izboru supstituisan sa C1-4alkil grupom;

n je nezavisno odabrano od nula, 1, 2, i 3;

r je nezavisno odabrano od nula, 1, 2, i 3; i

p je nezavisno odabrano od nula, 1, i

Patent sadrži još 24 patentnih zahtjeva

(11) **03431** (13) **B**

(51) **H04W 48/16**^(2009.01)

H04L 1/00^(2006.01)

(21) P-2019-214

(22) 23.09.2015

(30) 201462065001 P 17.10.2014 US
201514861325 22.09.2015 US

(96) 15775876.4/23.09.2015

(86) US PCT/US2015/051641/23.09.2015

(87) WO 2016/060802/21.04.2016/2016/16

(97) EP 3207743/23.08.2017/2017/34
EP 3207743/10.07.2019/2019/28

(54) me **BLUMOV FILTAR ZA INFORMACIJE KOJE NJ GOVEŠTAVAJU SERVIS U REKLAMAMA**
en **BLOOM FILTER FOR SERVICE HINT INFORMATION IN ADVERTISEMENTS**

(73) QUALCOMM INCORPORATED

5775 Morehouse Drive, San Diego, CA 92121-1714/ US

(72) ABRAHAM, Santosh Paul

5775 Morehouse Drive, San Diego, California 92121-1714/ US

CHERIAN, George

5775 Morehouse Drive, San Diego, California 92121-1714/ US

RAISSINIA, Alireza

5775 Morehouse Drive, San Diego, California 92121-1714/ US

(57)

1. Postupak za bežične komunikacije putem uređaja, koji obuhvata:

generisanje mnoštva bitmapa koje ukazuju na jedan ili više servisa koji su poznati uređaju, pri čemu je svaka bitmapa generisana primenom različitog seta od jedne ili više heš funkcija zasnovanih na cikličnoj proveru redundanse (CRC), od mnoštva setova heš funkcija zasnovanih na CRC, na jednu ili više identifikacija servisa (IDs), za svaki servis;

generisanje jednog ili više okvira podataka, pri čemu svaki okvir podataka uključuje bitmapu odabranu od mnoštva bitmapa i naznaku seta od jedne ili više heš funkcija zasnovanih na CRC koje su korišćene za generisanje odabrane bitmape uključene u okvir podataka;

isporučivanje jednog ili više okvira za prenos.

Patent sadrži još 14 patentnih zahtjeva

(11) **03446** (13) **B**

(51) **C07K 16/28**^(2006.01)

(21) P-2019-215

(22) 28.02.2017

(30) 201662301271 P 29.02.2016 US

(96) 17716593.3/28.02.2017

(86) IB PCT/IB2017/000293/28.02.2017

(87) WO 2017/149394/08.09.2017/2017/36

(97) EP 3423496/09.01.2019/2019/02

EP 3423496/03.07.2019/2019/27

(54) me **NE-ANTAGONISTIČKA ANTITELA USMERENA PROTIV ALFA LANCA
EKSTRACELULARNOG DOMENA IL7 RECEPTORA I NJIHOVA UPOTREBA U LEČENJU
KANCERA**
en **NON-ANTAGONISTIC ANTIBODIES DIRECTED AGAINST THE ALPHA CHAIN OF THE IL7
RECEPTOR EXTRACELLULAR DOMAIN AND USE THEREOF IN CANCER TREATMENT**

(73) OSE Immunotherapeutics

22 Boulevard Benoni Goullin, Nantes, 44200 / FR

(72) POIRIER, Nicolas

1 Chemin du Passe-Temps, Treillières, 44119/ FR

MARY, Caroline

7 Rue du Buisson, Sainte-Pazanne, 44680 / FR

(57)

1. Antitelo ili njegov antigen-vezujući fragment, koje sadrži sledeće CDR regione:

- VH-CDRI čija aminokiselinska sekvenca je Effi3-VH3-CDR1 prema SEQ ID No14;

- VH-CDR2 čija aminokiselinska sekvenca je Effi3-VH3-CDR2 prema SEQ ID No16;

- VH-CDR3 čija aminokiselinska sekvenca je Effi3-VH3-CDR3 prema SEQ ID No18;

- VL-CDR2 čija aminokiselinska sekvenca je Effi3-VL3-CDR2 prema SEQ ID No22;

- VL-CDR3 čija aminokiselinska sekvenca je Effi3-VL3-CDR3 prema SEQ ID No24; i

- VL-CDRI čija aminokiselinska sekvenca je Effi3-VL3-CDR1 prema SEQ ID No20 ili čija aminokiselinska sekvenca je Effi3-VL4-CDR1 prema SEQ ID No26,

pri čemu se antitelo ili njegov antigen-vezujući fragment specifično vezuje za ekstracelularni domen humanog CD127 i nije antagonist CD127.

Patent sadrži još 25 patentnih zahtjeva

(11) **03447** (13) **B**

(51) **A61K 39/00**^(2006.01)

C07K 16/28^(2006.01)

C07K 16/30^(2006.01)

(21) P-2019-216

(22) 01.03.2011

(30) 310692 P 04.03.2010 US

311057 P 05.03.2010 US

310695 P 04.03.2010 US

(96) 11751204.6/01.03.2011

(86) US PCT/US2011/026689/01.03.2011

(87) WO 2011/109400/09.09.2011/2011/36

(97) EP 2542256/09.01.2013/2013/02

EP 2542256/22.05.2019/2019/21

(54) me **ANTITELA REAKTIVNA SA B7-H3, NJIHOVI IMUNOLOŠKI AKTIVNI FRAGMENTI I UPOTREBA**

en **ANTIBODIES REACTIVE WITH B7-H3, IMMUNOLOGICALLY ACTIVE FRAGMENTS THEREOF AND USES THEREOF**

(73) MacroGenics, Inc.

9704 Medical Center Drive, Rockville, MD 20850/ US

(72) LOO, Deryk T.

1509 Pine Knoll Drive, Belmont, CA 94402/ US

HUANG, Ling

8210 Moorland Lane, Bethesda, MD 20817/ US

CHEN, Francine Zhifen

2660-31 St Ave, San Francisco, CA 94116/ US

MOORE, Paul A.

7013 Old Gate Road, North Bethesda, MD 20852/ US

JOHNSON, Leslie S.

14411 Poplar Hill Road, Darnestown, MD 20874/ US

(57)

1. B7-H3 vezujući molekul,pri čemu je navedeni B7-H3 vezujući molekul antitelo,ili njegov imunoreaktivni fragment,koji obuhvata varijabilni domen koji specifično vezuje ekstracelularni domen B7-H3, pri čemu navedeni B7-H3 vezujući molekul obuhvata:

(1) varijabilni domen lakog lanca koji obuhvata CDR1 sa sekvencom amino kiseline SEQ ID NO:

21,CDR2 sa sekvencom amino kiseline SEQ ID NO: 23 iCDR3 sa sekvencom amino kiseline SEQ ID NO: 25, i varijabilni domen teškog lanca koji obuhvata CDR1 sa sekvencom amino kiseline SEQ ID NO: 29,CDR2 sa sekvencom amino kiseline SEQ ID NO: 31i CDR3 sa sekvencom amino kiseline SEQ ID NO: 33;

(2) varijabilni domen lakog lanca koji obuhvata CDR1 sa sekvencom amino kiseline SEQ ID NO: S,

CDR2 sa sekvencom amino kiseline SEQ ID NO: 7 i CDR3 sa sekvencom amino kiseline SEQ ID NO:

9, i varijabilni domen teškog lanca koji obuhvata CDR1 sa sekvencom amino kiseline SEQ ID NO:

13,CDR2 sa sekvencom amino kiseline SEQ ID NO: 15 i COR3 sa sekvencom amino kiseline SEQ ID

NO: 17; ili

{3} varijabilni domen lakog lanca koji obuhvata CDR1 sa sekvencom amino kiseline SEQ ID NO:

37, CDR2 sa sekvencom amino kiseline SEQ ID NO: 39 i CDR3 sa sekvencom amino kiseline SEQ ID NO: 41, i varijabilni domen teškog lanca koji obuhvata CDR1 sa sekvencom amino kiseline SEQ ID NO: 45, CDR2 sa sekvencom amino kiseline SEQ ID NO: 47 i CDR3 sa sekvencom amino kiseline SEQ ID NO: 49.

Patent sadrži još 17 patentnih zahtjeva

(11) **03412** (13) **B**

(51) **C08L 27/16**^(2006.01)

C08L 81/04^(2006.01)

F16C 33/20^(2006.01)

C08L 71/00^(2006.01)

C08L 81/06^(2006.01)

C08L 27/18^(2006.01)

(21) P-2019-218

(22) 22.12.2014

(30) 102013227188 27.12.2013 DE

(96) 14827443.4/22.12.2014

(86) EP PCT/EP2014/079010/22.12.2014

(87) WO 2015/097160/02.07.2015/2015/26

(97) EP 3087142/02.11.2016/2016/44

EP 3087142/19.06.2019/2019/25

(54) me **SAMOPODMAZUJUĆI TERMOPLASTIČNI SLOJ SA DODATKOM PTFE SA
POLIMODALNOM MOLEKULSKOM TEŽINOM**

en **SELBSTSCHMIERENDE THERMOPLASTISCHE SCHICHTEN MIT ZUSATZ VON PTFE
MITPOLYMODALEM MOLEKULARGEWICHT**

(73) FEDERAL-MOGUL WIESBADEN GMBH

Stielstrasse 11, Wiesbaden, 65201/ DE

(72) ADAM, Achim

Alte Mainzerstrasse 3, 64569 Nauheim/ DE

FLEISCHHACKER, Norbert

Badegasse 18, 64653 Lorsch/ DE

(57)

1. Klizni element sa jednim metalnim zaštitnim slojem, sa jednim poroznim metalnim nosećim slojem postavljenim na zaštitni sloj i sa jednim kliznim materijalom postavljenim na porozni noseći sloj ili impregniranim u porozni noseći sloj, koji ima termoplastični materijal matrice i jedan dodatak PTFE, pri čemu dodatni PTFE ima najmanje dve različite vrste PTFE sa različitom molekularskom težinom.

Patent sadrži još 11 patentnih zahtjeva

(11) **03448** (13) **B**

(51) **A61K 9/08**^(2006.01)

A61K 47/40^(2006.01)

A61K 31/00^(2006.01)

A61K 47/18^(2006.01)

A61K 9/00^(2006.01)

C07D 417/12^(2006.01)

(21) P-2019-219

(22) 28.02.2013

(30) 102012101680 29.02.2012 DE

(96) 13707000.9/28.02.2013

(86) EP PCT/EP2013/054114/28.02.2013

(87) WO 2013/127970/06.09.2013/2013/36

(97) EP 2819648/07.01.2015/2015/02

EP 2819648/29.05.2019/2019/22

(54) me **FARMACEUTSKI PREPARAT KOJI OBUHVATA ANTIVIRUSNO EFIKASAN DERIVAT DIHIDROHINAZOLINA**
en **PHARMACEUTICAL PREPARATION CONTAINING AN ANTIVIRALLY DIHYDROQUINAZOLINE DERIVATIVE**

(73) AiCuris Anti-infective Cures GmbH

Friedrich-Ebert-Strasse 475, Wuppertal, 42117/ DE

(72) PAULUS, Kerstin

Hugo-Schlimm-Str. 65, Ratingen, 40882/ DE

SCHWAB, Wilfried

An den Hainbuchen 12, Werder (Havel), 14542 / DE

GRUNDER, Dominique

Schafmattstr. 11, Belp, CH-3123/ CH

VAN HOOGEVEST, Peter

Ägyptenpfad 22, Neustadt an der Weinstraße, 67433/ DE

(57)

1. Farmaceutskipreparat za intravenozno davanje,koji obuhvata sledeće,naime:

a) {8-fluor-2-[4-(3-metoksifenil)piperazin-1-il]-3-[2-metoksi-5-(trifluormetil)fenil]-3,4-dihidrohinaolin-4-il} sirćetnu kiselinu ili njenu so,solvat ili solvat soli,

b) ekscipijens odabran ciklodekstrinaa,i

e) vodu.

Patent sadrži još 19 patentnih zahtjeva

(11) **03449** (13) **B**

(51) **G07F1/04**^(2006.01)

(21) P-2019-220

(22) 05.01.2010

(30) 20092000228U 06.01.2009 DE

(96) 10000025.6/05.01.2010

(97) EP 2204781/07.07.2010/2010/27

EP 2204781/24.07.2019/2019/30

(54) me **NAPRAVA ZA USMERAVANJE**
en **GUIDING DEVICE**

(73) Novomatic AG

Wiener Strasse 158, Gumpoldskirchen , 2352 / AT

(72) Mührenberg, Roland

c/o I P& Rechtsabteilung, Gumpoldskirchen, 2352 / AT

Buchholz, Wiebke

c/o IP & Rechtsabteilung, Gumpoldskirchen, 2352 / AT

Zander, Marko

c/o IP & Rechtsabteilung, Gumpoldskirchen, 2352 / AT

(57)

1. Naprava (I) za vođenje, a naročito kovanica ili zamena za kovanice, za vođenje, usmeravanje i/ili promenu položaja ili lokacije kovanica ili zamena za kovanice, a naročito unutar automata, pri čemu se naprava (I) za usmeravanje sastoji od dva naspramna, međusobno razmaknuta, u suštini ravna osnovna lima (2, 3), koji pomoću distantnih elemenata (I O, 18) obrazuju stazu za kovanice ili zamene za kovanice, pri čemu distantni elementi (10) zahvataju u otvore (II) osnovnih limova (2, 3) i time međusobno fiksiraju osnovne limove (2, 3), pri čemu svaki od navedenih osnovnih limova (2, 3) ima prvu ravnu oblast (4, 5) u oblasti za ubacivanje naprave za usmeravanje, drugu ravnu oblast {6, 7} u oblasti za izbacivanje naprave za usmeravanje, kao i savijenu oblast (8, 9), pomoću koje su navedena prva i druga oblast (4, 5; 6, 7) međusobno spojene, i ravan za dovođenje kovanica je nagnuta u odnosu na ravan za odvođenje kovanica, naznačena time, što oblast za ubacivanje ima prvi kanal za kovanice čija širina je veća od širine drugog kanala za kovanice oblasti za izbacivanje, pri čemu se u gore navedenoj savijenoj oblasti (8, 9) između oblasti za ubacivanje i oblasti za izbacivanje širina kanala za kovanice gore navedenog prvog kanala za kovanice postepeno sužava do širine drugog kanala za kovanice.

Patent sadrži još 11 patentnih zahtjeva

(11) **03459** (13) **B**

(51) **C01B 32/15**^(2017.01)

B01J 21/18^(2006.01)

B82Y 30/00^(2011.01)

C09K 5/14^(2006.01)

H01M 4/92^(2006.01)

B01J 35/00^(2006.01)

B01J 37/02^(2006.01)

B01J 23/42^(2006.01)

B82Y 40/00^(2011.01)

H01B 1/04^(2006.01)

B01J 20/20^(2006.01)

(21) P-2019-221

(22) 16.09.2011

(30) 2005365 17.09.2010 NL

(96) 11760877.8/16.09.2011

(86) NL PCT/NL2011/050628/16.09.2011

(87) WO 2012/036555/22.03.2012/2012/12

(97) EP 2616391/24.07.2013/2013/30

EP 2616391/15.05.2019/2019/20

(54) me **UGLJENIČNE NANOSTRUKTURE I MREŽE PROIZVEDENE HEMIJSKOM DEPOZICIJOM IZ GASNE FAZE**
en **CARBON NANOSTRUCTURES AND NETWORKS PRODUCED BY CHEMICAL VAPOR DEPOSITION**

(73) CarbonX IP B.V.

Rembrandt Tower, 35th Floor, Amstelplein 1, 1096 HA Amsterdam/ NL

(72) KOWLGI, Krishna Narayan Kumar

Valorisation Centre, Postbus 5, NL-2600 AA Delft/ NL

KOPER, Gerardus Joseph Maria

Valorisation Centre, Postbus 5, NL-2600 AA Delft/ NL

VAN RAALTEN, Rutger Alexander David

Valorisation Centre, Postbus 5, NL-2600 AA Delft/ NL

(57)

1. Postupak za proizvodnju kristalnih ugljeničnih nanocevi i/ili mreže kristalnih ugljeničnih nanocevi, koji obuhvata

(i) obezbeđivanje dvokontinualne mikroemulzije koja sadrži metalne nanočestice prosečne veličine čestica između 1 i 100 nm, i gde su odstupanja veličine čestica od prosečne veličine čestica manja od 10%;

(ii) dovođenje pomenute dvokontinualne mikroemulzije u kontakt sa supstratom; i

(iii) izlaganje pomenutih metalnih nanočestica i gasovitog izvora ugljenika hemijskoj depoziciji iz parne faze, čime se obrazuju ugljenične nanocevi i/ili mreža ugljeničnih nanocevi.

Patent sadrži još 5 patentnih zahtjeva

(11) **03472** (13) **B**

(51) **C07D 413/12**^(2006.01)

C07D 498/04^(2006.01)

A61K 31/505^(2006.01)

C07D 417/12^(2006.01)

C07D 513/04^(2006.01)

A61P 11/06^(2006.01)

(21) P-2019-222

(22) 12.03.2015

(30) 201461955487 P 19.03.2014 US

(96) 15711451.3/12.03.2015

(86) EP PCT/EP2015/055228/12.03.2015

(87) WO 2015/140051/24.09.2015/2015/38

(97) EP 3119772/25.01.2017/2017/04

EP 3119772/22.05.2019/2019/21

(54) me **HETEROARILNI SIK INHIBITORI**
en **HETEROARYL SIK INHIBITORS**

(73) Boehringer Ingelheim International GmbH

Binger Strasse 173, Ingelheim am Rhein, 55216/ DE

(72) DAHMANN, Georg

Binger Str. 173, 55216 Ingelheim am Rhein/ DE

HOFFMANN, Matthias

Binger Str. 173, 55216 Ingelheim am Rhein/ DE

KLICIC, Jasna

Binger Str. 173, 55216 Ingelheim am Rhein/ DE

LAMB, David James

Binger Str. 173, 55216 Ingelheim am Rhein/ DE

MCCARTHY, Clive

Science Park Square, Falmer Brighton, BN1 9SB/ GB

NAPIER, Spencer

114 Milton Park, Milton, Abingdon Oxfordshire OX14 4SA/ GB

PARRISH, Karen

114 Milton Park, Milton, Abingdon Oxfordshire OX14 4SA/ GB

SCOTT, John

114 Milton Park, Milton, Abingdon Oxfordshire OX14 4SA/ GB

SWANTEK FITZGERALD, Jennifer L.

900 Ridgebury Road, P.O.Box 368, Ridgefield, Connecticut 06877-0368/ US

WALKER, Edward

114 Milton Park, Milton, Abingdon Oxfordshire OX14 4SA/ GB

(57)

1. Jedinjenje sa formulom 1

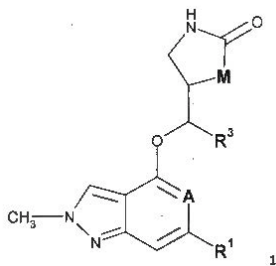

gdje

A je izabran iz grupe koja se sastoji od N i CH

i gdje

M je izabran iz grupe koja se sastoji od -CH₂-, -O-, -NH- i -N(C1-4-alkil)-;

R3 je izabran iz grupe koja se sastoji od metil i etil;

i gdje

R1 je izabran iz grupe koja se sastoji od

C6-10-aril, **Het** i **Hetaril**;

koji opciono je dalje supstituisan sa jednim, dva ili tri supstituenta **Z**,

pri čemu svaki **Z** je substituent odabran iz grupe koja se sastoji od

-OH, okso, -CN, halogen, -C1-6-alkil, -O-C1-6-alkil, -C1-6-haloalkil, tro- do sedmo-člani cikloalkil, **Het**, **Hetaril**, -CO-N(CH₃)₂, -CO-NHCH₃, -CO-NH₂, -(C1-3-alkilen)-O-(C1-3-alkil), -O-**Het**,

koji opciono je dalje supstituisan sa jednim, dva ili tri supstituenta **X**,

pri čemu svaki **X** je izabran iz grupe koja se sastoji od halogen, -OH, okso, -C1-4-alkil, -O-C1-4-alkil, -C1-4-haloalkil, -O-(C1-4-alkilen)-**Het**, **Het**, **Hetaril**, -NH₂, -NH(CH₃), -N(CH₃)₂ grupe,

pri čemu supstituent **X** je opciono dalje supstituisan sa jednim, dva ili tri supstituenta iz grupe izabrane od okso, -OH, halogen i C1-3-alkil,

i gdje

Het je izabran iz grupe koja se sastoji od

peto- do šesto-članog monocikličnog heterocikla sa 1, 2, 3 ili 4 heteroatoma svaki nezavisno jedan od drugog izabran od N, S i O,

devet- do jedanaesto-članog bicikličnog heterocikla sa 1, 2, 3 ili 4 heteroatoma svaki nezavisno jedan od drugog izabran od N, S i O;

Hetaril je izabran od grupe koja se sastoji od

peto- do šesto-članog monocikličnog heteroaromata sa 1, 2, 3 ili 4 heteroatoma svaki nezavisno jedan od drugog izabran od N, S i O;

devet- do jedanaesto-članog bicikličnog heteroaromata sa 1, 2, 3 ili 4 heteroatoma svaki nezavisno jedan od drugog izabran od N, S i O;

i farmaceutski prihvatljive soli gore pomenutih jedinjenja.

Patent sadrži još 33 patentnih zahtjeva

(11) **03471** (13) **B**

(51) **A61K 31/56**^(2006.01)

A61K 9/20^(2006.01)

A61K 45/06^(2006.01)

A61K 9/00^(2006.01)

A61K 9/06^(2006.01)

A61K 31/569^(2006.01)

(21) P-2019-223

(22) 30.09.2010

(30) 200924764209P 01.10.2009 US

(96) 18178891.0/30.09.2010

(97) EP 3403654/21.11.2018/2018/47

EP 3403654/31.07.2019/2019/31

(54) me **KORATKOSTEROIDNE KOMPOZICIJE ZA ORALNU ADMINISTRACIJU**
en **ORALLY ADMINISTERED CORTICOSTEROID COMPOSITIONS**

(73) Adare Development I, L.P.

1200 Lenox Drive, Suite 100, Lawrenceville, NJ 08648/ US

(72) PERRETT, Stephen

142 Leabrook Lane, Princeton, NJ 08540/ US

COHEN, Fredric Jay

52 Bailey Dr., Washington Crossing, PA 18977/ US

VENKATESH, Gopi M.

780 Waldsmith Way, Vandalia, OH 45377/ US

(57)

1.Oralno dispergirajuća tableta (ODT) koja sadrži manje od ili tačno 20 mg kortikosteroida, izabranog iz grupe koja se sastoji od flutikazona, flunizolida, ciklesonida, mometazona, beklometazona i solvata i njihovih estera, i najmanje jedno sredstvo za dispergiranje, pri čemu se ODT dezintegriše u roku od 60 sekundi u simuliranoj tečnosti pljuvačke kada se ispituje USP <701> Testom dezintegracije i pogodna je za lokalnu primenu kortikosteroida u jednjaku.

Patent sadrži još 14 patentnih zahtjeva

(11) **03463** (13) **B**

(51) **A61K35/74**^(2015.01)

A61P1/14^(2006.01)

A61P29/00^(2006.01)

(21) P-2019-224

(22) 12.12.2017

(30) 20160021123 12.12.2016 GB

(96) 17818220.0/12.12.2017

(86) GB PCT/GB2017/053722/12.12.2017

(87) WO 2018/109461/21.06.2018/2018/25

(97) EP 3359172/15.08.2018/2018/33

EP 3359172/12.06.2019/2019/24

(54) me **KOMPOZICIJE KOJE SADRŽE BAKTERIJSKE SOJEVE**
en **COMPOSITIONS COMPRISING BACTERIAL STRAINS**

(73) 4D PHARMA PLC

5th floor, 9 Bond Court, Leeds, LS1 2JZ / GB

(72) JEFFERY, Ian

Room 447 Food Science Building, University College Co Cork, Western Road, Cork/ IE
SHANAHAN, Fergus

Seafort Fort Hill, Kinsale, County Cork / IE

O'TOOLE, Paul

Room 447, Food Science Building, University College Co Cork, Western Road, Cork/ IE

STEVENSON, Alex

3rd Floor, 9 Bond Court, Leeds, Yorkshire LS1 2JZ/ GB

MULDER, Imke

Life Sciences, Innovation Building, Cornhill Road, Aberdeen, Aberdeenshire AB25 2ZS/ GB

SAVIGNAC, Helene

3rd Floor 9, Bond Court, Leeds, Yorkshire LS1 2JZ/ GB

(57)

1. Kompozicija koja sadrži bakterijski soj vrsta *Blautia hydrogenotrophica*, za upotrebu u lečenju ili prevenciji sindroma nervoznog creva, gde lečenje ili prevencija obuhvata povećanje diverziteta mikrobiote kod subjekta .

Patent sadrži još 12 patentnih zahtjeva

(11) **03464** (13) **B**

(51) **A61K 9/16**^(2006.01)

A61K 9/28^(2006.01)

C07D 405/12^(2006.01)

A61K 31/443^(2006.01)

A61K 9/20^(2006.01)

C07D 213/75^(2006.01)

C07D 405/14^(2006.01)

(21) P-2019-225

(22) 25.01.2013

(30) 201261590479 P 25.01.2012 US

201261651218 P 24.05.2012 US

201261691898 P 22.08.2012 US

201261708691 P 02.10.2012 US

(96) 13703243.9/25.01.2013

(86) US PCT/US2013/023100/25.01.2013

(87) WO 2013/112804/01.08.2013/2013/31

(97) EP 2806859/03.12.2014/2014/49

EP 2806859/15.05.2019/2019/20

(54) me **FORMULACIJE 3-(6-(1-(2.2-DIFLUOROBENZO[D][1,3]DIOKSOL-5-IL)
CIKLOPROPANKARBOKSAMIDO)-3-METILPIRIDIN-2-IL)BENZOJEVE KISELINE**
en **FORMULATIONS OF 3-(6-(1-(2.2-DIFLUOROBENZO[D][1,3]DIOXOL-5-YL)
CYCLOPROPANECARBOXAMIDO)-3-METHYLPYRIDIN-2-YL)BENZOIC ACID**

(73) Vertex Pharmaceuticals Incorporated
50 Northern Avenue , Boston, MA 02210/ US

(72) VERWIJIS, Marinus Jacobus
4 Carter Drive, Framingham, MA 01701/ US

(57)

1. Kontinualan postupak za pripremanje tablete koja sadrži jedinjenje 1kojisadržikorake:

a) mešanje jedinjenja 1,punioea,i sredstva za raspadanje u uređaju za mešanje da bi se dobila

b) pripremanje rastvora za granulaciju sa vodom, vezivnim sredstvom, i površinski aktivnim sredstvom;

c) dovođenje smeše iz koraka a) u kontinualni dvostruko vijačni granulator dok se dodaje rastvor za granulaciju iz koraka b) da bise proizvele granule;

d) sušenje granula iz koraka e) njihovo mlevenje;

e) mešanje samlevenih granula iz koraka d) sa punioeem,sredstvom za raspadanje,i lubrikansom da bise formirala smeša;i

f) sabijanje smeše iz koraka e) u tabletu;

gde je jedinjenje 13-(6-(1-(2,2-difluorobenzo[d](1,3)dioksol-5-il) ciklopropankarboksamido)-3-metilpiridin-2-il)benzojeva kiselina.

Patent sadrži još 4 patentnih zahtjeva

(11) **03460** (13) **B**

(51) **C07D 403/04**^(2006.01)

A61K 31/506^(2006.01)

C07D 471/04^(2006.01)

A61P 31/16^(2006.01)

(21) P-2019-226

(22) 12.11.2014

(30) 201361903572 P 13.11.2013 US

(96) 14802787.3/12.11.2014

(86) US PCT/US2014/065114/12.11.2014

(87) WO 2015/073476/21.05.2015/2015/20

(97) EP 3068776/21.09.2016/2016/38

EP 3068776/29.05.2019/2019/22

(54) me **INHIBITORI REPLIKACIJE VIRUSA INFLUENCE**
en **INHIBITORS OF INFLUENZA VIRUSES REPLICATION**

(73) Vertex Pharmaceuticals Incorporated

50 Northern Avenue , Boston, MA 02210/ US

(72) NTI-ADDAE, Kwame W.

19 Kensington Way, Tewksbury, MA 01876/ US

WALDO, Michael

4 Patricia Drive, Grafton, MA 01519/ US

O'NEIL, Simon Adam

77 Maple Street, Belmont, MA 02478/ US

VAN ALSTEN, John Gregg

3 Clearview Drive, Framingham, MA 01701/ US

MACIKENAS, Dainius

7 Clinton Street, Cambridge, MA 02139/ US

MUDUNURI, Praveen

77 Forest Street, Arlington, MA 02474 / US

SHI, Yi

80 Rathburn Road, Natick, MA 01760/ US

LEDEBOER, Mark Willem

36 Faulkner Hill Road, Acton, MA 01720/ US

JURKAUSKAS, Valdas

226 Brattle Street, Cambridge, MA 02138/ US

MEDEK, Ales

14 Lockland Road, Winchester, MA 01890/ US

JONES, Steven

68 Summer Street, Hyde Park, MA 02136/ US

BYRN, Randal

7 Pemberton Road, Wayland, MA 01778/ US

ASMAL, Mohammed

69 Fair Oaks Avenue, Newton, MA 02460/ US

ROBERTSON, Sarah Marie

55 Vernon Street 3, Somerville, MA 02145/ US

TSAI, Wanjung

205 Summer Street Apt. 3, Somerville, MA 02143/ US

(57)

1. Polimorfni oblik Jedinjenja (1), naznačeno time što je Jedinjenje (1) predstavljeno sledećom strukturnom formulom :

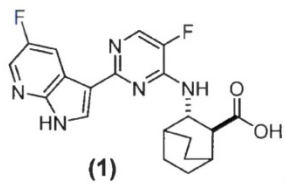

pri čemu je polimorfni oblik kristalna HCl so hemihidrata Jedinjenja (1), a navedeni polimorfni oblik se dalje karakteriše sa jednim ili više pikova koji odgovaraju vrednostima merenim u 2-teta stepenima za 10.5 ± 0.2 , 5.2 ± 0.2 , 7.4 ± 0.2 i 18.9 ± 0.2 pri difrakciji X-zraka praškastog uzorka

Patent sadrži još 23 patentnih zahtjeva

(11) **03467** (13) **B**

(51) **C07D 515/22**^(2006.01)

A61P 35/00^(2006.01)

A61K 31/4995^(2006.01)

(21) P-2019-227

(22) 27.04.2018

(30) 17382228 27.04.2017 EP

17382497 26.07.2017 EP

(96) 18382288.1/27.04.2018

(97) EP 3395821/31.10.2018/2018/44

EP 3395821/15.05.2019/2019/20

(54) me **ANTITUMORSKA JEDINJENJA**

en **ANTITUMORAL COMPOUNDS**

(73) Pharma Mar, S.A.

Avenida de los Reyes, 1, Polígono Industrial La Mina, 28770 Colmenar Viejo, Madrid/ ES

(72) CUEVAS MARCHANTE, María del Carmen

Avenida de los Reyes, 1, Polígono Industrial La Mina, E-28770 Colmenar Viejo, Madrid/ ES

FRANCESCH SOLLOSO, Andrés

Avenida de los Reyes, 1, Polígono Industrial La Mina, E-28770 Colmenar Viejo, Madrid/ ES

MARTÍNEZ BARRASA, Valentín

Avenida de los Reyes, 1, Polígono Industrial La Mina, E-28770 Colmenar Viejo, Madrid/ ES

(57)

I. Jedinjenje sa formulom **I**, ili njegova farmaceutska prihvatljiva so ili estar:

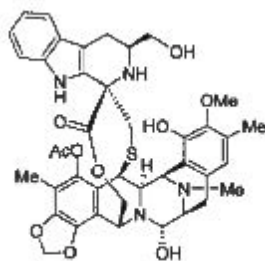

Formula I.

Patent sadrži još 11 patentnih zahtjeva

(11) **03466** (13) **B**

(51) **C07D 515/22**^(2006.01)

A61P 35/00^(2006.01)

A61K 31/4995^(2006.01)

(21) P-2019-228

(22) 27.04.2018

(30) 17382228 27.04.2017 EP

17382497 26.07.2017 EP

(96) 18382287.3/27.04.2018

(97) EP 3395820/31.10.2018/2018/44

EP 3395820/15.05.2019/2019/20

(54) me **ANTITUMORSKA JEDINJENJA**

en **ANTITUMORAL COMPOUNDS**

(73) Pharma Mar S.A.

Avda. de los Reyes, 1, Polígono Industrial La Mina, 28770 Colmenar Viejo, Madrid/ ES

(72) CUEVAS MARCHANTE, María del Carmen

Avenida de los Reyes, 1, Polígono Industrial La Mina, E-28770 Colmenar Viejo, Madrid/ ES

FRANCESCH SOLLOSO, Andrés

Avenida de los Reyes, 1, Polígono Industrial La Mina, E-28770 Colmenar Viejo, Madrid/ ES

MARTÍNEZ BARRASA, Valentín

Avenida de los Reyes, 1, Polígono Industrial La Mina, E-28770 Colmenar Viejo, Madrid/ ES

(57)

I. Jedinjenje sa formulom V, ili njegova farmaceutski prihvatljiva so ili estar:

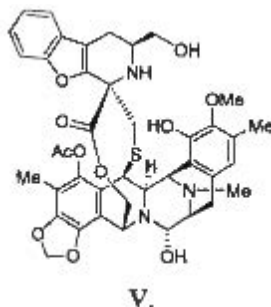

Patent sadrži još 14 patentnih zahtjeva

(11) **03465** (13) **B**

(51) **A61K 31/135**^(2006.01)

A61K 47/12^(2006.01)

A61K 9/00^(2006.01)

A61P 25/24^(2006.01)

(21) P-2019-229

(22) 14.03.2014

(30) 201361791505 P 15.03.2013 US

(96) 14719471.6/14.03.2014

(86) US PCT/US2014/027074/14.03.2014

(87) WO 2014/143646/18.09.2014/2014/38

(97) EP 2968221/20.01.2016/2016/03

EP 2968221/19.06.2019/2019/25

(54) me **FARMACEUTSKA KOMPOZICIJA S-KETAMIN HIDROHLORIDA**
en **PHARMACEUTICAL COMPOSITION OF S-KETAMINE HYDROCHLORIDE**

(73) Janssen Pharmaceutica NV

Turnhoutseweg 30, 2340 Beerse/ BE

(72) BASSTANIE, Esther D. G.

Nazarethpad 34, B-2240 Zandhoven/ BE

BENTZ, Johanna

36036 Bayonne Drive, Newark, California 94560/ US

EMBRECHTS, Roger C.A.

Sperwersweg 5, B-2360 Oud-Turnhout/ BE

NIEMEIJER, Nico Rudolph

Biesvelden 8, NL-5685 JB Best/ NL

(57)

1. Farmaceutska kompozicija koja obuhvata S-ketamin hidrohlorid i vodu; pri čemu farmaceutska kompozicija ne obuhvata antimikrobnikonzervans;

pri čemu S-ketamin hidrohlorid se nalazi u koncentraciji od najmanje ekv. 120 mg/ml, na osnovu ukupne zapremine kompozicije.

Patent sadrži još 14 patentnih zahtjeva

(11) **03462** (13) **B**

(51) **C07H 19/173**^(2006.01)

A61K 31/7076^(2006.01)

A61P 35/00^(2006.01)

(21) P-2019-230

(22) 27.11.2015

(30) 201421211 28.11.2014 GB

201519316 02.11.2015 GB

(96) 15804216.8/27.11.2015

(86) US PCT/GB2015/053628/27.11.2015

(87) WO 2016/083830/02.06.2016/2016/22

(97) EP 3224268/04.10.2017/2017/40

EP 3224268/26.06.2019/2019/26

(54) me **NOVI 2' I/ILI 5' DERIVATI 3'-DEOKSI ADENOZINA SUPSTITUISANI AMINOKISELINSKIM ESTROM FOSFORAMIDATA, KAO ANTIKANCERSKA JEDINJENJA**
en **NEW 2' AND/OR 5' AMINO-ACID ESTER PHOSPHORAMIDATE 3'-DEOXY ADENOSINE DERIVATIVES AS ANTI-CANCER COMPOUNDS**

(73) NuCana plc

77-78 Cannon Street, London EC4N 6AF/ GB

(72) GRIFFITH, Hugh

PO Box 10, Lochside Place, Edinburgh EH12 9RG/ GB

MCGUIGAN, Christopher

Cardiff University, Redwood Building, King Edward VII Avenue, Cardiff South Glamorgan CF10 3NB/ GB

FERRARI, Valentina

Cardiff University, Redwood Building, King Edward VII Avenue, Cardiff South Glamorgan CF10 3NB/ GB

SERPI, Michaela

Cardiff University, Redwood Building, King Edward VII Avenue, Cardiff South Glamorgan CF10 3NB/ GB

JIMENEZ ANTUNEZ, Carmen

Cardiff University, Redwood Building, King Edward VII Avenue, Cardiff South Glamorgan CF10 3NC/ GB

(57)

I. 3'-Deoksiadenozin-5'-O-[fenil(benziloksi-L-alaninil)] fosfat

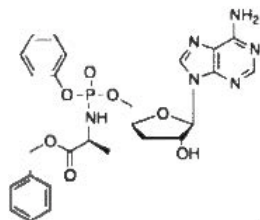

ili farmaceutski prihvatljiva so, estar, so estra ili solvat njegovogjedinjenja.

Patent sadži još 13 patentnih zahtjev

(11) **03493** (13) **B**

(51) **A61P 35/00**^(2006.01)
C07K 16/28^(2006.01)

A61K 39/395^(2006.01)

(21) P-2019-231

(22) 12.05.2015

(30) 201461992658P 13.05.2014 US

201562105992P 21.01.2015 US

201562114336P 10.02.2015 US

(96) 15722195.3/12.05.2015

(86) EP PCT/EP2015/060523/12.05.2015

(87) WO 2015/173267/19.11.2015/2015/46

(97) EP 3142751/22.03.2017/2017/12

EP 3142751/07.08.2019/2019/32

(54) me **ANTI-B7-H1 I ANTI-CTLA-4 ANTITIJELA ZA TRETMAN NESITNOĆELIJSKOG KANCERA PLUĆA**
en **ANTI-B7-H1 AND ANTI-CTLA-4 ANTIBODIES FOR TREATING NON-SMALL CELL LUNG CANCER**

(73) MedImmune Limited

Milstein Building, Granta Park, Cambridge, Cambridgeshire CB21 6GH / GB

(72) NARWAL, Rajesh

One MedImmune Way , Gaithersburg Maryland 20878/ US

ROBBINS, Paul

One MedImmune Way , Gaithersburg Maryland 20878/ US

KARAKUNNEL, Joyson

One MedImmune Way , Gaithersburg Maryland 20878/ US

DAR, Mohammed M.

One MedImmune Way , Gaithersburg Maryland 20878/ US

(74) Advokat RADULOVIĆ, Božidar S.

Studentska bb, Lamela 3/18 , Podgorica, 81000 / ME

(57)

1. Kombinacija koja sadrži MEDI4736, ili njegov fragment koji vezuje antigen, i tremelimumab ili njegov fragment koji vezuje antigen, za upotrebu u lečenju NSCLC kod humanog pacijenta, pri čemu se MEDI-4736 daje u dozi od 20 mg/kg na svake 4 nedelje, a tremelimumab se daje pacijentu u dozi od 1 mg/kg.

Patent sadrži još 16 patentnih zahtjeva

(11) **03494** (13) **B**

(51) **C07K 14/575**^(2006.01)

C07K 14/605^(2006.01)

A61K 38/26^(2006.01)

(21) P-2019-238

(22) 05.01.2016

(30) 201562101488P 09.01.2015 US

(96) 16703620.1/05.01.2016

(86) US PCT/US2016/012124/05.01.2016

(87) WO 2016/111971/14.07.2016/2016/28

(97) EP 3242887/15.11.2017/2017/46

EP 3242887/14.08.2019/2019/33

(54) me **SPOJEVI KOJI SU SUAGONISTI GIP I GLP-1**
en **GIP AND GLP-1 CO-AGONIST COMPOUNDS**

(73) Eli Lilly and Company

Lilly Corporate Center, Indianapolis, IN 46285/ US

(72) ALSINA-FERNANDEZ, Jorge

P.O. Box 6288 , Indianapolis, Indiana 46206-6288/ US

BOKVIST, Bengt Krister

P.O. Box 6288 , Indianapolis, Indiana 46206-6288/ US

COSKUN, Tamer

P.O. Box 6288 , Indianapolis, Indiana 46206-6288/ US

CUMMINS, Robert Chadwick

P.O. Box 6288 , Indianapolis, Indiana 46206-6288/ US

(74) AOD "ČUPIĆ"

Bulevar Džordža Vašingtona 79, Podgorica, 81000/ ME

(57)

1. Spoj Formule: YX1EGTFTSDYSIX2LDKIAQKAX3VQWLIAGGPSSGAPPPS;

naznačen time što

X1 je Aib;

X2 je Aib;

K na položaju 20 je kemijski modificiran konjugacijom ϵ -amino skupinom iz bočnog lanca K s ([2-(2-aminoetoksi)etoksi]acetil)2-(γ Glu)a-CO-(CH₂)^b-CO₂H, gdje je a 1 do 2, a b je 10 do 20;

X3 je Phe ili 1-Nal;

i C-terminalna aminokiselina može biti amidirana kao C-terminalni primarni amid (SEQ ID NO: 11), ili njegova farmaceutski prihvatljiva sol.

Patent sadrži još 15 patentnih zahtjeva

(11) **03473** (13) **B**

(51) **A61K 38/55**^(2006.01)

A61K 39/395^(2006.01)

A61P 9/00^(2006.01)

A61P 11/06^(2006.01)

A61P 9/10^(2006.01)

A61P 1/00^(2006.01)

A61P 37/06^(2006.01)

A61P 31/04^(2006.01)

A61P 31/12^(2006.01)

A61K 39/42^(2006.01)

C07K 19/00^(2006.01)

A61P 29/00^(2006.01)

A61P 11/00^(2006.01)

A61P 35/00^(2006.01)

A61P 19/02^(2006.01)

A61P 3/10^(2006.01)

A61P 21/00^(2006.01)

A61P 31/10^(2006.01)

A61K 39/40^(2006.01)

(21) P-2019-253

(22) 28.06.2012

(30) 201161502055 P 28.06.2011 US

201161570394 P 14.12.2011 US

201161577204 P 19.12.2011 US

201261638168 P 25.04.2012 US

(96) 12804863.4/28.06.2012

(86) US PCT/US2012/044730/28.06.2012

(87) WO 2013/003641/03.01.2013/2013/01

(97) EP 2726092/07.05.2014/2014/19

EP 2726092/19.06.2019/2019/25

(54) me **FUZIONI POLIPEPTIDI NA BAZI SERPINA I POSTUPCI ZA NJIHOVU UPOTREBU**
en **SERPIN FUSION POLYPEPTIDES AND METHODS OF USE THEREOF**

(73) Inhibrx, LP

11099 N. Torrey Pines Road, Suite 130, La Jolla, CA 92037/ US

(72) ECKELMAN, Brendan P.

11099 N. Torrey Pines Road Suite 130, La Jolla, CA 92037/ US

TIMMER, John C.

11099 N. Torrey Pines Road Suite 130, La Jolla, CA 92037/ US

NGUY, Peter L.

11099 N. Torrey Pines Road Suite 130, La Jolla, CA 92037/ US

GUENTHER, Grant B.

11099 N. Torrey Pines Road Suite 130, La Jolla, CA 92037/ US

DEVERAUX, Quinn

11099 N. Torrey Pines Road Suite 130, La Jolla, CA 92037/ US

(57)

I. Izolovani fuzioni protein koji sadrži najmanje jedan humani polipeptid alfa-I antitripsin (AAT) koji sadrži aminokiselinsku sekvencu izabranu iz grupe koja se sastoji od SEQ ID NO:1, SEQ ID NO: 2, SEQ ID NO: 32 i SEQ ID NO: 33, u kome je polipeptid AAT funkcionalno povezan sa imunoglobulinskim Fe polipeptidom, naznačen time, što izolovani fuzioni protein ispoljava aktivnost inhibicije serin proteaze i namenjen je upotrebi u postupku za lečenje bolesti ili poremećaja kod subjekta odabranog od nedostatka AAT, emfizema, hronične opstruktivne bolesti pluća (COPD), akutnog respiratornog distres sindroma (ARDS), alergijske astme, cistične fibroze, kancera pluća, ishemijsko-

reperfuzione povrede, ishemijsko/reperfuzione povrede nakon transplantacije srca, infarkta miokarda, reumatoidnog artritisa, septičkog artritisa, psorijaznog artritisa, ankiloznog spondilitisa, Kronove bolesti, psorijaze, dijabetesa tipa I i/ili tipa II, pneumonije, sepse, bolesti kaJam-protiv-domaćina (GVHD), zarastanja rane, sistemskog eritemskog lupusa i multiple skleroze.

Patent sadži još 11 patentnih zahtjeva

(11) **03407** (13) **B**

(51) **C07K 14/725**^(2006.01)

A61P 35/00^(2006.01)

C07K 14/47^(2006.01)

A61K 35/26^(2006.01)

(21) P-2019-67

(22) 30.03.2015

(30) PCT/EP2014/000868 01.04.2014 WO

PCT/EP2014/072864 24.10.2014 WO

(96) 15712657.4/30.03.2015

(86) EP PCT/EP2015/056899/30.03.2015

(87) WO 2015/150327/08.10.2015/2015/40

(97) EP 3126381/08.02.2017/2017/06

EP 3126381/16.01.2019/2019/03

(54) me **KLAUDIN-6 SPECIFIČNI IMUNORECEPTORI I T-ĆELIJSKI EPITOPI**
en **CLAUDIN-6-SPECIFIC IMMUNORECEPTORS AND T CELL EPITOPES**

(73) Biontech Cell&Gene Therapies GmbH

An der Goldgrube 12, Mainz, 55131/ DE

TRON - Translationale Onkologie an der Universitätsmedizin der Johannes Gutenberg- Universität Mainz
gemeinnützige GmbH

Freiligrathstrasse 12, Mainz, 55131/ DE

Ganymed Pharmaceuticals GmbH

An der Goldgrube 12, Mainz, 55131 / DE

(72) SAHIN , Ugur

Philipp von Zabernplatz 1, Mainz, 55116/ DE

TÜRECI, Özlem

Philipp von Zabernplatz 1, Mainz, 55116/ DE

SIMON, Petra

Silvanerstrasse 33A, Mainz, 55129/ DE

OMOKOKO, Tana

Franz-Werfel-Str. 20, Mainz, 55116/ DE

HOFF, Holger

Tieckstrasse 22, Berlin, 10115 / DE

VOSS, Ralf-Holger

Lotharstrasse 32, Ingelheim, 55218 / DE

BREITKREUZ, Andrea

Trifelsstrasse 47, Worms, 67551/ DE

HOBOHM, Kathleen

Johann Strausstrasse 18, Kelkheim i. Ts., 65779 / DE

MROZ, Karolina, Anna

Zietenring 3, Wiesbaden, 65195/ DE

(57)

1. Peptid koji sadrži aminokiselinsku sekvencu izabranu iz grupe koja se sastoji od SEK ID BR: 3, 4 i 5, naznačen time, da je pomenuti peptid dužine l OO aminokiselina ili manje, 50 aminokiselina ili manje, 20 aminokiselina ili manje, ili l O aminokiselina ili manje.

Patent sadrži još 18 patentnih zahtjeva

(11) 3372 (13) B

(51) C07D 401/10^(2006.01)

C07D 405/14^(2006.01)

C07D 413/14^(2006.01)

C07D 498/08^(2006.01)

A61K 31/444^(2006.01)

C07D 401/14^(2006.01)

C07D 413/10^(2006.01)

C07D 417/14^(2006.01)

A61K 31/506^(2006.01)

A61P 25/28^(2006.01)

(21) P-2019-69

(22) 03.10.2012

(30) 2011222741 07.10.2011 JP

(96) 12781479.6/03.10.2012

(86) US PCT/JP2012/076257/03.10.2012

(87) WO 2013/054822/18.04.2013/2013/16

(97) EP 2763979/13.08.2014/2014/33

EP 2763979/26.12.2018/2018/52

(54) me **JEDINJENJA 1-ARILKARBONIL-4-OKSIPIPERIDINA KORISNA ZA TRETMAN NEURODEGENERATIVNIH BOLESTI**

en **1 - ARYLCARBONYL - 4 - OXY - PIPERIDINE COMPOUNDS USEFUL FOR THE TREATMENT OF NEURODEGENERATIVE DISEASES**

(73) Takeda Pharmaceutical Company Limited

1-1 Doshomachi 4-chome Chuo-ku, Osaka-shi, Osaka 541-0045/ JP

(72) , KOIKE, Tatsuki

c/o TAKEDA PHARMACEUTICAL COMPANY LIMITED 26-1 Muraoka-Higashi 2-chome, Fujisawa-shi Kanagawa 251-0012/ JP

, YOSHIKAWA, Masato

c/o TAKEDA PHARMACEUTICAL COMPANY LIMITED 26-1 Muraoka-Higashi 2-chome, Fujisawa-shi Kanagawa 251-0012/ JP

, ANDO, Haruhi

c/o TAKEDA PHARMACEUTICAL COMPANY LIMITED 26-1 Muraoka-Higashi 2-chome, Fujisawa-shi Kanagawa 251-0012/ JP

, FARNABY, William John

c/o TAKEDA CAMBRIDGE LIMITED 418 Cambridge Science Park, Cambridge CB4 0PA/ GB

(57)

1. Jedinjenje predstavljeno formulom (I):

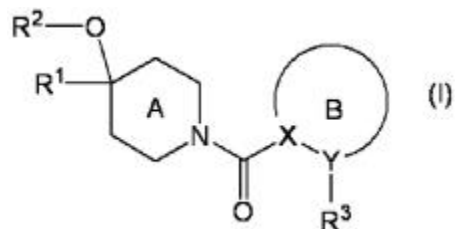

pri čemu

R¹ je C1-6 alkil grupa opciono supstituisana sa 1 do 3 supstituenta izabrana od

(1) C6-14 aril grupe opciono supstituisane sa 1 do 3 supstituenta izabrana od

- (a) atoma halogena,
- (b) cijano grupe i
- (c) C1-6 alkoksi grupe opciono supstituisane sa 1 do 3 atoma halogena

(2) 5- ili 6-člane monociklične aromatične heterociklične grupe opciono supstituisane sa 1 do 3 supstituenta izabrana od

- (a) atoma halogena,
- (b) cijano grupe i
- (c) C1-6 alkoksi grupe opciono supstituisane sa 1 do 3 atoma halogena i

(3) 3- do 8-člane monociklične alifatične heterociklične grupe opciono supstituisane sa 1 do 3 supstituenta izabrana od

- (a) atoma halogena,
- (b) cijano grupe i
- (c) C1-6 alkoksi grupe opciono supstituisane sa 1 do 3 atoma halogena;

R2 je atom vodonika ili C1-6 alkil grupa;

R3 je 5- ili 6-člana aromatična heterociklična grupa sa azotom opciono supstituisana sa 1 do 3 atoma halogena;

prsten A je piperidin prsten koji nema druge supstituente osim R1, R2-O- i -C(=O)-prsten B, ili oksa-9-

azabiciklo[3.3.1]nonan prsten koji nema druge supstituente osim R1, R2-O- i -C(=O)-prsten B; i

prsten B je 5- ili 6-člani aromatični prsten (X i Y su nezavisno atom ugljenika ili atom azota), koji je, osim na R3 i -C(=O)-prsten A, opciono supstituisan sa 1 do 3 supstituenta izabrana od

- (1) atoma halogena,
- (2) C1-6 alkil grupe opciono supstituisane sa 1 do 3 atoma halogena,
- (3) C1-6 alkoksi grupe i
- (4) C1-6 alkenilendioksi grupe.

ili njegova so.

Patent sadrži još 14 patentnih zahtjeva

(11) **03373** (13) **B**

(51) **C07C253/04**^(2006.01)

C07D249/18^(2006.01)

A01N43/707^(2006.01)

A01N37/34^(2006.01)

C07C255/42^(2006.01)

A61K31/4192^(2006.01)

A61P33/00^(2006.01)

(21) P-2019-70

(22) 12.05.2008

(30) 20070930485P 15.05.2007 US

(96) 16156007.3/12.05.2008

(97) EP 3088384/02.11.2016/2016/44

EP 3088384/12.12.2018/2018/50

(54) me **ARILAOZOL-2-IL CIJANOETILAMINO JEDINJENJA, POSTUPCI DOBIJANJA I POSTUPCI NJIHOVE PRIMENE**

en **ARYLOAZOL-2-YL CYANOETHYLAMINO COMPOUNDS, METHOD OF MAKING AND METHOD OF USING THEREOF**

(73) Merial, Inc.

Duluth, GA 30096/ US

Aventis Agriculture

, 75008 Paris/ FR

(72) SOLL, Mark David

, Alpharetta, Georgia 30005/ US

LE HIR DE FALLOIS, Loic Patrick

, Atlanta, Georgia 30305/ US

HUBER, Scot Kevin

, Raleigh, North Carolina 27612/ US

LEE, Hyoung Ik

, Cary, North Carolina 27519/ US

Boehringer Ingelheim Animal Health USA Inc.

3239 Satellite Boulevard, Bldg. 500 Duluth,, GA 30096/ US

JACOBS, Robert Toms

, Wake Forest, North Carolina 27587/ US

(57)

1. Paraziticidalna kompozicija u obliku injektabilne formulacije, naznačena time što navedena kompozicija sadrži jedinjenje ariloazol-2-ilcijanoetilamina formule (I):

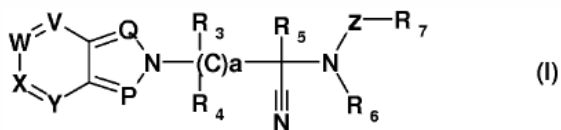

gde:

P je C-R1 ili N;

Q je C-R2 ili N;

V je C-R8 ili N;

W je C-R9 ili N;

X je C-R10 ili N;

Y je C-R11 ili N;

R1; R2, R8, R9, R10 i R11 svaki, međusobno nezavisno, je vodonik, amino, amido, cijano, nitro, halogen, alkil, alkenil, alkinil, cikloalkil, hidroksialkil, haloalkil, alkiltio, haloalkiltio, ariltio, alkoksi, fenoksi, alkoksialkoksi, cikloalkiloksi, haloalkoksi, alkilkarbonil, haloalkilkarbonil, alkilsulfinil, haloalkilsulfinil, alkilsulfonyl, alkilamin, di(alkil)amino, alkilkarbonilamino, alkilaminoalkoksi, dialkilaminoalkoksi, alkilaminoalkil, dialkilaminoalkil, aminoalkil, formil, HO₂C-, alkil-O₂C-, nesupstituisan ili supstituisan aril ili nesupstituisan ili supstituisan fenoksi, pri čemu supstituenti svaki mogu biti međusobno nezavisni i izabrani su iz grupe koja se sastoji od cijano, nitro, halogena, alkila, haloalkila, alkiltio, haloalkiltio, ariltio, alkoksi, haloalkoksi, alkilkarbonila, haloalkilkarbonila, alkilsulfinila, haloalkilsulfinila, alkilsulfonyla, haloalkilsulfonyla;

R3, R4 i R5 svaki, međusobno nezavisno, je vodonik, halogen, alkil, hidroksialkil, alkiltioalkil, haloalkil, alkiloksialkil, alkilsulfinilalkil, alkilsulfonylalkil, alkilsulfonyloksialkil; nesupstituisan ili supstituisan cikloalkil, pri čemu supstituenti mogu svaki biti međusobno nezavisni i izabrani su iz grupe koja se sastoji od halogena i alkila; nesupstituisan ili supstituisan fenil, pri čemu supstituenti mogu svaki biti međusobno nezavisni i izabrani su iz grupe koja se sastoji od cijano, nitro, halogena, alkila, haloalkila, alkiltio, haloalkiltio, ariltio, alkoksi, haloalkoksi, alkilkarbonila, haloalkilkarbonila, alkilsulfinila, haloalkilsulfinila, alkilsulfonyla, haloalkilsulfonyla, alkilamina, di(alkil)amino; ili

R4 i R5 zajedno sa ugljenikom za koji su vezani formiraju cikloalkil prsten;

R6 je vodonik, alkil, alkoksialkil, alkilkarbonil, alkiltiokarbonil ili nesupstituisan ili supstituisan benzil, pri čemu supstituenti mogu svaki biti međusobno nezavisni i izabrani su iz grupe koja se sastoji od cijano, nitro, halogena, alkila, haloalkila, alkiltio, haloalkiltio, ariltio, alkoksi, haloalkoksi, alkilkarbonila, haloalkilkarbonila, alkilsulfinila, haloalkilsulfinila, alkilsulfonyla, haloalkilsulfonyla, alkilamina, di(alkil)amino;

R7 je vodonik, alkil, alkoksialkil, alkilkarbonil, alkiltiokarbonil ili nesupstituisan ili supstituisan fenil gde supstituenti mogu svaki biti međusobno nezavisni i izabrani su iz grupe koja se sastoji od cijano, nitro, halogena, alkila, haloalkila, fenila, fenoksi, alkiltio, haloalkiltio, ariltio, alkoksi, haloalkoksi, alkilkarbonila, haloalkilkarbonila, alkilsulfinila, haloalkilsulfinila, alkilsulfonyla, haloalkilsulfonyla, alkilamina, di(alkil)amino;

nesupstituisan ili supstituisan hetaril, pri čemu supstituenti svaki mogu biti međusobno nezavisni i izabrani su iz grupe koja se sastoji od cijano, nitro, halogena, alkila, haloalkila, alkiltio, haloalkiltio, ariltio, alkoksi, haloalkoksi, alkilkarbonila, haloalkilkarbonila, alkilsulfinila, haloalkilsulfinila, alkilsulfonyla, alkilamina, di(alkil)amino; ili

nesupstituisan ili supstituisan naftil ili hinolil, pri čemu supstituenti mogu svaki biti međusobno nezavisni i izabrani su iz grupe koja se sastoji od cijano, nitro, halogena, alkila, haloalkila, alkiltio, haloalkiltio, ariltio, alkoksi, haloalkoksi, alkilkarbonila, haloalkilkarbonila, alkilsulfinila, haloalkilsulfinila, alkilsulfonyla, alkilamina, di(alkil)amino;

Z je direktna veza, C(O), C(S) ili S(O)_p;

a je 1, 2 ili 3;

p je 0, 1 ili 2; i njegove soli.

Patent sadrži još 19 patentnih zahtjeva

(11) **03442** (13) **B**

(51) **A61K 39/155**^(2006.01)

C07K 14/135^(2006.01)

(21) P-2019-73

(22) 24.04.2014

(30) 20130165402 25.04.2013 EP

(96) 14719022.7/24.04.2014

(86) EP PCT/EP2014/058353/24.04.2014

(87) WO 2014/174018/30.10.2014/2014/44

(97) EP 2988780/02.03.2016/2016/09

EP 2988780/26.12.2018/2018/52

(54) me **STABILIZOVANI RASTVORLJIVI PRE-FUZIONI RSV F POLIPEPTIDI**
en **STABILIZED SOLUBLE PREFUSION RSV F POLYPEPTIDES**

(73) Janssen Vaccines & Prevention B.V.

Archimedesweg 4, 2333 CN Leiden/ NL

(72) LANGEDIJK, Johannes Petrus Maria

Archimedesweg 4-6, 2333 CN Leiden/ NL

KRARUP, Anders

Archimedesweg 4-6, 2333 CN Leiden/ NL

(57)

1. Rekombinantni pre-fuzioni Fuzioni (F) polipeptid respiratornog sincicijskog virusa (RSV), koji sadrži najmanje jedan epitop koji je specifičan za pre-fuzioni konformacioni F protein, gde je najmanje jedan epitop prepoznat od strane pre-fuzionog specifičnog monoklonskog antitela, koji sadrži CDRI region teškog lanca od SEQ ID NO: 54, CDR2 region teškog lanca od SEQ ID NO: 55, CDR3 region teškog lanca od SEQ ID NO: 56 i CDRI region lakog lanca od SEQ ID NO: 62, CDR2 region lakog lanca od SEQ ID NO: 63, i CDR3 region lakog lanca od SEQ ID NO: 64 i/ili pre-fuziono specifično monoklonsko antitelo, koje sadrži CDRI region teškog lanca od SEQ ID NO: 58, CDR2 region teškog lanca od SEQ ID NO: 59, CDR3 region teškog lanca od SEQ ID NO: 60 i CDRI region lakog lanca od SEQ ID NO: 66, CDR2 region lakog lanca od SEQ ID NO: 67, i CDR3 region lakog lanca od SEQ ID NO: 68, gde polipeptid sadrži mutaciju aminokiselinskog ostatka N¹f na položaju 67 u I, i/ili mutaciju aminokiselinskog ostatka S na položaju 215 u P, gde su položaji aminokiselina dati u odnosu na sekvencu od RSV F proteina iz A2 soja (SEQ ID NO: I).

Patent sadrži još 17 patentnih zahtjeva

(11) **03443** (13) **B**

(51) **B01D 21/30**^(2006.01)

C02F 1/00^(2006.01)

C02F 1/76^(2006.01)

C02F 1/24^(2006.01)

C02F 1/50^(2006.01)

C02F 1/72^(2006.01)

C02F 5/08^(2006.01)

C02F 103/02^(2006.01)

C02F 103/10^(2006.01)

B01D 61/04^(2006.01)

C02F 1/52^(2006.01)

C02F 9/02^(2006.01)

C02F 1/44^(2006.01)

C02F 1/56^(2006.01)

C02F 1/78^(2006.01)

C02F 101/20^(2006.01)

C02F 103/08^(2006.01)

(21) P-2019-74

(22) 12.09.2011

(30) 201161469537 P 30.03.2011 US

201113136474 08.01.2011 US

(96) 16198842.3/12.09.2011

(97) EP 3156111/19.04.2017/2017/16

EP 3156111/12.12.2018/2018/50

(54) me **POSTUPAK ZA PREČIŠĆAVANJE VODE KOJI SE KORISTI ZA INDUSTRIJSKE SVRHE**
en **METHOD FOR TREATING WATER USED FOR INDUSTRIAL PURPOSES**

(73) Crystal Lagoons (Curaçao) B.V.

Kaya W.F.G. (Jombi), Mensing 14/ CW

(72) Fischmann, T. Fernando

Avenida Kennedy, 8830 Vitacura, Santiago/ CL

(57)

I. Postupak za prečišćavanje vode pri niskim troškovima, gde postupak prečišćava vodu i uklanja suspendovane čestice u vodi filtriranjem male količine ukupne zapremine vode, koji postupak obuhvata:

a. Sakupljanje vode sa koncentracijom ukupne rastvorene supstance (IDS) do 60,000 ppm;

b. Čuvanje navedene vode u bar jednom sredstvu za sakupljanje (8), gde navedena sredstva (8) za sakupljanje imaju dno (17) koje je u stanju da se čisti sa pokretnim sredstvima za crpljenje (5) i gde navedena sredstva za sakupljanje imaju zapreminu od bar 15.000 m³;

c. U okvi ru perioda od 7 dana:

i. Za temperature vode do 35 stepeni Celzijusa, održavanje ORP navedene vode od bar 500 mV za minimalni period od 1 sata za svaki stepen Celzijusa temperature vode, dodavanjem sredstava za dezinfekciju u vodu;

ii. Za temperature vode veće od 35 stepeni Celzijusa i do 69 stepeni Celzijusa, održavanje ORP navedene vode od bar 500 mV za minimalni period sati dodavanjem sredstava za dezinfekciju u vodu, gde je minimalni period sati izračunat sa sledećom jednačinom:

[35 sati]- [Temperatura vode u stepenima Celzijusa- 35] =minimalni period sati; i

iii. Za temperature vode od 70 stepeni Celzijusa ili više, održavanje ORP navedene vode od bar 500 mV za minimalni period od 1 sata;

d. Aktiviranje sledećih procesa kroz sredstva za koordinaciju (1) gde procesi prečišćavaju vodu i eliminišu suspendovane čestice filtriranjem samo malog dela ukupne zapremine vode, gde sredstva za koordinaciju primaju informacije koje se odnose na parametre kvaliteta vode i aktiviraju u sredstva za primenu hemikalija i pokretna sredstva za crpljenje kako bi se navedeni parametri podesili unutar svojih granica:

i. Primenjivanje sredstava za oksidaciju kako bi se izbegle koncentracije gvožđa i mangana preko 1 ppm;

ii. Primenjivanje koagulanata, flokulanata ili njihove smeše kako bi se izbegla zamućenost preko 5 NTU;

iii. Crpljenje protoka vode koja sadrži istaložene čestice, proizvedene sa prethodnim procesima, sa pokretnim sredstvima za crpljenje za izbegavanje prosečne debljine istaloženog materijala veće od 100mm;

iv. Filtriranje protoka crpljenog pokretnim sredstvi ma za crpljenje, sa bar jednim sredstvom za filtraciju; i

v. Vraćanje filtrirane vode do bar jednog navedenog sredstva za sakupljanje;

e. Korišćenje navedene prečišćene vode u bar jednom nizvodnom industrijskom procesu; gde sredstva za koordinaciju variraju protok prečišćene vode do nizvodnog industrijskog procesa na osnovu informacija (12) kao što su izlaz ili brzina proizvodnje.

Patent sadrži još 12 patentnih zahtjeva

(11) **03371** (13) **B**

(51) **A61K 31/4188**^(2006.01)

A61K 31/55^(2006.01)

C07F 9/6506^(2006.01)

A61P 5/00^(2006.01)

C07D 487/04^(2006.01)

(21) P-2019-8

(22) 13.01.2011

(30) 294980 P 14.01.2010 US

(96) 11702096.6/13.01.2011

(86) US PCT/US2011/021100/13.01.2011

(87) WO 2011/088188/21.07.2011/2011/29

(97) EP 2523731/21.11.2012/2012/47

EP 2523731/24.10.2018/2018/43

(54) me **UPOTREBA AGENSA ZA MODIFIKOVANJE HORMONA ADRENALINA**
en **USE OF AN ADRENAL HORMONE-MODIFYING AGENT**

(73) NOVARTIS AG

Lichtstrasse 35, Basel, 4056/ CH

(72) , HU, Qi-Ying

Novartis Institutes for BioMedical Research Inc. 100 Technology Square, Cambridge, Massachusetts 02139/ US

, KSANDER, Gary

37 The Flume, Amherst, New Hampshire 03031/ US

, MEREDITH, Erik

Novartis Institutes for BioMedical Research Inc. 100 Technology Square, Cambridge, Massachusetts 02139/ US

, MONOVICH, Lauren G.

Novartis Institutes for BioMedical Research Inc. 100 Technology Square, Cambridge, Massachusetts 02139/ US

, PAPILLON, Julien

Novartis Institutes for BioMedical Research Inc. 100 Technology Square, Cambridge, Massachusetts 02139/ US

, SCHUMACHER, Christoph

Novartis Pharma AG Postfach, CH-4002 Basel/ CH

(57)

1. Jedinjenje 4-[(5R)-6,7-dihidro-5H-pirol[1,2-c]imidazol-5-il]-3-fluoro-benzonitril ima formulu

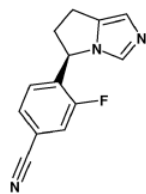

ili njegova farmaceutske prihvatljiva so, za upotrebu u lečenju Kušingovog sindroma ili Kušingove bolesti.

Patent sadrži još 7 patentnih zahtjeva

(11) **03417** (13) **B**

(51) **C07D 405/06**^(2006.01)

A61P 35/00^(2006.01)

(21) P-2019-81

(22) 13.05.2015

(30) 201461993423P 15.05.2014 US

(96) 15727125.5/13.05.2015

(86) US PCT/US2015/030464/13.05.2015

(87) WO 2015/175594/19.11.2015/2015/46

(97) EP 3143016/22.03.2017/2017/12

EP 3143016/12.12.2018/2018/50

(54) me **JEDINJENJE PLADIENOLID PIRIDINA I POSTUPCI PRIMJENE**
en **PLADIENOLIDE PYRIDINE COMPOUNDS AND METHODS OF USE**

(73) Eisai R&D Management Co., Ltd.

6-10, Koishikawa 4-chome Bunkyo-ku, Tokyo 112-8088/ JP

(72) KEANEY, Gregg F.

34 Robbins Road, Lexington, Massachusetts 02421/ US

WANG, John

2 Governor's Drive, Andover, Massachusetts 01810/ US

GERARD, Baudouin

69A Dartmouth Street, Belmont, Massachusetts 02478/ US

ARAI, Kenzo

Tsukuba Research Laboratories, 5-1-3 Tokodai Tsukuba-shi Ibaraki 300-2635/ JP

LIU, Xiang

10 Marion Street, Winchester, Massachusetts 01890/ US

ZHENG, Guo Zhu

14 Meriam Street, Lexington, Massachusetts 02420/ US

KIRA, Kazunobu

Tsukuba Research Laboratories, 5-1-3 Tokodai Tsukuba-shi Ibaraki 300-2635/ JP

TIVITMAHAISOON, Parcharee

580 Commonwealth Avenue 606, Boston, Massachusetts 02215/ US

PRAJAPATI, Sudeep

270 Highland Avenue, Apt.53, Somerville, Massachusetts 02143/ US

GEARHART, Nicholas C.

2164 Crestview Drive, Durango, Colorado 81301/ US

KOTAKE, Yoshihiko

Tsukuba Research Laboratories, 5-1-3 Tokodai Tsukuba-shi Ibaraki 300-2635/ JP

NAGAO, Satoshi

Tsukuba Research Laboratories, 5-1-3 Tokodai Tsukuba-shi Ibaraki 300-2635/ JP

KANADA SONOBE, Regina

Tsukuba Research Laboratories, 5-1-3 Tokodai Tsukuba-shi Ibaraki 300-2635/ JP

MIYANO, Masayuki

Tsukuba Research Laboratories, 5-1-3 Tokodai Tsukuba-shi Ibaraki 300-2635/ JP

MURAI, Norio

Tsukuba Research Laboratories, 5-1-3 Tokodai Tsukuba-shi Ibaraki 300-2635/ JP

BUONAMICI, Silvia

680 Tremont Street, Apt. 4, Boston, MA 02118/ US

YU, Lihua

19 Wood Lane, Acton, MA 01720/ US

CHAN, Betty

15 Littleton Road, 3A, Harvard, MA 01451/ US

SMITH, Peter G.

173A Franklin Street, Arlington, MA 02472/ US

PARK, Eunice Sun

4 Knowles Farm Road, Arlington, MA 02474 / US

THOMAS, Michael P.

66 Washington Street, Stoneham, MA 02180/ US

PAZOLLI, Ermira

133 Plain Road, Wayland, MA 01778/ US

LIM, Kian Huat

135 Farms Drive, Burlington, MA 01803/ US

(74) Advokat RADULOVIĆ, Božidar S.

Studentska bb, Lamela 3/18 , Podgorica, 81000 / ME

(57)

1. Jedinjenje izabrano od jedinjenja formule 1:

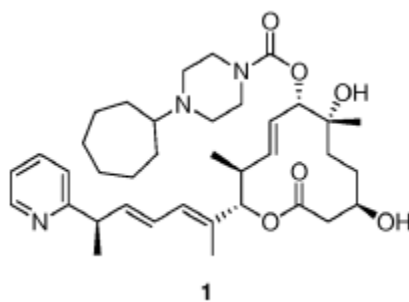

jedinjenja formule 2:

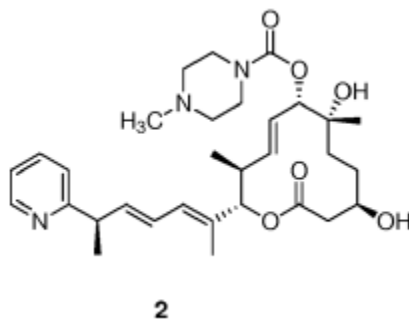

jedinjenja formule 3:

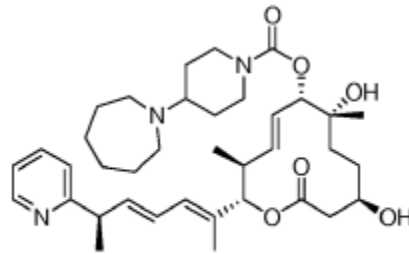

3

jedinjenja formule 4:

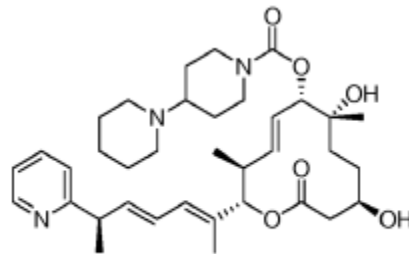

4

i njihovih farmaceutski prihvatljivih soli.

Patent sadrži još 27 patentnih zahtjeva

(11) **03418** (13) **B**

(51) **B01D 21/30**^(2006.01)

C02F 1/00^(2006.01)

C02F 1/76^(2006.01)

C02F 1/24^(2006.01)

C02F 1/50^(2006.01)

C02F 1/72^(2006.01)

C02F 5/08^(2006.01)

C02F 103/02^(2006.01)

C02F103/10^(2006.01)

B01D 61/04^(2006.01)

C02F 1/52^(2006.01)

C02F 9/02^(2006.01)

C02F 1/44^(2006.01)

C02F 1/56^(2006.01)

C02F 1/78^(2006.01)

C02F 101/20^(2006.01)

C02F103/08^(2006.01)

(21) P-2019-82

(22) 12.09.2011

(30) 201161469537P 30.03.2011 US

201113136474 01.08.2011 US

(96) 16198869.6/12.09.2011

(97) EP 3147015/29.03.2017/2017/13

EP 3147015/12.12.2018/2018/50

(54) me **APARAT ZA PRERADU VODE KOJA SE KORISTI U INDUSTRIJSKE SVRHE**
en **APPARATUS FOR TREATING WATER USED FOR INDUSTRIAL PURPOSES**

(73) Crystal Lagoons (Curaçao) B.V.

Kaya W.F.G. (Jombi), Mensing 14/ CW

(72) FISCHMANN, T. Fernando

Avenida Kennedy, 8830 Vitacura, Santiago/ CL

(74) Advokat RADULOVIĆ, Božidar S.

Studentska bb, Lamela 3/18 , Podgorica, 81000 / ME

(57)

1. Aparat za preradu vode uz male troškove za njenu primenu kao sirovine u najmanje jednom narednom industrijskom procesu, kojim se uklanjaju suspendovane čvrste materije iz vode filtriranjem male frakcije ukupne zapremine vode, pri čemu aparat sadrži:

- najmanje jedan napojni vod za vodu (7) do najmanje jednog sredstva za skladištenje (8);
- najmanje jedno sredstvo za skladištenje (8), naznačeno time što sredstvo za skladištenje ima zapreminu od najmanje 15.000 m³, koje uključuje prijemno sredstvo za nataložene čestice (17), i naznačeno time što je prijemno sredstvo pričvršćeno za dno sredstva za skladištenje i konstruisano je od neporoznog materijala koji može da se čisti, tako da je dno sredstva za skladištenje prekriveno neporoznim materijalom koji omogućava da mobilno sredstvo za usisavanje putuje preko cele donje površine sredstva za skladištenje i usisava nataložene čestice;
- najmanje jedno sredstvo za koordinaciju (1), gde sredstvo za koordinaciju (1) sadrži elektronske uređaje konfigurisane da primaju informacije u vezi sa parametrima kvaliteta vode, obrađuju te informacije i aktiviraju sredstva za primenu hemikalija i mobilno sredstvo za usisavanje, kako bi se podesili parametri vode u okviru granica naznačenih sredstvom za koordinaciju;
- najmanje jedno sredstvo za primenu hemikalija (4), koje se aktivira pomenutim najmanje jednim sredstvom za koordinaciju (1);
- najmanje jedno mobilno sredstvo za usisavanje (5), koje se kreće po dnu (17) pomenutog najmanje jednog sredstva za skladištenje (8), usisavajući tok vode koji sadrži nataložene čestice;

- najmanje jedno pogonsko sredstvo (6) koje obezbeđuje kretanje pomenutog najmanje jednog mobilnog sredstva za usisavanje (5) kako bi ono moglo da se kreće po dnu (17) pomenutog najmanje jednog sredstva za skladištenje (8);
 - najmanje jedno sredstvo za filtraciju (3) koje filtrira vodu koja sadrži nataložene čestice;
 - najmanje jedan sabirni vod (15), povezan između pomenutog najmanje jednog mobilnog sredstva za usisavanje (5) i pomenutog najmanje jednog sredstva za filtraciju (3);
 - najmanje jedan povratni vod (16) od pomenutog najmanje jednog sredstva za filtraciju (3) do pomenutog najmanje jednog sredstva za skladištenje (8); i
 - najmanje jedan izlazni vod za vodu (18) od pomenutog najmanje jednog sredstva za skladištenje (8) do narednog industrijskog procesa;
- naznačeno time što je sredstvo za koordinaciju konfigurisano tako da menja tok prerađene vode do narednog industrijskog procesa na osnovu informacija (12), kao što je izlaz ili brzina proizvodnje.

Patent sadrži još 6 patentnih zahtjeva

(11) **03419** (13) **B**

(51) **C07D 401/14**^(2006.01)

C07D 401/06^(2006.01)

A61P 35/00^(2006.01)

C07D 405/14^(2006.01)

A61K 31/47^(2006.01)

(21) P-2019-85

(22) 05.06.2015

(30) 201462013410P 17.06.2014 US

201562156533P 04.05.2015 US

(96) 15730290.2/05.06.2015

(86) IB PCT/IB2015/054272/05.06.2019

(87) WO 2015/193765/23.12.2015/2015/51

(97) EP 3157915/26.04.2017/2017/17

EP 3157915/27.02.2019/2019/09

(54) me **SUPSTITUIRANI SPOJEVI DIHIDROIZOKINOLINONA**
en **SUBSTITUTED DIHYDROISOQUINOLINONE COMPOUNDS**

(73) Pfizer Inc.

235 East 42nd Street, New York 10017/ US

(72) COLLINS, Michael, Raymond

17330 Campillo Drive, San Diego, California 92128-2150,/ US

KANIA, Robert, Steven

10670 Haven Brook Place, San Diego, California 92130/ US

KUMPF, Robert, Arnold

3280 Avenida Anacapa, Carlsbad, California 92009/ US

KUNG, Pei-Pei

5504 Shannon Ridge Lane, San Diego, California 92130/ US

RICHTER, Daniel, Tyler

2220 Chicago Street, San Diego, California 92110/ US

SUTTON, Scott, Channing

11660 Weatherwood Place, San Diego, California 92131/ US

WYTHES, Martin, James

756 North Granados Avenue, Solana Beach, California 92075/ US

(74) AOD "ĆUPIĆ"

Bulevar Džordža Vašigtona 79, Podgorica, 81000/ ME

(57)

1. Spoj formule (I):

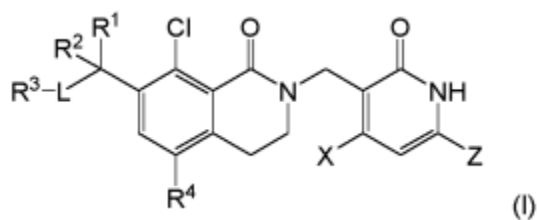

ili njegova farmaceutski prihvatljiva sol,

naznačen time što:

R1 se bira iz skupine koju čine F, C1-C4 alkil, C1-C4 alkoksi, C(O)R5, C3-C8 cikloalkil, 3-12-eročlani heterociklil i 5-12-eročlani heteroaril, gdje svaki navedeni C1-C4 alkil ili C1-C4 alkoksi može biti supstituiran s jednim ili više R6, a svaki navedeni C3-C8 cikloalkil, 3-12-eročlani heterociklil ili 5-12-eročlani heteroaril može biti supstituiran s jednim ili više R7;

R2 je H, F ili C1-C4 alkil;

L je veza ili C1-C4 alkilen;

R3 se bira iz skupine koju čine C1-C4 alkil, C1-C4 alkoksi, OH, CN, C(O)R8, COOR9, NR10R11, OR12, C3-C8 cikloalkil, 3-12-eročlani heterociklil i 5-12-eročlani heteroaril, gdje svaki navedeni C1-C4 alkil ili C1-C4 alkoksi može biti supstituiran s jednim ili više R6, a svaki navedeni C3-C8 cikloalkil, 3-12-eročlani heterociklil ili 5-12-eročlani heteroaril može biti supstituiran s jednim ili više R7;

R4 je H, halogen ili C1-C4 alkil, gdje svaki navedeni C1-C4 alkil može biti supstituiran s jednim ili više R6;

R5 je C1-C4 alkil, gdje svaki navedeni C1-C4 alkil može biti supstituiran s jednim ili više R14;

svaki R6 je neovisno OH, F, CN ili C1-C4 alkoksi;

svaki R7 je neovisno C1-C4 alkil, OH, F, CN, C1-C4 alkoksi, =O, ili C(O)R13;

R8 je C1-C4 alkil, gdje svaki navedeni C1-C4 alkil može biti supstituiran s jednim ili više R14;

R9 je H ili C1-C4 alkil, gdje svaki navedeni C1-C4 alkil može biti supstituiran s jednim ili više R14;

R10 i R11 are neovisno H ili C1-C4 alkil, gdje svaki navedeni C1-C4 alkil može biti supstituiran s jednim ili više R14;

R12 se bira iz skupine koju čine C3-C8 cikloalkil, 3-12-eročlani heterociklil i 5-12-eročlani heteroaril, gdje svaki navedeni C3-C8 cikloalkil, 3-12-eročlani heterociklil ili 5-12-eročlani heteroaril može biti supstituiran s jednim ili više R7;

svaki R13 je neovisno C1-C4 alkil, gdje svaki navedeni C1-C4 alkil može biti supstituiran s jednim ili više R15;

svaki R14 i R15 je neovisno OH, F, CN ili C1-C4 alkoksi; i

X i Z are neovisno C1-C4 alkil, C1-C4 fluoralkil, C1-C4 alkoksi ili C1-C4 fluoralkoksi.

Patent sadrži još 22 patentnih zahtjeva

(11) **03420** (13) **B**

(51) **C07D 213/84**^(2006.01)

C07D 401/04^(2006.01)

C07D 213/61^(2006.01)

(21) P-2019-86

(22) 17.12.2015

(30) 201462094436P 19.12.2014 US

(96) 15823875.8/17.12.2015

(86) US PCT/US2015/066356/17.12.2015

(87) WO 2016/100652/23.06.2016/2016/25

(97) EP 3233803/25.10.2017/2017/43

EP 3233803/30.01.2019/2019/05

(54) me **POSTUPAK ZA PRIPREMU JEDINJENJA DIARILTIOHIDANTOINA**

en **PROCESS FOR THE PREPARATION OF A DIARYLTHIOHYDANTOIN COMPOUND**

(73) ARAGON PHARMACEUTICALS, INC

12780 El Camino Real, Suite 301, San Diego, CA 92130/ US

(72) HAIM, Cyril Ben

Krommenhof 54, 2340 Beerse/ BE

HORVATH, Andras

Smalvoortstraat 46 Bus 2 , B2300 Turnhout/ BE

WEERTS, Johan Erwin Edmond

Statiestraat 7, 2340 Beerse/ BE

(74) Advokat LUTOVAC, Branislav

Bulevar Ivana Crnojevica 93 , Podgorica , 81000 / ME

(57)

1. Postupak za pripremu jedinjenja (X)

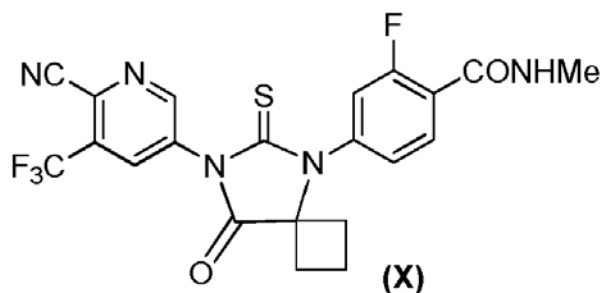

koji obuhvata

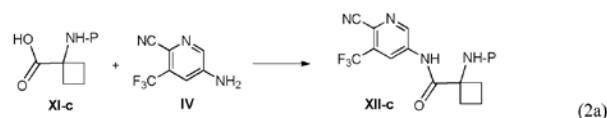

reagovanje jedinjenja formule (XI-c), gde je P amino zaštitna grupa, sa jedinjenjem (IV) pod uslovima za obrazovanje amidne veze; u prisustvu sredstva za spajanje amida; i u prisustvu katalizatora; u organskom rastvaraču; na temperaturi u opsegu od 0 °C do oko 50 °C; da se dobije odgovarajuće jedinjenje formule (XII-c); ili,

5-izocijanato-3-(trifluorometil)picolinonitril

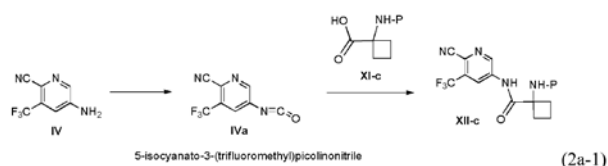

reagovanje jedinjenja (IV) sa fozgenom ili analogom fozgena; u prisustvu organske baze; u aprotonskom rastvaraču; zatim tretiranje dobijenog intermedijera izocijanata (IVa), opciono bez izolovanja, sa jedinjenjem formule (XI-c); u prisustvu baze koja nije nukleofilna; na temperaturi u opsegu od oko -20 °C do oko 80 °C; da se dobije odgovarajuće jedinjenje formule (XII-c);

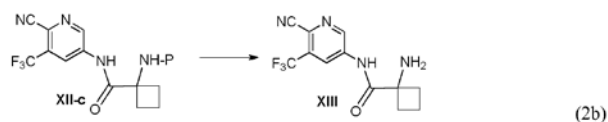

reagovanje jedinjenja formule (XII-c) pod uslovima za uklanjanje amino zaštite; u organskom rastvaraču; na temperaturi koja je veća od sobne temperature; da se dobije odgovarajuće jedinjenje (XIII);

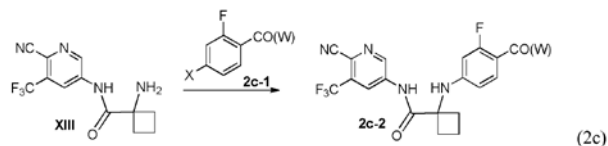

reagovanje jedinjenja (XIII) sa jedinjenjem formule (2c-1) pri čemu X je hloro, bromo, ili jodo, i W je C1-8alkoksi ili metilamino; u prisustvu izvora bakra (0) ili soli bakra; u prisustvu neorganske baze; u organskom rastvaraču; opciono u prisustvu liganda; opciono u prisustvu redukujućeg sredstva; na temperaturi u opsegu od oko sobne temperature do oko 140 °C; da se dobije odgovarajuće jedinjenje formule (2c-2) pri čemu W je C1-8alkoksi (2c-2B) ili metilamino (XVII);

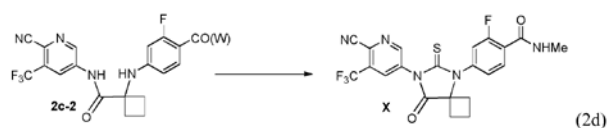

konvertovanje jedinjenja formule (2c-2) u jedinjenje (X).

Patent sadrži još 26 patentnih zahtjeva

(11) **03421** (13) **B**

(51) **C07D 249/08**^(2006.01)

A61P 35/00^(2006.01)

A61K 31/497^(2006.01)

(21) P-2019-88

(22) 20.06.2014

(30) 201361838172P 21.06.2013 US

(96) 14738998.5/20.06.2014

(86) US PCT/US2014/043479/20.06.2014

(87) WO 2014/205389/24.12.2014/2014/52

(97) EP 3010892/27.04.2016/2016/17

EP 3010892/26.12.2018/2018/52

(54) me **1,2,4-TRIAZOLI KAO MODULATORI NUKLEARNOG TRANSPORTA I NJIHOVA UPOTREBA**
en **1,2,4-TRIAZOLES AS NUCLEAR TRANSPORT MODULATORS AND USES THEREOF**

(73) Karyopharm Therapeutics Inc.

85 Wells Avenue, Newton, MA 02459/ US

(72) BALOGLU, Erkan

8 Benjamin Terrace, Stoneham, MA 02180/ US

SHACHAM, Sharon

145 Hagen Road, Newton, MA 02459/ US

MCCAULEY, Dilara

49 Brantwood Road, Arlington, MA 02476/ US

KASHYAP, Trinayan

65 Auburn Street Apt. 8, Framingham, MA 01701/ US

SENAPEDES, William

34 Timberline Road, Millis, MA 02054/ US

LANDESMAN, Yosef

260 Tappan Street, Brookline, MA 02445/ US

GOLAN, Gali

192 Har Yeela Street, 99770 Mesilat Zion/ IL

KALID, Ori

Dror 30/2, 37025 Pardes Hanna/ IL

SHECHTER, Sharon

18 Ivy Lane, Andover, MA 01810/ US

(74) Advokat RADULOVIĆ, Božidar S.

Studentska bb, Lamela 3/18, Podgorica, 81000 / ME

(57)

1. Jedinjenje, **naznačeno time**, što je predstavljeno sa strukturnom formulom IV:

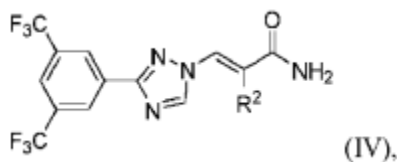

ili neka njegova farmaceutski prihvatljiva so, pri čemu:

R2 je izabran iz opciono supstituisanog heteroarila koji sadrži 5 do 15 atoma u prstenu i opciono supstituisanog arila koji sadrži 6 do 12 atoma u prstenu,

pri čemu pomenuti opcioni supstituenti na R2-grupama su 1, 2 ili 3 supstituenta nezavisno izabrana iz halogena, C1-C4 alkila, halo-C1-C4 alkila, C1-C4 alkoksi, C1-C4 tioalkoksi, hidroksila, amino, C1-C4 alkilamino, C1-C4 dialkilamino, sulfhidrila, cijano, C6 arila i heteroarila koji sadrži 5 ili 6 atoma u prstenu.

Patent sadrži još 16 patentnih zahtjeva

(11) **03422** (13) **B**

(51) **C07D 307/81**^(2006.01)

A61K 31/343^(2006.01)

A61P 3/00^(2006.01)

(21) P-2019-89

(22) 12.02.2015

(30) 20140025832 13.02.2014 JP

(96) 15706546.7/12.02.2015

(86) JP PCT/JP2015/000639/12.02.2015

(87) WO 2015/122187/20.08.2015/2015/33

(97) EP 3105213/21.12.2016/2016/51

EP 3105213/09.01.2019/2019/02

(54) me **JEDINJENJA DIHIDROBENZOFURANA KORISNA U LIJEČENJU DIJABETESA I GOJAZNOSTI**

en **DIHYDROBENZOFURAN COMPOUNDS USEFUL IN THE TREATMENT OF DIABETES AND OBESITY**

(73) Takeda Pharmaceutical Company Limited

1-1, Doshomachi 4-chome Chuo-ku Osaka-shi, Osaka 541-0045/ JP

(72) SASAKI, Minoru

26-1, Muraoka-Higashi 2-chome, Fujisawa-shi, Kanagawa 251-0012 / JP

KAKEGAWA, Keiko

26-1, Muraoka-Higashi 2-chome, Fujisawa-shi, Kanagawa 251-0012/ JP

KIKUCHI, Fumiaki

26-1 Muraoka-Higashi 2-chome, Fujisawa-shi, Kanagawa 251-0012/ JP

IKEDA, Zenichi

26-1, Muraoka-Higashi 2-chome, Fujisawa-shi, Kanagawa 251-0012/ JP

NISHIKAWA, Yoichi

26-1, Muraoka-Higashi 2-chome, Fujisawa-shi, Kanagawa 251-0012/ JP

(74) Advokat POPOVIĆ, Miladin

Đoka Miraševića 21/III, Podgorica, 81000 / ME

(57)

1. Jedinjenje predstavljeno formulom (I):

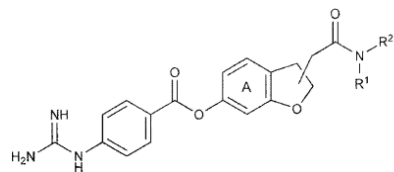

(I)

gde

prsten A predstavlja benzen prsten izborno supstituisan sa 1 do 3 supstituenta izabrana od atoma halogena i C1-6 alkil grupe;

R1 predstavlja atom vodonika ili C1-6 alkil grupu supstituisanu sa COOH; i

R2 predstavlja C1-6 alkil grupu supstituisanu sa jednim ili dva COOH i dalje izborno supstituisanu sa SO₃H, ili njegova so.

Patent sadrži još 12 patentnih zahtjeva

(11) **03408** (13) **B**

(51) **A61K 31/4995**^(2006.01)

A61K 31/519^(2006.01)

A61K 31/7068^(2006.01)

A61K 45/06^(2006.01)

A61K 31/337^(2006.01)

A61K 31/513^(2006.01)

A61K 31/69^(2006.01)

A61K 38/15^(2006.01)

A61P 35/00^(2006.01)

A61K 31/475^(2006.01)

(21) P-2019-91

(22) 11.11.2011

(30) 10382300 12.11.2010 EP

(96) 14175268.3/11.11.2011

(97) EP 2786754/08.10.2014/2014/41

EP 2786754/09.01.2019/2019/02

(54) me **KOMBINOVANA TERAPIJA SA INHIBITOROM MITOZE**
en **Combination therapy with an mitotic inhibitor**

(73) Pharma Mar S.A.

Avda. de los Reyes 1, Polígono Industrial La Mina-Norte, Colmenar Viejo Madrid, 28770/ ES

(72) Moneo Ocana, Victoria

Pharma Mar, S.A, Avda. de los Reyes 1/ ES

Garcia Fernandez, Luis Francisco

Pharma Mar, S.A., Avda. de los Reyes 1/ ES

Galmarini, , Carlos María

Pharma Mar, S.A., Avda. de los Reyes 1/ ES

Guillen Navarro, María José

Pharma Mar, S.A., Avda. de los Reyes 1/ ES

Aviles Marin, Pablo Manuel

Pharma Mar, S.A., Avda. de los Reyes 1/ ES

Santamaria Nunez, Gema

Pharma Mar, S.A., Avda. de los Reyes 1/ ES

(57)

1. PM01183, ili njegova farmaceutski prihvatljiva so, za upotrebu u liječenju karcinoma, koji se sastoji od davanja terapeutske efikasne količine PM01183, ili njegove farmaceutski prihvatljive soli, u sinergističkoj kombinaciji sa terapeutske efikasnom količinom inhibitora mitoze, pri čemu je inhibitor mitoze izabran od paklitaksela, docetaksela, vinkristina i vinorelbina.

Patent sadrži još 9 patentnih zahtjeva

(11) **03374** (13) **B**

(51) **C07D 403/06**^(2006.01)

A61P 19/02^(2006.01)

A61K 31/496^(2006.01)

A61P 19/04^(2006.01)

(21) P-2019-92

(22) 18.12.2015

(30) 14307129 22.12.2014 EP

(96) 15813831.3/18.12.2015

(86) EP PCT/EP2015/080430/18.12.2015

(87) WO 2016/102347/30.06.2016/2016/26

(97) EP 3237406/01.11.2017/2017/44

EP 3237406/06.02.2019/2019/06

(54) me **DERIVATI 5-[(PIPERAZIN-1-IL)-3-OKSO-PROPIL]-IMIDAZOLIDIN-2,4-DIONA KAO ADAMTS INHIBITORI ZA LIJEČENJE OSTEOARTRITISA**
en **5-[(PIPERAZIN-1-YL)-3-OXO-PROPYL]-IMIDAZOLIDINE-2,4-DIONE DERIVATIVES AS ADAMTS INHIBITORS FOR THE TREATMENT OF OSTEOARTHRITIS**

(73) Galapagos NV

Generaal De Wittelaan L11/A3, 2800 Mechelen/ BE

Les Laboratoires Servier

35, Rue de Verdun, 92284 Suresnes/ FR

(72) BREBION, Franck Laurent

Galapagos SASU 102 Avenue Gaston Roussel, 93230 Romainville/ FR

ALVEY, Luke Jonathan

Galapagos SASU 102 Avenue Gaston Roussel, 93230 Romainville/ FR

AMANTINI, David

Galapagos SASU 102 Avenue Gaston Roussel, 93230 Romainville/ FR

DEPREZ, Pierre Marc Marie Joseph

Galapagos SASU 102 Avenue Gaston Roussel, 93230 Romainville/ FR

GOSMINI, Romain Luc Marie

Galapagos SASU 102 Avenue Gaston Roussel, 93230 Romainville/ FR

JARY, Helène Marie

Galapagos SASU 102 Avenue Gaston Roussel, 93230 Romainville/ FR

PEIXOTO, Christophe

Galapagos SASU 102 Avenue Gaston Roussel, 93230 Romainville/ FR

VARIN, Marie Laurence Claire

Galapagos SASU 102 Avenue Gaston Roussel, 93230 Romainville/ FR

DE CEUNINCK, Frédéric André

4 Impasse Morlet, 75011 Paris/ FR

POP-BOTEZ, Iuliana Ecaterina

53 Rue Anatole France, 78800 Houilles/ FR

(57)

1. Spoj, **naznačen time**, da je u skladu s Formulom I:

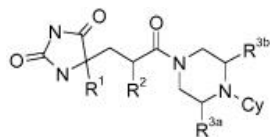

I

pri čemu:

R1 je:

- H,
- C1-4 alkil po izboru supstituiran s jednom ili više neovisno odabranih R4 skupina,
- C3-7 monociklički cikloalkil po izboru supstituiran s jednom ili više neovisno odabranih R4 skupina,
- 4-7-eročlani monociklički heterocikloalkil koji sadrži 1 do 2 heteroatoma neovisno odabrana od N, O i S, po izboru supstituirana s jednim ili više neovisno odabranim C1-4 alkilom, -C(=O)C1-4 alkilom ili -C(=O)OC1-4 alkilom,
- fenil po izboru supstituiran s jednom ili više neovisno odabranih R5 skupina,
- fenil spojen s 5-6-eročlanim monocikličkim heterocikloalkilom koji sadrži 1, 2 ili 3 heteroatoma neovisno odabrana od N, O i S, koji heterocikloalkil je po izboru supstituiran s jednim ili više =O,
- 5-6-eročlani monociklički heteroaril koji sadrži 1 ili 2 heteroatoma neovisno odabrana od N, O i S, po izboru supstituirana s jednom ili više neovisno odabranih R5 skupina;

R2 je neovisno odabran od:

- H,
- OH,
- C1-4 alkoksi i
- C1-4 alkila po izboru supstituiranog s jednom
 - o OH,
 - o -CN,
 - o C1-4 alkoksi po izboru supstituiranog s jednim fenilom i
 - o 5-6-eročlani monociklički heteroaril koji sadrži 1 ili 2 heteroatoma neovisno odabrana od N, O i S, po izboru supstituirana s jednim ili više neovisno odabranim C1-4 alkilom;

svaki R3a i R3b je neovisno odabran od:

- H i
 - C1-4 alkila;
- Cy je
- 6-10-eročlani monociklički ili spojeni biciklički aril po izboru supstituiran s jednom ili više neovisno odabranih R6 skupina,
 - 5-10-eročlani monociklički ili spojeni biciklički heteroaril koji sadrži 1, 2 ili 3 heteroatoma neovisno odabrana od N, O i S, po izboru supstituirana s jednom ili više neovisno odabranih R6 skupina;

R4 je

- halo,
- OH,
- -CN,
- C1-4 alkil,
- C1-4 alkoksi po izboru supstituiran s C1-4 alkoksi ili fenilom,
- C1-4 tioalkoksi,
- 4-7 eročlani monociklički heterocikloalkil koji sadrži jedna ili više heteroatoma neovisno odabrana od N, S i O, po izboru supstituirana s jednim ili više halo ili -C(=O)OC1-4 alkilom,
- fenil,
- -S(=O)2C1-4 alkil
- -C(=O)OR7a
- -C(=O)NR7bR7c
- -NHC(=O)OR7d

- -NHC(=O)R7e
- -NR8aR8b;

svaki R5 je

- halo,
- OH,
- -CN,
- C1-4 alkil po izboru supstituiran s jednim ili više neovisno odabranim halo, -NR9aR9b ili -C(=O)NR9cR9d,
- C1-4 alkoksi po izboru supstituiran s -NR9eR9f ili
- -S(=O)2C1-4 alkil;

svaki R6 je

- halo,
- -CN,
- -NO2,
- -CH3,
- 5-10-eročlani monociklički ili spojeni biciklički heteroaril koji sadrži 1, 2 ili 3 heteroatoma neovisno odabrana od N, O i S, po izboru supstituirana s jednim ili više halo, C1-4 alkilom ili C1-4 alkoksi ili
- -NR9gR9h;

svaki R7a, R7b, R7c, R7d ili R7e je

- H ili
- C1-4 alkil po izboru supstituiran s OH ili C1-4 alkoksi;

svaki R8a ili R8b je neovisno odabran od

- H i
- C1-4 alkila po izboru susptituiranog s OH, C1-4 alkoksi ili fenilom;

svaki R9a, R9b, R9c, R9d, R9e, R9f, R9g i R9h je neovisno odabran od H i C1-4 alkila; ili farmaceutski prihvatljive soli ili solvata ili farmaceutski prihvatljive soli njihovih solvata; pod uvjetom da:

- R1 i R2 nisu istovremeno H i
- kada je R1 Me, a R2 je H, tada Cy nije

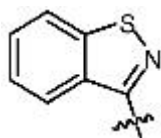

ili farmaceutski prihvatljiva sol ili solvat ili sol njihovih solvata.

Patent sadrži još 17 patentnih zahtjeva

(11) 03375 (13) B

(51) A61K 31/451^(2006.01)

A61K 31/4545^(2006.01)

A61K 31/519^(2006.01)

A61K 31/554^(2006.01)

C07C 45/67^(2006.01)

A61K 31/495^(2006.01)

C07D 241/04^(2006.01)

A61K 31/454^(2006.01)

A61K 31/496^(2006.01)

A61K 31/551^(2006.01)

C07C 45/61^(2006.01)

C07D 295/073^(2006.01)

C07B 59/00^(2006.01)

(21) P-2019-93

(22) 19.06.2012

(30) 201161498651 P 20.06.2011 US

201161537103 P 21.09.2011 US

(96) 16179882.2/19.06.2012

(97) EP 3135656/01.03.2017/2017/09

EP 3135656/27.02.2019/2019/09

(54) me **DEUTERIZOVANI 1-PIPERAZINO-3-FENIL INDANI ZA TRETIRANJE ŠIZOFRENIJE**
en **DEUTERATED 1-PIPERAZINO-3-PHENYL INDANES FOR TREATMENT OF**
SCHIZOPHRENIA

(73) H. Lundbeck A/S

Ottiliavej 9, 2500 Valby/ DK

(72) , JØRGENSEN, Morten

Aldershvilevej 94, 2880 Bagsværd/ DK

, ANDERSEN, Peter, Høngaard

V.M. Amdrupsvej 13, 3520 Farum/ DK

, JENSEN, Klaus, Gjervig

Sofiegade 10, 2. mf., 1418 København K/ DK

, HVENEGAARD, Mette, Graulund

Jersie Solvænge 13, 2680 Solrød Strand/ DK

, BADOLO, Lassina

Lærkebakken 5, 2400 København NV/ DK

, JACOBSEN, Mikkel, Fog

Nyelandsvej 54, 4.th., 2000 Frederiksberg/ DK

(57)

1. Jedinjenje formule Y:

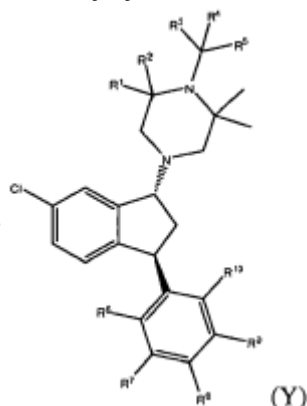

u kojoj,

R1 - R10 su nezavisno vodonik ili deuterijum, pri čemu su R6-R10 svaki deuterijum, ili njegova farmaceutski prihvatljiva adiciona so sa kiselinom, za upotrebu kao lek.

Patent sadrži još 21 patentnih zahtjeva

(11) **03409** (13) **B**

(51) **C07D231/56**^(2006.01)

C07D471/04^(2006.01)

A61P33/00^(2006.01)

A01N37/34^(2006.01)

C07D249/18^(2006.01)

C07D487/04^(2006.01)

A01N43/707^(2006.01)

(21) P-2019-94

(22) 13.11.2009

(30) 20080114656P 14.11.2008 US

20080114665P 14.11.2008 US

20090176136P 07.05.2009 US

(96) 15181173.4/13.11.2009

(97) EP 3050874/03.08.2016/2016/31

EP 3050874/09.01.2019/2019/02

(54) me **ENANTIOMERNO OBOGAĆENA PARAZITICIDALNA JEDINJENJA ARILOAZOL-2-ii
CIJANOETILAMINO**

en **ENANTIOMERICALLY ENRICHED ARYLOAZOL-2-YL CYANOETHYLAMINO PARACITICIDAL
COMPOUNDS**

(73) Merial Inc.

3239 Satellite Boulevard Building 500, Duluth, GA 30096/ US

(72) SOLL, Mark David

605 Newport Shore, Alpharetta , GA 30005/ US

LE HIR DE FALLOIS, Loïc Patrick

2259 Fairhaven Circle NE, Atlanta Georgia 30305/ US

HUBER, Scot Kevin

6104 Bramblewood Drive, Rayleigh, NC 27612/ US

LEE, Hyoung Ik

103 Roundtop Road, Cary, NC 27519/ US

WILKINSON, Douglas Edward

536 Rodney Bay Crossing, Wake Forest NC 27587/ US

JACOBS, Robert Toms

1849 Old College Circle, Wake Forest, NC 27587/ US

BECK, Brent Christopher

710 Straywhite Avenue, Apex NC 27539/ US

(57)

1. Derivat ariloazol-2-il-cijanoetilamino pentafluorotiobenzamida formule (IH):

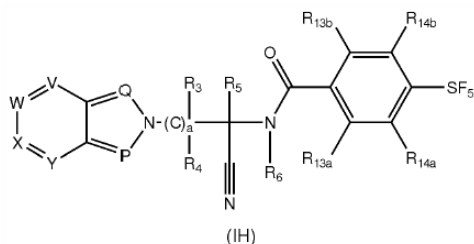

gde:

P je N;

Q je C-R2 ili N;

V je N;

W je C-R9 ili N;

X je C-R10 ili N;

Y je C-R11 ili N;

R2, R9, R10 i R11 su međusobno nezavisno vodonik, amino, amido, cijano, nitro, halogen, C1-C6-alkil, C3-C7cikloalkil, C2-C6-alkenil, halo-C1-C6-alkil, C1-C6-alkiltio, halo-C1-C6-alkiltio, C1-C6-alkoksi, C3-C7cikloalkiloksi, halo-C1-C6-alkoksi, C1-C6-alkilkarbonil, halo-C1-C6-alkilkarbonil, C1-C6-alkoksikarbonil, halo-C1-C6-alkoksikarbonil, C1-C6-alkilsulfinil, halo-C1-C6-alkilsulfinil, C1-C6-alkilsulfonyl, halo-C1-C6-alkilsulfonyl, C1-C6-alkilamino, ili di(C1-C6-alkil)amino;

R3, R4 i R5 su međusobno nezavisno vodonik, halogen, alkil, hidroksialkil, alkiltioalkil, haloalkil, alkiloksialkil, alkilsulfonylalkil, alkilsulfonylalkil, alkilsulfonylalkil; nesupstituisan ili supstituisan cikloalkil, pri čemu supstituenti mogu svaki biti nezavisno halogen i alkil; nesupstituisan ili supstituisan aril, nesupstituisan ili supstituisan heteroaril, pri čemu supstituenti mogu svaki biti međusobno nezavisno cijano, nitro, halogen, alkil, haloalkil, alkiltio, haloalkiltio, ariltio, alkoksi, haloalkoksi, alkilkarbonil, haloalkilkarbonil, alkoksikarbonil, haloalkoksikarbonil, alkilsulfinil, haloalkilsulfinil, alkilsulfonyl, haloalkilsulfonyl, SF5, alkilamino ili di(alkil)amino; ili

R4 i R5 zajedno sa ugljenikom za koji su vezani formiraju cikloalkil prsten;

R6 je vodonik, alkil, alkoksialkil, alkilkarbonil, haloalkilkarbonil, alkoksikarbonil, haloalkoksikarbonil, alkiltioalkil ili nesupstituisan ili supstituisan benzil, pri čemu supstituenti mogu svaki biti međusobno nezavisno cijano, nitro, halogen, alkil, haloalkil, alkiltio, haloalkiltio, ariltio, alkoksi, haloalkoksi, alkilkarbonil, haloalkilkarbonil, alkoksikarbonil, haloalkoksikarbonil, alkilsulfinil, haloalkilsulfinil, alkilsulfonyl, haloalkilsulfonyl, SF5, alkilamino ili di(alkil)amino;

R13a, R13b, R14a i R14b su svaki međusobno nezavisno vodonik, cijano, nitro, halogen, SF5, C1-C6-alkil, halo-C1-C6-alkil, C1-C6-alkoksi, C1-C6-alkiltio, halo-C1-C6-alkoksi ili halo-C1-C6-alkiltio; i

a je 1.

Patent sadrži još 14 patentnih zahtjeva

(11) **03376** (13) **B**

(51) **C07D 487/04**^(2006.01)

C07D 519/00^(2006.01)

C07D 487/22^(2006.01)

A61K 31/519^(2006.01)

C07D 498/22^(2006.01)

C07D 471/22^(2006.01)

(21) P-2019-96

(22) 13.05.2011

(30) 346767 P 20.05.2010 US
201061426716 P 23.12.2010 US

(96) 17163978.4/13.05.2011

(97) EP 3205654/16.08.2017/2017/33
EP 3205654/02.01.2019/2019/01

(54) me **MAKROCIKLIČKA JEDINJENJA KAO INHIBITORI TRK KINAZE**
en **MACROCYCLIC COMPOUNDS AS TRK KINASE INHIBITORS**

(73) ARRAY BIOPHARMA, INC.

3200 Walnut Street, Boulder, CO 80301/ US

(72) ANDREWS, Steven Wade

c/o Array BioPharma, Inc. 3200 Walnut Street, Boulder, CO Colorado 80301/ US

CONDROSKI, Kevin Ronald

c/o Array BioPharma, Inc. 3200 Walnut Street, Boulder, CO Colorado 80301/ US

HAAS, Julia

c/o Array BioPharma, Inc. 3200 Walnut Street, Boulder, CO Colorado 80301/ US

JIANG, Yutong

c/o Array BioPharma, Inc. 3200 Walnut Street, Boulder, CO Colorado 80301/ US

KOLAKOWSKI, Gabrielle R.

c/o Array BioPharma, Inc. 3200 Walnut Street, Boulder, CO Colorado 80301/ US

SEO, Jeongbeob

c/o Array BioPharma, Inc. 3200 Walnut Street, Boulder, CO Colorado 80301/ US

YANG, Hong-Woon

c/o Array BioPharma, Inc. 3200 Walnut Street, Boulder, CO Colorado 80301/ US

ZHAO, Qian

c/o Array BioPharma, Inc. 3200 Walnut Street, Boulder, CO Colorado 80301/ US

(57)

1. Jedinjenje izabrano iz grupe koju čine:

(6R)-9-fluoro-15-hidroksi-13-oksa-2,11,17,21,22,25- heksaazapentaciklo[17.5.2.W·6.07·12.<f2·26] heksakoza-1
(25),7,9,11,19(26),20,23-heptaen-18- on;

(6R, 15R)-9-fluoro-15-hidroksi-13-oksa-2,11,17,21,22,25-heksaazapentaciklo-
[17.5.2.W·6.07·12.Q22.26]heksakoza-1 (25),7,9,11,19(26),20,23-heptaen-18-on;

(6R)-9-fluoro-13-oksa-2,11,16,20,21,24-heksaazapentaciklo[16.5.2.W·6.07·12.Q21.25]pentakoza-

1(24).7,9,11,18(25),19,22-heptaen-17-on;

(6R)-9-fluoro-13-oksa-2,11,18,22,23,26-heksaazapentaciklo-
[18.5.2.W·6.07·12.<f3.27]heptakoza-1(26),7,9,11,20(27),21,24-heptaen-19-on;
(6R)-9-fluoro-2,11,13,16,20,21,24-heksaazapentaciklo[16.5.2.W·6.07·12.Q21.25]
pentakoza-1(24),7,9,11,18(25),19,22-heptaen-17-on;
(6R)-9-fluoro-15,15-dimetil-13-oksa-2,11,17,21,22,25-heksaaza-pentaciklo
[17.5.2.W·6.07·12.Q22.26]heksakoza-1(25),7,9,11,19(26),20,23-heptaen-18-on; i
(6R)-9-fluoro-15,15-dimetil-2,11,16,20,21,24-heksaaza-pentaciklo
[16.5.2.Q2·6.07·12.Q21.25]pentakoza-1(24),7,9,11,18(25),19,22-heptaen-17-on;
ili njegova farmaceutska prihvatljiva so.

Patent sadrži još 16 patentnih zahtjeva

(11) **03377** (13) **B**

(51) **C07D 413/14**^(2006.01)

A61P 35/00^(2006.01)

A61K 31/5377^(2006.01)

(21) P-2019-97

(22) 17.10.2014

(30) 201361892564 P 18.10.2013 US

(96) 14854037.0/17.10.2014

(86) CA PCT/CA2014/051001/17.10.2014

(87) WO 2015/054793/23.04.2015/2015/16

(97) EP 3057965/24.08.2016/2016/34

EP 3057965/02.01.2019/2019/01

(54) me **SOL I KRISTALNI OBLICI INHIBITORA PLK-4**

en **SALT AND CRYSTAL FORMS OF PLK-4 INHIBITOR**

(73) University Health Network

190 Elizabeth Street R. Fraser Elliott Building - Room 1S-417, Toronto, Ontario M5G 2C4/ CA

(72) SAMPSON, Peter Brent

1320 Ridgebank Drive, Oakville, Ontario L6M 4A5/ CA

FEHER, Miklos

229 West 60th Street Apt. 22M, New York, New York 10023/ US

PAULS, Heinz W.

460 Fourth Line, Oakville, Ontario L6L 5A4/ CA

(57)

1. Fumarat sol spoja (I) je predstavljena slijedećom strukturnom formulom:

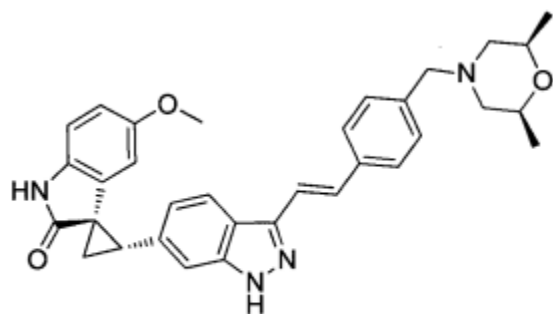

Compound (I)

Spoj (I)

pri čemu je molarni odnos između spoja (I) i fumarne kiseline 1:1.

Patent sadrži još 18 patentnih zahtjeva

(11) **03378** (13) **B**

(51) **C07K 16/18**^(2006.01)

A61K 39/00^(2006.01)

(21) P-2019-98

(22) 06.04.2010

(30) 168411 P 10.04.2009 US

(96) 15159780.4/06.04.2010

(97) EP 2930184/14.10.2015/2015/42

EP 2930184/27.03.2019/2019/13

(54) me **PROTUTIJELA PROTIV DKK-1**
en **DKK-1 ANTIBODIES**

(73) ELI LILLY AND COMPANY

Lilly Corporate Center, Indianapolis, IN 46285/ US

(72) Chedid, Marcio

Lilly Corporate Centre, Indianapolis, IN 46285/ US

Darling, Ryan James

Lilly Corporate Center, Indianapolis, IN 46285/ US

Galvin, Rachelle Jeanette

Lilly Corporate Center, Indianapolis, IN 46285/ US

Swanson, Barbara Anne

Lilly Corporate Center, Indianapolis, IN 46285/ US

(57)

1. Konstruirano protutijelo protiv DKK-1, ili njegov antigenski vežući fragment, naznačeno time što sadrži varijabilno područje la.lcog lanca (LCVR) i varijabilno područje teškog lanca (HCVR), gdje LCVR ima aminokiselinski slijed SEQ ID NO: 14, a HCVR ima aminokiselinski slijed SEQ ID NO: 12.

Patent sadrži još 3 patentnih zahtjeva

(11) **03379** (13) **B**

(51) **C07D 413/14**^(2006.01)

C07D 417/06^(2006.01)

C07D 279/16^(2006.01)

A61K 31/538^(2006.01)

C07D 413/06^(2006.01)

C07D 265/36^(2006.01)

A61K 31/5383^(2006.01)

(21) P-2019-99

(22) 08.06.2016

(30) 2851CH2015 08.06.2015 IN

(96) 16738860.2/08.06.2016

(86) IB PCT/IB2016/000771/08.06.2016

(87) WO 2016/198937/15.12.2016/2016/50

(97) EP 3303331/11.04.2018/2018/15

EP 3303331/27.02.2019/2019/09

(54) me **POZITIVNI ALOSTERNI MODULATORI MUSKARINSKOG M1 RECEPTORA**
en **MUSCARINIC M1 RECEPTOR POSITIVE ALLOSTERIC MODULATORS**

(73) Suven Life Sciences Limited

Serene Chambers Road - 5 Avenue - 7 Banjara Hills, Hyderabad, Telangana 500034/ IN

(72) NIROGI, Ramakrishna

Suven Life Sciences Limited Serene Chambers Road - 5 Avenue - 7 Banjara Hills, Hyderabad Talangana 500034/ IN

MOHAMMED, Abdul Rasheed

Suven Life Sciences Limited Serene Chambers Road - 5 Avenue - 7 Banjara Hills, Hyderabad Talangana 500034/ IN

SHINDE, Anil Karbhari

Suven Life Sciences Limited Serene Chambers Road - 5 Avenue - 7 Banjara Hills, Hyderabad Talangana 500034/ IN

GAGGINAPALLY, Shankar Reddy

Suven Life Sciences Limited Serene Chambers Road - 5 Avenue - 7 Banjara Hills, Hyderabad Talangana 500034/ IN

JASTI, Venkateswarlu

Suven Life Sciences Limited Serene Chambers Road - 5 Avenue - 7 Banjara Hills, Hyderabad Talangana 500034/ IN

(57)

1. Jedinjenje formule (I),

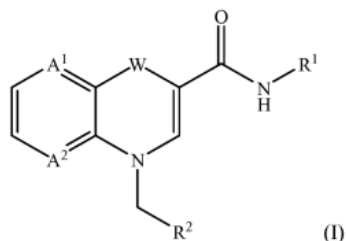

pri čemu:

A1 i A2 svaki nezavisno predstavlja CH, CF ili N;

W je O, S, S(O) ili S(O)₂;

R1 je

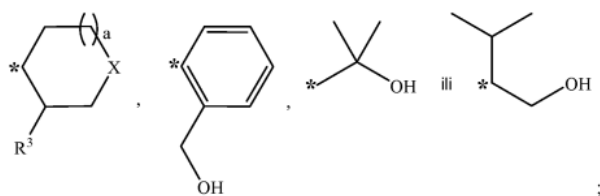

R2 je

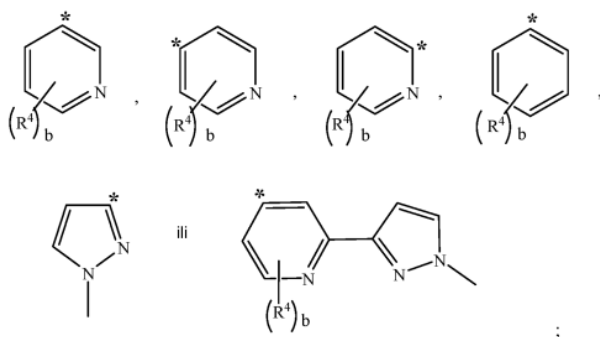

pri čemu * predstavlja tačku vezivanja;

R3 je OH, F, NH₂ ili H;

R4 je pri svakoj pojavi nezavisno izabran između halogena, -O-CH₃; -S-CH₃, -N(CH₃)₂, -CH₃, -CF₃, -CHF₂, -CH₂F, -OH, -CN, fenila, piridila i vodonika; pri čemu su fenil i piridil opciono supstituisani sa jednim ili više supstituenata izabranih iz grupe koja se sastoji od halogena ili CH₃;

X je CH₂, O ili NH;

a je 0 ili 1; i b je 1 ili 2;

ili izotopski oblik, stereoizomer, tautomer ili njegova farmaceutski prihvatljiva so.

Patent sadrži još 11 patentnih zahtjeva

(11) **03416** (13) **B**

(51) **C07D 401/12** ^(2006.01)
A61K 31/4155 ^(2006.01)
A61K 31/4178 ^(2006.01)
A61K 31/454 ^(2006.01)
A61P 3/10 ^(2006.01)

A41P 43/00 ^(2006.01)
C07D 403/12 ^(2006.01)
C07D 405/12 ^(2006.01)
C07D 405/14 ^(2006.01)

(21) P-2019-130

(22) 30.08.2012

(30) 188121 31.08.2011. JP
61573433P 06.09.2011. US

(96) 17157922.0/30.08.2012

(97) EP 3199533 / 02.08.2017 / 2017/131 A1
EP 3199533 /27.02.2019 /2019/09 B1

(54) me **SPOJ PIRAZOLA I NJEGOVA FARMACEUTSKA UPOTREBA**
en **PYRAZOLE COMPOUND AND PHARMACEUTICAL USE THEREOF**

(73) Japan Tobacco Inc.
2-1 Toranomom 2-chome, Minato-ku
Tokyo 105-8422 / JP

(72) MIURA, Tomoya
c/o Central Pharmaceutical Research Institute of Japan, Tobacco Inc.
1-1, Murasaki-cho, Takatsuki-shi
Osaka 569-1125 / JP

OGOSHI, Yosuke
c/o Central Pharmaceutical Research Institute of Japan, Tobacco Inc.
1-1, Murasaki-cho, Takatsuki-shi
Osaka 569-1125 / JP

UEYAMA, Kazuhito
c/o Central Pharmaceutical Research Institute of Japan, Tobacco Inc.
1-1, Murasaki-cho, Takatsuki-shi
Osaka 569-1125 / JP

MOTODA, Dai
c/o Central Pharmaceutical Research Institute of Japan, Tobacco Inc.
1-1, Murasaki-cho, Takatsuki-shi
Osaka 569-1125 / JP

IWAYAMA, Toshihiko
c/o Central Pharmaceutical Research Institute of Japan, Tobacco Inc.
1-1, Murasaki-cho, Takatsuki-shi
Osaka 569-1125 / JP

SUZAWA, Koichi
c/o Central Pharmaceutical Research Institute of Japan, Tobacco Inc.
1-1, Murasaki-cho, Takatsuki-shi
Osaka 569-1125 / JP

NAGAMORI, Hironobu
c/o Central Pharmaceutical Research Institute of Japan, Tobacco Inc.
1-1, Murasaki-cho, Takatsuki-shi
Osaka 569-1125 / JP

UENO, Hiroshi

c/o Central Pharmaceutical Research Institute of Japan, Tobacco Inc.

1-1, Murasaki-cho, Takatsuki-shi

Osska 569-1125 / JP

TAKAHASHI, Akihiko

c/o Central Pharmaceutical Research Institute of Japan, Tobacco Inc.

1-1, Murasaki-cho, Takatsuki-shi

Osska 569-1125 / JP

SUGIMOTO, Kazuyuki

c/o Central Pharmaceutical Research Institute of Japan, Tobacco Inc.

1-1, Murasaki-cho, Takatsuki-shi

Osska 569-1125 / JP

(57) 1. Spoj, ili njegova farmaceutski prihvatljiva sol, prikazan općom formulom [Ib]:

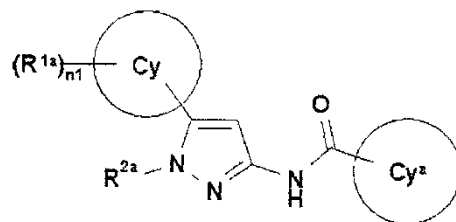

[Ib]

naznačen time što

prsten Cy je

(1) C₆₋₁₀ aril,

(2) C₃₋₈ cikloalkil ili

(3) C₃₋₈ cikloalkenil,

n₁ je 0, 1, 2, 3 ili 4,

R^{1a} je

(1) atom halogena,

(2) hidroksi,

(3) karboksi,

(4) C₁₋₆ alkilna skupina,

(5) C₂₋₈ alkenilna skupina,

(6) C₂₋₈ alkinilna skupina,

(7) C₁₋₆ alkoksi skupina,

(8) C₃₋₆ cikloalkilna skupina,

(9) halogen C₁₋₆ alkilna skupina,

(10) hidroksi C₁₋₆ alkilna skupina,

- (11) C₁₋₆ alkoksi C₁₋₆ alkilna skupina,
- (12) halogen C₁₋₆ alkoksi C₁₋₆ alkilna skupina,
- (13) C₁₋₆ alkilsulfonyl C₁₋₆ alkilna skupina,
- (14) halogen C₁₋₆ alkilsulfonyl C₁₋₆ alkilna skupina,
- (15) halogen C₁₋₆ alkilamino C₁₋₆ alkilna skupina,
- (16) C₃₋₆ cikloalkil C₂₋₆ alkinilna skupina,
- (17) halogen C₁₋₆ alkoksi skupina,
- (18) karboksi C₁₋₆ alkoksi skupina,
- (19) C₁₋₆ alkilsulfanilna skupina,
- (20) C₁₋₆ alkilsulfonylna skupina,
- (21) halogen C₁₋₆ alkilsulfonylna skupina,
- (22) C₁₋₈ alkilkarbonilna skupina,
- (23) C₁₋₆ alkiloksikarbonilna skupina,
- (24) skupina prikazana formulom:

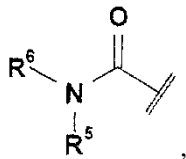

gdje

R⁵ je

- (a) atom vodika ili
- (b) C₁₋₆ alkilna skupina, i

R⁶ je

- (a) C₁₋₆ alkilna skupina ili
- (b) halogen C₁₋₆ alkilna skupina,

- (25) zasićena heterociklo C₁₋₆ alkilna skupina (gdje je zasićeni heterocikl 4-eročlani do 6-eročlani zasićeni heterocikl s 1 do 2 heteroatoma, koje se bira između dušika, kisika i sumpora) ili
- (26) zasićena heterociklo oksid C₁₋₆ alkilna skupina (gdje je zasićeni heterocikl 4-eročlani do 6-eročlani zasićeni heterocikl s 1 do 2 heteroatoma, koje se bira između dušika, kisika i sumpora),

uz uvjet da kada je n1 2, 3 ili 4, svaki R^{1a} je isti ili različiti,

R^{2a} je

- (1) C₁₋₈ alkilna skupina,
- (2) C₃₋₈ cikloalkil C₁₋₆ alkilna skupina,
- (3) C₆₋₁₀ aril C₁₋₆ alkilna skupina,
- (4) zasićena heterociklo C₁₋₆ alkilna skupina (gdje je zasićeni heterocikl 4-eročlani do 6-eročlani zasićeni heterocikl s 1 do 2 heteroatoma, koje se bira između dušika, kisika i sumpora),
- (5) C₃₋₈ cikloalkilna skupina,
- (6) halogen C₁₋₆ alkilna skupina,
- (7) C₁₋₆ alkoksi C₁₋₆ alkilna skupina,
- (8) halogen C₃₋₈ cikloalkilna skupina,
- (9) C₆₋₁₀ arilna skupina (gdje C₆₋₁₀ arilna skupina može biti supstituirana s 1 do 4 supstituenta, koje se bira između
 - (a) atoma halogena,
 - (b) hidroksi,
 - (c) C₁₋₆ alkilne skupine,
 - (d) C₂₋₈ alkenilne skupine,
 - (e) C₂₋₆ alkinilne skupine,
 - (f) C₁₋₆ alkoksi skupine,
 - (g) halogen C₁₋₆ alkilne skupine,
 - (h) C₁₋₆ alkoksi C₁₋₆ alkilne skupine,
 - (i) halogen C₁₋₆ alkoksi skupine,
 - (j) hidroksi C₁₋₆ alkoksi skupine,
 - (k) C₁₋₆ alkoksi C₁₋₆ alkoksi skupine,
 - (l) karboksi C₁₋₆ alkoksi skupine,
 - (m) C₆₋₁₀ aril C₁₋₆ alkoksi skupine,
 - (n) C₁₋₆ alkilsulfanil C₁₋₆ alkoksi skupine,
 - (o) C₁₋₆ alkilsulfonil C₁₋₆ alkoksi skupine,
 - (p) C₆₋₁₀ aril C₁₋₆ alkoksi C₁₋₆ alkoksi skupine,

(q) zasićene heterociklo C₁₋₆ alkoksi skupine (gdje je zasićeni heterocikl 4-eročlani do 6-eročlani zasićeni heterocikl s 1 do 2 heteroatoma, koje se bira između dušika, kisika i sumpora, te može biti supstituiran s 1 do 2 C₁₋₆ alkilne skupine),

(r) zasićene heterociklo okski skupine (gdje je zasićeni heterocikl a 4-eročlani do 6-eročlani zasićeni heterocikl s 1 do 2 heteroatoma, koje se bira između dušika, kisika i sumpora),

(s) C₃₋₈ cikloalkiloksi skupine,

(t) C₁₋₆ alkoksikarboniloksi skupine i

(u) C₁₋₆ alkilsulfonilne skupine), ili

(10) zasićena heterociklička skupina (gdje je zasićeni heterocikl 4-eročlani do 6-eročlani zasićeni heterocikl s 1 do 2 heteroatoma, koje se bira između dušika, kisika i sumpora, te može biti supstituiran s 1 do 4 C₁₋₆ alkilne skupine), i

prsten Cy^a je skupina koju se bira između

(1) skupine prikazane formulom:

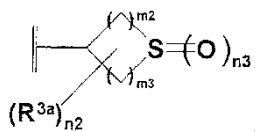

gdje

m_2 je 1, 2 ili 3,

m_3 je 1, 2 ili 3,

n_3 je 1 ili 2,

(2) skupine prikazane formulom:

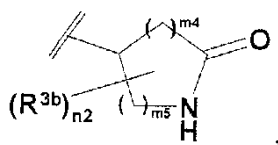

gdje

m_4 je 0, 1, 2 ili 3,

m_5 je 0, 1 ili 2,

uz uvjet da je zbroj m_4 i m_5 1 ili više,

(3) skupine prikazane formulom:

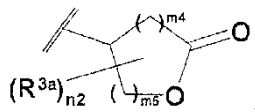

gdje

m_4 je 0, 1, 2 ili 3,

m_5 je 0, 1 ili 2,

uz uvjet da je zbroj m_4 i m_5 1 ili više,

(4) skupine prikazane formulom:

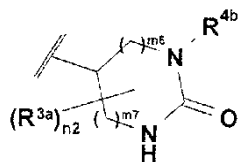

gdje

m_6 je 0, 1 ili 2,

m_7 je 0, 1 ili 2,

uz uvjet da je zbroj m_6 i m_7 1 ili više,

(5) skupine prikazane formulom:

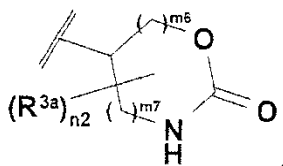

gdje

m_6 je 0, 1 ili 2,

m_7 je 0, 1 ili 2,

uz uvjet da je zbroj m_6 i m_7 1 ili više,

(6) skupine prikazane formulom:

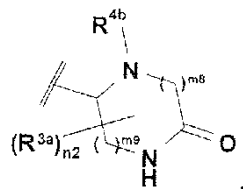

gdje

m_8 je 1 ili 2,

m_9 je 1 ili 2, i

(7) skupine prikazane formulom:

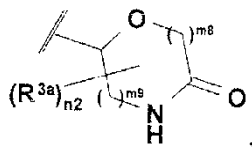

gdje

m_8 je 1 ili 2,

m_9 je 1 ili 2,

n_2 je 0, 1, 2, 3 ili 4,

R^{3a} je

- (1) hidroksi,
- (2) C_{1-6} alkilna skupina ili
- (3) hidroksi C_{1-6} alkilna skupina,

uz uvjet da kada je n_2 2, 3 ili 4, svaki R^{3a} je isti ili različiti,

R^{3b} je

- (1) hidroksi,
- (2) C_{1-6} alkilna skupina (koja može tvoriti C_{3-6} cikloalkilnu skupinu zajedno s ugljikom na kojeg je vezana i s njemu susjednim ugljikom) ili
- (3) hidroksi C_{1-6} alkilna skupina, ili
- (4) kada su dva R^{3b} vezana na isti ugljik, mogu tvoriti C_{3-6} cikloalkilnu skupinu zajedno s ugljikom na kojeg su vezani,

uz uvjet da kada je n_2 2, 3 ili 4, svaki R^{3b} je isti ili različiti, i

R^{4b} je

- (1) atom vodika,
- (2) C_{1-6} alkilna skupina,
- (3) karboksi C_{1-6} alkilna skupina,
- (4) halogen C_{1-6} alkilna skupina ili
- (5) C_{1-6} alkoksi C_{1-6} alkilna skupina.

Patent sadrži još 20 patentnih zahtjeva

Objava zahtjeva za proširenje evropskih prijava patenata

(51) MKP
B32B 5/14 2006 (97) EP 3559365
C04B 28/14 2006
E04C 2/04 2006
(96) EP 16834274.9 12/20/2016
(97) EP 3559365, 10/30/2019 201944, en
(54) GYPSUM PLASTERBOARD
(72) HERTFURTH, Dominik, Pfaffensteig 8, 97346 Iphofen, DE
FRIEDEL, Felix, Thüringerstrasse 24, 91325 Adelsdorf, DE

(51) MKP
A61K 9/70 2006 (97) EP 3257504
A61K 31/381 2006
(96) EP 17185284.1 12/22/2010
(97) EP 3257504, 1/8/2020 202002, en
(31) 289302 P (32) 22.12.2009 (33) US
(54) POLYVINYLPIRROLIDONE FOR THE STABILIZATION OF A SOLID DISPERSION OF THE NON-CRYSTALLINE FORM OF ROTIGOTINE
(71) UCB Biopharma SRL, Allé de la Recherche 60, 1070 Brussels, BE
LTS Lohmann Therapie-Systeme AG, Lohmannstrasse 2, 56626 Andernach, DE
(72) Wolff, Hans-Michael, Schwarz Biosciences GmbH Alfred-Nobel-Strasse 10, 40789 Monheim, DE
Arth, Christoph, Schwarz Biosciences GmbH Alfred-Nobel-Strasse 10, 40789 Monheim, DE
Quere, Luc, UCB Pharma SA Chemin du Foriest, 1420 Braine-l'Allued, BE
Müller, Walter, UCB Pharma SA Chemin du Foriest, 1420 Braine-l'Allued, BE

(51) MKP
B01J 8/10 2006 (97) EP 3441136
B01J 8/22 2006
B01J 8/38 2006
B01J 19/18 2006
C10L 1/08 2006
F04C 7/00 2006
F04C 19/00 2006
(96) EP 17185413.6 8/8/2017
(97) EP 3441136, 11/20/2019 201947, de
(54) DEVICE FOR CRUSHING AND MIXING, SYSTEM AND METHOD FOR CATALYTIC PRESSURELESS OILING
(71) Tuma Pumpensysteme GmbH, Eitnerstrasse 12, 1230 Wien, AT
(72) Mittinger, Robert, Schillerstrasse 12/1, 2351 Wiener Neudorf, AT

(51) MKP
G06F 8/35 2018 (97) EP 3486766
G06F 11/36 2006
G06F 17/50 2006
G06Q 30/08 2012
(96) EP 17202216.2 11/17/2017
(97) EP 3486766, 1/1/2020 202001, en
(54) COMPUTER-IMPLEMENTED METHOD OF AUGMENTING A SIMULATION MODEL OF A PHYSICAL ENVIRONMENT OF A VEHICLE
(71) Steinbeis Interagierende Systeme GmbH, Martinstr. 42-44, 73728 Esslingen, DE

(72) Ulmer, Daniel, Lauterstraße 30, 71083 Herrenberg, DE
 Bühler, Oliver, Trinkäcker 7, 73271 Holzmaden, DE
 Wittel, Steffen, Frontalstraße 35, 75392 Deckenpfronn, DE

(51) MKP
G01N 33/558 2006 (97) EP 3489686
G01N 33/569 2006
 (96) EP 17203120.5 11/22/2017
 (97) EP 3489686, 1/8/2020 202002, en
 (54) METHOD AND DEVICE FOR DISCRIMINATING BETWEEN VIRAL AND BACTERIAL INFECTIONS
 (71) Jakschies, Detlef, Teichhöfe 7, 30659 Hannover, DE
 von Mutius, Dietrich, Dahlwitzer Strasse 78, 15366 Neuenhagen, DE
 Erber, Walter, Maroltingergasse 49, 2303, 1160 Wien, AT
 (72) JAKSCHIES, Detlef, Teichhöfe 7, 30659 Hannover, DE

(51) MKP
B29C 65/48 2006 (97) EP 3489003
B29D 22/02 2006
B29K 105/04 2006
B63B 7/08 2006
B63C 1/02 2006
 (96) EP 17203543.8 11/24/2017
 (97) EP 3489003, 1/8/2020 202002, en
 (54) METHOD OF MANUFACTURE OF AN INFLATABLE PRODUCT WITH AN ATTACHABLE FOAM FINISH
 (71) NautiBuoy Marine Limited, 1 Hunters Moon House Dartington, Totnes, Devon TQ9 6EZ, GB
 (72) BUILDER, Clay, 1 Hunters Moon House Dartington, Totnes, Devon TQ9 6EZ, GB
 ANDERSON, Nina, 1 Hunters Moon House Dartington, Totnes, Devon TQ9 6EZ, GB

(51) MKP
A61K 8/04 2006 (97) EP 3492143
A61K 8/73 2006
A61Q 11/00 2006
 (96) EP 17204327.5 11/29/2017
 (97) EP 3492143, 1/8/2020 202002, de
 (54) LOW VISCOSITY DENTAL CARE COMPOSITION
 (72) Sörgel, Norbert, Münchenerstr. 42, 82031 Gröndwald, DE
 Keiner, Michael, Rotkehlchenweg 10, 35619 Braunfels, DE

(51) MKP
A61K 31/58 2006 (97) EP 3558376
A61K 35/00 2006
A61K 45/06 2006
 (96) EP 17837879.0 12/19/2017
 (97) EP 3558376, 10/30/2019 201944, en
 (31) 16206232 (32) 22.12.2016 (33) EP
 (54) A THERAPEUTIC COMBINATION COMPRISING A PULMONARY SURFACTANT AND A STEROID FOR THE TREATMENT OF EVOLVING BPD
 (72) FABBRI, Laura, c/o CHIESI FARMACEUTICI S.p.A. Via Palermo 26/A, 43122 Parma, IT
 SALOMONE, Fabrizio, c/o CHIESI FARMACEUTICI S.p.A. Via Palermo 26/A, 43122 Parma, IT

(51) MKP
A61K 47/65 2017 (97) EP 3558388
A61P 35/00 2006
 (96) EP 17837949.1 12/14/2017
 (97) EP 3558388, 10/30/2019 201944, de
 (31) 16205868 (32) 21.12.2016 (33) EP
 (54) ANTIBODY DRUG CONJUGATES (ADCS) HAVING ENZYMATICALLY CLEAVABLE GROUPS
 (72) LERCHEN, Hans-Georg, Sürderstr. 3, 51375 Leverkusen, DE
 REBSTOCK, Anne-Sophie, 11 rue du Pavé, 69410 Champagne au Mont d'Or, FR
 STELTE-LUDWIG, Beatrix, Görtzheide 10F, 42489 Wülfrath, DE
 KIRCHHOFF, Dennis, Charlottenburger Str. 25, 13086 Berlin, DE
 DIETZ, Lisa, An der Grenze 17, 42111 Wuppertal, DE

MAHLERT, Christoph, Kranichweg 11, 42111 Wuppertal, DE
 GREVEN, Simone, Am Schneckenacker 45, 41541 Dormagen, DE
 MÄRSCH, Stephan, Kleine Hartwichstr. 25, 50733 Köln, DE
 BERNDT, Sandra, Käthestr. 9, 16540 Hohen Neuendorf, DE
 SOMMER, Anette, Chodowiecki Str. 28, 10405 Berlin, DE
 HAMMER, Stefanie, Neue Welt 12, 10247 Berlin, DE

(51) MKP
C07K 14/195 2006 (97) EP 3559022
C07K 14/52 2006
C12N 15/70 2006
C12N 15/74 2006
 (96) EP 17837961.6 12/20/2017
 (97) EP 3559022, 10/30/2019 201944, en
 (31) 16205439 (32) 20.12.2016 (33) EP
 (54) VIRULENCE ATTENUATED BACTERIA BASED PROTEIN DELIVERY
 (72) ITTIG, Simon, Zehntenfreistrasse 32, 4103 Bottmingen, CH
 AMSTUTZ, Marlise, Wittlingerstrasse 140, 4058 Basel, CH
 KASPER, Christoph, Ruttigerweg 4, 4600 Olten, CH

(51) MKP
A61K 31/4439 2006 (97) EP 3558973
A61K 31/444 2006
A61P 37/00 2006
C07D 213/81 2006
C07D 401/12 2006
C07D 401/14 2006
C07D 413/14 2006
C07D 513/04 2006
 (96) EP 17838020.0 12/21/2017
 (97) EP 3558973, 10/30/2019 201944, en
 (31) 201662438020 P (32) 22.12.2016 (33) US
 201762487356 P 19.04.2017 US
 (54) PYRIDINE DERIVATIVES AS IMMUNOMODULATORS
 (72) WU, Liangxing, Incyte Corporation 1801 Augustine Cut-Off, Wilmington, Delaware 19803, US
 YU, Zhiyong, Incyte Corporation 1801 Augustine Cut-Off, Wilmington, Delaware 19803, US
 ZHANG, Fenglei, Incyte Corporation 1801 Augustine Cut-Off, Wilmington, Delaware 19803, US
 YAO, Wenqing, Incyte Corporation 1801 Augustine Cut-Off, Wilmington, Delaware 19803, US

(51) MKP
A61P 35/00 2006 (97) EP 3559040
C07K 16/28 2006
 (96) EP 17838041.6 12/21/2017
 (97) EP 3559040, 10/30/2019 201944, en
 (31) 201662437770 P (32) 22.12.2016 (33) US
 17155973 14.02.2017 EP
 (54) BINDING MOLECULES FOR THE TREATMENT OF CANCER
 (72) KUENKELE, Klaus-Peter, Boehringer Ingelheim GmbH/ Corporate Patents Binger Strasse 173, 55216 Ingelheim Am Rhein, DE
 FENN, Timothy, c/o VP IP Legal Boehringer Ingelheim USA Corp. 900 Ridgebury Road P.O. Box 368, Ridgefield, CT 06877-0368, US
 GARCIA-MARTINEZ, Juan, Manuel, Boehringer Ingelheim GmbH/ Corporate Patents Binger Strasse 173, 55216 Ingelheim Am Rhein, DE
 HO, Jason, 34 Beech Court, Colledgeville, PA 19426, US
 KOESSL, Christian, Boehringer Ingelheim GmbH/ Corporate Patents Binger Strasse 173, 55216 Ingelheim Am Rhein, DE
 SEN, Saurabh, c/o VP IP Legal Boehringer Ingelheim USA Corp. 900 Ridgebury Road P.O. Box 368, Ridgefield, CT 06877-0368, US
 VOYNOV, Vladimir, c/o VP IP Legal Boehringer Ingelheim USA Corp. 900 Ridgebury Road P.O. Box 368, Ridgefield, CT 06877-0368, US
 WERNITZNIG, Andreas, Boehringer Ingelheim GmbH/ Corporate Patents Binger Strasse 173, 55216 Ingelheim Am Rhein, DE
 ERYILMAZ, Ertan, c/o VP IP Legal Boehringer Ingelheim USA Corp. 900 Ridgebury Road P.O. Box 368, Ridgefield, CT 06877-0368, US
 SHAABAN, Abdulsalam, c/o VP IP Legal Boehringer Ingelheim USA Corp. 900 Ridgebury Road P.O. Box 368, Ridgefield, CT 06877-0368, US
 GANESAN, Rajkumar, c/o VP IP Legal Boehringer Ingelheim USA Corp. 900 Ridgebury Road P.O. Box 368, Ridgefield, CT 06877-0368, US

(51) MKP
A61K 39/12 2006 (97) EP 3551224
A61K 39/235 2006
C07K 14/075 2006

C12N 15/861 2006
 (96) EP 17838152.1 12/7/2017
 (97) EP 3551224, 10/16/2019 201942, en
 (31) 201620968 (32) 09.12.2016 (33) GB
 (54) ADENOVIRUS POLYNUCLEOTIDES AND POLYPEPTIDES
 (72) AMMENDOLA, Virginia, Via di Castel Romano 100, 00128 Rome, IT
 CAPONE, Stefania, Via di Castel Romano 100, 00128 Rome, IT
 COLLOCA, Stefano, Via Salaria 73, 00198 Rome, IT
 FOLGORI, Antonella, Via di Castel Romano 100, 00128 Rome, IT
 MERONE, Rosella, Via di Castel Romano 100, 00128 Rome, IT

(51) MKP
F16K 1/12 2006 (97) EP 3563208
G05D 16/06 2006
G05D 16/16 2006
 (96) EP 17840460.4 12/22/2017
 (97) EP 3563208, 11/6/2019 201945, en
 (31) P20161198 (32) 29.12.2016 (33) RS
 (54) AXIAL GAS PRESSURE REGULATOR
 (71) Gas Teh Ltd, Kralja Petra 1bb, 22320 Indjija, RS
 (72) SADZAKOVIC, Miroљjub, Gandijeva 170, 11070 Novi Beograd, RS

(51) MKP
A61K 31/423 2006 (97) EP 3558985
A61P 37/00 2006
C07D 413/06 2006
C07D 413/12 2006
C07D 413/14 2006
C07D 471/04 2006
C07D 487/04 2006
C07D 498/04 2006
C07D 513/04 2006
 (96) EP 17840466.1 12/21/2017
 (97) EP 3558985, 10/30/2019 201944, en
 (31) 201662438009 P (32) 22.12.2016 (33) US
 201762487336 P 19.04.2017 US
 201762551033 P 28.08.2017 US
 (54) BENZOOXAZOLE DERIVATIVES AS IMMUNOMODULATORS
 (72) WU, Liangxing, Incyte Corporation 1801 Augustine Cut-Off, Wilmington Delaware 19803, US
 LI, Jingwei, Incyte Corporation 1801 Augustine Cut-Off, Wilmington Delaware 19803, US
 QI, Chao, Incyte Corporation 1801 Augustine Cut-Off, Wilmington Delaware 19803, US
 ZHANG, Fenglei, Incyte Corporation 1801 Augustine Cut-Off, Wilmington Delaware 19803, US
 LI, Zhenwu, Incyte Corporation 1801 Augustine Cut-Off, Wilmington Delaware 19803, US
 ZHU, Wenyu, Incyte Corporation 1801 Augustine Cut-Off, Wilmington Delaware 19803, US
 YU, Zhiyong, Incyte Corporation 1801 Augustine Cut-Off, Wilmington Delaware 19803, US
 XIAO, Kaijiong, Incyte Corporation 1801 Augustine Cut-Off, Wilmington Delaware 19803, US
 LU, Liang, Incyte Corporation 1801 Augustine Cut-Off, Wilmington Delaware 19803, US
 MEI, Song, Incyte Corporation 1801 Augustine Cut-Off, Wilmington Delaware 19803, US
 QIAN, Ding-Quan, Incyte Corporation 1801 Augustine Cut-Off, Wilmington Delaware 19803, US
 HE, Chunhong, Incyte Corporation 1801 Augustine Cut-Off, Wilmington Delaware 19803, US
 YE, Yingda, Incyte Corporation 1801 Augustine Cut-Off, Wilmington Delaware 19803, US
 XU, Meizhong, Incyte Corporation 1801 Augustine Cut-Off, Wilmington Delaware 19803, US
 YAO, Wenqing, Incyte Corporation 1801 Augustine Cut-Off, Wilmington Delaware 19803, US

(51) MKP
A61K 39/09 2006 (97) EP 3562503
A61K 47/64 2017
A61P 31/04 2006
 (96) EP 17840524.7 12/29/2017
 (97) EP 3562503, 11/6/2019 201945, en
 (31) 201662441115 P (32) 30.12.2016 (33) US
 201762530803 P 10.07.2017 US
 201762568201 P 04.10.2017 US
 201762591160 P 27.11.2017 US

(54) POLYPEPTIDE-ANTIGEN CONJUGATES WITH NON-NATURAL AMINO ACIDS

(71) SutroVax, Inc., 353 Hatch Drive, Foster City, California 94404, US

(72) FAIRMAN, Jeffery, 114 Pacchetti Way, Mountain View, California 94040, US
HEINRICH, Jon, 4247 Arbor Lane, Doylestown, California 18902, US
CHAN, Wei, 173 Stoneridge Lane, San Francisco, California 94134, US

(51) MKP
B60K 6/48 2007 (97) EP 3551489

(96) EP 17842397.6 12/1/2017

(97) EP 3551489, 10/16/2019 201942, en

(31) 201600123644 (32) 06.12.2016 (33) IT

(54) APPARATUS FOR SELECTIVELY SHARING THE POWER OF A MULTIDRIVE UNIT VEHICLE

(72) MAZZINI, Samuele, Zona S. Lorenzo 120, 06019 Umbertide (PG), IT

(51) MKP
A61K 31/4439 2006 (97) EP 3558969

A61K 31/444 2006

A61K 31/4725 2006

A61K 31/538 2006

A61P 35/00 2006

C07D 401/12 2006

C07D 401/14 2006

C07D 405/14 2006

C07D 413/14 2006

C07D 417/14 2006

C07D 471/04 2006

C07D 487/04 2006

C07D 491/04 2006

C07D 495/04 2006

(96) EP 17851862.7 12/20/2017

(97) EP 3558969, 10/30/2019 201944, en

(31) 201662437384 P (32) 21.12.2016 (33) US

(54) PYRAZOLE DERIVATIVES AS MALT1 INHIBITORS

(72) LU, Tianbao, Welsh & McKean Roads, Spring House, Pennsylvania 19477, US

ALLISON, Brett Douglas, 3210 Merryfield Row, San Diego, California 92121, US

BARBAY, Joseph Kent, Welsh & McKean Roads, Spring House, Pennsylvania 19477, US

CONNOLLY, Peter J., Welsh & McKean Roads, Spring House, Pennsylvania 19477, US

CUMMINGS, Maxwell David, Welsh & McKean Roads, Spring House, Pennsylvania 19477, US

DIELS, Gaston, Turnhoutseweg 30, B-2340 Beerse, BE

EDWARDS, James Patrick, Welsh & McKean Roads, Spring House, Pennsylvania 19477, US

KREUTTER, Kevin D., Welsh & McKean Roads, Spring House, Pennsylvania 19477, US

PHILIPPAR, Ulrike, Turnhoutseweg 30, B-2340 Beerse, BE

SHEN, Fang, Welsh & McKean Roads, Spring House, Pennsylvania 19477, US

THURING, Johannes Wilhelmus John Fitzgerald, Turnhoutseweg 30, B-2340 Beerse, BE

WU, Tongfei, Turnhoutseweg 30, B-2340 Beerse, BE

BERTHELOT, Didier Jean-Claude, 1 rue Camille Desmoulins, TSA 91003, 92787 Issy-les-Moulineaux Cedex 9, FR

(51) MKP
A23L 33/105 2016 (97) EP 3453381

A23L 33/15 2016

A23L 33/175 2016

A61K 8/97 2017

A61K 9/48 2006

A61K 31/197 2006

A61K 31/4188 2006

A61K 47/18 2017

(96) EP 17190217.4 9/8/2017

(97) EP 3453381, 10/23/2019 201943, en

(54) METHOD AND USE OF A COMPOSITION FOR IMPROVING HAIR APPEARANCE

(71) Bayer Consumer Care AG, Peter Merian-Strasse 84, 4052 Basel, CH

(72) Boudon, Stephanie, Liebrütstrasse 42, 4303 Kaiseraugst, CH

Kurka, Peter, Peter Merian strasse 84, 4002 Basel, CH

Gnacke, Christina, Christinastrasse 62, 50733 Köln, DE

Zhang, Lei, Turbinenstrasse 60, 8005 Zürich, CH

- (51) MKP
C07K 16/24 2006 (97) EP 3456736
- (96) EP 17191987.1 9/19/2017
 (97) EP 3456736, 10/30/2019 201944, en
 (54) ANTIBODY VARIANTS
 (72) FURRER, Esther, c/o Tillotts Pharma AG Baslerstrasse 15, 4310 Rheinfelden, CH

- (51) MKP
C07K 16/24 2006 (97) EP 3456737
- (96) EP 17191988.9 9/19/2017
 (97) EP 3456737, 10/30/2019 201944, en
 (54) ANTIBODY VARIANTS
 (72) FURRER, Esther, c/o Tillotts Pharma AG Baslerstrasse 15, 4310 Rheinfelden, CH

- (51) MKP
C07K 16/24 2006 (97) EP 3456738
- (96) EP 17191989.7 9/19/2017
 (97) EP 3456738, 10/23/2019 201943, en
 (54) ANTIBODY VARIANTS
 (72) FURRER, Esther, c/o Tillotts Pharma AG Baslerstrasse 15, 4310 Rheinfelden, CH

- (51) MKP
A61K 9/16 2006 (97) EP 3459527
A61K 39/00 2006
- (96) EP 17192259.4 9/20/2017
 (97) EP 3459527, 11/6/2019 201945, en
 (54) METHOD FOR PREPARING A SOLID DOSAGE FORM COMPRISING ANTIBODIES BY WET GRANULATION, EXTRUSION AND SPHERONIZATION
 (72) VARUM, Felipe, c/o Tillotts Pharma AG Baslerstrasse 15, 4310 Rheinfelden, CH
 DECOLLOGNY, Sophie, Birsstrasse 240, 4052 Basel, CH
 BRAVO, Roberto, c/o Tillotts Pharma AG Baslerstrasse 15, 4310 Rheinfelden, CH

- (51) MKP
A61K 9/16 2006 (97) EP 3459528
A61K 39/00 2006
- (96) EP 17192260.2 9/20/2017
 (97) EP 3459528, 11/6/2019 201945, en
 (54) PREPARATION OF SOLID DOSAGE FORMS COMPRISING ANTIBODIES BY SOLUTION/SUSPENSION LAYERING
 (72) VARUM, Felipe, c/o Tillotts Pharma AG Baslerstrasse 15, 4310 Rheinfelden, CH

- (51) MKP
A61K 9/16 2006 (97) EP 3459529
A61K 39/00 2006
C07K 16/24 2006
- (96) EP 17192261.0 9/20/2017
 (97) EP 3459529, 11/6/2019 201945, en
 (54) PREPARATION OF SUSTAINED RELEASE SOLID DOSAGE FORMS COMPRISING ANTIBODIES BY SPRAY DRYING
 (72) BRUNO, Cristina, c/o Tillotts Pharma AG Baslerstrasse 15, 4310 Rheinfelden, CH
 VARUM, Felipe, c/o Tillotts Pharma AG Baslerstrasse 15, 4310 Rheinfelden, CH
 BRAVO, Roberto, c/o Tillotts Pharma AG Baslerstrasse 15, 4310 Rheinfelden, CH

- (51) MKP
G01N 15/02 2006 (97) EP 3580550
G01N 15/14 2006
G01N 21/47 2006
G01N 21/51 2006
G01N 35/00 2006
G01N 35/04 2006

- (96) EP 17708358.1 2/10/2017
 (97) EP 3580550, 12/18/2019 201951, en
 (54) IMAGING SYSTEM FOR COUNTING AND SIZING PARTICLES IN FLUID-FILLED VESSELS
 (72) FRADKIN, Dmitry, 5510 Owensmouth Avenue 304, Woodland Hills, CA 93167, US
 MILNE, Graham, F., 436 Poli Street Unit 309, Ventura, CA 93001, US
 PEARSON, Thomas, Clark, 4182 Greenwood Drive, Newbury Park, CA 91320, US

- (51) MKP
G01N 33/52 2006 (97) EP 3552018
G01N 33/543 2006
G01N 33/558 2006

- (96) EP 17709225.1 2/13/2017
 (97) EP 3552018, 10/16/2019 201942, en
 (31) 201662432022 P (32) 09.12.2016 (33) US
 (54) DIAGNOSTIC TESTING ASSAYS AND RELATED DEVICES WITH SECURITY AND METHODS OF USE THEREOF
 (71) Cellmic, LLC, 8901 S. La Cienega Blvd. Suite 206, Inglewood, California 90301, US
 (72) KARLOVAC, Neven, 8901 S. La Cienega Blvd. Suite 206, Inglewood, CA 90301, US
 MUDANYALI, Onur, 8901 S. La Cienega Blvd. Suite 206, Inglewood, CA 90301, US

- (51) MKP
A61K 38/46 2006 (97) EP 3449933
A61K 47/68 2017
C07K 16/44 2006
C07K 16/46 2006
C07K 19/00 2006
C12N 9/22 2006
C12N 15/55 2006
C12N 15/62 2006

- (96) EP 18167227.0 4/27/2012
 (97) EP 3449933, 10/16/2019 201942, en
 (31) 201161480961 P (32) 29.04.2011 (33) US
 201261617241 P 29.03.2012 US
 (54) THERAPEUTIC NUCLEASE COMPOSITIONS AND METHODS
 (71) University of Washington, UW Center for Commercialization 4311 11th Avenue N.E., Suite 500, Seattle, WA 98105-4608, US
 (72) LEDBETTER, Jeffrey, University of Washington UW Center for Commercialization 4311 11th Avenue N.E., Suite 500, London, WA 98105-4608, US
 HAYDEN-LEDBETTER, Martha, University of Washington UW Center for Commercialization 4311 11th Avenue N.E., Suite 500, Seattle, WA 98105-4608, US
 ELKON, Keith, University of Washington UW Center for Commercialization 4311 11th Avenue N.E., Suite 500, Seattle, WA 98105-4608, US
 SUN, Xizhang, University of Washington UW Center for Commercialization 4311 11th Avenue N.E., Suite 500, Seattle, WA 98105-4608, US

- (51) MKP
F41A 27/08 2006 (97) EP 3569967
F41A 27/10 2006

- (96) EP 18172092.1 5/14/2018
 (97) EP 3569967, 11/20/2019 201947, de
 (54) CARDAN MOUNT
 (71) Achleitner, Franz, Weitschön 80, 6250 Kundl, AT
 (72) Achleitner, Franz, Weitschön 80, 6250 Kundl, AT

- (51) MKP
A61K 39/395 2006 (97) EP 3250597
A61P 27/02 2006
A61P 35/00 2006
C07K 16/22 2006

- (96) EP 16703684.7 1/25/2016
 (97) EP 3250597, 1/1/2020 202001, en
 (31) 201562108600 P (32) 28.01.2015 (33) US
 (54) VEGFA/ANG2 COMPOUNDS
 (72) LEUNG, Donmienne Doen Mun, c/o Eli Lilly and Company P.O. Box 6288, Indianapolis, Indiana 46206-6288, US
 TANG, Ying, c/o Eli Lilly and Company P.O. Box 6288, Indianapolis, Indiana 46206-6288, US
 VAILLANCOURT, Peter Edward, c/o Eli Lilly and Company P.O. Box 6288, Indianapolis, Indiana 46206-6288, US
 XU, Jianghuai, c/o Eli Lilly and Company P.O. Box 6288, Indianapolis, Indiana 46206-6288, US

(51) MKP
C07K 16/00 2006 (97) EP 3247721
C07K 16/28 2006
C07K 16/32 2006

(96) EP 16704512.9 1/21/2016
(97) EP 3247721, 12/18/2019 201951, en
(31) 201562106494 P (32) 22.01.2015 (33) US

(54) IgG BISPECIFIC ANTIBODIES AND PROCESSES FOR PREPARATION
(72) ALDAZ, Hector, c/o Eli Lilly and Company P. O. Box 6288, Indianapolis, Indiana 46206-6288, US
ATWELL, Shane, c/o Eli Lilly and Company P. O. Box 6288, Indianapolis, Indiana 46206-6288, US
DEMAREST, Stephen J., c/o Eli Lilly and Company P. O. Box 6288, Indianapolis, Indiana 46206-6288, US
FRONING, Karen J., c/o Eli Lilly and Company P. O. Box 6288, Indianapolis, Indiana 46206-6288, US
KUHLMAN, Brian Arthur, c/o Eli Lilly and Company P. O. Box 6288, Indianapolis, Indiana 46206-6288, US
LEAVER-FAY, Andrew Philip, c/o Eli Lilly and Company P. O. Box 6288, Indianapolis, Indiana 46206-6288, US

(51) MKP
A61M 5/20 2006 (97) EP 3573687
A61M 5/315 2006

(96) EP 17716594.1 1/25/2017
(97) EP 3573687, 12/4/2019 201949, en
(54) DOSE CONTROL SYSTEM FOR INJECTABLE-DRUG DELIVERY DEVICES AND ASSOCIATED METHODS OF USE
(72) ALDON, Lionel, 1, chemin du Ténére Varennes, 63450 Chanonat, FR
MARCOZ, Alain, Espinasse Haut, 63160 Montmorin, FR

(51) MKP
A47J 47/00 2006 (97) EP 3552529

(96) EP 18425027.2 4/10/2018
(97) EP 3552529, 10/16/2019 201942, en
(54) AN INNOVATIVE CHOPPING BOARD EQUIPPED WITH A PROTECTIVE EDGE
(71) Cheli, Gabriele, Via Santa Vigilia 16, 57122 Livorno (LI), IT
(72) Cheli, Gabriele, Via Santa Vigilia 16, 57122 Livorno (LI), IT

(51) MKP
B66F 7/06 2006 (97) EP 3573919
B66F 9/06 2006
B66F 9/075 2006

(96) EP 18700757.0 1/17/2018
(97) EP 3573919, 12/4/2019 201949, de
(31) 102017201108 (32) 24.01.2017 (33) DE

(54) IMPROVED INDUSTRIAL TRUCK
(71) Robert Bosch GmbH, Wernerstrasse 1 Postfach 30 02 20, 70442 Stuttgart, DE
(72) SCHWIMMER, Helmut, Paulinenstr. 66/2, 88046 Friedrichshafen, DE
REMLINGER, Markus, Stoeger-Ostin-Strasse 11, 83714 Miesbach, DE
OAKEY, Nadia, Foeggenbeuren 4a, 83623 Dietramszell, DE
HUBERTUS, David Julian, Am Gangsteig 7, 83024 Rosenheim, DE
MUELLER, David, Marienstr. 5, 83607 Holzkirchen, DE
WEINZIERL, Johannes, Dorfstr. 20a, 83627 Osterwarngau, DE
HAMMER, Uwe, Karl Unsin Strasse 1, 83059 Kolbermoor, DE
KURZ, Josef Maximilian, Pfarrer-Wahner-Weg 4a, 83104 Ostermuenchen, DE

(51) MKP
F16M 11/04 2006 (97) EP 3566000
F16M 13/02 2006

(96) EP 18700796.8 1/8/2018
(97) EP 3566000, 11/13/2019 201946, fr
(31) 1750189 (32) 09.01.2017 (33) FR

(54) DEVICE FOR SNAP-FIT FASTENING OF AN ACCESSORY ON A WALL
(71) MXS Group, 5 rue Marcel Pagnol, 78530 Buc, FR
(72) MAXIS, Guy, 5 rue Marcel Pagnol, 78530 Buc, FR

- (51) MKP
A61K 31/337 2006 (97) EP 3565547
A61K 31/519 2006
A61K 45/06 2006
A61P 35/00 2006
- (96) EP 18700861.0 1/5/2018
(97) EP 3565547, 11/13/2019 201946, en
- (31) 201762443082 P (32) 06.01.2017 (33) US
17157779 24.02.2017 EP
201762527360 P 30.06.2017 US
- (54) COMBINATION OF A MCL-1 INHIBITOR AND A TAXANE COMPOUND, USES AND PHARMACEUTICAL COMPOSITIONS THEREOF
(72) PORTER, Dale, 250 Massachusetts Avenue, Cambridge, Massachusetts MA 02139, US
HALILOVIC, Ensar, 250 Massachusetts Avenue, Cambridge, Massachusetts MA 02139, US
CHANRION, Maïa, 14 rue de la Galiote Apt. D441, 92130 Issy les Moulineaux, FR
MARAGNO, Ana Leticia, 4 Allée Anastasi, 78290 Croissy-sur-Seine, FR
GENESTE, Olivier, Bâtiment A 17 rue Crevel Duval, 92500 Rueil Malmaison, FR
MERINO, Delphine, 123 Gore Street, Fitzroy, Victoria 3065, AU
WHITTLE, James, 24/9-19 Miller Street, Fitzroy North, Victoria 3068, AU
VAILLANT, François, 50 Aberdeen Street, Geelong West, Victoria 3218, AU
VISVADER, Jane, 12 Holroyd Street, Kew, Victoria 3101, AU
LINDEMAN, Geoffrey, 12 Holroyd Street, Kew, Victoria 3101, AU
LESSENE, Guillaume, 19 Gonella Crescent, Bundoora, Victoria 3083, AU
MARANGONI, Elisabetta, 15 rue Montbrun, 75014 Paris, FR
-

- (51) MKP
A61K 31/255 2006 (97) EP 3565545
A61K 31/421 2006
A61K 31/427 2006
A61P 13/08 2006
- (96) EP 18701088.9 1/2/2018
(97) EP 3565545, 11/13/2019 201946, en
- (31) 17150176 (32) 03.01.2017 (33) EP
- (54) IL-8 INHIBITORS FOR USE IN THE TREATMENT OF SOME UROLOGICAL DISORDERS
(72) ALLEGRETTI, Marcello, c/o Dompé farmaceutici S.p.A. Via Campo Di Pile s.n.c., I-67100 L'Aquila (AQ), IT
ARAMINI, Andrea, c/o Dompé farmaceutici S.p.A. Via Campo Di Pile s.n.c., I-67100 L'Aquila (AQ), IT
CESTA, Maria, Candida, c/o Dompé farmaceutici S.p.A. Via Campo Di Pile s.n.c., I-67100 L'Aquila (AQ), IT
BIANCHINI, Gianluca, c/o Dompé farmaceutici S.p.A. Via Campo Di Pile s.n.c., I-67100 L'Aquila (AQ), IT
BRANDOLINI, Laura, c/o Dompé farmaceutici S.p.A. Via Campo Di Pile s.n.c., I-67100 L'Aquila (AQ), IT
-

- (51) MKP
G06F 3/03 2006 (97) EP 3568780
G06F 17/50 2006
- (96) EP 18701131.7 1/11/2018
(97) EP 3568780, 11/20/2019 201947, en
- (31) 202017000132 U (32) 12.01.2017 (33) DE
- (54) METHOD OF KITCHEN PLANNING
(71) Küchenatlas Portal Betriebs GmbH, Bergsonstraße 47, 81245 München, DE
(72) KIEFER, Sebastian, Küchenatlas Portal Betriebs GmbH Bergsonstraße 47, 81245 München, DE
-

- (51) MKP
A61K 31/506 2006 (97) EP 3571192
A61P 17/14 2006
A61P 37/00 2006
C07D 403/04 2006
C07D 403/14 2006
- (96) EP 18701296.8 1/16/2018
(97) EP 3571192, 11/27/2019 201948, en
- (31) 201762447057 P (32) 17.01.2017 (33) US
- (54) JAK1 SELECTIVE INHIBITORS
(72) NILSSON, Karl, Magnus, AstraZeneca, 431 83 Mölndal, SE
ÅSTRAND, Annika, Birgitta, Margareta, AstraZeneca, 431 83 Mölndal, SE
BERGGREN, Anna, Ingrid, Kristina, AstraZeneca, 431 83 Mölndal, SE
JOHANSSON, Johan, R., AstraZeneca, 431 83 Mölndal, SE
LEPISTÖ, Matti, Juhani, AstraZeneca, 431 83 Mölndal, SE

KAWATKAR, Sameer, Pralhad, Astrazeneca Pharmaceuticals LP 1800 Concord Pike, Wilmington, DE 19803, US
 SU, Qibin, Astrazeneca Pharmaceuticals LP 1800 Concord Pike, Wilmington, DE 19803, US
 KETTLE, Jason, Grant, 1 Francis Crick Avenue Cambridge Biomedical Campus, Cambridge CB2 0AA, GB

- (51) MKP
A61K 35/12 2015 (97) EP 3571296
A61K 35/15 2015
A61K 35/28 2015
A61K 48/00 2006
C07K 14/435 2006
C12N 5/0775 2010
C12N 5/0786 2010
- (96) EP 18701425.3 1/17/2018
 (97) EP 3571296, 11/27/2019 201948, en
 (31) PCT/EP2017/051068 (32) 19.01.2017 (33) WO
- (54) ENGINEERED CELLS FOR INDUCING TOLERANCE
 (71) Biontech SE, An der Goldgrube 12, 55131 Mainz, DE
 University Of Verona, Policlinico G.B. Rossi Piazzale L.A. Scuro 10, 37134 Verona, IT
 (72) SAHIN, Ugur, Philipp-von-Zabern-Platz 1, 55116 Mainz, DE
 BRONTE, Vincenzo, via Montessori n. 11, 35031 Abano Terme (PD), IT
 UGEL, Stefano, via XXIV Maggio n. 20/A, 31024 Ormelle (TV), IT
 FIORE, Alessandra, corso Orbassano n. 216, 10137 Torino (TO), IT

- (51) MKP
A61L 2/07 2006 (97) EP 3576797
A61L 11/00 2006
- (96) EP 18701599.5 1/18/2018
 (97) EP 3576797, 12/11/2019 201950, en
 (31) 201700012621 (32) 06.02.2017 (33) IT
- (54) STERILIZING APPARATUS FOR THE STERILIZATION OF POST-CONSUMER ABSORBENT SANITARY PRODUCTS
 (72) SOMMA, Marcello, c/o FATER S.p.A. Via Alessandro Volta 10, 65129 Pescara, IT
 VACCARO, Giorgio, c/o FATER S.p.A. Via Alessandro Volta 10, 65129 Pescara, IT
 PAGOTTO, Amedeo, c/o FATER S.p.A. Via Alessandro Volta 10, 65129 Pescara, IT

- (51) MKP
B25B 27/30 2006 (97) EP 3568264
E05D 13/00 2006
- (96) EP 18701674.6 1/10/2018
 (97) EP 3568264, 11/20/2019 201947, de
 (31) 102017100581 (32) 13.01.2017 (33) DE
- (54) TENSIONING DEVICE FOR TENSIONING A HELICAL SPRING
 (71) Gruner, Andreas Heiko, Watzdorf Nr. 26a, 07422 Bad Blankenburg, DE
 (72) Gruner, Andreas Heiko, Watzdorf Nr. 26a, 07422 Bad Blankenburg, DE

- (51) MKP
A61K 31/437 2006 (97) EP 3577112
A61P 35/00 2006
C07D 471/04 2006
- (96) EP 18701774.4 2/1/2018
 (97) EP 3577112, 12/11/2019 201950, en
 (31) 17000158 (32) 01.02.2017 (33) EP
- (54) ARYL HYDROCARBON RECEPTOR (AHR) MODULATOR COMPOUNDS
 (72) STEENECK, Christoph, Weberstrasse 4/2, 69120 Heidelberg, DE
 DEUSCHLE, Ulrich, Maulbeerstück 11, 67346 Speyer, DE
 ALBERS, Michael, Schwabenstr. 6 A, 68239 Mannheim, DE
 HOFFMANN, Thomas, Daimlerstrasse 21, 67346 Speyer, DE

- (51) MKP
A61K 39/00 2006 (97) EP 3565835
A61P 31/04 2006
C07K 16/12 2006
- (96) EP 18701825.4 1/2/2018

(97) EP 3565835, 11/13/2019 201946, en
 (31) 201762441786 P (32) 03.01.2017 (33) US
 (54) HUMAN ANTIBODIES TO S.AUREUS HEMOLYSIN A TOXIN
 (72) COPPI, Alida, c/o Regeneron Pharmaceuticals Inc. 777 Old Saw Mill River Road, Tarrytown New York 10591, US
 MASON, Peter, 101 Wallace Street, Somerville Massachusetts 02144, US
 OLSON, William, c/o Regeneron Pharmaceuticals Inc. 777 Old Saw Mill River Road, Tarrytown New York 10591, US

(51) MKP
A61K 9/00 2006 (97) EP 3565526
A61K 31/00 2006
A61K 47/10 2017
A61K 47/32 2006
A61K 47/38 2006
 (96) EP 18701853.6 1/5/2018
 (97) EP 3565526, 11/13/2019 201946, en
 (31) 201762443174 P (32) 06.01.2017 (33) US
 (54) TOPICAL DETOMIDINE FORMULATIONS
 (72) TSIPORI, Omer, P.O.Box 279, 4283500 Shaar Efraim, IL
 ZAMANSKY, Mark, Azriel 22/23, 5221436 Ramat Gan, IL

(51) MKP
A61K 39/00 2006 (97) EP 3568698
C07K 14/35 2006
C07K 16/12 2006
G01N 33/569 2006
 (96) EP 18701926.0 1/11/2018
 (97) EP 3568698, 11/20/2019 201947, en
 (31) 201700487 (32) 11.01.2017 (33) GB
 (54) DIAGNOSTIC
 (71) Hav Vaccines Limited, 11 Parkside Avenue Wimbledon, London SW19 5ES, GB
 (72) HERMON-TAYLOR, John, Division of Diabetes&Nutritional Sciences Franklin-Wilkins Building King's College London 150 Stamford Street, London, Greater London SE1 9NH, GB

(51) MKP
A61K 31/4725 2006 (97) EP 3565811
A61P 1/10 2006
A61P 9/12 2006
C07D 401/12 2006
C07D 401/14 2006
 (96) EP 18701988.0 1/9/2018
 (97) EP 3565811, 11/13/2019 201946, en
 (31) 201762444338 P (32) 09.01.2017 (33) US
 (54) INHIBITORS OF NHE-MEDIATED ANTIPORT
 (72) DOTSENKO, Irina, 34175 Ardenwood Boulevard, Fremont California 94555, US
 DRAGOLI, Dean, 34175 Ardenwood Boulevard, Fremont California 94555, US
 LEWIS, Jason, 34175 Ardenwood Boulevard, Fremont California 94555, US

(51) MKP
A61K 31/437 2006 (97) EP 3568135
A61K 31/4439 2006
A61K 31/519 2006
A61P 25/28 2006
 (96) EP 18702014.4 1/11/2018
 (97) EP 3568135, 11/20/2019 201947, en
 (31) 201762445022 P (32) 11.01.2017 (33) US
 201762555298 P 07.09.2017 US
 (54) BICYCLIC INHIBITORS OF HISTONE DEACETYLASE
 (71) Rodin Therapeutics, Inc., 300 Technology Square, 8th Floor, Cambridge, MA 02139, US
 (72) FULLER, Nathan, Oliver, 66 Freeman St. 2, Arlington MA 02474, US
 LOWE, John, A., III, 28 Coveside Lane, Stonington CT 06378, US

(51) MKP

	B60L 5/42	2006	(97) EP 3568313				
	B60L 11/18	2006					
(96)	EP 18702102.7 1/11/2018						
(97)	EP 3568313, 11/20/2019 201947, de						
(31)	102017200593		(32)	16.01.2017	(33)	DE	
(54)	CONTACT UNIT FOR A CHARGING STATION, AND METHOD FOR MAKING CONTACT						
(71)	Schunk Bahn- und Industrietechnik GmbH, Aupoint 23, 5101 Bergheim, AT						
(72)	FELDINGER, Martin, Mayerlehen 40, 5201 Seekirchen am Wallersee, AT						
<hr/>							
(51)	MKP		(97) EP 3576740				
	A61K 31/498	2006					
	A61P 35/00	2006					
	G01N 33/574	2006					
(96)	EP 18702299.1 2/2/2018						
(97)	EP 3576740, 12/11/2019 201950, en						
(31)	201762455211 P		(32)	06.02.2017	(33)	US	
	17209098			20.12.2017		EP	
(54)	CANCER TREATMENT						
(72)	STUYCKENS, Kim, c/o Janssen Pharmaceutica NV Turnhoutseweg 30, 2340 Beerse, BE						
	PEREZ RUIXO, Juan, Jose, c/o Janssen-Cilag S.A. Edificio Johnson&Johnson Paseo de las Doce Estrellas 5-7 5° planta Campo de las Naciones, 28042 Madrid, ES						
	DE PORRE, Peter, Marie, Z., c/o Janssen Pharmaceutica NV Turnhoutseweg 30, 2340 Beerse, BE						
	AVADHANI, Anjali, Narayan, c/o Janssen Pharmaceuticals Inc. Springhouse Campus 1400 McKean Road, Springhouse Pennsylvania 19477, US						
	LORIOT, Yohann, c/o Gustave Roussy 114 rue Édouard-Vaillant, 94805 Villejuif Cedex, FR						
	SIEFKER-RADTKE, Arlene, O., c/o Janssen Pharmaceutica NV Turnhoutseweg 30, 2340 Beerse, BE						
<hr/>							
(51)	MKP		(97) EP 3570823				
	A61K 31/01	2006					
	A61K 31/4745	2006					
	A61K 31/513	2006					
	A61K 31/555	2006					
	A61K 45/06	2006					
	A61P 35/00	2006					
(96)	EP 18702329.6 1/15/2018						
(97)	EP 3570823, 11/27/2019 201948, en						
(31)	201700005649		(32)	19.01.2017	(33)	IT	
(54)	USE OF CAROTENOID DERIVATIVES TO REDUCE THE TOXICITY AND INCREASE THE EFFICACY OF ANTI-EGFR ANTITUMOR TREATMENTS						
(71)	Associazione Oncologica Milanese Amo La Vita Onlus, Via Pio II 3, 20153 Milano, IT						
(72)	MORONI, Mauro, Piazza Dei Daini 4, 20126 Milano, IT						
	PEDRAZZOLI, Paolo, Località Crosignano 101, 29010 Ziano Piacentino, IT						
	PIROVANO, Marco Giulio Giuseppe, Via Zamagna 19, 20148 Milano, IT						
<hr/>							
(51)	MKP		(97) EP 3571036				
	B29C 49/06	2006					
	B29C 49/36	2006					
	B29C 49/42	2006					
	B29C 49/80	2006					
(96)	EP 18702338.7 1/19/2018						
(97)	EP 3571036, 11/27/2019 201948, en						
(31)	201700006070		(32)	20.01.2017	(33)	IT	
(54)	IMPROVED MACHINE FOR THE PRODUCTION OF CONTAINERS AND CHECKING METHOD						
(71)	Verve SpA, Via Venegono 57, 21040 Vedano Olona (VA), IT						
(72)	VERSIGLIA, Pierfilippo, Via S. Michele 11, I-21040 Venegono Inferiore (VA), IT						
<hr/>							
(51)	MKP		(97) EP 3573716				
	A61K 38/17	2006					
	A61P 21/00	2006					
(96)	EP 18702344.5 1/24/2018						
(97)	EP 3573716, 12/4/2019 201949, en						
(31)	201700008082		(32)	25.01.2017	(33)	IT	
(54)	BIOLOGICALLY ACTIVE FUSION PEPTIDE FOR USE IN THE TREATMENT OF SPINAL MUSCULAR ATROPHY (SMA)						
(71)	Istituti Clinici Scientifici Maugeri Spa Società Benefit, Via Salvatore Maugeri 4, 27100 Pavia, IT						

(72) ROSSI, Daniela Maria Carmelita, c/o Istituti Clinici Scientifici Maugeri S.p.A. Società Benefit Laboratorio di Ricerca sulle Malattie Neurodegenerative Via Maugeri 10, 27100 Pavia, IT
 BRAMBILLA, Liliana, c/o Istituti Clinici Scientifici Maugeri S.p.A. Società Benefit Laboratorio di Ricerca sulle Malattie Neurodegenerative Via Maugeri 10, 27100 Pavia, IT

(51) MKP
A61K 35/17 2015 (97) EP 3565888
C12N 5/078 2010
C12N 5/0783 2010

(96) EP 18702378.3 1/5/2018
 (97) EP 3565888, 11/13/2019 201946, en

(31) 201762443556 P (32) 06.01.2017 (33) US
 201762460477 P 17.02.2017 US
 201762532807 P 14.07.2017 US
 201762567151 P 02.10.2017 US

(54) EXPANSION OF TUMOR INFILTRATING LYMPHOCYTES (TILS) WITH TUMOR NECROSIS FACTOR RECEPTOR SUPERFAMILY (TNFRSF) AGONISTS AND THERAPEUTIC COMBINATIONS OF TILS AND TNFRSF AGONISTS

(72) LOTZE, Michael, T., 5134 Westminster Place, Pittsburgh PA 15232, US
 RITTHIPICHAI, Krit, 14605 N. 42nd Street, Apt. 60, Tampa FL 33613, US

(51) MKP
A61P 25/28 2006 (97) EP 3565836
C07K 16/18 2006
G01N 33/68 2006

(96) EP 18702407.0 1/3/2018
 (97) EP 3565836, 11/13/2019 201946, en

(31) PA201700006 (32) 04.01.2017 (33) DK

(54) ANTIBODIES SPECIFIC FOR HYPERPHOSPHORYLATED TAU FOR THE TREATMENT OF OCULAR DISEASES

(72) PEDERSEN, Jan, Torleif, c/o H. Lundbeck A/S Ottiliavej 9, 2500 Valby, DK
 PEDERSEN, Lars, Østergaard, c/o H. Lundbeck A/S Ottiliavej 9, 2500 Valby, DK
 DAECHSEL, Justus, Claus, Alfred, c/o H. Lundbeck A/S Ottiliavej 9, 2500 Valby, DK
 ABDUR-RASHEED ASUNI, Ayodeji, c/o H. Lundbeck A/S Ottiliavej 9, 2500 Valby, DK
 ROSENQVIST, Nina, Helen, c/o H. Lundbeck A/S Ottiliavej 9, 2500 Valby, DK

(51) MKP
A61K 39/395 2006 (97) EP 3570882
A61P 7/02 2006
C07K 16/36 2006

(96) EP 18702623.2 1/16/2018
 (97) EP 3570882, 11/27/2019 201948, en

(31) 17152108 (32) 19.01.2017 (33) EP

(54) NOVEL STABLE FORMULATION FOR FXIA ANTIBODIES

(72) OLBRICH, Carsten, Gneisenastr. 46, 10961 Berlin, DE
 TRILL, Thomas, Lindenstr. 29, 16552 Schildow, DE
 VEURINK, Marieke, Zimmerstrasse 1, 22085 Hamburg, DE

(51) MKP
A61K 39/00 2006 (97) EP 3573647
C07K 7/06 2006
C07K 7/08 2006
C07K 14/47 2006
C07K 14/705 2006

(96) EP 18702642.2 1/26/2018
 (97) EP 3573647, 12/4/2019 201949, en

(31) 102017101671 (32) 27.01.2017 (33) DE
 201762451255 P 27.01.2017 US

(54) NOVEL PEPTIDES AND COMBINATION OF PEPTIDES FOR USE IN IMMUNOTHERAPY AGAINST OVARIAN CANCER AND OTHER CANCERS

(72) SCHUSTER, Heiko, Dorfackerstrasse 22, 72074 Tübingen, DE
 PEPER, Janet, Frühlingsstrasse 1, 85354 Freising, DE
 RÖHLE, Kevin, Eberhardstrasse 25, 72072 Tübingen, DE
 WAGNER, Philipp, Stafflenbergstr. 42, 70184 Stuttgart, DE
 RAMMENSEE, Hans-Georg, Sommerhalde 3, 72070 Unterjesingen, DE

(51) MKP
A61K 31/437 2006 (97) EP 3570834
A61K 31/519 2006
A61P 25/28 2006
(96) EP 18702839.4 1/11/2018
(97) EP 3570834, 11/27/2019 201948, en
(31) 201762445022 P (32) 11.01.2017 (33) US
201762555298 P 07.09.2017 US
(54) BICYCLIC INHIBITORS OF HISTONE DEACETYLASE
(72) FULLER, Nathan, Oliver, 66 Freeman St. 2, Arlington MA 02474, US
LOWE, John, A., III, 28 Coveside Lane, Stonington CT 06378, US

(51) MKP
A61K 31/4545 2006 (97) EP 3570839
A61P 35/00 2006
(96) EP 18702877.4 1/18/2018
(97) EP 3570839, 11/27/2019 201948, en
(31) 201762448486 P (32) 20.01.2017 (33) US
(54) SOLID DISPERSIONS OF (R)-N-((4-METHOXY-6-METHYL-2-OXO-1,2-DIHYDROPYRIDIN-3-YL)METHYL)-2-METHYL-1-(1-(1-(2,2,2-TRIFLUOROETHYL)PIPERIDIN-4-YL)ETHYL)-1H-INDOLE-3-CARBOXAMIDE
(72) ARRIGO, Alisha, 2620 Trade Centre Avenue, Longmont CO 80503, US
CORSON, Donald, 525 Market Street 36th Floor, San Francisco CA 94105, US
HARMANGE, Jean-christophe, 57 William Street, Andover MA 01810, US

(51) MKP
A61K 8/00 2006 (97) EP 3568146
A61K 9/00 2006
A61K 36/53 2006
A61P 17/14 2006
(96) EP 18702926.9 1/11/2018
(97) EP 3568146, 11/20/2019 201947, en
(31) 201700003045 (32) 12.01.2017 (33) IT
(54) VEGETABLE EXTRACT TO PREVENT AND TREAT HAIR LOSS
(72) GIULIANI, Giammaria, Vicolo delle scuole 7, 6926 Montagnola, CH
BENEDUSI, Anna, Viale Nazario Sauro 9, 20124 Milano, IT
MARZANI, Barbara, Via G. Marconi 13, 27020 Carbonara Al Ticino, IT

(51) MKP
C07K 14/64 2006 (97) EP 3574004
(96) EP 18702944.2 1/24/2018
(97) EP 3574004, 12/4/2019 201949, en
(31) 201762450338 P (32) 25.01.2017 (33) US
(54) RELAXIN FUSION POLYPEPTIDES AND USES THEREOF
(72) HAO, Weidong, MedImmune LLC One MedImmune Way, Gaithersburg, Maryland 20878, US
GARCIA, Andrew, MedImmune LLC One MedImmune Way, Gaithersburg, Maryland 20878, US
GAO, Changshou, MedImmune LLC One MedImmune Way, Gaithersburg, MD 20878, US
SERMADIRAS, Isabelle, MEDIMMUNE LIMITED Milstein Building Granta Park, Cambridge Cambridgeshire CB21 6GH, GB

(51) MKP
A61J 1/14 2006 (97) EP 3582825
A61J 1/20 2006
A61M 5/145 2006
A61M 5/28 2006
(96) EP 18703137.2 1/17/2018
(97) EP 3582825, 12/25/2019 201952, en
(31) 201762460559 P (32) 17.02.2017 (33) US
(54) DRUG DELIVERY DEVICE WITH STERILE FLUID FLOWPATH AND RELATED METHOD OF ASSEMBLY
(72) DAMESTANI, Yasaman, 359 Hodencamp Road Apt. 134, Thousand Oaks, CA, US
RING, Lawrence, S., 898 Hillcrest Drive, Laguna Beach, CA 92651, US

(51) MKP
A61K 31/445 2006 (97) EP 3573983
A61P 25/00 2006
A61P 25/28 2006
C07D 417/14 2006
(96) EP 18703154.7 1/19/2018
(97) EP 3573983, 12/4/2019 201949, en
(31) 201762451137 P (32) 27.01.2017 (33) US
(54) N-[4-FLUORO-5-[[[(2S,4S)-2-METHYL-4-[(5-METHYL-1,2,4-OXADIAZOL-3-YL)METHOXY]-1-PIPERIDYL]METHYL]THIAZOL-2-YL]ACETAMIDE AS OGA INHIBITOR
(72) DREYFUS, Nicolas Jacques Francois, c/o ELI LILLY AND COMPANY P.O. Box 6288, Indianapolis, Indiana 46206-6288, US
LINDSAY-SCOTT, Peter James, c/o ELI LILLY AND COMPANY P.O. Box 6288, Indianapolis, Indiana 46206-6288, US

(51) MKP
A61K 31/496 2006 (97) EP 3573981
A61P 25/28 2006
C07D 417/12 2006
C07D 417/14 2006
(96) EP 18703235.4 1/23/2018
(97) EP 3573981, 12/4/2019 201949, en
(31) 17153210 (32) 26.01.2017 (33) EP
(54) ALKOXY BIS-HETEROARYL DERIVATIVES AS MODULATORS OF PROTEIN AGGREGATION
(72) HALL, Adrian, c/o IP Department 60 Allée de la Recherche, 1070 Brussels, BE
MACCOSS, Malcolm, c/o Bohicket Pharma Consulting LLC 2556 Seabrook Island Road, Seabrook Island, South Carolina 29455, US

(51) MKP
A61K 31/496 2006 (97) EP 3573982
A61K 31/501 2006
A61K 31/506 2006
A61P 25/28 2006
A61P 35/00 2006
C07D 417/12 2006
C07D 417/14 2006
(96) EP 18703236.2 1/23/2018
(97) EP 3573982, 12/4/2019 201949, en
(31) 17153214 (32) 26.01.2017 (33) EP
(54) BIS-HETEROARYL DERIVATIVES AS MODULATORS OF PROTEIN AGGREGATION
(72) HALL, Adrian, c/o IP Department 60 Allée de la Recherche, 1070 Brussels, BE

(51) MKP
C07D 471/04 2006 (97) EP 3573986
C07D 487/04 2006
C07D 498/04 2006
(96) EP 18703237.0 1/23/2018
(97) EP 3573986, 12/4/2019 201949, en
(31) 17153217 (32) 26.01.2017 (33) EP
(54) BICYCLIC BIS-HETEROARYL DERIVATIVES AS MODULATORS OF PROTEIN AGGREGATION
(72) HALL, Adrian, c/o IP Department 60 Allée de la Recherche, 1070 Brussels, BE
PROVINS, Laurent, c/o IPD UCB Biopharma SPRL 60 Allée de la Recherche, 1070 Brussels, BE
MACCOSS, Malcolm, c/o Bohicket Pharma Consulting LLC 2556 Seabrook Island Road, Seabrook Island, SC 29455, US

(51) MKP
C12N 15/113 2010 (97) EP 3577222
G01N 33/574 2006
(96) EP 18703289.1 1/31/2018
(97) EP 3577222, 12/11/2019 201950, en
(31) 17154260 (32) 01.02.2017 (33) EP
(54) NOVEL METHODS FOR SUB-TYPING AND TREATING CANCER
(71) Hi-stem GgmbH, Im Deutschen Krebsforschungszentrum DKFZ Im Neuenheimer Feld 280, 69120 Heidelberg, DE
(72) TRUMPP, Andreas, Oberer Gaisbergweg 24, 69115 Heidelberg, DE
RAFFEL, Simon, Blumenstrasse 2, 69115 Heidelberg, DE

- (51) MKP
A61K 8/02 2006 (97) EP 3579928
A61K 8/19 2006
A61K 8/29 2006
A61Q 17/04 2006
- (96) EP 18703302.2 2/2/2018
(97) EP 3579928, 12/18/2019 201951, en
- (31) 17155425 (32) 09.02.2017 (33) EP
201762459667 P 16.02.2017 US
- (54) FUNCTIONALIZED CALCIUM CARBONATE FOR SUN PROTECTION BOOSTING
(72) BUDDE, Tanja, Grubenring 3, 4805 Brittnau, CH
HECKER, Anaïs, Neugasse 9, 4665 Oftringen, CH

- (51) MKP
A61K 39/395 2006 (97) EP 3565594
A61P 35/00 2006
C07K 16/28 2006
- (96) EP 18703388.1 1/9/2018
(97) EP 3565594, 11/13/2019 201946, en
- (31) 201762444354 P (32) 09.01.2017 (33) US
201762582272 P 06.11.2017 US
- (54) METHODS OF TREATING CANCER WITH ANTI-TIM-3 ANTIBODIES
(72) BOBILEV, Dmitri, c/o Tesaro Inc. 1000 Winter Street North Suite 3300, Waltham MA 02451, US
FERGUSON, Andrew, R., c/o Tesaro Inc. 1000 Winter Street North Suite 3300, Waltham MA 02451, US
MCEACHERN, Kristen, Anne, c/o Tesaro Inc. 1000 Winter Street North Suite 3300, Waltham MA 02451, US
WANG, Jing, c/o Tesaro Inc. 1000 Winter Street North Suite 3300, Waltham MA 02451, US

- (51) MKP
A61K 31/437 2006 (97) EP 3573987
A61K 31/519 2006
A61P 11/06 2006
C07D 471/04 2006
C07D 487/04 2006
C07D 519/00 2006
- (96) EP 18703524.1 1/26/2018
(97) EP 3573987, 12/4/2019 201949, en
- (31) 17153785 (32) 30.01.2017 (33) EP
- (54) TYROSINE AMIDE DERIVATIVES AS RHO- KINASE INHIBITORS
(72) ACCETTA, Alessandro, c/o CHIESI FARMACEUTICI S.p.A. Via Palermo 26/A, 43122 Parma, IT
RANCATI, Fabio, c/o CHIESI FARMACEUTICI S.p.A. Via Palermo 26/A, 43122 Parma, IT
CAPELLI, Anna Maria, c/o CHIESI FARMACEUTICI S.p.A. Via Palermo 26/A, 43122 Parma, IT
CLARK, David Edward, c/o CHIESI FARMACEUTICI S.p.A. Via Palermo 26/A, 43122 Parma, IT
TISSELLI, Patrizia, c/o CHIESI FARMACEUTICI S.p.A. Via Palermo 26/A, 43122 Parma, IT
EDWARDS, Christine, c/o CHIESI FARMACEUTICI S.p.A. Via Palermo 26/A, 43122 Parma, IT
CHEGUILLAUME, Arnaud Jean Francois Auguste, c/o CHIESI FARMACEUTICI S.p.A. Via Palermo 26/A, 43122 Parma, IT
BHALAY, Gurdip, c/o CHIESI FARMACEUTICI S.p.A. Via Palermo 26/A, 43122 Parma, IT

- (51) MKP
H01R 4/36 2006 (97) EP 3583662
H01R 12/51 2011
H01R 12/75 2011
- (96) EP 18703597.7 2/8/2018
(97) EP 3583662, 12/25/2019 201952, en
- (31) 201700015793 (32) 14.02.2017 (33) IT
- (54) CONNECTOR FOR PRINTED CIRCUIT BOARDS
(71) Sauro S.r.l., Viale Delle Industrie 17, 35010 Villafranca Padovana, IT
(72) FAVERO, Santino, Via Capitello 5, 35136 Padova, IT
BORELLA, Raffaele, Via Ponchielli Amilcare 9, 35031 Abano Terme, IT

- (51) MKP

A61K 9/00 2006 (97) EP 3573597
A61K 47/32 2006
A61K 47/36 2006
(96) EP 18703628.0 1/17/2018
(97) EP 3573597, 12/4/2019 201949, en
(31) 201700009786 (32) 30.01.2017 (33) IT
(54) TEAR SUBSTITUTE
(71) For Health Pharma S.r.l., Corso Italia 171, 95127 Catania (CT), IT
(72) MANGIAFICO, Sebastiano, c/o For Health Pharma S.r.l. Corso Italia 171, 95127 Catania, IT

(51) MKP
A61K 31/40 2006 (97) EP 3565808
A61K 31/41 2006
A61K 31/435 2006
A61K 31/445 2006
A61K 31/4462 2006
C07D 207/12 2006
C07D 211/56 2006
C07D 225/02 2006
C07D 249/04 2006
C07D 295/033 2006
C07D 317/26 2006
(96) EP 18703655.3 1/9/2018
(97) EP 3565808, 11/13/2019 201946, en
(31) 201762444335 P (32) 09.01.2017 (33) US
201762541097 P 04.08.2017 US
(54) COMPOUNDS USEFUL FOR TREATING GASTROINTESTINAL TRACT DISORDERS
(72) DRAGOLI, Dean, 34175 Ardenwood Boulevard, Fremont California 94555, US
DOTSENKO, Irina, 34175 Ardenwood Boulevard, Fremont California 94555, US
LEWIS, Jason, 34175 Ardenwood Boulevard, Fremont California 94555, US

(51) MKP
C12P 7/22 2006 (97) EP 3571307
C12P 17/06 2006
(96) EP 18703685.0 1/15/2018
(97) EP 3571307, 11/27/2019 201948, en
(31) 201762446429 P (32) 14.01.2017 (33) US
201762524239 P 23.06.2017 US
201762546372 P 16.08.2017 US
(54) ENZYME-ASSISTED LIPID-BASED EXTRACTION AND STABILIZATION OF PHYTO-CANNABINOIDS AND TERPENS AND PRODUCTS OBTAINED THEREOF
(71) Herbolea Biotech S.R.L., Via Luciano Lama, 9/11, 50019 Sesto Fiorentino, IT
(72) VENTURINI DEL GRECO, Giovanni, Via Carducci 16, 50121 Firenze, IT

(51) MKP
A61K 31/501 2006 (97) EP 3580211
A61P 35/00 2006
C07D 237/04 2006
C07D 237/24 2006
C07D 401/04 2006
C07D 401/14 2006
C07D 403/04 2006
C07D 405/14 2006
C07D 409/04 2006
C07D 413/04 2006
C07D 417/04 2006
C07D 417/14 2006
(96) EP 18703958.1 2/2/2018
(97) EP 3580211, 12/18/2019 201951, en
(31) 17155406 (32) 09.02.2017 (33) EP
17202882 21.11.2017 EP
(54) 2-HETEROARYL-3-OXO-2,3-DIHYDROPYRIDAZINE-4-CARBOXAMIDES FOR THE TREATMENT OF CANCER
(71) Deutsches Krebsforschungszentrum, Im Neuenheimer Feld 280, 69120 Heidelberg, DE
(72) GUTCHER, Ilona, Paul Robesonstrasse 28, 10439 Berlin, DE

RÖHN, Ulrike, Boyenstrasse 42, 10115 Berlin, DE
 SCHMEES, Norbert, Bondickstrasse 61, 13469 Berlin, DE
 ZORN, Ludwig, Osianderweg 45A, 13509 Berlin, DE
 RÖSE, Lars, Fuchsring 82, 13465 Berlin, DE
 BADER, Benjamin, Hillmannstrasse 14, 13467 Berlin, DE
 KOBER, Christina, Am Alten Bahnhof 8, 35457 Lollar, DE
 CARRETERO, Rafael, Mühlingstrasse 6, 69121 Heidelberg, DE
 STÖCKIGT, Detlef, Clara Zetkinstrasse 27, 14471 Potsdam, DE
 IRLBACHER, Horst, Winsstrasse 47, 10405 Berlin, DE
 PLATTEN, Michael, Cambridgestrasse 7, 69115 Heidelberg, DE

- (51) MKP
A61P 35/00 2006 (97) EP 3565844
C07K 16/28 2006
- (96) EP 18704101.7 1/9/2018
 (97) EP 3565844, 11/13/2019 201946, en
- (31) 201762444336 P (32) 09.01.2017 (33) US
 201762477423 P 27.03.2017 US
 201762491220 P 27.04.2017 US
 201762556386 P 09.09.2017 US
- (54) METHODS OF TREATING CANCER WITH ANTI-PD-1 ANTIBODIES
 (72) JENKINS, David, c/o Tesaro Inc. 1000 Winter Street North Suite 3300, Waltham MA 02451, US
 LAKEN, Haley, c/o Tesaro Inc. 1000 Winter Street North Suite 3300, Waltham MA 02451, US
 IM, Ellie, c/o Tesaro Inc. 1000 Winter Street North Suite 3300, Waltham MA 02451, US
 DIAZ, Allene, c/o Tesaro Inc. 1000 Winter Street North Suite 3300, Waltham MA 02451, US
 LU, Sharon, c/o Tesaro Inc. 1000 Winter Street North Suite 3300, Waltham MA 02451, US

- (51) MKP
C12P 19/24 2006 (97) EP 3583224
- (96) EP 18704216.3 2/7/2018
 (97) EP 3583224, 12/25/2019 201952, en
- (31) 17156215 (32) 15.02.2017 (33) EP
- (54) PROCESS FOR PRODUCTION OF A SOLID MATERIAL CONTAINING ISOMALTULOSE CRYSTALS AND TREHALULOSE
 (71) Evonik Operations GmbH, Rellinghauser Straße 1-11, 45128 Essen, DE
 (72) HELLMERS, Frank, Waterpad 19, 26629 Großefehn, DE
 SCHLEGEL-KACHEL, Sibylle, Hanauer Landstr. 31b, 63457 Hanau, DE
 ÖHRLEIN, Johannes, Glockenstr. 33b, 40476 Düsseldorf, DE
 WOLTER, Jan, An den Kämpen 36, 40489 Düsseldorf, DE

- (51) MKP
A61K 31/416 2006 (97) EP 3571187
A61K 31/4162 2006
A61K 31/424 2006
A61K 31/429 2006
A61P 1/00 2006
A61P 5/00 2006
A61P 11/00 2006
A61P 13/00 2006
A61P 17/00 2006
A61P 25/00 2006
A61P 31/00 2006
A61P 35/00 2006
C07D 231/56 2006
C07D 263/52 2006
C07D 265/12 2006
C07D 487/04 2006
C07D 498/04 2006
C07D 498/20 2006
C07D 513/04 2006
- (96) EP 18704341.9 1/22/2018
 (97) EP 3571187, 11/27/2019 201948, en
- (31) 201762449431 P (32) 23.01.2017 (33) US
 201762492813 P 01.05.2017 US

- (54) CHEMICAL COMPOUNDS AS INHIBITORS OF INTERLEUKIN-1 ACTIVITY
 (72) STAFFORD, Jeffrey A., 12752 Sandy Crest Court, San Diego, California 92130, US
 VEAL, James M., 8916 Weaver Crossing Road, Apex, North Carolina 27502, US
 TRZOSS, Lynn Lin, 9120 Meadowrun Way, San Diego, California 92129, US
 MCBRIDE, Christopher, 10595 Montego Drive, San Diego, California 92124, US

- (51) MKP
C07C 205/19 2006 (97) EP 3573948
C07D 207/452 2006
C07D 487/04 2006
C07D 519/04 2006
 (96) EP 18704352.6 1/24/2018
 (97) EP 3573948, 12/4/2019 201949, en
 (31) 201762450270 P (32) 25.01.2017 (33) US
 (54) METHODS OF PREPARING CYTOTOXIC BENZODIAZEPINE DERIVATIVES
 (72) GÉRARD, Baudouin, 69 Dartmouth Street, Belmont, MA 02478, US
 SILVA, Richard, A., 587 Greendale Avenue, Needham, MA 02492, US
 MILLER, Michael, Louis, 4 Maymont Drive, Framingham, MA 01701, US
 SHIZUKA, Manami, 253 Payson Road, Belmont, MA 02478, US

- (51) MKP
A61K 39/00 2006 (97) EP 3577136
A61K 39/395 2006
C07K 16/28 2006
 (96) EP 18704492.0 2/2/2018
 (97) EP 3577136, 12/11/2019 201950, en
 (31) 17154658 (32) 03.02.2017 (33) EP
 (54) INHIBITION OF PLATELET AGGREGATION USING ANTI-HUMAN GPVI ANTIBODIES
 (71) Acticor Biotech, Bâtiment INSERM U698 HP BICHAT 46 rue Henri Huchard, 75877 Paris Cedex 18, FR
 Université Paris Diderot Paris 7, 5 Rue Thomas Mann, 75013 Paris, FR
 Université Paris XIII, 99, avenue Jean-Baptiste Clément, 93430 Villetaneuse, FR
 INSERM (Institut National de la Santé et de la Recherche Scientifique), 101 rue de Tolbiac, 75654 Paris Cedex 13, FR
 Université Paris Sud 11, 15 rue Georges Clemenceau, 91400 Orsay, FR
 (72) BILLIALD, Philippe, 28 rue des Sablons, 75116 Paris, FR
 JANDROT-PERRUS, Martine, 5 rue Barbès, 92170 Vanves, FR
 AVENARD, Gilles, 85 rue Périer, 92120 Montrouge, FR

- (51) MKP
G01N 33/36 2006 (97) EP 3586127
 (96) EP 18704597.6 1/18/2018
 (97) EP 3586127, 1/1/2020 202001, en
 (31) 201700020724 (32) 23.02.2017 (33) IT
 (54) MODULABLE SYSTEM FOR IDENTIFYING AND CERTIFYING GARMENTS
 (71) Adapta SPA, Via Pontina Km. 31 700, 00071 Pomezia (RM), IT
 (72) STASI, Gemma, c/o ADAPTA SPA Via Pontina Km. 31 700, 00071 Pomezia (RM), IT

- (51) MKP
A61K 9/00 2006 (97) EP 3576762
A61K 38/00 2006
C12N 9/64 2006
 (96) EP 18704801.2 1/31/2018
 (97) EP 3576762, 12/11/2019 201950, en
 (31) 201762452826 P (32) 31.01.2017 (33) US
 (54) FACTOR IX FUSION PROTEINS AND METHODS OF MAKING AND USING SAME
 (72) VAN DER FLIER, Arjan, 32 Ibbetson Street 2, Somerville Massachusetts 02143, US
 LIU, Zhiqian, 5 Pocahontas Drive, Winchester Massachusetts 01890, US
 LIGHT, David R., 43 Park Street Unit 16, Somerville Massachusetts 02143, US
 CHHABRA, Ekta Seth, 1550 Worcester Road Unit 128, Framingham Massachusetts 01702, US
 LIU, Tongyao, 3 Buckman Drive, Lexington Massachusetts 02421, US
 PETERS, Robert T., 53 Parkinson Street, Needham Massachusetts 02492, US
 KULMAN, John, 88 Creeley Road, Belmont Massachusetts 02478, US
 ISMAIL, Ayman, 313 Cardinal Medeiros Apt 3, Cambridge Massachusetts 02141, US

(51) MKP
C04B 18/16 2006 (97) EP 3577169
C04B 26/26 2006
C08L 91/00 2006
C08L 95/00 2006
E01C 1/00 2006
E01C 7/35 2006
(96) EP 18704820.2 2/1/2018
(97) EP 3577169, 12/11/2019 201950, en
(31) 201762453882 P (32) 02.02.2017 (33) US
(54) BITUMINOUS EMULSIONS CONTAINING STEROL ADDITIVE FOR ASPHALT PAVEMENT
(72) REINKE, Gerald, H., W5373 Boma Road, La Crosse WI 54601, US
BAUMGARDNER, Gaylon, L., 326 Helms Road, Arkadelphia AR 71923, US
HANZ, Andrew, 319 Hinkley Rd. Apt. B, La Crosse WI 54603, US

(51) MKP
A61K 31/215 2006 (97) EP 3576770
A61K 31/5377 2006
A61K 38/08 2019
A61P 27/02 2006
A61P 27/06 2006
(96) EP 18704823.6 2/1/2018
(97) EP 3576770, 12/11/2019 201950, en
(31) 201762453153 P (32) 01.02.2017 (33) US
(54) COMPOUNDS AND COMPOSITIONS FOR THE TREATMENT OF OPHTHALMIC DISORDERS
(72) SAVINAINEN, Anneli, C/o Shire Human Genetic Therapies Inc. 300 Shire Way, Lexington MA 02421, US
SHAWER, Mohannad, C/o Shire Human Genetic Therapies Inc. 300 Shire Way, Lexington MA 02421, US
DONG, Jinquan, c/o Shire Human Genetic Therapies Inc. 300 Shire Way, Lexington MA 02421, US

(51) MKP
A61K 31/454 2006 (97) EP 3568414
A61K 39/00 2006
A61P 35/00 2006
C07K 16/28 2006
C12Q 1/6869 2018
(96) EP 18705031.5 1/10/2018
(97) EP 3568414, 11/20/2019 201947, en
(31) 201762444802 P (32) 10.01.2017 (33) US
201762551752 P 29.08.2017 US
201762596662 P 08.12.2017 US
(54) EPIGENETIC ANALYSIS OF CELL THERAPY AND RELATED METHODS
(72) BONYHADI, Mark, L., 400 Dexter Ave. N Suite 1200, Seattle WA 98109, US
KUGLER, David, G., 400 Dexter Ave. N Suite 1200, Seattle WA 98109, US
JOHNSTONE, Timothy G., 400 Dexter Ave. N Suite 1200, Seattle WA 98109-4703, US
HAUSE, Ronald James, Jr., 400 Dexter Ave. N Suite 1200, Seattle WA 98109-4703, US

(51) MKP
C08J 7/04 2006 (97) EP 3585844
C09D 151/02 2006
(96) EP 18705148.7 2/16/2018
(97) EP 3585844, 1/1/2020 202001, en
(31) 17157947 (32) 24.02.2017 (33) EP
201762466421 P 03.03.2017 US
(54) MINERAL OIL BARRIER
(72) ROHÉ, Ramon, Zollweg 21, 5034 Suhr, CH

(51) MKP
C07D 487/10 2006 (97) EP 3577121
(96) EP 18705346.7 2/6/2018
(97) EP 3577121, 12/11/2019 201950, en

(31)	17154751	(32)	06.02.2017	(33)	EP
(54)	OGA INHIBITOR COMPOUNDS				
(72)	BARTOLOMÉ-NEBREDA, José Manuel, c/o: Janssen-Cilag S.A. Edificio Johnson&Johnson Paseo de las Doce Estrellas 5-7 5° planta Campo de las Naciones, 28042 Madrid, ES				
	TRABANCO-SUÁREZ, Andrés Avelino, c/o: Janssen-Cilag S.A. Edificio Johnson&Johnson Paseo de las Doce Estrellas 5-7 5° planta Campo de las Naciones, 28042 Madrid, ES				
	MARTINEZ VITURRO, Carlos Manuel, Janssen-Cilag S.A. Edificio Johnson&Johnson Paseo de las Doce Estrellas 5-7 5° planta Campo de las Naciones, 28042 Madrid, ES				

(51) MKP
C07K 16/00 2006 (97) EP 3580233
C07K 16/10 2006
C07K 16/28 2006

(96) EP 18705367.3 2/12/2018

(97) EP 3580233, 12/18/2019 201951, en

(31)	PA201700097	(32)	10.02.2017	(33)	DK
------	-------------	------	------------	------	----

(54) POLYPEPTIDE VARIANTS AND USES THEREOF

(71) Genmab B.V., Yalelaan 60, 3584 CM Utrecht, NL

(72) BEURSKENS, Frank, c/o Genmab B.V. Yalelaan 60, 3584 CM Utrecht, NL

OVERDIJK, Marije, c/o Genmab B.V. Yalelaan 60, 3584 CM Utrecht, NL

DIKS, Annieck, M., Raam 63-G, 2801 VJ Gouda, NL

DE JONG, Rob, c/o Genmab B.V. Yalelaan 60, 3584 CM Utrecht, NL

STRUMANE, Kristin, c/o Genmab B.V. Yalelaan 60, 3584 CM Utrecht, NL

SCHUURMAN, Janine, c/o Genmab B.V. Yalelaan 60, 3584 CM Utrecht, NL

PARREN, Paul, Werdorperwaard 17, 3984 PR Odijk, NL

(51) MKP
A61K 31/44 2006 (97) EP 3580204
A61P 35/00 2006
C07D 213/72 2006

(96) EP 18705460.6 2/7/2018

(97) EP 3580204, 12/18/2019 201951, en

(31)	201762455645 P	(32)	07.02.2017	(33)	US
------	----------------	------	------------	------	----

(54) SULFINYL PYRIDINES AND THEIR USE IN THE TREATMENT OF CANCER

(72) PELCMAN, Benjamin, Döbelnsgatan 85, SE-113 52 Stockholm, SE

ORWAR, Owe, Hovås Fasanstig 11b, SE-436 50 Hovås, SE

STAFFORD, William, Pepparvägen 40 Lgh 1301, SE-123 56 Farsta, SE

ANDERSSON, Kjell, Fagaredsväagen, SE-439 72 Fjärås, SE

(51) MKP
A61K 31/427 2006 (97) EP 3580215
A61K 31/44 2006
A61P 35/00 2006
C07D 401/12 2006
C07D 403/12 2006
C07D 417/12 2006

(96) EP 18705461.4 2/7/2018

(97) EP 3580215, 12/18/2019 201951, en

(31)	201762455639 P	(32)	07.02.2017	(33)	US
------	----------------	------	------------	------	----

201762594799 P

05.12.2017

US

(54) HETEROARYLSULFONYL-SUBSTITUTED PYRIDINES AND THEIR USE IN THE TREATMENT OF CANCER

(72) PELCMAN, Benjamin, Döbelnsgatan 85, SE-113 52 Stockholm, SE

SUNA, Edgars, Alsungas 5a, LV-1004 Riga, LV

STAFFORD, William, Pepparvägen 40 Lgh 1301, SE-123 56 Farsta, SE

PRIEDE, Martins, Bikernieku 77-46, LV-1039 Riga, LV

(51) MKP
A61K 31/44 2006 (97) EP 3580209
A61P 35/00 2006
C07D 401/12 2006
C07D 407/12 2006

(96) EP 18705719.5 2/7/2018

(97) EP 3580209, 12/18/2019 201951, en

(31) 201762455644 P (32) 07.02.2017 (33) US
 201762594784 P 05.12.2017 US
 (54) HETEROCYCLYL SULFONYL-SUBSTITUTED PYRIDINES AND THEIR USE IN THE TREATMENT OF CANCER
 (72) PELCMAN, Benjamin, Döbelnsgatan 85, SE-113 52 Stockholm, SE
 STAFFORD, William, Pepparvägen 40 Lgh 1301, SE-123 56 Farsta, SE

(51) MKP
B01D 53/14 2006 (97) EP 3579964
B01D 53/50 2006
B01D 53/78 2006
B01J 4/00 2006
B01J 19/24 2006
 (96) EP 18705855.7 2/7/2018
 (97) EP 3579964, 12/18/2019 201951, fr
 (31) 1751104 (32) 10.02.2017 (33) FR
 (54) DEVICE FOR PRODUCING AND TREATING A GAS STREAM THROUGH AN AUTOMATICALLY CONTROLLED VOLUME OF LIQUID
 (72) ZEMMOURI, Jaouad, 28 rue Henri Derain, 59310 Nomain, FR

(51) MKP
A61K 31/664 2006 (97) EP 3473636
A61K 31/675 2006
A61K 31/7072 2006
A61K 31/7076 2006
A61K 31/708 2006
A61P 31/18 2006
A61P 31/20 2006
C07F 9/36 2006
C07F 9/44 2006
C07F 9/6561 2006
C07H 19/10 2006
C07H 19/20 2006
 (96) EP 17791915.6 4/7/2017
 (97) EP 3473636, 11/6/2019 201945, en
 (31) 2017106611 (32) 28.02.2017 (33) RU
 (54) NUCLEOTIDES CONTAINING AN N-[(S)-1-CYCLOBUTOXYCARBONYL]PHOSPHORAMIDATE FRAGMENT, ANALOGS THEREOF, AND USE THEREOF
 (71) Alla Chem, LLC, 1835 E. Hallandale Bch Blvd 442, Hallandale Beach, FL 33009, US
 (72) IVACHTCHENKO, Alexandr Vasilievich, 1835 E. Hallandale Bch Blvd., 442, Hallandale Beach, Florida 33009, US
 MITKIN, Oleg Dmitrievich, Kurkinskoye shosse 20 Apt. 62, g. Khimki 141400, RU

(51) MKP
A61F 2/24 2006 (97) EP 3592287
 (96) EP 17718993.3 3/7/2017
 (97) EP 3592287, 1/15/2020 202003, en
 (54) METHOD FOR GENERATING A MITRAL REPAIR RING, AND MITRAL REPAIR RING
 (71) CD Med S.r.l., Via Manfredo Fanti 3, 10128 Torino, IT
 (72) DEORSOLA, Luca, Corso Monte Cucco 60, 10141 Torino, IT

(51) MKP
A61K 31/426 2006 (97) EP 3551626
A61P 25/08 2006
C07D 213/76 2006
C07D 237/20 2006
C07D 239/69 2006
C07D 261/16 2006
C07D 277/52 2006
C07D 285/08 2006
C07D 403/12 2006
C07D 413/12 2006
C07D 493/10 2006
 (96) EP 17728326.4 5/19/2017
 (97) EP 3551626, 10/16/2019 201942, en
 (31) 201662432169 P (32) 09.12.2016 (33) US

- (54) BENZENESULFONAMIDE COMPOUNDS AND THEIR USE AS THERAPEUTIC AGENTS
 (72) ANDREZ, Jean-Christophe, 200 - 3650 Gilmore Way, Burnaby, British Columbia V5G 4W8, CA
 BOGUCKI, David Earl, 200 - 3650 Gilmore Way, Burnaby, British Columbia V5G 4W8, CA
 BURFORD, Kristen, Nicole, 200 - 3650 Gilmore Way, Burnaby, British Columbia V5G 4W8, CA
 CHOWDHURY, Sultan, 200 - 3650 Gilmore Way, Burnaby, British Columbia V5G 4W8, CA
 COHEN, Charles, Jay, 200 - 3650 Gilmore Way, Burnaby, British Columbia V5G 4W8, CA
 DECKER, Shannon, Marie, 200 - 3650 Gilmore Way, Burnaby, British Columbia V5G 4W8, CA
 DEHNHARDT, Christoph, Martin, 200 - 3650 Gilmore Way, Burnaby, British Columbia V5G 4W8, CA
 DEVITA, Robert, Joseph, 200 - 3650 Gilmore Way, Burnaby, British Columbia V5G 4W8, CA
 EMPFIELD, James, Roy, 200 - 3650 Gilmore Way, Burnaby, British Columbia V5G 4W8, CA
 FOCKEN, Thilo, 200 - 3650 Gilmore Way, Burnaby, British Columbia V5G 4W8, CA
 GRIMWOOD, Michael, Edward, 200 - 3650 Gilmore Way, Burnaby, British Columbia V5G 4W8, CA
 HASAN, Syed, Abid, 200 - 3650 Gilmore Way, Burnaby, British Columbia V5G 4W8, CA
 JIA, Qi, 200 - 3650 Gilmore Way, Burnaby, British Columbia V5G 4W8, CA
 JOHNSON, James, Philip, Jr., 200 - 3650 Gilmore Way, Burnaby, British Columbia V5G 4W8, CA
 WILSON, Michael, Scott, 200 - 3650 Gilmore Way, Burnaby, British Columbia V5G 4W8, CA
 ZENOVA, Alla, Yurevna, 200 - 3650 Gilmore Way, Burnaby, British Columbia V5G 4W8, CA
-

- (51) MKP
G06K 9/00 2006 (97) EP 3457314
- (96) EP 17210867.2 12/28/2017
 (97) EP 3457314, 10/30/2019 201944, en
 (31) 201710839948 (32) 18.09.2017 (33) CN
- (54) BODY INFORMATION ANALYSIS APPARATUS AND METHOD OF DETECTING FACE SHAPE BY USING SAME
 (72) Shen, Shyh-Yong, c/o Cal-Comp Big Data, Inc. No. 147, Sec. 3, Beishen Rd., Shenkeng Dist., New Taipei City 222, TW
 Chi, Min-Chang, c/o Cal-Comp Big Data, Inc. No. 147, Sec. 3, Beishen Rd., Shenkeng Dist., New Taipei City 222, TW
 Lin, Hui-Teng, c/o Cal-Comp Big Data, Inc. No. 147, Sec. 3, Beishen Rd., Shenkeng Dist., New Taipei City 222, TW
 Wang, Ching-Wei, c/o Cal-Comp Big Data, Inc. No. 147, Sec. 3, Beishen Rd., Shenkeng Dist., New Taipei City 222, TW
-

- (51) MKP
G06T 7/00 2017 (97) EP 3454297
- (96) EP 17211163.5 12/29/2017
 (97) EP 3454297, 10/23/2019 201943, en
 (31) 201710803833 (32) 08.09.2017 (33) CN
- (54) BODY INFORMATION ANALYSIS APPARATUS AND METHOD OF ANALYZING HAND SKIN USING SAME
 (71) CAL-COMP BIG DATA, INC, No. 147, Sec. 3 Beishen Rd., Shenkeng, New Taipei City 222, TW
 (72) Shen, Shyh-Yong, c/o Cal-Comp Big Data, Inc. No. 147, Sec. 3, Beishen Rd. Shenkeng Dist., 222 New Taipei City, TW
 Chi, Min-Chang, c/o Cal-Comp Big Data, Inc. No. 147, Sec. 3, Beishen Rd. Shenkeng Dists., 222 New Taipei City, TW
 Lin, Hui-Teng, c/o Cal-Comp Big Data, Inc. No. 147, Sec. 3, Beishen Rd. Shenkeng Dist., 222 New Taipei City, TW
 Wang, Ching-Wei, c/o Cal-Comp Big Data, Inc. No. 147, Sec. 3, Beishen Rd. Shenkeng Dist., 222 New Taipei City, TW
-

- (51) MKP
A01G 2/30 2018 (97) EP 3456178
- (96) EP 17290119.1 9/18/2017
 (97) EP 3456178, 10/30/2019 201944, en
 (54) NURSERY FRUIT TREE OF AT LEAST DOUBLE TRUNK TYPE
 (71) Gradilis Recherche SARL, Chemin Canta Aoussel, 34130 Mudaison, FR
 (72) Grand, Olivier, Mas Lou 4 Caires Chemin de la Font de Rulle, 34130 Mudaison, FR
 Vasseur, Thibault, 1234 Route de Lunel Viel Mas de cadoule Logement 3b, 34400 ST Just, FR
-

- (51) MKP
G06F 21/33 2013 (97) EP 3461073
G06Q 10/10 2012
H04L 12/58 2006
H04L 29/06 2006
H04W 4/14 2009
H04W 12/06 2009
- (96) EP 17382630.6 9/21/2017
 (97) EP 3461073, 10/30/2019 201944, en
 (54) PLATFORM AND METHOD OF CERTIFICATION OF AN ELECTRONIC NOTICE FOR ELECTRONIC IDENTIFICATION AND TRUST SERVICES (EIDAS)
 (72) SAPENA SOLER, Francisco, LLEIDANETWORKS SERVEIS TELEMATICS, S.A. Parque Tecnológico Agroalimentario, edificio H1, 2ªplanta,

25003 Lleida (LLEIDA), ES

- (51) MKP
G06F 21/33 2013 (97) EP 3461074
G06Q 10/10 2012
H04L 12/58 2006
H04L 29/06 2006
H04W 4/14 2009
H04W 12/06 2009
- (96) EP 17382631.4 9/21/2017
(97) EP 3461074, 10/30/2019 201944, en
(54) PLATFORM AND METHOD OF CERTIFICATION OF AN ELECTRONIC CONTRACT FOR ELECTRONIC IDENTIFICATION AND TRUST SERVICES (EIDAS)
(71) Lleidanetworks Serveis Telemàtics S.A., Parque Tecnológico Agroalimentario Edificio H1, 2ª planta, 25003 Lleida, ES
(72) SAPENA SOLER, Francisco, LLEIDANETWORKS SERVEIS TELEMATICS, S.A. Parque Tecnológico Agroalimentario edificio H1, 2ª planta, 25003 Lleida (LLEIDA), ES

- (51) MKP
A61K 31/4164 2006 (97) EP 3498276
A61K 31/505 2006
A61P 15/02 2006
- (96) EP 17382851.8 12/14/2017
(97) EP 3498276, 1/8/2020 202002, en
(54) ECTOINE AND ECTOINE DERIVATIVES FOR USE IN VULVOVAGINAL CONDITIONS
(71) Laboratorios Litaphar, S.L., Loiolabide, 7, 20730 Azpeitia - Gipuzkoa, ES
Disproquima, S.A., Carrer la Terra, 42, 08227 Terrassa - Barcelona, ES
(72) MOLERO RODRÍGUEZ, Francisca, Rafael de Casanova 68 -70, 3er-2a., E-08921 Santa Coloma de Gramenet - Barcelona, ES
TOMASI SCIANÒ, Giuseppe Giovanni, LABORATORIOS LITAPHAR, S.L. Loiolabide, 7, E-20730 Azpeitia - Gipuzkoa, ES
JIMÉNEZ LÓPEZ, Oscar, DISPROQUIMA, S.A. Carrer la Terra, 42, E-08227 Terrassa - Barcelona, ES

- (51) MKP
A61K 9/107 2006 (97) EP 3466409
A61K 9/16 2006
A61K 9/20 2006
A61K 9/50 2006
A61K 31/192 2006
A61K 31/519 2006
- (96) EP 17386032.1 10/5/2017
(97) EP 3466409, 11/13/2019 201946, en
(54) SELF-EMULSIFYING COMPOSITIONS OF WEAKLY IONIZABLE OR NON-IONIZABLE ACTIVE PHARMACEUTICAL INGREDIENTS
(71) Vianex S.A., Tatoiou Street 18th Kilometre Athens-Lamia National Road, 146 71 Nea Erythrea, GR
(72) Nikolakakis, Ioannis, Evzonon 9A, 55236 Panorama Thessaloniki, GR

- (51) MKP
A23G 9/08 2006 (97) EP 3565418
A23G 9/40 2006
A23G 9/52 2006
- (96) EP 17700081.7 1/5/2017
(97) EP 3565418, 11/13/2019 201946, en
(54) COMPOSITION AND PROCESS FOR PRODUCING ARTISAN ICE CREAM FOR BATCH FREEZING
(71) Argenti Italian Food S.r.l., Via Leonida di Mastrodicasa 252, 06134 Perugia, IT
(72) ARGENTI, Maria Paola, Strada di Montevile 41/A, 06135 Perugia, IT
GIOMBOLINI, Domenico, Strada dei Loggi 93, 06135 Perugia, IT
MACCARELLI, Enzo, Via Mattioli 14, 06122 Perugia, IT
NOVEMBRI ALUNNI, Claudio, Via del Moggio 158, 06132 Perugia, IT

- (51) MKP
A61K 47/00 2006 (97) EP 3570891
A61P 35/00 2006
- (96) EP 17732608.9 3/24/2017
(97) EP 3570891, 11/27/2019 201948, en
(31) 201715530513 (32) 23.01.2017 (33) US
(54) MEDICAMENTS AND USES IN TREATMENT OF CANCER AND OTHER PATHOLOGICAL CONDITIONS ASSOCIATED WITH AGING

(71) Tas, Sinan, S. Hasan Tuncel Caddesi N:36, 51700 Bor/Nigde, TR

(72) Tas, Sinan, S. Hasan Tuncel Caddesi N:36, 51700 Bor/Nigde, TR

(51) MKP

C07C 291/02 2006 (97) EP 3530649
C07C 405/00 2006

(96) EP 18157888.1 2/21/2018

(97) EP 3530649, 1/1/2020 202001, en

(54) PROCESS FOR THE PREPARATION OF A NITRIC OXIDE DONATING PROSTAGLANDIN ANALOGUE

(71) Nicox S.A., Drakkar 2 - Bât D 2405 route des Dolines - CS 10313 Sophia Antipolis, 06560 Valbonne, FR

(72) ALMIRANTE, Nicoletta, Via Caracciolo, 26, 20155 MILANO, IT

(51) MKP

G06K 9/00 2006 (97) EP 3457318

(96) EP 18161758.0 3/14/2018

(97) EP 3457318, 10/30/2019 201944, en

(31) 201710833322 (32) 15.09.2017 (33) CN

(54) BODY INFORMATION ANALYSIS APPARATUS AND BLUSH ANALYSIS METHOD THEREOF

(72) Shen, Shyh-Yong, No. 147, Sec. 3, Beishen Rd., Shenkeng Dist., 222 New Taipei City, TW

Chi, Min-Chang, No. 147, Sec. 3, Beishen Rd., Shenkeng Dist., 222 New Taipei City, TW

Gosno, Eric Budiman, No. 147, Sec. 3, Beishen Rd., Shenkeng Dist., 222 New Taipei City, TW

(51) MKP

A61K 31/33 2006 (97) EP 3456325

A61P 25/00 2006

C07D 213/50 2006

C07D 231/56 2006

C07D 235/06 2006

C07D 263/56 2006

C07D 307/80 2006

C07D 311/58 2006

C07D 317/54 2006

C07D 319/18 2006

C07D 327/06 2006

C07D 333/54 2006

C07D 339/08 2006

C07D 401/06 2006

C07D 405/06 2006

C07D 407/06 2006

C07D 409/06 2006

C07D 411/06 2006

C07D 413/06 2006

(96) EP 18182474.9 2/21/2014

(97) EP 3456325, 12/25/2019 201952, en

(31) 201361768033 P (32) 22.02.2013 (33) US

(54) GAMMA-DIKETONES AS WNT/BETA-CATENIN SIGNALING PATHWAY ACTIVATORS

(72) WALLACE, David Mark, 6448 Peinado Way, San Diego CA 92121, CA California, US

HOOD, John, 10831 Vereda Sol del Dios, San Diego CA 92130, CA California, US

KUMAR KC, Sunil, 10504 Clasico Court, San Diego CA 92127, CA California, US

BARROGA, Charlene, 8950 Costa Verde, San Diego CA 92122, CA California 4237, US

(51) MKP

A61K 9/14 2006 (97) EP 3456318

A61K 9/16 2006

A61K 9/20 2006

A61K 31/00 2006

(96) EP 18183992.9 6/9/2011

(97) EP 3456318, 10/30/2019 201944, en

(31) 81330110 (32) 10.06.2010 (33) US

35355310 P

10.06.2010

US

(54) SOLID COMPOSITIONS

(72) LIEPOLD, Bernd, Birkenweg 44, 69221 Dossheim, DE

JUNG, Tina, Eugenie_Kaufmann-Str. 22, 68163 Mannheim, DE

HOELIG, Peter, Hopfengarten 11, 63607 Waechtersbach, DE
 SCHROEDER, Rudolf, Brahmstr. 3, 67551 Worms-pfeddersheim, DE
 SEVER, Nancy E., 2643 N. Drury Lane, Arlington Heights, IL Illinois 60004, US
 LAFOUNTAIN, Justin, 659 W. Randolph 913, Chicago, IL Illinois 60661, US
 SINCLAIR, Brent D., 18377 Meander Drive, Grayslake, IL Illinois 60030, US
 GAO, Yi, 210 East Baltusrol, Vernon Hill, IL Illinois 60061, US
 WU, Jianwei, 1520 Eric Lane, Libertyville, IL Illinois 60048, US
 ERICKSON, Bryan K., 9299 8th Avenue, Pleasant Prarie, WI Wisconsin 53158, US
 KULLMANN, Simon, Dr.-Sammelweis-Str. 27, 67433 Neustadt an der Weinstrasse, DE
 WESTEDT, Ulrich, Weinheimer Str. 2, 69198 Schriesheim, DE
 PAULI, Mirko, Wielandstr. 30, 67065 Ludwigshafen, DE
 HEITERMANN, Tanja, Klosterstrasse 39, 76646 Bruchsal, DE
 KOENIG, Renato, Meckenheimer Str. 20 e, 67454 Hassloch, DE
 THIEL, Madlen, Görlitzer Str. 27, 67105 Schifferstadt, DE
 WOHRLE, Gerd, Seestr. 58, 69214 Eppelheim, DE

(51) MKP
C07K 16/28 2006 (97) EP 3456743

(96) EP 18185359.9 5/30/2014
 (97) EP 3456743, 10/30/2019 201944, en
 (31) 201361829082 P (32) 30.05.2013 (33) US

(54) ONCOSTATIN M RECEPTOR ANTIGEN BINDING PROTEINS
 (71) Kiniksa Pharmaceuticals, Ltd., Clarendon House 2 Church Street, Hamilton HM 11, BM
 (72) ARNETT, Heather A., 3029 25th Avenue W., Seattle, WA 98199, US
 ESCOBAR, Sabine S., 1707 E. Beaver Lake Drive SE, Sammamish, WA 98075, US
 KING, Chadwick T., 1325 Moody Avenue, North Vancouver, British Columbia V7L 3T5, CA
 LIM, Ai Ching, 7105 82nd Avenue SE, Mercer Island, WA 98040, US
 NARAYANAN, Saravanakumar, 70 Centre Street 1C, Brookline, MA 02446, US
 WEINREB, Paul H., 133 Boston Post Road, Weston, MA 02493, US
 PEDERSON, Nels E., 71 Patty's Road, Mansfield, MA 02048, US

(51) MKP
A61K 31/506 2006 (97) EP 3453708
A61P 35/00 2006
C07D 401/12 2006

(96) EP 18186197.2 12/15/2011
 (97) EP 3453708, 10/23/2019 201943, en
 (31) 201061424194 P (32) 17.12.2010 (33) US

(54) PROCESS FOR THE PREPARATION OF 5-CHLORO-N-(2-ISOPROPOXY-5-METHYL-4-PIPERIDIN-4-YL-PHENYL)-N-2-(ISOPROPYLSULFONYL)PHENYL)-2,4-DIAMINE DI-HYDROCHLORIDE
 (72) FENG, Lili, Novartis Pharmaceuticals Corporation One Health Plaza, East Hanover, New Jersey 07936-1080, US
 GONG, Baoqing, Novartis Pharmaceuticals Corporation One Health Plaza, East Hanover, New Jersey 07936-1080, US
 KARPINSKI, Piotr H., Novartis Pharmaceuticals Corporation One Health Plaza, East Hanover, New Jersey 07936-1080, US
 WAYKOLE, Liladhar Murlidhar, Novartis Pharmaceuticals Corporation One Health Plaza, East Hanover, New Jersey 07936-1080, US

(51) MKP
C07K 14/00 2006 (97) EP 3461889
C07K 19/00 2006
C12N 9/00 2006
C12N 9/12 2006
C12N 9/96 2006

(96) EP 18186578.3 11/19/2010
 (97) EP 3461889, 11/13/2019 201946, en
 (31) 26291909 P (32) 19.11.2009 (33) US
 35045710 P 01.06.2010 US
 35654110 P 18.06.2010 US
 39085710 P 07.10.2010 US

(54) COMPOSITIONS FOR INCREASING POLYPEPTIDE STABILITY AND ACTIVITY, AND RELATED METHODS
 (72) Kahre, Olev, c/o Solis BioDyne Riia 185a, EE-51014 Tartu, EE
 Artma, Kadri, c/o Solis BioDyne Riia 185a, EE-51014 Tartu, EE
 Kahre, Tiina, c/o Solis BioDyne Riia 185a, EE-51014 Tartu, EE

(51) MKP

C07F 9/576 2006 (97) EP 3459958
C07F 9/58 2006
 (96) EP 18186616.1 12/12/2014
 (97) EP 3459958, 11/6/2019 201945, en
 (31) 201361915937 P (32) 13.12.2013 (33) US
 (54) PROCESS AND INTERMEDIATES FOR PREPARING PRODRUGS OF PYRIDONE AMIDES USEFUL AS MODULATORS OF SODIUM CHANNELS
 (72) ANDERSON, Corey, 7565 Charmant Drive Unit 502, San Diego, CA California 92122, US
 HADIDA-RUAH, Sara Sabina, 2356 Torrey Pines Road 16, La Jolla, CA California 92037, US
 GOLEC, Julian Marian Charles, Milton Park, Abingdon, Oxfordshire SN7 7QI, GB
 ZHANG, Beili, 4505 Shorepointe Way, San Diego, CA California 92130, US
 LITTLER, Benjamin Joseph, 7016 Ivy Street, Carlsbad, CA California 92011, US
 KESHAVARZ-SHOKRI, Ali, 4285 Corte Langostino, San Diego, CA California 92130, US
 ALCACIO, Tim Edward, 4708 Lucille Drive, San Diego, CA California 92115, US
 BELMONT, Daniel T., 1 Gershom Drive, Grafton, MA Massachusetts 01536, US

(51) MKP
A01K 29/00 2006 (97) EP 3449720
A01K 63/00 2017
A22B 3/00 2006
A23B 4/06 2006
 (96) EP 18187445.4 8/6/2018
 (97) EP 3449720, 10/16/2019 201942, de
 (31) 102017008149 (32) 29.08.2017 (33) DE
 (54) DEVICE FOR THE TREATMENT OF PET FOOD FOR CARNIVORES
 (71) Messer Tatragas spol. s. r.o., Chalupkova 9, 81944 Bratislava, SK
 (72) Gockel, Frank, Schubertstraße 44, 42553 Velbert, DE
 Olexová, Dorota, Sibírska 699/18, 911 01 Trenčín, SK

(51) MKP
F17C 5/02 2006 (97) EP 3450819
 (96) EP 18187582.4 8/6/2018
 (97) EP 3450819, 10/16/2019 201942, de
 (31) 102017008211 (32) 31.08.2017 (33) DE
 (54) METHOD FOR FILLING A MOBILE COOLANT TANK WITH A CRYOGENIC COOLANT
 (72) Frère, Émilien, 15 avenue Gallieni, Appartement 18, 77100 Meaux, FR
 Gockel, Frank, Schubertstraße 44, 42553 Velbert, DE
 Beil, Denis, Robert-Koch-Straße 10, 53859 Niederkassel, DE

(51) MKP
A61K 9/20 2006 (97) EP 3456321
A61K 9/28 2006
A61K 31/4174 2006
A61P 25/04 2006
 (96) EP 18187598.0 3/10/2014
 (97) EP 3456321, 10/30/2019 201944, en
 (31) 201313829984 (32) 14.03.2013 (33) US
 (54) OPIOID RECEPTOR MODULATOR DOSAGE FORMULATIONS
 (71) Allergan Holdings Unlimited Company, Clonshaugh Business & Technology Park, Dublin 17, IE
 (72) CEULEMANS, Jens, Jozef, Turnhoutseweg 30, B-2340 Beerse, BE
 COSTELLO, Tim, 300 North 3rd Street Suite 110, Wilmington, NC North Carolina 28401, US
 JANS, Eugeen, Maria Jozef, Turnhoutseweg 30, B-2340 Beerse, BE
 HEYNS, Philip, Erna H., Turnhoutseweg 30, B-2340 Beerse, BE

(51) MKP
A61K 31/519 2006 (97) EP 3450434
A61P 35/02 2006
C07B 59/00 2006
C07D 487/04 2006
 (96) EP 18188152.5 6/14/2013
 (97) EP 3450434, 10/16/2019 201942, en
 (31) 201261660428 P (32) 15.06.2012 (33) US

201261678795 P

02.08.2012

US

- (54) DEUTERATED DERIVATIVES OF RUXOLITINIB
 (71) CoNCERT Pharmaceuticals, Inc., 65 Hayden Avenue, Suite 3000N, Lexington, MA 02421, US
 (72) SILVERMAN, I. Robert, 36 Orvis Road, Arlington, MA 02474, US
 LIU, Julie F., 3 Whitman Circle, Lexington, MA 02420, US
 MORGAN, Adam J., 14 Oak Ridge Lane, Ashland, MA 01721, US
 PANDYA, Bhaumik, 28 Silk Street, Arlington, MA 02474, US
 HARBESON, Scott L., 355 Shore Dr, Ellenton, FL 34222-2025, US

- (51) MKP
C07K 16/24 2006 (97) EP 3456740

(96) EP 18188208.5 11/2/2011

(97) EP 3456740, 10/23/2019 201943, en

- | | | | | | |
|------|----------------|------|------------|------|----|
| (31) | 41015810 P | (32) | 04.11.2010 | (33) | US |
| | 41195310 P | | 10.11.2010 | | US |
| | 41259410 P | | 11.11.2010 | | US |
| | 201161448785 P | | 03.03.2011 | | US |

(54) ANTI-IL-23 ANTIBODIES

- (72) Barrett, Rachel, c/o VP, IP, Legal, Boehringer Ingelheim USA Corp. 900 Ridgebury Road P.O.Box 368, Ridgefield, CT 06877-0368, US
 Canada, Keith, 24 Equinox Lane, Freehold, NJ 07728, US
 Catron, Katrina Mary, c/o VP, IP, Legal, Boehringer Ingelheim USA Corp. 900 Ridgebury Road P.O.Box 368, Ridgefield, CT 06877-0368, US
 Copenhaver, Robert, 4370 SW Twombly Ave, Portland, OR 97239, US
 Frego, Lee Edward, c/o VP, IP, Legal, Boehringer Ingelheim USA Corp. 900 Ridgebury Road P.O.Box 368, Ridgefield, CT 06877-0368, US
 Raymond, Ernest Lee, c/o VP, IP, Legal, Boehringer Ingelheim USA Corp. 900 Ridgebury Road P.O.Box 368, Ridgefield, CT 06877-0368, US
 Singh, Sanjaya, c/o VP, IP, Legal, Boehringer Ingelheim USA Corp. 900 Ridgebury Road P.O.Box 368, Ridgefield, CT 06877-0368, US
 Zhu, Xiangyang, c/o VP, IP, Legal, Boehringer Ingelheim USA Corp. 900 Ridgebury Road P.O.Box 368, Ridgefield, CT 06877-0368, US

- (51) MKP
C07D 403/14 2006 (97) EP 3555087

C07D 417/12 2006

C07D 417/14 2006

(96) EP 17816832.4 12/15/2017

(97) EP 3555087, 10/23/2019 201943, en

- | | | | | | |
|------|----------|------|------------|------|----|
| (31) | 16204840 | (32) | 16.12.2016 | (33) | EP |
|------|----------|------|------------|------|----|

(54) MONOCYCLIC OGA INHIBITOR COMPOUNDS

- (72) BARTOLOMÉ-NEBREDA, José, Manuel, c/o: Janssen-Cilag S.A. Edificio Johnson&Johnson Paseo de las Doce Estrellas 5-7 5° planta Campo de las Naciones, 28042 Madrid, ES
 TRABANCO-SUÁREZ, Andrés, Avelino, c/o: Janssen-Cilag S.A. Edificio Johnson&Johnson Paseo de las Doce Estrellas 5-7 5° planta Campo de las Naciones, 28042 Madrid, ES
 ALCÁZAR-VACA, Manuel, Jesús, c/o: Janssen-Cilag S.A. Edificio Johnson&Johnson Paseo de las Doce Estrellas 5-7 5° planta Campo de las Naciones, 28042 Madrid, ES
 MARTINEZ VITURRO, Carlos, Manuel, c/o: Janssen-Cilag S.A. Edificio Johnson&Johnson Paseo de las Doce Estrellas 5-7 5° planta Campo de las Naciones, 28042 Madrid, ES
 TRESADERN, Gary, John, c/o: Janssen-Cilag S.A. Edificio Johnson&Johnson Paseo de las Doce Estrellas 5-7 5° planta Campo de las Naciones, 28042 Madrid, ES
 ZHANG, Wei, c/o Janssen Research&Development LLC 920 US Route 202 PO Box 300, Raritan, NJ 08869, US
 CHEN, Gang, c/o Janssen Research&Development LLC 920 US Route 202 PO Box 300, Raritan, NJ 08869, US

- (51) MKP
A61K 31/4427 2006 (97) EP 3555064

A61K 31/497 2006

A61P 3/00 2006

C07D 401/14 2006

C07D 405/14 2006

C07D 413/14 2006

C07D 471/04 2006

C07D 487/04 2006

(96) EP 17817174.0 12/1/2017

(97) EP 3555064, 10/23/2019 201943, en

- | | | | | | |
|------|----------------|------|------------|------|----|
| (31) | 201662435533 P | (32) | 16.12.2016 | (33) | US |
|------|----------------|------|------------|------|----|

(54) GLP-1 RECEPTOR AGONISTS AND USES THEREOF

- (72) ASPNES, Gary Erik, 160 Clinton Street, Hopkinton, MA 01748, US
 BAGLEY, Scott W., 16 Riverbend Drive, Mystic, CT 06355, US

CURTO, John M., 11 Grove Avenue, Mystic, CT06355, US
 DOWLING, Matthew S., 1 Pyrus Court, Old Lyme, CT 06371, US
 EDMONDS, David James, 428 Massachusetts Avenue Apt. 6, Arlington, MA 02474, US
 FLANAGAN, Mark E., 10 Queen Eleanor Drive, Gales Ferry, CT 06335, US
 FUTATSUGI, Kentaro, 10 Faxon Avenue Apt. 808, Quincy, MA 02169, US
 GRIFFITH, David A., 55 Maple Avenue, Sudbury, MA 01776, US
 HUARD, Kim, 34 Thatcher Street, Medford, MA 02155, US
 INGLE, Gajendra, 195 Michelle Lane Apt. 102, Groton, CT 06340, US
 JIAO, Wenhua, 151 Beckwith Drive, Salem, CT 06420, US
 LIMBERAKIS, Chris, 37 River Crest Drive, Pawcatuck, CT 06379, US
 MATHIOWETZ, Alan M., 4 Miller Avenue, Quaker Hill, CT 06375, US
 PIOTROWSKI, David W., 19 Beacon Hill Drive, Waterford, CT 06385, US
 RUGGERI, Roger B., 53 Twin Lakes Drive, Waterford, CT 06385, US

- (51) MKP
A61K 39/395 2006 (97) EP 3551225
C07K 16/28 2006
- (96) EP 17818020.4 12/7/2017
 (97) EP 3551225, 10/16/2019 201942, en
- | | | | | | |
|------|----------------|------|------------|------|----|
| (31) | 201662431279 P | (32) | 07.12.2016 | (33) | US |
| | 201762570451 P | | 10.10.2017 | | US |
| | 201762582814 P | | 07.11.2017 | | US |
| | 201762586605 P | | 15.11.2017 | | US |
- (54) ANTIBODIES AND METHODS OF USE THEREOF
 (72) VAN DIJK, Marc, Tolhuislaan 8A, 3735 KG Bosch en Duin, NL
 MUNDT, Cornelia Anne, Hangstrasse 34, 79539 Lörrach, DE
 RITTER, Gerd, c/o Ludwig Institute for Cancer Research 666 Third Avenue, New York, New York 10017, US
 SCHAEER, David, 715 Shore Acres Drive, Mamaroneck, NY 10543, US
 WOLCHOK, Jedd David, 333 E. 30th Street Apt. 17C, New York, New York 10016, US
 MERGHOUB, Taha, 10 Huron Avenue Apt. 14K, Jersey City, NJ 07306, US
 WILSON, Nicholas Stuart, 43 Willow Glen Way, San Carlos, CA 94070-2841, US
 SAVITSKY, David Adam, 28 Sunrise Road, Boxford, MA 01921, US
 FINDEIS, Mark Arthur, 431 School Street, Belmont, Massachusetts 02478, US
 ZAPPASODI, Roberta, 475 Main Street Apt. 2U, New York, NY 10044, US
 HOLMGAARD, Rikke Bæk, 200 W. 60th Street Apt. 14F, New York, New York 10023, US
 CUIILLEROT, Jean-Marie, 5 Tower Court Apt. 4, Somerville, Massachusetts 02143, US
 PROSCURSHIM, Igor, 1193 Curve Street, Carlisle, Massachusetts 01741, US
 SHEBANOVA, Olga, 13 Malvern Avenue 1, Somerville, Massachusetts 02144, US

- (51) MKP
A61K 31/513 2006 (97) EP 3558316
A61P 15/00 2006
- (96) EP 17818103.8 12/13/2017
 (97) EP 3558316, 10/30/2019 201944, de
- | | | | | | |
|------|----------|------|------------|------|----|
| (31) | 16205339 | (32) | 20.12.2016 | (33) | EP |
|------|----------|------|------------|------|----|
- (54) USE OF CHYMASE INHIBITORS FOR THE TREATMENT OF ENDOMETRIOSIS, POST-OPERATIVE FIBROSIS AND DISEASES WHICH ARE CHARACTERIZED BY FIBROSIS FORMATION
 (72) PETERS, Michael, Heinrich-Roller Str. 1, 10405 Berlin, DE
 KOCH, Markus, Eschengraben 16, 13189 Berlin, DE
 ZOLLNER, Thomas, Holsteinische Str. 36, 12161 Berlin, DE

- (51) MKP
A61K 31/5365 2006 (97) EP 3555104
A61P 1/16 2006
A61P 9/00 2006
A61P 11/00 2006
A61P 11/06 2006
A61P 13/12 2006
A61P 17/06 2006
A61P 35/00 2006
C07D 498/04 2006
- (96) EP 17818303.4 12/11/2017
 (97) EP 3555104, 10/23/2019 201943, en
- | | | | | | |
|------|----------------|------|------------|------|----|
| (31) | 201662434745 P | (32) | 15.12.2016 | (33) | US |
|------|----------------|------|------------|------|----|

(54) NRF2 COMPOUNDS

(72) BROOKS, Carl A., 709 Swedeland Road, King of Prussia, PA 19406, US
MATTHEWS, Jay M., 709 Swedeland Road, King of Prussia, PA 19406, US

(51) MKP

A61K 31/554 2006 (97) EP 3555088
A61P 1/16 2006
A61P 9/00 2006
A61P 11/00 2006
A61P 11/06 2006
A61P 13/12 2006
A61P 17/06 2006
A61P 35/00 2006
C07D 417/12 2006
C07D 417/14 2006
C07D 498/04 2006

(96) EP 17818304.2 12/11/2017

(97) EP 3555088, 10/23/2019 201943, en

(31) 201662433954 P (32) 14.12.2016 (33) US

(54) BISARYL AMIDES AS NRF2 REGULATORS

(72) CALLAHAN, James Francis, 709 Swedeland Road, King Of Prussia, Pennsylvania 19406, US
 COLANDREA, Vincent J., 709 Swedeland Road, King Of Prussia, Pennsylvania 19406, US
 COOPER, Anthony William James, Gunnels Wood Road, Stevenage Hertfordshire SG1 2NY, GB
 GOODWIN, Nicole Cathleen, 709 Swedeland Road, King Of Prussia, Pennsylvania 19406, US
 HUFF, Chelsea Ariane, 709 Swedeland Road, King Of Prussia, Pennsylvania 19406, US
 KARPIAK, Joel, 709 Swedeland Road, King Of Prussia, Pennsylvania 19406, US
 KERNS, Jeffrey K., 709 Swedeland Road, King Of Prussia, Pennsylvania 19406, US
 NIE, Hong, 709 Swedeland Road, King Of Prussia, Pennsylvania 19406, US

(51) MKP

A61K 39/00 2006 (97) EP 3551660
C07K 16/28 2006

(96) EP 17818406.5 12/7/2017

(97) EP 3551660, 10/16/2019 201942, en

(31) 201662431272 P (32) 07.12.2016 (33) US

(54) ANTI-CTLA-4 ANTIBODIES AND METHODS OF USE THEREOF

(72) VAN DIJK, Marc, Tolhuislaan 8A, 3735 KG Bosch en Duin, NL
 MUNDT, Cornelia, Anne, Hangstrasse 34, 79539 Lörrach, DE
 RITTER, Gerd, c/o Ludwig Institute for Cancer Research 666 Third Avenue, New York, New York 10017, US
 SCHAEER, David, 715 Shore Acres Drive, Mamaroneck, NY 10543, US
 WOLCHOK, Jedd, David, 333 E. 30th Street Apt. 17C, New York, New York 10016, US
 MERGHOUB, Taha, 10 Huron Avenue Apt. 14K, Jersey City, NJ 07306, US
 WILSON, Nicholas, Stuart, 292 Grove Street, Medford, Massachusetts 02155, US
 SAVITSKY, David, Adam, 28 Sunrise Road, Boxford, MA 01921, US
 FINDEIS, Mark, Arthur, 431 School Street, Belmont, Massachusetts 02478, US
 UNDERWOOD, Dennis, John, 28 John A. Andrew Street, Boston, Massachusetts 02130, US
 CUIILLEROT, Jean-Marie, 5 Tower Court Apt. 4, Somerville, Massachusetts 02143, US
 PROSCURSHIM, Igor, 1193 Curve Street, Carlisle, Massachusetts 01741, US
 SHEBANOVA, Olga, 13 Malvern Avenue 1, Somerville, Massachusetts 02144, US

(51) MKP

A61K 31/55 2006 (97) EP 3558948
A61P 9/10 2006
C07D 223/16 2006

(96) EP 17818573.2 12/20/2017

(97) EP 3558948, 10/30/2019 201944, en

(31) 201621771 (32) 20.12.2016 (33) GB

(54) NEW SALT OF IVABRADINE AND USES THEREOF

(71) Biogena (A.P.I) Ltd, Iliou Street Ypsonas Industrial Area PO Box 50170, Limassol 3061, CY
 (72) IOANNOU, Savvas, c/o Biogena (A.P.I.) Ltd Iliou Street Ypsonas Industrial Area PO Box 50170, Limassol 3061, CY
 SERGIDES, Christakis, c/o Biogena (A.P.I.) Ltd Iliou Street Ypsonas Industrial Area PO Box 50170, Limassol 3061, CY
 PITTA, Daphne, c/o Biogena (A.P.I.) Ltd Iliou Street Ypsonas Industrial Area PO Box 50170, Limassol 3061, CY
 PITTAS, Andreas, c/o Biogena (A.P.I.) Ltd Iliou Street Ypsonas Industrial Area PO Box 50170, Limassol 3061, CY

- (51) MKP
A61K 31/551 2006 (97) EP 3555068
A61P 9/04 2006
A61P 11/00 2006
C07D 403/10 2006
C07D 403/12 2006
- (96) EP 17818632.6 12/11/2017
(97) EP 3555068, 10/23/2019 201943, en
- (31) 201662433965 P (32) 14.12.2016 (33) US
- (54) 3-OXO-1,4-DIAZEPINYLE COMPOUNDS AS NRF2 ACTIVATORS
(72) BOEHM, Jeffrey Charles, 709 Swedeland Road, King Of Prussia, Pennsylvania 19406, US
DAVIS, Roderick S., 709 Swedeland Road, King Of Prussia, Pennsylvania 19406, US
GOODWIN, Nicole Cathleen, 709 Swedeland Road, King Of Prussia, Pennsylvania 19406, US
KERNS, Jeffrey K., 709 Swedeland Road, King Of Prussia, Pennsylvania 19406, US
LI, Tindy, 709 Swedeland Road, King Of Prussia, Pennsylvania 19406, US
YAN, Hongxing, 709 Swedeland Road, King Of Prussia, Pennsylvania 19406, US

- (51) MKP
A61K 31/553 2006 (97) EP 3555082
A61K 31/554 2006
A61P 9/04 2006
A61P 11/00 2006
C07D 249/04 2006
C07D 413/12 2006
C07D 419/12 2006
C07D 419/14 2006
C07D 471/04 2006
C07D 498/04 2006
- (96) EP 17818633.4 12/11/2017
(97) EP 3555082, 10/23/2019 201943, en
- (31) 201662434500 P (32) 15.12.2016 (33) US
- (54) ETHER LINKED TRIAZOLES AS NRF2 REGULATORS
(72) COOPER, Anthony William James, Gunnels Wood Road, Stevenage Hertfordshire SG1 2NY, GB
GOODWIN, Nicole Cathleen, 709 Swedeland Road, King Of Prussia, Pennsylvania 19406, US
GRIFFITHS-JONES, Charlotte Mary, 436 Cambridge Science Park Milton Road, Cambridge Cambridgeshire CB4 0QA, GB
HEIGHTMAN, Thomas Daniel, 436 Cambridge Science Park Milton Road, Cambridge Cambridgeshire CB4 0QA, GB
KERNS, Jeffrey K., 709 Swedeland Road, King Of Prussia, Pennsylvania 19406, US
WILLEMS, Hendrika Maria Gerarda, 436 Cambridge Science Park Milton Road, Cambridge Cambridgeshire CB4 0QA, GB
YAN, Hongxing, 709 Swedeland Road, King Of Prussia, Pennsylvania 19406, US

- (51) MKP
A61K 31/496 2006 (97) EP 3585779
A61K 31/497 2006
A61K 31/501 2006
A61K 31/506 2006
C07B 59/00 2006
C07D 401/12 2006
C07D 403/12 2006
C07D 405/12 2006
C07D 405/14 2006
C07D 407/12 2006
C07D 413/12 2006
C07D 417/12 2006
C07D 417/14 2006
C07D 471/04 2006
C07D 475/04 2006
C07D 487/04 2006
C07D 495/04 2006
C07D 498/04 2006
C07D 513/04 2006
- (96) EP 17755535.6 8/24/2017
(97) EP 3585779, 1/1/2020 202001, en
- (31) PCT/EP2017/054280 (32) 24.02.2017 (33) WO

PCT/EP2017/054268 24.02.2017 WO

(54) SUBSTITUTED DIHYDROBENZOFURAN GLYCOSIDASE INHIBITORS
 (71) Asceneuron S.A., EPFL Innovation Park Bâtiment B, 1015 Lausanne, CH
 (72) QUATTROPANI, Anna, Grand'rue 5, 1180 Rolle, CH
 KULKARNI, Santosh S., A206, Temple Trees Apartment J P Nagar 6th Phase, Bangalore 560078, IN
 GIRI, Awadut Gajendra, Flat no. 408 MB4 Surya City, Chandapura Bangalore 560099, IN

(51) MKP
C07D 401/12 2006 (97) EP 3585783
C07D 405/12 2006
C07D 413/12 2006
C07D 417/12 2006
C07D 417/14 2006
C07D 495/04 2006

(96) EP 17758140.2 8/24/2017
 (97) EP 3585783, 1/1/2020 202001, en

(31) PCT/EP2017/054280 (32) 24.02.2017 (33) WO
 PCT/EP2017/054268 24.02.2017 WO

(54) SULFOXIMINE GLYCOSIDASE INHIBITORS
 (72) QUATTROPANI, Anna, Grand'rue 5, 1180 Rolle, CH
 KULKARNI, Santosh S., A206 Temple Trees Apartment J P Nagar 6th Phase, Bangalore 560078, IN
 GIRI, Awadut Gajendra, Flat no. 408 MB4 Surya City, Chandapura Bangalore 560099, IN

(51) MKP
A21D 13/80 2017 (97) EP 3566583
A23L 5/40 2016
A23L 33/00 2016
A23L 33/21 2016

(96) EP 17808964.5 10/2/2017
 (97) EP 3566583, 11/13/2019 201946, en

(31) 201700254 (32) 23.03.2017 (33) ES

(54) CHILDREN'S BISCUIT WITH NO ADDED SUGAR AND METHOD OF PREPARING IT
 (71) Cuetara, S.L, Avenida Hermanos Gomez Cuetara Num. 1, 28590 Villarejo de Salvanes (Madrid), ES
 (72) VARGAS OLMO, Juan Gabriel, Avda. President Kennedy 55 A, 08320 El Masnou (Barcelona), ES

(51) MKP
H02K 3/52 2006 (97) EP 3552303

(96) EP 17809306.8 12/7/2017
 (97) EP 3552303, 10/16/2019 201942, de

(31) 102016224526 (32) 08.12.2016 (33) DE

(54) STATOR OF AN ELECTRICAL MACHINE, ELECTRICAL MACHINE, AND ROUTING AND CONTACTING DEVICE FOR AN ELECTRICAL MACHINE
 (72) HOFFMANN, Martin, Pfannenstiel 12, 88048 Friedrichshafen, DE
 WÜST, Stefan, Brunnengasse 4, 97816 Lohr am Main, DE
 ZIEGLER, Thomas, Georg-Leder-Str. 8, 97450 Schwebenried, DE

(51) MKP
A61K 31/165 2006 (97) EP 3574898
A61P 25/14 2006

(96) EP 18000481.4 5/29/2018
 (97) EP 3574898, 12/4/2019 201949, en

(54) SAFINAMIDE FOR THE TREATING MYOTONIA
 (72) Desaphy, Jean-François, Via Nicolò Giudice 8, 70010 Cellamare (BA), IT
 Pierno, Sabata, Via Nicolò Giudice 8, 70010 Cellamare (BA), IT
 Diana, Conte, Via della Costituente 43, 70125 Bari (BA), IT
 Melloni, Elsa, Via Ornato 110 D, 20162 Milano, IT
 Vailati, Silvia, Via Parini 106, 20862 Arcore (MB), IT
 Padoani, Gloria, Via Calori - 16, 20085 Locate Triulzi (MI), IT
 Caccia, Carla, Via Fieramosca 9, 21013 Gallarate (VA), IT

(51) MKP

A61K 31/4045 2006 (97) EP 3461821
A61P 29/00 2006
A61P 37/00 2006
C07D 209/18 2006
C07D 401/04 2006
C07D 401/06 2006
C07D 401/12 2006
C07D 403/04 2006
C07D 403/10 2006
C07D 403/12 2006
C07D 413/04 2006
C07D 417/04 2006
C07D 471/04 2006
C07D 487/04 2006
C07D 487/10 2006
 (96) EP 18205411.4 10/23/2015
 (97) EP 3461821, 11/6/2019 201945, en
 (31) 201462068225 P (32) 24.10.2014 (33) US
 (54) INDOLE CARBOXAMIDE COMPOUNDS USEFUL AS KINASE INHIBITORS
 (72) AHMAD, Saleem, Bristol-Myers Squibb Company Route 206 and Province Line Road, Princeton, NJ 08543, US
 TEBBEN, Andrew J, Bristol-Myers Squibb Company Route 206 and Province Line Road, Princeton, NJ 08543, US
 GONG, Hua, Bristol-Myers Squibb Company Route 206 and Province Line Road, Princeton, NJ 08543, US
 LIU, Qingjie, Bristol-Myers Squibb Company Route 206 and Province Line Road, Princeton, NJ 08543, US
 NGU, Khehyong, Bristol-Myers Squibb Company Route 206 and Province Line Road, Princeton, NJ 08543, US
 WATTERSON, Scott Hunter, Bristol-Myers Squibb Company Route 206 and Province Line Road, Princeton, NJ 08543, US

(51) MKP
C07K 16/28 2006 (97) EP 3466977
 (96) EP 18205524.4 4/15/2011
 (97) EP 3466977, 11/20/2019 201947, en
 (31) 32494410 (32) 16.04.2010 (33) US
 (54) ANTI-VLA-4 ANTIBODIES
 (72) LUGOVSKOY, Alexey A., 35 Audrey Road, Belmont, MA 02478, US
 TAYLOR, Frederick R., 98 Gulliver Street, Milton, MA 02186, US
 MCLACHLAN, Karen, 948 Valley Ave, Solana Beach, CA 92075, US

(51) MKP
C07D 207/06 2006 (97) EP 3461828
C07D 239/46 2006
C07D 239/47 2006
C07D 239/48 2006
C07D 239/545 2006
C07D 487/04 2006
 (96) EP 18205728.1 9/14/2015
 (97) EP 3461828, 12/11/2019 201950, en
 (31) 201462051044 P (32) 16.09.2014 (33) US
 (54) METHODS OF PREPARING TOLL-LIKE RECEPTOR MODULATORS
 (72) ALLEN, Darin, c/o Gilead Sciences Inc. 333 Lakeside Drive, Foster City, CA 94404, US
 BROWN, Brandon Heath, c/o Gilead Sciences Inc. 333 Lakeside Drive, Foster City, CA 94404, US
 CHAO, Jessica Jade, 6134 Countess Drive, San Jose, CA 95129, US
 HALCOMB, Randall L., 892 Gull Avenue, Foster City, CA 94404, US
 HRVATIN, Paul, Department of Chemistry UC Davis One Shields Ave, Davis, CA 95616, US
 MCFADDEN, Ryan, c/o Gilead Sciences Inc. 333 Lakeside Drive, Foster City, CA 94404, US
 ROETHLE, Paul, 2210 Browning Street, Berkeley, CA 94702, US
 RUDIO, Erwina, c/o Gilead Sciences Inc. 333 Lakeside Drive, Foster City, CA 94404, US
 YANG, Hong, c/o Gilead Sciences Inc. 333 Lakeside Drive, Foster City, CA 94404, US
 YU, Richard Hung Chiu, c/o Gilead Sciences Inc. 333 Lakeside Drive, Foster City, CA 94404, US

(51) MKP
A61L 27/36 2006 (97) EP 3476410
A61L 27/38 2006
A61L 27/54 2006
 (96) EP 18205901.4 9/17/2013

(97) EP 3476410, 12/11/2019 201950, en
 (31) 201261703203 P (32) 19.09.2012 (33) US
 (54) COMPOSITIONS AND METHODS FOR TREATING AND PREVENTING TISSUE INJURY AND DISEASE
 (71) MicroVascular Tissues, Inc., 100 Cummings Center, Suite 215F, Beverly, MA 01915, US
 (72) Peterson, Dale R., 7168 Sitio Corazon, Carlsbad, CA California 92009, US
 Mattern, Ralph-Heiko, 24859 Oakana Road, Ramona, CA California 92065, US
 Wilson-Wirth, Corey, 1780 Kettner Blvd. 103, San Diego, CA California 92101, US
 Ohashi, Kevin L., 60 Orchard Street, Jamaica Plain, MA Massachusetts 02130, US

(51) MKP
A61K 31/225 2006 (97) EP 3466420
A61P 25/14 2006
A61P 25/28 2006
 (96) EP 18206136.6 4/29/2010
 (97) EP 3466420, 11/20/2019 201947, en
 (31) 17379709 P (32) 29.04.2009 (33) US
 17527009 P 04.05.2009 US
 (54) DIMETHYL FUMARATE FOR THE TREATMENT OF FRIEDREICH ATAXIA
 (72) Lukashov, Matvey, 3 Louis Rd., Tewksbury, MA Massachusetts 02142, US

(51) MKP
A61K 31/7088 2006 (97) EP 3483273
A61P 35/00 2006
C07K 14/47 2006
C12N 15/113 2010
 (96) EP 18206571.4 10/30/2013
 (97) EP 3483273, 12/25/2019 201952, en
 (31) 201261720939 P (32) 31.10.2012 (33) US
 201361777875 P 12.03.2013 US
 (54) CANCER TREATMENT
 (72) CROOKE, Stanley, T, Isis Pharmaceuticals Inc. 2855 Gazelle Court, Carlsbad, CA 92010, US
 YAMASHITA, Mason, Isis Pharmaceuticals Inc. 2855 Gazelle Court, Carlsbad, CA 92010, US

(51) MKP
A61K 39/00 2006 (97) EP 3473648
A61K 39/395 2006
A61P 35/00 2006
C07K 16/22 2006
C07K 16/28 2006
C07K 16/30 2006
 (96) EP 18206830.4 1/23/2015
 (97) EP 3473648, 11/6/2019 201945, en
 (31) 201461930582 P (32) 23.01.2014 (33) US
 201462089549 P 09.12.2014 US
 (54) HUMAN ANTIBODIES TO PD-L1
 (72) PAPADOPOULOS, Nicholas, J., c/o Regeneron Pharmaceuticals Inc. 777 Old Saw Mill River Road, Tarrytown, NY 10591, US
 MURPHY, Andrew, J., c/o Regeneron Pharmaceuticals Inc. 777 Old Saw Mill River Road, Tarrytown, NY 10591, US
 THURSTON, Gavin, c/o Regeneron Pharmaceuticals Inc. 777 Old Saw Mill River Road, Tarrytown, NY 10591, US
 IOFFE, Ella, c/o Regeneron Pharmaceuticals Inc. 777 Old Saw Mill River Road, Tarrytown, NY 10591, US
 BUROVA, Elena, c/o Regeneron Pharmaceuticals Inc. 777 Old Saw Mill River Road, Tarrytown, NY 10591, US

(51) MKP
B29C 31/04 2006 (97) EP 3486076
B29C 70/48 2006
B29C 70/54 2006
 (96) EP 18206913.8 11/19/2018
 (97) EP 3486076, 12/25/2019 201952, en
 (31) PCT/EP2017/079807 (32) 20.11.2017 (33) WO
 (54) RESIN SUPPLY SYSTEM FOR RTM (RESIN-TRANSFER-MOLDING) AND RELATED METHOD
 (71) Coexpair S.A., rue des Entrepreneurs 10, 5020 Namur, BE
 (72) BERTIN, André, 8 rue Depoortere, 5020 Namur, BE

(51) MKP
C12Q 1/6804 2018 (97) EP 3495505

(96) EP 18207398.1 3/14/2014
 (97) EP 3495505, 1/15/2020 202003, en

(31) 201361784253 P (32) 14.03.2013 (33) US

(54) QUANTITATIVE ASSESSMENT FOR CAP EFFICIENCY OF MESSENGER RNA
 (72) HEARTLEIN, Michael, c/o Shire Human Genetic Therapies, Inc. 300 Shire Way, Lexington, MA 02421, US
 DEROSA, Frank, c/o Shire Human Genetic Therapies, Inc. 300 Shire Way, Lexington, MA 02421, US
 DIAS, Anusha, c/o Shire Human Genetic Therapies, Inc. 300 Shire Way, Lexington, MA 02421, US

(51) MKP
B03C 1/033 2006 (97) EP 3488932
B03C 1/22 2006
B03C 1/23 2006

(96) EP 18207728.9 11/22/2018
 (97) EP 3488932, 1/8/2020 202002, de

(31) 509812017 (32) 24.11.2017 (33) AT

(54) SEPARATION OF COMPONENTS OF A MIXTURE CONTAINING METAL
 (71) IFE Aufbereitungstechnik Gmbh, Patertal 20, 3340 Waidhofen/Ybbs, AT
 (72) KARL, Christian, Tormäuerstrasse 45a, 3292 Gaming, AT

(51) MKP
A61K 31/4375 2006 (97) EP 3466490
A61K 31/4985 2006
A61K 31/5365 2006
A61K 45/06 2006
A61P 31/18 2006
C07D 491/14 2006
C07D 491/22 2006
C07D 498/14 2006
C07D 498/16 2006
C07D 498/22 2006
C07D 513/22 2006

(96) EP 18207888.1 4/1/2016
 (97) EP 3466490, 11/13/2019 201946, en

(31) 201562142338 P (32) 02.04.2015 (33) US

(54) POLYCYCLIC-CARBAMOYLPIRIDONE COMPOUNDS AND THEIR PHARMACEUTICAL USE
 (72) CAI, Zhenhong, R., c/o Gilead Sciences Inc. 333 Lakeside Drive, Foster City, CA 94404, US
 JIN, Haolun, c/o Gilead Sciences Inc. 333 Lakeside Drive, Foster City, CA 94404, US
 LAZERWITH, Scott, E., c/o Gilead Sciences Inc. 333 Lakeside Drive, Foster City, CA 94404, US
 PYUN, Hyung-Jung, c/o Gilead Sciences Inc. 333 Lakeside Drive, Foster City, CA 94404, US

(51) MKP
A61K 35/37 2015 (97) EP 3495385
A61L 2/00 2006
C07K 14/755 2006

(96) EP 18208034.1 12/14/2011
 (97) EP 3495385, 1/8/2020 202002, en

(31) 42351210 P (32) 15.12.2010 (33) US

(54) VIRAL INACTIVATION USING IMPROVED SOLVENT-DETERGENT METHOD
 (72) Felgenhauer, Martin, Colloredogasse 27, 1180 Vienna, AT
 Mison, Dominique, 123 Bd de Lattre de Tassigny, 17340 Chatelaillon-Plage, FR
 Montandon, Frederic, 9, rue des Hirondelles, 25130 Villers-le-Lac, FR
 Farcet, Maria, Haberlgasse 82/10, 1160 Vienna, AT

(51) MKP
A23B 5/005 2006 (97) EP 3491933
A23B 5/01 2006
A23L 3/005 2006
A23L 15/00 2016

(96) EP 18209377.3 11/30/2018
 (97) EP 3491933, 1/15/2020 202003, en

(31) 201700138714 (32) 01.12.2017 (33) IT
 (54) A METHOD OF MICROBIOLOGICAL SANITISATION OF THE SURFACE OF WHOLE EGGS IN SHELL
 (71) Fontana, Mauro, Via Nigra 49/C, 10147 Torino, IT
 Bisotti, Stefano, Stradone Farnese 17, 29121 Piacenza, IT
 Branciaroli, Osvaldo, Strada Valpiana 12, 10132 Torino, IT
 (72) Fontana, Mauro, Via Nigra 49/C, 10147 Torino, IT
 Bisotti, Stefano, Stradone Farnese 17, 29121 Piacenza, IT
 Branciaroli, Osvaldo, Strada Valpiana 12, 10132 Torino, IT

(51) MKP
G01V 5/00 2006 (97) EP 3483635

(96) EP 18211256.5 4/21/2011
 (97) EP 3483635, 12/25/2019 201952, en

(31) 42097310 P (32) 08.12.2010 (33) US
 32650310 P 21.04.2010 US

(54) METHOD AND SYSTEM FOR USE IN PERFORMING SECURITY SCREENING
 (71) Vanderlande APC Inc., 1280 Boulevard Lebourgneuf Bureau 420, Quebec, QC G2K 0H1, CA
 (72) PERRON, Luc, 1127 de la Chatelaine, Charlesbourg, Québec G2L 1A1, CA

(51) MKP
A61K 31/519 2006 (97) EP 3492472
A61P 17/06 2006
A61P 19/02 2006
C07B 59/00 2006
C07D 471/04 2006
C07D 487/04 2006

(96) EP 18213179.7 8/15/2013
 (97) EP 3492472, 1/8/2020 202002, en

(31) 201261684196 P (32) 17.08.2012 (33) US
 201361780661 P 13.03.2013 US

(54) DEUTERATED BARICITINIB WITH IMPROVED METABOLIC STABILITY AS JAK1 AND JAK2 KINASE INHIBITOR FOR TREATING E.G. RHEUMATOID ARTHRITIS
 (71) Concert Pharmaceuticals Inc., 65 Hayden Avenue, Suite 3000N, Lexington, MA 02421, US
 (72) Tung,, Roger D, 3 Burnham Road, Lexington, MA Massachusetts 02420, US

(51) MKP
C07D 498/16 2006 (97) EP 3486248
C07D 498/18 2006

(96) EP 18213678.8 9/26/2013
 (97) EP 3486248, 1/1/2020 202001, en

(31) 201261705731 P (32) 26.09.2012 (33) US

(54) IMPROVED METHODS FOR THE ACYLATION OF MAYTANSINOL
 (72) Widdison, Wayne C, 7 Holden Road, Belmont, MA Massachusetts 02478, US
 Zhao, Robert Yongxin, 7 Loring Road, Lexington, MA Massachusetts 02421, US

(51) MKP
A61P 35/00 2006 (97) EP 3489362
C12N 15/85 2006

(96) EP 18214778.5 10/19/2015
 (97) EP 3489362, 1/1/2020 202001, en

(31) 201462065138 P (32) 17.10.2014 (33) US
 201562151315 P 22.04.2015 US

(54) BIPARTITE AND TRIPARTITE SIGNALING IMMUNE CELLS
 (72) VALDES, Juan Fernando Vera, 5227 Maple Street, Bellaire, TX 77401, US
 LEEN, Ann Marie, 5227 Maple Street, Bellaire, TX 77401, US
 SUKUMARAN, Sujita, 777 Dunlavy Street, Apt 6206, Houston, TX 77019, US

(51) MKP
A61K 31/135 2006 (97) EP 3501542
A61K 45/06 2006
A61P 25/24 2006

(96)	EP 18215651.3	12/21/2018					
(97)	EP 3501542,	1/15/2020	202003,	en			
(31)	201762609504 P		(32)	22.12.2017	(33)	US	
	201862663219 P			26.04.2018		US	
	201862663206 P			26.04.2018		US	
	201862667406 P			04.05.2018		US	
	201862675846 P			24.05.2018		US	
	201862755905 P			05.11.2018		US	
(54)	ESKETAMINE FOR THE TREATMENT OF DEPRESSION						
(72)	CANUSO, Carla, 1125 Trenton-Harbourton Road, Titusville, NJ New Jersey 08560, US						
	DALY, Ella, 1125 Trenton-Harbourton Road, Titusville, NJ New Jersey 08560, US						
	DREVETS, Wayne, 3210 Merryfield Row, San Diego, CA California 92121, US						
	LI, Honglan, 1800 American Boulevard, Pennington, NJ New Jersey 08534, US						
	HOUGH, David Wood, 1800 American Boulevard, Pennington, NJ New Jersey 08534, US						
	JANIK, Adam, 3210 Merryfield Row, San Diego, CA California 92121, US						
	OCHS-ROSS, Rachel, 1800 American Boulevard, Pennington, NJ New Jersey 08534, US						
	SINGH, Jaskaran, 3210 Merryfield Row, San Diego, CA California 92121, US						
	WAJS, Ewa, Turnhoutseweg 30, 2340 Beerse, BE						
	ZANNIKOS, Peter, 1125 Trenton-Harbourton Road, Titusville, NJ New Jersey 08560, US						
<hr/>							
(51)	MKP						
	A61K 9/00	2006	(97) EP 3558379				
	A61K 9/08	2006					
	A61K 31/496	2006					
	A61K 47/10	2017					
(96)	EP 17821532.3	12/13/2017					
(97)	EP 3558379,	10/30/2019	201944,	de			
(31)	16205686		(32)	21.12.2016	(33)	EP	
	17157800			24.02.2017		EP	
(54)	PHARMACEUTICAL DOSAGE FORMS CONTAINING TASK-1 AND TASK-3 CHANNEL INHIBITORS, AND THE USE OF SAME IN BREATHING DISORDER THERAPY						
(72)	ANLAHR, Johanna, Vinckestr. 5, 44139 Dortmund, DE						
	BECK-BROICHSITTER, Moritz, Im Hilsbruch 47, 64291 Darmstadt, DE						
	NICOLAI, Janine, Bernhardstr. 56, 45239 Essen, DE						
	DELBECK, Martina, Müllerweg 10, 42579 Heiligenhaus, DE						
	HAHN, Michael, Rietherbach 42D, 40764 Langenfeld, DE						
	ALBUS, Udo, Am Römerkastell 9, 61197 Florstadt, DE						
	GEHRING, Doris, Frankfurter Str. 166, 65779 Kelkheim, DE						
	ROSENSTEIN, Björn, Mühlenstr. 2, 63628 Bad Soden-Salmünster, DE						
<hr/>							
(51)	MKP						
	A61K 31/437	2006	(97) EP 3558988				
	A61K 31/4985	2006					
	A61P 25/00	2006					
	A61P 25/16	2006					
	A61P 25/28	2006					
	C07D 471/04	2006					
	C07D 487/04	2006					
	C07D 519/00	2006					
(96)	EP 17821622.2	12/20/2017					
(97)	EP 3558988,	10/30/2019	201944,	en			
(31)	PA201600784		(32)	22.12.2016	(33)	DK	
	PA201700404			06.07.2017		DK	
(54)	PYRAZOLO[3,4-B]PYRIDINES AND IMIDAZO[1,5-B]PYRIDAZINES AS PDE1 INHIBITORS						
(72)	KEHLER, Jan, c/o H. Lundbeck A/S Ottiliavej 9, 2500 Valby, DK						
	RASMUSSEN, Lars, Kyhn, c/o H. Lundbeck A/S Ottiliavej 9, 2500 Valby, DK						
	LANGGÅRD, Morten, c/o H. Lundbeck A/S Ottiliavej 9, 2500 Valby, DK						
	JESSING, Mikkel, c/o H. Lundbeck A/S Ottiliavej 9, 2500 Valby, DK						
	VITAL, Paulo, Jorge, Vieira, c/o H. Lundbeck A/S Ottiliavej 9, 2500 Valby, DK						
	JUHL, Karsten, c/o H. Lundbeck A/S Ottiliavej 9, 2500 Valby, DK						
	MARIGO, Mauro, c/o H. Lundbeck A/S Ottiliavej 9, 2500 Valby, DK						
<hr/>							
(51)	MKP						

(51) MKP
A61K 31/5375 2006 (97) EP 3558951
C07C 21/00 2006
C07D 265/30 2006
(96) EP 17821624.8 12/20/2017
(97) EP 3558951, 10/30/2019 201944, en
(31) 201600130538 (32) 23.12.2016 (33) IT
(54) METHOD FOR THE MANUFACTURING OF DELMOPINOL
(72) DE FAVERI, Carla, Via dei Colli 28, 31010 Farra di Soligo TV, IT
STIVANELLO, Mariano, Via Marostica 20, 36015 Schio (VI), IT

(51) MKP
B30B 11/20 2006 (97) EP 3551444
(96) EP 17821830.1 12/7/2017
(97) EP 3551444, 10/16/2019 201942, de
(31) 511202016 (32) 09.12.2016 (33) AT
(54) DEVICE FOR PRODUCING PELLETS
(71) Josef Schaidler Privatstiftung, Bachgasse 12, 3430 Tulln-Staasdorf, AT
(72) SCHAIDER, Ludwig, Wiesenweg 4, 3430 Staasdorf, AT
SCHAIDER, Josef, Wiesenweg 4, 3430 Staasdorf, AT

(51) MKP
C07K 1/14 2006 (97) EP 3555114
C07K 7/08 2006
C07K 7/56 2006
(96) EP 17821855.8 12/12/2017
(97) EP 3555114, 10/23/2019 201943, en
(31) 201600127655 (32) 16.12.2016 (33) IT
(54) PROCESS FOR THE PURIFICATION OF LIPOPOLYPEPTIDE ANTIBIOTICS
(71) Gnosis S.p.A., Piazza Filippo Meda, 3, 20121 Milano, IT
(72) VALOTI, Ermanno, Via Cascina Nuova 14, 24044 Dalmine (BG), IT
ROSSINI, Mauro, c/o Gnosis S.p.A. Via Laboratori Autobianchi 1, 20832 Desio (MB), IT
TAGLIANI, Auro Roberto, c/o Gnosis S.p.A. Via Laboratori Autobianchi 1, 20832 Desio (MB), IT

(51) MKP
G01R 15/26 2006 (97) EP 3552030
G01R 29/08 2006
(96) EP 17822028.1 12/8/2017
(97) EP 3552030, 10/16/2019 201942, fr
(31) 1670747 (32) 09.12.2016 (33) FR
(54) DEVICE FOR MEASURING A RADIOELECTRIC DOSE ON A SURFACE, IN PARTICULAR FOR MEASURING THE RADIOLOGICAL DOSE FOR A PATIENT DURING A RADIOLOGY OPERATION
(72) MAALLOUL, Fouad, 30 Rue Léon Delos, 59700 Marcq en Baroeul, FR
GUERIN, Laura, 9 Rue Gosselet, 59000 Lille, FR
LOYEZ, Christophe, 245 Rue Résidence les Prés du Lièvre, 62149 Festubert, FR

(51) MKP
C07K 14/47 2006 (97) EP 3551754
C12N 15/10 2006
C12N 15/63 2006
C12N 15/864 2006
(96) EP 17822105.7 12/6/2017
(97) EP 3551754, 10/16/2019 201942, en
(31) 201662431787 P (32) 08.12.2016 (33) US
201762542660 P 08.08.2017 US
(54) METHODS AND COMPOSITIONS FOR ENHANCING FUNCTIONAL MYELIN PRODUCTION
(72) TESAR, Paul, 10900 Euclid Avenue, Cleveland, OH 44106, US
ELITT, Matthew, 10900 Euclid Avenue, Cleveland, OH 44106, US

(51) MKP
A61K 9/08 2006 (97) EP 3558380
A61K 31/496 2006

A61K 47/10 2017
 (96) EP 17822216.2 12/13/2017
 (97) EP 3558380, 10/30/2019 201944, de
 (31) 16205688 (32) 21.12.2016 (33) EP
 17157805 24.02.2017 EP
 (54) PHARMACEUTICAL DOSAGE FORMS CONTAINING TASK-1 AND TASK-3 CHANNEL INHIBITORS, AND THE USE OF SAME IN BREATHING DISORDER THERAPY
 (72) ANLAHR, Johanna, Vinckestr. 5, 44139 Dortmund, DE
 BECK-BROICHSITTER, Moritz, Im Hilsbruch 47, 64291 Darmstadt, DE
 NICOLAI, Janine, Bernhardstr. 56, 45239 Essen, DE
 DELBECK, Martina, Müllerweg 10, 42579 Heiligenhaus, DE
 HAHN, Michael, Rietherbach 42D, 40764 Langenfeld, DE
 ALBUS, Udo, Am Römerkastell 9, 61197 Florstadt, DE
 GEHRING, Doris, Frankfurter Str. 166, 65779 Kelkheim, DE
 ROSENSTEIN, Björn, Mühlenstr. 2, 63628 Bad Soden-Salmünster, DE

(51) MKP
E05F 11/38 2006 (97) EP 3555400
E05F 11/48 2006
 (96) EP 17822260.0 12/19/2017
 (97) EP 3555400, 10/23/2019 201943, de
 (31) 202016107095 U (32) 19.12.2016 (33) DE
 (54) RAIL SLIDER FOR A CABLE-TYPE WINDOW LIFTER OF A MOTOR VEHICLE
 (71) Brose Fahrzeugteile GmbH & Co. Kommanditgesellschaft, Bamberg, Berliner Ring 1, 96052 Bamberg, DE
 (72) MÜLLER, Jörg, Nürnbergerstraße 153, 96050 Bamberg, DE
 DALLOS, Christian, Landsknechtstr. 32, 96103 Hallstadt, DE
 TAUBMANN, Udo, Wiesengrund 19, 96476 Bad Rodach, DE

(51) MKP
C07C 21/04 2006 (97) EP 3558952
C07C 21/17 2006
C07D 265/30 2006
 (96) EP 17822275.8 12/20/2017
 (97) EP 3558952, 10/30/2019 201944, en
 (31) 201600130729 (32) 23.12.2016 (33) IT
 (54) METHOD FOR THE MANUFACTURING OF DELMOPINOL INTERMEDIATES
 (72) DE FAVERI, Carla, Via dei Colli 28, 31010 Farra di Soligo TV, IT
 STIVANELLO, Mariano, Via Marostica 20, 36015 Schio (VI), IT

(51) MKP
A47K 3/28 2006 (97) EP 3555389
E03C 1/04 2006
E04H 1/12 2006
E04H 9/02 2006
 (96) EP 17822449.9 11/24/2017
 (97) EP 3555389, 10/23/2019 201943, en
 (31) 201600127242 (32) 16.12.2016 (33) IT
 (54) ANTI SEISMIC PROTECTION DEVICE
 (71) Borri, Sabina, Via Verona 3, 00161 Roma, IT
 (72) Borri, Sabina, Via Verona 3, 00161 Roma, IT

(51) MKP
A61K 31/5365 2006 (97) EP 3555105
A61P 35/00 2006
C07D 498/04 2006
 (96) EP 17822882.1 12/8/2017
 (97) EP 3555105, 10/23/2019 201943, en
 (31) 201662435283 P (32) 16.12.2016 (33) US
 (54) 7-PHENYLETHYLAMINO-4H-PYRIMIDO[4,5-D][1,3]OXAZIN-2-ONE COMPOUNDS AS MUTANT IDH1 AND IDH2 INHIBITORS
 (72) BAUER, Renato Alejandro, c/o Eli Lilly and Company P.O. Box 6288, Indianapolis, Indiana 46206-6288, US
 BOULET, Serge Louis, c/o Eli Lilly and Company P.O. Box 6288, Indianapolis, Indiana 46206-6288, US
 BURKHOLDER, Timothy Paul, c/o Eli Lilly and Company P.O. Box 6288, Indianapolis, Indiana 46206-6288, US
 GILMOUR, Raymond, c/o Eli Lilly and Company P.O. Box 6288, Indianapolis, Indiana 46206-6288, US

HAHN, Patric James, c/o Eli Lilly and Company P.O. Box 6288, Indianapolis, Indiana 46206-6288, US
 RANKOVIC, Zoran, c/o Eli Lilly and Company P.O. Box 6288, Indianapolis, Indiana 46206-6288, US

(51) MKP
A61K 31/5355 2006 (97) EP 3555080
A61K 31/5377 2006
A61P 25/28 2006
C07D 265/08 2006
C07D 265/12 2006
C07D 265/30 2006
C07D 413/10 2006

(96) EP 17822984.5 12/13/2017

(97) EP 3555080, 10/23/2019 201943, en

(31) 201662434711 P (32) 15.12.2016 (33) US
 201762570425 P 10.10.2017 US

(54) OXAZINE DERIVATIVES AS BETA-SECRETASE INHIBITORS AND METHODS OF USE

(72) ALLEN, Jennifer R., 4404 Via Juanita, Newbury Park, California 91320, US
 BOURBEAU, Matthew P., 23510 Aetna Street, Woodland Hills, California 91367, US
 CHEN, Ning, 2342 Gillingham Circle, Thousand Oaks, California 91362, US
 FROHN, Michael J., 2808 Cedar Wood Place, Thousand Oaks, California 91362, US
 HARRINGTON, Paul E., 2330 Gillingham Circle, Thousand Oaks, California 91362, US
 LIU, Qingyian, 4631 Paseo Girasol, Camarillo, California 93012, US
 REEVES, Corey, 14948 Dickens Street, Apt. 5, Sherman Oaks, California 91403, US

(51) MKP
A61K 31/541 2006 (97) EP 3555084
A61P 25/00 2006
A61P 25/28 2006
C07D 417/10 2006

(96) EP 17822985.2 12/13/2017

(97) EP 3555084, 10/23/2019 201943, en

(31) 201662434714 P (32) 15.12.2016 (33) US

(54) THIAZINE DERIVATIVES AS BETA-SECRETASE INHIBITORS AND METHODS OF USE

(72) BOURBEAU, Matthew P., 23510 Aetna Street, Woodland Hills, California 91367, US
 HARRINGTON, Paul E., 2330 Gillingham Circle, Thousand Oaks, California 91362, US
 LIU, Qingyian, 4631 Paseo Girasol, Camarillo, California 93012, US

(51) MKP
A61K 31/5365 2006 (97) EP 3555106
A61K 31/542 2006
A61P 25/00 2006
A61P 25/28 2006
C07D 498/04 2006
C07D 513/04 2006

(96) EP 17822986.0 12/13/2017

(97) EP 3555106, 10/23/2019 201943, en

(31) 201662434719 P (32) 15.12.2016 (33) US
 201762570429 P 10.10.2017 US

(54) BICYCLIC THIAZINE AND OXAZINE DERIVATIVES AS BETA-SECRETASE INHIBITORS AND METHODS OF USE

(72) ALLEN, Jennifer R., 4404 Via Juanita, Newbury Park, California 91320, US
 BOURBEAU, Matthew P., 23510 Aetna Street, Woodland Hills, California 91367, US
 CHEN, Ning, 2342 Gillingham Circle, Thousand Oaks, California 91362, US
 LIU, Qingyian, 4631 Paseo Girasol, Camarillo, California 93012, US
 PETTUS, Liping H., 301 Virgo Court, Thousand Oaks, California 91360, US
 SIEGMUND, Aaron C., 5665 Pembroke Street, Ventura, California 93003, US

(51) MKP
A61K 31/5415 2006 (97) EP 3555085
A61P 25/28 2006
C07D 279/08 2006
C07D 417/10 2006
C07D 417/14 2006

(96) EP 17822987.8 12/13/2017

- (97) EP 3555085, 10/23/2019 201943, en
 (31) 201662434721 P (32) 15.12.2016 (33) US
 (54) CYCLOPROPYL FUSED THIAZINE DERIVATIVES AS BETA-SECRETASE INHIBITORS AND METHODS OF USE
 (72) ALLEN, Jennifer R., 4404 Via Juanita, Newbury Park, California 91320, US
 AMEGADZIE, Albert, 15242 Campus Park Drive Apt. B, Moorpark, California 93021, US
 BOURBEAU, Matthew P., 23510 Aetna Street, Woodland Hills, California 91367, US
 CHEN, Jian J., 5448 Castillo De Rosas, Camarillo, California 93012, US
 FROHN, Michael J., 2808 Cedar Wood Place, Thousand Oaks, California 91362, US
 HARRINGTON, Paul E., 2330 Gillingham Circle, Thousand Oaks, California 91362, US
 LOW, Jonathan D., 19355 Sherman Way 39, Reseda, California 91335, US
 MA, Vu V., 356 Countryside Road, Oak Park, California 91377, US
 NGUYEN, Thomas T., 468 Calle Veracruz, Newbury Park, California 91320, US
 PICKRELL, Alexander J., 4435 Regents Court, Westlake Village, California 91361, US
 REEVES, Corey, 14948 Dickens Street, Apt. 5, Sherman Oaks, California 91403, US
-

- (51) MKP
A61K 31/54 2006 (97) EP 3555086
A61P 25/28 2006
C07D 417/10 2006
C07D 417/14 2006
C07D 471/04 2006
C07D 491/056 2006
C07D 498/08 2006
C07D 513/04 2006
 (96) EP 17822989.4 12/13/2017
 (97) EP 3555086, 10/23/2019 201943, en
 (31) 201662434715 P (32) 15.12.2016 (33) US
 (54) 1,4-THIAZINE DIOXIDE AND 1,2,4-THIADIAZINE DIOXIDE DERIVATIVES AS BETA-SECRETASE INHIBITORS AND METHODS OF USE
 (72) ALLEN, Jennifer R., 4404 Via Juanita, Newbury Park, California 91320, US
 BOURBEAU, Matthew P., 23510 Aetna Street, Woodland Hills, California 91367, US
 BROWN, James A., 4438 Appleglen Court, Moorpark, California 93021, US
 CHEN, Ning, 2342 Gillingham Circle, Thousand Oaks, California 91362, US
 FROHN, Michael J., 2808 Cedar Wood Place, Thousand Oaks, California 91362, US
 FU, Zice, 788 Santa Maria Lane, Foster City, California 94404, US
 LIU, Longbin, 753 Rushing Creek Place, Thousand Oaks, California 91360, US
 LIU, Qingyian, 4631 Paseo Girasol, Camarillo, California 93012, US
 PETTUS, Liping H., 301 Virgo Court, Thousand Oaks, California 91360, US
 QIAN, Wenyuan, 4231 Via Azul, Thousand Oaks, California 91320, US
 REEVES, Corey, 14948 Dickens Street, Apt. 5, Sherman Oaks, California 91403, US
 SIEGMUND, Aaron C., 5665 Pembroke Street, Ventura, California 93003, US
-

- (51) MKP
A61K 31/4184 2006 (97) EP 3555066
A61P 11/06 2006
A61P 35/00 2006
C07D 235/08 2006
C07D 401/12 2006
C07D 401/14 2006
C07D 403/04 2006
 (96) EP 17822994.4 12/14/2017
 (97) EP 3555066, 10/23/2019 201943, en
 (31) 201662434839 P (32) 15.12.2016 (33) US
 (54) BENZIMIDAZOLE COMPOUNDS AS C-KIT INHIBITORS
 (72) BENCIVENGA, Nicholas, E., c/o Ariad Pharmaceuticals Inc. 40 Landsdowne Street, Cambridge, MA 02139, US
 DALGARNO, David, C., c/o Ariad Pharmaceuticals Inc. 40 Landsdowne Street, Cambridge, MA 02139, US
 GOZGIT, Joseph, M., c/o Ariad Pharmaceuticals Inc. 40 Landsdowne Street, Cambridge, MA 02139, US
 HUANG, Wei-sheng, c/o Ariad Pharmaceuticals Inc. 40 Landsdowne Street, Cambridge, MA 02139, US
 KOHLMANN, Anna, c/o Ariad Pharmaceuticals Inc. 40 Landsdowne Street, Cambridge, MA 02139, US
 LI, Feng, c/o Ariad Pharmaceuticals Inc. 40 Landsdowne Street, Cambridge, MA 02139, US
 QI, Jiwei, c/o Ariad Pharmaceuticals Inc. 40 Landsdowne Street, Cambridge, MA 02139, US
 SHAKESPEARE, William, C., c/o Ariad Pharmaceuticals Inc. 40 Landsdowne Street, Cambridge, MA 02139, US
 THOMAS, Ranny, M., c/o Ariad Pharmaceuticals Inc. 40 Landsdowne Street, Cambridge, MA 02139, US
 WANG, Yihan, c/o Ariad Pharmaceuticals Inc. 40 Landsdowne Street, Cambridge, MA 02139, US
 ZHANG, Yun, c/o Ariad Pharmaceuticals Inc. 40 Landsdowne Street, Cambridge, MA 02139, US
 ZHU, Xiaotian, c/o Ariad Pharmaceuticals Inc. 40 Landsdowne Street, Cambridge, MA 02139, US

(51) MKP
F24F 3/00 2006 (97) EP 3563094
F24F 3/14 2006
F24F 3/16 2006
F24F 5/00 2006
F24F 6/00 2006
F28C 3/06 2006
(96) EP 17823094.2 12/19/2017
(97) EP 3563094, 11/6/2019 201945, fr
(31) 1663416 (32) 27.12.2016 (33) FR
(54) FACILITY FOR PRODUCING AND TREATING A GAS STREAM THROUGH A VOLUME OF LIQUID
(71) Starklab, 28 rue Henri Derain, 59310 Nomain, FR
(72) ZEMMOURI, M. Jaouad, 28 Rue Henri Derain, 59310 Nomain, FR

(51) MKP
A61K 39/12 2006 (97) EP 3554536
A61K 39/155 2006
A61K 39/245 2006
A61K 39/295 2006
C07K 14/03 2006
C07K 14/08 2006
C12N 7/00 2006
(96) EP 17823319.3 12/13/2017
(97) EP 3554536, 10/23/2019 201943, en
(31) 201662433842 P (32) 14.12.2016 (33) US
(54) RECOMBINANT HVT VECTORS EXPRESSING MULTIPLE ANTIGENS OF AVIAN PATHOGENS, AND VACCINES COMPRISING THEM
(71) Boehringer Ingelheim Animal Health USA Inc., 3239 Satellite Blvd, Duluth, GA 30096, US
(72) BUBLOT, Michael, 3 rue Favre Garin, 69630 Chaponost, FR
MEBATSION, Teshome, 2670 Bent Tree Lane, Watkinsville, GA 30677, US
PRITCHARD, Joyce, 3804 Princeton Court, Gainesville, GA 30504, US
LINZ, Perry, 2286 Cotton Gin Row, Jefferson, GA 30549, US
KASSA, Aemro, 4390 Meadow Springs Drive, Watkinsville, GA 30677, US

(51) MKP
A61K 39/395 2006 (97) EP 3555129
C07K 16/22 2006
(96) EP 17825499.1 12/19/2017
(97) EP 3555129, 10/23/2019 201943, en
(31) 201621635 (32) 19.12.2016 (33) GB
(54) GREMLIN-1 CRYSTAL STRUCTURE AND INHIBITORY ANTIBODY
(72) DEDI, Neesha, c/o IPD UCB Celltech 208 Bath Road, Slough Berkshire SL1 3WE, GB
TWOMEY, Breda, c/o IPD UCB Celltech 208 Bath Road, Slough Berkshire SL1 3WE, GB
WRIGHT, Michael John, c/o IPD UCB Celltech 208 Bath Road, Slough Berkshire SL1 3WE, GB
DAVIES, Gareth, c/o IPD UCB Celltech 208 Bath Road, Slough Berkshire SL1 3WE, GB
MCMILLAN, David James, c/o IP Department UCB Celltech 208 Bath Road, Slough Berkshire SL1 3WE, GB

(51) MKP
B29C 45/17 2006 (97) EP 3558622
(96) EP 17825627.7 12/19/2017
(97) EP 3558622, 10/30/2019 201944, en
(31) 201600129409 (32) 21.12.2016 (33) IT
(54) METHOD FOR THE INJECTION MOLDING OF INTERNALLY HOLLOW PARTS
(71) Sapa S.P.A., Via Vittoria Colonna 14, 80121 Napoli, IT
(72) AFFINITA, Antonio, c/o SAPA S.R.L. Via Vittoria Colonna 14, 80121 Napoli (NA), IT

(51) MKP
C07K 14/725 2006 (97) EP 3551653
C12N 15/09 2006
(96) EP 17825761.4 12/6/2017
(97) EP 3551653, 10/16/2019 201942, en

(31) 102016123893 (32) 08.12.2016 (33) DE
 201662497895 P 08.12.2016 US

(54) T CELL RECEPTORS WITH IMPROVED PAIRING
 (72) BUNK, Sebastian, Gertrud-Baeumer-Str. 19/1, 72074 Tübingen, DE
 MAURER, Dominik, Fleinerweg 7, 72116 Moessingen, DE
 FRITSCH, Jens, Lärchenweg 11, 72144 Dusslingen, DE
 WAGNER, Claudia, Nürtinger Strasse 32, 72074 Tübingen, DE
 ALTEN, Leonie, Weißdornweg 14 App. 161, 72076 Tübingen, DE
 HOFFGAARD, Franziska, Schwärzlocher Strasse 64, 72070 Tübingen, DE
 FERBER, Mathias, 1 Rue de Paradis, 75010 Paris, FR

(51) MKP
C07K 14/725 2006 (97) EP 3551654
C07K 16/30 2006

(96) EP 17825768.9 12/7/2017
 (97) EP 3551654, 10/16/2019 201942, en

(31) 102016123859 (32) 08.12.2016 (33) DE
 201662431580 P 08.12.2016 US

(54) NOVEL T CELL RECEPTORS AND IMMUNE THERAPY USING THE SAME
 (72) ALTEN, Leonie, Weißdornweg 14 App. 161, 72076 Tübingen, DE
 BUNK, Sebastian, Gertrud-Baeumer-Str. 19/1, 72074 Tübingen, DE
 MAURER, Dominik, Fleinerweg 7, 72116 Moessingen, DE
 WAGNER, Claudia, Nürtinger Strasse 32, 72074 Tübingen, DE

(51) MKP
A61K 31/437 2006 (97) EP 3555094
A61P 25/00 2006
C07D 471/04 2006
C07D 493/04 2006

(96) EP 17825805.9 12/15/2017
 (97) EP 3555094, 10/23/2019 201943, en

(31) 16204834 (32) 16.12.2016 (33) EP

(54) BICYCLIC OGA INHIBITOR COMPOUNDS
 (72) BARTOLOMÉ-NEBREDA, José, Manuel, c/o: Janssen-Cilag S.A. Edificio Johnson&Johnson Paseo de las Doce Estrellas 5-7 5° Planta Campo de las Naciones, 28042 Madrid, ES
 TRABANCO-SUÁREZ, Andrés, Avelino, c/o: Janssen-Cilag S.A. Edificio Johnson&Johnson Paseo de las Doce Estrellas 5-7 5° Planta Campo de las Naciones, 28042 Madrid, ES
 MARTINEZ VITURRO, Carlos, Manuel, c/o: Janssen-Cilag S.A. Edificio Johnson&Johnson Paseo de las Doce Estrellas 5-7 5° Planta Campo de las Naciones, 28042 Madrid, ES
 TRESADERN, Gary, John, c/o: Janssen-Cilag S.A. Edificio Johnson&Johnson Paseo de las Doce Estrellas 5-7 5° Planta Campo de las Naciones, 28042 Madrid, ES
 ALCÁZAR-VACA, Manuel, Jesús, c/o: Janssen-Cilag S.A. Edificio Johnson&Johnson Paseo de las Doce Estrellas 5-7 5° Planta Campo de las Naciones, 28042 Madrid, ES

(51) MKP
A61K 31/522 2006 (97) EP 3558997
A61P 35/00 2006
C07D 473/18 2006
C07D 519/00 2006

(96) EP 17825829.9 12/19/2017
 (97) EP 3558997, 10/30/2019 201944, en

(31) 201662436619 P (32) 20.12.2016 (33) US

(54) AMINO-TRIAZOLOPYRIDINE COMPOUNDS AND THEIR USE IN TREATING CANCER
 (72) FINLAY, Maurice, Raymond, Verschoyle, AstraZeneca R&D Cambridge Darwin Building Cambridge Science Park Milton Road, Cambridge Cambridgeshire CB4 0FZ, GB
 GOLDBERG, Frederick, Woolf, AstraZeneca R&D Cambridge Darwin Building Cambridge Science Park Milton Road, Cambridge Cambridgeshire CB4 0FZ, GB
 TING, Atilla, Kuan, Tsuei, AstraZeneca R&D Cambridge Darwin Building Cambridge Science Park Milton Road, Cambridge Cambridgeshire CB4 0FZ, GB

(51) MKP
C01F 11/18 2006 (97) EP 3573928
C09C 1/02 2006

(96) EP 17825837.2 12/20/2017
 (97) EP 3573928, 12/4/2019 201949, en
 (31) 17153420 (32) 26.01.2017 (33) EP
 (54) PROCESS FOR THE PREPARATION OF FRAGMENTED NATURAL CALCIUM CARBONATE WITH A REDUCED CONTENT OF IMPURITIES AND PRODUCTS OBTAINED THEREOF
 (72) TAVAKKOLI, Bahman, Zauchenweg 8, 9722 Gummern, AT
 RUHDORFER, David, Höflingerstrasse 15, 9584 Finkenstein, AT

(51) MKP
A61L 9/12 2006 (97) EP 3562519

(96) EP 17825880.2 12/28/2017
 (97) EP 3562519, 11/6/2019 201945, en
 (31) PCT/ES2016/070946 (32) 29.12.2016 (33) WO
 (54) PERFUME TESTERS
 (71) Airparfum Timeless, S.L., Avda. Castilleja De La Cuesta 210 Local, 41110 Bollullos De La Mitacion, ES
 (72) MEDINA RIVERO, Armando, Cueva de Menga 1 bloque 1 1º A, 41020 Sevilla, ES

(51) MKP
C10J 3/26 2006 (97) EP 3551733
C10J 3/30 2006
C10J 3/36 2006
C10J 3/86 2006
C10K 1/04 2006

(96) EP 17825936.2 12/7/2017
 (97) EP 3551733, 10/16/2019 201942, en
 (31) 201600124642 (32) 09.12.2016 (33) IT
 (54) SYSTEM FOR TRANSFORMING AN ORGANIC MATERIAL INTO SYNGAS
 (71) Site S.p.A. Con Socio Unico, Via del Tuscolano 15, 40128 Bologna, IT
 (72) BRANDA, Paolo, c/o Site S.p.a. Con Socio Unico Via del Tuscolano 15, 40128 Bologna, IT

(51) MKP
A61K 31/437 2006 (97) EP 3555096
A61P 35/00 2006
A61P 37/00 2006
C07D 471/14 2006

(96) EP 17826097.2 12/15/2017
 (97) EP 3555096, 10/23/2019 201943, en
 (31) 201662435639 P (32) 16.12.2016 (33) US
 201762592747 P 30.11.2017 US
 201762596636 P 08.12.2017 US
 (54) IMIDAZOPYRROLOPYRIDINE AS INHIBITORS OF THE JAK FAMILY OF KINASES
 (72) CHAI, Wenyng, 3210 Merryfield Row, San Diego, California 92121, US
 KOU德里AKOVA, Tatiana, 3210 Merryfield Row, San Diego, California 92121, US
 KRAWCZUK, Paul J., Welsh and McKean Roads, Spring House, Pennsylvania 19477, US
 KREUTTER, Kevin D., 1400 McKean Road, Spring House, Pennsylvania 19477, US
 LEONARD, Kristi, 1400 McKean Road, Spring House, Pennsylvania 19477, US
 RIZZOLIO, Michele C., 3210 Merryfield Row, San Diego, California 92121, US
 SEIERSTAD, Mark, 3210 Merryfield Row, San Diego, California 92121, US
 SMITH, Russel C., 3210 Merryfield Row, San Diego, California 92121, US
 TICHENOR, Mark S., 3210 Merryfield Row, San Diego, California 92121, US
 VENABLE, Jennifer D., 3210 Merryfield Row, San Diego, California 92121, US
 WANG, Aihua, 1400 McKean Road, Spring House, Pennsylvania 19477, US
 BACANI, Genesis M., 3210 Merryfield Row, San Diego, California 92121, US
 WANG, Aihua, 1400 McKean Road, Spring House, Pennsylvania 19477, US

(51) MKP
A61K 31/415 2006 (97) EP 3558960
A61P 29/00 2006
C07D 213/56 2006
C07D 231/12 2006
C07D 231/56 2006
C07D 233/64 2006

C07D 241/12 2006
C07D 277/56 2006
C07D 333/28 2006
C07D 333/38 2006
C07D 333/58 2006
C07D 495/04 2006

- (96) EP 17826197.0 12/18/2017
 (97) EP 3558960, 10/30/2019 201944, en
 (31) 16206750 (32) 23.12.2016 (33) EP
 (54) CARBOXYLIC ACID AROMATIC AMIDES AS ANTAGONISTS OF BRADYKININ B1 RECEPTOR
 (72) BÄURLE, Stefan, Fischzug 21H, 10245 Berlin, DE
 DAVENPORT, Adam, James, c/o Evotec (UK) Limited 114 Innovation Drive Milton Park, Abingdon Oxfordshire OX14 4RZ, GB
 STIMSON, Christopher, c/o Evotec (UK) Limited 114 Innovation Drive Milton Park, Oxfordshire OX14 4RZ, GB
 NAGEL, Jens, Gemeindegarten 9, 55442 Daxweiler, DE
 SCHMIDT, Nicole, Aprather Weg 18A, 42113 Wuppertal, DE
 ROTGERI, Andrea, Damwildsteig 21, 13503 Berlin, DE
 GRÖTICKE, Ina, Kamminer Str. 36, 10589 Berlin, DE
 RAUSCH, Alexandra, Schönhauser Str. 54C, 13158 Berlin, DE
 KLAR, Jürgen, Leipziger Straße 6, 42109 Wuppertal, DE
 DYRKS, Thomas, Spießweg 90, 13437 Berlin, DE
-

- (51) MKP
C07C 211/63 2006 (97) EP 3555325
C22B 3/26 2006
C22B 59/00 2006
 (96) EP 17826540.1 12/14/2017
 (97) EP 3555325, 10/23/2019 201943, en
 (31) 201621523 (32) 16.12.2016 (33) GB
 (54) SEPARATION OF RARE EARTH METALS
 (71) The Queen's University Of Belfast, University Road, Belfast, Antrim BT7 1NN, GB
 (72) NOCKEMANN, Peter, c/o The Queen's University of Belfast University Road, Belfast Antrim BT7 1NN, GB
 RITESH, Ruhela, c/o The Queen's University of Belfast University Road, Belfast Antrim BT7 1NN, GB
-

- (51) MKP
A61K 31/455 2006 (97) EP 3551622
A61P 11/00 2006
C07D 231/20 2006
C07D 401/04 2006
C07D 401/14 2006
 (96) EP 17826629.2 12/8/2017
 (97) EP 3551622, 10/16/2019 201942, en
 (31) 201662432537 P (32) 09.12.2016 (33) US
 (54) MODULATOR OF CYSTIC FIBROSIS TRANSMEMBRANE CONDUCTANCE REGULATOR, PHARMACEUTICAL COMPOSITIONS, METHODS
 OF TREATMENT, AND PROCESS FOR MAKING THE MODULATOR
 (72) ABELA, Alexander, Russell, 50 Northern Avenue, Boston, MA 02210, US
 ALCACIO, Timothy, 50 Northern Avenue, Boston, MA 02210, US
 ANDERSON, Corey, 50 Northern Avenue, Boston, MA 02210, US
 ANGELL, Paul, Timothy, 50 Northern Avenue, Boston, MA 02210, US
 BAEK, Minson, 50 Northern Avenue, Boston, MA 02210, US
 CLEMENS, Jeremy, J., 50 Northern Avenue, Boston, MA 02210, US
 CLEVELAND, Thomas, 50 Northern Avenue, Boston, MA 02210, US
 FERRIS, Lori, Ann, 50 Northern Avenue, Boston, MA 02210, US
 GROOTENHUIS, Peter Diederik, Jan, 50 Northern Avenue, Boston, MA 02210, US
 GROSS, Raymond, Stanley, 50 Northern Avenue, Boston, MA 02210, US
 GULEVICH, Anton, 50 Northern Avenue, Boston, MA 02210, US
 HADIDA RUAH, Sara, Sabina, 50 Northern Avenue, Boston, MA 02210, US
 HSIA, Clara, Kuang-Ju, 50 Northern Avenue, Boston, MA 02210, US
 HUGHES, Robert, M., 50 Northern Avenue, Boston, MA 02210, US
 JOSHI, Pramod, Virupax, 13023 Old West Avenue, San Diego, CA 92129, US
 KANG, Ping, 50 Northern Avenue, Boston, MA 02210, US
 KESHAVARZ-SHOKRI, Ali, 50 Northern Avenue, Boston, MA 02210, US
 KHATUYA, Haripada, 50 Northern Avenue, Boston, MA 02210, US
 KRENITSKY, Paul, John, 50 Northern Avenue, Boston, MA 02210, US
 MCCARTNEY, Jason, 50 Northern Avenue, Boston, MA 02210, US
 MILLER, Mark, Thomas, 50 Northern Avenue, Boston, MA 02210, US

PARASELLI, Prasuna, 50 Northern Avenue, Boston, MA 02210, US
 PIERRE, Fabrice Jean, Denis, 50 Northern Avenue, Boston, MA 02210, US
 SHI, Yi, 50 Northern Avenue, Boston, MA 02210, US
 SHRESTHA, Muna, 50 Northern Avenue, Boston, MA 02210, US
 SIESEL, David, Andrew, 50 Northern Avenue, Boston, MA 02210, US
 STAVROPOULOS, Kathy, 50 Northern Avenue, Boston, MA 02210, US
 TERMIN, Andreas, P., 50 Northern Avenue, Boston, MA 02210, US
 UY, Johnny, 50 Northern Avenue, Boston, MA 02210, US
 VAN GOOR, Fredrick, F., 50 Northern Avenue, Boston, MA 02210, US
 YOUNG, Tomothy, John, 50 Northern Avenue, Boston, MA 02210, US
 ZHOU, Jinglan, 50 Northern Avenue, Boston, MA 02210, US

- (51) MKP
A61K 47/64 2017 (97) EP 3554552
A61P 21/00 2006
- (96) EP 17826645.8 12/14/2017
 (97) EP 3554552, 10/23/2019 201943, en
- (31) 201662436223 P (32) 19.12.2016 (33) US
 201762443484 P 06.01.2017 US
 201762479178 P 30.03.2017 US
 201762562146 P 22.09.2017 US
- (54) EXON SKIPPING OLIGOMER CONJUGATES FOR MUSCULAR DYSTROPHY
 (72) PASSINI, Marco, A., 215 First Street Suite 415, Cambridge, MA 02142, US
 HANSON, Gunnar, J., 215 First Street Suite 415, Cambridge, MA 02142, US

- (51) MKP
C07C 201/08 2006 (97) EP 3555039
C07C 205/06 2006
- (96) EP 17828680.3 12/14/2017
 (97) EP 3555039, 10/23/2019 201943, de
- (31) 102017000973 (32) 03.02.2017 (33) DE
 102017106881 30.03.2017 DE
 102017110084 10.05.2017 DE
- (54) METHOD AND SYSTEM FOR ADIABATIC NITRIDING OF AROMATES
 (72) PÖHLMANN, Jürgen, Türnichstrasse 5, 50969 Köln, DE
 HERMANN, Dr. Heinrich, Donauweg 27, 50858 Köln, DE
 HÄNDEL, Mirko, Auf der Heide 17, 53804 Much, DE
 WERNITZ, Sophie, Aschenbrödelweg 18, 51067 Köln, DE
 FANKEL, Stefan, Herresbecherstrasse 31, 53639 Königswinter, DE

- (51) MKP
C12Q 1/68 2018 (97) EP 3555307
- (96) EP 17828700.9 12/15/2017
 (97) EP 3555307, 10/23/2019 201943, en
- (31) 16204532 (32) 15.12.2016 (33) EP
- (54) METHODS OF DETERMINING COLORECTAL CANCER STATUS IN AN INDIVIDUAL
 (71) University College Cork-National University of Ireland, Cork, College Road, Cork, IE
 (72) O'TOOLE, Paul, University College Cork APC College Road, Cork, IE
 FLEMER, Burkhardt, University College Cork APC College Road, Cork, IE
 SHANAHAN, Fergus, University College Cork APC College Road, Cork, IE
 JEFFERY, Ian, Bawnard West, Midleton Co. Cork, IE
 CISEK, Katryna, 41 Southern Road, Cork, IE

- (51) MKP
A61K 31/519 2006 (97) EP 3558999
A61P 11/00 2006
A61P 37/00 2006
C07D 487/04 2006
- (96) EP 17828752.0 12/21/2017
 (97) EP 3558999, 10/30/2019 201944, en
- (31) 16205661 (32) 21.12.2016 (33) EP
- (54) BICYCLIC DIHYDROPYRIMIDINE-CARBOXAMIDE DERIVATIVES AS RHO-KINASE INHIBITORS

(72) ACCETTA, Alessandro, c/o CHIESI FARMACEUTICI S.p.A. Via Palermo 26/A, 43122 Parma, IT
 RANCATI, Fabio, c/o CHIESI FARMACEUTICI S.p.A. Via Palermo 26/A, 43122 Parma, IT
 CAPELLI, Anna Maria, c/o CHIESI FARMACEUTICI S.p.A. Via Palermo 26/A, 43122 Parma, IT
 CLARK, David Edward, c/o CHIESI FARMACEUTICI S.p.A. Via Palermo 26/A, 43122 Parma, IT
 TISSELLI, Patrizia, c/o CHIESI FARMACEUTICI S.p.A. Via Palermo 26/A, 43122 Parma, IT
 EDWARDS, Christine, c/o CHIESI FARMACEUTICI S.p.A. Via Palermo 26/A, 43122 Parma, IT
 BHALAY, Gurdip, c/o CHIESI FARMACEUTICI S.p.A. Via Palermo 26/A, 43122 Parma, IT

(51) MKP
A23L 33/135 2016 (97) EP 3554522
A61K 9/00 2006
A61K 9/14 2006
A61K 9/20 2006
A61K 35/741 2015
A61K 35/744 2015
A61K 35/745 2015
A61K 35/747 2015
A61K 36/06 2006
A61P 1/00 2006

(96) EP 17829025.0 12/15/2017

(97) EP 3554522, 10/23/2019 201943, en

(31) 201600127498 (32) 16.12.2016 (33) IT

(54) PROBIOTICS FOR USE IN THE TREATMENT OF DIVERTICULOSIS AND DIVERTICULAR DISEASE

(72) BIFFI, Andrea, Via Mulino Vecchio 146, 24059 Urganò (Bergamo), IT

FIORÉ, Walter, Via Salita Montone 1, 84010 Atrani (Salerno), IT

ROSSI, Ruggero, Via Federico Engels 1, 20153 Milano, IT

(51) MKP
A61K 47/68 2017 (97) EP 3558389
A61P 43/00 2006
C07K 16/28 2006

(96) EP 17829033.4 12/19/2017

(97) EP 3558389, 10/30/2019 201944, en

(31) 201662437622 P (32) 21.12.2016 (33) US
 201762520854 P 16.06.2017 US

(54) ANTIBODY DRUG CONJUGATES FOR ABLATING HEMATOPOIETIC STEM CELLS

(72) WEN, Ben, c/o Novartis Institute for Functional Genomics Inc. DBA Genomics Institute of the Novartis Research Foundation 10675 John Jay Hopkins Drive, San Diego, CA 92121, US

BOITANO, Anthony E., 13037 Cavalry Court, San Diego, CA 92129, US

BURGER, Matthew, c/o Novartis Institutes for Biomedical Research Inc. 250 Massachusetts Avenue, Cambridge, MA 02139, US

CELLITTI, Susan E., c/o Novartis Institute for Functional Genomics Inc. DBA Genomics Institute of the Novartis Research Foundation 10675 John Jay Hopkins Drive, San Diego, CA 92121, US

COOKE, Michael P., 135 University Avenue 1, Brookline, MA 02445, US

FINNER, Catrin, c/o Morphosys AG Semmelweisstrasse 7, 82152 Planegg, DE

GEIERSTANGER, Bernhard Hubert, c/o Novartis Institute for Functional Genomics Inc. DBA Genomics Institute of the Novartis Research Foundation 10675 John Jay Hopkins Drive, San Diego, CA 92121, US

JIN, Yunho, c/o Novartis Institute for Functional Genomics Inc. DBA Genomics Institute of the Novartis Research Foundation 10675 John Jay Hopkins Drive, San Diego, CA 92121, US

LEE-HOEFLICH, Si Tuen, c/o Novartis Institutes for BioMedical Research Inc. 250 Massachusetts Avenue, Cambridge, MA 02139, US

PHAM, HongNgoc Thi, c/o Novartis Institute for Functional Genomics Inc. DBA Genomics Institute of the Novartis Research Foundation 10675 John Jay Hopkins Drive, San Diego, CA 92121, US

SCHLEYER, Siew Ho, 2649 Monte Vista Avenue, El Cerrito, CA 94530, US

TISSOT, Kathrin, c/o Morphosys AG Semmelweisstrasse 7, 82152 Planegg, DE

UNO, Tetsuo, c/o Novartis Institute for Functional Genomics Inc. DBA Genomics Institute of the Novartis Research Foundation 10675 John Jay Hopkins Drive, San Diego, CA 92121, US

(51) MKP
A61K 31/427 2006 (97) EP 3555090
A61P 35/00 2006
C07D 277/44 2006
C07D 417/12 2006

(96) EP 17829077.1 12/14/2017

(97) EP 3555090, 10/23/2019 201943, en

(31) 201662434845 P (32) 15.12.2016 (33) US

- (54) AMINOTHIAZOLE COMPOUNDS AS C-KIT INHIBITORS
 (72) BENCIVENGA, Nicholas, E., c/o Ariad Pharmaceuticals Inc. 40 Landsdowne Street, Cambridge, MA 02139, US
 DALGARNO, David, C., c/o Ariad Pharmaceuticals Inc. 40 Landsdowne Street, Cambridge, MA 02139, US
 GOZGIT, Joseph, M., c/o Ariad Pharmaceuticals Inc. 40 Landsdowne Street, Cambridge, MA 02139, US
 HUANG, Wei-Sheng, C/o Ariad Pharmaceuticals Inc. 40 Landsdowne Street, Cambridge, MA 02139, US
 KOHLMANN, Anna, c/o Ariad Pharmaceuticals Inc. 40 Landsdowne Street, Cambridge, MA 02139, US
 LI, Feng, c/o Ariad Pharmaceuticals Inc. 40 Landsdowne Street, Cambridge, MA 02139, US
 QI, Jiwei, c/o Ariad Pharmaceuticals Inc. 40 Landsdowne Street, Cambridge, MA 02139, US
 SHAKESPEARE, William, C., c/o Ariad Pharmaceuticals Inc. 40 Landsdowne Street, Cambridge, MA 02139, US
 THOMAS, Ranny, M., c/o Ariad Pharmaceuticals Inc. 40 Landsdowne Street, Cambridge, MA 02139, US
 WANG, Yihan, c/o Ariad Pharmaceuticals Inc. 40 Landsdowne Street, Cambridge, MA 02139, US
 ZHU, Xiaotian, c/o Ariad Pharmaceuticals Inc. 40 Landsdowne Street, Cambridge, MA 02139, US

- (51) MKP
A23L 33/175 2016 (97) EP 3554492
A23L 33/18 2016
A61K 31/198 2006
A61P 1/16 2006
 (96) EP 17829105.0 12/19/2017
 (97) EP 3554492, 10/23/2019 201943, en
 (31) 201662436073 P (32) 19.12.2016 (33) US
 201762443205 P 06.01.2017 US
 201762491773 P 28.04.2017 US
 201762545322 P 14.08.2017 US
 201762576267 P 24.10.2017 US
 (54) AMINO ACID COMPOSITIONS AND METHODS FOR THE TREATMENT OF LIVER DISEASES
 (72) HAMILL, Michael, c/o Axcella Health Inc. 840 Memorial Drive 3rd Floor, Cambridge MA 02139, US
 AFEYAN, Raffi, c/o Axcella Health Inc. 840 Memorial Drive 3rd Floor, Cambridge MA 02139, US
 LEE, Chung-Wei, c/o Axcella Health Inc. 840 Memorial Drive 3rd Floor, Cambridge MA 02139, US
 LUITHARDT, Harry, c/o Axcella Health Inc. 840 Memorial Drive 3rd Floor, Cambridge MA 02139, US
 BERRY, David, c/o Axcella Health Inc. 840 Memorial Drive 3rd Floor, Cambridge MA 02139, US

- (51) MKP
A61K 31/352 2006 (97) EP 3558982
A61P 11/00 2006
A61P 11/12 2006
C07D 407/12 2006
 (96) EP 17829313.0 12/19/2017
 (97) EP 3558982, 10/30/2019 201944, en
 (31) 201662436673 P (32) 20.12.2016 (33) US
 (54) DEUTERATED CFTR MODULATORS AND METHODS OF USE
 (72) CHAN, Vincent S., 6728 16th Ave NW, Seattle, WA 98117-5513, US
 KYM, Philip R., 1002 Gracewood Avenue, Libertyville, IL 60048, US
 SHEKHAR, Shashank, 1327 Ashley Court, Vernon Hills, IL 60061, US
 WANG, Xueqing, 1742 Larkdale Road, Northbrook, IL 60062, US

- (51) MKP
A61K 39/395 2006 (97) EP 3558361
A61K 45/00 2006
A61P 3/04 2006
 (96) EP 17829315.5 12/20/2017
 (97) EP 3558361, 10/30/2019 201944, en
 (31) 201662437097 P (32) 21.12.2016 (33) US
 (54) MYOSTATIN, ACTIVIN OR ACTIVIN RECEPTOR ANTAGONISTS FOR USE IN TREATING OBESITY AND RELATED CONDITIONS
 (72) GARITO, Tania Silvia, c/o Novartis Pharma AG Postfach, 4002 Basel, CH
 ROUBENOFF, Ronenn, c/o Novartis Pharma AG Postfach, 4002 Basel, CH
 ZAKARIA, Marjorie, c/o Novartis Institutes for BioMedical Research Inc. 250 Massachusetts Avenue, Cambridge, MA 02139, US

- (51) MKP
A61P 35/00 2006 (97) EP 3558968
A61P 37/00 2006
C07D 401/12 2006
 (96) EP 17829328.8 12/21/2017

(97) EP 3558968, 10/30/2019 201944, en
 (31) 201662437633 P (32) 21.12.2016 (33) US
 201762569028 P 06.10.2017 US
 (54) IMIDAZOPYRAZINE INHIBITORS OF BRUTON'S TYROSINE KINASE
 (72) PODOLL, Terry, 5021 Bowen Place S., Seattle Washington 98118, US
 EVARTS, Jerry, 4101 E. Garfield Street, Seattle Washington 98112, US
 KAPTEIN, Allard, Marten van Rossemsingel 51, 5301 HB Zaltbommel, NL

(51) MKP
A61K 31/444 2006 (97) EP 3551617
A61P 25/06 2006
C07D 401/06 2006
 (96) EP 17829372.6 12/5/2017
 (97) EP 3551617, 10/16/2019 201942, en
 (31) 201662430662 P (32) 06.12.2016 (33) US
 (54) COMPOSITIONS AND METHODS RELATED TO PYRIDINOYLPIPERIDINE 5-HT1F AGONISTS
 (71) CoLucid Pharmaceuticals, Inc., c/o Eli Lilly and Company Lilly Corporate Center, Indianapolis, IN 46285, US
 (72) ALLIERI, Brigida, c/o Eli Lilly and Company Lilly Corporate Center, Indianapolis, IN 46285, US
 FAGAN, Paul, c/o Eli Lilly and Company Lilly Corporate Center, Indianapolis, IN 46285, US
 SHARP, Emma, c/o Johnson Matthey Plc 250 Cambridge Science Park Milton Road, Cambridge Cambridgeshire CB4 0WE, GB
 SKWIERCZYNSKI, Raymond, D., c/o Eli Lilly and Company Lilly Corporate Center, Indianapolis, IN 46285, US

(51) MKP
B32B 5/02 2006 (97) EP 3554822
B32B 5/20 2006
B32B 5/26 2006
B32B 13/02 2006
B32B 13/04 2006
B32B 13/08 2006
B32B 13/14 2006
B32B 27/28 2006
B32B 27/30 2006
B32B 29/00 2006
B32B 29/02 2006
C04B 2/02 2006
C04B 2/04 2006
C04B 28/14 2006
E04C 2/04 2006
 (96) EP 17829420.3 12/15/2017
 (97) EP 3554822, 10/23/2019 201943, en
 (31) 201662434984 P (32) 15.12.2016 (33) US
 (54) PLASTER BOARDS AND METHODS FOR MAKING THEM
 (72) SHI, Zhiqiang, 7 Argila Lane, Shrewsbury, MA 01545, US
 GLEAN, Aldo, 1620 Worcester Road, Framingham, MA 01702, US

(51) MKP
A61K 31/519 2006 (97) EP 3555070
A61P 35/00 2006
C07D 403/12 2006
C07D 403/14 2006
C07D 413/12 2006
C07D 471/04 2006
C07D 487/04 2006
C07D 491/04 2006
C07D 491/14 2006
C07D 498/04 2006
 (96) EP 17829454.2 12/19/2017
 (97) EP 3555070, 10/23/2019 201943, en
 (31) 201662436139 P (32) 19.12.2016 (33) US
 201762517840 P 09.06.2017 US
 (54) AMINE-SUBSTITUTED HETEROCYCLIC COMPOUNDS AS EHMT2 INHIBITORS AND METHODS OF USE THEREOF
 (72) CAMPBELL, John Emmerson, 581 Mt. Auburn Street Unit 1, Cambridge Massachusetts 02138, US
 DUNCAN, Kenneth William, 132 Roosevelt Avenue, Norwood Massachusetts 02062, US

(51) MKP
A61K 31/675 2006 (97) EP 3559011
A61P 31/18 2006
C07F 9/6561 2006

(96) EP 17829499.7 12/20/2017
(97) EP 3559011, 10/30/2019 201944, en

(31) 201662437753 P (32) 22.12.2016 (33) US
201762574493 P 19.10.2017 US

(54) ANTIVIRAL ALIPHATIC ESTER PRODRUGS OF TENOFOVIR
(71) Idenix Pharmaceuticals LLC, 320 Bent Street, Floor 4, Cambridge, MA 02141, US
(72) RAHEEM, Izzat, 770 Sumneytown Pike, West Point, Pennsylvania 19486, US
PAPARIN, Jean-Laurent, 3 rue des Pins, 34230 Vendemian, FR
RAHALI, Houcine, 17 impasse du Cabanon, 30126 Saint Laurent des Arbres, FR
DA COSTA, Daniel, 299 rue du Pic Saint Loup, 34570 Montarnaud, FR
DUKHAN, David, 10, rue Levat, 34000 Montpellier, FR

(51) MKP
A61K 31/437 2006 (97) EP 3558989
A61P 37/00 2006
C07D 471/04 2006

(96) EP 17829552.3 12/21/2017
(97) EP 3558989, 10/30/2019 201944, en

(31) 201662438001 P (32) 22.12.2016 (33) US
201762487341 P 19.04.2017 US

(54) TRIAZOLO[1,5-A]PYRIDINE DERIVATIVES AS IMMUNOMODULATORS
(72) WU, Liangxing, Incyte Corporation 1801 Augustine Cut-Off, Wilmington, Delaware 19803, US
SHEN, Bo, Incyte Corporation 1801 Augustine Cut-Off, Wilmington, Delaware 19803, US
XU, Meizhong, Incyte Corporation 1801 Augustine Cut-Off, Wilmington, Delaware 19803, US
YAO, Wenqing, Incyte Corporation 1801 Augustine Cut-Off, Wilmington, Delaware 19803, US

(51) MKP
A61K 31/69 2006 (97) EP 3559009
A61P 35/00 2006
C07F 5/02 2006

(96) EP 17829574.7 12/22/2017
(97) EP 3559009, 10/30/2019 201944, en

(31) 201662438092 P (32) 22.12.2016 (33) US
201662439614 P 28.12.2016 US

(54) COMPOSITIONS AND METHODS FOR INHIBITING ARGINASE ACTIVITY
(72) SJOGREN, Eric, B., 442 Dell Avenue, Mountain View California 94043, US
LI, Jim, 56 Otsego Avenue, San Francisco California 94112, US
CHEN, Lijing, Apt. 3211 19500 Pruneridge Avenue, Cupertino California 95014, US
BILLEDEAU, Roland, J., 3491 Butcher Drive, Santa Clara California 95051, US
STANTON, Timothy, F., 1528 Linda Mar BLVD, Pacifica, CA 94044-4329, US
VAN ZANDT, Michael, 91 Golden Hill Drive, Guilford Connecticut 06437, US
WHITEHOUSE, Darren, 40 Fishing Brook Road, Westbrook Connecticut 06498, US
JAGDMANN, Gunnar, E., Jr., 6C Pineview Drive, Branford Connecticut 06405, US
PETERSEN, Lene, Raunkjær, Anyvej 13, 3500 Værløse, DK
PARLATI, Francesco, 1035 York Street, San Francisco California 94110, US
GROSS, Matthew, I., 934 Springfield Drive, Walnut Creek California 94598, US

(51) MKP
A61K 39/00 2006 (97) EP 3551221
C07K 14/47 2006
C07K 14/725 2006

(96) EP 17829609.1 12/7/2017
(97) EP 3551221, 10/16/2019 201942, en

(31) 102016123847 (32) 08.12.2016 (33) DE
201662431588 P 08.12.2016 US

(54) NOVEL T CELL RECEPTORS AND IMMUNE THERAPY USING THE SAME
(72) ALTEN, Leonie, Weißdornweg 14 App. 161, 72076 Tübingen, DE
BUNK, Sebastian, Gertrud-Baeumer-Str. 19/1, 72074 Tübingen, DE

MAURER, Dominik, Fleinerweg 7, 72116 Moessingen, DE
 WAGNER, Claudia, Nürtinger Strasse 32, 72074 Tübingen, DE

- (51) MKP
A61K 31/407 2006 (97) EP 3559003
A61K 31/519 2006
A61P 17/06 2006
A61P 17/14 2006
C07D 487/10 2006
- (96) EP 17829724.8 12/20/2017
 (97) EP 3559003, 10/30/2019 201944, en
 (31) 201662437262 P (32) 21.12.2016 (33) US
- (54) CRYSTALLINE FORMS OF A JANUS KINASE INHIBITOR
 (72) KAMIYA, Yukihiko, c/o Central Pharmaceutical Research Institute of Japan Tobacco Inc. 1-1 Murasaki-cho, Takatsuki-shi Osaka 569-1125, JP
 SHIMOYAMA, Noriaki, c/o Central Pharmaceutical Research Institute of Japan Tobacco Inc. 1-1 Murasaki-cho, Takatsuki-shi Osaka 569-1125, JP
 OKURA, Ryuhei, c/o Central Pharmaceutical Research Institute of Japan Tobacco Inc. 1-1 Murasaki-cho, Takatsuki-shi Osaka 569-1125, JP
 NOJI, Satoru, c/o Central Pharmaceutical Research Institute of Japan Tobacco Inc. 1-1 Murasaki-cho, Takatsuki-shi Osaka 569-1125, JP

- (51) MKP
A61K 39/00 2006 (97) EP 3551662
A61P 35/00 2006
C07K 16/28 2006
- (96) EP 17829762.8 12/4/2017
 (97) EP 3551662, 10/16/2019 201942, en
 (31) 201662431480 P (32) 08.12.2016 (33) US
- (54) ANTI-TIM-3 ANTIBODIES FOR COMBINATION WITH ANTI-PD-1 ANTIBODIES
 (71) Innovent Biologics (Suzhou) Co., Ltd., 168 Dongping Street Suzhou Industrial Park, Suzhou, Jiangsu 215123, CN
 (72) LI, Yiwon, c/o Eli Lilly And Company P.O. Box 6288, Indianapolis, Indiana 46206-6288, US
 ZHANG, Yi, c/o Eli Lilly And Company P.O. Box 6288, Indianapolis, Indiana 46206-6288, US

- (51) MKP
A61K 31/4375 2006 (97) EP 3558963
A61K 31/519 2006
A61P 37/00 2006
C07D 401/04 2006
C07D 519/00 2006
- (96) EP 17829877.4 12/21/2017
 (97) EP 3558963, 10/30/2019 201944, en
 (31) 201662438038 P (32) 22.12.2016 (33) US
 201762487362 P 19.04.2017 US
 201762551011 P 28.08.2017 US
- (54) BICYCLIC HETEROAROMATIC COMPOUNDS AS IMMUNOMODULATORS
 (72) QI, Chao, Incyte Corporation 1801 Augustine Cut-Off, Wilmington Delaware 19803, US
 KONKOL, Leah C., Incyte Corporation 1801 Augustine Cut-Off, Wilmington Delaware 19803, US
 WU, Liangxing, Incyte Corporation 1801 Augustine Cut-Off, Wilmington Delaware 19803, US
 LAJKIEWICZ, Neil, Incyte Corporation 1801 Augustine Cut-Off, Wilmington Delaware 19803, US
 HE, Chunhong, Incyte Corporation 1801 Augustine Cut-Off, Wilmington Delaware 19803, US
 XIAO, Kaijiong, Incyte Corporation 1801 Augustine Cut-Off, Wilmington Delaware 19803, US
 ZHU, Wenyu, Incyte Corporation 1801 Augustine Cut-Off, Wilmington Delaware 19803, US
 LI, Zhenwu, Incyte Corporation 1801 Augustine Cut-Off, Wilmington Delaware 19803, US
 MEI, Song, Incyte Corporation 1801 Augustine Cut-Off, Wilmington Delaware 19803, US
 YAO, Wenqing, Incyte Corporation 1801 Augustine Cut-Off, Wilmington Delaware 19803, US

- (51) MKP
A61K 31/4035 2006 (97) EP 3558981
A61K 31/4155 2006
A61K 31/4709 2006
A61P 35/00 2006
C07D 405/06 2006
C07D 405/14 2006
C07D 409/14 2006
C07D 413/14 2006
C07D 417/14 2006

C07D 451/02 2006
 (96) EP 17832250.9 12/21/2017
 (97) EP 3558981, 10/30/2019 201944, en
 (31) 20166024 (32) 22.12.2016 (33) FI
 (54) PYRAN DERIVATIVES AS CYP11A1 (CYTOCHROME P450 MONOOXYGENASE 11A1) INHIBITORS
 (72) DIN BELLE, David, Louhentie 13 A 5, FI-02130 Espoo, FI
 MÄKELÄ, Mikko, Hirsikalliontie 7 A 1, FI-02710 Espoo, FI
 PASSINIEMI, Mikko, Poutuntie 3 A 4, FI-00400 Helsinki, FI
 PIETIKÄINEN, Pekka, Aallonkohina 6 E 51, FI-02320 Espoo, FI
 RUMMAKKO, Petteri, Haagankaari 12, FI-02580 Siuntio, FI
 TIAINEN, Eija, Ruutikatu 3 A 17, FI-02650 Espoo, FI
 VAISMAA, Matti, Alberganesplanadi 2 A 10, FI-02600 Espoo, FI
 WOHLFAHRT, Gerd, Vattuniemenkatu 14 C 35, FI-00210 Helsinki, FI

(51) MKP
A61K 31/70 2006 (97) EP 3558459
A61K 36/45 2006
A61K 36/63 2006
A61P 13/10 2006
A61P 31/04 2006
 (96) EP 17832350.7 12/21/2017
 (97) EP 3558459, 10/30/2019 201944, en
 (31) 201600130012 (32) 22.12.2016 (33) IT
 (54) COMPOSITION FOR USE IN THE TREATMENT OF DISORDERS OF THE UROGENITAL APPARATUS
 (72) DI MAIO, Umberto, Via Ripa di Cassano 12, 80063 Piano Di Sorrento (NA), IT
 BAGNULO, Antonino, c/o Neilos S.r.l. Via Bagnulo 95, 80063 Piano Di Sorrento (NA), IT

(51) MKP
A61K 47/64 2017 (97) EP 3554553
A61P 21/00 2006
 (96) EP 17832401.8 12/13/2017
 (97) EP 3554553, 10/23/2019 201943, en
 (31) 201662436182 P (32) 19.12.2016 (33) US
 201762443476 P 06.01.2017 US
 201762479173 P 30.03.2017 US
 201762562080 P 22.09.2017 US
 (54) EXON SKIPPING OLIGOMER CONJUGATES FOR MUSCULAR DYSTROPHY
 (72) PASSINI, Marco A., 215 First Street Suite 415, Cambridge, MA 02142, US
 HANSON, Gunnar J., 215 First Street Suite 415, Cambridge, MA 02142, US

(51) MKP
A61K 47/64 2017 (97) EP 3554554
A61P 21/00 2006
 (96) EP 17832405.9 12/14/2017
 (97) EP 3554554, 10/23/2019 201943, en
 (31) 201662436199 P (32) 19.12.2016 (33) US
 201762443481 P 06.01.2017 US
 201762479177 P 30.03.2017 US
 201762562119 P 22.09.2017 US
 (54) EXON SKIPPING OLIGOMER CONJUGATES FOR MUSCULAR DYSTROPHY
 (72) PASSINI, Marco A., 215 First Street Suite 415, Cambridge, MA 02142, US
 HANSON, Gunnar, J., 215 First Street Suite 415, Cambridge, MA 02142, US

(51) MKP
A61K 31/713 2006 (97) EP 3555292
C07H 21/02 2006
C12N 15/113 2010
 (96) EP 17832412.5 12/15/2017
 (97) EP 3555292, 10/23/2019 201943, en
 (31) 201662435127 P (32) 16.12.2016 (33) US
 (54) METHODS FOR TREATING OR PREVENTING TTR-ASSOCIATED DISEASES USING TRANSTHYRETIN (TTR) IRNA COMPOSITIONS
 (72) VEST, John, 300 Third Street 3rd Floor, Cambridge, MA 02142, US
 ROBBIE, Gabriel, 300 Third Street 3rd Floor, Cambridge, MA 02142, US

ATTARWALA, Husain, Z., 300 Third Street 3rd Floor, Cambridge, MA 02142, US
 GOEL, Varun, 300 Third Street 3rd Floor, Cambridge, MA 02142, US
 CHAN, Amy, 300 Third Street 3rd Floor, Cambridge, MA 02142, US

(51) MKP
A61K 9/00 2006 (97) EP 3558363
A61K 9/08 2006
A61K 39/395 2006
C07K 16/24 2006

(96) EP 17832444.8 12/20/2017

(97) EP 3558363, 10/30/2019 201944, en

(31) 201662437640 P (32) 21.12.2016 (33) US

(54) ANTI-TNF ALPHA ANTIBODY FORMULATIONS

(72) CALLAHAN, William J., 1104 Woodridge Avenue, Thousand Oaks, California 91362, US

KAUSHIK, Rahul Rajan, 786 Via Donte, Newbury Park, California 91320, US

BRENNAN, Joy, 467 Erbes Road, Thousand Oaks, California 91362, US

(51) MKP
A61K 31/13 2006 (97) EP 3551178
A61K 31/16 2006
A61K 31/20 2006
A61K 31/345 2006
A61P 35/00 2006

(96) EP 17832609.6 12/8/2017

(97) EP 3551178, 10/16/2019 201942, en

(31) 201662431893 P (32) 09.12.2016 (33) US

201762461381 P 21.02.2017 US

(54) MARKERS FOR PERSONALIZED CANCER TREATMENT WITH LSD1 INHIBITORS

(72) MCGRATH, John, 31 Indian Ridge Road, Natick, MA 01760, US

TROJER, Patrick, 57 Longwood Road, Reading, MA 01867, US

(51) MKP
C07K 14/71 2006 (97) EP 3562840

(96) EP 17832636.9 12/15/2017

(97) EP 3562840, 11/6/2019 201945, en

(31) 201662435493 P (32) 16.12.2016 (33) US

(54) STABILIZED PROTEOLYTICALLY ACTIVATED GROWTH DIFFERENTIATION FACTOR 11

(72) PEPINSKY, R. Blake, 30 Falmouth Road, Arlington, Massachusetts 02474, US

LEHMANN, Andreas, 35 Gilbert Road 2, Belmont, Massachusetts 02478, US

WEN, Dingyi, 255 Lincoln Street, Waltham, Massachusetts 02451, US

(51) MKP
A61K 31/428 2006 (97) EP 3558955
A61K 31/429 2006
A61K 31/437 2006
A61K 31/498 2006
A61K 31/4985 2006
A61K 31/517 2006
A61K 31/519 2006
A61P 35/00 2006
C07D 239/80 2006
C07D 275/04 2006
C07D 401/04 2006
C07D 403/04 2006
C07D 417/04 2006
C07D 471/04 2006
C07D 471/08 2006
C07D 487/04 2006
C07D 487/10 2006
C07D 513/04 2006

(96) EP 17832646.8 12/21/2017

(97) EP 3558955, 10/30/2019 201944, en

(31)	201662438334 P	(32)	22.12.2016	(33)	US
(54)	BENZISOTHIAZOLE, ISOTHIAZOLO[3,4-B]PYRIDINE, QUINAZOLINE, PHTHALAZINE, PYRIDO[2,3-D]PYRIDAZINE AND PYRIDO[2,3-D]PYRIMIDINE DERIVATIVES AS KRAS G12C INHIBITORS FOR TREATING LUNG, PANCREATIC OR COLORECTAL CANCER				
(72)	LANMAN, Brian Alan, 6000 De Soto Avenue 305, Woodland Hills, California 91367, US CEE, Victor J., 2881 Capella Way, Thousand Oaks, California 91362, US PICKRELL, Alexander J., 4435 Regents Court, Westlake Village, California 91361, US REED, Anthony B., 3031 Charlotte Street, Newbury Park, California 91320, US YANG, Kevin C., 8871 Camino Real Avenue, San Gabriel, California 91775, US KOPECKY, David John, 1300 N. Street NW Apt.415, Washington, District of Columbia 20005, US WANG, Hui-Ling, 822 Lynnmere Drive, Thousand Oaks, California 91360, US LOPEZ, Patricia, 5614 Le Sage Avenue, Woodland Hills, California 91367, US ASHTON, Kate, 4435 Regents Court, Westlake Village, California 91361, US BOOKER, Shon, 15243 Camarillo Street, Sherman Oaks, California 91403, US TEGLEY, Christopher M., 804 87th Street, Daly City California 94015, US				

(51) MKP
A61K 31/352 2006 (97) EP 3562816
A61K 31/47 2006
C07D 217/04 2006
C07D 217/08 2006
C07D 223/16 2006
C07D 311/76 2006
C07D 498/14 2006

(96) EP 17832681.5 12/27/2017
(97) EP 3562816, 11/6/2019 201945, en

(31)	201662439289 P	(32)	27.12.2016	(33)	US
(54)	NRF2 ACTIVATOR				
(72)	LUCAS, Brian, Stuart, 4 Brantwood Road, Arlington, MA 02476, US LIN, Edward, Yin-Shiang, 22 Pilgrim Road, Ashland, MA 01721, US CAPACCI, Andrew, George, 77 Trowbridge Street, Apt. 72, Cambridge, MA 02138, US XIN, Zhili, 14 Meriam Street, Lexington, MA 02420, US ENYEDY, Istvan, 15 Lyman Road, Milton, MA 02186, US CHEN, TeYu, 8 Brighton Street Unit 1, Charlestown, MA 02129, US JONES, John, H., 7 Stanley Drive, Framingham, MA 01701, US VAN VLOTEN, Kurt, D., 334 Farm Street, Bellingham, MA 02019, US				

(51) MKP
A61K 31/517 2006 (97) EP 3562822
A61P 35/00 2006
C07D 239/74 2006
C07D 401/08 2006
C07D 401/14 2006
C07D 403/08 2006
C07D 405/10 2006
C07D 417/08 2006
C07D 487/04 2006

(96) EP 17832694.8 12/28/2017
(97) EP 3562822, 11/6/2019 201945, en

(31)	201662440581 P	(32)	30.12.2016	(33)	US
(54)	POLY-ADP RIBOSE POLYMERASE (PARP) INHIBITORS				
(72)	TAKAHASHI, Taisuke, Miyukigaoka 21, Tsukuba Ibaraki 305-8585, JP KLUGE, Arthur, P.O. Box 6177, Lincoln MA 01773, US LAGU, Bharat, 21 Lexington Drive, Acton MA 01720, US JI, Nan, 5 Stony Brook Road, Arlington MA 02476, US				

(51) MKP
A61K 31/437 2006 (97) EP 3555097
A61P 29/00 2006
C07D 471/14 2006

(96) EP 17854175.1 12/15/2017
(97) EP 3555097, 10/23/2019 201943, en

(31)	201662435609 P	(32)	16.12.2016	(33)	US
	201762592680 P		30.11.2017		US
	201762596607 P		08.12.2017		US

(54) SMALL MOLECULE INHIBITORS OF THE JAK FAMILY OF KINASES
 (72) KOUDRIAKOVA, Tatiana, 3210 Merryfield Row, San Diego, California 92121, US
 KREUTTER, Kevin D., 1400 McKean Road, Spring House, Pennsylvania 19477, US
 LEONARD, Kristi, Welsh and McKean Roads, Spring House, Pennsylvania 19477, US
 RIZZOLIO, Michele C., 3210 Merryfield Row, San Diego, California 92121, US
 SMITH, Russell C., 3210 Merryfield Row, San Diego, California 92121, US
 TICHENOR, Mark S., 3210 Merryfield Row, San Diego, California 92121, US
 WANG, Aihua, Welsh and McKean Roads, Spring House, Pennsylvania 19477, US

(51) MKP
A47J 37/04 2006 (97) EP 3551019
A47J 43/18 2006
 (96) EP 17857639.3 12/12/2017
 (97) EP 3551019, 10/16/2019 201942, en
 (31) P20161106 (32) 12.12.2016 (33) RS
 (54) WIRE-STICK WITH A RING FOR EASY REMOVAL OF GRILLED MEAT AND VEGETABLES KEBABS
 (71) KALIC, Samir, Franje Kluza 10a, 21000 Novi Sad, RS
 (72) KALIC, Samir, Franje Kluza 10a, 21000 Novi Sad, RS

(51) MKP
A61K 31/4365 2006 (97) EP 3558309
C07D 495/04 2006
 (96) EP 17867920.5 11/7/2017
 (97) EP 3558309, 10/30/2019 201944, en
 (31) 201662418663 P (32) 07.11.2016 (33) US
 (54) POSITIVE ALLOSTERIC MODULATORS OF THE MUSCARINIC ACETYLCHOLINE RECEPTOR M4
 (72) LINDSLEY, Craig W., 9281 Wardley Park Lane, Brentwood, TN 37027, US
 ENGERS, Darren W., 1744 Stillwater Circle, Brentwood, TN 37027, US
 CONN, P.Jeffrey, 2806 Acklen Avenue, Nashville, TN 37212, US
 BOLLINGER, Katrina A., 140 Melstone Court, Murfreesboro, TN 37127, US
 CAPSTICK, Rory, 1252 Ballater Drive, Murfreesboro, TN 37128, US
 SPEARING, Paul, 1820 Sawgrass Lane, Chapel Hill, TN 37034, US
 BOLLINGER, Sean R., 140 Melstone Court, Murfreesboro, TN 37127, US

(51) MKP
A61K 36/31 2006 (97) EP 3562496
 (96) EP 17875026.1 11/22/2017
 (97) EP 3562496, 11/6/2019 201945, en
 (31) 201662425320 P (32) 22.11.2016 (33) US
 (54) COMPOSITIONS AND METHODS FOR TREATMENT OF INTESTINAL INFLAMMATION AND COLON CANCER
 (71) University of Louisville Research Foundation, Inc., Office of Technology Transfer 300 E. Market St., Suite 300, Louisville, KY 40202, US
 (72) ZHANG, Huang-Ge, c/o University of Louisville Research Foundation Inc. Office of Technology Transfer 300 East Market Street Suite 300, Louisville, Kentucky 40202, US

(51) MKP
A61K 35/76 2015 (97) EP 3551750
A61K 38/43 2006
C12N 7/00 2006
C12N 15/86 2006
 (96) EP 17877511.0 12/6/2017
 (97) EP 3551750, 10/16/2019 201942, en
 (31) 201662430795 P (32) 06.12.2016 (33) US
 (54) GENE THERAPY FOR MUCOPOLYSACCHARIDOSIS, TYPE I
 (72) GOSS, Kendrick A., 75 Winter Street, Lexington, Massachusetts 02420, US
 PARSONS, Geoffrey B., 17 Castleton Street, Jamaica Plain, Massachusetts 02130, US

(51) MKP
A61K 9/51 2006 (97) EP 3551193
A61K 31/7105 2006
A61K 31/7115 2006
A61P 31/14 2006

(96) EP 17877985.6 12/8/2017
 (97) EP 3551193, 10/16/2019 201942, en
 (31) 201662431775 P (32) 08.12.2016 (33) US
 (54) RESPIRATORY VIRUS NUCLEIC ACID VACCINES
 (72) CIARAMELLA, Giuseppe, 1 Hawes Road, Sudbury, MA 01776, US
 HIMANSU, Sunny, 23 Fernway, Winchester, MA 01890, US

(51) MKP
E01B 9/28 2006 (97) EP 3551800
E01B 9/30 2006
E01B 9/60 2006
E01B 13/02 2006
 (96) EP 17878675.2 12/6/2017
 (97) EP 3551800, 10/16/2019 201942, en
 (31) 1600654 (32) 07.12.2016 (33) HU
 (54) RAIL MOUNTING DEVICE AND METHOD FOR FIXING RAILS TO REINFORCED CONCRETE RAILWAY SLEEPER
 (71) HR System Hungary Zrt., Bartók Béla út 46/B 1. em. 13., 2370 Dabas, HU
 (72) RÁCZ, Attila, Léva u. 6., 1204 Budapest, HU

(51) MKP
A61K 35/76 2015 (97) EP 3562937
A61K 38/43 2006
C12N 7/00 2006
C12N 15/86 2006
 (96) EP 17878786.7 12/6/2017
 (97) EP 3562937, 11/6/2019 201945, en
 (31) 201662430819 P (32) 06.12.2016 (33) US
 (54) GENE THERAPY FOR MUCOPOLYSACCHARIDOSIS, TYPE II
 (72) GOSS, Kendrick A., 75 Winter Street, Lexington, Massachusetts 02420, US
 PARSONS, Geoffrey B., 17 Castleton Street, Jamaica Plain, Massachusetts 02130, US

(51) MKP
A61F 13/15 2006 (97) EP 3551149
A61F 13/51 2006
A61F 13/511 2006
A61F 13/514 2006
A61F 13/53 2006
 (96) EP 17878892.3 12/6/2017
 (97) EP 3551149, 10/16/2019 201942, en
 (31) 201615369886 (32) 06.12.2016 (33) US
 (54) BIODEGRADABLE SANITARY ARTICLES WITH HIGHER BIOBASED CONTENT
 (72) SOOKRAJ, Sadesh H., c/o Novomer, Inc. 1 Bowdoin Square, Suite 300, Boston, Massachusetts 02114, US

(51) MKP
A61K 35/16 2015 (97) EP 3551215
A61K 38/18 2006
A61K 38/19 2006
A61K 38/20 2006
 (96) EP 17879120.8 12/6/2017
 (97) EP 3551215, 10/16/2019 201942, en
 (31) 2950659 (32) 06.12.2016 (33) CA
 (54) METHOD FOR THE PREPARATION AND PROLONGED STORAGE OF GROWTH FACTORS AND CYTOKINES OBTAINED FROM PLATELET RICH PLASMA
 (72) GALEA, Anthony, 230 Browns Line, Toronto, Ontario M8W 3T4, CA
 BROKHMANN, Irina, 15 Marmot Court, Vaughan, Ontario L6A 4C7, CA

(51) MKP
A61K 39/395 2006 (97) EP 3551667
C07K 16/18 2006
C07K 16/28 2006
C07K 16/46 2006
 (96) EP 17879207.3 12/8/2017

(97) EP 3551667, 10/16/2019 201942, en
 (31) 201662432472 P (32) 09.12.2016 (33) US
 (54) BIVALENT ANTIBODIES MASKED BY COILED COILS
 (72) TRANG, Vivian, 21823 30th Drive S.E., Bothell, WA 98021, US
 LEVENGOOD, Matthew R., 21823 30th Drive S.E., Bothell, WA 98021, US
 SENTER, Peter, 21823 30th Drive S.E., Bothell, WA 98021, US

(51) MKP
C07K 7/08 2006 (97) EP 3556766
C07K 14/005 2006
C07K 19/00 2006
 (96) EP 17879807.0 12/15/2017
 (97) EP 3556766, 10/23/2019 201943, en
 (31) 20160172548 (32) 16.12.2016 (33) KR
 (54) CYTOPLASMIC TRANSDUCTION PEPTIDE AND INTRACELLULAR MESSENGER COMPRISING SAME
 (71) Avixgen Inc., 222 Banpo-daero Seocho-gu, Seoul 06591, KR
 (72) BAEK, Yi Yong, 601-ho 901-dong 10 Hugok-ro Ilsanseo-gu, Goyang-si Gyeonggi-do 10375, KR
 KIM, Min Jung, 201-ho 29 Nambusunhwan-ro 210-gil Gwanak-gu, Seoul 08785, KR

(51) MKP
A23K 50/10 2016 (97) EP 3554266
A61K 31/351 2006
A61K 38/00 2006
A61K 39/00 2006
 (96) EP 17879927.6 12/14/2017
 (97) EP 3554266, 10/23/2019 201943, en
 (31) 201662434333 P (32) 14.12.2016 (33) US
 2017115832 13.06.2017 JP
 (54) MULTI-DRUG ANTIBODY DRUG CONJUGATES
 (72) LEVENGOOD, Matthew, R., c/o 21823 -30th Drive S. E., Bothell, WA 98021, US

(51) MKP
A61K 39/395 2006 (97) EP 3554544
A61P 35/00 2006
C07K 16/18 2006
C07K 16/30 2006
 (96) EP 17880084.3 12/15/2017
 (97) EP 3554544, 10/23/2019 201943, en
 (31) 201662435509 P (32) 16.12.2016 (33) US
 201762488445 P 21.04.2017 US
 201762588516 P 20.11.2017 US
 (54) ANTI-CUB DOMAIN-CONTAINING PROTEIN 1 (CDCP1) ANTIBODIES, ANTIBODY DRUG CONJUGATES, AND METHODS OF USE
 THEREOF
 (71) Bluefin Biomedicine, Inc., 32 Tozer Road, Beverly, MA 01915, US
 (72) REN, Hong, 87 Arlington Street, Brighton, MA 02315, US
 LONNING, Scott, Michael, 1 Grassy Lane, Westford, MA 01886, US
 PEDERSON, Nels, Eric, 71 Pattys Road, Mansfield, MA 02048, US
 RIKOVA, Klarisa, 1 Charles Street Unit M, Reading, MA 01867, US
 TKACHEV, Aleksandr, 1105 Massachusetts Avenue Apt. 9H, Cambridge, MA 02138, US
 GU, Tinglei, 67 Argilla Road, Andover, MA 01810, US

(51) MKP
A61K 35/545 2015 (97) EP 3555273
C07K 14/705 2006
C12N 5/074 2010
C12N 9/12 2006
 (96) EP 17880424.1 12/15/2017
 (97) EP 3555273, 10/23/2019 201943, en
 (31) 201662435522 P (32) 16.12.2016 (33) US
 (54) ENHANCED hAT FAMILY TRANSPOSON-MEDIATED GENE TRANSFER AND ASSOCIATED COMPOSITIONS, SYSTEMS, AND METHODS
 (71) B-Mogen Biotechnologies, Inc., 614 McKinley Place NE, Minneapolis, Minnesota 55413, US
 (72) LARGAESPADA, David, 8285 Knollwood Drive, Mounds View, Minnesota 55112, US
 MORIARITY, Branden, 1520 Sherwood Road, Shoreview, Minnesota 55126, US

WEBBER, Beau, 2607 130th Circle NW, Coon Rapids, Minnesota 55448, US
 OTTO, Neil, 20344 Babcock Avenue, Lester Prairie, Minnesota 55354, US
 KUMAR, Sandeep, 1122 Como Avenue SE Apt. 105, Minneapolis, Minnesota 55414, US
 HOGDAL, Leah, 500 N 2nd Street Apt. 112, Minneapolis, Minnesota 55401, US

(51) MKP
C07D 215/12 2006 (97) EP 3558946
C07D 215/38 2006
 (96) EP 17880820.0 12/15/2017
 (97) EP 3558946, 10/30/2019 201944, en
 (31) 201662435426 P (32) 16.12.2016 (33) US
 (54) POSITIVE ALLOSTERIC MODULATORS OF THE MUSCARINIC ACETYLCHOLINE RECEPTOR M4
 (72) LINDSLEY, Craig, W., 9281 Wardley Park Lane, Brentwood, TN 37027, US
 CONN, P., Jeffrey, 2806 Acklen Avenue, Nashville, TN 37212, US
 ENGERS, Darren, W., 1744 Stillwater Circle, Brentwood, TN 37027, US
 ENGERS, Julie, L., 1744 Stillwater Circle, Brentwood, TN 37027, US
 LONG, Madeline, F., 4110 Idaho Avenue, Nashville, TN 37209, US

(51) MKP
C12N 9/22 2006 (97) EP 3555289
C12N 11/14 2006
C12N 15/10 2006
C12Q 1/34 2006
C12Q 1/68 2018
 (96) EP 17880888.7 12/13/2017
 (97) EP 3555289, 10/23/2019 201943, en
 (31) 201662433352 P (32) 13.12.2016 (33) US
 (54) RNA AFFINITY PURIFICATION
 (72) MIRACCO, Edward, J., 6 Frost Street, Arlington, MA 02474, US

(51) MKP
A61K 9/00 2006 (97) EP 3556370
A61K 9/08 2006
A61K 31/635 2006
A61K 31/728 2006
 (96) EP 17882056.9 12/15/2017
 (97) EP 3556370, 10/23/2019 201943, en
 (31) 20160172784 (32) 16.12.2016 (33) KR
 (54) OPHTHALMIC COMPOSITION CONTAINING SULFASALAZINE AND HYALURONIC ACID
 (71) Kukje Pharma Co., Ltd., 96-8 Yatap-ro Bundang-gu, Seongnam-si, Gyeonggi-do 13517, KR
 (72) BAE, Hyun Ju, 732-102 52 Jeongja-ro 42beon-gil Jangan-gu, Suwon-si Gyeonggi-do 16325, KR
 KIM, Seung Ki, 501-1503 403 Beonyeong-ro, Gunpo-si Gyeonggi-do 15869, KR
 KIM, Beom Jung, 1132-1303 533 Chungjang-ro Sangnok-gu, Ansan-si Gyeonggi-do 15292, KR
 LEE, Ju Hee, 721-1702 119 Gwangjeong-ro, Gunpo-si Gyeonggi-do 15825, KR
 KIM, Young Gwan, 310-1001 201 Gwangdeok 3-ro Danwon-gu, Ansan-si Gyeonggi-do 15463, KR

(51) MKP
A61K 31/4545 2006 (97) EP 3560919
A61P 35/00 2006
C07D 401/14 2006
 (96) EP 17882687.1 12/22/2017
 (97) EP 3560919, 10/30/2019 201944, en
 (31) 2016249767 (32) 22.12.2016 (33) JP
 (54) SALT OF SUBSTITUTED PIPERIDINE COMPOUND
 (72) MITSUYA Morihiko, c/o Taiho Pharmaceutical Co. Ltd. 3 Okubo, Tsukuba-shi Ibaraki 300-2611, JP

(51) MKP
B05D 1/00 2006 (97) EP 3558864
B82B 3/00 2006
B82Y 40/00 2011
C08F 2/34 2006
C08F 2/46 2006

	C08F 2/58	2006					
	C23C 14/00	2006					
	C23C 16/455	2006					
	C23C 16/50	2006					
	H05H 1/24	2006					
(96)	EP 17883477.6 12/21/2017						
(97)	EP 3558864, 10/30/2019 201944, en						
(31)	2016905306		(32)	21.12.2016		(33)	AU
(54)	NANOPARTICLES						
(71)	The Heart Research Institute Ltd, 7 Eliza Street, Newtown, New South Wales 2042, AU						
(72)	CORREIA DOS SANTOS, Miguel Angelo, 5/19 Moore Park Road, Paddington, New South Wales 2021, AU						
	FILIPE, Elysse, 5/19 Moore Park Road, Paddington, New South Wales 2021, AU						
	LORWATTANAPONGSA, Praveesuda, Unit 1 181 Missenden Road, Newtown, New South Wales 2042, AU						
	BILEK, Marcela, 2 Kurrajong Street, Sutherland, New South Wales 2232, AU						
	WISE, Steven Garry, 30 Milford Avenue, Panania, New South Wales 2213, AU						
<hr/>							
(51)	MKP						
	A61K 31/519	2006	(97)	EP 3560931			
	A61P 43/00	2006					
	C07D 231/12	2006					
	C07D 519/00	2006					
(96)	EP 17883651.6 12/20/2017						
(97)	EP 3560931, 10/30/2019 201944, en						
(31)	2016247606		(32)	21.12.2016		(33)	JP
(54)	METHOD FOR PRODUCING 7H-PYRROLO[2,3-D]PYRIMIDINE DERIVATIVE, AND COCRYSTAL OF SAID DERIVATIVE						
(72)	SHIMAZAKI, Takahisa, c/o Central Pharmaceutical Research Institute of Japan Tobacco Inc. 1-1 Murasaki-cho, Takatsuki-shi Osaka 569-1125, JP						
<hr/>							
(51)	MKP						
	A61K 39/395	2006	(97)	EP 3558369			
	A61P 19/02	2006					
	C07K 16/24	2006					
	G01N 33/53	2006					
(96)	EP 17883800.9 12/21/2017						
(97)	EP 3558369, 10/30/2019 201944, en						
(31)	201662437143 P		(32)	21.12.2016		(33)	US
(54)	ANTIBODIES THAT SPECIFICALLY BIND TO HUMAN IL-15 AND USES THEREOF						
(72)	LAINE, David Jose Simon, c/o Teva Pharmaceutical Australia Pty Ltd., 37 Epping Road,, Macquarie Park NSW 2113, AU						
	POLLARD, Matthew, 60 Summerland Place,, Pullenvale QLD 4069, AU						
	DOYLE, Anthony Gerard, Teva Pharmaceuticals Austrakia Pty Ltd., 37 Epping Road,, Macquarie Park NSW 2113, AU						
	POULTON, Lynn Dorothy, Teva Pharmaceutical Australia Pty Ltd., 37 Epping Road, Macquarie Park NSW 2113, AU						
	CLARKE, Adam William, Teva Pharmaceutical Australia Pty Ltd., 37 Epping Road,, Macquarie Park NSW 2113,, AU						
<hr/>							
(51)	MKP						
	A61K 31/685	2006	(97)	EP 3558322			
	A61P 31/18	2006					
	A61P 31/20	2006					
	C07F 9/6561	2006					
(96)	EP 17883867.8 12/19/2017						
(97)	EP 3558322, 10/30/2019 201944, en						
(31)	201662437745 P		(32)	22.12.2016		(33)	US
	201762540748 P			03.08.2017			US
(54)	ANTIVIRAL BENZYL-AMINE PHOSPHODIAMIDE COMPOUNDS						
(72)	DE LERA RUIZ, Manuel, 770 Sumneytown Pike, West Point Pennsylvania 19486, US						
	HARTINGH, Timothy, J., 770 Sumneytown Pike, West Point Pennsylvania 19486, US						
	RAHEEM, Izzat, 770 Sumneytown Pike, West Point Pennsylvania 19486, US						
	SCHREIER, John, 770 Sumneytown Pike, West Point Pennsylvania 19486, US						
	PAPARIN, Jean-Laurent, 3 rue des Pins, 34230 Vendemian, FR						
<hr/>							
(51)	MKP						
	C07C 271/22	2006	(97)	EP 3560932			
	C07D 307/33	2006					
	C07D 403/06	2006					

C07D 487/10 2006
C07D 491/10 2006
C07D 519/00 2006
(96) EP 17885424.6 12/20/2017
(97) EP 3560932, 10/30/2019 201944, en
(31) 2016247607 (32) 21.12.2016 (33) JP
(54) METHOD FOR PRODUCING 7H-PYRROLO[2,3-D]PYRIMIDINE DERIVATIVE AND SYNTHETIC INTERMEDIATE OF SAME
(72) TAKIGUCHI, Hiromu, c/o Central Pharmaceutical Research Institute of Japan Tobacco Inc. 1-1 Murasaki-cho, Takatsuki-shi Osaka 569-1125, JP
HIGASHI, Akinobu, c/o Central Pharmaceutical Research Institute of Japan Tobacco Inc. 1-1 Murasaki-cho, Takatsuki-shi Osaka 569-1125, JP
INABA, Takashi, c/o Central Pharmaceutical Research Institute of Japan Tobacco Inc. 1-1 Murasaki-cho, Takatsuki-shi Osaka 569-1125, JP
WATANABE, Takashi, c/o Central Pharmaceutical Research Institute of Japan Tobacco Inc. 1-1 Murasaki-cho, Takatsuki-shi Osaka 569-1125, JP
TAKEICHI, Tsubasa, c/o Central Pharmaceutical Research Institute of Japan Tobacco Inc. 1-1 Murasaki-cho, Takatsuki-shi Osaka 569-1125, JP
PETERSEN, Anders Klarskov, c/o LEO Pharma A/S Industriparken 55, DK-2750 Ballerup, DK
VEDSOE, Per, c/o LEO Pharma A/S Industriparken 55, DK-2750 Ballerup, DK
JENSEN, Kim Lebek, c/o LEO Pharma A/S Industriparken 55, DK-2750 Ballerup, DK
BORNHOLDT, Jan, c/o LEO Pharma A/S Industriparken 55, DK-2750 Ballerup, DK
EBDRUP, Søren, c/o LEO Pharma A/S Industriparken 55, DK-2750 Ballerup, DK

(51) MKP
A61K 31/415 2006 (97) EP 3562486
A61K 31/4174 2006
(96) EP 17885750.4 12/29/2017
(97) EP 3562486, 11/6/2019 201945, en
(31) 201662441164 P (32) 31.12.2016 (33) US
201762471393 P 15.03.2017 US
201762542323 P 08.08.2017 US
(54) USE OF SUBLINGUAL DEXMEDETOMIDINE FOR THE TREATMENT OF AGITATION
(72) NANDABALAN, Krishnan, c/o Bioxcel Therapeutics Inc. 780 East Main Street, Branford Connecticut 06405, US
YOCCA, Frank, c/o Bioxcel Therapeutics Inc. 780 East Main Street, Branford Connecticut 06405, US
SHARMA, Sameer, c/o Bioxcel Therapeutics Inc. 780 East Main Street, Branford Connecticut 06405, US

(51) MKP
G06F 17/30 2006 (97) EP 3563379
G16H 10/20 2018
G16H 15/00 2018
(96) EP 17888679.2 12/28/2017
(97) EP 3563379, 11/6/2019 201945, en
(31) 201615395902 (32) 30.12.2016 (33) US
(54) DYNAMIC SEARCH AND RETRIEVAL OF QUESTIONS
(71) UNIVERSAL RESEARCH SOLUTIONS, LLC, 414 E Broadway, Suite 102, Columbia, MO 65201, US
(72) PLUMMER, Otho Raymond, 2600 Johnson Drive, Columbia, MO 65203, US
HUSSAM, Ali Adel, 2002 Chapel Ridge Rd., Columbia, MO 65203, US

(51) MKP
H04L 29/06 2006 (97) EP 3570512
H04L 29/12 2006
(96) EP 17891473.5 12/22/2017
(97) EP 3570512, 11/20/2019 201947, en
(31) 201710021111 (32) 11.01.2017 (33) CN
(54) DOMAIN NAME RESOLUTION METHOD, SERVER AND STORAGE MEDIUM
(71) Tencent Technology (Shenzhen) Company Limited, 35/F, Tencent Building Kejizhongyi Road Midwest District of Hi-tech Park Nanshan District, Shenzhen, Guangdong 518057, CN
(72) JIANG, Fengbo, 35/F, Tencent Building Kejizhongyi Road Midwest District of Hi-Tech Park Nanshan District, Shenzhen Guangdong 518057, CN
WANG, Hailong, 35/F, Tencent Building Kejizhongyi Road Midwest District of Hi-Tech Park Nanshan District, Shenzhen Guangdong 518057, CN
CHEN, Fangzhou, 35/F, Tencent Building Kejizhongyi Road Midwest District of Hi-Tech Park Nanshan District, Shenzhen Guangdong 518057, CN

(51) MKP
A61K 39/395 2006 (97) EP 3573658
C07K 14/525 2006
C07K 16/24 2006
(96) EP 17893875.9 11/16/2017
(97) EP 3573658, 12/4/2019 201949, en

(31) 201762452079 P (32) 30.01.2017 (33) US
 (54) ANTI-TNF ANTIBODIES, COMPOSITIONS, AND METHODS FOR THE TREATMENT OF ACTIVE PSORIATIC ARTHRITIS
 (72) HARRISON, Diane, D., 1400 McKean Road, Spring House, PA 19477, US
 HSIA, Elizabeth, C., 1400 McKean Road, Spring House, PA 19477, US
 KIM, Lee-Lian, 1400 McKean Road, Spring House, PA 19477, US
 LO, Kim Hung, 1400 McKean Road, Spring House, PA 19477, US

(51) MKP
A61K 31/7088 2006 (97) EP 3576751
A61K 31/7105 2006
A61K 39/00 2006
A61K 39/39 2006
A61P 35/00 2006
 (96) EP 17894869.1 10/26/2017
 (97) EP 3576751, 12/11/2019 201950, en
 (31) 201762453444 P (32) 01.02.2017 (33) US
 201762453465 P 01.02.2017 US
 201762558238 P 13.09.2017 US
 (54) RNA CANCER VACCINES
 (72) VALIANTE, Nicholas, 70 Norfolk Street, Cambridge, MA 02139, US
 ASHBURN, Ted, 1688 Washington Street No. 1, Boston, MA 02118, US
 HOPSON, Kristen, 331 Appleton Street, Arlington, MA 02476, US

(51) MKP
A61K 39/395 2006 (97) EP 3579871
C07K 16/18 2006
C07K 16/24 2006
 (96) EP 17895666.0 11/16/2017
 (97) EP 3579871, 12/18/2019 201951, en
 (31) 201762455651 P (32) 07.02.2017 (33) US
 (54) ANTI-TNF ANTIBODIES, COMPOSITIONS, AND METHODS FOR THE TREATMENT OF ACTIVE ANKYLOSING SPONDYLITIS
 (72) HARRISON, Diane, D., 1400 McKean Road, Spring House, PA 19477, US
 HSIA, Elizabeth, C., 1400 McKean Road, Spring House, PA 19477, US
 KIM, Lee-Lian, 1400 McKean Road, Spring House, PA 19477, US
 LO, Kim Hung, 1400 McKean Road, Spring House, PA 19477, US

(51) MKP
A21C 9/00 2006 (97) EP 3581030
A21D 8/02 2006
A21D 8/06 2006
A21D 10/02 2006
G07F 9/10 2006
G07F 11/70 2006
G07F 17/00 2006
 (96) EP 17895690.0 8/7/2017
 (97) EP 3581030, 12/18/2019 201951, en
 (31) 201730112 U (32) 07.02.2017 (33) ES
 201730142 07.02.2017 ES
 201730780 07.06.2017 ES
 (54) METHOD FOR PREPARING FOODS BASED ON DOUGHS FROZEN IN PORTIONS AND MACHINE FOR PREPARING AND SELLING SAID FOODS
 (71) Rodriguez Barbero Moreno, Luis Miguel, CL Lopez de Hoyos 363, 28280 Madrid, ES
 Serrano Vacas, Juan Carlos, Rnda. San Torcuato 11 P04 E, 49006 Zamora, ES
 Monferrer Tena, Joan Antoni, Plaza Roige i Badia 5 4-2, 08820 El Prat de Llobregat (Barcelona), ES
 (72) RODRIGUEZ BARBERO MORENO, Luis Miguel, CL Lopez de Hoyos 363, 28280 Madrid, ES

(51) MKP
C07D 217/26 2006 (97) EP 3470397
 (96) EP 18189607.7 7/15/2013
 (97) EP 3470397, 11/20/2019 201947, en
 (31) 201261672191 P (32) 16.07.2012 (33) US
 201361768297 P 22.02.2013 US

201361832566 P

07.06.2013

US

- (54) CRYSTALLINE FORMS OF A PROLYL HYDROXYLASE INHIBITOR
 (72) WITSCHI, Claudia, c/o FibroGen, Inc. 409 Illinois St., San Francisco, CA California 94158, US
 PARK, Jung Min, c/o FibroGen, Inc. 409 Illinois St., San Francisco, CA California 94158, US
 THOMPSON, Michael, D., c/o FibroGen, Inc. 409 Illinois St., San Francisco, CA California 94158, US
 MARTINELLI, Michael, John, c/o FibroGen, Inc. 409 Illinois St., San Francisco, CA California 94158, US
 YEOWELL, David, A., c/o FibroGen, Inc. 409 Illinois St., San Francisco, CA California 94158, US
 AREND, Michael, P., c/o FibroGen, Inc. 409 Illinois St., San Francisco, CA California 94158, US
-

- (51) MKP
A61K 39/00 2006 (97) EP 3485902
A61K 39/395 2006
A61P 11/00 2006
G01N 33/48 2006
 (96) EP 18189626.7 10/14/2014
 (97) EP 3485902, 1/1/2020 202001, en
 (31) 201361891175 P (32) 15.10.2013 (33) US
 201461970126 P 25.03.2014 US
 (54) METHODS FOR TREATING CHRONIC OBSTRUCTIVE PULMONARY DISEASE USING BENRALIZUMAB
 (72) VAN DER MERWE, Rene, Medimmune Limited Milstein Building Granta Park, Cambridge, Cambridgeshire CB21 6GH, GB
 WARD, Christine, Medimmune LLC One Medimmune Way, Gaithersburg, Maryland 20878, US
 MARTIN, Ubaldo, Medimmune LLC One Medimmune Way, Gaithersburg, Maryland 20878, US
 ROSKOS, Lorin, Medimmune LLC One Medimmune Way, Gaithersburg, Maryland 20878, US
 WANG, Bing, Medimmune LLC One Medimmune Way, Gaithersburg, Maryland 20878, US
-

- (51) MKP
A61B 17/34 2006 (97) EP 3459475
 (96) EP 18190051.5 7/21/2010
 (97) EP 3459475, 11/6/2019 201945, en
 (31) 53359009 (32) 31.07.2009 (33) US
 (54) SURGICAL ACCESS DEVICES WITH SORBENTS
 (72) MORENO, Cesar E., Jr., 514 Ezzard Charles Drive, Cincinnati, OH 45214, US
 MINNELLI, Patrick J., 103 Burk Lane, Harrison, OH 45030, US
 GILKER, Thomas A., 3434 Darwin Place, Cincinnati, OH 45211, US
 MUMAW, Daniel J., 953 Long Lane, Milford, OH 45150, US
 MOLLERE, Rebecca J., 6178 Spires Drive, Loveland, OH 45140, US
 TANGUAY, Randall, 4299 N. Sr 741, Lebanon, OH 45036, US
 FRANER, Paul T., 6217 Rapid Run Road, Cincinnati, OH 45233, US
-

- (51) MKP
G01N 33/533 2006 (97) EP 3467501
 (96) EP 18190640.5 5/15/2015
 (97) EP 3467501, 11/20/2019 201947, en
 (31) 201461994430 P (32) 16.05.2014 (33) US
 (54) ASSAY FOR DETECTING TH1 AND TH2 CELL POPULATIONS
 (72) GORSKI, Kevin, 28 Curlew Way, Novato, CA 94949, US
 PARNES, Jane, R., 5832 Middle Crest Drive, Agoura Hills, CA 91301, US
 BIGLER, Jeanette, 3200 NE 92nd, Seattle, CA 98115, US
 BOEDIGHEIMER, Michael, J., 3192 Holloway Court, Newbury Park, CA 91320, US
 WELCHER, Andrew, A., 1175 Church Street, Ventura, CA 93001, US
-

- (51) MKP
A01N 43/56 2006 (97) EP 3473099
A61K 31/415 2006
A61K 45/06 2006
A61P 35/00 2006
C07D 401/04 2006
C07D 401/10 2006
C07D 401/14 2006
C07D 405/14 2006
C07D 413/12 2006
 (96) EP 18191545.5 9/13/2012

(97) EP 3473099, 11/27/2019 201948, en
 (31) 201161534601 P (32) 14.09.2011 (33) US
 201261624646 P 16.04.2012 US
 (54) INDAZOLE-3-CARBOXAMIDES AND THEIR USE AS WNT/B-CATENIN SIGNALING PATHWAY INHIBITORS
 (71) Samumed, LLC, 9381 Judicial Drive, San Diego, California 92121, US
 (72) HOOD, John, 10831 Vereda Sol del Dios, San Diego, CA 92130, US
 KC, Sunil Kumar, 10504 Clasico Court, San Diego, CA 92127, US

(51) MKP
A61K 9/20 2006 (97) EP 3470063
A61K 31/443 2006
A61K 31/47 2006
A61K 45/06 2006
 (96) EP 18192504.1 11/1/2013
 (97) EP 3470063, 11/27/2019 201948, en
 (31) 201261721622 P (32) 02.11.2012 (33) US
 201261728328 P 20.11.2012 US
 201361770668 P 28.02.2013 US
 201361824005 P 16.05.2013 US
 201361840668 P 28.06.2013 US
 (54) PHARMACEUTICAL COMPOSITIONS FOR THE TREATMENT OF CFTR MEDIATED DISEASES
 (72) VERWIJS, Marinus, Jacobus, 4 Carter Drive, Framingham, Massachusetts 01701, US
 KARKARE, Radhika, 88 Oxbow Road, Framingham, Massachusetts 01701, US
 MOORE, Michael, Douglas, 22 Prospect Street Unit 1, Charlestown, Massachusetts 02129, US

(51) MKP
C12Q 1/68 2018 (97) EP 3467500
G01N 33/52 2006
G01N 33/53 2006
G01N 33/543 2006
 (96) EP 18192525.6 11/9/2012
 (97) EP 3467500, 11/20/2019 201947, en
 (31) 201161558537 P (32) 11.11.2011 (33) US
 (54) CO-BINDER ASSISTED ASSAY METHODS
 (72) Glezer, Eli N., 13746 Durango Drive, Del Mar, California 92014, US
 Sigal, George, 5333 Trailway Drive, Rockville, Maryland 20853, US

(51) MKP
A61K 48/00 2006 (97) EP 3461838
C07K 14/47 2006
C12N 15/113 2010
C12N 15/86 2006
 (96) EP 18192536.3 4/18/2014
 (97) EP 3461838, 11/13/2019 201946, en
 (31) 201361814256 P (32) 20.04.2013 (33) US
 (54) RECOMBINANT ADENO-ASSOCIATED VIRUS DELIVERY OF EXON 2-TARGETED U7SNRNA POLYNUCLEOTIDE CONSTRUCTS
 (72) FLANIGAN, Kevin, 700 Children's Drive, Room W172, Columbus, OH 43205, US
 VULIN-CHAFFIOL, Adeline, 31 rue de la Croix Louis, Brétigny sur Orge, 91220, FR
 WEIN, Nicolas, 700 Children's Drive, Room W172, Columbus, OH 43205, US

(51) MKP
A01N 37/34 2006 (97) EP 3437474
A01N 37/40 2006
A01N 41/10 2006
A01N 43/40 2006
A01N 47/36 2006
A01P 13/00 2006
 (96) EP 18193634.5 4/30/2013
 (97) EP 3437474, 10/23/2019 201943, en
 (31) 2012107101 (32) 08.05.2012 (33) JP
 (54) HERBICIDAL COMPOSITION
 (72) YAMADA, Ryu, c/o Ishihara Sangyo Kaisha Ltd. Chuo Kenkyusho 3-1 Nishi-shibukawa 2-chome Kusatsu-shi, Shiga, 525-0025, JP
 OKAMOTO, Hiroyuki, c/o Ishihara Sangyo Kaisha Ltd. Chuo Kenkyusho 3-1 Nishi-shibukawa 2-chome Kusatsu-shi, Shiga, 525-0025, JP

- (51) MKP
A61P 11/00 2006 (97) EP 3460054
A61P 21/00 2006
A61P 29/00 2006
A61P 37/00 2006
C12N 9/00 2006
C12N 9/96 2006
- (96) EP 18194251.7 3/14/2014
(97) EP 3460054, 10/23/2019 201943, en
(31) 201361789011 P (32) 15.03.2013 (33) US
- (54) HISTIDYL-TRNA SYNTHETASE-FC CONJUGATES
(71) Atyr Pharma, Inc., 3545 John Hopkins Court, Suite No. 250, San Diego, CA 92121, US
(72) Buechler, Ying, 1343 Cassins Street, Carlsbad, California 92011, US
Chiang, Kyle, 162 Mystic Street, Arlington, MA 02474, US
Do, Minh-Ha, 3911 Zanakano Street, San Diego, California 92122, US
Lee, Darin, 3432 Conrad Avenue, San Diego, California 92117, US
Piehl, Kristi, 5321 Zion Avenue, San Diego, California 92130, US
Thomas, Marc, 800 Orca Avo Drive, Vista, California 92084-0282, US
Watkins, Jeffrey D., 3442 Fortuna Ranch Road, Encinitas, California 92024, US
Wu, Chi-Fang, 2649 Villas Way, San Diego, California 92108, US
Mendlein, John D., 1550 Neptune Avenue, Encinitas, California 92024, US

- (51) MKP
B01L 3/00 2006 (97) EP 3450980
C12Q 1/68 2018
G01N 33/52 2006
G01N 33/543 2006
- (96) EP 18194882.9 10/7/2016
(97) EP 3450980, 10/16/2019 201942, en
(31) 201562238171 P (32) 07.10.2015 (33) US
201662368564 P 29.07.2016 US
- (54) METHOD OF HOSTING A STABLE DROPLET PATTERN
(72) Kunding, Andreas, Dalbugten 65, 2730 Herlev, DK

- (51) MKP
G01N 33/68 2006 (97) EP 3483611
- (96) EP 18195890.1 9/27/2012
(97) EP 3483611, 12/25/2019 201952, en
(31) 201161540839 P (32) 29.09.2011 (33) US
201261701489 P 14.09.2012 US
- (54) INTACT MASS DETERMINATION OF PROTEIN CONJUGATED AGENT COMPOUNDS
(72) VALLIERE-DOUGLASS, John Fay, Seattle Genetics, Inc. 21823 30th Drive, S.E., Bothell, WA 98021, US
SALAS, Oscar, Seattle Genetics, Inc. 21823 30th Drive, S.E., Bothell, WA 98021, US

- (51) MKP
A61K 9/14 2006 (97) EP 3470370
A61K 33/00 2006
A61K 33/24 2019
A61K 45/06 2006
B01J 19/00 2006
B01J 19/18 2006
B01J 39/02 2006
B01J 39/14 2006
C01B 33/20 2006
C01B 39/02 2006
C01B 39/46 2006
C07F 7/02 2006
- (96) EP 18195925.5 2/10/2012
(97) EP 3470370, 11/27/2019 201948, en
(31) 201161441893 P (32) 11.02.2011 (33) US

- (54) MICROPOROUS ZIRCONIUM SILICATE FOR THE TREATMENT OF HYPERKALEMIA
 (71) ZS Pharma, Inc, 508 Wrangler Dr., Suite 100, Coppell, TX 75019-7609, US
 (72) KEYSER, Donald, Jeffrey, 1216 Wyndham Hill Lane, Southlake, TX Texas 76092, US
 GUILLEM, Alvaro, F., 727 Lathrop Street, Lantana, TX Texas 76226, US

- (51) MKP
A61K 39/285 2006 (97) EP 3456349
C07K 14/07 2006
C12N 15/863 2006
 (96) EP 18195933.9 3/11/2010
 (97) EP 3456349, 10/30/2019 201944, en
 (31) 159857 P (32) 13.03.2009 (33) US
 09009759 28.07.2009 EP
 (54) OPTIMIZED EARLY-LATE PROMOTER COMBINED WITH REPEATED VACCINATION FAVORS CYTOTOXIC T CELL RESPONSE AGAINST
 RECOMBINANT ANTIGEN IN MVA VACCINES
 (72) Hausmann, Jürgen, Bavarian Nordic GmbH Alte Bundesstrasse 130, 79194 Gundelfingen, DE
 Brinkmann, Kay, Gebssattelstrasse 10, 81541 Munich, DE
 Baur, Karen, Lichtenbergstrasse 14, 65191 Wiesbaden, DE

- (51) MKP
A61K 39/395 2006 (97) EP 3480202
A61K 47/50 2017
A61K 51/00 2006
C07D 498/14 2006
 (96) EP 18196502.1 6/2/2010
 (97) EP 3480202, 12/18/2019 201951, en
 (31) 18377409 P (32) 03.06.2009 (33) US
 (54) CONJUGATION METHODS
 (72) KELLOGG, Brenda A., 16 Marshall Street, Medford, MA Massachusetts 02155, US
 SINGH, Rajeeva, 17 Dartmouth Drive, Framingham, MA Massachusetts 01701, US
 CHARI, Ravi, V., J., 174 Winchester Street, Newton, MA Massachusetts 02161, US

- (51) MKP
A61K 31/4412 2006 (97) EP 3483143
A61P 35/00 2006
C07D 211/40 2006
C07D 279/02 2006
C07D 401/04 2006
C07D 401/06 2006
C07D 401/12 2006
C07D 407/04 2006
C07D 407/06 2006
C07D 409/04 2006
C07D 413/06 2006
C07D 417/06 2006
C07D 471/20 2006
C07D 498/08 2006
C07D 498/20 2006
 (96) EP 18197155.7 6/3/2011
 (97) EP 3483143, 12/18/2019 201951, en
 (31) 35182710 P (32) 04.06.2010 (33) US
 35232210 P 07.06.2010 US
 201161452578 P 14.03.2011 US
 (54) PIPERIDINONE DERIVATIVES AS MDM2 INHIBITORS FOR THE TREATMENT OF CANCER
 (72) Bartberger, Michael David, 4471 Ventura Canyon Avenue D-105, Sherman Oaks, CA 91423, US
 Gonzalez Buenrostro, Ana, 1409 Pershing Avenue, San Mateo, CA 94403, US
 Beck, Hilary Place, 115 Springdale Way, Emerald Hills, CA 94062, US
 Chen, Xiaoqi, 970 Blair Court, Palo Alto, CA 94303, US
 Connors, Richard Victor, 935 Crespi Drive, Pacifica, CA 94044, US
 Deignan, Jeffrey, 500 29th Street, San Francisco, CA 94131, US
 Duquette, Jason A., 460 Bayview Avenue, Millbrae, CA 90403, US
 Eksterowicz, John, 1845 Church Street, San Francisco, CA 94131, US
 Fisher, Benjamin, 1020 Yates Way Apt. 313, San Mateo, CA 94403, US
 Fox, Brian Matthew, 124 Swallowtail Court, Brisbane, CA 94005, US

Fu, Jiasheng, 221 Pelican Court, Foster City, CA 94404, US
 Fu, Zice, 788 Santa Maria Lane, Foster City, CA 94404, US
 Gonzalez Lopez de Turiso, Felix, 10 De Sabla Road Apt. 509, San Mateo, CA 94402, US
 Gribble, Jr., Michael William, 11 Walter Terrace, Abt. One, Somerville, MA 02145, US
 Gustin, Darin James, 433 Kehoe Avenue, Half Moon, CA 94019, US
 Heath, Julie Anne, 6 Ivy Drive, Orinda, CA 94563, US
 Huang, Xin, 16 Abbott Road, Wellesly, MA 02481, US
 Jiao, Xianjun, 2603 All View Way, Belmont, CA 94002, US
 Johnson, Michael, 409 Clipper Street, San Francisco, CA 94114, US
 Kayser, Frank, 4150, 17th Street, Apt. 25, San Francisco, CA 94114, US
 Kopecky, David John, 548 Brannan Street 200, San Francisco, CA 94107, US
 Lai, Sujen, 1439 Floribunda Avenue 15, Burlingame, CA 94010, US
 Li, Yihong, 821 Taylor Boulevard, Millbrae, CA 94030, US
 Li, Zhihong, 467 Anita Drive, Millbrae, CA 94030, US
 Liu, Jiwen, 250 Trysail Court, Foster City, CA 94404, US
 Low, Jonathan Dante, 18644 Clark Street 5, Tarzana, CA 91356, US
 Lucas, Brian Stuart, 133 10th Avenue, San Francisco, CA 94118, US
 Ma, Zhihua, 733 Celestial Lane, Foster City, CA 94404, US
 McGee, Lawrence R., 39 Big Sur Way, Pacifica, CA 94044, US
 McIntosh, Joel, 540 Fremont Avenue, Pacifica, CA 94044, US
 McMinn, Dustin, 255 Kent Road, Pacifica, CA 94044, US
 Medina, Julio Cesar, 1407 Cedar Street, San Carlos, CA 94070, US
 Mihalic, Jeffrey Thomas, 300 3rd Street 523, San Francisco, CA 94107, US
 Olson, Steven Howard, 406 Green Hills Drive, Millbrae, CA 94030, US
 Rew, Yosup, 828 Juno Lane, Foster City, CA 94404, US
 Roveto, Philip Marley, 500 29th Street, San Francisco, CA 94131, US
 Sun, Daqing, 804 Cortez Lane, Foster City, CA 94404, US
 Wang, Xiaodong, 821 Taylor Boulevard, Millbrae, CA 94030, US
 Wang, Yingcai, 860 Helen Drive, Millbrae, CA 94030, US
 Yan, Xuelei, 1120 Nimitz Lane, Foster City, CA 94404, US
 Yu, Ming, 42 Williams Lane, Foster City, CA 94404, US
 Zhu, Jiang, 747 Coastland Drive, Palo Alto, CA 94303, US

(51) MKP
A61K 39/00 2006 (97) EP 3485903
A61P 35/00 2006
C07K 16/00 2006
C12P 21/08 2006
 (96) EP 18197338.9 9/24/2012
 (97) EP 3485903, 1/1/2020 202001, en
 (31) 201161538454 P (32) 23.09.2011 (33) US
 201261597409 P 10.02.2012 US
 201261692978 P 24.08.2012 US
 (54) VEGF/DLL4 BINDING AGENTS AND USES THEREOF
 (72) GURNEY, Austin L., 946 Diamond Street, San Francisco, CA California 94114, US
 SATO, Aaron Ken, 1640 Coronado Way, Burlingame, CA California 94010, US
 BOND, Christopher John, 511 30th Avenue, San Mateo, CA California 94403, US

(51) MKP
A61F 13/00 2006 (97) EP 3461465
 (96) EP 18197746.3 9/28/2018
 (97) EP 3461465, 11/13/2019 201946, en
 (31) 201762565631 P (32) 29.09.2017 (33) US
 (54) EXTENSIBLE DRESSINGS
 (72) CETTINA, Melinda, 199 Grandview Road, Skillman, NJ New Jersey 08558, US
 ORIANI, Paulo G., Rod. Presidente Dutra KM 154 Sao Jose dos Campos, 12240-907 Sao Paulo, BR

(51) MKP
A43B 1/04 2006 (97) EP 3470563
D04B 1/10 2006
D04B 1/22 2006
 (96) EP 18197769.5 9/28/2018
 (97) EP 3470563, 11/6/2019 201945, en
 (31) 201700109721 (32) 03.10.2017 (33) IT

- (54) METHOD FOR PRODUCING A CRIMPED UPPER
 (71) Vueffe Studio SRL, Via Montello, 1 Noventa Padovana, 35027 Padova, IT
 (72) TURAZZI, Filippo, Via A. Diaz, 411 Frassinelle Polesine, 45030 Rovigo, IT
 BOMBARDA, Marco, Via Boschetta, 10/B Rubano, 35030 Padova, IT

- (51) MKP
A61K 38/00 2006 (97) EP 3485901
A61K 38/39 2006
A61K 39/395 2006
A61K 45/06 2006
A61P 35/00 2006
C07K 14/78 2006
C07K 16/28 2006
 (96) EP 18197990.7 11/21/2013
 (97) EP 3485901, 1/1/2020 202001, en
 (31) 201261728906 P (32) 21.11.2012 (33) US
 201261728914 P 21.11.2012 US
 201261728912 P 21.11.2012 US
 201361782550 P 14.03.2013 US
 201361809541 P 08.04.2013 US
 (54) EGFR AND C-MET-FIBRONECTIN TYPE III DOMAIN BINDING MOLECULES
 (72) ANDERSON, Mark, 1400 McKean Road, Spring House, PA Pennsylvania 19477, US
 ATTAR, Ricardo, 1400 McKean Road, Spring House, PA Pennsylvania 19477, US
 DIEM, Michael, 1400 McKean Road, Spring House, PA Pennsylvania 19477, US
 HYUN, Linus, 1400 McKean Road, Spring House, PA Pennsylvania 19477, US
 JACOBS, Steven, 1400 McKean Road, Spring House, PA Pennsylvania 19477, US
 KING, Alastair, 1400 McKean Road, Spring House, PA Pennsylvania 19477, US
 KLEIN, Donna, 1400 McKean Road, Spring House, PA Pennsylvania 19477, US
 MOORES, Sheri, 1400 McKean Road, Spring House, PA Pennsylvania 19477, US
 O'NEIL, Karyn, 800/850 Ridgeview Drive, Horsham, PA 19044, US
 PICHA, Kristen, 1400 McKean Road, Spring House, PA Pennsylvania 19477, US

- (51) MKP
H04B 1/69 2011 (97) EP 3468051
H04J 13/18 2011
H04L 5/00 2006
 (96) EP 18198124.2 10/2/2018
 (97) EP 3468051, 10/23/2019 201943, en
 (31) 201700111602 (32) 05.10.2017 (33) IT
 (54) SYSTEM AND METHOD FOR OPTIMISING THE USE OF THE RADIO SPECTRUM AS A FUNCTION OF THE AIR TRANSMISSION TIMES
 (71) Unidata S.p.A., Viale Alexandre Gustave Eiffel 100, 00148 Roma (RM), IT
 (72) BIANCHI, Giuseppe, Via di Priscilla 35/1, 00199 ROMA (RM), IT
 CAMPO, Manuel, Via Trapani n. 7, 00019 TIVOLI (RM), IT
 CAPONI, Alberto, Via Alberto Sordi 6, 03100 Frosinone (FR), IT
 CUOMO, Francesca, Largo Dell'Olgiate n. 15, 00123 ROMA (RM), IT
 PISANI, Patrizio, Via del Forte Boccea, 115, 00167 ROMA (RM), IT
 ROSSINI, Giampaolo, Via Norvegia 16, 00041 ALBANO LAZIALE (RM), IT

- (51) MKP
A61K 31/444 2006 (97) EP 3461483
A61K 31/497 2006
A61P 25/28 2006
C07D 401/12 2006
 (96) EP 18198764.5 11/9/2015
 (97) EP 3461483, 11/13/2019 201946, en
 (31) PA201400648 (32) 10.11.2014 (33) DK
 PA201500447 07.08.2015 DK
 (54) SOLID DOSAGE FORMS OF 2-AMINO-6-(DIFLUOROMETHYL)-5,5-DIFLUORO-6-PHENYL-3,4,5,6- TETRAHYDROPYRIDINE BACE1
 INHIBITORS
 (72) JUHL, Karsten, c/o H. Lundbeck A/S Ottiliavej 9, 2500 Valby, DK
 TAGMOSE, Lena, c/o H. Lundbeck A/S Ottiliavej 9, 2500 Valby, DK
 MARIGO, Mauro, c/o H. Lundbeck A/S Ottiliavej 9, 2500 Valby, DK

(51) MKP
A23D 7/00 2006 (97) EP 3466278
A23L 9/20 2016
A23L 33/115 2016
C11C 3/10 2006
(96) EP 18198937.7 10/5/2018
(97) EP 3466278, 11/13/2019 201946, en
(31) 201700112612 (32) 06.10.2017 (33) IT
(54) IMITATION WHIPPING CREAM
(72) CESARI, Riccardo, c/o UNIGRA' S.R.L. Via Gardizza 9/B, 48017 CONSELICE (RA), IT
GHERARDI, Alessandro, c/o UNIGRA' S.R.L. Via Gardizza 9/B, 48017 CONSELICE (RA), IT
FUSARI, Massimo, c/o UNIGRA' S.R.L. Via Gardizza 9/B, 48017 CONSELICE (RA), IT
GRAMIGNA, Lucia, c/o UNIGRA' S.R.L. Via Gardizza 9/B, 48017 CONSELICE (RA), IT

(51) MKP
A61K 39/00 2006 (97) EP 3456346
A61K 39/395 2006
C07K 16/28 2006
(96) EP 18199685.1 7/28/2016
(97) EP 3456346, 10/30/2019 201944, en
(31) 201562198867 P (32) 30.07.2015 (33) US
201562239559 P 09.10.2015 US
201562255140 P 13.11.2015 US
201662322974 P 15.04.2016 US
(54) PD-1 AND LAG-3 BINDING MOLECULES AND METHODS OF USE THEREOF
(72) SHAH, Kalpana, 13013 Ethel Rose Way, Boyds, MD 20841, US
SMITH, Douglas, H., 429 W. Hillsdale Boulevard, San Mateo, CA 94403, US
LA MOTTE-MOHS, Ross, 16000 Schaeffer Road, Boyds, MD 20841, US
JOHNSON, Leslie, S., 14411 Poplar Hill Road, Darnestown, MD 20874, US
MOORE, Paul, A., 10 Turley Court, North Potomac, MD 20878, US
BONVINI, Ezio, 11136 Powder Horn Drive, Potomac, MD 20854, US
KOENIG, Scott, 10901 Ralston Road, Rockville, MD 20852, US

(51) MKP
A61K 39/395 2006 (97) EP 3450458
A61P 29/00 2006
C07K 16/28 2006
(96) EP 18200535.5 8/21/2013
(97) EP 3450458, 10/16/2019 201942, en
(31) 201261692029 P (32) 22.08.2012 (33) US
(54) HUMAN ANTIBODIES TO GFR 3 AND METHODS OF USE THEREOF
(72) CROLL, Susan, D., 176 Bell Hollow Road, Unit 3, Putnam, NY 10579, US
MACDONALD, Lynn, 16 Gedney Way, White Plains, NY 10605, US
MURPHY, Andrew, J., 10 Newton Court, Croton-on-Hudson, NY 10520, US

(51) MKP
A61K 39/00 2006 (97) EP 3480316
C12N 15/867 2006
(96) EP 18200744.3 3/29/2013
(97) EP 3480316, 12/18/2019 201951, en
(31) 201213436472 (32) 30.03.2012 (33) US
201261666103 P 29.06.2012 US
201261732756 P 03.12.2012 US
201361789575 P 15.03.2013 US
(54) LENTIVIRAL VECTOR PARTICLES HAVING IMPROVED TRANSDUCTION EFFICIENCY FOR CELLS EXPRESSING DC-SIGN
(72) NICOLAI, Christopher, James, 1442 N.W. 63rd Street Apt. 102, Seattle, WA 98107, US
TAREEN, Semih, 1616 Eastlake Ave. E. Suite 310, Seattle, WA 98102, US

(51) MKP
C07F 9/40 2006 (97) EP 3450438
C07F 9/44 2006
C07H 19/20 2006
(96) EP 18200819.3 5/18/2012

(97) EP 3450438, 10/16/2019 201942, en
 (31) 201161488133 P (32) 19.05.2011 (33) US
 (54) PROCESSES AND INTERMEDIATES FOR PREPARING ANTI-HIV AGENTS
 (72) YU, Richard Hung Chiu, 2625 35th Avenue, San Francisco, CA 94116, US
 BROWN, Brandon Heath, 7221 Spring Creek Circle, Niwot, Colorado 80503, US
 POLNIASZEK, Richard P., 2904 Alameda Avenue, Half Moon Bay, CA 94019, US
 GRAETZ, Benjamin R., 2925 Isabelle Avenue, San Mateo, CA 94403, US
 SUJINO, Keiko, 9647 80 Avenue, Edmonton, Alberta T6C0V2, CA
 TRAN, Duong Duc-Phi, 3207 23 Street, Edmonton, Alberta T6T2A9, CA
 TRIMAN, Alan Scott, 978 Bellomo Avenue, Apt. D, Sunnyvale, CA 94086, US
 KENT, Kenneth M., 844 Gladiola Drive, Sunnyvale, CA 94086, US
 PFEIFFER, Steven, 46421 Canyon Crest Ct., Temecula, CA 92592, US

(51) MKP
A23L 29/00 2016 (97) EP 3476388
A23L 33/10 2016
A61K 9/16 2006
A61K 31/122 2006
 (96) EP 18201332.6 10/18/2018
 (97) EP 3476388, 11/27/2019 201948, en
 (31) 201700120582 (32) 24.10.2017 (33) IT
 201800003503 13.03.2018 IT
 (54) COMPOSITION COMPRISING COENZYME Q10 AND PIPERINE
 (71) Difass International S.r.l., Via Ausa, 181 Loc. Cerasolo, 47853 Coriano (RN), IT
 (72) MARINI, Daniele, c/o DIFASS INTERNATIONAL S.R.L. Via Ausa, 181 - Loc. Cerasolo, 47853 CORIANO (RN), IT
 GIORGINI, Davide, Via Ribano Canonica, 863, 47039 SAVIGNANO SUL RUBICONE (FC), IT
 AGOSTINI, Alida, c/o DIFASS INTERNATIONAL S.R.L. Via Ausa, 181 - Loc. Cerasolo, 47853 CORIANO (RN), IT

(51) MKP
A61K 31/70 2006 (97) EP 3466431
C07D 317/26 2006
 (96) EP 18201632.9 3/10/2014
 (97) EP 3466431, 11/20/2019 201947, en
 (31) 201361783128 P (32) 14.03.2013 (33) US
 201361887504 P 07.10.2013 US
 201361912252 P 05.12.2013 US
 (54) CRYSTALLINE FORMS AND METHODS FOR PREPARING SGLT2 INHIBITORS
 (72) Brenek, Steven J., 235 East 42nd Street, New York, NY 10017, US
 Caron, Stephanie, 235 East 42nd Street, New York, NY 10017, US
 Nelson, Jade D., 235 East 42nd Street, New York, NY 10017, US
 Webster, Mark, E., 235 East 42nd Street, New York, NY 10017, US
 Weekly, Rodney Matthew, 235 East 42nd Street, New York, NY 10017, US

(51) MKP
C07H 21/04 2006 (97) EP 3466960
C12N 15/11 2006
 (96) EP 18201757.4 3/30/2012
 (97) EP 3466960, 12/4/2019 201949, en
 (31) 201161471001 P (32) 01.04.2011 (33) US
 201161471045 P 01.04.2011 US
 201161471035 P 01.04.2011 US
 201161471015 P 01.04.2011 US
 201161558308 P 10.11.2011 US
 201161558316 P 10.11.2011 US
 (54) MODULATION OF SIGNAL TRANSDUCER AND ACTIVATOR OF TRANSCRIPTION 3 (STAT3) EXPRESSION
 (72) SWAYZE, Eric E., 2855 Gazelle Court, Carlsbad, CA 92010, US
 FREIER, Susan M., 2855 Gazelle Court, Carlsbad, CA 92010, US
 MACLEOD, Robert A., 2855 Gazelle Court, Carlsbad, CA 92010, US
 KIM, Youngsoo, 2855 Gazelle Court, Carlsbad, CA 92010, US

(51) MKP
A23C 9/152 2006 (97) EP 3456386
A23L 33/135 2016

	A61K 9/19	2006					
	A61K 31/00	2006					
	A61K 35/74	2015					
	A61K 39/00	2006					
	A61K 39/08	2006					
	A61P 11/06	2006					
	A61P 19/00	2006					
	A61P 27/02	2006					
	A61P 29/00	2006					
(96)	EP 18202101.4 11/23/2016						
(97)	EP 3456386, 10/30/2019 201944, en						
(31)	201520631		(32)	23.11.2015		(33)	GB
(54)	COMPOSITIONS COMPRISING BACTERIAL STRAINS						
(72)	MULDER, Imke Elisabeth, c/o 4D Pharma Research Limited Life Sciences Innovation Building Cornhill Road, Aberdeen, aberdeenshire AB25 2ZS, GB						
	HOLT, Amy Beth, c/o 4D Pharma Research Limited Life Sciences Innovation Building Cornhill Road, Aberdeen, Aberdeenshire AB25 2ZS, GB						
	MCCLUSKEY, Seanin Marie, c/o 4D Pharma Research Limited Life Sciences Innovation Building Cornhill Road, Aberdeen, Aberdeenshire AB25 2ZS, GB						
	LENNON, Grainne Clare, c/o 4D Pharma Research Limited Life Sciences Innovation Building Cornhill Road, Aberdeen, Aberdeenshire AB25 2ZS, GB						
	AHMED, Suaad, c/o 4D Pharma Research Limited Life Sciences Innovation Building Cornhill Road, Aberdeen, Aberdeenshire AB25 2ZS, GB						
<hr/>							
(51)	MKP						
	A61K 31/497	2006	(97)	EP 3492455			
	A61P 35/00	2006					
	C07D 249/08	2006					
	C07D 401/06	2006					
	C07D 403/06	2006					
	C07D 405/06	2006					
	C07D 413/06	2006					
	C07D 417/06	2006					
(96)	EP 18202641.9 6/20/2014						
(97)	EP 3492455, 1/8/2020 202002, en						
(31)	201361838172 P		(32)	21.06.2013		(33)	US
(54)	1,2,4-TRIAZOLES AS NUCLEAR TRANSPORT MODULATORS AND USE IN THE TREATMENT OF SPECIFIC FORMS OF CANCER						
(71)	Karyopharm Therapeutics Inc., 85 Wells Avenue, Newton, MA 02459, US						
(72)	BALOGLU, Erkan, 8 Benjamin Terrace, Stoneham, MA 02180, US						
	SHACHAM, Sharon, 145 Hagen Road, Newton, MA 02459, US						
	MCCAULEY, Dilara, 49 Brantwood Road, Arlington, MA 02476, US						
	KASHYAP, Trinayan, 65 Auburn Street, Apt. 8, Framingham, MA 01701, US						
	SENAPEDIS, William, 34 Timberline Road, Millis, MA 02054, US						
	LANDESMAN, Yosef, 260 Tappan Street, Brookline, MA 02445, US						
	GOLAN, Gali, 192 Har Yeela Street, 99770 Mesilat Zion, IL						
	KALID, Ori, Dror 30/2, 37025 Pardes Hanna, IL						
	SHECHTER, Sharon, 18 Ivy Lane, Andover, MA 01810, US						
<hr/>							
(51)	MKP						
	A01K 67/027	2006	(97)	EP 3456832			
	C07K 16/00	2006					
	C07K 16/18	2006					
	C07K 16/46	2006					
	C12N 15/10	2006					
	C12N 15/85	2006					
(96)	EP 18202954.6 6/22/2011						
(97)	EP 3456832, 10/30/2019 201944, en						
(31)	35731710 P		(32)	22.06.2010		(33)	US
	35731410 P			22.06.2010			US
(54)	MICE EXPRESSING AN IMMUNOGLOBULIN HYBRID LIGHT CHAIN						
(72)	MACDONALD, Lynn, 16 Gedney Way, White Plains, NY 10605, US						
	STEVENS, Sean, 355 Berry Street, 413, San Francisco, CA 94158, US						
	GURER, Cagan, 8 Pamela Lane, Valhalla, NY 10595, US						
	MURPHY, Andrew J., 10 Newton Court, Croton-on-Hudson, NY 10520, US						
	HOSIAWA, Karolina A., 211 Benjamin Boulevard, Yorktown Heights, NY 10598, US						

- (51) MKP
A61K 31/4985 2006 (97) EP 3495368
A61P 19/08 2006
A61P 29/00 2006
A61P 31/00 2006
A61P 35/00 2006
A61P 37/00 2006
C07D 487/04 2006
C07D 519/00 2006
- (96) EP 18203086.6 7/11/2012
(97) EP 3495368, 1/15/2020 202003, en
- (31) 201161509397 P (32) 19.07.2011 (33) US
11174578 19.07.2011 EP
- (54) (S)-4-(8-AMINO-3-(1-(BUT-2-YNOYL)PYRROLIDIN-2-YL)IMIDAZO[1,5-A]PYRAZIN-1-YL)-2-METHOXY-N-(PYRIDIN-2-YL)BENZAMIDE AS BTK-INHIBITOR
- (72) BARF, Tjeerd A., St. Luciastraat 7, 5371 AS Ravenstein, NL
JANS, Christiaan Gerardus Johannes Maria, Heggerank 134, 5342 CC Cuijk, NL
de MAN, Andrianus Petrus Antonius, N.V. Organon H.W. Van Heelstraat 4, 5327 AH Hurwenen, NL
OUBRIE, Arthur A., Saltshof 1106, 6604 EB Wijchen, NL
RAAIJMAKERS, Hans C.A., Eikakkerhoven 26, 5242 KK Eindhoven, NL
REWINKEL, Johannes Bernardus Maria, Molenweg 16, 5351 EV Berghem, NL
STERRENBURG, Jan-Gerard, Grote Omloop 18, 6871 TE Renkum, NL
WUKMANS, Jacobus, N.V. Organon, OSS, 5345 LR Hurwenen, NL
-

- (51) MKP
A61P 21/00 2006 (97) EP 3498857
C07H 21/04 2006
C07K 16/00 2006
C12P 21/08 2006
- (96) EP 18203126.0 6/11/2013
(97) EP 3498857, 1/1/2020 202001, en
- (31) 201261658237 P (32) 11.06.2012 (33) US
- (54) DUAL RECEPTOR ANTAGONISTIC ANTIGEN-BINDING PROTEINS AND USES THEREOF
- (72) HAN, Huiquan, C/o Amgen Inc. One Amgen Center Drive, Thousand Oaks, CA 91320-1799, US
ZHOU, Xiaolan, C/o Amgen Inc. One Amgen Center Drive, Thousand Oaks, CA 91320-1799, US
CHEN, Qing, C/o Amgen Inc. One Amgen Center Drive, Thousand Oaks, CA 91320-1799, US
TSAI, Mei-Mei, C/o Amgen Inc. One Amgen Center Drive, Thousand Oaks, CA 91320-1799, US
-

- (51) MKP
C07D 209/08 2006 (97) EP 3492474
C07D 403/12 2006
C07D 498/04 2006
- (96) EP 18203369.6 11/22/2013
(97) EP 3492474, 11/6/2019 201945, en
- (31) 3593DE2012 (32) 23.11.2012 (33) IN
750DE2013 14.03.2013 IN
3172DE2013 25.10.2013 IN
- (54) INTERMEDIATES USED IN THE PRODUCTION OF DIACYLGLYCEROL ACYLTRANSFERASE INHIBITORS
- (72) CHEUNG, Mui, 709 Swedeland Road, King Of Prussia, PA 19406, US
TANGIRALA, Raghuram, S., 10-3-133 Teachers Colony East Marredpally, 500 026 Secunderabad, IN
-

- (51) MKP
C07D 401/14 2006 (97) EP 3489239
C07D 487/04 2006
C07F 5/04 2006
- (96) EP 18204165.7 3/5/2014
(97) EP 3489239, 1/1/2020 202001, en
- (31) 201361773659 P (32) 06.03.2013 (33) US
- (54) PROCESSES AND INTERMEDIATES FOR MAKING A JAK INHIBITOR
- (72) LIU, Pingli, 205 Pilot Court, Newark, DE 19702, US
WANG, Dengjin, 2205 F Prior Road, Wilmington, DE 19809, US
WU, Yongzhong, 2 Robert Court, Chadds Ford, PA 19317, US
CAO, Ganfeng, 10 Shadow Lane, Chadds Ford, PA 19317, US
XIA, Michael, 304 Clubhouse Lane, Wilmington, DE 19810, US

(51) MKP
A61B 17/072 2006 (97) EP 3479780

(96) EP 18204373.7 11/5/2018
 (97) EP 3479780, 12/18/2019 201951, en
 (31) 201715804280 (32) 06.11.2017 (33) US

(54) MULTI-LAYER TISSUE THICKNESS COMPENSATOR COMPRISING RESILIENT AND SACRIFICIAL COLLAPSIBLE LAYERS
 (72) KRIKSUNOV, Leo B., U.S. Route 22, Somerville, NJ 08876, US
 TANNHAUSER, Robert J., U.S. Route 22, Somerville, NJ 08876, US

(51) MKP
A61K 31/4545 2006 (97) EP 3473619
A61P 35/00 2006
C07D 401/14 2006

(96) EP 18204389.3 11/6/2015
 (97) EP 3473619, 12/4/2019 201949, en
 (31) 201462079742 P (32) 14.11.2014 (33) US

(54) AURORA A KINASE INHIBITOR
 (72) Henry, James Robert, c/o Eli Lilly and Company P.O. Box 6288, Indianapolis, 46206-6288, US

(51) MKP
B01D 11/02 2006 (97) EP 3482808
B01D 11/04 2006
B01D 24/00 2006
B01D 29/56 2006
B01D 35/18 2006

(96) EP 18204438.8 11/5/2018
 (97) EP 3482808, 12/25/2019 201952, en
 (31) 201715809980 (32) 10.11.2017 (33) US

(54) CLOSED-LOOP MULTI-STAGE CHILLED FILTER SYSTEM
 (71) NextLeaf Solutions Ltd., 304-68 Water Street, Vancouver, British Columbia V6B 1A4, CA
 (72) Delmoral KO, Ryan, c/o 68 Schooner Street Unit 3, Coquitlam, British Columbia V3K 7B1, CA

(51) MKP
F25B 9/00 2006 (97) EP 3483529
F25B 31/00 2006
F25B 49/00 2006

(96) EP 18205135.9 11/8/2018
 (97) EP 3483529, 12/25/2019 201952, en
 (31) 201700128009 (32) 09.11.2017 (33) IT

(54) LUBRICANT MONITORING SYSTEM FOR A CIRCUIT COMPRESSOR
 (71) Rivacold S.R.L., Via Sicilia 7 Fraz. Montecchio, 61022 Vallefoglia (PU), IT
 (72) VITRI, Giuseppe, Via Carducci, 7, 61020 MONTECALVO IN FOGLIA (PU), IT
 SCAVOLINI, Giampietro, Via Valentini, 10, 61122 PERSARO (PU), IT

(51) MKP
C12N 15/10 2006 (97) EP 3467108

(96) EP 18205176.3 3/14/2014
 (97) EP 3467108, 11/13/2019 201946, en
 (31) 201361784996 P (32) 14.03.2013 (33) US

(54) METHODS FOR PURIFICATION OF MESSENGER RNA
 (72) HEARTLEIN, Michael, c/o Shire Human Genetic Therapies Inc. 300 Shire Way, Lexington, MA 02421, US
 DEROSA, Frank, c/o Shire Human Genetic Therapies Inc. 300 Shire Way, Lexington, MA 02421, US
 DIAS, Anusha, c/o Shire Human Genetic Therapies Inc. 300 Shire Way, Lexington, MA 02421, US
 KARVE, Shirang, c/o Shire Human Genetic Therapies Inc. 300 Shire Way, Lexington, MA 02421, US

(51) MKP
A47C 1/032 2006 (97) EP 3476254
A47C 7/02 2006

(96) EP 17198337.2 10/25/2017

- (97) EP 3476254, 12/11/2019 201950, de
 (54) SEATING FURNITURE, IN PARTICULAR AN OFFICE CHAIR
 (72) Ehrenleitner, Franz, Sommerhalde 36, 72213 Altensteig-Walddorf, DE

- (51) MKP
C09D 5/33 2006 (97) EP 3555218
C09D 133/02 2006
C09D 201/00 2006
E01B 19/00 2006

- (96) EP 17832730.0 11/14/2017
 (97) EP 3555218, 10/23/2019 201943, de
 (31) 102016121807 (32) 14.11.2016 (33) DE

- (54) COATING REFLECTING SOLAR RADIATION, AND USE THEREOF
 (71) Joint Stock Company Railway Research Institute, 3rd Mytishchinskaya Street 10, Moskau 129626, RU
 (72) SCHMAL, Eugen, Seestücken 20c, 21077 Hamburg, DE
 LAPIDUS, Boris Moiseevich, c/o JSC Railway Research Institute 3rd Mytishchinskaya Street 10, Moskau 129626, RU
 SUSLOV, Oleg Aleksandrovich, c/o JSC Railway Research Institute 3rd Mytishchinskaya Street 10, Moskau 129626, RU
 KOSAREV, Aleksandr Borisovich, c/o JSC Railway Research Institute 3rd Mytishchinskaya Street 10, Moskau 129626, RU

- (51) MKP
A61K 39/395 2006 (97) EP 3558364
A61P 25/28 2006
C07K 16/18 2006

- (96) EP 17832954.6 12/21/2017
 (97) EP 3558364, 10/30/2019 201944, en
 (31) PA201600782 (32) 22.12.2016 (33) DK
 PA201700016 05.01.2017 DK

- (54) MONOCLONAL ANTI-ALPHA-SYNUCLEIN ANTIBODIES FOR PREVENTING TAU AGGREGATION
 (72) FOG, Karina, c/o H. Lundbeck A/S Ottiliavej 9, 2500 Valby, DK
 PEDERSEN, Jeppe, Falsig, c/o H. Lundbeck A/S Ottiliavej 9, 2500 Valby, DK

- (51) MKP
A61K 31/427 2006 (97) EP 3558987
A61P 31/04 2006
C07D 417/12 2006

- (96) EP 17832956.1 12/21/2017
 (97) EP 3558987, 10/30/2019 201944, en
 (31) 16205800 (32) 21.12.2016 (33) EP

- (54) COMBINATION THERAPY WITH AMIDINE SUBSTITUTED β -LACTAM COMPOUNDS AND β -LACTAMASE INHIBITORS FOR INFECTIONS WITH ANTIBIOTIC RESISTANT BACTERIAL STRAINS
 (72) WIEGAND, Irith, Sandstr. 5, 41564 Kaarst, DE
 VUONG, Cuong, Westfalenweg 267A, 42117 Wuppertal, DE
 RAUSCH, Daniela M., Klingelholl 53, 42281 Wuppertal, DE

- (51) MKP
A61K 39/00 2006 (97) EP 3559037
C07K 16/28 2006

- (96) EP 17833041.1 12/19/2017
 (97) EP 3559037, 10/30/2019 201944, en
 (31) 201662438227 P (32) 22.12.2016 (33) US

- (54) SIRP-GAMMA TARGETED AGENTS FOR USE IN THE TREATMENT OF CANCER
 (72) LIN, Hui-Kuan, 5623 Addlestone Road, Winston-Salem, North Carolina 27106, US
 XU, Chuan, 377-19-62 Jucui Street Wuhou, Chengdu 610041, CN
 BIAN, Xiu-Wu, 70-1-2 Gaotanyan Street 30 Shapingba District, Chongqing 400038, CN
 HAIGH MOLINA, Sarah, 4226 Allistair Road, Winston-Salem, North Carolina 27104, US
 FURTH, Mark, 3621 Sweeten Creek Road, Chapel Hill, North Carolina 27514, US

- (51) MKP
A61K 38/10 2006 (97) EP 3558337
A61K 47/32 2006
A61P 1/10 2006

- (96) EP 17833050.2 12/21/2017

(97) EP 3558337, 10/30/2019 201944, en
 (31) 201662437566 P (32) 21.12.2016 (33) US
 (54) METHODS OF TREATING IRRITABLE BOWEL SYNDROME WITH MODIFIED OR DELAYED RELEASE FORMULATIONS OF LINACLOTIDE
 (72) HASHASH, Ahmad, 5 Oland Lane, Southborough, MA 01772, US

(51) MKP
A23L 33/175 2016 (97) EP 3554493
A23L 33/18 2016
A61K 31/198 2006
A61P 21/00 2006
A61P 21/06 2006

(96) EP 17835529.3 12/19/2017
 (97) EP 3554493, 10/23/2019 201943, en
 (31) 201662436073 P (32) 19.12.2016 (33) US
 201762443205 P 06.01.2017 US
 201762491776 P 28.04.2017 US
 201762545358 P 14.08.2017 US
 201762576321 P 24.10.2017 US

(54) AMINO ACID COMPOSITIONS AND METHODS FOR THE TREATMENT OF MUSCLE DISEASES AND DISORDERS
 (71) Axcella Health Inc., 840 Memorial Drive, 3rd Floor, Cambridge, MA 02139, US
 (72) HAMILL, Michael, C/o Axcella Health Inc. 840 Memorial Drive 3rd Floor, Cambridge MA 02139, US
 AFEYAN, Raffi, C/o Axcella Health Inc. 840 Memorial Drive 3rd Floor, Cambridge MA 02139, US
 COMB, William, C/o Axcella Health Inc. 840 Memorial Drive 3rd Floor, Cambridge MA 02139, US

(51) MKP
A61K 39/00 2006 (97) EP 3558365
A61K 39/395 2006
A61P 35/00 2006
C07K 16/28 2006
G01N 33/53 2006

(96) EP 17835532.7 12/21/2017
 (97) EP 3558365, 10/30/2019 201944, en
 (31) 201662438733 P (32) 23.12.2016 (33) US

(54) ANTI-NEUROFILIN ANTIGEN-BINDING PROTEINS AND METHODS OF USE THEREOF
 (72) HICKLIN, Daniel, c/o Potenza Therapeutics Inc. 1030 Massachusetts Avenue Suite 210, Cambridge, MA 02138, US
 SEIDEL-DUGAN, Cynthia, c/o Potenza Therapeutics Inc. 1030 Massachusetts Avenue Suite 210, Cambridge, MA 02138, US
 WINSTON, William, c/o Potenza Therapeutics Inc. 1030 Massachusetts Avenue Suite 210, Cambridge, MA 02138, US
 SALMERON-GARCIA, Jose-Andres, c/o Potenza Therapeutics Inc. 1030 Massachusetts Avenue Suite 210, Cambridge, MA 02138, US
 NIELSON, Nels, P., c/o Potenza Therapeutics Inc. 1030 Massachusetts Avenue Suite 210, Cambridge, MA 02138, US
 BRODKIN, Heather, c/o Potenza Therapeutics Inc. 1030 Massachusetts Avenue Suite 210, Cambridge, MA 02138, US

(51) MKP
A61K 47/68 2017 (97) EP 3558391
A61P 35/00 2006
C07K 16/28 2006
C07K 16/30 2006
C07K 16/40 2006

(96) EP 17835533.5 12/21/2017
 (97) EP 3558391, 10/30/2019 201944, en
 (31) 201662438488 P (32) 23.12.2016 (33) US
 201762480201 P 31.03.2017 US

(54) IMMUNOCONJUGATES TARGETING ADAM9 AND METHODS OF USE THEREOF
 (72) HICKS, Stuart William, 415 Massachusetts Avenue, North Andover, MA 01845, US
 YODER, Nicholas C., 20 Egmont Street, 6, Brookline, MA 02446, US
 BARAT, Bhaswati, 15504 Villisca Terrace, Derwood, MD 20855, US
 BONVINI, Ezio, 11136 Powder Horn Drive, Potomac, Maryland 20854, US
 DIEDRICH, Gundo, 13409 Bonnie Dale Drive, North Potomac, MD 20878, US
 JOHNSON, Leslie S., 14411 Poplar Hill Road, Darnestown, MD 20874, US
 LOO, Deryk, 1509 Pine Knoll Drive, Belmont, CA 94002, US
 SCRIBNER, Juniper A., 1217 Oak Grove Avenue Apt. 4, Burlingame, CA 94010, US

(51) MKP

A61P 37/00 2006 (97) EP 3551664
C07K 16/28 2006
 (96) EP 17835592.1 12/7/2017
 (97) EP 3551664, 10/16/2019 201942, en
 (31) 16306655 (32) 09.12.2016 (33) EP
 (54) ANTIBODIES AND POLYPEPTIDES DIRECTED AGAINST CD127
 (72) POIRIER, Nicolas, 1 chemin du Passe-Temps, 44119 Treillieres, FR
 MARY, Caroline, 7 rue du Buisson, 44680 Sainte-Pazanne, FR
 VANHOVE, Bernard, 72 bis rue Henri Barbusse, 44400 Reze, FR
 THEPENIER, Virginie, 45 rue de la feuillette, 44680 Sainte Pazanne, FR

(51) MKP
A61P 25/16 2006 (97) EP 3555127
C07K 16/18 2006
 (96) EP 17835611.9 12/14/2017
 (97) EP 3555127, 10/23/2019 201943, en
 (31) PA201600769 (32) 16.12.2016 (33) DK
 (54) AGENTS, USES AND METHODS
 (72) KALLUNKI, Pekka, c/o H. Lundbeck A/S Ottiliavej 9, 2500 Valby, DK
 FOG, Karina, c/o H. Lundbeck A/S Ottiliavej 9, 2500 Valby, DK

(51) MKP
A61K 31/437 2006 (97) EP 3558990
A61P 35/00 2006
A61P 37/00 2006
C07D 471/04 2006
 (96) EP 17835760.4 12/21/2017
 (97) EP 3558990, 10/30/2019 201944, en
 (31) 201662437998 P (32) 22.12.2016 (33) US
 201662438038 P 22.12.2016 US
 201662438020 P 22.12.2016 US
 201662438009 P 22.12.2016 US
 201662438001 P 22.12.2016 US
 201762487356 P 19.04.2017 US
 201762487457 P 19.04.2017 US
 201762487336 P 19.04.2017 US
 201762487362 P 19.04.2017 US
 201762487341 P 19.04.2017 US
 201762487365 P 19.04.2017 US
 201762551011 P 28.08.2017 US
 201762551033 P 28.08.2017 US
 201762569936 P 09.10.2017 US
 (54) TETRAHYDRO IMIDAZO[4,5-C]PYRIDINE DERIVATIVES AS PD-L1 INTERNALIZATION INDUCERS
 (72) LIU, Phillip C., Incyte Corporation 1801 Augustine Cut-Off, Wilmington, Delaware 19803, US
 VOLGINA, Alla, Incyte Corporation 1801 Augustine Cut-Off, Wilmington, Delaware 19803, US
 WYNN, Richard, Incyte Corporation 1801 Augustine Cut-Off, Wilmington, Delaware 19803, US
 ZOLOTARJOVA, Nina, Incyte Corporation 1801 Augustine Cut-Off, Wilmington, Delaware 19803, US
 WU, Liangxing, Incyte Corporation 1801 Augustine Cut-Off, Wilmington, Delaware 19803, US
 XIAO, Kaijiong, Incyte Corporation 1801 Augustine Cut-Off, Wilmington, Delaware 19803, US
 MEI, Song, Incyte Corporation 1801 Augustine Cut-Off, Wilmington, Delaware 19803, US
 LU, Liang, Incyte Corporation 1801 Augustine Cut-Off, Wilmington, Delaware 19803, US
 ZHU, Wenyu, Incyte Corporation 1801 Augustine Cut-Off, Wilmington, Delaware 19803, US
 YE, Yingda, Incyte Corporation 1801 Augustine Cut-Off, Wilmington, Delaware 19803, US
 WANG, Haisheng, Incyte Corporation 1801 Augustine Cut-Off, Wilmington, Delaware 19803, US
 QIAN, Ding-Quan, Incyte Corporation 1801 Augustine Cut-Off, Wilmington, Delaware 19803, US
 YAO, Wenqing, Incyte Corporation 1801 Augustine Cut-Off, Wilmington, Delaware 19803, US

(51) MKP
A01M 29/28 2011 (97) EP 3550965
 (96) EP 17835805.7 11/30/2017
 (97) EP 3550965, 10/16/2019 201942, de
 (31) 16062016 (32) 06.12.2016 (33) CH
 (54) METHOD AND DEVICE FOR INFLUENCING INSECTS

(71) Nopixglobal AG, Schaffhauserstrasse 16, 8302 Kloten, CH
 (72) STOLL, Kurt, Rietstrasse 30, 8152 Glattbrugg, CH

(51) MKP
A61K 31/4178 2006 (97) EP 3562490
A61K 31/4375 2006
A61K 31/46 2006
A61K 31/506 2006
A61K 31/575 2006
A61P 1/16 2006
A61P 11/00 2006
A61P 13/12 2006

(96) EP 17835977.4 12/28/2017

(97) EP 3562490, 11/6/2019 201945, en

(31) 201662439666 P (32) 28.12.2016 (33) US

(54) COMBINATION THERAPY FOR NONALCOHOLIC STEATOHEPATITIS (NASH) AND LIVER FIBROSIS

(71) Modunex Bio Corp., 3rd Floor J&C Building P.O. Box 933, Road Town, Tortola VG 1110, VG

(72) LAU, Walter, 19 Davis Drive Suite 202, Belmont CA 94002, US

WANG, Christopher, 17 Cody Avenue, Edison NJ 08820, US

SHO, Shonan, 10600 Wilkins Avenue Apt. 2B, Los Angeles CA 90024, US

(51) MKP
C07D 265/30 2006 (97) EP 3558953
C07D 498/04 2006

(96) EP 17836021.0 12/20/2017

(97) EP 3558953, 10/30/2019 201944, en

(31) 201600130642 (32) 23.12.2016 (33) IT

(54) METHOD FOR THE MANUFACTURING OF 2-(3-(ALKYL AND ALKENYL)MORPHOLINO)-ETHAN-1-OLS

(72) DE FAVERI, Carla, Via dei Colli 28, 31010 Farra di Soligo TV, IT

STIVANELLO, Mariano, Via Marostica 20, 36015 Schio (VI), IT

(51) MKP
A41D 13/05 2006 (97) EP 3562344

(96) EP 17836036.8 12/29/2017

(97) EP 3562344, 11/6/2019 201945, de

(31) 102016226310 (32) 29.12.2016 (33) DE
 102017217135 26.09.2017 DE

(54) UNDERGARMENT

(71) Tekath, Anneliese, Sudetenstraße 19, 82110 Germering, DE

(72) Tekath, Anneliese, Sudetenstraße 19, 82110 Germering, DE

(51) MKP
A61K 35/26 2015 (97) EP 3514172
A61P 35/00 2006
C07K 14/47 2006
C07K 14/725 2006

(96) EP 19151238.3 3/30/2015

(97) EP 3514172, 1/8/2020 202002, en

(31) PCT/EP2014/000868 (32) 01.04.2014 (33) WO
 PCT/EP2014/072864 24.10.2014 WO

(54) CLAUDIN-6-SPECIFIC IMMUNORECEPTORS AND T CELL EPITOPES

(72) SAHIN, Ugur, Philipp-von-Zabern-Platz 1, 55116 Mainz, DE

TÜRECI, Özlem, Philipp-von-Zabern-Platz 1, 55116 Mainz, DE

SIMON, Petra, Silvanerstrasse 33A, 55129 Mainz, DE

OMOKOKO, Tana, Franz-Werfel-Str. 20, 55116 Mainz, DE

HOFF, Holger, Tieckstrasse 22, 10115 Berlin, DE

VOSS, Ralf-Holger, Lotharstrasse 32, 55218 Ingelheim, DE

BREITKREUZ, Andrea, Trifelsstrasse 47, 67551 Worms, DE

HOBOHM, Kathleen, Johann-Strauss-Str. 18, 65779 Kelkheim i. Ts., DE

MROZ, Karolina Anna, c/o BioNTech Cell & Gene Therapies GmbH An der Goldgrube 12, 55131 Mainz, DE

(51) MKP
A61K 31/58 2006 (97) EP 3517541
A61P 5/44 2006
C07J 31/00 2006
C07J 71/00 2006

(96) EP 19156409.5 5/6/2013
(97) EP 3517541, 1/8/2020 202002, en

(31)	201261644105 P	(32)	08.05.2012	(33)	US
	201261657239 P		09.06.2012		US
	201261692487 P		23.08.2012		US
	201313735973		07.01.2013		US
	201361763770 P		12.02.2013		US
	201361788519 P		15.03.2013		US

(54) POLYMORPHIC FORM OF FLUTICASONE PROPIONATE
(71) Nicox Ophthalmics, Inc., 777 Main Street, Suite 1292, Fort Worth, TX 76102, US
(72) CAVANAGH, Thomas, 57 Hunters Creek Lane, New Canaan, CT Connecticut 06840, US
BARMAN, Shikha P., 19a Crosby Drive, Suite 200, Bedford, MA Massachusetts 01730, US
HAO, Tian, c/o NICOX RESEARCH INSTITUTE S.r.l. - Patent Dept. Via Ariosto, 21, 20091 Bresso (MI), IT
LELAND, Thomas B., 23 Vaughn Hill Road, Bolton, MA Massachusetts 01740, US
THEKKEDATH, Ritesh V., D/1 202 Panchratna, Anand Nagar, Manpada Road, Dombivli (E). M.S., IN

(51) MKP
A61B 1/00 2006 (97) EP 3539448
A61B 1/05 2006
A61B 1/227 2006

(96) EP 19156793.2 2/4/2013
(97) EP 3539448, 11/6/2019 201945, en

(54) METHOD FOR IDENTIFYING OBJECTS IN A SUBJECT'S EAR
(71) Helen of Troy, Limited, The Phoenix Centre George Street Belleville, St. Michael, BB
(72) RUPPERSBERG, J. Peter, Chemin du Signal 53, 1807 Blonay, CH
LEPPLE-WIENHUES, Albrecht, 6 rue de la République, 25300 Pontarlier, FR

(51) MKP
B65B 25/14 2006 (97) EP 3530576
B65B 35/36 2006
B65B 35/50 2006
B65B 43/26 2006
B65G 61/00 2006

(96) EP 19159365.6 2/26/2019
(97) EP 3530576, 12/18/2019 201951, en

(31)	201862635836 P	(32)	27.02.2018	(33)	US
------	----------------	------	------------	------	----

(54) TRAY FILLING APPARATUS FOR LEAFLETS
(71) The Challenge Printing Company, 2 Bridewell Place, Clifton, NJ 07014, US
(72) Sasso, Chad, 106 Chadmore Drive, Cary, NC North Carolina 27518, US
Polt, Margaret, 1545 Lily Creek Drive, Cary, NC North Carolina 27518, US
Thies, Kevin, 650 Skyline Drive, Lake Hopatcong, NJ New Jersey 07849, US
Velez, James, 4928 Mashpee Lane, Apex, NC North Carolina 27539, US

(51) MKP
B62D 55/28 2006 (97) EP 3552931

(96) EP 19161269.6 3/7/2019
(97) EP 3552931, 1/1/2020 202001, de

(31)	502372018	(32)	21.03.2018	(33)	AT
------	-----------	------	------------	------	----

(54) CLIMBING AID
(71) Hettegger, Rupert, Schieddorf 24, 5611 Grossari, AT
(72) Hettegger, Rupert, Schieddorf 24, 5611 Grossari, AT

(51) MKP
A61K 39/00 2006 (97) EP 3552665
A61P 35/00 2006
C07K 16/28 2006

(96) EP 19161728.1 8/12/2015
(97) EP 3552665, 10/16/2019 201942, en

(31)	201414270 201422614 201507541	(32)	12.08.2014 18.12.2014 01.05.2015	(33)	GB GB GB
------	-------------------------------------	------	--	------	----------------

(54) ANTIBODIES
(72) ELLMARK, Peter, Alligator Bioscience Medicon Village, 233 81 Lund, SE
NORLEN, Per, Alligator Bioscience Medicon Village, 233 81 Lund, SE
VEITONMÄKI, Niina, Alligator Bioscience Medicon Village, 233 81 Lund, SE

(51) MKP
A61K 39/00 2006 (97) EP 3552665
A61P 35/00 2006
C07K 16/28 2006

(96) EP 19161728.1 8/12/2015
(97) EP 3552665, 12/18/2019 201951, en

(31)	201414270 201422614 201507541	(32)	12.08.2014 18.12.2014 01.05.2015	(33)	GB GB GB
------	-------------------------------------	------	--	------	----------------

(54) ANTIBODIES
(72) ELLMARK, Peter, Alligator Bioscience Medicon Village, 233 81 Lund, SE
NORLEN, Per, Alligator Bioscience Medicon Village, 233 81 Lund, SE
VEITONMÄKI, Niina, Alligator Bioscience Medicon Village, 233 81 Lund, SE

(51) MKP
A61K 31/713 2006 (97) EP 3587578
C12N 9/64 2006
C12N 15/113 2010

(96) EP 19164080.4 5/22/2014
(97) EP 3587578, 1/1/2020 202001, en

(31)	201361826178 P 201361912988 P	(32)	22.05.2013 06.12.2013	(33)	US US
------	----------------------------------	------	--------------------------	------	----------

(54) TMPRSS6 IRNA COMPOSITIONS AND METHODS OF USE THEREOF
(72) BUTLER, James, c/o Alnylam Pharmaceuticals, Inc. 300 Third Street, 3rd Floor, Cambridge, MA 02142, US
BETTENCOURT, Brian, c/o Alnylam Pharmaceuticals, Inc. 300 Third Street, 3rd Floor, Cambridge, MA 02142, US
RAJEEV, Kallanthottathil, G., c/o Alnylam Pharmaceuticals, Inc. 300 Third Street, 3rd Floor, Cambridge, MA 02142, US
MAIER, Martin, c/o Alnylam Pharmaceuticals, Inc. 300 Third Street, 3rd Floor, Cambridge, MA 02142, US
CHARISSE, Klaus, c/o Alnylam Pharmaceuticals, Inc. 300 Third Street, 3rd Floor, Cambridge, MA 02142, US

(51) MKP
A61K 31/506 2006 (97) EP 3578554
A61P 31/16 2006
C07D 403/04 2006
C07D 471/04 2006

(96) EP 19165859.0 11/12/2014
(97) EP 3578554, 12/11/2019 201950, en

(31)	201361903572 P	(32)	13.11.2013	(33)	US
------	----------------	------	------------	------	----

(54) INHIBITORS OF INFLUENZA VIRUSES REPLICATION
(72) NTI-ADDAE, Kwame W., 19 Kensington Way, Tewksbury, MA 01876, US
WALDO, Michael, 4 Patricia Drive, Grafton, MA 01519, US
O'NEIL, Simon Adam, 77 Maple Street, Belmont, MA 02478, US
VAN ALSTEN, John Gregg, 3 Clearview Drive, Framingham, MA 01701, US
MACIKENAS, Dainius, 7 Clinton Street, Cambridge, MA 02139, US
MUDUNURI, Praveen, 77 Forest Street, Arlington, MA 02474, US
SHI, Yi, 80 Rathburn Road, Natick, MA 01760, US
LEDEBOER, Mark Willem, 36 Faulkner Hill Road, Acton, MA 01720, US
JURKAUSKAS, Valdas, 226 Brattle Street, Cambridge, MA 02138, US
MEDEK, Ales, 14 Lockland Road, Winchester, MA 01890, US
JONES, Steven, 68 Summer Street, Hyde Park, MA 02136, US
BYRN, Randal, 7 Pemberton Road, Wayland, MA 01778, US
ASMAL, Mohammed, 69 Fair Oaks Avenue, Newton, MA 02460, US
ROBERTSON, Sarah Marie, 55 Vernon Street 3, Somerville, MA 02145, US
TSAI, Wanjung, 205 Summer Street Apt. 3, Somerville, MA 02143, US

(51) MKP

A61J 1/10 2006 (97) EP 3545935
A61J 1/14 2006
A61J 1/20 2006
A61J 1/22 2006
(96) EP 19165924.2 3/28/2019
(97) EP 3545935, 12/18/2019 201951, en
(31) 201800004116 (32) 30.03.2018 (33) IT
(54) STERILE FLEXIBLE PACKAGE WITH PRESSURE COMPENSATOR FOR THE DOSED RECONSTITUTION OF FLUID MEDICINAL OR NUTRITIONAL SUBSTANCES TO BE ADMINISTERED TO PATIENTS BY INFUSION OR INJECTION
(72) GOBBI FRATTINI, Paolo Giuseppe, Via Stelvio, 12, 23035 Sondalo SO, IT

(51) MKP
A61K 38/17 2006 (97) EP 3539979
A61K 39/00 2006
C07K 7/06 2006
C07K 7/08 2006
C07K 14/47 2006
(96) EP 19166517.3 11/3/2014
(97) EP 3539979, 1/1/2020 202001, en
(31) 201319446 (32) 04.11.2013 (33) GB
201361899680 P 04.11.2013 US
(54) PERSONALIZED IMMUNOTHERAPY AGAINST SEVERAL NEURONAL AND BRAIN TUMORS
(72) Weinschenk, Toni, Im Morgenrain 15, 73773 Aichwald, DE
Fritsche, Jens, Lärchenweg 11, 72144 Dusslingen, DE
Walter, Steffen, 2901 Wroxtton Road, Houston, TX 77005, US
Hilf, Norbert, Im Wengertacker 17, 72138 Kirchentellinsfurt, DE
Schoor, Oliver, Eichhaldenstrasse 19, 72074 Tübingen, DE
Singh, Harpreet, Heckscherstrasse 25a, 80804 München, DE
Kuttruff-Coqui, Sabrina, Torstrasse 2-6, 70794 Filderstadt-Sielmingen, DE
Song, Colette, Willi-Baumeister-Weg 21, 73760 Ostfildern, DE

(51) MKP
A61K 51/04 2006 (97) EP 3533473
(96) EP 19167560.2 11/13/2014
(97) EP 3533473, 12/18/2019 201951, en
(31) 201361904400 P (32) 14.11.2013 (33) US
201361904387 P 14.11.2013 US
201361909822 P 27.11.2013 US
(54) COMPOUNDS FOR POSITRON EMISSION TOMOGRAPHY
(72) VLAHOV, Iontcho R., 1041 Shootingstar Court, West Lafayette, IN Indiana 47906, US
LEAMON, Christopher P., 5830 Farm Ridge Road, West Lafayette, IN Indiana 47906, US
LOW, Philip S., 5850 Farm Ridge Road, West Lafayette, IN Indiana 47906, US
PARHAM, Garth L., 9105 Jakes Path, Largo, FL Florida 33771, US
CHEN, Qingshou, 227 Arnold Dr. Apt. 9, West Lafayette, IN Indiana 47906, US

(51) MKP
A61K 39/00 2006 (97) EP 3539988
C07K 16/28 2006
C07K 16/32 2006
(96) EP 19168254.1 5/27/2011
(97) EP 3539988, 12/4/2019 201949, en
(31) PA201000467 (32) 27.05.2010 (33) DK
34918010 P 27.05.2010 US
PCT/EP2011/056388 20.04.2011 WO
PA201100312 20.04.2011 DK
(54) MONOCLONAL ANTIBODIES AGAINST HER2
(72) GOEIJ, Bart de, Uppsalalaan 15, NL-3584 CT Utrecht, NL
HAIJ, Simone de, Uppsalalaan 15, NL-3584 CT Utrecht, NL
RIEDL, Thilo, Uppsalalaan 15, NL-3584 CT Utrecht, NL
HOET, René, Van Speyk 126, NL-5831 LG Boxmeer, NL
BAADSGAARD, Ole, Tuborg Sundpark 10, 1. tv., DK-2900 Hellerup, DK
WINKEL, Jan van de, Uppsalalaan 15, NL-3584 CT Utrecht, NL
SATIJN, David, Uppsalalaan 15, NL-3584 CT Utrecht, NL

PARREN, Paul, Werdorperwaard 17, NL-3984 PR Odijk, NL
 LABRIJN, Aran Frank, Uppsalalaan 15, NL-3584 CT Utrecht, NL
 MEESTERS, Joyce, Uppsalalaan 15, NL-3584 CT Utrecht, NL
 SCHUURMAN, Janine, Uppsalalaan 15, NL-3584 CT Utrecht, NL
 BRINK, Edward N. van den, Uppsalalaan 15, NL-3584 CT Utrecht, NL

(51) MKP
E06B 3/66 2006 (97) EP 3567200
E06B 3/663 2006
E06B 3/667 2006
E06B 3/67 2006
E06B 3/677 2006
 (96) EP 19168282.2 7/18/2014
 (97) EP 3567200, 11/13/2019 201946, en
 (31) PCT/CA2013/000653 (32) 19.07.2013 (33) WO
 (54) PRESSURE COMPENSATED GLASS UNIT
 (72) Clarahan, Gregory L., 754 Hendra Crescent N.W., Edmonton, Alberta T6R 1S5, CA

(51) MKP
A61K 38/04 2006 (97) EP 3545965
A61P 35/00 2006
C07K 7/00 2006
C07K 7/06 2006
C07K 7/08 2006
 (96) EP 19170191.1 12/16/2015
 (97) EP 3545965, 12/25/2019 201952, en
 (31) 201423016 (32) 23.12.2014 (33) GB
 201462096165 P 23.12.2014 US
 201501017 21.01.2015 GB
 (54) NOVEL PEPTIDES AND COMBINATION OF PEPTIDES FOR USE IN IMMUNOTHERAPY AGAINST HEPATOCELLULAR CARCINOMA (HCC) AND OTHER CANCERS
 (72) Weinschenk, Toni, Im Morgenrain 15, 73773 Aichwald, DE
 Mahr, Andrea, Horemer 17, 72076 Tübingen, DE
 Fritsche, Jens, Lärchenweg 11, 72144 Dusslingen, DE
 Müller, Phillip, Obere Karlsstrasse 14, 34117 Kassel, DE
 Wiebe, Anita, Quellenstraße 49, 72124 Ruebgarten, DE
 Missel, Sarah, Französische Allee 13, 72072 Tübingen, DE

(51) MKP
B28B 7/36 2006 (97) EP 3536867
E03F 5/02 2006
 (96) EP 19170566.4 3/28/2018
 (97) EP 3536867, 12/18/2019 201951, de
 (31) 502572017 (32) 31.03.2017 (33) AT
 (54) METHOD FOR PRODUCING A MOULDED ARTICLE
 (72) PREDL, Manfred, Matthias-Loi-Strasse 1, 04924 Bönitz, DE

(51) MKP
C12N 15/67 2006 (97) EP 3578659
 (96) EP 19171200.9 3/27/2013
 (97) EP 3578659, 12/11/2019 201950, en
 (31) PCT/EP2012/001336 (32) 27.03.2012 (33) WO
 PCT/EP2012/002447 08.06.2012 WO
 (54) ARTIFICIAL NUCLEIC ACID MOLECULES FOR IMPROVED PROTEIN OR PEPTIDE EXPRESSION
 (72) Theß, Andreas, c/o CureVac AG IP Department Paul-Ehrlich-Str. 15, 72076 Tübingen, DE

(51) MKP
A61K 38/17 2006 (97) EP 3578196
A61K 39/00 2006
C07K 7/06 2006
C07K 7/08 2006

C12N 5/0783 2010
C12N 9/64 2006
(96) EP 19171543.2 8/4/2014
(97) EP 3578196, 12/11/2019 201950, en
(31) 201313987 (32) 05.08.2013 (33) GB
201361862213 P 05.08.2013 US
201403297 25.02.2014 GB
(54) NOVEL IMMUNOTHERAPY AGAINST SEVERAL TUMORS, SUCH AS LUNG CANCER, INCLUDING NSCLC
(72) WEINSCHENK, Toni, Im Morgenrain 15, 73773 Aichwald, DE
WALTER, Steffen, 2901 Wroxton Road, Houston, TX Texas 77005, US
FRITSCHKE, Jens, Lärchenweg 11, 72144 Dusslingen, DE
SONG, Colette, Willi-Baumeister-Weg 21, 73760 Ostfildern, DE
SINGH, Harpreet, Heckscherstraße 25a, 80804 München, DE

(51) MKP
C12N 5/0735 2010 (97) EP 3578988
C12Q 1/68 2018
G01N 33/15 2006
G01N 33/68 2006
(96) EP 19172117.4 5/19/2011
(97) EP 3578988, 12/11/2019 201950, en
(31) 39625710 P (32) 25.05.2010 (33) US
(54) METHOD OF NOCICEPTOR DIFFERENTIATION OF HUMAN EMBRYONIC STEM CELLS AND USES THEREOF
(72) STUDER, Lorenz, 360 E. 88th Street, New York, NY 10128, US
CHAMBERS, Sturat, M., P.O. Box 256 1275 York Avenue Rrl-945, New York, NY 10021, US

(51) MKP
A61K 39/00 2006 (97) EP 3574916
A61P 35/00 2006
(96) EP 19172853.4 8/21/2014
(97) EP 3574916, 12/4/2019 201949, en
(31) PCT/EP2013/002514 (32) 21.08.2013 (33) WO
(54) COMPOSITION AND VACCINE FOR TREATING LUNG CANCER
(72) Kallen, Karl-Josef, c/o IP DEPARTMENT CureVac AG Paul Ehrlich Str. 15, 72076 Tübingen, DE
Fotin-Mleczek, Mariola, c/o IP DEPARTMENT CureVac AG Paul Ehrlich Str. 15, 72076 Tübingen, DE
Gnad-Vogt, Ulrike, c/o IP DEPARTMENT CureVac AG Paul Ehrlich Str. 15, 72076 Tübingen, DE

(51) MKP
A61K 39/395 2006 (97) EP 3572093
C07K 14/435 2006
(96) EP 19172994.6 3/31/2015
(97) EP 3572093, 11/27/2019 201948, en
(31) PCT/IB2014/000467 (32) 31.03.2014 (33) WO
PCT/IB2015/000288 06.03.2015 WO
(54) FGFR FUSIONS
(72) TANAKA, Hiroaki, Rue de Genève 77, 1004 Lausanne, CH
MOULON, Corinne, Chemin de Milavy 6D, 1806 Saint-Léger, CH
CHESSEX, Anne Vaslin, Avenue du Major-Davel 22B, 1800 Vevey, CH
WOJCIK, Jérôme, Rue de la Comboe de l'Eau 218, 01220 Divonne-les-Bains, FR
ARMENISE, Claudia, Rue des Vignes 155, 01200 Eloise, FR

(51) MKP
A61K 39/395 2006 (97) EP 3572093
C07K 14/435 2006
(96) EP 19172994.6 3/31/2015
(97) EP 3572093, 1/15/2020 202003, en
(31) PCT/IB2014/000467 (32) 31.03.2014 (33) WO
PCT/IB2015/000288 06.03.2015 WO
(54) FGFR FUSIONS
(72) TANAKA, Hiroaki, Rue de Genève 77, 1004 Lausanne, CH
MOULON, Corinne, Chemin de Milavy 6D, 1806 Saint-Léger, CH
CHESSEX, Anne Vaslin, Avenue du Major-Davel 22B, 1800 Vevey, CH
WOJCIK, Jérôme, Rue de la Comboe de l'Eau 218, 01220 Divonne-les-Bains, FR

ARMENISE, Claudia, Rue des Vignes 155, 01200 Eloise, FR

- (51) MKP
A61K 31/13 2006 (97) EP 3583940
A61P 25/28 2006
- (96) EP 19174007.5 8/11/2017
 (97) EP 3583940, 12/25/2019 201952, en
- (31) 201613829 (32) 11.08.2016 (33) GB
 201702551 16.02.2017 GB
 201705766 10.04.2017 GB
 201706867 28.04.2017 GB
- (54) THERAPEUTIC AGENTS FOR NEURODEGENERATIVE DISEASES
 (72) STRUPP, Michael, Ludwig-Maximilians-University Hospital Munich, c/o The Department of Neurology and German Center Campus Grosshadern Marchioninstr. 15, 81377 Munich, DE

- (51) MKP
A61K 39/12 2006 (97) EP 3566714
C07K 14/005 2006
- (96) EP 19175392.0 11/27/2012
 (97) EP 3566714, 11/13/2019 201946, en
- (31) 11191003 (32) 28.11.2011 (33) EP
 201161564086 P 28.11.2011 US
 11191009 28.11.2011 EP
 201161564198 P 28.11.2011 US
 12166268 01.05.2012 EP
 201261720281 P 30.10.2012 US
- (54) INFLUENZA VIRUS VACCINES AND USES THEREOF
 (72) MEIJBERG, Jan Willem, IP Department Archimedesweg 4-6, 2333 CN Leiden, NL
 IMPAGLIAZZO, Antonietta, Archimedesweg 4-6, 2333 CN Leiden, NL
 VOGELS, Ronald, Archimedesweg 4-6, 2333 CN Leiden, NL
 FRIESEN, Robert, Heinz, Edward, Archimedesweg 4-6, 2333 CN Leiden, NL
 ALARD, Philippe, Archimedesweg 4-6, 2333 CN Leiden, NL
 LOVERIX, Stefan, Archimedesweg 4-6, 2333 CN Leiden, NL

- (51) MKP
A61K 31/415 2006 (97) EP 3556752
A61K 31/454 2006
A61K 31/4709 2006
A61K 31/497 2006
A61K 31/506 2006
C07D 231/14 2006
C07D 401/06 2006
C07D 401/10 2006
C07D 401/14 2006
C07D 403/10 2006
C07D 409/14 2006
C07D 413/14 2006
- (96) EP 19176610.4 11/26/2015
 (97) EP 3556752, 10/23/2019 201943, en
- (31) 201421083 (32) 27.11.2014 (33) GB
- (54) N-((HET)ARYLMETHYL)-HETEROARYL-CARBOXAMIDES COMPOUNDS AS PLASMA KALLIKREIN INHIBITORS
 (72) DAVIE, Rebecca Louise, c/o KALVISTA PHARMACEUTICALS LIMITED Porton Science Park Bybrook Road, Porton Down, Wiltshire SP4 0BF, GB
 EDWARDS, Hannah Joy, c/o KALVISTA PHARMACEUTICALS LIMITED Porton Science Park Bybrook Road, Porton Down, Wiltshire SP4 0BF, GB
 EVANS, David Michael, c/o KALVISTA PHARMACEUTICALS LIMITED Porton Science Park Bybrook Road, Porton Down, Wiltshire SP4 0BF, GB
 HODGSON, Simon Teanby, Orchard House The Avenue, Ampthill, Bedfordshire MK45 2NR, GB

- (51) MKP
C07K 16/12 2006 (97) EP 3594232
C07K 16/26 2006
C07K 16/36 2006
C07K 16/46 2006

(96) EP 19177410.8 4/19/2013
 (97) EP 3594232, 1/15/2020 202003, en
 (31) 201261635935 P (32) 20.04.2012 (33) US
 (54) METHODS AND MEANS FOR THE PRODUCTION OF IG-LIKE MOLECULES
 (72) de Kruijff, Cornelis Adriaan, c/o Yalelaan 62, 3584 CM Utrecht, NL
 Hendriks, Linda Johanna Aleida, c/o Yalelaan 62, 3584 CM Utrecht, NL
 Logtenberg, Ton, c/o Yalelaan 62, 3584 CM Utrecht, NL

(51) MKP
C01B 32/20 2017 (97) EP 3578512
C01B 32/205 2017
 (96) EP 19177660.8 2/15/2016
 (97) EP 3578512, 12/11/2019 201950, en
 (31) 15704986 (32) 13.02.2015 (33) NZ
 (54) GRAPHITE PRODUCTION FROM BIOMASS
 (72) CONNER, Gregory Thomas, c/o CarbonScape Limited PO Box 55, 7240 Blenheim, NZ
 MILLER, Ian James, c/o CarbonScape Limited PO Box 55, 7240 Blenheim, NZ
 GOMEZ, Mireia Marques, c/o CarbonScape Limited PO Box 55, 7240 Blenheim, NZ

(51) MKP
C07K 16/12 2006 (97) EP 3594233
C07K 16/26 2006
C07K 16/36 2006
C07K 16/46 2006
 (96) EP 19178196.2 4/19/2013
 (97) EP 3594233, 1/15/2020 202003, en
 (31) 201261635935 P (32) 20.04.2012 (33) US
 (54) METHODS AND MEANS FOR THE PRODUCTION OF IG-LIKE MOLECULES
 (72) de Kruijff, Cornelis Adriaan, c/o Yalelaan 62, 3584 CM Utrecht, NL
 Hendriks, Linda Johanna Aleida, c/o Yalelaan 62, 3584 CM Utrecht, NL
 Logtenberg, Ton, c/o Yalelaan 62, 3584 CM Utrecht, NL

(51) MKP
A61K 31/7088 2006 (97) EP 3564380
A61K 35/76 2015
C12N 7/01 2006
C12N 15/861 2006
 (96) EP 19179450.2 11/15/2013
 (97) EP 3564380, 11/6/2019 201945, en
 (31) 201261727455 P (32) 16.11.2012 (33) US
 (54) RECOMBINANT ADENOVIRUSES AND USE THEREOF
 (72) BAROUCH, Dan, H., 115 Willard Street, Newton, MA 02461, US
 VIRGIN, Herbert, 9 Tuscany Park, St. Louis, MO 63105, US
 ABBINK, Peter, Beth Israel Deaconess Medical Center, Inc. 330 Brookline Avenue, Boston, MA 02215, US

(51) MKP
A61K 39/00 2006 (97) EP 3564378
A61K 39/08 2006
C07K 14/33 2006
C07K 16/12 2006
C12N 15/62 2006
C12N 15/70 2006
 (96) EP 19179871.9 5/25/2012
 (97) EP 3564378, 11/6/2019 201945, en
 (31) 201161490707 P (32) 27.05.2011 (33) US
 201161490734 P 27.05.2011 US
 201161490716 P 27.05.2011 US
 (54) IMMUNOGENIC COMPOSITION
 (72) CASTADO, Cindy, GlaxoSmithKline Biologicals SA Rue de l'Institut 89, 1330 Rixensart, BE

(51) MKP

C04B 28/14 2006 (97) EP 3564199
C04B 111/00 2006
 (96) EP 19181378.1 5/20/2014
 (97) EP 3564199, 11/6/2019 201945, en
 (31) 201309058 (32) 20.05.2013 (33) GB
 (54) CONSTRUCTION PANEL HAVING IMPROVED FIXING STRENGTH AND METHOD FOR THE MANUFACTURE THEREOF
 (72) HOTCHIN, Glen, c/o Saint-Gobain Construction Products UK Limited Saint-Gobain House Binley Business Park, Coventry, CV3 2TT, GB
 JONES, Nicholas, c/o Saint-Gobain Construction Products UK Limited Saint-Gobain House Binley Business Park, Coventry, CV3 2TT, GB
 RICHARDSON, Adam, c/o Saint-Gobain Construction Products UK Limited Saint-Gobain House Binley Business Park, Coventry, CV3 2TT, GB

(51) MKP
A61K 39/00 2006 (97) EP 3572432
A61P 31/00 2006
A61P 35/00 2006
A61P 37/00 2006
C07K 16/28 2006
 (96) EP 19182007.5 1/26/2016
 (97) EP 3572432, 11/27/2019 201948, en
 (31) 201562108605 P (32) 28.01.2015 (33) US
 201562192331 P 14.07.2015 US
 201562247355 P 28.10.2015 US
 (54) ICOS BINDING PROTEINS
 (71) Centre National de la Recherche Scientifique, 3 rue Michel Ange, 75016 Paris, FR
 (72) LIU, Yao-Bin, GlaxoSmithKline 1250 S. Collegeville Road, Collegeville, PA 19426, US
 PARMAR, Radha Shah, GlaxoSmithKline Gunnels Wood Road, Stevenage, Hertfordshire SG1 2NY, GB
 MAYES, Patrick, GlaxoSmithKline 1250 S. Collegeville Road, Collegeville, PA 19426, US
 OLIVE, Daniel, 27 bd Lei Roure BP 3, 13009 Marseille, FR

(51) MKP
A61K 39/00 2006 (97) EP 3575324
A61P 31/00 2006
A61P 35/00 2006
A61P 37/00 2006
C07K 16/28 2006
 (96) EP 19182010.9 1/26/2016
 (97) EP 3575324, 12/4/2019 201949, en
 (31) 201562108605 P (32) 28.01.2015 (33) US
 201562192331 P 14.07.2015 US
 201562247355 P 28.10.2015 US
 (54) ICOS BINDING PROTEINS
 (72) LIU, Yao-Bin, GlaxoSmithKline 1250 S. Collegeville Road, Collegeville, PA 19426, US
 PARMAR, Radha Shah, GlaxoSmithKline Gunnels Wood Road, Stevenage, Hertfordshire SG1 2NY, GB
 MAYES, Patrick, GlaxoSmithKline 1250 S. Collegeville Road, Collegeville, PA 19426, US
 OLIVE, Daniel, 27 bd Lei Roure BP 3, 13009 Marseille, FR

(51) MKP
A61K 31/415 2006 (97) EP 3567037
A61K 31/454 2006
A61K 31/4709 2006
A61K 31/497 2006
A61K 31/506 2006
C07D 231/14 2006
C07D 401/06 2006
C07D 401/10 2006
C07D 401/14 2006
C07D 403/10 2006
C07D 409/14 2006
C07D 413/14 2006
 (96) EP 19182383.0 11/26/2015
 (97) EP 3567037, 11/13/2019 201946, en
 (31) 201421083 (32) 27.11.2014 (33) GB
 (54) N-((HET)ARYLMETHYL)-HETEROARYL-CARBOXAMIDES COMPOUNDS AS PLASMA KALLIKREIN INHIBITORS
 (72) DAVIE, Rebecca Louise, c/o KALVISTA PHARMACEUTICALS LIMITED Porton Science Park Bybrook Road Porton Down, Wiltshire, SP4 0BF, GB

EDWARDS, Hannah Joy, c/o KALVISTA PHARMACEUTICALS LIMITED Porton Science Park Bybrook Road Porton Down, Wiltshire, SP4 0BF, GB

EVANS, David Michael, c/o KALVISTA PHARMACEUTICALS LIMITED Porton Science Park Bybrook Road Porton Down, Wiltshire, SP4 0BF, GB
HODGSON, Simon Teanby, Orchard House, The Avenue Ampthill, Bedfordshire, MK45 2NR, GB

- (51) MKP
F16L 41/08 2006 (97) EP 3567293
- (96) EP 19183600.6 7/14/2015
(97) EP 3567293, 11/13/2019 201946, en
- (31) 1040885 (32) 14.07.2014 (33) NL
1041068 25.11.2014 NL
- (54) SYSTEM FOR COOLING A FLOW OR FOR EXTRACTING HEAT OUT OF A FLOW THROUGH A PIPELINE AND/OR FOR EXTRACTING HEAT OUT OF A SURROUNDING OF A PIPELINE AND A METHOD FOR PROVIDING SUCH A SYSTEM
- (72) Roelfsema, Marcel, Scheepswerfkade 21, 9503 PB Stadskanaal, NL
Kanters, Arno F.C., De Widtstraat 14, 7701 XM Dedemsvaart, NL

- (51) MKP
A61K 9/00 2006 (97) EP 3593788
A61K 9/08 2006
A61K 31/5575 2006
A61K 47/14 2017
A61P 27/06 2006
- (96) EP 19185400.9 7/10/2019
(97) EP 3593788, 1/15/2020 202003, en
- (31) 18290082 (32) 12.07.2018 (33) EP
- (54) OPHTHALMIC COMPOSITIONS CONTAINING A NITRIC OXIDE RELEASING PROSTAMIDE
- (72) PILOTAZ, Frédéric, Les Villas de Bellet - B3 - 209 route de Bellet, 06200 NICE, FR
WEINER, Alan L., 2312 Grafton Lane, MCKINNEY, TX Texas 75071, US
DO, Marina, 5 Rue de Bréa, 06500 MENTON, FR
SALDO, Julien, 6 Rue Gendarme Desclair - Les Vergers - Bâtiment B, 06800 CAGNES SUR MER, FR

- (51) MKP
G06Q 20/32 2012 (97) EP 3594881
G06Q 20/38 2012
G06Q 20/42 2012
- (96) EP 19185731.7 7/11/2019
(97) EP 3594881, 1/15/2020 202003, de
- (31) 102018117038 (32) 13.07.2018 (33) DE
- (54) PROCEDURE TO EFFECT AUTHENTICATED PAYMENTS WITH A MOBILE DEVICE OF THE PURCHASER
- (71) Hermanns, Matthias, Hedwigstr. 2, 48149 Münster, DE
(72) Hermanns, Matthias, Hedwigstr. 2, 48149 Münster, DE

- (51) MKP
C07K 14/16 2006 (97) EP 3584252
- (96) EP 19186284.6 12/15/2016
(97) EP 3584252, 12/25/2019 201952, en
- (31) 15200138 (32) 15.12.2015 (33) EP
16194124 17.10.2016 EP
- (54) HUMAN IMMUNODEFICIENCY VIRUS ANTIGENS, VECTORS, COMPOSITIONS, AND METHODS OF USE THEREOF
- (72) LANGEDIJK, Johannes, Petrus, Maria, Archimedesweg 4-6, 2333 CN Leiden, NL
CALLENDRET, Benoit, C.,S., Archimedesweg 4-6, 2333 CN Leiden, NL
VAN MANEN, Danielle, Archimedesweg 4-6, 2333 CN Leiden,, NL
KRARUP, Anders, Archimedesweg 4-6, 2333 CN Leiden, NL
STITZ, Jörn, Archimedesweg 4-6, 2333 CN Leiden, NL
WEGMANN, Frank, Archimedesweg 4-6, 2333 CN Leiden, NL
VELLINGA, Jort, Archimedesweg 4-6, 2333 CN Leiden, NL

- (51) MKP
C07D 231/18 2006 (97) EP 3578547
- (96) EP 19187141.7 2/16/2016
(97) EP 3578547, 12/11/2019 201950, en

(31) 2015900507 (32) 16.02.2015 (33) AU
 (54) SULFONYLUREAS AND RELATED COMPOUNDS AND USE OF SAME
 (71) The University of Queensland, St. Lucia, Queensland 4072, AU
 (72) O'NEILL, Luke, Trinity Biomedical Sciences Institute Trinity College Dublin 152-160 Pearse Street, Dublin 2, IE
 COLL, Rebecca, 18 Forbes Street West End, Queensland 4101, AU
 COOPER, Matthew, 29 Camborne Place Chapel Hill, Queensland 4049, AU
 ROBERTSON, Avril, 44 Maryland Street Kenmore, Queensland 4069, AU
 SCHRODER, Kate, 7 Love Street Fairfield, Queensland 4103, AU

(51) MKP
A61K 31/422 2006 (97) EP 3587412
A61K 31/4439 2006
A61P 1/16 2006
A61P 3/04 2006
A61P 3/10 2006
A61P 29/00 2006
A61P 35/00 2006
C07D 401/14 2006
C07D 413/12 2006
C07D 413/14 2006

(96) EP 19188723.1 6/9/2017
 (97) EP 3587412, 1/1/2020 202001, en
 (31) 201662349490 P (32) 13.06.2016 (33) US
 (54) FXR (NR1H4) MODULATING COMPOUNDS
 (72) BLOMGREN, Peter A, c/o Gilead Sciences, Inc. 333 Lakeside Drive, Foster City, CA 94404, US
 CURRIE, Kevin S, c/o Gilead Sciences, Inc. 333 Lakeside Drive, Foster City, CA 94404, US
 GEGE, Christian, c/o Phenex Pharmaceuticals AG Donnersbergweg 1, 67059 Ludwigshafen, DE
 KROPF, Jeffrey E, c/o Gilead Sciences, Inc. 333 Lakeside Drive, Foster City, CA 94404, US
 XU, Jianjun, c/o Gilead Sciences, Inc. 333 Lakeside Drive, Foster City, CA 94404, US

(51) MKP
A61K 31/437 2006 (97) EP 3581573
A61P 35/00 2006
C07D 471/04 2006

(96) EP 19189460.9 5/5/2016
 (97) EP 3581573, 12/18/2019 201951, en
 (31) 201562157902 P (32) 06.05.2015 (33) US
 201562241040 P 13.10.2015 US
 (54) SYNTHESIS OF A COMPOUND THAT MODULATES KINASES
 (71) Daiichi Sankyo Company, Limited, 3-5-1, Nihonbashi Honcho Chuo-ku, Tokyo 103-8426, JP
 (72) IBRAHIM, Prabha N., c/o Plexikon Inc. 91 Bolivar Drive Suite A, Berkeley, CA 94710, US
 JIN, Masayoshi, c/o Daiichi Sankyo Company, Limited 3-5-1 Nihonbashi Honcho, Chuo-ku, Tokyo 103-8426, JP
 MATSUURA, Shinji, c/o Daiichi Sankyo Company, Limited 3-5-1 Nihonbashi Honcho, Chuo-ku, Tokyo 103-8426, JP

(51) MKP
A61B 17/17 2006 (97) EP 3573548
A61B 17/56 2006
A61B 17/88 2006
A61B 17/90 2006
A61C 3/04 2006
A61C 8/00 2006

(96) EP 19733646.4 3/12/2019
 (97) EP 3573548, 12/4/2019 201949, en
 (31) 201862682489 P (32) 08.06.2018 (33) US
 201862641821 P 12.03.2018 US
 (54) APPARATUS AND METHODS WITH SURGICAL GUIDES HAVING ROUTED LIQUID COOLANT IRRIGATION
 (71) MUSC Foundation for Research Development, 135 Cannon Drive, Suite 101L, Charleston, SC 29425, US
 (72) RENNE, Walter, 2107 Military Way, Charleston, SC 29414, US
 EVANS, Zachary, 1524 Regimental Ln., Johns Island, SC 29455, US

(51) MKP
C09K 11/08 2006 (97) EP 3592825
C09K 11/77 2006

- C09K 11/80 2006**
G01T 1/00 2006
G01T 1/02 2006
G01T 1/20 2006
- (96) EP 19750719.7 2/7/2019
(97) EP 3592825, 1/15/2020 202003, en
- (31) 201862627399 P (32) 07.02.2018 (33) US
201862672890 P 17.05.2018 US
- (54) GARNET SCINTILLATOR CO-DOPED WITH MONOVALENT ION
(71) University of Tennessee Research Foundation, UT Conference Center 600 Henley Street Suite 211, Knoxville, TN 37996, US
(72) FOSTER, Camera Janelle, 5562 Meadow Wells Drive, Knoxville, TN 37924, US
WU, Yuntao, 309 Science And Engineering Building 1414 Circle Drive, Knoxville, TN 37996-2100, US
KOSCHAN, Merry A., 912 Baylor Circle, Knoxville, TN 37923, US
MELCHER, Charles, L., 14 Rivers Run Blvd., Oak Ridge, TN 37830, US
-
- (51) MKP
F01K 25/10 2006 (97) EP 3587752
H02K 7/18 2006
H02K 35/02 2006
- (96) EP 19760178.4 2/7/2019
(97) EP 3587752, 1/1/2020 202001, en
- (31) 2018036840 (32) 01.03.2018 (33) JP
- (54) WORKING MEDIUM CHARACTERISTIC DIFFERENCE POWER GENERATION SYSTEM AND WORKING MEDIUM CHARACTERISTIC DIFFERENCE POWER GENERATION METHOD IN WHICH SAID POWER GENERATION SYSTEM IS USED
(71) Kobayashi, Takaitu, 3-16-33, Nekozone Urayasu-shi, Chiba 279-0004, JP
(72) Kobayashi, Takaitu, 3-16-33, Nekozone Urayasu-shi, Chiba 279-0004, JP
-
- (51) MKP
A61K 31/53 2006 (97) EP 3556761
A61P 35/00 2006
C07D 487/04 2006
- (96) EP 17896079.5 12/26/2017
(97) EP 3556761, 10/23/2019 201943, en
- (31) 201710068798 (32) 08.02.2017 (33) CN
- (54) PYRROLO-AROMATIC HETEROCYCLIC COMPOUND, PREPARATION METHOD THEREFOR, AND MEDICAL USE THEREOF
(71) The National Institutes Of Pharmaceutical Research, No.27 Zhansimen Road Shahe Changping, Beijing 102206, CN
(72) YIN, Huijun, NO.27 Zhansimen Road Shahe Changping, Beijing 102206, CN
YAN, Xu, NO.27 Zhansimen Road Shahe Changping, Beijing 102206, CN
ZONG, Libin, NO.27 Zhansimen Road Shahe Changping, Beijing 102206, CN
TIAN, Weixue, NO.27 Zhansimen Road Shahe Changping, Beijing 102206, CN
ZHENG, Li, NO.27 Zhansimen Road Shahe Changping, Beijing 102206, CN
DOU, Haoshuai, NO.27 Zhansimen Road Shahe Changping, Beijing 102206, CN
YANG, Yan, NO.27 Zhansimen Road Shahe Changping, Beijing 102206, CN
-
- (51) MKP
A61K 31/133 2006 (97) EP 3592357
A61K 31/56 2006
A61K 31/575 2006
C07J 5/00 2006
C07J 9/00 2006
C07J 31/00 2006
- (96) EP 17899634.4 9/21/2017
(97) EP 3592357, 1/15/2020 202003, en
- (31) 201762468259 P (32) 07.03.2017 (33) US
- (54) METHODS OF TREATING CANCER
(72) MOSCHETTA, Antonio, Via Pietro Giannone 17, 70032 Bitonto Bari, IT
ASURMEDI, Jesús, María Bañales, Biodonostia Health Research Institute - Donostia University Hospital Paseo Doctor Begiristain s/n, 20014 San Sebastián, ES
PIEROLA, Luis, Bujanda Fernandez De, Biodonostia Health Research Institute - Donostia University Hospital Paseo Doctor Begiristain s/n, 20014 San Sebastián, ES
MONTIEL, María, Jesus Perugorria, Biodonostia Health Research Institute - Donostia University Hospital Paseo Doctor Begiristain s/n, 20014 San Sebastián, ES
AZPARREN, Oihane, Erice, Biodonostia Health Research Institute - Donostia University Hospital Paseo Doctor Begiristain s/n, 20014 San Sebastián, ES

- (51) MKP
A61K 31/337 2006 (97) EP 3577110
A61K 31/4155 2006
A61K 31/495 2006
A61K 31/504 2006
A61K 31/506 2006
A61K 31/5365 2006
C07C 243/28 2006
C07C 275/16 2006
C07D 401/12 2006
C07D 403/12 2006
C07D 405/14 2006
C07D 471/08 2006
C07D 487/08 2006
C07D 487/10 2006
C07D 491/04 2006
- (96) EP 18706072.8 2/5/2018
(97) EP 3577110, 12/11/2019 201950, en
- (31) 201762455348 P (32) 06.02.2017 (33) US
- (54) ATAZANAVIR (ATV) ANALOGUES FOR TREATING HIV INFECTIONS
(72) BACON, Elizabeth M., c/o Gilead Sciences Inc. 333 Lakeside Drive, Foster City CA 94404, US
CHIN, Elbert, c/o Gilead Sciences Inc. 333 Lakeside Drive, Foster City CA 94404, US
COTTELL, Jeromy J., c/o Gilead Sciences Inc. 333 Lakeside Drive, Foster City CA 94404, US
KATANA, Ashley Anne, 6599 Nancy Drive, North Olmsted OH 44070, US
KATO, Darryl, c/o Gilead Sciences Inc. 333 Lakeside Drive, Foster City CA 94404, US
LINK, John O., c/o Gilead Sciences Inc. 333 Lakeside Drive, Foster City CA 94404, US
SHAPIRO, Nathan, c/o Gilead Sciences Inc. 333 Lakeside Drive, Foster City CA 94404, US
TREJO MARTIN, Teresa Alejandra, c/o Gilead Sciences Inc. 333 Lakeside Drive, Foster City CA 94404, US
YANG, Zheng-Yu, c/o Gilead Sciences Inc. 333 Lakeside Drive, Foster City CA 94404, US

- (51) MKP
A61L 17/00 2006 (97) EP 3579889
A61L 17/10 2006
A61L 17/14 2006
- (96) EP 18706077.7 2/6/2018
(97) EP 3579889, 12/18/2019 201951, en
- (31) 201715427963 (32) 08.02.2017 (33) US
- (54) BRAIDED SUTURE WITH FILAMENT CONTAINING A MEDICANT
(72) SCALZO, Howard, P.O. Box 151 Route 22 West, Somerville, NJ 08876, US
KRIKSUNOV, Leo, B., P.O. Box 151 U.S. Route 22, Somerville, NJ 08876, US
TANNHAUSER, Robert, J., P.O. Box 151 U.S. Route 22, Somerville, NJ 08876, US
SKULA, Emil, Richard, P.O. BOX 151 Route 22 West, Somerville, NJ 08876, US

- (51) MKP
A61K 39/00 2006 (97) EP 3580238
A61K 51/10 2006
C07C 259/00 2006
C07K 16/28 2006
- (96) EP 18706165.0 2/9/2018
(97) EP 3580238, 12/18/2019 201951, en
- (31) 201762457287 P (32) 10.02.2017 (33) US
- (54) RADIOLABELED ANTI-LAG3 ANTIBODIES FOR IMMUNO-PET IMAGING
(72) KELLY, Marcus, c/o Regeneron Pharmaceuticals Inc. 777 Old Saw Mill River Road, Tarrytown New York 10591, US
MA, Dangshe, c/o Regeneron Pharmaceuticals Inc. 777 Old Saw Mill River Road, Tarrytown New York 10591, US
OLSON, William, c/o Regeneron Pharmaceuticals Inc. 777 Old Saw Mill River Road, Tarrytown New York 10591, US
TAVARE, Richard, c/o Regeneron Pharmaceuticals Inc. 777 Old Saw Mill River Road, Tarrytown New York 10591, US
THURSTON, Gavin, c/o Regeneron Pharmaceuticals Inc. 777 Old Saw Mill River Road, Tarrytown New York 10591, US

- (51) MKP
C07D 209/10 2006 (97) EP 3585780
C07D 401/12 2006
C07D 403/12 2006

C07D 405/12 2006
 (96) EP 18706506.5 2/21/2018
 (97) EP 3585780, 1/1/2020 202001, en
 (31) 17000276 (32) 21.02.2017 (33) EP
 (54) ARYL HYDROCARBON RECEPTOR (AHR) MODULATOR COMPOUNDS
 (72) DEUSCHLE, Ulrich, Maulbeerstück 11, 67346 Speyer, DE
 STEENECK, Christoph, Weberstrasse 4/2, 69120 Heidelberg, DE
 ALBERS, Michael, Schwabenstrasse 6 A, 68239 Mannheim, DE
 HOFFMANN, Thomas, Daimlerstrasse 21, 67346 Speyer, DE

(51) MKP
A61K 39/395 2006 (97) EP 3576788
C07K 16/28 2006
 (96) EP 18706965.3 2/2/2018
 (97) EP 3576788, 12/11/2019 201950, en
 (31) 201762453952 P (32) 02.02.2017 (33) US
 (54) LOW PH PHARMACEUTICAL COMPOSITION COMPRISING T CELL ENGAGING ANTIBODY CONSTRUCTS
 (72) MCAULEY, Arnold, c/o Amgen Inc One Amgen Center Drive, Thousand Oaks California 91320, US
 GHATTYVENKATAKRISHNA, Pavan, c/o Amgen Inc One Amgen Center Drive, Thousand Oaks California 91320, US
 ABEL, Jeff, 402 Willow Glen Circle, Simi Valley California 93065, US
 HUH, Joon, c/o Amgen Inc One Amgen Center Drive, Thousand Oaks California 91320, US
 POMPE, Cornelius, c/o Amgen Research (Munich) GmbH Staffelseestrasse 2, 81477 Munich, DE
 KANAPURAM, Sekhar, c/o Amgen Inc One Amgen Center Drive, Thousand Oaks California 91320, US
 TREUHEIT, Michael, 807 Pamela Wood St., Newbury Park California 91320, US
 JAGANNATHAN, Bharadwaj, 1663 Amarelle St, Thousand Oaks California 91320, US

(51) MKP
C12Q 1/6886 2018 (97) EP 3585908
 (96) EP 18707022.2 2/22/2018
 (97) EP 3585908, 1/1/2020 202001, en
 (31) 201762463125 P (32) 24.02.2017 (33) US
 201762589837 P 22.11.2017 US
 (54) AN INHIBITOR OF ATR KINASE FOR USE IN A METHOD OF TREATING A HYPER-PROLIFERATIVE DISEASE
 (72) WENGER, Antje, Margret, Binzstr. 60, 13189 Berlin, DE
 SIEMEISTER, Gerhard, Reimerswalder Steig 26, 13503 Berlin, DE
 HÄNDLER, Bernard, Am Biberbau 8, 13465 Berlin, DE
 GOLFIER, Sven, Stölpchenweg 12E, 14109 Berlin, DE
 SCHLICKER, Andreas, Rigaer Str. 17, 10247 Berlin, DE
 LIU, Li, 11 Hillside Drive, East Hanover NJ 07936, US

(51) MKP
B24B 3/54 2006 (97) EP 3576907
 (96) EP 18707074.3 1/26/2018
 (97) EP 3576907, 12/11/2019 201950, fr
 (31) 1750890 (32) 02.02.2017 (33) FR
 (54) SHARPENING DEVICE
 (71) Sogest, 4 rue de la Tannerie, 57130 Ars sur Moselle, FR
 (72) GORNAY, Jean Luc, 2 impasse de la Fontaine de Fer, 57680 Corny sur Moselle, FR

(51) MKP
A61K 31/44 2006 (97) EP 3580203
A61P 35/00 2006
C07D 213/71 2006
C07D 401/12 2006
C07D 405/12 2006
 (96) EP 18707131.1 2/7/2018
 (97) EP 3580203, 12/18/2019 201951, en
 (31) 201762455641 P (32) 07.02.2017 (33) US
 201762594794 P 05.12.2017 US
 (54) HYDROCARBYLSULFONYL-SUBSTITUTED PYRIDINES AND THEIR USE IN THE TREATMENT OF CANCER
 (72) PELCMAN, Benjamin, Döbelngatan 85, SE-113 52 Stockholm, SE
 SUNA, Edgars, Alsungas 5a, LV-1004 Riga, LV

STAFFORD, William, Pepparvägen 40 Lgh 1301, SE-123 56 Farsta, SE
 PRIEDE, Martins, Bikernieku 77-46, LV-1039 Riga, LV

(51) MKP
B42C 7/00 2006 (97) EP 3573840
B42C 15/00 2006
 (96) EP 18707141.0 1/23/2018
 (97) EP 3573840, 12/4/2019 201949, en
 (31) 201700007352 (32) 24.01.2017 (33) IT
 (54) AUTOMATIC MACHINE AND METHOD FOR COVERING THE COVERS OF BOOKS
 (71) Colibri' System S.p.A., Via Enrico Cernuschi 4, 20129 Milano, IT
 (72) FARNETI, Aldo, Via Achillini Claudio 14, 20162 Milano, IT

(51) MKP
A61K 31/437 2006 (97) EP 3577115
A61P 35/00 2006
C07D 471/04 2006
 (96) EP 18707242.6 2/1/2018
 (97) EP 3577115, 12/11/2019 201950, en
 (31) 17000157 (32) 01.02.2017 (33) EP
 (54) ARYL HYDROCARBON RECEPTOR (AHR) MODULATOR COMPOUNDS
 (72) STEENECK, Christoph, Weberstrasse 4/2, 69120 Heidelberg, DE
 DEUSCHLE, Ulrich, Maulbeerstück 11, 67346 Speyer, DE
 ALBERS, Michael, Schwabenstr. 6 A, 68239 Mannheim, DE
 HOFFMANN, Thomas, Daimlerstrasse 21, 67346 Speyer, DE

(51) MKP
A61P 37/06 2006 (97) EP 3583128
C07K 16/28 2006
 (96) EP 18707306.9 2/15/2018
 (97) EP 3583128, 12/25/2019 201952, en
 (31) 17305184 (32) 17.02.2017 (33) EP
 (54) NEW USES OF ANTI-SIRPG ANTIBODIES
 (72) POIRIER, Nicolas, 1 chemin du Passe-Temps, 44119 Treillieres, FR
 MARY, Caroline, 7 rue du Buisson, 44680 Sainte-Pazanne, FR
 GAUTTIER, Vanessa, 22 rue Félicien Thomazeau, 44400 Reze, FR
 THEPENIER, Virginie, 45 rue de la feuillette, 44680 Saint Pazanne, FR
 PENGAM, Sabrina, 11 rue des Oréades, 44980 St Luce s/ Loire, FR
 VANHOVE, Bernard, 72 bis rue Henri Barbusse, 44400 Reze, FR

(51) MKP
A61K 38/09 2006 (97) EP 3573663
A61K 45/06 2006
A61P 35/00 2006
 (96) EP 18707414.1 1/30/2018
 (97) EP 3573663, 12/4/2019 201949, en
 (31) 201762452096 P (32) 30.01.2017 (33) US
 (54) A composition comprising at least one GNRH antagonist
 (71) Antev Limited, 22 South Molton Street, London W1K 5RB, GB
 (72) LARSEN, Finn, 18 Forest Road Bonchester Bridge, Hawick TD9 8JS, GB

(51) MKP
A61K 39/395 2006 (97) EP 3577139
A61K 47/68 2017
C07K 16/28 2006
 (96) EP 18707417.4 2/1/2018
 (97) EP 3577139, 12/11/2019 201950, en
 (31) 201762454476 P (32) 03.02.2017 (33) US
 (54) ANTI-CCR7 ANTIBODY DRUG CONJUGATES
 (72) BENDER, Steven, c/o Novartis Institute for Functional Genomics Inc. dba Genomics Institute of the Novartis Research Foundation 10675 John Jay Hopkins Drive, San Diego, California 92121, US
 CHARLTON, Tracy, c/o Novartis Institute for Functional Genomics Inc. dba Genomics Institute of the Novartis Research Foundation 10675 John

Jay Hopkins Drive, San Diego, California 92121, US
 GALKIN, Anna, c/o Novartis Institute for Functional Genomics Inc. dba Genomics Institute of the Novartis Research Foundation 10675 John Jay Hopkins Drive, San Diego, California 92121, US
 GEIERSTANGER, Bernhard Hubert, c/o Novartis Institute for Functional Genomics Inc. dba Genomics Institute of the Novartis Research Foundation 10675 John Jay Hopkins Drive, San Diego, California 92121, US
 GLASER, Scott Martin, c/o Novartis Institute for Functional Genomics Inc. dba Genomics Institute of the Novartis Research Foundation 10675 John Jay Hopkins Drive, San Diego, California 92121, US
 KASIBHATLA, Shailaja, 13073 Dressage Lane, San Diego, California 92130, US
 KNUETH, Mark, c/o Novartis Institute for Functional Genomics Inc. dba Genomics Institute of the Novartis Research Foundation 10675 John Jay Hopkins Drive, San Diego, California 92121, US
 ROTTMANN, Sabine, c/o Novartis Institute for Functional Genomics Inc. dba Genomics Institute of the Novartis Research Foundation 10675 John Jay Hopkins Drive, San Diego, California 92121, US
 RUE, Sarah, c/o Novartis Institute for Functional Genomics Inc. dba Genomics Institute of the Novartis Research Foundation 10675 John Jay Hopkins Drive, San Diego, California 92121, US
 SPRAGGON, Glen, c/o Novartis Institute for Functional Genomics Inc. dba Genomics Institute of the Novartis Research Foundation 10675 John Jay Hopkins Drive, San Diego, California 92121, US
 UNO, Tetsuo, c/o Novartis Institute for Functional Genomics Inc. dba Genomics Institute of the Novartis Research Foundation 10675 John Jay Hopkins Drive, San Diego, California 92121, US

(51) MKP
A61D 1/02 2006 (97) EP 3579787
A61D 7/00 2006
A61J 1/06 2006
 (96) EP 18707553.6 2/13/2018
 (97) EP 3579787, 12/18/2019 201951, en
 (31) 201762458428 P (32) 13.02.2017 (33) US
 (54) LIQUID APPLICATOR FOR DELIVERING VACCINES
 (72) DE MALIBRAN-SANTIBANEZ, Aurelie, 1860 Wellbourne Drive, Atlanta, GA 30324, US
 PRADO-MASIAS, Alonso, 5865 Norfolk Chase Road, Peachtree Corner, GA 30092, US
 DAVID, Frederic, 1130 Christian Terrace, Watkinsville, GA 30677, US

(51) MKP
A61K 47/60 2017 (97) EP 3585441
A61P 35/00 2006
C08G 69/10 2006
C08G 69/40 2006
C08G 83/00 2006
 (96) EP 18707681.5 2/22/2018
 (97) EP 3585441, 1/1/2020 202001, en
 (31) 201762461983 P (32) 22.02.2017 (33) US
 201762488151 P 21.04.2017 US
 201762591823 P 29.11.2017 US
 (54) THERAPEUTIC DENDRIMERS
 (72) MCCOULL, William, AstraZeneca R&D, Macclesfield Cheshire SK10 4TG, GB
 ASHFORD, Marianne, Bernice, AstraZeneca R&D, Macclesfield Cheshire SK10 4TG, GB
 GRANT, Iain, AstraZeneca R&D, Macclesfield Cheshire SK10 4TG, GB
 HENNESSY, Edward, John, AstraZeneca R&D Boston 35 Gatehouse Drive, Waltham Massachusetts 02451, US
 SECRIST, John, Paul, AstraZeneca R&D Boston 35 Gatehouse Drive, Waltham Massachusetts 02451, US
 OWEN, David, Starpharma Pty Limited 4-6 Southampton Crescent, Abbotsford, Victoria 3067, AU
 KELLY, Brian, Starpharma Pty Limited 4-6 Southampton Crescent, Abbotsford, Victoria 3067, AU
 GIANNIS, Michael, Starpharma Pty Limited 4-6 Southampton Crescent, Abbotsford, Victoria 3067, AU

(51) MKP
A61K 31/437 2006 (97) EP 3589323
A61K 31/438 2006
A61K 31/4545 2006
A61K 31/47 2006
A61K 31/4965 2006
A61K 31/498 2006
A61K 45/06 2006
A61P 31/06 2006
 (96) EP 18707713.6 2/28/2018
 (97) EP 3589323, 1/8/2020 202002, en
 (31) 17158607 (32) 01.03.2017 (33) EP

- (54) COMBINATION THERAPY
 (71) Janssen Sciences Ireland Unlimited Company, Barnahely, Ringaskiddy, Co Cork, IE
 (72) ANDRIES, Koenraad Jozef Lodewijk Marcel, c/o Janssen Pharmaceutica NV Turnhoutseweg 30, 2340 Beerse, BE
 KOUL, Anil, c/o Janssen Pharmaceutica NV Turnhoutseweg 30, 2340 Beerse, BE
 VILLELLAS ARILLA, Maria Cristina, c/o Janssen Pharmaceutica NV Turnhoutseweg 30, 2340 Beerse, BE

- (51) MKP
A61K 38/00 2006 (97) EP 3589954
G01N 33/569 2006
 (96) EP 18707724.3 3/2/2018
 (97) EP 3589954, 1/8/2020 202002, en
 (31) 17159243 (32) 03.03.2017 (33) EP
 17159242 03.03.2017 EP
 201703809 09.03.2017 GB
 (54) PEPTIDE VACCINES
 (72) LISZIEWICZ, Julianna, Szorosi ut 13, 8220 Balatonalmadi, HU
 MOLNÁR, Levente, Kossuth Lajos u. 20., 2363 Felsőpakony, HU
 TÖKE, Enikő, Kossuth Lajos u. 20., 2363 Felsőpakony, HU
 TOTH, József, Újkut u. 72, 9012 Gyor, HU
 LORINCZ, Orsolya, Attila u. 27 fszt/13, 1047 Budapest, HU
 CSISZOVSZKI, Zsolt, Bikszádi u. 12/A 4/9, 1119 Budapest, HU
 SOMOGYI, Eszter, Borgazda u. 3, 8220 Balatonalmádi, HU
 PÁNTYA, Katalin, Üllői út 16/b 2.em. 9/b, 1085 Budapest, HU
 MEGYESI, Mónika, Táncsics Mihály u. 63, 3441 Mezokeresztes, HU

- (51) MKP
A61K 39/00 2006 (97) EP 3589310
A61K 39/12 2006
G01N 33/50 2006
G01N 33/569 2006
 (96) EP 18707725.0 3/2/2018
 (97) EP 3589310, 1/8/2020 202002, en
 (31) 17159243 (32) 03.03.2017 (33) EP
 17159242 03.03.2017 EP
 201703809 09.03.2017 GB
 (54) PERSONALISED IMMUNOGENIC PEPTIDE IDENTIFICATION PLATFORM
 (72) LISZIEWICZ, Julianna, Szorosi ut 13, 8200 Balatonalmadi, HU
 MOLNÁR, Levente, Kossuth Lajos u. 20., Felsőpakony 2363, HU
 TÖKE, Enikő, R., Kossuth Lajos u. 20., Felsőpakony 2363, HU
 TOTH, József, Újkut u. 72, 9012 Gyor, HU
 LORINCZ, Orsolya, Attila u. 27 fszt/13, 1047 Budapest, HU
 CSISZOVSZKI, Zsolt, Attila u. 27 fszt/13, 1047 Budapest, HU
 SOMOGYI, Eszter, Borgazda u. 3, 8220 Balatonalmádi, HU
 PÁNTYA, Katalin, Üllői út 16/b 2.em. 9/b, Budapest 1085, HU
 MEGYESI, Mónika, Táncsics Mihály u. 63, 3441 Mezokeresztes, HU

- (51) MKP
A61K 31/444 2006 (97) EP 3582775
A61K 31/541 2006
A61K 45/06 2006
A61P 29/00 2006
A61P 35/00 2006
A61P 37/00 2006
A61P 37/06 2006
A61P 37/08 2006
A61P 43/00 2006
 (96) EP 18707866.2 2/15/2018
 (97) EP 3582775, 12/25/2019 201952, en
 (31) 201702603 (32) 17.02.2017 (33) GB
 (54) ANTI-INFLAMMATORY COMPOSITIONS COMPRISING IRAK AND JAK INHIBITORS
 (72) BRYNS, Reginald, Christophe, Xavier, Galapagos NV Generaal De Wittelaan L11/A3, 2800 Mechelen, BE
 GALIEN, René, Alexandre, Galapagos SASU 102 Avenue Gaston Roussel, 93230 Romainville, FR
 DE VOS, Steve, Irma, Joel, Galapagos NV Generaal De Wittelaan L11/A3, 2800 Mechelen, BE
 AMANTINI, David, Galapagos SASU 102 Avenue Gaston Roussel, 93230 Romainville, FR

- (51) MKP
A61K 38/22 2006 (97) EP 3580232
C07K 14/64 2006
- (96) EP 18708002.3 2/8/2018
 (97) EP 3580232, 12/18/2019 201951, en
- (31) 201762456161 P (32) 08.02.2017 (33) US
 201862627411 P 07.02.2018 US
- (54) MODIFIED RELAXIN POLYPEPTIDES COMPRISING A PHARMACOKINETIC ENHANCER AND USES THEREOF
 (72) DUBOWCHIK, Gene, M., 5 Research Parkway, Wallingford Connecticut 06492, US
 GUDMUNDSSON, Olafur, S., Route 206 and Province Line Road, Princeton New Jersey 08543, US
 HAN, Xiaojun, 5 Research Parkway, Wallingford Connecticut 06492, US
 LAWRENCE, R., Michael, 350 Carter Road, Hopewell New Jersey 08540, US
 LIPOVSEK, Dasa, 100 Beaver Street, Waltham Massachusetts 02453, US
 MADSEN, Cort, S., 311 Pennington-Rocky Hill Road, Pennington New Jersey 08543, US
 MAPELLI, Claudio, 465 Briggs Road, Langhorne Pennsylvania 19047, US
 MORIN, Paul, E., Route 206 and Province Line Road, Princeton New Jersey 08543, US
 MYERS, Michael, C., 350 Carter Road, Hopewell New Jersey 08540, US

- (51) MKP
A61K 38/40 2006 (97) EP 3583120
A61K 39/00 2006
C07K 14/705 2006
C07K 14/79 2006
- (96) EP 18708025.4 2/15/2018
 (97) EP 3583120, 12/25/2019 201952, en
- (31) 201762460692 P (32) 17.02.2017 (33) US
 201762543658 P 10.08.2017 US
 201762583314 P 08.11.2017 US
- (54) ENGINEERED TRANSFERRIN RECEPTOR BINDING POLYPEPTIDES
 (72) CHEN, Xiaocheng, c/o Denali Therapeutics Inc. 161 Oyster Point Blvd., South San Francisco California 94080, US
 DENNIS, Mark S., c/o Denali Therapeutics Inc. 161 Oyster Point Blvd., South San Francisco California 94080, US
 KARIOLIS, Mihalis, c/o Denali Therapeutics Inc. 161 Oyster Point Blvd., South San Francisco California 94080, US
 SILVERMAN, Adam P., c/o Denali Therapeutics Inc. 161 Oyster Point Blvd., South San Francisco California 94080, US
 SRIVASTAVA, Ankita, c/o Denali Therapeutics Inc. 161 Oyster Point Blvd., South San Francisco California 94080, US
 WATTS, Ryan J., c/o Denali Therapeutics Inc. 161 Oyster Point Blvd., South San Francisco California 94080, US
 WELLS, Robert C., c/o Denali Therapeutics Inc. 161 Oyster Point Blvd., South San Francisco California 94080, US
 ZUCHERO, Joy Yu, c/o Denali Therapeutics Inc. 161 Oyster Point Blvd., South San Francisco California 94080, US

- (51) MKP
A61K 31/7084 2006 (97) EP 3582853
A61P 31/04 2006
A61P 37/04 2006
C07F 9/6527 2006
C07F 9/6574 2006
C07H 19/213 2006
- (96) EP 18708032.0 2/17/2018
 (97) EP 3582853, 12/25/2019 201952, en
- (31) 201762460562 P (32) 17.02.2017 (33) US
 201762479169 P 30.03.2017 US
 201762551645 P 29.08.2017 US
 201762551647 P 29.08.2017 US
 201762551668 P 29.08.2017 US
- (54) CYCLIC DI-NUCLEOTIDES COMPOUNDS FOR THE TREATMENT OF CANCER
 (72) KIM, Dae-Shik, 79 Dascomb Road, Andover Massachusetts 01810, US
 FANG, Frank, 16 Greybitch Road, Andover Massachusetts 01810, US
 ENDO, Atsushi, 311 Lowell Street, Andover Massachusetts 01810, US
 CHOI, Hyeong-Wook, 39 Juniper Road, Andover Massachusetts 01810, US
 HAO, Ming-Hong, 138 Quincy Shore Drive 173, Quincy Massachusetts 02171, US
 BAO, Xingfeng, 993 Main Street, Concord Massachusetts 01742, US
 HUANG, Kuan-Chun, 7 Manning Street, Lexington Massachusetts 02421, US

- (51) MKP
A61K 31/713 2006 (97) EP 3577223
A61P 7/00 2006
C12N 15/113 2010
- (96) EP 18708204.5 2/5/2018
(97) EP 3577223, 12/11/2019 201950, en
- (31) 201762455464 P (32) 06.02.2017 (33) US
- (54) COMPOSITIONS AND METHODS FOR THE TREATMENT OF HEMOGLOBINOPATHIES
(71) Intellia Therapeutics, Inc., 40 Erie Street Ste. 130, Cambridge, MA 02139, US
(72) MICKANIN, Craig Stephen, c/o Novartis Institutes for BioMedical Research Inc. 250 Massachusetts Avenue, Cambridge, MA 02139, US
SCHMEDT, Christian, c/o Novartis Institute For Functional Genomics Inc. DBA The Genomics Institute of the Novartis Research Foundation (GNF) 10675 John Jay Hopkins Drive, San Diego, CA 92121, US
SNEAD, Jennifer, c/o Novartis Institute For Functional Genomics Inc. DBA The Genomics Institute of the Novartis Research Foundation (GNF) 10675 John Jay Hopkins Drive, San Diego, CA 92121, US
STEVENSON, Susan C., c/o Novartis Institutes for BioMedical Research Inc. 250 Massachusetts Avenue, Cambridge, MA 02139, US
YANG, Yi, c/o Novartis Institutes for BioMedical Research Inc. 250 Massachusetts Avenue, Cambridge, MA 02139, US
-

- (51) MKP
A61K 31/519 2006 (97) EP 3585790
A61P 25/28 2006
C07D 487/04 2006
C07D 519/00 2006
- (96) EP 18708385.2 2/27/2018
(97) EP 3585790, 1/1/2020 202001, en
- (31) 17158044 (32) 27.02.2017 (33) EP
- (54) [1,2,4]-TRIAZOLO [1,5-A]-PYRIMIDINYL DERIVATIVES SUBSTITUTED WITH PIPERIDINE, MORPHOLINE OR PIPERAZINE AS OGA INHIBITORS
(72) BARTOLOMÉ-NEBREDÁ, José Manuel, c/o: Janssen-Cilag S.A. Edificio Johnson&Johnson Paseo de las Doce Estrellas 5-7 5° planta Campo de las Naciones, 28042 Madrid, ES
TRABANCO-SUÁREZ, Andrés Avelino, c/o: Janssen-Cilag S.A. Edificio Johnson&Johnson Paseo de las DoceEstrellas 5-7 5° planta Campo de las Naciones, 28042 Madrid, ES
ALCÁZAR-VACA, Manuel Jesús, c/o: Janssen-Cilag S.A. Edificio Johnson&Johnson Paseo de las Doce Estrellas 5-7 5° planta Campo de las Naciones, 28042 Madrid, ES
-

- (51) MKP
A61K 31/4184 2006 (97) EP 3585772
C07D 235/08 2006
C07D 401/10 2006
C07D 403/10 2006
C07D 413/10 2006
C07D 417/10 2006
- (96) EP 18708631.9 2/23/2018
(97) EP 3585772, 1/1/2020 202001, en
- (31) 201741006586 (32) 24.02.2017 (33) IN
- (54) 1, 4, 6-TRISUBSTITUTED-2-ALKYL-1H-BENZO[D]IMIDAZOLE DERIVATIVES AS DIHYDROOROTATE OXYGENASE INHIBITORS
(72) THUNUGUNTLA, Siva Sanjeeva Rao, H. No: 52 Phase - II Jaya Prakash Narayan Nagar Colony Miyapur, Hyderabad Telangana State 500 049, IN
HOSAHALLI, Subramanya, A 103 Temple Meadows 3 27th Cross Banashankari 2nd Stage, Bangalore Karnataka 560 070, IN
PANIGRAHI, Sunil Kumar, S/o. Shree Jogeswar Panigrahi Kantamal, Boudh State of Orissa 762 017, IN
SCHWARZ, Matthias, Rue de l'Abbaye 15B, 1196 Gland, CH
ARLT, Michael, Im Strenger 7, 64665 Alsbach, DE
-

- (51) MKP
C12Q 1/48 2006 (97) EP 3585904
C12Q 1/68 2018
G01N 33/574 2006
- (96) EP 18708634.3 2/26/2018
(97) EP 3585904, 1/1/2020 202001, en
- (31) 201762464006 P (32) 27.02.2017 (33) US
- (54) USE OF BIOMARKERS IN IDENTIFYING CANCER PATIENTS THAT WILL BE RESPONSIVE TO TREATMENT WITH A PRMT5 INHIBITOR
(72) BREHMER, Dirk, Janssen Pharmaceutica NV Turnhoutseweg 30, 2340 Beerse, BE
BEKE, Lijs, Janssen Pharmaceutica NV Turnhoutseweg 30, 2340 Beerse, BE
GAFFNEY, Dana, Suzanne, Janssen Research&Development LLC 920 US Route 202 PO Box 300, Raritan, NJ 08869, US
MOY, Christopher, H, Janssen Research&Development LLC 920 US Route 202 PO Box 300, Raritan, NJ 08869, US

- (51) MKP
A61P 25/28 2006 (97) EP 3583123
C07K 16/18 2006
- (96) EP 18708795.2 2/15/2018
(97) EP 3583123, 12/25/2019 201952, en
- (31) 201762460642 P (32) 17.02.2017 (33) US
201762583400 P 08.11.2017 US
- (54) ANTI-TAU ANTIBODIES AND METHODS OF USE THEREOF
(71) Denali Therapeutics Inc., 161 Oyster Point Boulevard, South San Francisco, California 94080, US
(72) CHEN, Xiaocheng, c/o Denali Therapeutics Inc. 161 Oyster Point Blvd., South San Francisco, California 94080, US
DENNIS, Mark S., c/o Denali Therapeutics Inc. 161 Oyster Point Blvd., South San Francisco, California 94080, US
KANE, Lesley Ann, c/o Denali Therapeutics Inc. 161 Oyster Point Blvd., South San Francisco, CA 94080, US
KIM, Do Jin, c/o Denali Therapeutics Inc. 161 Oyster Point Blvd., South San Francisco, California 94080, US
LEWCOCK, Joseph W., c/o Denali Therapeutics Inc. 161 Oyster Point Blvd., South San Francisco, California 94080, US
PODA, Suresh, c/o Denali Therapeutics Inc. 161 Oyster Point Blvd., South San Francisco, California 94080, US
RAKHIT, Rishi, c/o Denali Therapeutics Inc. 161 Oyster Point Blvd., South San Francisco, California 94080, US
SHUKLA, Rinkan, c/o Denali Therapeutics Inc. 161 Oyster Point Blvd., South San Francisco, California 94080, US
SILVERMAN, Adam P., c/o Denali Therapeutics Inc. 161 Oyster Point Blvd., South San Francisco, California 94080, US

- (51) MKP
A61M 5/315 2006 (97) EP 3589340
- (96) EP 18708870.3 2/22/2018
(97) EP 3589340, 1/8/2020 202002, en
- (31) 201762464662 P (32) 28.02.2017 (33) US
201762539106 P 31.07.2017 US
201762552556 P 31.08.2017 US
- (54) DOSE DETECTION AND DRUG IDENTIFICATION FOR A MEDICATION DELIVERY DEVICE
(72) BYERLY, Roy Howard, c/o ELI LILLY AND COMPANY P.O. Box 6288, Indianapolis, Indiana 46206-6288, US
MASSARI, Rossano Claudio, c/o ELI LILLY AND COMPANY P.O. Box 6288, Indianapolis, Indiana 46206-6288, US
MURPHY, Patrick Kevin, c/o ELI LILLY AND COMPANY P.O. Box 6288, Indianapolis, Indiana 46206-6288, US
PACCIORETTI, Davide, c/o ELI LILLY AND COMPANY P.O. Box 6288, Indianapolis, Indiana 46206-6288, US
PERKINS, Russell Wayne, c/o ELI LILLY AND COMPANY P.O. Box 6288, Indianapolis, Indiana 46206-6288, US
PSZENNY, Sean Matthew, c/o ELI LILLY AND COMPANY P.O. Box 6288, Indianapolis, Indiana 46206-6288, US
REGELE, Oliver Brian, c/o ELI LILLY AND COMPANY P.O. Box 6288, Indianapolis, Indiana 46206-6288, US

- (51) MKP
A61K 31/185 2006 (97) EP 3585373
A61K 31/381 2006
A61K 31/404 2006
A61K 31/415 2006
A61K 31/4152 2006
A61K 31/4168 2006
A61K 31/4184 2006
A61K 31/4196 2006
A61K 31/42 2006
A61K 31/423 2006
A61K 31/426 2006
A61K 31/428 2006
A61K 31/433 2006
A61K 31/44 2006
A61K 31/4425 2006
A61K 31/505 2006
A61K 31/52 2006
A61K 31/53 2006
A61K 31/536 2006
A61K 31/5377 2006
A61P 25/28 2006
- (96) EP 18708877.8 2/23/2018
(97) EP 3585373, 1/1/2020 202001, en
- (31) 201762463421 P (32) 24.02.2017 (33) US
- (54) METHODS FOR TREATING NEURODEGENERATIVE DISORDERS
(72) KOCIS, Petr, 111 Speen Street Suite 306, Framingham MA 01701, US

TOLAR, Martin, 111 Speen Street Suite 306, Framingham MA 01701, US
 HEY, John, 111 Speen Street Suite 306, Framingham MA 01701, US

(51) MKP
A61K 48/00 2006 (97) EP 3589329
C07K 14/745 2006
C07K 14/755 2006
C12N 15/85 2006
C12N 15/88 2006

(96) EP 18708931.3 2/21/2018
 (97) EP 3589329, 1/8/2020 202002, en

(31) 17170681 (32) 11.05.2017 (33) EP
 17177443 22.06.2017 EP
 PCT/EP2017/074630 28.09.2017 WO

(54) CONCEPT FOR THE TREATMENT OF MONOGENETIC DISORDERS
 (71) Zentrum für Forschungsförderung in der Pädiatrie GmbH, Herrenstraße 13, 30159 Hannover, DE
 (72) HANENBERG, Helmut, Bockumer Str. 352a, 40489 Düsseldorf, DE
 HOLZ, Maj-Kristin, Bunsenstr. 39, 45145 Essen, DE
 RÖLLECKE, Katharina, Düsseldorfer Str. 35, 44143 Dortmund, DE
 WAACK-BUCHHOLZ, Katharina, Am Bilstein 82, 45219 Essen, DE

(51) MKP
B01F 3/04 2006 (97) EP 3580183
C02F 3/20 2006
C02F 3/22 2006

(96) EP 18709076.6 2/7/2018
 (97) EP 3580183, 12/18/2019 201951, en

(31) 201700013252 (32) 07.02.2017 (33) IT

(54) DEVICE FOR SEWAGE TREATMENT
 (71) Novideas S.r.l., Viale Trieste 91, 09025 Sanluri, IT
 (72) SANNA, Edoardo, Strada 53 n.3 Loc. Poggio dei Pini, 09012 Capoterra, IT
 SANNA, Ludovico, Strada 53 n.3 Loc. Poggio dei Pini, 09012 Capoterra, IT

(51) MKP
A61K 9/00 2006 (97) EP 3570840
A61K 31/47 2006
A61K 45/06 2006
A61P 35/00 2006
A61P 35/04 2006

(96) EP 18709192.1 1/19/2018
 (97) EP 3570840, 11/27/2019 201948, en

(31) 201762448869 P (32) 20.01.2017 (33) US
 201762458447 P 13.02.2017 US

(54) COMBINATIONS OF CABOZANTINIB AND ATEZOLIZUMAB TO TREAT CANCER
 (71) Exelixis, Inc., 1851 Harbor Bay Parkway, Alameda, CA 94502, US
 (72) SCHWAB, Gisela, 25530 Dario Terrace, Hayward CA 94541, US
 SCHEFFOLD, Christian, 642 Maybell Avenue, Palo Alto CA 94306, US
 HESSEL, Colin, 17 Inyo Pl., Redwood City CA 94061, US

(51) MKP
A61K 38/19 2006 (97) EP 3589308
A61K 38/20 2006
A61K 38/21 2006
C07K 14/535 2006
C07K 14/54 2006
C07K 14/56 2006
C12N 15/67 2006

(96) EP 18709243.2 2/27/2018
 (97) EP 3589308, 1/8/2020 202002, en

(31) 201762464981 P (32) 28.02.2017 (33) US
 17306089 23.08.2017 EP
 201762597527 P 12.12.2017 US

(54) THERAPEUTIC RNA

(72) GIESEKE, Friederike, c/o BioNTech AG An der Goldgrube 12, 55131 Mainz, DE
 SAHIN, Ugur, c/o BioNTech AG An der Goldgrube 12, 55131 Mainz, DE
 WIEDERSCHAIN, Dmitri G., c/o Sanofi 55 Corporate Drive Mail Code: 55A-505A, Bridgewater, New Jersey 08807, US
 WAGENAAR, Timothy R., c/o Sanofi 55 Corporate Drive Mail Code: 55A-505A, Bridgewater, New Jersey 08807, US

(51) MKP
A61K 39/00 2006 (97) EP 3571226
A61P 19/08 2006
C07K 16/22 2006

(96) EP 18709437.0 1/19/2018

(97) EP 3571226, 11/27/2019 201948, en

(31) 201762448763 P (32) 20.01.2017 (33) US

(54) BONE-TARGETING ANTIBODIES

(72) QIU, Huawei, c/o Sanofi 55 Corporate Drive Mail Code: 55A-505A, Bridgewater, NJ 08807, US
 PARK, Sunghae, c/o Sanofi 55 Corporate Drive Mail Code: 55A-505A, Bridgewater, NJ 08807, US
 STEFANO, James, c/o Sanofi 55 Corporate Drive Mail Code: 55A-505A, Bridgewater, NJ 08807, US

(51) MKP
A61K 31/4152 2006 (97) EP 3592732
A61P 35/00 2006
C07D 231/14 2006

(96) EP 18709661.5 2/27/2018

(97) EP 3592732, 1/15/2020 202003, en

(31) 20175202 (32) 07.03.2017 (33) FI

(54) MANUFACTURE OF A CRYSTALLINE PHARMACEUTICAL PRODUCT

(72) HARTEVA, Merja, Hauenkalliontie 12-14 A 3, FI-02170 Espoo, FI
 STAFFANS, Anna, Fallåker 11 F 15, FI-02740 Espoo, FI

(51) MKP
B29C 45/16 2006 (97) EP 3585583
B29C 45/17 2006
B29K 23/00 2006
B29K 75/00 2006
B29K 77/00 2006
B29K 105/04 2006
G10K 11/00 2006

(96) EP 18709785.2 2/20/2018

(97) EP 3585583, 1/1/2020 202001, en

(31) 201700019731 (32) 22.02.2017 (33) IT

(54) MULTI-STEP METHOD FOR PRODUCING A SOUNDPROOF COMPOSITE COVER FOR INTERNAL COMBUSTION ENGINES AND PRODUCT THUS OBTAINED

(72) AFFINITA, Antonio, c/o SAPA S.R.L. Via Vittoria Colonna 14, I-80121 Napoli (NA), IT

(51) MKP
B29C 45/16 2006 (97) EP 3585584
B29C 45/17 2006
B29C 45/26 2006
B29K 23/00 2006
B29K 75/00 2006
B29K 77/00 2006
B29K 105/04 2006
B60R 13/08 2006
F02B 77/11 2006
G10K 11/00 2006

(96) EP 18709786.0 2/20/2018

(97) EP 3585584, 1/1/2020 202001, en

(31) 201700019746 (32) 22.02.2017 (33) IT

(54) MULTI-STEP METHOD FOR PRODUCING A COMPOSITE COMPONENT FOR VEHICLES AND PRODUCT THUS OBTAINED

(72) AFFINITA, Antonio, c/o SAPA S.R.L. Via Vittoria Colonna 14, I-80121 Napoli (NA), IT

(51) MKP

A01N 43/72 2006 (97) EP 3579696
A01N 43/90 2006
A01N 47/18 2006
A01P 5/00 2006
(96) EP 18709829.8 2/8/2018
(97) EP 3579696, 12/18/2019 201951, en
(31) 201762456510 P (32) 08.02.2017 (33) US
(54) IN VIVO MODEL FOR PARASITIC WORM INFECTION AND METHODS FOR EVALUATING ANTIPARASITIC COMPOUNDS, INCLUDING COMPOUNDS ACTIVE AGAINST CANINE HEARTWORM
(71) Thomas Jefferson University, 901 Walnut Street 11th Floor, Philadelphia, PA 19107, US
(72) ABRAHAM, David, 1419 Surrey Lane, Wynnewood, PA 19096, US
HESS, Jessica, 2954 Kanans Road, Willow Grove, PA 19090, US
BONDESEN, Brenda, A., 1655 Centerview Drive Apt. 224, Duluth, GA 30096, US
HARRINGTON, John, Matthew, 2508 Commerce Road, Athens, GA 30607, US

(51) MKP
A61K 31/7084 2006 (97) EP 3582854
A61P 31/04 2006
A61P 37/04 2006
C07F 9/6527 2006
C07F 9/6536 2006
C07F 9/6574 2006
C07H 19/213 2006
(96) EP 18709835.5 2/17/2018
(97) EP 3582854, 12/25/2019 201952, en
(31) 201762460562 P (32) 17.02.2017 (33) US
201762479169 P 30.03.2017 US
201762551645 P 29.08.2017 US
201762551647 P 29.08.2017 US
201762551668 P 29.08.2017 US
(54) CYCLIC DI-NUCLEOTIDES DERIVATIVE FOR THE TREATMENT OF CANCER
(72) KIM, Dae-Shik, 79 Dascomb Road, Andover Massachusetts 01810, US
FANG, Frank, 16 Greybirch Road, Andover Massachusetts 01810, US
ENDO, Atsushi, 311 Lowell Street, Andover Massachusetts 01810, US
CHOI, Hyeong-Wook, 39 Juniper Road, Andover Massachusetts 01810, US
HAO, Ming-Hong, 138 Quincy Shore Drive 173, Quincy Massachusetts 02171, US
BAO, Xingfeng, 993 Main Street, Concord Massachusetts 01742, US
HUANG, Kuan-Chun, 7 Manning Street, Lexington Massachusetts 02421, US

(51) MKP
A61K 31/357 2006 (97) EP 3582804
A61K 39/00 2006
A61P 35/00 2006
(96) EP 18709923.9 2/20/2018
(97) EP 3582804, 12/25/2019 201952, en
(31) 17020059 (32) 20.02.2017 (33) EP
(54) PHARMACEUTICAL COMBINATIONS FOR TREATING CANCER
(72) BAUER, Michael, Konrad-Adenauer-Strasse 32, 79540 Lörrach, DE
HOOFMAN, Leon, Gempenweg 16, 4414 Arlesheim, CH
ROMAGNOLI, Barbara, Waldeckweg 24, CH-4102 Binningen, CH

(51) MKP
A61K 31/542 2006 (97) EP 3592750
A61P 25/28 2006
C07D 498/04 2006
C07D 513/04 2006
(96) EP 18709999.9 3/6/2018
(97) EP 3592750, 1/15/2020 202003, en
(31) 201762468052 P (32) 07.03.2017 (33) US
17189762 07.09.2017 EP
(54) INHIBITORS OF BETA SECRETASE
(72) VOS, Ann, Marleen, c/o Janssen Pharmaceutica NV Turnhoutseweg 30, 2340 Beerse, BE
OEHLRICH, Daniel, c/o Janssen Pharmaceutica NV Turnhoutseweg 30, 2340 Beerse, BE
GIJSEN, Henricus, Jacobus, Maria, c/o Janssen Pharmaceutica NV Turnhoutseweg 30, 2340 Beerse, BE

WATTS, Karl, Shawn, c/o Schrödinger 101 S.W. Main Street Suite 1300, Portland, Oregon 97211, US
 BHAT, Sathesh, Pangala, c/o Schrödinger 101 S.W. Main Street Suite 1300, Portland, Oregon 97211, US
 VAN DEN KEYBUS, Frans, Alfons, Maria, c/o Janssen Pharmaceutica NV Turnhoutseweg 30, 2340 Beerse, BE

- (51) MKP
A61K 31/542 2006 (97) EP 3592751
A61P 25/28 2006
C07D 513/04 2006
- (96) EP 18710000.3 3/6/2018
 (97) EP 3592751, 1/15/2020 202003, en
- (31) 201762467998 P (32) 07.03.2017 (33) US
 17189756 07.09.2017 EP
- (54) INHIBITORS OF BETA SECRETASE
- (72) VOS, Ann, Marleen, c/o Janssen Pharmaceutica NV Turnhoutseweg 30, 2340 Beerse, BE
 OEHLRICH, Daniel, c/o Janssen Pharmaceutica NV Turnhoutseweg 30, 2340 Beerse, BE
 GIJSEN, Henricus, Jacobus, Maria, c/o Janssen Pharmaceutica NV Turnhoutseweg 30, 2340 Beerse, BE
 WATTS, Karl, Shawn, c/o Schrödinger 101 S.W. Main Street Suite 1300, Portland, Oregon 97211, US
 BHAT, Sathesh, Pangala, c/o Schrödinger 101 S.W. Main Street Suite 1300, Portland, Oregon 97211, US
 BUIJNSTERS, Peter, Jacobus, Johannes, Antonius, c/o Janssen Pharmaceutica NV Turnhoutseweg 30, 2340 Beerse, BE
 VAN BRANDT, Sven, Franciscus, Anna, c/o Janssen Pharmaceutica NV Turnhoutseweg 30, 2340 Beerse, BE
 ALCÁZAR-VACA, Manuel, Jesús, c/o: Janssen-Cilag S.A. Edificio Johnson & Johnson Paseo de las Doce Estrellas 5-7 5° planta Campo de las Naciones, 28042 Madrid, ES

- (51) MKP
A61K 31/542 2006 (97) EP 3592752
A61P 25/28 2006
C07D 513/04 2006
- (96) EP 18710001.1 3/6/2018
 (97) EP 3592752, 1/15/2020 202003, en
- (31) 201762468070 P (32) 07.03.2017 (33) US
 17189778 07.09.2017 EP
- (54) INHIBITORS OF BETA SECRETASE
- (72) VAN BRANDT, Sven, Franciscus, Anna, c/o Janssen Pharmaceutica NV Turnhoutseweg 30, 2340 Beerse, BE
 GIJSEN, Henricus, Jacobus, Maria, c/o Janssen Pharmaceutica NV Turnhoutseweg 30, 2340 Beerse, BE
 VOS, Ann, Marleen, c/o Janssen Pharmaceutica NV Turnhoutseweg 30, 2340 Beerse, BE
 OEHLRICH, Daniel, c/o Janssen Pharmaceutica NV Turnhoutseweg 30, 2340 Beerse, BE

- (51) MKP
A61K 31/426 2006 (97) EP 3592734
A61P 9/00 2006
C07D 277/56 2006
- (96) EP 18710011.0 3/6/2018
 (97) EP 3592734, 1/15/2020 202003, en
- (31) 17382114 (32) 06.03.2017 (33) EP
- (54) AMINE SALT OF (1R,3S)-3-(5-CYANO-4-PHENYL-1,3-THIAZOL-2-YLCARBAMOYL)CYCLOPENTANE CARBOXYLIC ACID
- (72) CASTRO PALOMINO LARIA, Julio, Tecnocampus Mataró 3 Avenida Ernest Lluch 32 Planta 4, Oficina 1., E-08302 Mataró, Barcelona, ES
 CAMACHO GÓMEZ, Juan, Tecnocampus Mataró 3 Avenida Ernest Lluch 32 Planta 4, Oficina 1., E-08302 Mataró, Barcelona, ES

- (51) MKP
A22C 17/00 2006 (97) EP 3582620
B02C 18/36 2006
- (96) EP 18710137.3 2/9/2018
 (97) EP 3582620, 12/25/2019 201952, en
- (31) 201700017473 (32) 16.02.2017 (33) IT
- (54) CUTTING DEVICE WITH MONOLITHIC STRUCTURE
- (72) Quadrana, Marcello, Via Rigosa, 46, 40069 Zola Predosa (BO), IT

- (51) MKP
C25B 1/06 2006 (97) EP 3585926
C25B 9/06 2006
C25B 15/02 2006
C25B 15/08 2006

(96) EP 18710148.0 2/22/2018
 (97) EP 3585926, 1/1/2020 202001, en
 (31) 201700020606 (32) 23.02.2017 (33) IT
 (54) ELECTROLYSIS HEATING SYSTEM
 (72) PUCCI, Aurelio, Via Antonio Santovetti 76, 00046 Grottaferrata (RM), IT

(51) MKP
A61K 39/395 2006 (97) EP 3585821
A61K 47/18 2017
C07K 16/40 2006
 (96) EP 18710193.6 2/22/2018
 (97) EP 3585821, 1/1/2020 202001, en
 (31) 201762462266 P (32) 22.02.2017 (33) US
 (54) LOW-VISCOSITY, HIGH-CONCENTRATION EVOLOCUMAB FORMULATIONS AND METHODS OF MAKING THE SAME
 (72) SLOEY, Christopher James, 474 Calle Veracruz, Newbury Park California 91320, US
 KANAPURAM, Sekhar, 5675 Via Bonita, Thousand Oaks California 91320, US
 CUI, Huanchun, St. Jakobstrasse 68, 4147 Aesch Basel Land, CH
 CHAN, Chio Mui, 1180 NE 63rd Way Unit 1010, Hillsboro Oregon 97124, US
 BINABAJI, Elaheh, 11734 Wilshire Blvd. Apt. C1501, Los Angeles California 90025, US

(51) MKP
A61K 47/65 2017 (97) EP 3589328
A61K 47/68 2017
A61P 35/00 2006
 (96) EP 18710275.1 2/27/2018
 (97) EP 3589328, 1/8/2020 202002, en
 (31) 201762465118 P (32) 28.02.2017 (33) US
 201762480209 P 31.03.2017 US
 (54) MAYTANSINOID DERIVATIVES WITH SELF-IMMOLATIVE PEPTIDE LINKERS AND CONJUGATES THEREOF
 (72) WIDDISON, Wayne, C., 7 Holden Road, Belmont, MA 02478, US

(51) MKP
A61K 35/17 2015 (97) EP 3585402
 (96) EP 18710284.3 2/27/2018
 (97) EP 3585402, 1/1/2020 202001, en
 (31) 201762464371 P (32) 27.02.2017 (33) US
 201762465817 P 01.03.2017 US
 201762470180 P 10.03.2017 US
 201762527002 P 29.06.2017 US
 201762580416 P 01.11.2017 US
 201762584740 P 10.11.2017 US
 201762596703 P 08.12.2017 US
 (54) COMPOSITIONS, ARTICLES OF MANUFACTURE AND METHODS RELATED TO DOSING IN CELL THERAPY
 (71) Juno Therapeutics, Inc., 400 Dexter Ave. N Suite 1200, Seattle, WA 98109-4703, US
 (72) CHRISTIN, Brian, 400 Dexter Ave. N Suite 1200, Seattle Washington 98109-4703, US
 COVINGTON, Michael Gerard, 400 Dexter Ave. N Suite 1200, Seattle Washington 98109-4703, US
 DAVE, Kedar Himanshu, 400 Dexter Ave. N Suite 1200, Seattle Washington 98109-4703, US
 GETTO, Richard James, Jr., 400 Dexter Ave. N Suite 1200, Seattle Washington 98109-4703, US
 KOWSKI, Tom, 400 Dexter Ave. N Suite 1200, Seattle Washington 98109-4703, US
 LARSON, Ryan P., 400 Dexter Ave. N Suite 1200, Seattle Washington 98109-4703, US
 RAMSBORG, Christopher Glen, 400 Dexter Ave. N Suite 1200, Seattle Washington 98109-4703, US
 TREDE, Nikolaus Sebastian, 400 Dexter Ave. N Suite 1200, Seattle Washington 98109-4703, US
 WEBER, Clinton, 400 Dexter Ave. N Suite 1200, Seattle Washington 98109-4703, US
 WHITMORE, James Boyd, 400 Dexter Ave. N Suite 1200, Seattle Washington 98109-4703, US
 YEE, Nathan, 400 Dexter Ave. N Suite 1200, Seattle Washington 98109-4703, US
 BEAUCHESNE, Pascal, c/o Juno Therapeutics Inc. 400 Dexter Ave. N Suite 1200, Seattle Washington 98109-4703, US
 BECKETT, Travis, c/o Juno Therapeutics Inc. 400 Dexter Ave. N Suite 1200, Seattle Washington 98109-4703, US
 BLACKMAN, Samuel Charles, c/o Juno Therapeutics Inc. 400 Dexter Ave. N Suite 1200, Seattle Washington 98109-4703, US
 CHARTRAND, Nathaniel, c/o Juno Therapeutics Inc. 400 Dexter Ave. N Suite 1200, Seattle Washington 98109-4703, US
 DAVIS-PICKETT, Mel, c/o Juno Therapeutics Inc. 400 Dexter Ave. N Suite 1200, Seattle Washington 98109-4703, US
 GILBERT, Mark, c/o Juno Therapeutics Inc. 400 Dexter Ave. N Suite 1200, Seattle Washington 98109-4703, US
 LAMBERT, Nathaniel, c/o Juno Therapeutics Inc. 400 Dexter Ave. N Suite 1200, Seattle Washington 98109-4703, US
 LI, He, c/o Juno Therapeutics Inc. 400 Dexter Ave. N Suite 1200, Seattle Washington 98109-4703, US

MALLANEY, Mary, c/o Juno Therapeutics Inc. 400 Dexter Ave. N Suite 1200, Seattle Washington 98109-4703, US
 POLLOCK, Kathryn Lindsay, c/o Juno Therapeutics Inc. 400 Dexter Ave. N Suite 1200, Seattle Washington 98109-4703, US
 ODEGARD, Valerie, c/o Juno Therapeutics Inc. 400 Dexter Ave. N Suite 1200, Seattle Washington 98109-4703, US
 SMITH, Jeff, c/o Juno Therapeutics Inc. 400 Dexter Ave. N Suite 1200, Seattle Washington 98109-4703, US
 SUTHERLAND, Claire, c/o Juno Therapeutics Inc. 400 Dexter Ave. N Suite 1200, Seattle Washington 98109-4703, US
 WALKER, Andrew W., c/o Juno Therapeutics Inc. 400 Dexter Ave. N Suite 1200, Seattle Washington 98109-4703, US

- (51) MKP
A61K 39/00 2006 (97) EP 3589951
G01N 33/50 2006
G01N 33/569 2006
- (96) EP 18710392.4 3/2/2018
 (97) EP 3589951, 1/8/2020 202002, en
- (31) 17159243 (32) 03.03.2017 (33) EP
 17159242 03.03.2017 EP
 201703809 09.03.2017 GB
- (54) POPULATION-BASED IMMUNOGENIC PEPTIDE IDENTIFICATION PLATFORM
 (71) Treos Bio Zrt., Viola utca 2, 8200 Veszprem, HU
 (72) LISZIEWICZ, Julianna, Szorosi ut 13, 8220 Balatonalmadi, HU
 MOLNÁR, Levente, Kossuth Lajos u. 20., 2363 Felsőpakony, HU
 TÖKE, Enikő, R., Kossuth Lajos u. 20., 2363 Felsőpakony, HU
 TOTH, József, Újkt u. 72, 9012 Gyor, HU
 LORINCZ, Orsolya, Attila u. 27 fszt/13, 1047 Budapest, HU
 CSISZOVSZKI, Zsolt, Bikszádi u. 12/A 4/9, 1119 Budapest, HU
 SOMOGYI, Eszter, Borgazda u. 3, 8220 Balatonalmádi, HU
 PÁNTYA, Katalin, Üllői út 16/b 2.em. 9/b, 1085 Budapest, HU
 MEGYESI, Mónika, Táncsics Mihály u. 63, 3441 Mezokeresztes, HU

- (51) MKP
A61K 38/10 2006 (97) EP 3589305
A61K 45/06 2006
- (96) EP 18710566.3 3/2/2018
 (97) EP 3589305, 1/8/2020 202002, en
- (31) 17158996 (32) 02.03.2017 (33) EP
- (54) SPECIFIC INCREASE OF DOPAMINE SYNTHESIS THROUGH TARGETING OF THE GUANYLATE CYCLASE 2C RECEPTOR IN THE TREATMENT OF PARKINSON'S DISEASE
 (71) Universiteit van Amsterdam, Spui 21, 1012 WX Amsterdam, NL
 (72) VAN DER HEIDE, Lars Philip, c/o Spui 21, 1012 WX Amsterdam, NL

- (51) MKP
C12Q 1/6886 2018 (97) EP 3592867
- (96) EP 18710572.1 3/9/2018
 (97) EP 3592867, 1/15/2020 202003, en
- (31) 17160346 (32) 10.03.2017 (33) EP
- (54) A METHYLATION CLASSIFIER FOR DETECTION OF HPV-INDUCED INVASIVE CANCERS, NONHPV- INDUCED GYNAECOLOGICAL AND ANOGENITAL CANCERS AND THEIR HIGH-GRADE PRECURSOR LESIONS
 (72) MEIJER, Christophorus Johannes Lambertus Maria, c/o Biothof 15 1, 1098 RX Amsterdam, NL
 STEENBERGEN, Renske Daniëla Maria, c/o Biothof 15 1, 1098 RX Amsterdam, NL
 SNIJDERS, Petrus Josephus Ferdinandus, c/o Biothof 15 1, 1098 RX Amsterdam, NL
 HEIDEMAN, Daniëlle Anne Marie, c/o Biothof 15 1, 1098 RX Amsterdam, NL

- (51) MKP
B61K 7/04 2006 (97) EP 3558786
F16D 65/00 2006
F16D 65/04 2006
- (96) EP 18710580.4 2/2/2018
 (97) EP 3558786, 10/30/2019 201944, en
- (31) 201700039 (32) 07.02.2017 (33) SI
- (54) LAMELLA OF RAIL ELEMENT, PREFERABLY RAIL BRAKE AND METHOD OF ITS USE
 (72) Pavcnik, Bojan, Smarska 17, 3320 Velenje, SI

(51) MKP
A61K 9/20 2006 (97) EP 3582814
A61K 31/404 2006
A61K 45/06 2006
A61P 1/00 2006
A61P 1/04 2006
A61P 17/00 2006
A61P 17/02 2006
A61P 37/00 2006

(96) EP 18710583.8 2/16/2018
(97) EP 3582814, 12/25/2019 201952, en

(31) 201762459881 P (32) 16.02.2017 (33) US
201762459870 P 16.02.2017 US

(54) COMPOUNDS AND METHODS FOR TREATMENT OF INFLAMMATORY BOWEL DISEASE WITH EXTRA-INTESTINAL MANIFESTATIONS
(72) LASSEN, Cheryl, Geraldine, Wildstrasse 18 Eglisau, 8193 Zurich, CH

(51) MKP
A61K 9/127 2006 (97) EP 3585417
A61K 38/17 2006
C07K 14/47 2006
C12N 15/10 2006

(96) EP 18710669.5 2/27/2018
(97) EP 3585417, 1/1/2020 202001, en

(31) 201762464215 P (32) 27.02.2017 (33) US

(54) NOVEL CODON-OPTIMIZED CFTR MRNA
(72) DIAS, Anusha, c/o Translate Bio Inc. 200 Sidney Street, Cambridge MA 02139, US
ABYSALH, Jonathan, c/o Translate Bio Inc. 200 Sidney Street, Cambridge MA 02139, US
BETTENCOURT, Brian, c/o Translate Bio Inc. 200 Sidney Street, Cambridge MA 02139, US
DEROSA, Frank, c/o Translate Bio Inc. 200 Sidney Street, Cambridge MA 02139, US
HEARTLEIN, Michael, c/o Translate Bio Inc. 200 Sidney Street, Cambridge MA 02139, US

(51) MKP
A61K 9/16 2006 (97) EP 3589274
A61K 9/20 2006
A61K 9/28 2006
A61K 9/48 2006
A61K 31/27 2006

(96) EP 18710740.4 3/1/2018
(97) EP 3589274, 1/8/2020 202002, en

(31) 201762465675 P (32) 01.03.2017 (33) US
201762468832 P 08.03.2017 US
201762526039 P 28.06.2017 US
201762530515 P 10.07.2017 US

(54) COMPOSITIONS COMPRISING PGI2-RECEPTOR AGONISTS AND PROCESSES FOR THE PREPARATION THEREOF
(72) SHAO, Zezhi Jesse, 11356 Saddle Cove Lane, San Diego, California 92130, US
FLORIDA, Raizza Berania, 488 Boudinot Court, Escondido, California 92027, US
LI, Ching-Yuan, 4215 Camino Sandoval, San Diego, California 92130, US
SELVEY, Lee Alani, 142 Monticello Drive, Longview, WA 98632, US

(51) MKP
A61K 9/107 2006 (97) EP 3573600
A61K 38/10 2006
A61K 38/17 2006

(96) EP 18710760.2 1/24/2018
(97) EP 3573600, 12/4/2019 201949, en

(31) 17305079 (32) 25.01.2017 (33) EP

(54) METHOD FOR MANUFACTURING A STABLE EMULSION FOR PEPTIDE DELIVERY
(72) CONDUZORGUES, Jean-Pascal, 4004 boulevard Paul Valéry, 34070 Montpellier, FR

(51) MKP
A61K 31/505 2006 (97) EP 3592774
A61K 39/395 2006
A61K 47/68 2017

A61P 35/00 2006
A61P 35/02 2006
C07K 16/28 2006
C07K 16/46 2006
 (96) EP 18710841.0 3/9/2018
 (97) EP 3592774, 1/15/2020 202003, en
 (31) 201703876 (32) 10.03.2017 (33) GB
 (54) PHARMACEUTICAL COMBINATIONS COMPRISING AN ANTI-LY75 ANTIBODY
 (71) Berlin-Chemie AG, Glienicke Weg 125-127, 12489 Berlin, DE
 (72) BINASCHI, Monica, Menarini Ricerche Via Tito Speri 10, Pomezia Rome, IT
 BIGIONI, Mario, Menarini Ricerche Via Tito Speri 10, Pomezia Rome, IT
 MERLINO, Giuseppe, Menarini Ricerche Via Tito Speri 10, Pomezia Rome, IT
 SIMONELLI, Cecilia, Menarini Ricerche Via Sette Santi 3, Firenze, IT
 BERTONI, Francesco, Institute of Oncology Research Fondazione per la Ricerca e la Cura sui Linfomi Via Vela 6, 6500 Bellinzona, CH
 PELLACANI, Andrea, Menarini Ricerche Via Sette Santi 3, Firenze, IT

(51) MKP
C12N 15/10 2006 (97) EP 3583230
C12Q 1/6806 2018
 (96) EP 18711191.9 2/15/2018
 (97) EP 3583230, 12/25/2019 201952, en
 (31) 201762459542 P (32) 15.02.2017 (33) US
 201762545248 P 14.08.2017 US
 (54) SYSTEMS AND PROCESSES FOR RAPID NUCLEIC ACID EXTRACTION, PURIFICATION, AND ANALYSIS
 (71) ANDE Corporation, 266 Second Avenue, Waltham, MA 02451, US
 (72) SELDEN, Richard F., 21 Huckelberry Hill, Lincoln, MA 01773, US
 TURINGAN WITKOWSKI, Rosemary, 40 Curve Road, Stoneham, MA 02180, US

(51) MKP
C12N 15/10 2006 (97) EP 3585891
 (96) EP 18711201.6 2/27/2018
 (97) EP 3585891, 1/1/2020 202001, en
 (31) 201762463998 P (32) 27.02.2017 (33) US
 (54) METHODS FOR PURIFICATION OF MESSENGER RNA
 (72) ABYSALH, Jonathan, c/o Translate Bio, Inc. 200 Sidney Street, Cambridge, MA 02139, US
 CRAWFORD, Daniel, c/o Translate Bio, Inc. 200 Sidney Street, Cambridge, MA 02139, US
 DEROSA, Frank, c/o Translate Bio, Inc. 200 Sidney Street, Cambridge, MA 02139, US
 KARVE, Shirang, c/o Translate Bio, Inc. 200 Sidney Street, Cambridge, MA 02139, US
 DIAS, Anusha, c/o Translate Bio, Inc. 200 Sidney Street, Cambridge, MA 02139, US
 HEARTLEIN, Michael, c/o Translate Bio, Inc. 200 Sidney Street, Cambridge, MA 02139, US

(51) MKP
A61K 35/76 2015 (97) EP 3589730
A61K 48/00 2006
C12N 7/00 2006
 (96) EP 18711202.4 2/27/2018
 (97) EP 3589730, 1/8/2020 202002, en
 (31) 201762464748 P (32) 28.02.2017 (33) US
 201762591002 P 27.11.2017 US
 201862614002 P 05.01.2018 US
 (54) ADENO-ASSOCIATED VIRUS (AAV) CLADE F VECTOR AND USES THEREFOR
 (72) WILSON, James, M., 1831 Delancey Street, Philadelphia, PA 19103, US
 WANG, Qiang, 228 West Winona Street 1st Floor, Philadelphia, PA 19144, US
 GILES, April, 844 N. 29th Street Apt 121, Philadelphia, PA 19130, US
 TURNER, Kevin, 124 Beechwood Road, Newtown Square, PA 19073, US

(51) MKP
A61K 9/19 2006 (97) EP 3592391
A61K 31/4965 2006
A61K 47/10 2017
A61P 9/12 2006
A61P 17/02 2006

(96) EP 18711258.6 3/7/2018
 (97) EP 3592391, 1/15/2020 202003, en
 (31) PCT/EP2017/055406 (32) 08.03.2017 (33) WO
 (54) PHARMACEUTICAL COMPOSITION COMPRISING SELEXIPAG
 (71) Actelion Pharmaceuticals Ltd, Gewerbstrasse 16, 4123 Allschwil, CH
 (72) HELLERBRAND, Klaus, c/o ProJect Pharmaceutics GmbH Fraunhoferstrasse 22, 82152 Martinsried, DE
 SCHLICKER-SPAIN, Alexandra, c/o Actelion Pharmaceuticals Ltd Gewerbstrasse 16, 4123 Allschwil, CH

(51) MKP
A61K 31/045 2006 (97) EP 3585367
A61K 36/185 2006
A61P 11/00 2006
 (96) EP 18711300.6 3/13/2018
 (97) EP 3585367, 1/1/2020 202001, de
 (31) 102017005865 (32) 21.06.2017 (33) DE
 102017117836 07.08.2017 DE
 (54) CINEOLE-CONTAINING COMPOSITION FOR TREATING NASAL DISEASES
 (72) UNKAUF, Markus, Liebigstrasse 10A, 80538 München, DE
 WOLLENBERG, Barbara, Grönerweg 68, 23566 Lbeck, DE
 PRIES, Ralph, Up'n Knust 38, 23619 Rehhorst, DE

(51) MKP
A61P 35/00 2006 (97) EP 3571227
C07K 16/22 2006
C07K 16/28 2006
 (96) EP 18711394.9 1/19/2018
 (97) EP 3571227, 11/27/2019 201948, en
 (31) 201762448800 P (32) 20.01.2017 (33) US
 17305061 20.01.2017 EP
 (54) ANTI-TGF-BETA ANTIBODIES AND THEIR USE
 (72) SHAPIRO, Gary, 15 Intervale Road, Arlington, MA 02474, US
 BROWER, Kevin, c/o Sanofi 55 Corporate Drive Mail Code: 55A-505A, Bridgewater, NJ 08807, US
 FINN, Patrick, 472 Dailey Drive, Franklin, MA 02038, US
 GREGORY, Richard, C., c/o Sanofi 55 Corporate Drive Mail Code: 55A-505A, Bridgewater, NJ 08807, US
 KODURI, Rao, c/o Sanofi 55 Corporate Drive Mail Code:55A-505A, Bridgewater, NJ 08807, US
 LIU, Feng, 3987 Montefrio Court, San Diego, CA 92130, US
 MALKOVA, Natalia, c/o Sanofi 55 Corporate Drive Mail Code:55A-505A, Bridgewater, NJ 08807, US
 MANKOO, Parminder, P.O. Box 8174, Foster City, CA 94404, US
 POLLARD, Jack, R., c/o Sanofi 55 Corporate Drive Mail Code:55A-505A, Bridgewater, NJ 08807, US
 QIU, Huawei, c/o Sanofi 55 Corporate Drive Mail Code:55A-505A, Bridgewater, NJ 08807, US
 THEILHABER, Joachim, c/o Sanofi 55 Corporate Drive Mail Code:55A-505A, Bridgewater, NJ 08807, US
 WINTER, Christopher, 169 Bradlee Avenue, Swampscott, MA 01907, US
 YU, Marcella, 34129 Spur Way, Fremont, CA 94555, US

(51) MKP
G16H 50/20 2018 (97) EP 3571700
G16H 50/30 2018
G16H 50/70 2018
 (96) EP 18711395.6 1/22/2018
 (97) EP 3571700, 11/27/2019 201948, en
 (31) 201715412806 (32) 23.01.2017 (33) US
 (54) METHOD AND SYSTEM FOR PREDICTING REFRACTORY EPILEPSY STATUS
 (72) MALHOTRA, Kunal, 266 Ferst Drive NW, Atlanta, GA 30332, US
 AN, Sungtae, 266 Ferst Drive NW, Atlanta, GA 30332, US
 SUN, Jimeng, 266 Ferst Drive NW, Atlanta, GA 30332, US
 CHOI, Myung, 75 5th Street NW, Atlanta, GA 30308, US
 DILLEY, Cynthia, 1950 Lake Park Drive, Smyrna, GA 30080, US
 CLARK, Chris, 1950 Lake Park Drive, Smyrna, GA 30080, US
 ROBERTSON, Joseph, 1950 Lake Park Drive, Smyrna, GA 30080, US
 HAN-BURGESS, Edward, 1950 Lake Park Drive, Smyrna, GA 30080, US

(51) MKP

A61K 39/00 2006 (97) EP 3568412
C07K 14/725 2006
C07K 16/30 2006
C12N 5/16 2006
 (96) EP 18711429.3 1/12/2018
 (97) EP 3568412, 11/20/2019 201947, en
 (31) 201762446084 P (32) 13.01.2017 (33) US
 (54) T CELL RECEPTORS THAT BIND TO NY-ESO-1 AND METHODS OF USE THEREOF
 (72) VAN DIJK, Marc, Tolhuislaan 8A, 3735KG Bosch en Duin, NL
 SEIBERT, Volker, Tumringer Str. 261C, 79539 Lörrach, DE
 MUNDT, Cornelia Anne, Hangstrasse 34, 79539 Lörrach, DE
 HURWITZ, Arthur Andrew, 9 Fitchdale Avenue, Bedford MA 01730, US
 EXLEY, Mark Adrian, 201 Reservoir Road, Brookline MA 02467, US
 WOLF, Benjamin Jacob, 478 Jamaicaway B, Boston MA 02130, US
 LEVENTHAL, Daniel, 18 Ship Ave Unit 1, Medford MA 02155, US
 LALEVÉE, Sébastien, 5 Rue des Cerisiers, 68300 Saint Louis, FR
 MASAKAYAN, Reed, 50 Wells Rd. Apt D8, Lincoln MA 01773, US

(51) MKP
A61K 31/519 2006 (97) EP 3592745
A61P 35/00 2006
C07D 487/04 2006
 (96) EP 18711666.0 3/12/2018
 (97) EP 3592745, 1/15/2020 202003, en
 (31) 201703881 (32) 10.03.2017 (33) GB
 (54) PYRIMIDOPYRIMIDINONES USEFUL AS WEE-1 KINASE INHIBITORS
 (71) Almac Discovery Limited, Almac House 20 Seagoe Industrial Estate, Craigavon, Armagh BT63 5QD, GB
 (72) HEWITT, Peter, c/o Almac Discovery Limited Almac House 20 Seagoe Industrial Estate, Craigavon BT63 5QD, GB
 BURKAMP, Frank, c/o Almac Discovery Limited Almac House 20 Seagoe Industrial Estate, Craigavon BT63 5QD, GB
 WILKINSON, Andrew, c/o Almac Discovery Limited Almac House 20 Seagoe Industrial Estate, Craigavon BT63 5QD, GB
 MIEL, Hugues, c/o Almac Discovery Limited Almac House 20 Seagoe Industrial Estate, Craigavon BT63 5QD, GB
 O'DOWD, Colin, c/o Almac Discovery Limited Almac House 20 Seagoe Industrial Estate, Craigavon BT63 5QD, GB

(51) MKP
C07H 1/06 2006 (97) EP 3585892
C12N 15/10 2006
C12P 19/34 2006
 (96) EP 18711737.9 2/27/2018
 (97) EP 3585892, 1/1/2020 202001, en
 (31) 201762463981 P (32) 27.02.2017 (33) US
 (54) METHODS FOR PURIFICATION OF MESSENGER RNA
 (72) DEROSA, Frank, c/o Translate Bio, Inc. 200 Sidney Street, Cambridge, MA 02139, US
 HEARTLEIN, Michael, c/o Translate Bio, Inc. 200 Sidney Street, Cambridge, MA 02139, US
 ABYSALH, Jonathan, c/o Translate Bio, Inc. 200 Sidney Street, Cambridge, MA 02139, US
 KARVE, Shrirang, c/o Translate Bio, Inc. 200 Sidney Street, Cambridge, MA 02139, US
 DIAS, Anusha, c/o Translate Bio, Inc. 200 Sidney Street, Cambridge, MA 02139, US
 CRAWFORD, Daniel, c/o Translate Bio, Inc. 200 Sidney Street, Cambridge, MA 02139, US

(51) MKP
A61K 31/397 2006 (97) EP 3592742
A61K 31/437 2006
A61P 11/00 2006
C07D 471/04 2006
 (96) EP 18711796.5 3/8/2018
 (97) EP 3592742, 1/15/2020 202003, en
 (31) 201762469073 P (32) 09.03.2017 (33) US
 (54) JAK INHIBITORS CONTAINING A 4-MEMBERED HETEROCYCLIC AMIDE
 (72) FATHEREE, Paul R., 921 Minnesota Street, San Francisco, California 94107, US
 BRANDT, Gary E.L., 2160 Buena Vista Avenue, Alameda, California 94501, US
 SMITH, Cameron, 4256 Shelter Creek Lane, San Bruno, California 94066, US
 SULLIVAN, Steven D.E., 1417 17th Avenue, San Francisco, California 94122, US
 VAN ORDEN, Lori Jean, 362 ParkStreet, San Francisco, California 94110, US
 KLEINSCHER, Melanie A., 30 Elizabeth Street, San Francisco, California 94110, US
 CRATER, Glenn D., 7108 Rippling Stone Lane, Raleigh, North Carolina 27612, US

(51)	MKP							
	A61K 31/415	2006	(97) EP 3589618					
	A61K 31/4155	2006						
	C07D 231/14	2006						
	C07D 401/12	2006						
	C07D 401/14	2006						
	C07D 403/12	2006						
	C07D 403/14	2006						
	C07D 405/12	2006						
	C07D 405/14	2006						
	C07D 413/12	2006						
	C07D 417/12	2006						
	C07D 471/04	2006						
(96)	EP 18712082.9 2/27/2018							
(97)	EP 3589618, 1/8/2020 202002, en							
(31)	201703283		(32)	01.03.2017		(33)		GB
	201716374			06.10.2017				GB
(54)	PYRAZOLE DERIVATIVES AS BROMODOMAIN INHIBITORS							
(72)	ATKINSON, Stephen John, GlaxoSmithKline Gunnels Wood Road, Stevenage Hertfordshire SG1 2NY, GB							
	DEMONT, Emmanuel Hubert, GlaxoSmithKline Gunnels Wood Road, Stevenage Hertfordshire SG1 2NY, GB							
	HARRISON, Lee Andrew, GlaxoSmithKline Gunnels Wood Road, Stevenage Hertfordshire SG1 2NY, GB							
	LIWICKI, Gemma Michele, GlaxoSmithKline Gunnels Wood Road, Stevenage Hertfordshire SG1 2NY, GB							
	LUCAS, Simon Christopher Cranko, GlaxoSmithKline Gunnels Wood Road, Stevenage Hertfordshire SG1 2NY, GB							
	PRESTON, Alexander G, GlaxoSmithKline Gunnels Wood Road, Stevenage Hertfordshire SG1 2NY, GB							
	SEAL, Jonathan, Thomas, GlaxoSmithKline Gunnels Wood Road, Stevenage Hertfordshire SG1 2NY, GB							
	WALL, Ian David, GlaxoSmithKline Gunnels Wood Road, Stevenage Hertfordshire SG1 2NY, GB							
	WATSON, Robert J, GlaxoSmithKline Gunnels Wood Road, Stevenage Hertfordshire SG1 2NY, GB							

(51)	MKP							
	C07K 16/10	2006	(97) EP 3592769					
	C07K 16/28	2006						
(96)	EP 18712124.9 3/9/2018							
(97)	EP 3592769, 1/15/2020 202003, en							
(31)	PA201700164		(32)	09.03.2017		(33)		DK
	PA201700408			11.07.2017				DK
(54)	ANTIBODIES AGAINST PD-L1							
(72)	ALTINTAS, Isil, c/o Genmab B.V. Uppsalalaan 15, 3584 CT Utrecht, NL							
	SATIJN, David, c/o Genmab B.V. Uppsalalaan 15, 3584 CT Utrecht, NL							
	VAN DEN BRINK, Edward, c/o Genmab B.V. Uppsalalaan 15, 3584 CT Utrecht, NL							
	VERZIJL, Dennis, c/o Genmab B.V. Uppsalalaan 15, 3584 CT Utrecht, NL							
	RADEMAKER, Rik, c/o Genmab B.V. Uppsalalaan 15, 3584 CT Utrecht, NL							
	PARREN, Paul, Werdorperwaard 17, 3984 PR Odijk, NL							
	DE GOEIJ, Bart, c/o Genmab B.V. Uppsalalaan 15, 3584 CT Utrecht, NL							

(51)	MKP							
	A61K 31/437	2006	(97) EP 3592743					
	A61P 11/00	2006						
	C07D 471/04	2006						
(96)	EP 18712398.9 3/8/2018							
(97)	EP 3592743, 1/15/2020 202003, en							
(31)	201762469073 P		(32)	09.03.2017		(33)		US
(54)	FUSED IMIDAZO-PIPERIDINE JAK INHIBITORS							
(72)	FATHEREE, Paul R., 921 Minnesota Street, San Francisco, California 94107, US							
	BRANDT, Gary E.L., 2160 Buena Vista Avenue, Alameda, California 94501, US							
	SMITH, Cameron, 4256 Shelter Creek Lane, San Bruno, California 94066, US							
	SULLIVAN, Steven D.E., 1417 17th Avenue, San Francisco, California 94122, US							
	VAN ORDEN, Lori Jean, 3 Whitney Street, San Francisco, California 94131, US							
	KLEINSCHKEK, Melanie A., 30 Elizabeth Street, San Francisco, California 94110, US							
	CRATER, Glenn D., 7108 Rippling Stone Lane, Raleigh, North Carolina 27612, US							

(51)	MKP							
	A61K 9/127	2006	(97) EP 3592728					

A61K 47/20 2006
A61K 47/54 2017
C07C 305/06 2006
C07C 317/18 2006
C08G 65/00 2006
 (96) EP 18713102.4 3/7/2018
 (97) EP 3592728, 1/15/2020 202003, en
 (31) 201762468244 P (32) 07.03.2017 (33) US
 (54) POLYANIONIC DELIVERY OF NUCLEIC ACIDS
 (72) HEARTLEIN, Michael, c/o Translate Bio Inc. 200 Sidney Street, Cambridge, MA 02139, US
 DEROSA, Frank, c/o Translate Bio Inc. 200 Sidney Street, Cambridge, MA 02139, US
 KARVE, Shirang, c/o Translate Bio Inc. 200 Sidney Street, Cambridge, MA 02139, US

(51) MKP
G01N 35/00 2006 (97) EP 3593403
G06K 19/077 2006
H01Q 1/22 2006
H01Q 7/00 2006
 (96) EP 18713726.0 3/9/2018
 (97) EP 3593403, 1/15/2020 202003, en
 (31) 2017900841 (32) 10.03.2017 (33) AU
 2017903507 31.08.2017 AU
 (54) CONTAINER LABELS
 (71) Sato Holdings Kabushiki Kaisha, 7-1 Shimomeguro 1-chome Meguro-ku, Tokyo 153-0064, JP
 (72) PONG, Tai Wai, c/- 32 Burrows Road, St Peters, New South Wales 2044, AU
 GREEN, Daron, c/- 32 Burrows Road, St Peters, New South Wales 2044, AU

(51) MKP
C12N 15/864 2006 (97) EP 3589739
 (96) EP 18713745.0 2/27/2018
 (97) EP 3589739, 1/8/2020 202002, en
 (31) 201762464756 P (32) 28.02.2017 (33) US
 201762515902 P 06.06.2017 US
 201862618437 P 17.01.2018 US
 (54) COMPOSITIONS USEFUL IN TREATMENT OF SPINAL MUSCULAR ATROPHY
 (72) WILSON, James, M., 1831 Delancey Street, Philadelphia, PA 19103, US
 HINDERER, Christian, 212 Brown Street Apt. 8A, Philadelphia, PA 19123, US
 KATZ, Nathan, 1111 Hope Street Unit 3, Stamford, CT 06907, US
 WANG, Qiang, 228 West Winona Street 1st Floor, Philadelphia, PA 19144, US

(51) MKP
C12N 9/12 2006 (97) EP 3585886
C12P 19/34 2006
 (96) EP 18713747.6 2/27/2018
 (97) EP 3585886, 1/1/2020 202001, en
 (31) 201762464043 P (32) 27.02.2017 (33) US
 (54) LARGE SCALE SYNTHESIS OF MESSENGER RNA
 (72) DIAS, Anusha, c/o Translate Bio Inc. 200 Sidney Street, Cambridge, MA 02139, US
 CRAWFORD, Daniel, c/o Translate Bio Inc. 200 Sidney Street, Cambridge, MA 02139, US
 DEROSA, Frank, c/o Translate Bio Inc. 200 Sidney Street, Cambridge, MA 02139, US
 ABYSALH, Jonathan, c/o Translate Bio Inc. 200 Sidney Street, Cambridge, MA 02139, US
 HEARTLEIN, Michael, c/o Translate Bio Inc. 200 Sidney Street, Cambridge, MA 02139, US

(51) MKP
A61K 39/395 2006 (97) EP 3570885
A61P 3/10 2006
C07K 16/28 2006
 (96) EP 18714635.2 1/16/2018
 (97) EP 3570885, 11/27/2019 201948, en
 (31) 201762447332 P (32) 17.01.2017 (33) US
 (54) METHOD OF TREATING OR AMELIORATING METABOLIC DISORDERS USING GLP-1 RECEPTOR AGONISTS CONJUGATED TO ANTAGONISTS FOR GASTRIC INHIBITORY PEPTIDE RECEPTOR (GIPR)

- (72) CHENG, Yuan, 5329 Via Jacinto, Newbury Park, California 91320, US
 NETIROJJANAKUL, Chawita, 4631 Kester Ave. Apt. 103, Sherman Oaks, California 91403, US
 HOLDER, Jerry Ryan, 1102 Waltham Road, Simi Valley, California 93065, US
 WU, Bin, 3090 Hollycrest Avenue, Thousand Oaks, California 91362, US
 FALSEY, James R., 13209 Peach Hill Road, Moorpark, California 93021, US
 HERBERICH, Bradley J., 1746 Hays Drive, Newbury Park, California 91320, US
 SHAM, Kelvin, 3111 La Casa Court, Thousand Oaks, California 91362, US
 MIRANDA, Leslie P., 3586 Mapleknoll Place, Thousand Oaks, California 91362, US
 LU, Shu-Chen, 2356 Rutland Place, Thousand Oaks, California 91362, US
 VENIANT-ELLISON, Murielle M., 645 Camino Manzanitas, Thousand Oaks, California 91360, US
 STANISLAUS, Shanaka, 4196 Minnetota Drive, Thousand Oaks, California 91360, US
 YIE, Junming, 4 Sugarwood Way, Warren, New Jersey 07059, US
 XU, Jing, 67 Bishops Forest Drive, Waltham, Massachusetts 02452, US

- (51) MKP
A61N 5/10 2006 (97) EP 3585482
- (96) EP 18714697.2 2/22/2018
 (97) EP 3585482, 1/1/2020 202001, en
- (31) 201715441898 (32) 24.02.2017 (33) US
- (54) RADIATION TREATMENT PLANNING AND DELIVERY USING COLLISION FREE REGIONS
 (71) Varian Medical Systems International AG, Hinterbergstrasse 14, 6330 Cham, CH
 Varian Medical Systems Inc, 3100 Hansen Way, Palo Alto, CA 94304, US
 (72) NORD, Janne, Alilahde 11, 02620 Espoo, FI
 PYYRY, Joakim, Intiankatu 6 A 1, 00560 Helsinki, FI
 HARRINGTON, Adam, 39 Hollis Landing, Glastonbury Connecticut 06033, US
 HERRIES, Sean, 165 Crescent Avenue, San Francisco California 94110, US
 SCHUMM, Joseph, 1124 Lake Washington Blvd, South Seattle Washington 98144, US
 FILIBERTI, Reto, Rosenweg 16a, 6340 Baar, CH
 JYRKKALA, Kari, Valhallankatu 6 a 15, 00250 Helsinki, FI
 SPIESSENS, Sylvie, Brugsesteenweg 71, 8531 Hulste-Harelbeke, BE
 MEIER, Roland, Amelie Moser Strasse 9, 33600 Herzogenbuchsee, CH
 GASSER, Dominique, Luxhaldenstrasse 1b, 5453 Oberrohrdorf, CH

- (51) MKP
A61K 31/404 2006 (97) EP 3582772
A61K 31/575 2006
A61P 1/16 2006
- (96) EP 18715275.6 2/16/2018
 (97) EP 3582772, 12/25/2019 201952, en
- (31) 201762459916 P (32) 16.02.2017 (33) US
 201762502129 P 05.05.2017 US
 201762506906 P 16.05.2017 US
- (54) COMPOUNDS AND METHODS FOR TREATMENT OF PRIMARY BILIARY CHOLANGITIS
 (72) LASSEN, Cheryl Geraldine, Wildstrasse 18 Eglisau, 8193 Zurich, CH
 JONES, Robert Mark, 400 Mariners Island Boulevard, No. 301, San Mateo, CA 94404, US
 LIU, Que, 13298 Gunner Avenue, San Diego, CA 92129, US
 CHRISTOPHER, Ronald J., 1059 Snipe Court, Carlsbad, CA 92011, US

- (51) MKP
C12Q 1/6883 2018 (97) EP 3571321
- (96) EP 18715826.6 1/19/2018
 (97) EP 3571321, 11/27/2019 201948, en
- (31) 201762449335 P (32) 23.01.2017 (33) US
 201762472972 P 17.03.2017 US
 201762581918 P 06.11.2017 US
- (54) HYDROXYSTEROID 17-BETA DEHYDROGENASE 13 (HSD17B13) VARIANTS AND USES THEREOF
 (72) ABUL-HUSN, Noura S., 777 Old Saw Mill River Road, Tarrytown New York 10591, US
 GOTTESMAN, Omri, 777 Old Saw Mill River Road, Tarrytown New York 10591, US
 LI, Alexander, 777 Old Saw Mill River Road, Tarrytown New York 10591, US
 CHENG, Xiping, 777 Old Saw Mill River Road, Tarrytown New York 10591, US
 XIN, Yurong, 777 Old Saw Mill River Road, Tarrytown NY 10591, US
 GROMADA, Jesper, 777 Old Saw Mill River Road, Tarrytown New York 10591, US
 DEWEY, Frederick E., 777 Old Saw Mill River Road, Tarrytown New York 10591, US

BARAS, Aris, 777 Old Saw Mill River Road, Tarrytown New York 10591, US
 SHULDINER, Alan, 777 Old Saw Mill River Road, Tarrytown New York 10591, US

(51) MKP
A61H 33/00 2006 (97) EP 3576708
A61H 33/14 2006
A61H 35/00 2006
 (96) EP 18715952.0 1/24/2018
 (97) EP 3576708, 12/11/2019 201950, en
 (31) 1700043 (32) 31.01.2017 (33) HU
 1700334 02.08.2017 HU
 (54) APPARATUS FOR TRANSCUTANEOUS TREATMENT BY GAS
 (71) Berta, Zsolt Zoltán, Munkácsy út 8., 3078 Bánytereny, HU
 Tóth, Béla Ern, Jablonka út 113., 1037 Budapest, HU
 (72) Berta, Zsolt Zoltán, Munkácsy út 8., 3078 Bánytereny, HU
 Tóth, Béla Ern, Jablonka út 113., 1037 Budapest, HU

(51) MKP
F28D 1/04 2006 (97) EP 3593075
F28F 1/16 2006
 (96) EP 18715986.8 3/7/2018
 (97) EP 3593075, 1/15/2020 202003, en
 (31) 201700025518 (32) 08.03.2017 (33) IT
 (54) WALL-MOUNTED RADIANT COOLING DEVICE
 (71) Equoclimate Srl, Via Mazzini 10, 26030 Gabbioneta Binanuova, IT
 (72) QUINZANINI, Roberto, Cascina Cigola Martinoni, 25020 Cigole, IT
 GAVIZZOLI, Massimo, Via Chioderolo 6, 25134 Brescia, IT

(51) MKP
A61K 31/444 2006 (97) EP 3581572
A61P 11/06 2006
A61P 13/12 2006
A61P 17/06 2006
A61P 19/02 2006
A61P 27/02 2006
A61P 29/00 2006
A61P 35/00 2006
C07D 417/14 2006
 (96) EP 18716648.3 1/19/2018
 (97) EP 3581572, 12/18/2019 201951, en
 (31) 201730065 (32) 20.01.2017 (33) ES
 (54) ADENOSINE A3 RECEPTOR MODULATORS
 (72) CASTRO PALOMINO LARIA, Julio, Palobiofarma S.L Tecnocampus Mataró 3 Avenida Ernest Lluch 32 Planta 4 Oficina 01, E-08302 Mataró (Barcelona), ES
 CAMACHO GÓMEZ, Juan, Palobiofarma S.L Tecnocampus Mataró 3 Avenida Ernest Lluch 32 Planta 4 Oficina 01, E-08302 Mataró - Barcelona, ES
 EL MAATOUGUI, Abdelaziz, Palobiofarma. CEIN Nave B-2 Plaza CEIN Polígono Industrial Mocholí, E-31110 Noáin (Navarra), ES

(51) MKP
A63C 19/00 2006 (97) EP 3582863
A63C 19/08 2006
 (96) EP 18717111.1 2/15/2018
 (97) EP 3582863, 12/25/2019 201952, en
 (31) 1700029 U (32) 16.02.2017 (33) HU
 (54) SPORTS FACILITY FOR KINDERGARTNERS
 (71) Globál Sport KFT., Tömös utca 17., 4030 Debrecen, HU
 (72) MOLNÁR, András, Homokkert utca 27., 4030 Debrecen, HU
 MOLNÁR, Andrea, Komjádi Béla utca 3., 3/18., 1023 Budapest, HU

(51) MKP
G01R 1/04 2006 (97) EP 3568707
G01R 11/04 2006

G01R 11/24 2006
G01R 22/06 2006
(96) EP 18717113.7 1/11/2018
(97) EP 3568707, 11/20/2019 201947, en
(31) 392017 (32) 12.01.2017 (33) CH
(54) ENCLOSURE ASSEMBLY AND METERING APPARATUS COMPRISING SAME
(71) Landis+Gyr AG, Theilerstrasse 1, 6301 Zug, CH
(72) CAKEBREAD, Andrew, 1B Baltimore Rise Orton Southgate, Peterborough PE2 6SP, GB

(51) MKP
C08G 8/22 2006 (97) EP 3589668
C08L 21/00 2006
C08L 61/12 2006
C08L 61/14 2006
C08L 77/00 2006
C09J 161/14 2006
(96) EP 18717141.8 2/28/2018
(97) EP 3589668, 1/8/2020 202002, en
(31) 201762464894 P (32) 28.02.2017 (33) US
(54) NOVOLAC RESINS AND USE IN RUBBER COMPOSITIONS
(71) Sumitomo Chemical Advanced Technologies LLC, D.B.A Sumika Electronic Materials 3832 East Watkins, Phoenix, Arizona 85034, US
(72) ITAHASHI, Tamon, c/o Sumitomo Chemical Advanced Technologies LLC D.B.A. Sumika Electronic Materials 3832 East Watkins, Phoenix, Arizona 85034, US
MCNAUGHTON, David, P., c/o Sumitomo Chemical Advanced Technologies LLC D.B.A. Sumika Electronic Materials 3832 East Watkins, Phoenix, Arizona 85034, US
TAJIMA, Koichiro, c/o Sumitomo Chemical Advanced Technologies LLC D.B.A. Sumika Electronic Materials 3832 East Watkins, Phoenix, Arizona 85034, US
WALKUP, C. Michael, c/o Sumitomo Chemical Advanced Technologies LLC D.B.A. Sumika Electronic Materials 3832 East Watkins, Phoenix, Arizona 85034, US

(51) MKP
A01K 87/04 2006 (97) EP 3585166
(96) EP 18719642.3 2/21/2018
(97) EP 3585166, 1/1/2020 202001, en
(31) 201700020303 (32) 23.02.2017 (33) IT
(54) GUIDING DEVICE FOR FISHING RODS
(71) Val Mar S.r.l., Via Cortenuova snc, 24050 Cividate al Piano, IT
(72) BELLEBONO, Alessandro, Via Locatelli 50, 24050 Cividate Al Piano, IT
GIORGI, Giuliano, Via Belvedere 7, 25050 Ome, IT

(51) MKP
A41D 13/06 2006 (97) EP 3582645
A43B 3/10 2006
(96) EP 18719994.8 2/14/2018
(97) EP 3582645, 12/25/2019 201952, en
(31) 201700015072 U (32) 14.02.2017 (33) IT
(54) INSOLE AND ITS PROCESS OF MANUFACTURING
(71) Nakefit Company S.r.l., Via Aurelio Saffi n. 134, 20123 Milano, IT
(72) ALTERIO, Sabato, c/o Nakefit Company S.r.l. Via Aurelio Saffi 34, 20123 Milano, IT

(51) MKP
A61K 39/00 2006 (97) EP 3571221
C07K 14/47 2006
C07K 14/705 2006
C12N 5/0783 2010
(96) EP 18729743.7 1/19/2018
(97) EP 3571221, 11/27/2019 201948, en
(31) 201762448936 P (32) 20.01.2017 (33) US
(54) CELL SURFACE CONJUGATES AND RELATED CELL COMPOSITIONS AND METHODS
(71) Juno Therapeutics GmbH, Grillparzerstrasse 10, 81675 Munich, DE
(72) GERMEROOTH, Lothar, Grillparzerstrasse 10, Munich 81675, DE
STEMBERGER, Christian, Grillparzerstrasse 10, Munich 81675, DE

(51) MKP
C23C 2/00 2006 (97) EP 3592878
C23C 2/02 2006
C23C 2/04 2006
C23C 2/06 2006
C23C 2/26 2006
C25D 17/06 2006
C25D 17/08 2006
F16B 45/00 2006

(96) EP 18730227.8 5/15/2018
(97) EP 3592878, 1/15/2020 202003, de

(31) 102017117860 (32) 07.08.2017 (33) DE
102017008098 29.08.2017 DE
102017120782 08.09.2017 DE

(54) HOT-DIP GALVANIZING METHOD AND CARRYING AND/OR HOLDING MEANS FOR THE HOT-DIP GALVANIZING
(72) PINGER, Thomas, Zum Imberg 24, 45721 Haltern am See, DE

(51) MKP
A61K 31/454 2006 (97) EP 3566055
C07D 413/14 2006
C07D 417/14 2006
G01N 33/68 2006

(96) EP 18735798.3 1/5/2018
(97) EP 3566055, 11/13/2019 201946, en

(31) 201762443066 P (32) 06.01.2017 (33) US

(54) METHODS FOR THE TREATMENT OF NEUROLOGICAL DISORDERS
(72) VINCENT, Benjamin, 9 Locke Street Apt. 2, Cambridge, MA 02140, US
TARDIFF, Daniel, 48 Newland Road, Arlington, MA 02474, US
PIOTROWSKI, Jeff, 171 Walnut Street, 3, Somerville, MA 02145, US
SOLIS, Eric, 29 Princess Pine Lane, Milford, MA 01757, US
SCANNEVIN, Robert, 26 Huckleberry Road, Hopkinton, MA 01748, US
CHUNG, Chee-Yeun, 416 Clinton Road, Brookline, MA 02445, US
ARON, Rebecca, 1 Whittamore Avenue, 104, Cambridge, MA 02140, US
LE BOURDONNEC, Bertrand, 2 Mohican Avenue, Northborough, MA 01532, US
LUCAS, Matthew, 48 Parker Street, Lexington, MA 02421, US
RHODES, Kenneth, 86 Juniper Road, Belmont, MA 02478, US

(51) MKP
A61K 31/407 2006 (97) EP 3565551
A61K 31/69 2006
A61P 13/02 2006
A61P 13/12 2006
A61P 31/04 2006

(96) EP 18735813.0 1/8/2018
(97) EP 3565551, 11/13/2019 201946, en

(31) 201762444238 P (32) 09.01.2017 (33) US
201762513936 P 01.06.2017 US

(54) METHODS OF TREATING BACTERIAL INFECTIONS
(71) Rempex Pharmaceuticals, Inc., 300 TriState International, Suite 272, Lincolnshire, Illinois 60069, US
(72) LOUTIT, Jeffrey, S., 300 TriState International, Suite 272, Lincolnshire, Illinois 60069, US
DUDLEY, Michael, N., 300 TriState International, Suite 272, Lincolnshire, Illinois 60069, US
MORGAN, Elizabeth, E., 300 TriState International, Suite 272, Lincolnshire, Illinois 60069, US
FUSARO, Karen, 300 TriState International, Suite 272, Lincolnshire, Illinois 60069, US
GRIFFITH, David, C., 300 TriState International, Suite 272, Lincolnshire, Illinois 60069, US
LOMOVSKAYA, Olga, 300 TriState International, Suite 272, Lincolnshire, Illinois 60069, US

(51) MKP
A61K 31/65 2006 (97) EP 3582786
A61K 38/12 2006
A61P 31/04 2006

(96) EP 18736291.8 1/8/2018
(97) EP 3582786, 12/25/2019 201952, en

(31) 201762444235 P (32) 09.01.2017 (33) US
 201762488528 P 21.04.2017 US
 (54) CO-ADMINISTRATION OF MINOCYCLINE AND COLISTIN TO REDUCE ACUTE KIDNEY INJURY
 (72) DUDLEY, Michael N., 300 TriState International, Suite 272, Lincolnshire, Illinois 60069, US
 GRIFFITH, David C., 300 TriState International, Suite 272, Lincolnshire, Illinois 60069, US

(51) MKP
A61K 31/58 2006 (97) EP 3565560
A61K 31/69 2006
A61K 39/395 2006
C07J 43/00 2006
C07K 16/28 2006
C12Q 1/68 2018
 (96) EP 18736583.8 1/9/2018
 (97) EP 3565560, 11/13/2019 201946, en
 (31) 201762443831 P (32) 09.01.2017 (33) US
 201762473507 P 20.03.2017 US
 201762561218 P 21.09.2017 US
 (54) PREDICTIVE AND DIAGNOSTIC METHODS FOR PROSTATE CANCER
 (72) NANDABALAN, Krishnan, c/o Bioxcel Therapeutics Inc. 780 East Main Street, Branford, Connecticut 06405, US
 RASTELLI, Luca, c/o Bioxcel Therapeutics Inc. 780 East Main Street, Branford, Connecticut 06405, US

(51) MKP
E01F 9/30 2016 (97) EP 3567162
E01F 15/02 2006
G08B 1/08 2006
 (96) EP 18736729.7 1/3/2018
 (97) EP 3567162, 11/13/2019 201946, en
 (31) 201730013 (32) 05.01.2017 (33) ES
 (54) IMPROVED ROAD PROTECTION BARRIER
 (72) Sanchez De La Cruz, Jose Manuel, Avenida 308 25, 08860 Castelldefels, ES

(51) MKP
A61N 5/00 2006 (97) EP 3568199
 (96) EP 18738677.6 3/8/2018
 (97) EP 3568199, 11/20/2019 201947, en
 (31) 201762445008 P (32) 11.01.2017 (33) US
 (54) MITIGATION OF INTERPLAY EFFECT IN PARTICLE RADIATION THERAPY
 (71) Varian Medical Systems, Inc., 3100 Hansen Way, Palo Alto, California 94304, US
 (72) POULSEN, Per, Rugaard, Chr. Winthers Vej 79, 8230 Abyhoj, DK
 ELEY, John, 5910 Brackenridge Ave., Baltimore MD 21212, US
 LANGNER, Ulrich, 12026 Lamplighters Dr., Ellicott City MD 21042, US
 LANGEN, Katja, 777 S. Eden Street 610, Baltimore MD 21231, US

(51) MKP
C07K 16/18 2006 (97) EP 3569709
C12N 1/15 2006
C12N 1/19 2006
C12N 1/21 2006
C12N 5/10 2006
C12N 15/09 2006
C12P 21/08 2006
G01N 33/574 2006
 (96) EP 18738824.4 1/10/2018
 (97) EP 3569709, 11/20/2019 201947, en
 (31) 2017001732 (32) 10.01.2017 (33) JP
 (54) ANTI-GPC3 ANTIBODY
 (71) Noile-Immune Biotech, Inc., 2-12-10, Shiba-Daimon Minato-ku, Tokyo 1050012, JP
 (72) TAMADA, Koji, c/o Yamaguchi University School of Medicine 1-1, Minamikogushi 1-chome, Ube-shi Yamaguchi 755-8505, JP
 SAKODA, Yukimi, c/o Yamaguchi University School of Medicine 1-1, Minamikogushi 1-chome, Ube-shi Yamaguchi 755-8505, JP
 NAKATSURA, Tetsuya, c/o National Cancer Center Hospital East 6-5-1, Kashiwanoha, Kashiwa-shi Chiba 277-8577, JP
 SAITO, Keigo, c/o National Cancer Center Hospital East 6-5-1, Kashiwanoha, Kashiwa-shi Chiba 277-8577, JP

(51) MKP
A61P 35/00 2006 (97) EP 3568471
C12N 5/09 2010
C12N 15/02 2006
(96) EP 18739163.6 1/11/2018
(97) EP 3568471, 11/20/2019 201947, en
(31) 201762444945 P (32) 11.01.2017 (33) US
201762515892 P 06.06.2017 US
(54) PERSONALIZED VACCINES
(71) Kufe, Donald, 179 Grove Street, Wellesley, MA 02482, US
(72) KUFE, Donald, 179 Grove Street, Wellesley MA 02482, US

(51) MKP
A61K 39/02 2006 (97) EP 3571288
C12N 1/15 2006
C12N 1/38 2006
C12N 15/03 2006
(96) EP 18741179.8 1/23/2018
(97) EP 3571288, 11/27/2019 201948, en
(31) 201762449228 P (32) 23.01.2017 (33) US
201762541293 P 04.08.2017 US
(54) INDUCTION OF PROTECTIVE IMMUNITY AGAINST ANTIGENS
(72) CURTISS, Roy, III, 2321 N.W. 23rd Terrace, Gainesville, FL 32605-2807, US
WANG, Shifeng, 3515 SW 39th Blvd Apt 32C, Gainesville, FL 32608-6547, US

(51) MKP
A61K 47/68 2017 (97) EP 3571230
C07K 16/28 2006
C12N 5/00 2006
(96) EP 18741244.0 1/19/2018
(97) EP 3571230, 11/27/2019 201948, en
(31) 201762448741 P (32) 20.01.2017 (33) US
201762595977 P 07.12.2017 US
(54) COMPOSITIONS AND METHODS FOR THE DEPLETION OF CD137+ CELLS
(71) Magenta Therapeutics, Inc., 100 Technology Square 5th Floor, Cambridge, Massachusetts 02139, US
(72) HARTIGAN, Adam, 84 Harvard Avenue Apt. 2, Brookline, Massachusetts 02446, US
BOITANO, Anthony, 27 Evelyn Road, Newton, Massachusetts 02468, US
COOKE, Michael, 135 University Road No. 1, Brookline, Massachusetts 02445, US
HOBAN, Megan D., 399 High Street Unit 1, Medford, Massachusetts 02155, US
PALCHAUDHURI, Rahul, 46 Springfield Street Apt. 2, Somerville, Massachusetts 02143, US

(51) MKP
A01H 5/00 2018 (97) EP 3570664
A01N 37/18 2006
A01N 61/00 2006
(96) EP 18742012.0 1/23/2018
(97) EP 3570664, 11/27/2019 201948, en
(31) 201715412420 (32) 23.01.2017 (33) US
(54) COMPOSITIONS AND METHODS FOR PROTECTING HOSTS AGAINST PATHOGEN INFECTIONS
(71) Innate Immunity LLC, 1475 Bishops Lodge Road, Santa Fe, New Mexico 87506, US
(72) GUPTA, Goutam, 1475 Bishops Lodge Road, Santa Fe New Mexico 87506, US

(51) MKP
C02F 1/44 2006 (97) EP 3571163
C07D 301/32 2006
G01N 33/00 2006
(96) EP 18742212.6 1/18/2018
(97) EP 3571163, 11/27/2019 201948, en
(31) 201762448337 P (32) 19.01.2017 (33) US
(54) METHODS AND SYSTEMS FOR TREATMENT OF ETHYLENE OXIDE
(72) POKROVSKI, Konstantin, A., C/o Novomer Inc. 1 Bowdoin Square Suite 300, Boston MA 02114, US

RUHL, John, B., C/o Novomer Inc. 1 Bowdoin Square Suite 300, Boston MA 02114, US
 TSEITLIN, Alexander, C/o Novomer Inc. 1 Bowdoin Square Suite 300, Boston MA 02114, US
 SHERRY, Kyle, C/o Novomer Inc. 1 Bowdoin Square Suite 300, Boston MA 02114, US

- (51) MKP
A61K 38/08 2019 (97) EP 3570873
A61K 38/10 2006
A61K 38/16 2006
A61K 38/17 2006
A61K 38/22 2006
A61P 3/00 2006
A61P 7/06 2006
A61P 13/12 2006
- (96) EP 18742291.0 1/18/2018
 (97) EP 3570873, 11/27/2019 201948, en
- (31) 201762447710 P (32) 18.01.2017 (33) US
 201762454322 P 03.02.2017 US
 201762554115 P 05.09.2017 US
- (54) COMPOSITIONS AND METHODS FOR TREATING IRON OVERLOAD
 (71) La Jolla Pharmaceutical Company, 4550 Towne Centre Court, San Diego, CA 92121, US
 (72) TIDMARSH, George, 45 Tintern Lane, Portola Valley CA 94028, US
 CHAWLA, Lakhmir, 5010 Zimmer Cove, San Diego CA 92130, US

- (51) MKP
H04L 29/08 2006 (97) EP 3576377
- (96) EP 18744042.5 1/17/2018
 (97) EP 3576377, 12/4/2019 201949, en
- (31) 201710060358 (32) 24.01.2017 (33) CN
- (54) GAME SERVER SWITCHING METHOD, RELEVANT DEVICE AND SYSTEM
 (72) LIU, Lin, 35/F, Tencent Building, Kejizhongyi Road, Midwest District of Hi-Tech Park, Nanshan District,, Shenzhen, GUANGDONG 518057,, CN
 DING, Xiaocheng, 35/F, Tencent Building, Kejizhongyi Road, Midwest District of Hi-Tech Park, Nanshan District,, Shenzhen, GUANGDONG 518057,, CN

- (51) MKP
A61K 31/4439 2006 (97) EP 3575284
A61K 31/496 2006
A61P 13/12 2006
A61P 37/06 2006
A61P 37/08 2006
C07D 207/16 2006
C07D 401/10 2006
C07D 403/10 2006
- (96) EP 18744079.7 1/23/2018
 (97) EP 3575284, 12/4/2019 201949, en
- (31) 2017010321 (32) 24.01.2017 (33) JP
- (54) PHENYLDIFLUOROMETHYL-SUBSTITUTED PROLINEAMIDE COMPOUND
 (72) NAKAJIMA, Yutaka, c/o Astellas Pharma Inc. 5-1 Nihonbashi-Honcho 2-chome Chuo-ku, Tokyo 103-8411, JP
 IMADA, Sunao, c/o Astellas Pharma Inc. 5-1 Nihonbashi-Honcho 2-chome Chuo-ku, Tokyo 103-8411, JP
 YAMAMOTO, Eriko, c/o Astellas Pharma Inc. 5-1 Nihonbashi-Honcho 2-chome Chuo-ku, Tokyo 103-8411, JP
 TSUCHIYA, Kazuyuki, c/o Astellas Pharma Inc. 5-1 Nihonbashi-Honcho 2-chome Chuo-ku, Tokyo 103-8411, JP
 HARAYAMA, Yu, c/o Astellas Pharma Inc. 5-1 Nihonbashi-Honcho 2-chome Chuo-ku, Tokyo 103-8411, JP
 MATSUMOTO, Shunichiro, c/o Astellas Pharma Inc. 5-1 Nihonbashi-Honcho 2-chome Chuo-ku, Tokyo 103-8411, JP

- (51) MKP
B65G 1/04 2006 (97) EP 3573906
B65G 1/06 2006
- (96) EP 18744470.8 1/26/2018
 (97) EP 3573906, 12/4/2019 201949, en
- (31) 20175075 (32) 27.01.2017 (33) FI
- (54) SYSTEM FOR AN AUTOMATED STORAGE
 (72) UTRIAINEN, Otto, Mikkelintie 1725, 77350 Montola, FI
 VARTIAINEN, Jari, Routiontie 11, 76850 Naarajärvi, FI

-
- (51) MKP
C12N 1/00 2006 (97) EP 3574081
C12N 1/21 2006
C12N 9/00 2006
C12N 9/04 2006
C12N 15/52 2006
C12N 15/63 2006
C12P 7/16 2006
- (96) EP 18744512.7 1/30/2018
(97) EP 3574081, 12/4/2019 201949, en
- (31) 201762451819 P (32) 30.01.2017 (33) US
201762504626 P 11.05.2017 US
201762512312 P 30.05.2017 US
201762588985 P 21.11.2017 US
- (54) METHODS AND MICROORGANISMS FOR MAKING 2,3-BUTANEDIOL AND DERIVATIVES THEREOF FROM C1 CARBONS
(72) ZHAO, Xinhua, 2771 Alliston Loop, Dublin California 94568, US
HELD, Mark, Anton, 1030 45th Street Rear, Emeryville California 94608, US
HUYNH, Tina, 3301 High Street, Oakland California 94619, US
CHAO, Lily, Yuin, 72 Langton Street Unit 3, San Francisco California 94103, US
TRINH, Na, 1839 Ygnacio Valley Road 181, Walnut Creek California 94598, US
SCHAMLISCH, Matthias, Helmut, 340 Holly Avenue, South San Francisco California 94080, US
YEH, Bryan, 156 Arlene Drive, Walnut Creek California 94595, US
KEALEY, James, 945 Midpine Way, Sebastopol California 95472, US
DIETZEL, Kevin, Lee, 963 Fassler Avenue, Pacifica California 94044, US
-
- (51) MKP
G06F 3/06 2006 (97) EP 3575948
- (96) EP 18744537.4 1/23/2018
(97) EP 3575948, 12/4/2019 201949, en
- (31) 201710055111 (32) 24.01.2017 (33) CN
- (54) SHARED DATA RECOVERY METHOD, DEVICE, COMPUTER EQUIPMENT AND STORAGE MEDIUM
(72) GUO, Rui, 35/F, Tencent Building, Kejizhongyi Road, Midwest District of Hi-Tech Park, Nanshan District,, Shenzhen, Guangdong 518057, CN
LI, Maocai, 35/F, Tencent Building, Kejizhongyi Road, Midwest District of Hi-Tech Park, Nanshan District,, Shenzhen, Guangdong 518057, CN
ZHANG, Jianjun, 35/F, Tencent Building, Kejizhongyi Road, Midwest District of Hi-Tech Park, Nanshan District,, Shenzhen, Guangdong 518057, CN
TU, Haitao, 35/F, Tencent Building, Kejizhongyi Road, Midwest District of Hi-Tech Park, Nanshan District,, Shenzhen, Guangdong 518057, CN
ZHAO, Qi, 35/F, Tencent Building, Kejizhongyi Road, Midwest District of Hi-Tech Park, Nanshan District,, Shenzhen, Guangdong 518057, CN
WANG, Zongyou, 35/F, Tencent Building, Kejizhongyi Road, Midwest District of Hi-Tech Park, Nanshan District,, Shenzhen, Guangdong 518057, CN
LIANG, Jun, 35/F, Tencent Building, Kejizhongyi Road, Midwest District of Hi-Tech Park, Nanshan District,, Shenzhen, Guangdong 518057, CN
ZHU, Dawei, 35/F, Tencent Building, Kejizhongyi Road, Midwest District of Hi-Tech Park, Nanshan District,, Shenzhen, Guangdong 518057, CN
CHEN, Lisheng, 35/F, Tencent Building, Kejizhongyi Road, Midwest District of Hi-Tech Park, Nanshan District,, Shenzhen, Guangdong 518057, CN
LIU, Binhua, 35/F, Tencent Building, Kejizhongyi Road, Midwest District of Hi-Tech Park, Nanshan District,, Shenzhen, Guangdong 518057, CN
-
- (51) MKP
A61K 39/02 2006 (97) EP 3573654
C07K 14/205 2006
C12N 15/74 2006
- (96) EP 18745001.0 1/26/2018
(97) EP 3573654, 12/4/2019 201949, en
- (31) 201762451146 P (32) 27.01.2017 (33) US
- (54) A FOOD SAFETY VACCINE TO CONTROL SALMONELLA ENTERICA AND REDUCE CAMPYLOBACTER IN POULTRY
(71) University of Florida Research Foundation, Incorporated, 223 Grinter Hall, Gainesville FL 32611, US
(72) CURTISS, III, Roy, 2801 NW 23rd Blvd. Apt. 129, Gainesville, FL 32605, US
WANDA, Soo-Young, 2801 NW 23rd Blvd. Apt. 129, Gainesville, FL 32605, US
-
- (51) MKP
A63F 13/822 2014 (97) EP 3574966
- (96) EP 18745479.8 1/17/2018
(97) EP 3574966, 12/4/2019 201949, en

(31) 201710060614 (32) 25.01.2017 (33) CN
 (54) PROCESSING METHOD FOR DISPLAYING DATA AT CLIENT, AND RELATED DEVICE
 (72) ZHANG, Zhenxing, 35/F, Tencent Building, Kejizhongyi Road, Midwest District of Hi-Tech Park, Nanshan District, Shenzhen,, Guangdong 518057,, CN
 ZHANG, Ran, 35/F, Tencent Building, Kejizhongyi Road, Midwest District of Hi-Tech Park, Nanshan District,, Shenzhen, Guangdong 518057,, CN
 QIU, Bin, 35/F, Tencent Building, Kejizhongyi Road, Midwest District of Hi-Tech Park, Nanshan District,, Shenzhen, Guangdong 518057,, CN
 FANG, Zhongkang, 35/F, Tencent Building, Kejizhongyi Road, Midwest District of Hi-Tech Park, Nanshan District,, Shenzhen, Guangdong 518057,, CN

(51) MKP
A61K 9/00 2006 (97) EP 3576721
A61K 31/00 2006
 (96) EP 18747137.0 2/5/2018
 (97) EP 3576721, 12/11/2019 201950, en
 (31) 201721004194 (32) 06.02.2017 (33) IN
 (54) COMPOSITION COMPRISING IMMEDIATE RELEASE AND EXTENDED RELEASE CAPECITABINE
 (72) GANDHI, Kashyap, Intas Pharmaceuticals Ltd. - Astron Division Plot No.: 457 458 Vill.: Matoda Sarkhej Bavla Highway Road Tal.: Sanand Dist., Ahmedabad Gujarat 382210, IN
 PATEL, Piyush, Intas Pharmaceuticals Ltd. - Astron Division Plot No.: 457 458 Vill.: Matoda Sarkhej Bavla Highway Road Tal.: Sanand Dist., Ahmedabad Gujarat 382210, IN
 PATEL, Manish, Intas Pharmaceuticals Ltd. - Astron Division Plot No.: 457 458 Vill.: Matoda Sarkhej Bavla Highway Road Tal.: Sanand Dist., Ahmedabad Gujarat 382210, IN
 CHAUHAN, Manish, Intas Pharmaceuticals Ltd. - Astron Division Plot No.: 457 458 Vill.: Matoda Sarkhej Bavla Highway Road Tal.: Sanand Dist., Ahmedabad Gujarat 382210, IN
 SEHGAL, Ashish, Intas Pharmaceuticals Ltd. - Astron Division Plot No.: 457 458 Vill.: Matoda Sarkhej Bavla Highway Road Tal.: Sanand Dist., Ahmedabad Gujarat 382210, IN

(51) MKP
C07D 487/22 2006 (97) EP 3565818
G01N 21/64 2006
 (96) EP 18747932.4 2/2/2018
 (97) EP 3565818, 11/13/2019 201946, en
 (31) 201762454493 P (32) 03.02.2017 (33) US
 (54) HYDROPORPHYRINS FOR PHOTOACOUSTIC IMAGING
 (71) NIRvana Sciences Inc., PO Box 12744, Durham NC 27709, US
 (72) PITNER, James Bruce, Nirvana Sciences Inc. 2 Davis Dr., Research Triangle Park NC 27709, US
 RAJAMAHENDIRAN, Rajalekha Manjakuppam, Nirvana Sciences Inc. 2 Davis Dr., Research Triangle Park NC 27709, US
 THOMAS, Russell D, Nirvana Sciences Inc. 2 Davis Dr., Research Triangle Park NC 27709, US

(51) MKP
A61K 31/517 2006 (97) EP 3578560
A61P 35/00 2006
C07D 471/10 2006
 (96) EP 18747957.1 2/1/2018
 (97) EP 3578560, 12/11/2019 201950, en
 (31) 2017017266 (32) 02.02.2017 (33) JP
 2017143607 25.07.2017 JP
 (54) QUINAZOLINE COMPOUND
 (72) KURAMOTO, Kazuyuki, c/o Astellas Pharma Inc. 5-1 Nihonbashi-Honcho 2-chome Chuo-ku, Tokyo 103-8411, JP
 AKAIWA, Michinori, c/o Astellas Pharma Inc. 5-1 Nihonbashi-Honcho 2-chome Chuo-ku, Tokyo 103-8411, JP
 ABE, Tomoaki, c/o Astellas Pharma Inc. 5-1 Nihonbashi-Honcho 2-chome Chuo-ku, Tokyo 103-8411, JP
 ARAKI, Takanobu, c/o Astellas Pharma Inc. 5-1 Nihonbashi-Honcho 2-chome Chuo-ku, Tokyo 103-8411, JP
 YAMAKI, Susumu, c/o Astellas Pharma Inc. 5-1 Nihonbashi-Honcho 2-chome Chuo-ku, Tokyo 103-8411, JP
 KUNIKAWA, Shigeki, c/o Astellas Pharma Inc. 5-1 Nihonbashi-Honcho 2-chome Chuo-ku, Tokyo 103-8411, JP
 IMAIZUMI, Tomoyoshi, c/o Astellas Pharma Inc. 5-1 Nihonbashi-Honcho 2-chome Chuo-ku, Tokyo 103-8411, JP
 NIGAWARA, Takahiro, c/o Astellas Pharma Inc. 5-1 Nihonbashi-Honcho 2-chome Chuo-ku, Tokyo 103-8411, JP
 ARAKAWA, Keisuke, c/o Astellas Pharma Inc. 5-1 Nihonbashi-Honcho 2-chome Chuo-ku, Tokyo 103-8411, JP
 SHIMADA, Itsuro, c/o Astellas Pharma Inc. 5-1 Nihonbashi-Honcho 2-chome Chuo-ku, Tokyo 103-8411, JP
 SHIMAZAKI, Masashi, c/o Astellas Pharma Inc. 5-1 Nihonbashi-Honcho 2-chome Chuo-ku, Tokyo 103-8411, JP
 SATAKE, Yoshiki, c/o Astellas Pharma Inc. 5-1 Nihonbashi-Honcho 2-chome Chuo-ku, Tokyo 103-8411, JP
 WATANABE, Kazushi, c/o Astellas Pharma Inc. 5-1 Nihonbashi-Honcho 2-chome Chuo-ku, Tokyo 103-8411, JP
 KOIKE, Takanori, c/o Astellas Pharma Inc. 5-1 Nihonbashi-Honcho 2-chome Chuo-ku, Tokyo 103-8411, JP

(51) MKP
C07F 5/04 2006 (97) EP 3577122

(96) EP 18747999.3 1/31/2018
 (97) EP 3577122, 12/11/2019 201950, en

(31) 201762453408 P (32) 01.02.2017 (33) US

(54) APPARATUS AND CONTINUOUS FLOW PROCESS FOR PRODUCTION OF BORONIC ACID DERIVATIVE
 (72) PELZ, Andreas, 300 TriState International, Suite 272, Lincolnshire, Illinois 60069, US
 SCHUSTER, Christian, 300 TriState International, Suite 272, Lincolnshire, Illinois 60069, US
 STEINHOFER, Stefan, 300 TriState International, Suite 272, Lincolnshire, Illinois 60069, US
 VASILOIU, Maria, 300 TriState International, Suite 272, Lincolnshire, Illinois 60069, US
 ZINGANELL, Christopher, 300 TriState International, Suite 272, Lincolnshire, Illinois 60069, US
 STUECKLER, Clemens, 300 TriState International, Suite 272, Lincolnshire, Illinois 60069, US

(51) MKP
F41G 1/387 2006 (97) EP 3577509
F41G 3/06 2006
F41G 11/00 2006
G02B 7/00 2006
G02B 27/01 2006

(96) EP 18748290.6 2/6/2018
 (97) EP 3577509, 12/11/2019 201950, en

(31) 201762466150 P (32) 02.03.2017 (33) US
 201762455274 P 06.02.2017 US
 201762485129 P 13.04.2017 US
 201862616799 P 12.01.2018 US

(54) VIEWING OPTIC WITH AN INTEGRATED DISPLAY SYSTEM
 (71) Sheltered Wings, Inc. D/b/a/ Vortex Optics, 2120 W. Greenview Drive, Middleton, WI 53562, US
 (72) HAVENS, Calen, 2120 W. Greenview Drive, Middleton WI 53562, US
 LOWRY, Will, 2120 W. Greenview Drive, Middleton WI 53562, US
 KLEMM, Ian, 2120 W. Greenview Drive, Middleton WI 53562, US
 HAMILTON, Samuel, 2120 W. Greenview Drive, Middleton WI 53562, US
 BOLLIG, Garrison, 2120 W. Greenview Drive, Middleton WI 53562, US
 SCHULTZ, Craig, 2120 W. Greenview Drive, Middleton WI 53562, US
 CARLSON, Andrew, 2120 W. Greenview Drive, Middleton WI 53562, US
 LYLE, Jason, 2120 W. Greenview Drive, Middleton WI 53562, US
 HAMILTON, David M., 2120 W. Greenview Drive, Middleton Wisconsin 53562, US

(51) MKP
A61K 38/00 2006 (97) EP 3576768
A61K 38/43 2006
A61K 48/00 2006
A61P 25/00 2006
A61P 25/28 2006
C12N 15/09 2006

(96) EP 18748381.3 1/30/2018
 (97) EP 3576768, 12/11/2019 201950, en

(31) 201762452769 P (32) 31.01.2017 (33) US
 201762485655 P 14.04.2017 US
 201762529366 P 06.07.2017 US
 201762579690 P 31.10.2017 US
 201862616234 P 11.01.2018 US

(54) TREATMENT OF MUCOPOLYSACCHARIDOSIS I WITH FULLY-HUMAN GLYCOSYLATED HUMAN ALPHA-L-IDURONIDASE (IDUA)
 (72) YOO, Stephen, 5521 Southwick Street, Bethesda, MD 20817, US
 REINHARDT, Rickey Robert, 108 Apple Grove Road, Silver Spring, MD 20904, US
 SIMPSON, Curran Matthew, 2149 Thurston Road, Frederick, MD 21704, US
 WU, Zhuchun, 14716 Soft Wind Drive, North Potomac, MD 20878, US

(51) MKP
C07K 7/60 2006 (97) EP 3577129

(96) EP 18748583.4 1/31/2018
 (97) EP 3577129, 12/11/2019 201950, en

(31) 201762452643 P (32) 31.01.2017 (33) US

(54) METHODS FOR TREATING FUNGAL INFECTIONS

(72) BARTIZAL, Kenneth, 7520 Draper Avenue Unit 5, La Jolla, CA 92037, US
 DARUWALA, Paul, 1141 Luneta Drive, Del Mar, CA 92014, US

(51) MKP
A61K 48/00 2006 (97) EP 3577221
C07H 19/02 2006
C07H 21/00 2006
C12N 15/11 2006

(96) EP 18748592.5 2/1/2018

(97) EP 3577221, 12/11/2019 201950, en

(31) 201762453482 P (32) 01.02.2017 (33) US

(54) POLYNUCLEOTIDE SECONDARY STRUCTURE

(72) MCFADYEN, Iain, 502 West River Road 49, Hooksett NH 03106, US

PRESNYAK, Vladimir, 502 West River Road 49, Hooksett NH 03106, US

MAUGER, David, 22 Elmore Street, Arlington MA 02476, US

(51) MKP
A61P 31/04 2006 (97) EP 3577213
C12N 1/00 2006
C12N 1/04 2006
C12N 1/14 2006
C12N 1/21 2006

(96) EP 18748726.9 1/31/2018

(97) EP 3577213, 12/11/2019 201950, en

(31) 201762452804 P (32) 31.01.2017 (33) US
 201762452816 P 31.01.2017 US
 201762510723 P 24.05.2017 US

(54) MICROBIAL CELLS, METHODS OF PRODUCING THE SAME, AND USES THEREOF

(71) Kansas State University Research Foundation, 2005 Research Park Circle, Suite 105, Manhattan, KS 66502, US

MS Biotech, Inc., 2489 W. Main Street, Littleton, Colorado 80120, US

(72) DROUILLARD, James Scott, 133 Call Hall, Manhattan Kansas 66506, US

APERCE, Celine Caroline, 1300 Kaw Valley Road, Wamego Kansas 66547, US

HERREN, Gina Rae, 1300 Kaw Valley Road, Wamego Kansas 66547, US

ELLERMAN, Tara Jo, 119 Call Hall, Manhattan Kansas 66506, US

SCALETTI, Ciana Marie, 116 Weber Hall, Manhattan Kansas 66506, US

VAN JORDAN, Katherine, 214 Weber Hall, Manhattan Kansas 66506, US

LATTIMER, James Morris, 132 Weber Hall, Manhattan Kansas 66506, US

BEYER, Scott, 130 Call Hall, Manhattan Kansas 66506, US

UWITUZE, Solange, Regional Universities Forum for Capacity Building in Agriculture (RUFORUM) Plot 151/155 Garden Hill Makerere University

Main Campus P.O. Box 16811, Wandegeya Kampala, UG

DOUTHIT, Teresa Lea, 129 Weber Hall, Manhattan Kansas 66506, US

GUNKEL, Christina Denise, 43779 Callaway Rd, Broken Bow Nebraska 68822, US

(51) MKP
A61K 39/395 2006 (97) EP 3579876
C07K 16/28 2006

(96) EP 18750616.7 2/9/2018

(97) EP 3579876, 12/18/2019 201951, en

(31) 201762457780 P (32) 10.02.2017 (33) US

(54) PROTEINS BINDING BCMA, NKG2D AND CD16

(71) Dragonfly Therapeutics, Inc., 35 Gatehouse Drive, Waltham MA 02451, US

CHANG, Gregory, P., 143 Saunders Street, Medford MA 02155, US

CHEUNG, Ann, F., 25 Morningside Lane, Lincoln MA 01773, US

HANEY, William, 61 Lincoln Road, Wayland MA 01778, US

LUNDE, Bradley, M., 7 Lucent Drive, Lebanon NH 03766, US

PRINZ, Bianka, 7 Lucent Drive, Lebanon NH 03766, US

(51) MKP
G06K 9/62 2006 (97) EP 3582144

(96) EP 18750641.5 2/2/2018

(97) EP 3582144, 12/18/2019 201951, en

(31) 201710069595 (32) 08.02.2017 (33) CN

(54) SAMPLE SELECTION METHOD, APPARATUS AND SERVER
 (71) Nanjing University of Aeronautics and Astronautics, No.29 Yudao Street Qinhuai District, Nanjing, Jiangsu 210016, CN
 (72) HUANG, Shengjun, No.29 Yudao Street, Qinhuai District, Nanjing,, Jiangsu 210016, CN
 GAO, Nengneng, No.29 Yudao Street, Qinhuai District, Nanjing,, Jiangsu 210016, CN
 YUAN, Kun, 35/F, Tencent Building, Kejizhongyi Road, Midwest District of Hi-tech Park, Nanshan District,, Shenzhen, Guangdong 518057, CN
 CHEN, Wei, 35/F, Tencent Building, Kejizhongyi Road, Midwest District of Hi-tech Park, Nanshan District,, Shenzhen, Guangdong 518057, CN
 WANG, Di, 35/F, Tencent Building, Kejizhongyi Road, Midwest District of Hi-tech Park, Nanshan District,, Shenzhen, Guangdong 518057, CN

(51) MKP
A61K 31/395 2006 (97) EP 3579835
A61K 31/4748 2006
A61K 36/71 2006
A61P 25/20 2006
C07D 451/14 2006
C07D 491/153 2006
 (96) EP 18750705.8 2/13/2018
 (97) EP 3579835, 12/18/2019 201951, en
 (31) 201762458230 P (32) 13.02.2017 (33) US
 (54) HERBAL COMPOSITIONS OF CALIFORNIA POPPY AND METHOD FOR THE TREATMENT OF SLEEP AND DREAM-RELATED DISORDERS
 (71) Mondias Naturels Inc., 26-4500 boul. Kimber, Longueuil, Québec J3Y 8K5, CA
 (72) CHAMBERLAND, Guy, 1230 rue du Boise, Boucherville Québec J4B 8R1, CA

(51) MKP
C07K 16/28 2006 (97) EP 3580239
 (96) EP 18750717.3 2/9/2018
 (97) EP 3580239, 12/18/2019 201951, en
 (31) 201762457021 P (32) 09.02.2017 (33) US
 (54) ANTI-ILT3 ANTIBODIES AND ANTIBODY DRUG CONJUGATES
 (72) DARCE, Jaime, 32 Freeman Street, Arlington MA 02474, US
 LONNING, Scott Michael, 1 Grassy Lane, Westford MA 01886, US
 PEDERSON, Nels Eric, 71 Pattys Road, Mansfield MA 02048, US
 RIKOVA, Klarisa, 1 Charles Street Unit M, Reading MA 01867, US
 TKACHEV, Aleksandr, 1105 Massachusetts Avenue, Apt. 9H, Cambridge MA 02138, US

(51) MKP
A47J 43/046 2006 (97) EP 3579731
A47J 43/07 2006
 (96) EP 18751031.8 2/8/2018
 (97) EP 3579731, 12/18/2019 201951, en
 (31) 201762456920 P (32) 09.02.2017 (33) US
 201715457874 13.03.2017 US
 201715633383 26.06.2017 US
 201715703933 13.09.2017 US
 (54) VACUUM BLENDER
 (71) Trojan, R., Joseph, 9250 Wilshire Blvd., Ste. 325, Beverly Hills, CA 90212, US
 (72) Trojan, R., Joseph, 9250 Wilshire Blvd., Ste. 325, Beverly Hills, CA 90212, US

(51) MKP
A61K 39/395 2006 (97) EP 3582813
A61P 17/00 2006
C07K 16/24 2006
 (96) EP 18753575.2 2/16/2018
 (97) EP 3582813, 12/25/2019 201952, en
 (31) 201762459841 P (32) 16.02.2017 (33) US
 (54) TREATMENT OF HIDRADENITIS SUPPURATIVA
 (72) KIM, Stanley, A., 5425 Park Central Court Suite 111, Naples, FL 34109, US
 GIAMARELLOS-BOURBOULIS, Evangelos, J., 21 Androutsou Street, 15351 Athens, GR

(51) MKP
C07K 16/28 2006 (97) EP 3583131
C07K 16/32 2006

(96) EP 18753685.9 2/20/2018
 (97) EP 3583131, 12/25/2019 201952, en
 (31) 201762461145 P (32) 20.02.2017 (33) US
 (54) PROTEINS BINDING CD33, NKG2D AND CD16
 (71) Dragonfly Therapeutics, Inc., 35 Gatehouse Drive, Waltham, MA 02451, US
 (72) CHANG, Gregory, P., 143 Saunders Street, Medford, MA 02155, US
 CHEUNG, Ann, F., 25 Morningside Lane, Lincoln, MA 01773, US
 HANEY, William, 61 Lincoln Road, Wayland, MA 01778, US
 LUNDE, Bradley, M., 7 Lucent Drive, Lebanon, NH 03766, US
 PRINZ, Bianca, 7 Lucent Drive, Lebanon, NH 03766, US

(51) MKP
A61K 39/00 2006 (97) EP 3582805
A61K 39/395 2006
C07K 16/28 2006
C07K 16/30 2006
G01N 33/574 2006
 (96) EP 18753778.2 2/16/2018
 (97) EP 3582805, 12/25/2019 201952, en
 (31) 201762459700 P (32) 16.02.2017 (33) US
 (54) ANTI-PD-L1 ANTIBODY TREATMENT OF BLADDER CANCER
 (72) KURLAND, John, c/o MedImmune LLC One Medimmune Way, Gaithersburg, MD 20878, US
 BLAKE-HASKINS, John, Andrew, c/o MedImmune LLC One Medimmune Way, Gaithersburg, MD 20878, US
 ZAJAC, Magdalena, c/o MedImmune Limited Milstein Building, Granta Park Cambridge CB21 6GH, GB
 REBELATTO, Marlon, c/o MedImmune LLC One Medimmune Way, Gaithersburg, MD 20878, US
 GUPTA, Ashok, c/o MedImmune LLC One Medimmune Way, Gaithersburg, MD 20878, US
 HO, Tony, c/o MedImmune LLC One Medimmune Way, Gaithersburg, MD 20878, US
 WALKER, Jill, c/o MedImmune LLC Milstein Building, Granta Park Cambridge CB21 6GH, GB
 JIN, Xiaoping, c/o MedImmune LLC One Medimmune Way, Gaithersburg, MD 20878, US
 MORRIS, Shannon, c/o MedImmune LLC One Medimmune Way, Gaithersburg, MD 20878, US
 IANNONE, Robert, c/o MedImmune LLC One Medimmune Way, Gaithersburg, MD 20878, US
 SHI, Li, c/o MedImmune LLC One Medimmune Way, Gaithersburg, MD 20878, US
 DAR, Mohammed, c/o MedImmune LLC One Medimmune Way, Gaithersburg, MD 20878, US
 BEN, Yong, c/o MedImmune LLC One Medimmune Way, Gaithersburg, MD 20878, US

(51) MKP
A61K 31/415 2006 (97) EP 3582773
A61P 13/12 2006
A61P 17/06 2006
 (96) EP 18753963.0 2/16/2018
 (97) EP 3582773, 12/25/2019 201952, en
 (31) 201762460576 P (32) 17.02.2017 (33) US
 (54) PROCESSES FOR PREPARING AG-10, ITS INTERMEDIATES, AND SALTS THEREOF
 (71) Eidos Therapeutics, Inc., 101 Montgomery Street 25th Floor, San Francisco, CA 94104, US
 (72) CHAND, Pooran, 101 Montgomery Street 25th Floor, San Francisco, CA 94104, US
 GUPTA, Yogesh, Kumar, 101 Montgomery Street 25th Floor, San Francisco, CA 94104, US
 KUMAWAT, Rakesh, Kumar, 101 Montgomery Street 25th Floor, San Francisco, CA 94104, US
 ALHAMADSHEH, Mamoun, 101 Montgomery Street 25th Floor, San Francisco, CA 94104, US
 ZAMBONI, Robert, 101 Montgomery Street 25th Floor, San Francisco, CA 94104, US

(51) MKP
H04N 7/18 2006 (97) EP 3585052
 (96) EP 18754005.9 2/6/2018
 (97) EP 3585052, 12/25/2019 201952, en
 (31) 201710081274 (32) 15.02.2017 (33) CN
 (54) IMAGE IDENTIFICATION METHOD, DEVICE, APPARATUS, AND DATA STORAGE MEDIUM
 (72) WANG, Dafeng, 35/F Tencent Building Kejizhongyi Road Midwest District of Hi-Tech Park Nanshan District ^, Shenzhen Guangdong 518057, CN

(51) MKP
G07C 5/08 2006 (97) EP 3584768
 (96) EP 18754577.7 2/6/2018
 (97) EP 3584768, 12/25/2019 201952, en

(31) 201710084422 (32) 16.02.2017 (33) CN
 (54) METHOD OF DETECTING PHOTOGRAPHIC DIRECTION SHIFT, DEVICE, APPARATUS, AND DATA STORAGE MEDIUM
 (72) WANG, Dafeng, 35/F, Tencent Building, Kejizhongyi Road, Midwest District of Hi-Tech Park, Nanshan District,, Shenzhen, Guangdong 518057,, CN
 CHEN, Jianye, 35/F, Tencent Building, Kejizhongyi Road, Midwest District of Hi-Tech Park, Nanshan District,, Shenzhen, Guangdong 518057,, CN

(51) MKP
A61K 31/7105 2006 (97) EP 3582790
A61K 39/12 2006
A61P 31/14 2006

(96) EP 18754856.5 2/16/2018
 (97) EP 3582790, 12/25/2019 201952, en

(31) 201762459763 P (32) 16.02.2017 (33) US
 (54) HIGH POTENCY IMMUNOGENIC COMPOSITIONS
 (72) CIARAMELLA, Giuseppe, 1 Hawes Road, Sudbury, MA 01776, US

(51) MKP
A61K 31/47 2006 (97) EP 3583943
A61K 47/04 2006
A61K 47/38 2006
A61K 47/40 2006
A61P 35/00 2006

(96) EP 18755023.1 2/14/2018
 (97) EP 3583943, 12/25/2019 201952, en

(31) 2017026203 (32) 15.02.2017 (33) JP
 (54) PHARMACEUTICAL COMPOSITION
 (72) OKADA Shinji, c/o Taiho Pharmaceutical Co. Ltd. 224-2 Hiraishiebisuno Kawauchi-cho, Tokushima-shi Tokushima 771-0194, JP

(51) MKP
C07K 16/28 2006 (97) EP 3589658

(96) EP 18756115.4 8/2/2018
 (97) EP 3589658, 1/8/2020 202002, en

(31) 201762541024 P (32) 03.08.2017 (33) US
 201862667388 P 04.05.2018 US

(54) ANTI-CD33 ANTIBODIES AND METHODS OF USE THEREOF
 (71) Alector LLC, 131 Oyster Point Boulevard, Suite 600, South San Francisco CA 94080, US
 (72) CULP, Patricia, c/o Alector LLC 131 Oyster Point Boulevard Suite 600, South San Francisco, CA 94080, US
 LAM, Helen, c/o Alector LLC 131 Oyster Point Boulevard Suite 600, South San Francisco, CA 94080, US
 ROSENTHAL, Arnon, 150 Normandy Lane, Woodside, CA 94062, US
 LEE, Seung-Joo, c/o Alector LLC 131 Oyster Point Boulevard Suite 600, South San Francisco, CA 94080, US
 NIELSON, Nels P., c/o Adimab LLC 7 Lucent Drive, Lebanon, NH 03766, US
 PEJCHAL, Robert, c/o Adimab LLC 7 Lucent Drive, Lebanon, NH 03766, US

(51) MKP
A61K 39/395 2006 (97) EP 3585429
C07K 16/18 2006

(96) EP 18756690.6 2/9/2018
 (97) EP 3585429, 1/1/2020 202001, en

(31) 201762463543 P (32) 24.02.2017 (33) US
 PCT/US2017/023788 23.03.2017 WO

(54) ANTI-IL31 ANTIBODIES FOR VETERINARY USE
 (71) Kindred Biosciences, Inc., 1555 Bayshore Highway, No. 200, Burlingame, CA 94010, US
 (72) LI, Shyr Jiann, 1555 Bayshore Highway Suite 200, Burlingame, California 94010, US
 NGUYEN, Lam, 1555 Bayshore Highway Suite 200, Burlingame, California 94010, US
 ZHAN, Hangjun, 1555 Bayshore Highway Suite 200, Burlingame, California 94010, US

(51) MKP
A61K 31/573 2006 (97) EP 3585405
A61K 35/74 2015

(96) EP 18757329.0 2/23/2018

(97) EP 3585405, 1/1/2020 202001, en
 (31) 201762462658 P (32) 23.02.2017 (33) US
 (54) PHARMACEUTICAL COMPOSITIONS OF A BILE ACID DERIVATIVE AND MICROBIOME AND USES THEREOF
 (72) WU, Gary D., 28 Whitmarsh Road, Ardmore Pennsylvania 1903, US
 LEE, Hongzhe, 110 Fairview Road, Penn Valley Pennsylvania 19072, US
 BABAKHANI, Farah, 12334 Darkwood Rd, San Diego California 92129, US
 ADORINI, Luciano, via Bronzino 8, 20133 Milano, IT

(51) MKP
A61K 39/00 2006 (97) EP 3585426
A61K 39/395 2006
C07K 16/30 2006
 (96) EP 18757760.6 2/22/2018
 (97) EP 3585426, 1/1/2020 202001, en
 (31) 201762462108 P (32) 22.02.2017 (33) US
 201762541409 P 04.08.2017 US
 (54) COMPOSITIONS AND METHODS FOR TUMOR TRANSDUCTION
 (71) Aleta Biotherapeutics Inc., 27 Strathmore Road, Natick, Massachusetts 01760, US
 (72) LOBB, Roy, 580 Washington Street Apt. 304, Wellesley Massachusetts 02482, US
 RENNERT, Paul, 205 Underwood Street, Holliston Massachusetts 01746, US

(51) MKP
A61K 39/395 2006 (97) EP 3585431
A61P 35/00 2006
 (96) EP 18757875.2 2/22/2018
 (97) EP 3585431, 1/1/2020 202001, en
 (31) 201762463353 P (32) 24.02.2017 (33) US
 201762597594 P 12.12.2017 US
 (54) BISPECIFIC BINDING MOLECULES THAT ARE CAPABLE OF BINDING CD137 AND TUMOR ANTIGENS, AND USES THEREOF
 (72) LIU, Liqin, 13515 Stonebridge Terrace, Germantown, MD 20874, US
 LAM, Chia-ying, Kao, 6020 Hawkcreek Place, San Jose, CA 95123, US
 DIETRICH, Gundo, 13409 Bonnie Dale Drive, North Potomac, MD 20878, US
 JOHNSON, Leslie, S., 14411 Poplar Hill Road, Darnestown, MD 20874, US
 MOORE, Paul, A., 10 Turley Court, North Potomac, MD 20878, US
 BONVINI, Ezio, 11136 Powder Horn Drive, Potomac, MD 20854, US

(51) MKP
C07K 16/28 2006 (97) EP 3585817
C07K 16/30 2006
C07K 16/32 2006
C07K 16/42 2006
C07K 16/46 2006
C07K 19/00 2006
 (96) EP 18758228.3 2/22/2018
 (97) EP 3585817, 1/1/2020 202001, en
 (31) 201762462098 P (32) 22.02.2017 (33) US
 201762541439 P 04.08.2017 US
 (54) COMPOSITIONS AND METHODS FOR TREATMENT OF CANCER
 (72) LOBB, Roy, 580 Washington Street Apt. 304, Wellesley Massachusetts 02482, US
 RENNERT, Paul, 205 Underwood Street, Holliston Massachusetts 01746, US

(51) MKP
A61K 31/4745 2006 (97) EP 3589285
C07D 401/12 2006
C07D 471/04 2006
 (96) EP 18760393.1 2/27/2018
 (97) EP 3589285, 1/8/2020 202002, en
 (31) 201762465047 P (32) 28.02.2017 (33) US
 (54) INHIBITORS OF (ALPHA-V)(BETA-6) INTEGRIN
 (71) Morphic Therapeutic, Inc., 35 Gatehouse Drive A2, Waltham, MA 02451, US
 (72) HARRISON, Bryce, Alden, 7 Old Wood Road, Framingham, MA 01701, US
 BURSAVICH, Matthew, Gregory, 172 Damon Road, Needham, MA 02494, US
 GERASYUTO, Aleksey, Lgorevich, 20 Skyline Drive, Flemington, NJ 08822, US

HAHN, Kristopher, Neil, 32 Webster Street, Medford, MA 02155, US
 KONZE, Kyle, David, 224 E. 70 Street Apt. 6, New York, NY 10021, US
 LIN, Fu-Yang, 44 Saxony Drive, Sudbury, MA 01776, US
 LIPPA, Blaise, Scott, 340 Pope Road, Concord, MA 01742, US
 LUGOVSKOY, Alexey, Alexandrovich, 35 Audrey Road, Belmont, MA 02478, US
 ROGERS, Bruce, Nelsen, 252 Common Street, Belmont, MA 02478, US
 SVENSSON, Mats, Ake, 160 West 24th Street Apt. 19C, New York, NY 10011, US
 TROAST, Dawn, Marie, 325 Springs Road, Bedford, MA 01730, US

- (51) MKP
A61K 35/14 2015 (97) EP 3589646
A61K 38/17 2006
A61K 38/43 2006
C07K 14/505 2006
C07K 14/705 2006
C07K 14/725 2006
C07K 16/18 2006
C07K 16/28 2006
C07K 16/30 2006
C07K 16/46 2006

(96) EP 18760420.2 3/2/2018

(97) EP 3589646, 1/8/2020 202002, en

(31) 201762466601 P (32) 03.03.2017 (33) US
 201762484052 P 11.04.2017 US

(54) CD19 COMPOSITIONS AND METHODS FOR IMMUNOTHERAPY

(71) Obsidian Therapeutics, Inc., 1030 Massachusetts Avenue Fourth Floor, Cambridge, MA 02138, US

(72) SURI, Vipin, 3 Coolidge Road, Belmont, Massachusetts 02478, US

BRISKIN, Michael Joseph, 28 Harbell Street, Lexington, Massachusetts 02421, US

DOLINSKI, Brian, c/o Obsidian Therapeutics, Inc. 1030 Massachusetts Avenue Fourth Floor, Cambridge, Massachusetts 02138, US

ELPEK, Kutlu Goksu, 5 Florence Terrace, Arlington, Massachusetts 02476, US

LI, Dan Jun, c/o Obsidian Therapeutics, Inc. 1030 Massachusetts Avenue Fourth Floor, Cambridge, Massachusetts 02138, US

HELLER, Scott Francis, 559 Plain Street, Stoughton, Massachusetts 02072, US

OLS, Michelle Lynn, 65 Oak Avenue, Northborough, Massachusetts 01532, US

SUN, Dexue, c/o Obsidian Therapeutics, Inc. 1030 Massachusetts Avenue Fourth Floor, Cambridge, Massachusetts 02138, US

KOSMIDER, Nicole, 1030 Massachusetts Avenue Fourth Floor, Cambridge, Massachusetts 02138, US

KULKARNI, Abhishek, 360 Tappan Street 3, Brookline, Massachusetts 02445, US

BALAKRISHNAN, Vijaya, 142A Main Street, Groton, Massachusetts 01450, US

EZELL, Tucker, 1030 Massachusetts Avenue Fourth Floor, Cambridge, Massachusetts 02138, US

- (51) MKP
A61K 39/44 2006 (97) EP 3589952
A61K 51/10 2006
B03C 1/005 2006
C12N 15/13 2006
G01N 33/50 2006
G01N 33/574 2006

(96) EP 18760507.6 2/27/2018

(97) EP 3589952, 1/8/2020 202002, en

(31) 201762464585 P (32) 28.02.2017 (33) US

(54) IMPROVED KITS AND ASSAYS TO DETECT CIRCULATING MULTIPLE MYELOMA CELLS FROM BLOOD

(71) Menarini Silicon Biosystems S.p.A., Via Giuseppe di Vittorio, 21 B/3, 40013 Castel Maggiore (BO), IT

(72) FOULK, Brad, 112 Circle Drive, Chalfont, Pennsylvania 18914, US

RAO, Galla Chandra, 9 Haverford Road, Princeton Jct., New Jersey 08550, US

GROSS, Steven, 2002 Lincoln Drive East, Ambler, Pennsylvania 19002, US

MORANO, Carrie Capps, 744 Quail Circle, Hatfield, Pennsylvania 19440, US

- (51) MKP
A61K 31/519 2006 (97) EP 3590516
A61K 33/24 2019
A61K 45/00 2006
A61P 35/00 2006
A61P 43/00 2006
C07D 487/04 2006

(96) EP 18761224.7 2/27/2018

(97) EP 3590516, 1/8/2020 202002, en
 (31) 2017037019 (32) 28.02.2017 (33) JP
 (54) ANTITUMOR-EFFECT ENHANCER USING PYRAZOLO[3,4-D]PYRIMIDINE COMPOUND
 (72) IRIE, Hiroki, c/o Taiho Pharmaceutical Co., Ltd. 3 Okubo, Tsukuba-shi Ibaraki 300-2611, JP
 OGUCHI, Kei, c/o Taiho Pharmaceutical Co., Ltd. 3 Okubo, Tsukuba-shi Ibaraki 300-2611, JP
 FUJIOKA, Yayoi, c/o Taiho Pharmaceutical Co., Ltd. 3 Okubo, Tsukuba-shi Ibaraki 300-2611, JP

(51) MKP
C07D 401/12 2006 (97) EP 3589627
C07D 471/04 2006
 (96) EP 18761396.3 2/27/2018
 (97) EP 3589627, 1/8/2020 202002, en
 (31) 201762464693 P (32) 28.02.2017 (33) US
 (54) INHIBITORS OF (ALPHA-V)(BETA-6) INTEGRIN
 (72) BREWER, Mark, Tramora Bottom Lane Checkendon, Reading Oxon R98 0NR, GB
 BURSAVICH, Matthew, Gregory, 172 Damon Road, Needham, MA 02494, US
 GERASYUTO, Aleksey, Lgorevich, 20 Skyline Drive, Flemington, NJ 08822, US
 HAHN, Kristopher, Neil, 32 Webster Street, Medford, MA 02155, US
 HARRISON, Bryce, Alden, 7 Old Wood Road, Framingham, MA 01701, US
 KONZE, Kyle, David, 224 E. 70 Street Apt. 6, New York, NY 10021, US
 LIN, Fu-yang, 44 Saxony Drive, Sudbury, MA 01776, US
 LIPPA, Blaise, Scott, 340 Pope Road, Concord, MA 01742, US
 LUGOVSKOY, Alexey, Alexandrovich, 35 Audrey Road, Belmont, MA 02478, US
 ROGERS, Bruce, Nelsen, 252 Common Street, Belmont, MA 02478, US
 SVENSSON, Mats, Ake, 160 West 24th Street Apt. 19C, New York, NY 10011, US
 TROAST, Dawn, Marie, 325 Springs Road, Bedford, MA 01730, US

(51) MKP
A61K 38/16 2006 (97) EP 3589648
A61K 39/395 2006
A61K 39/42 2006
A61P 31/12 2006
A61P 31/14 2006
C07K 16/08 2006
C07K 16/10 2006
 (96) EP 18761614.9 2/28/2018
 (97) EP 3589648, 1/8/2020 202002, en
 (31) 201762465379 P (32) 01.03.2017 (33) US
 (54) ANTI-RSV MONOCLONAL ANTIBODY FORMULATION
 (71) Medimmune Limited, Milstein Building Granta Park, Cambridge CB21 6GH, GB
 (72) LOBO, Brian, 6219 Sutton Court, Elkridge, MD 21075, US
 GOLDBERG, Deborah, 6219 Sutton Court, Elkridge, MD 21075, US

(51) MKP
A61K 31/546 2006 (97) EP 3592362
A61K 31/69 2006
A61P 31/04 2006
 (96) EP 18763383.9 3/5/2018
 (97) EP 3592362, 1/15/2020 202003, en
 (31) 201762467750 P (32) 06.03.2017 (33) US
 201762467752 P 06.03.2017 US
 201762564989 P 28.09.2017 US
 201762564990 P 28.09.2017 US
 (54) SOLID FORMS AND COMBINATION COMPOSITIONS COMPRISING A BETA-LACTAMASE INHIBITOR AND USES THEREOF
 (72) BURNS, Christopher J., 30 Spring Mill Drive, Malvern, Pennsylvania 19355, US
 PEVEAR, Daniel C., 30 Spring Mill Drive, Malvern, Pennsylvania 19355, US
 XERRI, Luigi, 30 Spring Mill Drive, Malvern, Pennsylvania 19355, US
 HENKEL, Timothy, 30 Spring Mill Drive, Malvern, Pennsylvania 19355, US
 MCGARRY, Daniel, 30 Spring Mill Drive, Malvern, Pennsylvania 19355, US
 ROSEN, Lawrence, 30 Spring Mill Drive, Malvern, Pennsylvania 19355, US
 BRENNER, Gerald, 3007 Oakwood Drive, Plymouth Meeting, Pennsylvania 19462, US
 ARLIN, Jean-Baptiste, Meibergdreef 31, 1105 AZ Amsterdam, NL
 FERNANDEZ CASARES, Ana, Meibergdreef 31, 1105 AZ Amsterdam, NL

-
- (51) MKP
E21B 34/14 2006 (97) EP 3592945
E21B 43/12 2006
E21B 43/267 2006
- (96) EP 18763690.7 3/8/2018
(97) EP 3592945, 1/15/2020 202003, en
(31) 201762469019 P (32) 09.03.2017 (33) US
- (54) A PROCESS FOR PRODUCING HYDROCARBON MATERIAL FROM A SUBTERRANEAN FORMATION WHILE EMPLOYING SOLIDS CONTROL
(72) WAGES, David, c/o BP Exploration (Alaska) Inc. 900 E. Benson Blvd., Anchorage, Alaska 99519-6612, US
WERRIES, Michael, c/o NCS Multistage Inc. 11929-40 Street SouthEast Unit 222, Calgary, Alberta T2Z 4M8, CA
WHYTE, Rio, c/o NCS Multistage Inc. 11929-40 Street SouthEast Unit 222, Calgary, Alberta T2Z 4M8, CA
-
- (51) MKP
H04N 19/146 2014 (97) EP 3595307
H04N 19/147 2014
H04N 19/159 2014
H04N 19/176 2014
- (96) EP 18763693.1 3/1/2018
(97) EP 3595307, 1/15/2020 202003, en
(31) 201710132204 (32) 07.03.2017 (33) CN
- (54) METHOD FOR VIDEO CODING CODE RATE ALLOCATION AND CODING UNIT CODE RATE ALLOCATION, AND COMPUTER EQUIPMENT
(72) MAO, Xunan, 35/F TencentBuilding Kejizhongyi Road Midwest District of Hi-tech Park Nanshan District, Shenzhen Guangdong 518057, CN
-
- (51) MKP
A61K 31/575 2006 (97) EP 3592359
C07J 9/00 2006
- (96) EP 18763875.4 3/7/2018
(97) EP 3592359, 1/15/2020 202003, en
(31) 201762468592 P (32) 08.03.2017 (33) US
- (54) CRYSTALLINE FORMS OF OBETICHOLIC ACID
(72) GALVIN, Gabriel M, 4760 Eastgate Mall, San Diego, California 92121, US
REWOLINSKI, Melissa, 4760 Eastgate Mall, San Diego, California 92121, US
-
- (51) MKP
E21B 34/06 2006 (97) EP 3592946
E21B 43/12 2006
- (96) EP 18764165.9 3/6/2018
(97) EP 3592946, 1/15/2020 202003, en
(31) 201762467855 P (32) 07.03.2017 (33) US
- (54) APPARATUSES, SYSTEMS AND METHODS FOR PRODUCING HYDROCARBON MATERIAL FROM A SUBTERRANEAN FORMATION
(72) RAVENSBERGEN, John, c/o NCS Multistage Inc. 5380 72nd Avenue S.E., Calgary, Alberta T2C 4X5, CA
LAUN, Lyle, c/o NCS Multistage Inc. 5380 72nd Avenue S.E., Calgary, Alberta T2C 4X5, CA
GILLIS, Brock, c/o NCS Multistage Inc. 5380 72nd Avenue S.E., Calgary, Alberta T2C 4X5, CA
WERRIES, Michael, c/o NCS Multistage Inc. 5380 72nd Avenue S.E., Calgary, Alberta T2C 4X5, CA
MONTERO, Juan, c/o NCS Multistage Inc. 5380 72nd Avenue S.E., Calgary, Alberta T2C 4X5, CA
JOHNSON, Tim, c/o NCS Multistage Inc. 5380 72nd Avenue S.E., Calgary, Alberta T2C 4X5, CA
-
- (51) MKP
A61M 1/36 2006 (97) EP 3579897
B01D 15/36 2006
- (96) EP 18764628.6 3/12/2018
(97) EP 3579897, 12/18/2019 201951, en
(31) 201762469643 P (32) 10.03.2017 (33) US
- (54) SHORT-ACTING HEPARIN-BASED ANTICOAGULANT COMPOUNDS AND METHODS
(71) The University of North Carolina at Chapel Hill, Office of Commercialization and Economic Development 109 Church St., Chapel Hill, NC 27516, US
(72) LIU, Jian, 217 Huntington Drive, Chapel Hill, NC 27514, US
WANG, Zhangjie, Room 404, Unit 2 23 Building Yu Cui Wan Hutchison Heji Yiju Road High-tech Zone, Changchun Jilin Province 130000, CN
HSIEH, Po-Hung, 307 S. Wilson Avenue Apt. 9, Pasadena, CA 91106, US
XU, Yongmei, 5501 Weston Downs Drive, Durham, NC 27707, US

(51) MKP
B28B 13/02 2006 (97) EP 3592522

(96) EP 18764935.5 3/7/2018
 (97) EP 3592522, 1/15/2020 202003, en
 (31) 1700104 (32) 10.03.2017 (33) HU

(54) APPARATUS AND METHOD FOR PRODUCING A PAVER BLOCK HAVING VEINED TREAD SURFACE
 (71) Barabás, Árpád, Hácncs utca 1., 8200 Veszprém, HU
 (72) Barabás, Árpád, Hácncs utca 1., 8200 Veszprém, HU

(51) MKP
A61K 38/00 2006 (97) EP 3592373
A61K 48/00 2006
C07K 14/78 2006
C12N 15/12 2006
C12N 15/85 2006
G01N 33/53 2006
G01N 33/68 2006

(96) EP 18764968.6 3/8/2018
 (97) EP 3592373, 1/15/2020 202003, en
 (31) 201762469053 P (32) 09.03.2017 (33) US
 201762588789 P 20.11.2017 US

(54) TYPE X COLLAGEN ASSAYS AND METHODS OF USE THEREOF
 (71) Shriners Hospitals for Children, 2900 Rocky Point Drive, Tampa FL 33607, US
 (72) HORTON, William, A., 5503 SW Downsview Ct., Portland, OR 97221, US
 LUNSTRUM, Gregory P., 1440 SE Holgate Blvd., Portland, OR 97202, US
 COGHLAN, Ryan F., 8514 SW 8th Ave., Portland, OR 97219, US
 OBERDORF, Jon A., 33808 Slavens Rd., Warren, OR 97053, US

(51) MKP
G06F 17/10 2006 (97) EP 3559821
G10L 19/02 2013
G10L 19/22 2013
G10L 19/24 2013
G10L 19/26 2013

(96) EP 18770254.3 3/19/2018
 (97) EP 3559821, 10/30/2019 201944, en
 (31) 201762475619 P (32) 23.03.2017 (33) US

(54) BACKWARD-COMPATIBLE INTEGRATION OF HARMONIC TRANSPOSER FOR HIGH FREQUENCY RECONSTRUCTION OF AUDIO SIGNALS
 (72) VILLEMoes, Lars, c/o Dolby Laboratories Inc. 1275 Market Street, San Francisco, California 94103, US
 PURNHAGEN, Heiko, c/o Dolby Laboratories Inc. 1275 Market Street, San Francisco, California 94103, US
 EKSTRAND, Per, c/o Dolby Laboratories Inc. 1275 Market Street, San Francisco, California 94103, US

(51) MKP
E21D 11/10 2006 (97) EP 3580429

(96) EP 18773927.1 8/24/2018
 (97) EP 3580429, 12/18/2019 201951, de
 (31) 102017120635 (32) 07.09.2017 (33) DE
 202017105802 U 25.09.2017 DE
 102017125624 02.11.2017 DE
 202018102249 U 23.04.2018 DE

(54) REINFORCEMENT SYSTEM FOR THE CONCRETE LINING OF THE INNER SHELL OF A TUNNEL CONSTRUCTION
 (71) BAG Bauartikel GmbH, Zotzenheimerstrasse 64a, 55576 Sprendlingen, DE
 (72) HEYMANN, Martin, Professor-Rüdinger-Straße 1, 55232 Erbes-Büdesheim, DE

(51) MKP
A01G 24/12 2018 (97) EP 3560908
A01G 24/15 2018
A01G 24/22 2018
C05D 1/04 2006

	C05D 9/00	2006					
	C05F 1/00	2006					
	C05F 3/00	2006					
	C05F 5/00	2006					
	C05G 1/00	2006					
	C05G 3/04	2006					
	C09K 17/00	2006					
	C09K 17/40	2006					
(96)	EP 18780317.6 3/22/2018						
(97)	EP 3560908, 10/30/2019 201944, en						
(31)	20170848		(32)	07.04.2017		(33)	CL
(54)	SOIL BUILDER						
(71)	Ganadera y Multiplicadora Genética Bio-Ñuble S.A., Ruta No. 50 San Nicolás, Octava Región, Chillán, CL						
(72)	GALLO GUÍÑEZ, Juan Aníbal, 5 de Abril 565 Región del Biobío, Chillán, CL						
<hr/>							
(51)	MKP						
	B28B 11/00	2006	(97) EP 3584383				
	B32B 3/08	2006					
	B65G 47/00	2006					
	E04C 1/40	2006					
(96)	EP 18784978.1 3/23/2018						
(97)	EP 3584383, 12/25/2019 201952, en						
(31)	2017112072		(32)	10.04.2017		(33)	RU
(54)	MULTILAYER STRUCTURAL ELEMENT, METHOD AND PRODUCTION LINE FOR PRODUCTION THEREOF						
(71)	Makhalin, Alexei Igorevich, Shmitovsky proezd 16 Korp.2, Kv.60, Moscow 123100, RU						
(72)	Makhalin, Alexei Igorevich, Shmitovsky proezd 16 Korp.2, Kv.60, Moscow 123100, RU						
<hr/>							
(51)	MKP						
	A61K 9/00	2006	(97) EP 3498268				
	A61K 31/135	2006					
	A61K 47/12	2006					
	A61P 25/24	2006					
(96)	EP 19151099.9 3/14/2014						
(97)	EP 3498268, 1/15/2020 202003, en						
(31)	201361791505 P		(32)	15.03.2013		(33)	US
(54)	PHARMACEUTICAL COMPOSITION OF S-KETAMINE HYDROCHLORIDE						
(72)	BASSTANIE, Esther D. G., Nazarethpad 34, B-2240 Zandhoven, BE						
	BENTZ, Johanna, 36036 Bayonne Drive, Newark, CA California 94560, US						
	EMBRECHTS, Roger C.A., Sperwersweg 5, B-2360 Oud-Turnhout, BE						
	NIEMEIJER, Nico Rudolph, Biesvelden 8, NL-5685 JB Best, NL						

Indeks brojeva zahtjeva za proširenje evropskih prijava patenta**Indeks brojeva zahtjeva za proširenje evropskih prijava patenta**

Broj objave evropske prijave patenta (97)	MKP (51)
3559365	B32B 5/14 (2006.01) C04B 28/14 (2006.01) E04C 2/04 (2006.01)
3257504	A61K 9/70 (2006.01) A61K 31/381 (2006.01)
3441136	B01J 8/10 (2006.01) B01J 8/22 (2006.01) B01J 8/38 (2006.01) B01J 19/18 (2006.01) C10L 1/08 (2006.01) F04C 7/00 (2006.01) F04C 19/00 (2006.01)
3486766	G06F 8/35 (2018.01) G06F 11/36 (2006.01) G06F 17/50 (2006.01) G06Q 30/08 (2012.01)
3489686	G01N 33/558 (2006.01) G01N 33/569 (2006.01)
3489003	B29C 65/48 (2006.01) B29D 22/02 (2006.01) B29K 105/04 (2006.01) B63B 7/08 (2006.01) B63C 1/02 (2006.01)
3492143	A61K 8/04 (2006.01) A61K 8/73 (2006.01) A61Q 11/00 (2006.01)
3558376	A61K 31/58 (2006.01) A61K 35/00 (2006.01) A61K 45/06 (2006.01)
3558388	A61K 47/65 (2017.01) A61P 35/00 (2006.01)
3559022	C07K 14/195 (2006.01) C07K 14/52 (2006.01) C12N 15/70 (2006.01) C12N 15/74 (2006.01)
3558973	A61K 31/4439 (2006.01) A61K 31/444 (2006.01) A61P 37/00 (2006.01) C07D 213/81 (2006.01) C07D 401/12 (2006.01) C07D 401/14 (2006.01) C07D 413/14 (2006.01) C07D 513/04 (2006.01)
3559040	A61P 35/00 (2006.01) C07K 16/28 (2006.01)

Broj objave evropske prijave patenta (97)	MKP (51)
3551224	A61K 39/12 (2006.01) A61K 39/235 (2006.01) C07K 14/075 (2006.01) C12N 15/861 (2006.01)
3563208	F16K 1/12 (2006.01) G05D 16/06 (2006.01) G05D 16/16 (2006.01)
3558985	A61K 31/423 (2006.01) A61P 37/00 (2006.01) C07D 413/06 (2006.01) C07D 413/12 (2006.01) C07D 413/14 (2006.01) C07D 471/04 (2006.01) C07D 487/04 (2006.01) C07D 498/04 (2006.01) C07D 513/04 (2006.01)
3562503	A61K 39/09 (2006.01) A61K 47/64 (2017.01) A61P 31/04 (2006.01)
3551489	B60K 6/48 (2007.01)
3558969	A61K 31/4439 (2006.01) A61K 31/444 (2006.01) A61K 31/4725 (2006.01) A61K 31/538 (2006.01) A61P 35/00 (2006.01) C07D 401/12 (2006.01) C07D 401/14 (2006.01) C07D 405/14 (2006.01) C07D 413/14 (2006.01) C07D 417/14 (2006.01) C07D 471/04 (2006.01) C07D 487/04 (2006.01) C07D 491/04 (2006.01) C07D 495/04 (2006.01)
3453381	A23L 33/105 (2016.01) A23L 33/15 (2016.01) A23L 33/175 (2016.01) A61K 8/97 (2017.01) A61K 9/48 (2006.01) A61K 31/197 (2006.01) A61K 31/4188 (2006.01) A61K 47/18 (2017.01)
3456736	C07K 16/24 (2006.01)
3456737	C07K 16/24 (2006.01)
3456738	C07K 16/24 (2006.01)
3459527	A61K 9/16 (2006.01) A61K 39/00 (2006.01)
3459528	A61K 9/16 (2006.01) A61K 39/00 (2006.01)

Broj objave evropske prijava patenta (97)	MKP (51)
3459529	A61K 9/16 (2006.01) A61K 39/00 (2006.01) C07K 16/24 (2006.01)
3580550	G01N 15/02 (2006.01) G01N 15/14 (2006.01) G01N 21/47 (2006.01) G01N 21/51 (2006.01) G01N 35/00 (2006.01) G01N 35/04 (2006.01)
3552018	G01N 33/52 (2006.01) G01N 33/543 (2006.01) G01N 33/558 (2006.01)
3449933	A61K 38/46 (2006.01) A61K 47/68 (2017.01) C07K 16/44 (2006.01) C07K 16/46 (2006.01) C07K 19/00 (2006.01) C12N 9/22 (2006.01) C12N 15/55 (2006.01) C12N 15/62 (2006.01)
3569967	F41A 27/08 (2006.01) F41A 27/10 (2006.01)
3250597	A61K 39/395 (2006.01) A61P 27/02 (2006.01) A61P 35/00 (2006.01) C07K 16/22 (2006.01)
3247721	C07K 16/00 (2006.01) C07K 16/28 (2006.01) C07K 16/32 (2006.01)
3573687	A61M 5/20 (2006.01) A61M 5/315 (2006.01)
3552529	A47J 47/00 (2006.01)
3573919	B66F 7/06 (2006.01) B66F 9/06 (2006.01) B66F 9/075 (2006.01)
3566000	F16M 11/04 (2006.01) F16M 13/02 (2006.01)
3565547	A61K 31/337 (2006.01) A61K 31/519 (2006.01) A61K 45/06 (2006.01) A61P 35/00 (2006.01)
3565545	A61K 31/255 (2006.01) A61K 31/421 (2006.01) A61K 31/427 (2006.01) A61P 13/08 (2006.01)
3568780	G06F 3/03 (2006.01) G06F 17/50 (2006.01)

Broj objave evropske prijava patenta (97)	MKP (51)
3571192	A61K 31/506 (2006.01) A61P 17/14 (2006.01) A61P 37/00 (2006.01) C07D 403/04 (2006.01) C07D 403/14 (2006.01)
3571296	A61K 35/12 (2015.01) A61K 35/15 (2015.01) A61K 35/28 (2015.01) A61K 48/00 (2006.01) C07K 14/435 (2006.01) C12N 5/0775 (2010.01) C12N 5/0786 (2010.01)
3576797	A61L 2/07 (2006.01) A61L 11/00 (2006.01)
3568264	B25B 27/30 (2006.01) E05D 13/00 (2006.01)
3577112	A61K 31/437 (2006.01) A61P 35/00 (2006.01) C07D 471/04 (2006.01)
3565835	A61K 39/00 (2006.01) A61P 31/04 (2006.01) C07K 16/12 (2006.01)
3565526	A61K 9/00 (2006.01) A61K 31/00 (2006.01) A61K 47/10 (2017.01) A61K 47/32 (2006.01) A61K 47/38 (2006.01)
3568698	A61K 39/00 (2006.01) C07K 14/35 (2006.01) C07K 16/12 (2006.01) G01N 33/569 (2006.01)
3565811	A61K 31/4725 (2006.01) A61P 1/10 (2006.01) A61P 9/12 (2006.01) C07D 401/12 (2006.01) C07D 401/14 (2006.01)
3568135	A61K 31/437 (2006.01) A61K 31/4439 (2006.01) A61K 31/519 (2006.01) A61P 25/28 (2006.01)
3568313	B60L 5/42 (2006.01) B60L 11/18 (2006.01)
3576740	A61K 31/498 (2006.01) A61P 35/00 (2006.01) G01N 33/574 (2006.01)
3570823	A61K 31/01 (2006.01) A61K 31/4745 (2006.01) A61K 31/513 (2006.01) A61K 31/555 (2006.01) A61K 45/06 (2006.01)

Broj objave evropske prijave patenta (97)	MKP (51)
	A61P 35/00 (2006.01)
3571036	B29C 49/06 (2006.01) B29C 49/36 (2006.01) B29C 49/42 (2006.01) B29C 49/80 (2006.01)
3573716	A61K 38/17 (2006.01) A61P 21/00 (2006.01)
3565888	A61K 35/17 (2015.01) C12N 5/078 (2010.01) C12N 5/0783 (2010.01)
3565836	A61P 25/28 (2006.01) C07K 16/18 (2006.01) G01N 33/68 (2006.01)
3570882	A61K 39/395 (2006.01) A61P 7/02 (2006.01) C07K 16/36 (2006.01)
3573647	A61K 39/00 (2006.01) C07K 7/06 (2006.01) C07K 7/08 (2006.01) C07K 14/47 (2006.01) C07K 14/705 (2006.01)
3570834	A61K 31/437 (2006.01) A61K 31/519 (2006.01) A61P 25/28 (2006.01)
3570839	A61K 31/4545 (2006.01) A61P 35/00 (2006.01)
3568146	A61K 8/00 (2006.01) A61K 9/00 (2006.01) A61K 36/53 (2006.01) A61P 17/14 (2006.01)
3574004	C07K 14/64 (2006.01)
3582825	A61J 1/14 (2006.01) A61J 1/20 (2006.01) A61M 5/145 (2006.01) A61M 5/28 (2006.01)
3573983	A61K 31/445 (2006.01) A61P 25/00 (2006.01) A61P 25/28 (2006.01) C07D 417/14 (2006.01)
3573981	A61K 31/496 (2006.01) A61P 25/28 (2006.01) C07D 417/12 (2006.01) C07D 417/14 (2006.01)
3573982	A61K 31/496 (2006.01) A61K 31/501 (2006.01) A61K 31/506 (2006.01) A61P 25/28 (2006.01)

Broj objave evropske prijave patenta (97)	MKP (51)
	A61P 35/00 (2006.01) C07D 417/12 (2006.01) C07D 417/14 (2006.01)
3573986	C07D 471/04 (2006.01) C07D 487/04 (2006.01) C07D 498/04 (2006.01)
3577222	C12N 15/113 (2010.01) G01N 33/574 (2006.01)
3579928	A61K 8/02 (2006.01) A61K 8/19 (2006.01) A61K 8/29 (2006.01) A61Q 17/04 (2006.01)
3565594	A61K 39/395 (2006.01) A61P 35/00 (2006.01) C07K 16/28 (2006.01)
3573987	A61K 31/437 (2006.01) A61K 31/519 (2006.01) A61P 11/06 (2006.01) C07D 471/04 (2006.01) C07D 487/04 (2006.01) C07D 519/00 (2006.01)
3583662	H01R 4/36 (2006.01) H01R 12/51 (2011.01) H01R 12/75 (2011.01)
3573597	A61K 9/00 (2006.01) A61K 47/32 (2006.01) A61K 47/36 (2006.01)
3565808	A61K 31/40 (2006.01) A61K 31/41 (2006.01) A61K 31/435 (2006.01) A61K 31/445 (2006.01) A61K 31/4462 (2006.01) C07D 207/12 (2006.01) C07D 211/56 (2006.01) C07D 225/02 (2006.01) C07D 249/04 (2006.01) C07D 295/033 (2006.01) C07D 317/26 (2006.01)
3571307	C12P 7/22 (2006.01) C12P 17/06 (2006.01)
3580211	A61K 31/501 (2006.01) A61P 35/00 (2006.01) C07D 237/04 (2006.01) C07D 237/24 (2006.01) C07D 401/04 (2006.01) C07D 401/14 (2006.01) C07D 403/04 (2006.01) C07D 405/14 (2006.01) C07D 409/04 (2006.01) C07D 413/04 (2006.01) C07D 417/04 (2006.01) C07D 417/14 (2006.01)

Broj objave evropske prijava patenta (97)	MKP (51)
3565844	A61P 35/00 (2006.01) C07K 16/28 (2006.01)
3583224	C12P 19/24 (2006.01)
3571187	A61K 31/416 (2006.01) A61K 31/4162 (2006.01) A61K 31/424 (2006.01) A61K 31/429 (2006.01) A61P 1/00 (2006.01) A61P 5/00 (2006.01) A61P 11/00 (2006.01) A61P 13/00 (2006.01) A61P 17/00 (2006.01) A61P 25/00 (2006.01) A61P 31/00 (2006.01) A61P 35/00 (2006.01) C07D 231/56 (2006.01) C07D 263/52 (2006.01) C07D 265/12 (2006.01) C07D 487/04 (2006.01) C07D 498/04 (2006.01) C07D 498/20 (2006.01) C07D 513/04 (2006.01)
3573948	C07C 205/19 (2006.01) C07D 207/452 (2006.01) C07D 487/04 (2006.01) C07D 519/04 (2006.01)
3577136	A61K 39/00 (2006.01) A61K 39/395 (2006.01) C07K 16/28 (2006.01)
3586127	G01N 33/36 (2006.01)
3576762	A61K 9/00 (2006.01) A61K 38/00 (2006.01) C12N 9/64 (2006.01)
3577169	C04B 18/16 (2006.01) C04B 26/26 (2006.01) C08L 91/00 (2006.01) C08L 95/00 (2006.01) E01C 1/00 (2006.01) E01C 7/35 (2006.01)
3576770	A61K 31/215 (2006.01) A61K 31/5377 (2006.01) A61K 38/08 (2019.01) A61P 27/02 (2006.01) A61P 27/06 (2006.01)
3568414	A61K 31/454 (2006.01) A61K 39/00 (2006.01) A61P 35/00 (2006.01) C07K 16/28 (2006.01) C12Q 1/6869 (2018.01)
3585844	C08J 7/04 (2006.01) C09D 151/02 (2006.01)

Broj objave evropske prijave patenta (97)	MKP (51)
3577121	C07D 487/10 (2006.01)
3580233	C07K 16/00 (2006.01) C07K 16/10 (2006.01) C07K 16/28 (2006.01)
3580204	A61K 31/44 (2006.01) A61P 35/00 (2006.01) C07D 213/72 (2006.01)
3580215	A61K 31/427 (2006.01) A61K 31/44 (2006.01) A61P 35/00 (2006.01) C07D 401/12 (2006.01) C07D 403/12 (2006.01) C07D 417/12 (2006.01)
3580209	A61K 31/44 (2006.01) A61P 35/00 (2006.01) C07D 401/12 (2006.01) C07D 407/12 (2006.01)
3579964	B01D 53/14 (2006.01) B01D 53/50 (2006.01) B01D 53/78 (2006.01) B01J 4/00 (2006.01) B01J 19/24 (2006.01)
3473636	A61K 31/664 (2006.01) A61K 31/675 (2006.01) A61K 31/7072 (2006.01) A61K 31/7076 (2006.01) A61K 31/708 (2006.01) A61P 31/18 (2006.01) A61P 31/20 (2006.01) C07F 9/36 (2006.01) C07F 9/44 (2006.01) C07F 9/6561 (2006.01) C07H 19/10 (2006.01) C07H 19/20 (2006.01)
3592287	A61F 2/24 (2006.01)
3551626	A61K 31/426 (2006.01) A61P 25/08 (2006.01) C07D 213/76 (2006.01) C07D 237/20 (2006.01) C07D 239/69 (2006.01) C07D 261/16 (2006.01) C07D 277/52 (2006.01) C07D 285/08 (2006.01) C07D 403/12 (2006.01) C07D 413/12 (2006.01) C07D 493/10 (2006.01)
3457314	G06K 9/00 (2006.01)
3454297	G06T 7/00 (2017.01)
3456178	A01G 2/30 (2018.01)

Broj objave evropske prijava patenta (97)	MKP (51)
3461073	G06F 21/33 (2013.01) G06Q 10/10 (2012.01) H04L 12/58 (2006.01) H04L 29/06 (2006.01) H04W 4/14 (2009.01) H04W 12/06 (2009.01)
3461074	G06F 21/33 (2013.01) G06Q 10/10 (2012.01) H04L 12/58 (2006.01) H04L 29/06 (2006.01) H04W 4/14 (2009.01) H04W 12/06 (2009.01)
3498276	A61K 31/4164 (2006.01) A61K 31/505 (2006.01) A61P 15/02 (2006.01)
3466409	A61K 9/107 (2006.01) A61K 9/16 (2006.01) A61K 9/20 (2006.01) A61K 9/50 (2006.01) A61K 31/192 (2006.01) A61K 31/519 (2006.01)
3565418	A23G 9/08 (2006.01) A23G 9/40 (2006.01) A23G 9/52 (2006.01)
3570891	A61K 47/00 (2006.01) A61P 35/00 (2006.01)
3530649	C07C 291/02 (2006.01) C07C 405/00 (2006.01)
3457318	G06K 9/00 (2006.01)
3456325	A61K 31/33 (2006.01) A61P 25/00 (2006.01) C07D 213/50 (2006.01) C07D 231/56 (2006.01) C07D 235/06 (2006.01) C07D 263/56 (2006.01) C07D 307/80 (2006.01) C07D 311/58 (2006.01) C07D 317/54 (2006.01) C07D 319/18 (2006.01) C07D 327/06 (2006.01) C07D 333/54 (2006.01) C07D 339/08 (2006.01) C07D 401/06 (2006.01) C07D 405/06 (2006.01) C07D 407/06 (2006.01) C07D 409/06 (2006.01) C07D 411/06 (2006.01) C07D 413/06 (2006.01)
3456318	A61K 9/14 (2006.01) A61K 9/16 (2006.01) A61K 9/20 (2006.01) A61K 31/00 (2006.01)
3456743	C07K 16/28 (2006.01)

Broj objave evropske prijave patenta (97)	MKP (51)
3453708	A61K 31/506 (2006.01) A61P 35/00 (2006.01) C07D 401/12 (2006.01)
3461889	C07K 14/00 (2006.01) C07K 19/00 (2006.01) C12N 9/00 (2006.01) C12N 9/12 (2006.01) C12N 9/96 (2006.01)
3459958	C07F 9/576 (2006.01) C07F 9/58 (2006.01)
3449720	A01K 29/00 (2006.01) A01K 63/00 (2017.01) A22B 3/00 (2006.01) A23B 4/06 (2006.01)
3450819	F17C 5/02 (2006.01)
3456321	A61K 9/20 (2006.01) A61K 9/28 (2006.01) A61K 31/4174 (2006.01) A61P 25/04 (2006.01)
3450434	A61K 31/519 (2006.01) A61P 35/02 (2006.01) C07B 59/00 (2006.01) C07D 487/04 (2006.01)
3456740	C07K 16/24 (2006.01)
3555087	C07D 403/14 (2006.01) C07D 417/12 (2006.01) C07D 417/14 (2006.01)
3555064	A61K 31/4427 (2006.01) A61K 31/497 (2006.01) A61P 3/00 (2006.01) C07D 401/14 (2006.01) C07D 405/14 (2006.01) C07D 413/14 (2006.01) C07D 471/04 (2006.01) C07D 487/04 (2006.01)
3551225	A61K 39/395 (2006.01) C07K 16/28 (2006.01)
3558316	A61K 31/513 (2006.01) A61P 15/00 (2006.01)
3555104	A61K 31/5365 (2006.01) A61P 1/16 (2006.01) A61P 9/00 (2006.01) A61P 11/00 (2006.01) A61P 11/06 (2006.01) A61P 13/12 (2006.01) A61P 17/06 (2006.01) A61P 35/00 (2006.01) C07D 498/04 (2006.01)

Broj objave evropske prijave patenta (97)	MKP (51)
3555088	A61K 31/554 (2006.01) A61P 1/16 (2006.01) A61P 9/00 (2006.01) A61P 11/00 (2006.01) A61P 11/06 (2006.01) A61P 13/12 (2006.01) A61P 17/06 (2006.01) A61P 35/00 (2006.01) C07D 417/12 (2006.01) C07D 417/14 (2006.01) C07D 498/04 (2006.01)
3551660	A61K 39/00 (2006.01) C07K 16/28 (2006.01)
3558948	A61K 31/55 (2006.01) A61P 9/10 (2006.01) C07D 223/16 (2006.01)
3555068	A61K 31/551 (2006.01) A61P 9/04 (2006.01) A61P 11/00 (2006.01) C07D 403/10 (2006.01) C07D 403/12 (2006.01)
3555082	A61K 31/553 (2006.01) A61K 31/554 (2006.01) A61P 9/04 (2006.01) A61P 11/00 (2006.01) C07D 249/04 (2006.01) C07D 413/12 (2006.01) C07D 419/12 (2006.01) C07D 419/14 (2006.01) C07D 471/04 (2006.01) C07D 498/04 (2006.01)
3585779	A61K 31/496 (2006.01) A61K 31/497 (2006.01) A61K 31/501 (2006.01) A61K 31/506 (2006.01) C07B 59/00 (2006.01) C07D 401/12 (2006.01) C07D 403/12 (2006.01) C07D 405/12 (2006.01) C07D 405/14 (2006.01) C07D 407/12 (2006.01) C07D 413/12 (2006.01) C07D 417/12 (2006.01) C07D 417/14 (2006.01) C07D 471/04 (2006.01) C07D 475/04 (2006.01) C07D 487/04 (2006.01) C07D 495/04 (2006.01) C07D 498/04 (2006.01) C07D 513/04 (2006.01)
3585783	C07D 401/12 (2006.01) C07D 405/12 (2006.01) C07D 413/12 (2006.01) C07D 417/12 (2006.01) C07D 417/14 (2006.01) C07D 495/04 (2006.01)

Broj objave evropske prijava patenta (97)	MKP (51)
3566583	A21D 13/80 (2017.01) A23L 5/40 (2016.01) A23L 33/00 (2016.01) A23L 33/21 (2016.01)
3552303	H02K 3/52 (2006.01)
3574898	A61K 31/165 (2006.01) A61P 25/14 (2006.01)
3461821	A61K 31/4045 (2006.01) A61P 29/00 (2006.01) A61P 37/00 (2006.01) C07D 209/18 (2006.01) C07D 401/04 (2006.01) C07D 401/06 (2006.01) C07D 401/12 (2006.01) C07D 403/04 (2006.01) C07D 403/10 (2006.01) C07D 403/12 (2006.01) C07D 413/04 (2006.01) C07D 417/04 (2006.01) C07D 471/04 (2006.01) C07D 487/04 (2006.01) C07D 487/10 (2006.01)
3466977	C07K 16/28 (2006.01)
3461828	C07D 207/06 (2006.01) C07D 239/46 (2006.01) C07D 239/47 (2006.01) C07D 239/48 (2006.01) C07D 239/545 (2006.01) C07D 487/04 (2006.01)
3476410	A61L 27/36 (2006.01) A61L 27/38 (2006.01) A61L 27/54 (2006.01)
3466420	A61K 31/225 (2006.01) A61P 25/14 (2006.01) A61P 25/28 (2006.01)
3483273	A61K 31/7088 (2006.01) A61P 35/00 (2006.01) C07K 14/47 (2006.01) C12N 15/113 (2010.01)
3473648	A61K 39/00 (2006.01) A61K 39/395 (2006.01) A61P 35/00 (2006.01) C07K 16/22 (2006.01) C07K 16/28 (2006.01) C07K 16/30 (2006.01)
3486076	B29C 31/04 (2006.01) B29C 70/48 (2006.01) B29C 70/54 (2006.01)
3495505	C12Q 1/6804 (2018.01)
3488932	B03C 1/033 (2006.01)

Broj objave evropske prijave patenta (97)	MKP (51)
	B03C 1/22 (2006.01) B03C 1/23 (2006.01)
3466490	A61K 31/4375 (2006.01) A61K 31/4985 (2006.01) A61K 31/5365 (2006.01) A61K 45/06 (2006.01) A61P 31/18 (2006.01) C07D 491/14 (2006.01) C07D 491/22 (2006.01) C07D 498/14 (2006.01) C07D 498/16 (2006.01) C07D 498/22 (2006.01) C07D 513/22 (2006.01)
3495385	A61K 35/37 (2015.01) A61L 2/00 (2006.01) C07K 14/755 (2006.01)
3491933	A23B 5/005 (2006.01) A23B 5/01 (2006.01) A23L 3/005 (2006.01) A23L 15/00 (2016.01)
3483635	G01V 5/00 (2006.01)
3492472	A61K 31/519 (2006.01) A61P 17/06 (2006.01) A61P 19/02 (2006.01) C07B 59/00 (2006.01) C07D 471/04 (2006.01) C07D 487/04 (2006.01)
3486248	C07D 498/16 (2006.01) C07D 498/18 (2006.01)
3489362	A61P 35/00 (2006.01) C12N 15/85 (2006.01)
3501542	A61K 31/135 (2006.01) A61K 45/06 (2006.01) A61P 25/24 (2006.01)
3558379	A61K 9/00 (2006.01) A61K 9/08 (2006.01) A61K 31/496 (2006.01) A61K 47/10 (2017.01)
3558988	A61K 31/437 (2006.01) A61K 31/4985 (2006.01) A61P 25/00 (2006.01) A61P 25/16 (2006.01) A61P 25/28 (2006.01) C07D 471/04 (2006.01) C07D 487/04 (2006.01) C07D 519/00 (2006.01)
3558951	A61K 31/5375 (2006.01) C07C 21/00 (2006.01) C07D 265/30 (2006.01)
3551444	B30B 11/20 (2006.01)

Broj objave evropske prijava patenta (97)	MKP (51)
3555114	C07K 1/14 (2006.01) C07K 7/08 (2006.01) C07K 7/56 (2006.01)
3552030	G01R 15/26 (2006.01) G01R 29/08 (2006.01)
3551754	C07K 14/47 (2006.01) C12N 15/10 (2006.01) C12N 15/63 (2006.01) C12N 15/864 (2006.01)
3558380	A61K 9/08 (2006.01) A61K 31/496 (2006.01) A61K 47/10 (2017.01)
3555400	E05F 11/38 (2006.01) E05F 11/48 (2006.01)
3558952	C07C 21/04 (2006.01) C07C 21/17 (2006.01) C07D 265/30 (2006.01)
3555389	A47K 3/28 (2006.01) E03C 1/04 (2006.01) E04H 1/12 (2006.01) E04H 9/02 (2006.01)
3555105	A61K 31/5365 (2006.01) A61P 35/00 (2006.01) C07D 498/04 (2006.01)
3555080	A61K 31/5355 (2006.01) A61K 31/5377 (2006.01) A61P 25/28 (2006.01) C07D 265/08 (2006.01) C07D 265/12 (2006.01) C07D 265/30 (2006.01) C07D 413/10 (2006.01)
3555084	A61K 31/541 (2006.01) A61P 25/00 (2006.01) A61P 25/28 (2006.01) C07D 417/10 (2006.01)
3555106	A61K 31/5365 (2006.01) A61K 31/542 (2006.01) A61P 25/00 (2006.01) A61P 25/28 (2006.01) C07D 498/04 (2006.01) C07D 513/04 (2006.01)
3555085	A61K 31/5415 (2006.01) A61P 25/28 (2006.01) C07D 279/08 (2006.01) C07D 417/10 (2006.01) C07D 417/14 (2006.01)
3555086	A61K 31/54 (2006.01) A61P 25/28 (2006.01) C07D 417/10 (2006.01)

Broj objave evropske prijava patenta (97)	MKP (51)
	C07D 417/14 (2006.01) C07D 471/04 (2006.01) C07D 491/056 (2006.01) C07D 498/08 (2006.01) C07D 513/04 (2006.01)
3555066	A61K 31/4184 (2006.01) A61P 11/06 (2006.01) A61P 35/00 (2006.01) C07D 235/08 (2006.01) C07D 401/12 (2006.01) C07D 401/14 (2006.01) C07D 403/04 (2006.01)
3563094	F24F 3/00 (2006.01) F24F 3/14 (2006.01) F24F 3/16 (2006.01) F24F 5/00 (2006.01) F24F 6/00 (2006.01) F28C 3/06 (2006.01)
3554536	A61K 39/12 (2006.01) A61K 39/155 (2006.01) A61K 39/245 (2006.01) A61K 39/295 (2006.01) C07K 14/03 (2006.01) C07K 14/08 (2006.01) C12N 7/00 (2006.01)
3555129	A61K 39/395 (2006.01) C07K 16/22 (2006.01)
3558622	B29C 45/17 (2006.01)
3551653	C07K 14/725 (2006.01) C12N 15/09 (2006.01)
3551654	C07K 14/725 (2006.01) C07K 16/30 (2006.01)
3555094	A61K 31/437 (2006.01) A61P 25/00 (2006.01) C07D 471/04 (2006.01) C07D 493/04 (2006.01)
3558997	A61K 31/522 (2006.01) A61P 35/00 (2006.01) C07D 473/18 (2006.01) C07D 519/00 (2006.01)
3573928	C01F 11/18 (2006.01) C09C 1/02 (2006.01)
3562519	A61L 9/12 (2006.01)
3551733	C10J 3/26 (2006.01) C10J 3/30 (2006.01) C10J 3/36 (2006.01) C10J 3/86 (2006.01) C10K 1/04 (2006.01)
3555096	A61K 31/437 (2006.01)

Broj objave evropske prijave patenta (97)	MKP (51)
	A61P 35/00 (2006.01) A61P 37/00 (2006.01) C07D 471/14 (2006.01)
3558960	A61K 31/415 (2006.01) A61P 29/00 (2006.01) C07D 213/56 (2006.01) C07D 231/12 (2006.01) C07D 231/56 (2006.01) C07D 233/64 (2006.01) C07D 241/12 (2006.01) C07D 277/56 (2006.01) C07D 333/28 (2006.01) C07D 333/38 (2006.01) C07D 333/58 (2006.01) C07D 495/04 (2006.01)
3555325	C07C 211/63 (2006.01) C22B 3/26 (2006.01) C22B 59/00 (2006.01)
3551622	A61K 31/455 (2006.01) A61P 11/00 (2006.01) C07D 231/20 (2006.01) C07D 401/04 (2006.01) C07D 401/14 (2006.01)
3554552	A61K 47/64 (2017.01) A61P 21/00 (2006.01)
3555039	C07C 201/08 (2006.01) C07C 205/06 (2006.01)
3555307	C12Q 1/68 (2018.01)
3558999	A61K 31/519 (2006.01) A61P 11/00 (2006.01) A61P 37/00 (2006.01) C07D 487/04 (2006.01)
3554522	A23L 33/135 (2016.01) A61K 9/00 (2006.01) A61K 9/14 (2006.01) A61K 9/20 (2006.01) A61K 35/741 (2015.01) A61K 35/744 (2015.01) A61K 35/745 (2015.01) A61K 35/747 (2015.01) A61K 36/06 (2006.01) A61P 1/00 (2006.01)
3558389	A61K 47/68 (2017.01) A61P 43/00 (2006.01) C07K 16/28 (2006.01)
3555090	A61K 31/427 (2006.01) A61P 35/00 (2006.01) C07D 277/44 (2006.01) C07D 417/12 (2006.01)
3554492	A23L 33/175 (2016.01) A23L 33/18 (2016.01)

Broj objave evropske prijava patenta (97)	MKP (51)
	A61K 31/198 (2006.01) A61P 1/16 (2006.01)
3558982	A61K 31/352 (2006.01) A61P 11/00 (2006.01) A61P 11/12 (2006.01) C07D 407/12 (2006.01)
3558361	A61K 39/395 (2006.01) A61K 45/00 (2006.01) A61P 3/04 (2006.01)
3558968	A61P 35/00 (2006.01) A61P 37/00 (2006.01) C07D 401/12 (2006.01)
3551617	A61K 31/444 (2006.01) A61P 25/06 (2006.01) C07D 401/06 (2006.01)
3554822	B32B 5/02 (2006.01) B32B 5/20 (2006.01) B32B 5/26 (2006.01) B32B 13/02 (2006.01) B32B 13/04 (2006.01) B32B 13/08 (2006.01) B32B 13/14 (2006.01) B32B 27/28 (2006.01) B32B 27/30 (2006.01) B32B 29/00 (2006.01) B32B 29/02 (2006.01) C04B 2/02 (2006.01) C04B 2/04 (2006.01) C04B 28/14 (2006.01) E04C 2/04 (2006.01)
3555070	A61K 31/519 (2006.01) A61P 35/00 (2006.01) C07D 403/12 (2006.01) C07D 403/14 (2006.01) C07D 413/12 (2006.01) C07D 471/04 (2006.01) C07D 487/04 (2006.01) C07D 491/04 (2006.01) C07D 491/14 (2006.01) C07D 498/04 (2006.01)
3559011	A61K 31/675 (2006.01) A61P 31/18 (2006.01) C07F 9/6561 (2006.01)
3558989	A61K 31/437 (2006.01) A61P 37/00 (2006.01) C07D 471/04 (2006.01)
3559009	A61K 31/69 (2006.01) A61P 35/00 (2006.01) C07F 5/02 (2006.01)
3551221	A61K 39/00 (2006.01) C07K 14/47 (2006.01) C07K 14/725 (2006.01)

Broj objave evropske prijava patenta (97)	MKP (51)
3559003	A61K 31/407 (2006.01) A61K 31/519 (2006.01) A61P 17/06 (2006.01) A61P 17/14 (2006.01) C07D 487/10 (2006.01)
3551662	A61K 39/00 (2006.01) A61P 35/00 (2006.01) C07K 16/28 (2006.01)
3558963	A61K 31/4375 (2006.01) A61K 31/519 (2006.01) A61P 37/00 (2006.01) C07D 401/04 (2006.01) C07D 519/00 (2006.01)
3558981	A61K 31/4035 (2006.01) A61K 31/4155 (2006.01) A61K 31/4709 (2006.01) A61P 35/00 (2006.01) C07D 405/06 (2006.01) C07D 405/14 (2006.01) C07D 409/14 (2006.01) C07D 413/14 (2006.01) C07D 417/14 (2006.01) C07D 451/02 (2006.01)
3558459	A61K 31/70 (2006.01) A61K 36/45 (2006.01) A61K 36/63 (2006.01) A61P 13/10 (2006.01) A61P 31/04 (2006.01)
3554553	A61K 47/64 (2017.01) A61P 21/00 (2006.01)
3554554	A61K 47/64 (2017.01) A61P 21/00 (2006.01)
3555292	A61K 31/713 (2006.01) C07H 21/02 (2006.01) C12N 15/113 (2010.01)
3558363	A61K 9/00 (2006.01) A61K 9/08 (2006.01) A61K 39/395 (2006.01) C07K 16/24 (2006.01)
3551178	A61K 31/13 (2006.01) A61K 31/16 (2006.01) A61K 31/20 (2006.01) A61K 31/345 (2006.01) A61P 35/00 (2006.01)
3562840	C07K 14/71 (2006.01)
3558955	A61K 31/428 (2006.01) A61K 31/429 (2006.01) A61K 31/437 (2006.01) A61K 31/498 (2006.01) A61K 31/4985 (2006.01)

Broj objave evropske prijave patenta (97)	MKP (51)
	A61K 31/517 (2006.01) A61K 31/519 (2006.01) A61P 35/00 (2006.01) C07D 239/80 (2006.01) C07D 275/04 (2006.01) C07D 401/04 (2006.01) C07D 403/04 (2006.01) C07D 417/04 (2006.01) C07D 471/04 (2006.01) C07D 471/08 (2006.01) C07D 487/04 (2006.01) C07D 487/10 (2006.01) C07D 513/04 (2006.01)
3562816	A61K 31/352 (2006.01) A61K 31/47 (2006.01) C07D 217/04 (2006.01) C07D 217/08 (2006.01) C07D 223/16 (2006.01) C07D 311/76 (2006.01) C07D 498/14 (2006.01)
3562822	A61K 31/517 (2006.01) A61P 35/00 (2006.01) C07D 239/74 (2006.01) C07D 401/08 (2006.01) C07D 401/14 (2006.01) C07D 403/08 (2006.01) C07D 405/10 (2006.01) C07D 417/08 (2006.01) C07D 487/04 (2006.01)
3555097	A61K 31/437 (2006.01) A61P 29/00 (2006.01) C07D 471/14 (2006.01)
3551019	A47J 37/04 (2006.01) A47J 43/18 (2006.01)
3558309	A61K 31/4365 (2006.01) C07D 495/04 (2006.01)
3562496	A61K 36/31 (2006.01)
3551750	A61K 35/76 (2015.01) A61K 38/43 (2006.01) C12N 7/00 (2006.01) C12N 15/86 (2006.01)
3551193	A61K 9/51 (2006.01) A61K 31/7105 (2006.01) A61K 31/7115 (2006.01) A61P 31/14 (2006.01)
3551800	E01B 9/28 (2006.01) E01B 9/30 (2006.01) E01B 9/60 (2006.01) E01B 13/02 (2006.01)
3562937	A61K 35/76 (2015.01) A61K 38/43 (2006.01) C12N 7/00 (2006.01) C12N 15/86 (2006.01)

Broj objave evropske prijava patenta (97)	MKP (51)
3551149	A61F 13/15 (2006.01) A61F 13/51 (2006.01) A61F 13/511 (2006.01) A61F 13/514 (2006.01) A61F 13/53 (2006.01)
3551215	A61K 35/16 (2015.01) A61K 38/18 (2006.01) A61K 38/19 (2006.01) A61K 38/20 (2006.01)
3551667	A61K 39/395 (2006.01) C07K 16/18 (2006.01) C07K 16/28 (2006.01) C07K 16/46 (2006.01)
3556766	C07K 7/08 (2006.01) C07K 14/005 (2006.01) C07K 19/00 (2006.01)
3554266	A23K 50/10 (2016.01) A61K 31/351 (2006.01) A61K 38/00 (2006.01) A61K 39/00 (2006.01)
3554544	A61K 39/395 (2006.01) A61P 35/00 (2006.01) C07K 16/18 (2006.01) C07K 16/30 (2006.01)
3555273	A61K 35/545 (2015.01) C07K 14/705 (2006.01) C12N 5/074 (2010.01) C12N 9/12 (2006.01)
3558946	C07D 215/12 (2006.01) C07D 215/38 (2006.01)
3555289	C12N 9/22 (2006.01) C12N 11/14 (2006.01) C12N 15/10 (2006.01) C12Q 1/34 (2006.01) C12Q 1/68 (2018.01)
3556370	A61K 9/00 (2006.01) A61K 9/08 (2006.01) A61K 31/635 (2006.01) A61K 31/728 (2006.01)
3560919	A61K 31/4545 (2006.01) A61P 35/00 (2006.01) C07D 401/14 (2006.01)
3558864	B05D 1/00 (2006.01) B82B 3/00 (2006.01) B82Y 40/00 (2011.01) C08F 2/34 (2006.01) C08F 2/46 (2006.01) C08F 2/58 (2006.01) C23C 14/00 (2006.01) C23C 16/455 (2006.01)

Broj objave evropske prijava patenta (97)	MKP (51)
	C23C 16/50 (2006.01) H05H 1/24 (2006.01)
3560931	A61K 31/519 (2006.01) A61P 43/00 (2006.01) C07D 231/12 (2006.01) C07D 519/00 (2006.01)
3558369	A61K 39/395 (2006.01) A61P 19/02 (2006.01) C07K 16/24 (2006.01) G01N 33/53 (2006.01)
3558322	A61K 31/685 (2006.01) A61P 31/18 (2006.01) A61P 31/20 (2006.01) C07F 9/6561 (2006.01)
3560932	C07C 271/22 (2006.01) C07D 307/33 (2006.01) C07D 403/06 (2006.01) C07D 487/10 (2006.01) C07D 491/10 (2006.01) C07D 519/00 (2006.01)
3562486	A61K 31/415 (2006.01) A61K 31/4174 (2006.01)
3563379	G06F 17/30 (2006.01) G16H 10/20 (2018.01) G16H 15/00 (2018.01)
3570512	H04L 29/06 (2006.01) H04L 29/12 (2006.01)
3573658	A61K 39/395 (2006.01) C07K 14/525 (2006.01) C07K 16/24 (2006.01)
3576751	A61K 31/7088 (2006.01) A61K 31/7105 (2006.01) A61K 39/00 (2006.01) A61K 39/39 (2006.01) A61P 35/00 (2006.01)
3579871	A61K 39/395 (2006.01) C07K 16/18 (2006.01) C07K 16/24 (2006.01)
3581030	A21C 9/00 (2006.01) A21D 8/02 (2006.01) A21D 8/06 (2006.01) A21D 10/02 (2006.01) G07F 9/10 (2006.01) G07F 11/70 (2006.01) G07F 17/00 (2006.01)
3470397	C07D 217/26 (2006.01)
3485902	A61K 39/00 (2006.01) A61K 39/395 (2006.01) A61P 11/00 (2006.01)

Broj objave evropske prijava patenta (97)	MKP (51)
	G01N 33/48 (2006.01)
3459475	A61B 17/34 (2006.01)
3467501	G01N 33/533 (2006.01)
3473099	A01N 43/56 (2006.01) A61K 31/415 (2006.01) A61K 45/06 (2006.01) A61P 35/00 (2006.01) C07D 401/04 (2006.01) C07D 401/10 (2006.01) C07D 401/14 (2006.01) C07D 405/14 (2006.01) C07D 413/12 (2006.01)
3470063	A61K 9/20 (2006.01) A61K 31/443 (2006.01) A61K 31/47 (2006.01) A61K 45/06 (2006.01)
3467500	C12Q 1/68 (2018.01) G01N 33/52 (2006.01) G01N 33/53 (2006.01) G01N 33/543 (2006.01)
3461838	A61K 48/00 (2006.01) C07K 14/47 (2006.01) C12N 15/113 (2010.01) C12N 15/86 (2006.01)
3437474	A01N 37/34 (2006.01) A01N 37/40 (2006.01) A01N 41/10 (2006.01) A01N 43/40 (2006.01) A01N 47/36 (2006.01) A01P 13/00 (2006.01)
3460054	A61P 11/00 (2006.01) A61P 21/00 (2006.01) A61P 29/00 (2006.01) A61P 37/00 (2006.01) C12N 9/00 (2006.01) C12N 9/96 (2006.01)
3450980	B01L 3/00 (2006.01) C12Q 1/68 (2018.01) G01N 33/52 (2006.01) G01N 33/543 (2006.01)
3483611	G01N 33/68 (2006.01)
3470370	A61K 9/14 (2006.01) A61K 33/00 (2006.01) A61K 33/24 (2019.01) A61K 45/06 (2006.01) B01J 19/00 (2006.01) B01J 19/18 (2006.01) B01J 39/02 (2006.01) B01J 39/14 (2006.01) C01B 33/20 (2006.01) C01B 39/02 (2006.01)

Broj objave evropske prijava patenta (97)	MKP (51)
	C01B 39/46 (2006.01) C07F 7/02 (2006.01)
3456349	A61K 39/285 (2006.01) C07K 14/07 (2006.01) C12N 15/863 (2006.01)
3480202	A61K 39/395 (2006.01) A61K 47/50 (2017.01) A61K 51/00 (2006.01) C07D 498/14 (2006.01)
3483143	A61K 31/4412 (2006.01) A61P 35/00 (2006.01) C07D 211/40 (2006.01) C07D 279/02 (2006.01) C07D 401/04 (2006.01) C07D 401/06 (2006.01) C07D 401/12 (2006.01) C07D 407/04 (2006.01) C07D 407/06 (2006.01) C07D 409/04 (2006.01) C07D 413/06 (2006.01) C07D 417/06 (2006.01) C07D 471/20 (2006.01) C07D 498/08 (2006.01) C07D 498/20 (2006.01)
3485903	A61K 39/00 (2006.01) A61P 35/00 (2006.01) C07K 16/00 (2006.01) C12P 21/08 (2006.01)
3461465	A61F 13/00 (2006.01)
3470563	A43B 1/04 (2006.01) D04B 1/10 (2006.01) D04B 1/22 (2006.01)
3485901	A61K 38/00 (2006.01) A61K 38/39 (2006.01) A61K 39/395 (2006.01) A61K 45/06 (2006.01) A61P 35/00 (2006.01) C07K 14/78 (2006.01) C07K 16/28 (2006.01)
3468051	H04B 1/69 (2011.01) H04J 13/18 (2011.01) H04L 5/00 (2006.01)
3461483	A61K 31/444 (2006.01) A61K 31/497 (2006.01) A61P 25/28 (2006.01) C07D 401/12 (2006.01)
3466278	A23D 7/00 (2006.01) A23L 9/20 (2016.01) A23L 33/115 (2016.01) C11C 3/10 (2006.01)
3456346	A61K 39/00 (2006.01)

Broj objave evropske prijave patenta (97)	MKP (51)
	A61K 39/395 (2006.01) C07K 16/28 (2006.01)
3450458	A61K 39/395 (2006.01) A61P 29/00 (2006.01) C07K 16/28 (2006.01)
3480316	A61K 39/00 (2006.01) C12N 15/867 (2006.01)
3450438	C07F 9/40 (2006.01) C07F 9/44 (2006.01) C07H 19/20 (2006.01)
3476388	A23L 29/00 (2016.01) A23L 33/10 (2016.01) A61K 9/16 (2006.01) A61K 31/122 (2006.01)
3466431	A61K 31/70 (2006.01) C07D 317/26 (2006.01)
3466960	C07H 21/04 (2006.01) C12N 15/11 (2006.01)
3456386	A23C 9/152 (2006.01) A23L 33/135 (2016.01) A61K 9/19 (2006.01) A61K 31/00 (2006.01) A61K 35/74 (2015.01) A61K 39/00 (2006.01) A61K 39/08 (2006.01) A61P 11/06 (2006.01) A61P 19/00 (2006.01) A61P 27/02 (2006.01) A61P 29/00 (2006.01)
3492455	A61K 31/497 (2006.01) A61P 35/00 (2006.01) C07D 249/08 (2006.01) C07D 401/06 (2006.01) C07D 403/06 (2006.01) C07D 405/06 (2006.01) C07D 413/06 (2006.01) C07D 417/06 (2006.01)
3456832	A01K 67/027 (2006.01) C07K 16/00 (2006.01) C07K 16/18 (2006.01) C07K 16/46 (2006.01) C12N 15/10 (2006.01) C12N 15/85 (2006.01)
3495368	A61K 31/4985 (2006.01) A61P 19/08 (2006.01) A61P 29/00 (2006.01) A61P 31/00 (2006.01) A61P 35/00 (2006.01) A61P 37/00 (2006.01) C07D 487/04 (2006.01) C07D 519/00 (2006.01)

Broj objave evropske prijava patenta (97)	MKP (51)
3498857	A61P 21/00 (2006.01) C07H 21/04 (2006.01) C07K 16/00 (2006.01) C12P 21/08 (2006.01)
3492474	C07D 209/08 (2006.01) C07D 403/12 (2006.01) C07D 498/04 (2006.01)
3489239	C07D 401/14 (2006.01) C07D 487/04 (2006.01) C07F 5/04 (2006.01)
3479780	A61B 17/072 (2006.01)
3473619	A61K 31/4545 (2006.01) A61P 35/00 (2006.01) C07D 401/14 (2006.01)
3482808	B01D 11/02 (2006.01) B01D 11/04 (2006.01) B01D 24/00 (2006.01) B01D 29/56 (2006.01) B01D 35/18 (2006.01)
3483529	F25B 9/00 (2006.01) F25B 31/00 (2006.01) F25B 49/00 (2006.01)
3467108	C12N 15/10 (2006.01)
3476254	A47C 1/032 (2006.01) A47C 7/02 (2006.01)
3555218	C09D 5/33 (2006.01) C09D 133/02 (2006.01) C09D 201/00 (2006.01) E01B 19/00 (2006.01)
3558364	A61K 39/395 (2006.01) A61P 25/28 (2006.01) C07K 16/18 (2006.01)
3558987	A61K 31/427 (2006.01) A61P 31/04 (2006.01) C07D 417/12 (2006.01)
3559037	A61K 39/00 (2006.01) C07K 16/28 (2006.01)
3558337	A61K 38/10 (2006.01) A61K 47/32 (2006.01) A61P 1/10 (2006.01)
3554493	A23L 33/175 (2016.01) A23L 33/18 (2016.01) A61K 31/198 (2006.01) A61P 21/00 (2006.01) A61P 21/06 (2006.01)
3558365	A61K 39/00 (2006.01)

Broj objave evropske prijave patenta (97)	MKP (51)
	A61K 39/395 (2006.01) A61P 35/00 (2006.01) C07K 16/28 (2006.01) G01N 33/53 (2006.01)
3558391	A61K 47/68 (2017.01) A61P 35/00 (2006.01) C07K 16/28 (2006.01) C07K 16/30 (2006.01) C07K 16/40 (2006.01)
3551664	A61P 37/00 (2006.01) C07K 16/28 (2006.01)
3555127	A61P 25/16 (2006.01) C07K 16/18 (2006.01)
3558990	A61K 31/437 (2006.01) A61P 35/00 (2006.01) A61P 37/00 (2006.01) C07D 471/04 (2006.01)
3550965	A01M 29/28 (2011.01)
3562490	A61K 31/4178 (2006.01) A61K 31/4375 (2006.01) A61K 31/46 (2006.01) A61K 31/506 (2006.01) A61K 31/575 (2006.01) A61P 1/16 (2006.01) A61P 11/00 (2006.01) A61P 13/12 (2006.01)
3558953	C07D 265/30 (2006.01) C07D 498/04 (2006.01)
3562344	A41D 13/05 (2006.01)
3514172	A61K 35/26 (2015.01) A61P 35/00 (2006.01) C07K 14/47 (2006.01) C07K 14/725 (2006.01)
3517541	A61K 31/58 (2006.01) A61P 5/44 (2006.01) C07J 31/00 (2006.01) C07J 71/00 (2006.01)
3539448	A61B 1/00 (2006.01) A61B 1/05 (2006.01) A61B 1/227 (2006.01)
3530576	B65B 25/14 (2006.01) B65B 35/36 (2006.01) B65B 35/50 (2006.01) B65B 43/26 (2006.01) B65G 61/00 (2006.01)
3552931	B62D 55/28 (2006.01)
3552665	A61K 39/00 (2006.01)

Broj objave evropske prijave patenta (97)	MKP (51)
	A61P 35/00 (2006.01) C07K 16/28 (2006.01)
3552665	A61K 39/00 (2006.01) A61P 35/00 (2006.01) C07K 16/28 (2006.01)
3587578	A61K 31/713 (2006.01) C12N 9/64 (2006.01) C12N 15/113 (2010.01)
3578554	A61K 31/506 (2006.01) A61P 31/16 (2006.01) C07D 403/04 (2006.01) C07D 471/04 (2006.01)
3545935	A61J 1/10 (2006.01) A61J 1/14 (2006.01) A61J 1/20 (2006.01) A61J 1/22 (2006.01)
3539979	A61K 38/17 (2006.01) A61K 39/00 (2006.01) C07K 7/06 (2006.01) C07K 7/08 (2006.01) C07K 14/47 (2006.01)
3533473	A61K 51/04 (2006.01)
3539988	A61K 39/00 (2006.01) C07K 16/28 (2006.01) C07K 16/32 (2006.01)
3567200	E06B 3/66 (2006.01) E06B 3/663 (2006.01) E06B 3/667 (2006.01) E06B 3/67 (2006.01) E06B 3/677 (2006.01)
3545965	A61K 38/04 (2006.01) A61P 35/00 (2006.01) C07K 7/00 (2006.01) C07K 7/06 (2006.01) C07K 7/08 (2006.01)
3536867	B28B 7/36 (2006.01) E03F 5/02 (2006.01)
3578659	C12N 15/67 (2006.01)
3578196	A61K 38/17 (2006.01) A61K 39/00 (2006.01) C07K 7/06 (2006.01) C07K 7/08 (2006.01) C12N 5/0783 (2010.01) C12N 9/64 (2006.01)
3578988	C12N 5/0735 (2010.01) C12Q 1/68 (2018.01) G01N 33/15 (2006.01) G01N 33/68 (2006.01)

Broj objave evropske prijave patenta (97)	MKP (51)
3574916	A61K 39/00 (2006.01) A61P 35/00 (2006.01)
3572093	A61K 39/395 (2006.01) C07K 14/435 (2006.01)
3572093	A61K 39/395 (2006.01) C07K 14/435 (2006.01)
3583940	A61K 31/13 (2006.01) A61P 25/28 (2006.01)
3566714	A61K 39/12 (2006.01) C07K 14/005 (2006.01)
3556752	A61K 31/415 (2006.01) A61K 31/454 (2006.01) A61K 31/4709 (2006.01) A61K 31/497 (2006.01) A61K 31/506 (2006.01) C07D 231/14 (2006.01) C07D 401/06 (2006.01) C07D 401/10 (2006.01) C07D 401/14 (2006.01) C07D 403/10 (2006.01) C07D 409/14 (2006.01) C07D 413/14 (2006.01)
3594232	C07K 16/12 (2006.01) C07K 16/26 (2006.01) C07K 16/36 (2006.01) C07K 16/46 (2006.01)
3578512	C01B 32/20 (2017.01) C01B 32/205 (2017.01)
3594233	C07K 16/12 (2006.01) C07K 16/26 (2006.01) C07K 16/36 (2006.01) C07K 16/46 (2006.01)
3564380	A61K 31/7088 (2006.01) A61K 35/76 (2015.01) C12N 7/01 (2006.01) C12N 15/861 (2006.01)
3564378	A61K 39/00 (2006.01) A61K 39/08 (2006.01) C07K 14/33 (2006.01) C07K 16/12 (2006.01) C12N 15/62 (2006.01) C12N 15/70 (2006.01)
3564199	C04B 28/14 (2006.01) C04B 111/00 (2006.01)
3572432	A61K 39/00 (2006.01) A61P 31/00 (2006.01) A61P 35/00 (2006.01) A61P 37/00 (2006.01) C07K 16/28 (2006.01)

Broj objave evropske prijava patenta (97)	MKP (51)
3575324	A61K 39/00 (2006.01) A61P 31/00 (2006.01) A61P 35/00 (2006.01) A61P 37/00 (2006.01) C07K 16/28 (2006.01)
3567037	A61K 31/415 (2006.01) A61K 31/454 (2006.01) A61K 31/4709 (2006.01) A61K 31/497 (2006.01) A61K 31/506 (2006.01) C07D 231/14 (2006.01) C07D 401/06 (2006.01) C07D 401/10 (2006.01) C07D 401/14 (2006.01) C07D 403/10 (2006.01) C07D 409/14 (2006.01) C07D 413/14 (2006.01)
3567293	F16L 41/08 (2006.01)
3593788	A61K 9/00 (2006.01) A61K 9/08 (2006.01) A61K 31/5575 (2006.01) A61K 47/14 (2017.01) A61P 27/06 (2006.01)
3594881	G06Q 20/32 (2012.01) G06Q 20/38 (2012.01) G06Q 20/42 (2012.01)
3584252	C07K 14/16 (2006.01)
3578547	C07D 231/18 (2006.01)
3587412	A61K 31/422 (2006.01) A61K 31/4439 (2006.01) A61P 1/16 (2006.01) A61P 3/04 (2006.01) A61P 3/10 (2006.01) A61P 29/00 (2006.01) A61P 35/00 (2006.01) C07D 401/14 (2006.01) C07D 413/12 (2006.01) C07D 413/14 (2006.01)
3581573	A61K 31/437 (2006.01) A61P 35/00 (2006.01) C07D 471/04 (2006.01)
3573548	A61B 17/17 (2006.01) A61B 17/56 (2006.01) A61B 17/88 (2006.01) A61B 17/90 (2006.01) A61C 3/04 (2006.01) A61C 8/00 (2006.01)
3592825	C09K 11/08 (2006.01) C09K 11/77 (2006.01) C09K 11/80 (2006.01) G01T 1/00 (2006.01)

Broj objave evropske prijava patenta (97)	MKP (51)
	G01T 1/02 (2006.01) G01T 1/20 (2006.01)
3587752	F01K 25/10 (2006.01) H02K 7/18 (2006.01) H02K 35/02 (2006.01)
3556761	A61K 31/53 (2006.01) A61P 35/00 (2006.01) C07D 487/04 (2006.01)
3592357	A61K 31/133 (2006.01) A61K 31/56 (2006.01) A61K 31/575 (2006.01) C07J 5/00 (2006.01) C07J 9/00 (2006.01) C07J 31/00 (2006.01)
3577110	A61K 31/337 (2006.01) A61K 31/4155 (2006.01) A61K 31/495 (2006.01) A61K 31/504 (2006.01) A61K 31/506 (2006.01) A61K 31/5365 (2006.01) C07C 243/28 (2006.01) C07C 275/16 (2006.01) C07D 401/12 (2006.01) C07D 403/12 (2006.01) C07D 405/14 (2006.01) C07D 471/08 (2006.01) C07D 487/08 (2006.01) C07D 487/10 (2006.01) C07D 491/04 (2006.01)
3579889	A61L 17/00 (2006.01) A61L 17/10 (2006.01) A61L 17/14 (2006.01)
3580238	A61K 39/00 (2006.01) A61K 51/10 (2006.01) C07C 259/00 (2006.01) C07K 16/28 (2006.01)
3585780	C07D 209/10 (2006.01) C07D 401/12 (2006.01) C07D 403/12 (2006.01) C07D 405/12 (2006.01)
3576788	A61K 39/395 (2006.01) C07K 16/28 (2006.01)
3585908	C12Q 1/6886 (2018.01)
3576907	B24B 3/54 (2006.01)
3580203	A61K 31/44 (2006.01) A61P 35/00 (2006.01) C07D 213/71 (2006.01) C07D 401/12 (2006.01) C07D 405/12 (2006.01)
3573840	B42C 7/00 (2006.01)

Broj objave evropske prijava patenta (97)	MKP (51)
	B42C 15/00 (2006.01)
3577115	A61K 31/437 (2006.01) A61P 35/00 (2006.01) C07D 471/04 (2006.01)
3583128	A61P 37/06 (2006.01) C07K 16/28 (2006.01)
3573663	A61K 38/09 (2006.01) A61K 45/06 (2006.01) A61P 35/00 (2006.01)
3577139	A61K 39/395 (2006.01) A61K 47/68 (2017.01) C07K 16/28 (2006.01)
3579787	A61D 1/02 (2006.01) A61D 7/00 (2006.01) A61J 1/06 (2006.01)
3585441	A61K 47/60 (2017.01) A61P 35/00 (2006.01) C08G 69/10 (2006.01) C08G 69/40 (2006.01) C08G 83/00 (2006.01)
3589323	A61K 31/437 (2006.01) A61K 31/438 (2006.01) A61K 31/4545 (2006.01) A61K 31/47 (2006.01) A61K 31/4965 (2006.01) A61K 31/498 (2006.01) A61K 45/06 (2006.01) A61P 31/06 (2006.01)
3589954	A61K 38/00 (2006.01) G01N 33/569 (2006.01)
3589310	A61K 39/00 (2006.01) A61K 39/12 (2006.01) G01N 33/50 (2006.01) G01N 33/569 (2006.01)
3582775	A61K 31/444 (2006.01) A61K 31/541 (2006.01) A61K 45/06 (2006.01) A61P 29/00 (2006.01) A61P 35/00 (2006.01) A61P 37/00 (2006.01) A61P 37/06 (2006.01) A61P 37/08 (2006.01) A61P 43/00 (2006.01)
3580232	A61K 38/22 (2006.01) C07K 14/64 (2006.01)
3583120	A61K 38/40 (2006.01) A61K 39/00 (2006.01) C07K 14/705 (2006.01) C07K 14/79 (2006.01)

Broj objave evropske prijave patenta (97)	MKP (51)
3582853	A61K 31/7084 (2006.01) A61P 31/04 (2006.01) A61P 37/04 (2006.01) C07F 9/6527 (2006.01) C07F 9/6574 (2006.01) C07H 19/213 (2006.01)
3577223	A61K 31/713 (2006.01) A61P 7/00 (2006.01) C12N 15/113 (2010.01)
3585790	A61K 31/519 (2006.01) A61P 25/28 (2006.01) C07D 487/04 (2006.01) C07D 519/00 (2006.01)
3585772	A61K 31/4184 (2006.01) C07D 235/08 (2006.01) C07D 401/10 (2006.01) C07D 403/10 (2006.01) C07D 413/10 (2006.01) C07D 417/10 (2006.01)
3585904	C12Q 1/48 (2006.01) C12Q 1/68 (2018.01) G01N 33/574 (2006.01)
3583123	A61P 25/28 (2006.01) C07K 16/18 (2006.01)
3589340	A61M 5/315 (2006.01)
3585373	A61K 31/185 (2006.01) A61K 31/381 (2006.01) A61K 31/404 (2006.01) A61K 31/415 (2006.01) A61K 31/4152 (2006.01) A61K 31/4168 (2006.01) A61K 31/4184 (2006.01) A61K 31/4196 (2006.01) A61K 31/42 (2006.01) A61K 31/423 (2006.01) A61K 31/426 (2006.01) A61K 31/428 (2006.01) A61K 31/433 (2006.01) A61K 31/44 (2006.01) A61K 31/4425 (2006.01) A61K 31/505 (2006.01) A61K 31/52 (2006.01) A61K 31/53 (2006.01) A61K 31/536 (2006.01) A61K 31/5377 (2006.01) A61P 25/28 (2006.01)
3589329	A61K 48/00 (2006.01) C07K 14/745 (2006.01) C07K 14/755 (2006.01) C12N 15/85 (2006.01) C12N 15/88 (2006.01)
3580183	B01F 3/04 (2006.01) C02F 3/20 (2006.01) C02F 3/22 (2006.01)

Broj objave evropske prijave patenta (97)	MKP (51)
3570840	A61K 9/00 (2006.01) A61K 31/47 (2006.01) A61K 45/06 (2006.01) A61P 35/00 (2006.01) A61P 35/04 (2006.01)
3589308	A61K 38/19 (2006.01) A61K 38/20 (2006.01) A61K 38/21 (2006.01) C07K 14/535 (2006.01) C07K 14/54 (2006.01) C07K 14/56 (2006.01) C12N 15/67 (2006.01)
3571226	A61K 39/00 (2006.01) A61P 19/08 (2006.01) C07K 16/22 (2006.01)
3592732	A61K 31/4152 (2006.01) A61P 35/00 (2006.01) C07D 231/14 (2006.01)
3585583	B29C 45/16 (2006.01) B29C 45/17 (2006.01) B29K 23/00 (2006.01) B29K 75/00 (2006.01) B29K 77/00 (2006.01) B29K 105/04 (2006.01) G10K 11/00 (2006.01)
3585584	B29C 45/16 (2006.01) B29C 45/17 (2006.01) B29C 45/26 (2006.01) B29K 23/00 (2006.01) B29K 75/00 (2006.01) B29K 77/00 (2006.01) B29K 105/04 (2006.01) B60R 13/08 (2006.01) F02B 77/11 (2006.01) G10K 11/00 (2006.01)
3579696	A01N 43/72 (2006.01) A01N 43/90 (2006.01) A01N 47/18 (2006.01) A01P 5/00 (2006.01)
3582854	A61K 31/7084 (2006.01) A61P 31/04 (2006.01) A61P 37/04 (2006.01) C07F 9/6527 (2006.01) C07F 9/6536 (2006.01) C07F 9/6574 (2006.01) C07H 19/213 (2006.01)
3582804	A61K 31/357 (2006.01) A61K 39/00 (2006.01) A61P 35/00 (2006.01)
3592750	A61K 31/542 (2006.01) A61P 25/28 (2006.01) C07D 498/04 (2006.01) C07D 513/04 (2006.01)

Broj objave evropske prijava patenta (97)	MKP (51)
3592751	A61K 31/542 (2006.01) A61P 25/28 (2006.01) C07D 513/04 (2006.01)
3592752	A61K 31/542 (2006.01) A61P 25/28 (2006.01) C07D 513/04 (2006.01)
3592734	A61K 31/426 (2006.01) A61P 9/00 (2006.01) C07D 277/56 (2006.01)
3582620	A22C 17/00 (2006.01) B02C 18/36 (2006.01)
3585926	C25B 1/06 (2006.01) C25B 9/06 (2006.01) C25B 15/02 (2006.01) C25B 15/08 (2006.01)
3585821	A61K 39/395 (2006.01) A61K 47/18 (2017.01) C07K 16/40 (2006.01)
3589328	A61K 47/65 (2017.01) A61K 47/68 (2017.01) A61P 35/00 (2006.01)
3585402	A61K 35/17 (2015.01)
3589951	A61K 39/00 (2006.01) G01N 33/50 (2006.01) G01N 33/569 (2006.01)
3589305	A61K 38/10 (2006.01) A61K 45/06 (2006.01)
3592867	C12Q 1/6886 (2018.01)
3558786	B61K 7/04 (2006.01) F16D 65/00 (2006.01) F16D 65/04 (2006.01)
3582814	A61K 9/20 (2006.01) A61K 31/404 (2006.01) A61K 45/06 (2006.01) A61P 1/00 (2006.01) A61P 1/04 (2006.01) A61P 17/00 (2006.01) A61P 17/02 (2006.01) A61P 37/00 (2006.01)
3585417	A61K 9/127 (2006.01) A61K 38/17 (2006.01) C07K 14/47 (2006.01) C12N 15/10 (2006.01)
3589274	A61K 9/16 (2006.01) A61K 9/20 (2006.01) A61K 9/28 (2006.01)

Broj objave evropske prijave patenta (97)	MKP (51)
	A61K 9/48 (2006.01) A61K 31/27 (2006.01)
3573600	A61K 9/107 (2006.01) A61K 38/10 (2006.01) A61K 38/17 (2006.01)
3592774	A61K 31/505 (2006.01) A61K 39/395 (2006.01) A61K 47/68 (2017.01) A61P 35/00 (2006.01) A61P 35/02 (2006.01) C07K 16/28 (2006.01) C07K 16/46 (2006.01)
3583230	C12N 15/10 (2006.01) C12Q 1/6806 (2018.01)
3585891	C12N 15/10 (2006.01)
3589730	A61K 35/76 (2015.01) A61K 48/00 (2006.01) C12N 7/00 (2006.01)
3592391	A61K 9/19 (2006.01) A61K 31/4965 (2006.01) A61K 47/10 (2017.01) A61P 9/12 (2006.01) A61P 17/02 (2006.01)
3585367	A61K 31/045 (2006.01) A61K 36/185 (2006.01) A61P 11/00 (2006.01)
3571227	A61P 35/00 (2006.01) C07K 16/22 (2006.01) C07K 16/28 (2006.01)
3571700	G16H 50/20 (2018.01) G16H 50/30 (2018.01) G16H 50/70 (2018.01)
3568412	A61K 39/00 (2006.01) C07K 14/725 (2006.01) C07K 16/30 (2006.01) C12N 5/16 (2006.01)
3592745	A61K 31/519 (2006.01) A61P 35/00 (2006.01) C07D 487/04 (2006.01)
3585892	C07H 1/06 (2006.01) C12N 15/10 (2006.01) C12P 19/34 (2006.01)
3592742	A61K 31/397 (2006.01) A61K 31/437 (2006.01) A61P 11/00 (2006.01) C07D 471/04 (2006.01)
3589618	A61K 31/415 (2006.01)

Broj objave evropske prijave patenta (97)	MKP (51)
	A61K 31/4155 (2006.01) C07D 231/14 (2006.01) C07D 401/12 (2006.01) C07D 401/14 (2006.01) C07D 403/12 (2006.01) C07D 403/14 (2006.01) C07D 405/12 (2006.01) C07D 405/14 (2006.01) C07D 413/12 (2006.01) C07D 417/12 (2006.01) C07D 471/04 (2006.01)
3592769	C07K 16/10 (2006.01) C07K 16/28 (2006.01)
3592743	A61K 31/437 (2006.01) A61P 11/00 (2006.01) C07D 471/04 (2006.01)
3592728	A61K 9/127 (2006.01) A61K 47/20 (2006.01) A61K 47/54 (2017.01) C07C 305/06 (2006.01) C07C 317/18 (2006.01) C08G 65/00 (2006.01)
3593403	G01N 35/00 (2006.01) G06K 19/077 (2006.01) H01Q 1/22 (2006.01) H01Q 7/00 (2006.01)
3589739	C12N 15/864 (2006.01)
3585886	C12N 9/12 (2006.01) C12P 19/34 (2006.01)
3570885	A61K 39/395 (2006.01) A61P 3/10 (2006.01) C07K 16/28 (2006.01)
3585482	A61N 5/10 (2006.01)
3582772	A61K 31/404 (2006.01) A61K 31/575 (2006.01) A61P 1/16 (2006.01)
3571321	C12Q 1/6883 (2018.01)
3576708	A61H 33/00 (2006.01) A61H 33/14 (2006.01) A61H 35/00 (2006.01)
3593075	F28D 1/04 (2006.01) F28F 1/16 (2006.01)
3581572	A61K 31/444 (2006.01) A61P 11/06 (2006.01) A61P 13/12 (2006.01) A61P 17/06 (2006.01) A61P 19/02 (2006.01) A61P 27/02 (2006.01) A61P 29/00 (2006.01)

Broj objave evropske prijava patenta (97)	MKP (51)
	A61P 35/00 (2006.01) C07D 417/14 (2006.01)
3582863	A63C 19/00 (2006.01) A63C 19/08 (2006.01)
3568707	G01R 1/04 (2006.01) G01R 11/04 (2006.01) G01R 11/24 (2006.01) G01R 22/06 (2006.01)
3589668	C08G 8/22 (2006.01) C08L 21/00 (2006.01) C08L 61/12 (2006.01) C08L 61/14 (2006.01) C08L 77/00 (2006.01) C09J 161/14 (2006.01)
3585166	A01K 87/04 (2006.01)
3582645	A41D 13/06 (2006.01) A43B 3/10 (2006.01)
3571221	A61K 39/00 (2006.01) C07K 14/47 (2006.01) C07K 14/705 (2006.01) C12N 5/0783 (2010.01)
3592878	C23C 2/00 (2006.01) C23C 2/02 (2006.01) C23C 2/04 (2006.01) C23C 2/06 (2006.01) C23C 2/26 (2006.01) C25D 17/06 (2006.01) C25D 17/08 (2006.01) F16B 45/00 (2006.01)
3566055	A61K 31/454 (2006.01) C07D 413/14 (2006.01) C07D 417/14 (2006.01) G01N 33/68 (2006.01)
3565551	A61K 31/407 (2006.01) A61K 31/69 (2006.01) A61P 13/02 (2006.01) A61P 13/12 (2006.01) A61P 31/04 (2006.01)
3582786	A61K 31/65 (2006.01) A61K 38/12 (2006.01) A61P 31/04 (2006.01)
3565560	A61K 31/58 (2006.01) A61K 31/69 (2006.01) A61K 39/395 (2006.01) C07J 43/00 (2006.01) C07K 16/28 (2006.01) C12Q 1/68 (2018.01)
3567162	E01F 9/30 (2016.01) E01F 15/02 (2006.01) G08B 1/08 (2006.01)

Broj objave evropske prijava patenta (97)	MKP (51)
3568199	A61N 5/00 (2006.01)
3569709	C07K 16/18 (2006.01) C12N 1/15 (2006.01) C12N 1/19 (2006.01) C12N 1/21 (2006.01) C12N 5/10 (2006.01) C12N 15/09 (2006.01) C12P 21/08 (2006.01) G01N 33/574 (2006.01)
3568471	A61P 35/00 (2006.01) C12N 5/09 (2010.01) C12N 15/02 (2006.01)
3571288	A61K 39/02 (2006.01) C12N 1/15 (2006.01) C12N 1/38 (2006.01) C12N 15/03 (2006.01)
3571230	A61K 47/68 (2017.01) C07K 16/28 (2006.01) C12N 5/00 (2006.01)
3570664	A01H 5/00 (2018.01) A01N 37/18 (2006.01) A01N 61/00 (2006.01)
3571163	C02F 1/44 (2006.01) C07D 301/32 (2006.01) G01N 33/00 (2006.01)
3570873	A61K 38/08 (2019.01) A61K 38/10 (2006.01) A61K 38/16 (2006.01) A61K 38/17 (2006.01) A61K 38/22 (2006.01) A61P 3/00 (2006.01) A61P 7/06 (2006.01) A61P 13/12 (2006.01)
3576377	H04L 29/08 (2006.01)
3575284	A61K 31/4439 (2006.01) A61K 31/496 (2006.01) A61P 13/12 (2006.01) A61P 37/06 (2006.01) A61P 37/08 (2006.01) C07D 207/16 (2006.01) C07D 401/10 (2006.01) C07D 403/10 (2006.01)
3573906	B65G 1/04 (2006.01) B65G 1/06 (2006.01)
3574081	C12N 1/00 (2006.01) C12N 1/21 (2006.01) C12N 9/00 (2006.01) C12N 9/04 (2006.01) C12N 15/52 (2006.01) C12N 15/63 (2006.01)

Broj objave evropske prijava patenta (97)	MKP (51)
	C12P 7/16 (2006.01)
3575948	G06F 3/06 (2006.01)
3573654	A61K 39/02 (2006.01) C07K 14/205 (2006.01) C12N 15/74 (2006.01)
3574966	A63F 13/822 (2014.01)
3576721	A61K 9/00 (2006.01) A61K 31/00 (2006.01)
3565818	C07D 487/22 (2006.01) G01N 21/64 (2006.01)
3578560	A61K 31/517 (2006.01) A61P 35/00 (2006.01) C07D 471/10 (2006.01)
3577122	C07F 5/04 (2006.01)
3577509	F41G 1/387 (2006.01) F41G 3/06 (2006.01) F41G 11/00 (2006.01) G02B 7/00 (2006.01) G02B 27/01 (2006.01)
3576768	A61K 38/00 (2006.01) A61K 38/43 (2006.01) A61K 48/00 (2006.01) A61P 25/00 (2006.01) A61P 25/28 (2006.01) C12N 15/09 (2006.01)
3577129	C07K 7/60 (2006.01)
3577221	A61K 48/00 (2006.01) C07H 19/02 (2006.01) C07H 21/00 (2006.01) C12N 15/11 (2006.01)
3577213	A61P 31/04 (2006.01) C12N 1/00 (2006.01) C12N 1/04 (2006.01) C12N 1/14 (2006.01) C12N 1/21 (2006.01)
3579876	A61K 39/395 (2006.01) C07K 16/28 (2006.01)
3582144	G06K 9/62 (2006.01)
3579835	A61K 31/395 (2006.01) A61K 31/4748 (2006.01) A61K 36/71 (2006.01) A61P 25/20 (2006.01) C07D 451/14 (2006.01) C07D 491/153 (2006.01)

Broj objave evropske prijava patenta (97)	MKP (51)
3580239	C07K 16/28 (2006.01)
3579731	A47J 43/046 (2006.01) A47J 43/07 (2006.01)
3582813	A61K 39/395 (2006.01) A61P 17/00 (2006.01) C07K 16/24 (2006.01)
3583131	C07K 16/28 (2006.01) C07K 16/32 (2006.01)
3582805	A61K 39/00 (2006.01) A61K 39/395 (2006.01) C07K 16/28 (2006.01) C07K 16/30 (2006.01) G01N 33/574 (2006.01)
3582773	A61K 31/415 (2006.01) A61P 13/12 (2006.01) A61P 17/06 (2006.01)
3585052	H04N 7/18 (2006.01)
3584768	G07C 5/08 (2006.01)
3582790	A61K 31/7105 (2006.01) A61K 39/12 (2006.01) A61P 31/14 (2006.01)
3583943	A61K 31/47 (2006.01) A61K 47/04 (2006.01) A61K 47/38 (2006.01) A61K 47/40 (2006.01) A61P 35/00 (2006.01)
3589658	C07K 16/28 (2006.01)
3585429	A61K 39/395 (2006.01) C07K 16/18 (2006.01)
3585405	A61K 31/573 (2006.01) A61K 35/74 (2015.01)
3585426	A61K 39/00 (2006.01) A61K 39/395 (2006.01) C07K 16/30 (2006.01)
3585431	A61K 39/395 (2006.01) A61P 35/00 (2006.01)
3585817	C07K 16/28 (2006.01) C07K 16/30 (2006.01) C07K 16/32 (2006.01) C07K 16/42 (2006.01) C07K 16/46 (2006.01) C07K 19/00 (2006.01)
3589285	A61K 31/4745 (2006.01) C07D 401/12 (2006.01)

Broj objave evropske prijava patenta (97)	MKP (51)
	C07D 471/04 (2006.01)
3589646	A61K 35/14 (2015.01) A61K 38/17 (2006.01) A61K 38/43 (2006.01) C07K 14/505 (2006.01) C07K 14/705 (2006.01) C07K 14/725 (2006.01) C07K 16/18 (2006.01) C07K 16/28 (2006.01) C07K 16/30 (2006.01) C07K 16/46 (2006.01)
3589952	A61K 39/44 (2006.01) A61K 51/10 (2006.01) B03C 1/005 (2006.01) C12N 15/13 (2006.01) G01N 33/50 (2006.01) G01N 33/574 (2006.01)
3590516	A61K 31/519 (2006.01) A61K 33/24 (2019.01) A61K 45/00 (2006.01) A61P 35/00 (2006.01) A61P 43/00 (2006.01) C07D 487/04 (2006.01)
3589627	C07D 401/12 (2006.01) C07D 471/04 (2006.01)
3589648	A61K 38/16 (2006.01) A61K 39/395 (2006.01) A61K 39/42 (2006.01) A61P 31/12 (2006.01) A61P 31/14 (2006.01) C07K 16/08 (2006.01) C07K 16/10 (2006.01)
3592362	A61K 31/546 (2006.01) A61K 31/69 (2006.01) A61P 31/04 (2006.01)
3592945	E21B 34/14 (2006.01) E21B 43/12 (2006.01) E21B 43/267 (2006.01)
3595307	H04N 19/146 (2014.01) H04N 19/147 (2014.01) H04N 19/159 (2014.01) H04N 19/176 (2014.01)
3592359	A61K 31/575 (2006.01) C07J 9/00 (2006.01)
3592946	E21B 34/06 (2006.01) E21B 43/12 (2006.01)
3579897	A61M 1/36 (2006.01) B01D 15/36 (2006.01)
3592522	B28B 13/02 (2006.01)

Broj objave evropske prijave patenta (97)	MKP (51)
3592373	A61K 38/00 (2006.01) A61K 48/00 (2006.01) C07K 14/78 (2006.01) C12N 15/12 (2006.01) C12N 15/85 (2006.01) G01N 33/53 (2006.01) G01N 33/68 (2006.01)
3559821	G06F 17/10 (2006.01) G10L 19/02 (2013.01) G10L 19/22 (2013.01) G10L 19/24 (2013.01) G10L 19/26 (2013.01)
3580429	E21D 11/10 (2006.01)
3560908	A01G 24/12 (2018.01) A01G 24/15 (2018.01) A01G 24/22 (2018.01) C05D 1/04 (2006.01) C05D 9/00 (2006.01) C05F 1/00 (2006.01) C05F 3/00 (2006.01) C05F 5/00 (2006.01) C05G 1/00 (2006.01) C05G 3/04 (2006.01) C09K 17/00 (2006.01) C09K 17/40 (2006.01)
3584383	B28B 11/00 (2006.01) B32B 3/08 (2006.01) B65G 47/00 (2006.01) E04C 1/40 (2006.01)
3498268	A61K 9/00 (2006.01) A61K 31/135 (2006.01) A61K 47/12 (2006.01) A61P 25/24 (2006.01)

Indeks klasifikacijskih oznaka zahtjeva za proširenje evropskih prijava patenta prema Međunarodnoj klasifikaciji patenata

Indeks klasifikacijskih oznaka zahtjeva za proširenje evropskih prijava patenta prema Međunarodnoj klasifikaciji patenata

MKP (51)	Broj objave evropske prijave patenta (97)	Naziv pronalaska (54)
B32B 5/14 (2006.01)	3559365	GYPSUM PLASTERBOARD
C04B 28/14 (2006.01)	3559365	GYPSUM PLASTERBOARD
E04C 2/04 (2006.01)	3559365	GYPSUM PLASTERBOARD
A61K 9/70 (2006.01)	3257504	POLYVINYLPIRROLIDONE FOR THE STABILIZATION OF A SOLID DISPERSION OF THE NON-CRYSTALLINE FORM OF ROTIGOTINE
A61K 31/381 (2006.01)	3257504	POLYVINYLPIRROLIDONE FOR THE STABILIZATION OF A SOLID DISPERSION OF THE NON-CRYSTALLINE FORM OF ROTIGOTINE
B01J 8/10 (2006.01)	3441136	DEVICE FOR CRUSHING AND MIXING, SYSTEM AND METHOD FOR CATALYTIC PRESSURELESS OILING
B01J 8/22 (2006.01)	3441136	DEVICE FOR CRUSHING AND MIXING, SYSTEM AND METHOD FOR CATALYTIC PRESSURELESS OILING
B01J 8/38 (2006.01)	3441136	DEVICE FOR CRUSHING AND MIXING, SYSTEM AND METHOD FOR CATALYTIC PRESSURELESS OILING
B01J 19/18 (2006.01)	3441136	DEVICE FOR CRUSHING AND MIXING, SYSTEM AND METHOD FOR CATALYTIC PRESSURELESS OILING
C10L 1/08 (2006.01)	3441136	DEVICE FOR CRUSHING AND MIXING, SYSTEM AND METHOD FOR CATALYTIC PRESSURELESS OILING
F04C 7/00 (2006.01)	3441136	DEVICE FOR CRUSHING AND MIXING, SYSTEM AND METHOD FOR CATALYTIC PRESSURELESS OILING
F04C 19/00 (2006.01)	3441136	DEVICE FOR CRUSHING AND MIXING, SYSTEM AND METHOD FOR CATALYTIC PRESSURELESS OILING
G06F 8/35 (2018.01)	3486766	COMPUTER-IMPLEMENTED METHOD OF AUGMENTING A SIMULATION MODEL OF A PHYSICAL ENVIRONMENT OF A VEHICLE
G06F 11/36 (2006.01)	3486766	COMPUTER-IMPLEMENTED METHOD OF AUGMENTING A SIMULATION MODEL OF A PHYSICAL ENVIRONMENT OF A VEHICLE
G06F 17/50 (2006.01)	3486766	COMPUTER-IMPLEMENTED METHOD OF AUGMENTING A SIMULATION MODEL OF A PHYSICAL ENVIRONMENT OF A VEHICLE
G06Q 30/08 (2012.01)	3486766	COMPUTER-IMPLEMENTED METHOD OF AUGMENTING A SIMULATION MODEL OF A PHYSICAL ENVIRONMENT OF A VEHICLE
G01N 33/558 (2006.01)	3489686	METHOD AND DEVICE FOR DISCRIMINATING BETWEEN VIRAL AND BACTERIAL INFECTIONS
G01N 33/569 (2006.01)	3489686	METHOD AND DEVICE FOR DISCRIMINATING BETWEEN VIRAL AND BACTERIAL INFECTIONS
B29C 65/48 (2006.01)	3489003	METHOD OF MANUFACTURE OF AN INFLATABLE PRODUCT WITH AN ATTACHABLE FOAM FINISH
B29D 22/02 (2006.01)	3489003	METHOD OF MANUFACTURE OF AN INFLATABLE PRODUCT WITH AN ATTACHABLE FOAM FINISH
B29K 105/04 (2006.01)	3489003	METHOD OF MANUFACTURE OF AN INFLATABLE PRODUCT WITH AN ATTACHABLE FOAM FINISH
B63B 7/08 (2006.01)	3489003	METHOD OF MANUFACTURE OF AN INFLATABLE PRODUCT WITH AN ATTACHABLE FOAM FINISH
B63C 1/02 (2006.01)	3489003	METHOD OF MANUFACTURE OF AN INFLATABLE PRODUCT WITH AN ATTACHABLE FOAM FINISH
A61K 8/04 (2006.01)	3492143	LOW VISCOSITY DENTAL CARE COMPOSITION
A61K 8/73 (2006.01)	3492143	LOW VISCOSITY DENTAL CARE COMPOSITION
A61Q 11/00 (2006.01)	3492143	LOW VISCOSITY DENTAL CARE COMPOSITION
A61K 31/58 (2006.01)	3558376	A THERAPEUTIC COMBINATION COMPRISING A PULMONARY SURFACTANT AND A STEROID FOR THE TREATMENT OF EVOLVING BPD
A61K 35/00 (2006.01)	3558376	A THERAPEUTIC COMBINATION COMPRISING A PULMONARY SURFACTANT AND A STEROID FOR THE TREATMENT OF

MKP (51)	Broj objave evropske prijave patenta (97)	Naziv pronalaska (54)
A61K 45/06 (2006.01)	3558376	EVOLVING BPD A THERAPEUTIC COMBINATION COMPRISING A PULMONARY SURFACTANT AND A STEROID FOR THE TREATMENT OF EVOLVING BPD
A61K 47/65 (2017.01)	3558388	ANTIBODY DRUG CONJUGATES (ADCS) HAVING ENZYMATICALLY CLEAVABLE GROUPS
A61P 35/00 (2006.01)	3558388	ANTIBODY DRUG CONJUGATES (ADCS) HAVING ENZYMATICALLY CLEAVABLE GROUPS
C07K 14/195 (2006.01)	3559022	VIRULENCE ATTENUATED BACTERIA BASED PROTEIN DELIVERY
C07K 14/52 (2006.01)	3559022	VIRULENCE ATTENUATED BACTERIA BASED PROTEIN DELIVERY
C12N 15/70 (2006.01)	3559022	VIRULENCE ATTENUATED BACTERIA BASED PROTEIN DELIVERY
C12N 15/74 (2006.01)	3559022	VIRULENCE ATTENUATED BACTERIA BASED PROTEIN DELIVERY
A61K 31/4439 (2006.01)	3558973	PYRIDINE DERIVATIVES AS IMMUNOMODULATORS
A61K 31/444 (2006.01)	3558973	PYRIDINE DERIVATIVES AS IMMUNOMODULATORS
A61P 37/00 (2006.01)	3558973	PYRIDINE DERIVATIVES AS IMMUNOMODULATORS
C07D 213/81 (2006.01)	3558973	PYRIDINE DERIVATIVES AS IMMUNOMODULATORS
C07D 401/12 (2006.01)	3558973	PYRIDINE DERIVATIVES AS IMMUNOMODULATORS
C07D 401/14 (2006.01)	3558973	PYRIDINE DERIVATIVES AS IMMUNOMODULATORS
C07D 413/14 (2006.01)	3558973	PYRIDINE DERIVATIVES AS IMMUNOMODULATORS
C07D 513/04 (2006.01)	3558973	PYRIDINE DERIVATIVES AS IMMUNOMODULATORS
A61P 35/00 (2006.01)	3559040	BINDING MOLECULES FOR THE TREATMENT OF CANCER
C07K 16/28 (2006.01)	3559040	BINDING MOLECULES FOR THE TREATMENT OF CANCER
A61K 39/12 (2006.01)	3551224	ADENOVIRUS POLYNUCLEOTIDES AND POLYPEPTIDES
A61K 39/235 (2006.01)	3551224	ADENOVIRUS POLYNUCLEOTIDES AND POLYPEPTIDES
C07K 14/075 (2006.01)	3551224	ADENOVIRUS POLYNUCLEOTIDES AND POLYPEPTIDES
C12N 15/861 (2006.01)	3551224	ADENOVIRUS POLYNUCLEOTIDES AND POLYPEPTIDES
F16K 1/12 (2006.01)	3563208	AXIAL GAS PRESSURE REGULATOR
G05D 16/06 (2006.01)	3563208	AXIAL GAS PRESSURE REGULATOR
G05D 16/16 (2006.01)	3563208	AXIAL GAS PRESSURE REGULATOR
A61K 31/423 (2006.01)	3558985	BENZOOXAZOLE DERIVATIVES AS IMMUNOMODULATORS
A61P 37/00 (2006.01)	3558985	BENZOOXAZOLE DERIVATIVES AS IMMUNOMODULATORS
C07D 413/06 (2006.01)	3558985	BENZOOXAZOLE DERIVATIVES AS IMMUNOMODULATORS
C07D 413/12 (2006.01)	3558985	BENZOOXAZOLE DERIVATIVES AS IMMUNOMODULATORS
C07D 413/14 (2006.01)	3558985	BENZOOXAZOLE DERIVATIVES AS IMMUNOMODULATORS
C07D 471/04 (2006.01)	3558985	BENZOOXAZOLE DERIVATIVES AS IMMUNOMODULATORS
C07D 487/04 (2006.01)	3558985	BENZOOXAZOLE DERIVATIVES AS IMMUNOMODULATORS
C07D 498/04 (2006.01)	3558985	BENZOOXAZOLE DERIVATIVES AS IMMUNOMODULATORS
C07D 513/04 (2006.01)	3558985	BENZOOXAZOLE DERIVATIVES AS IMMUNOMODULATORS
A61K 39/09 (2006.01)	3562503	POLYPEPTIDE-ANTIGEN CONJUGATES WITH NON-NATURAL AMINO ACIDS
A61K 47/64 (2017.01)	3562503	POLYPEPTIDE-ANTIGEN CONJUGATES WITH NON-NATURAL AMINO ACIDS
A61P 31/04 (2006.01)	3562503	POLYPEPTIDE-ANTIGEN CONJUGATES WITH NON-NATURAL AMINO ACIDS
B60K 6/48 (2007.01)	3551489	APPARATUS FOR SELECTIVELY SHARING THE POWER OF A MULTIDRIVE UNIT VEHICLE
A61K 31/4439 (2006.01)	3558969	PYRAZOLE DERIVATIVES AS MALT1 INHIBITORS
A61K 31/444 (2006.01)	3558969	PYRAZOLE DERIVATIVES AS MALT1 INHIBITORS
A61K 31/4725 (2006.01)	3558969	PYRAZOLE DERIVATIVES AS MALT1 INHIBITORS
A61K 31/538 (2006.01)	3558969	PYRAZOLE DERIVATIVES AS MALT1 INHIBITORS
A61P 35/00 (2006.01)	3558969	PYRAZOLE DERIVATIVES AS MALT1 INHIBITORS
C07D 401/12 (2006.01)	3558969	PYRAZOLE DERIVATIVES AS MALT1 INHIBITORS
C07D 401/14 (2006.01)	3558969	PYRAZOLE DERIVATIVES AS MALT1 INHIBITORS
C07D 405/14 (2006.01)	3558969	PYRAZOLE DERIVATIVES AS MALT1 INHIBITORS
C07D 413/14 (2006.01)	3558969	PYRAZOLE DERIVATIVES AS MALT1 INHIBITORS
C07D 417/14 (2006.01)	3558969	PYRAZOLE DERIVATIVES AS MALT1 INHIBITORS
C07D 471/04 (2006.01)	3558969	PYRAZOLE DERIVATIVES AS MALT1 INHIBITORS
C07D 487/04 (2006.01)	3558969	PYRAZOLE DERIVATIVES AS MALT1 INHIBITORS
C07D 491/04 (2006.01)	3558969	PYRAZOLE DERIVATIVES AS MALT1 INHIBITORS
C07D 495/04 (2006.01)	3558969	PYRAZOLE DERIVATIVES AS MALT1 INHIBITORS
A23L 33/105 (2016.01)	3453381	METHOD AND USE OF A COMPOSITION FOR IMPROVING HAIR APPEARANCE
A23L 33/15 (2016.01)	3453381	METHOD AND USE OF A COMPOSITION FOR IMPROVING HAIR APPEARANCE
A23L 33/175 (2016.01)	3453381	METHOD AND USE OF A COMPOSITION FOR IMPROVING HAIR APPEARANCE
A61K 8/97 (2017.01)	3453381	METHOD AND USE OF A COMPOSITION FOR IMPROVING HAIR APPEARANCE

MKP	Broj objave evropske prijave patenta (97)	Naziv pronalaska (54)
(51)		
A61K 9/48 (2006.01)	3453381	METHOD AND USE OF A COMPOSITION FOR IMPROVING HAIR APPEARANCE
A61K 31/197 (2006.01)	3453381	METHOD AND USE OF A COMPOSITION FOR IMPROVING HAIR APPEARANCE
A61K 31/4188 (2006.01)	3453381	METHOD AND USE OF A COMPOSITION FOR IMPROVING HAIR APPEARANCE
A61K 47/18 (2017.01)	3453381	METHOD AND USE OF A COMPOSITION FOR IMPROVING HAIR APPEARANCE
C07K 16/24 (2006.01)	3456736	ANTIBODY VARIANTS
C07K 16/24 (2006.01)	3456737	ANTIBODY VARIANTS
C07K 16/24 (2006.01)	3456738	ANTIBODY VARIANTS
A61K 9/16 (2006.01)	3459527	METHOD FOR PREPARING A SOLID DOSAGE FORM COMPRISING ANTIBODIES BY WET GRANULATION, EXTRUSION AND SPHERONIZATION
A61K 39/00 (2006.01)	3459527	METHOD FOR PREPARING A SOLID DOSAGE FORM COMPRISING ANTIBODIES BY WET GRANULATION, EXTRUSION AND SPHERONIZATION
A61K 9/16 (2006.01)	3459528	PREPARATION OF SOLID DOSAGE FORMS COMPRISING ANTIBODIES BY SOLUTION/SUSPENSION LAYERING
A61K 39/00 (2006.01)	3459528	PREPARATION OF SOLID DOSAGE FORMS COMPRISING ANTIBODIES BY SOLUTION/SUSPENSION LAYERING
A61K 9/16 (2006.01)	3459529	PREPARATION OF SUSTAINED RELEASE SOLID DOSAGE FORMS COMPRISING ANTIBODIES BY SPRAY DRYING
A61K 39/00 (2006.01)	3459529	PREPARATION OF SUSTAINED RELEASE SOLID DOSAGE FORMS COMPRISING ANTIBODIES BY SPRAY DRYING
C07K 16/24 (2006.01)	3459529	PREPARATION OF SUSTAINED RELEASE SOLID DOSAGE FORMS COMPRISING ANTIBODIES BY SPRAY DRYING
G01N 15/02 (2006.01)	3580550	IMAGING SYSTEM FOR COUNTING AND SIZING PARTICLES IN FLUID-FILLED VESSELS
G01N 15/14 (2006.01)	3580550	IMAGING SYSTEM FOR COUNTING AND SIZING PARTICLES IN FLUID-FILLED VESSELS
G01N 21/47 (2006.01)	3580550	IMAGING SYSTEM FOR COUNTING AND SIZING PARTICLES IN FLUID-FILLED VESSELS
G01N 21/51 (2006.01)	3580550	IMAGING SYSTEM FOR COUNTING AND SIZING PARTICLES IN FLUID-FILLED VESSELS
G01N 35/00 (2006.01)	3580550	IMAGING SYSTEM FOR COUNTING AND SIZING PARTICLES IN FLUID-FILLED VESSELS
G01N 35/04 (2006.01)	3580550	IMAGING SYSTEM FOR COUNTING AND SIZING PARTICLES IN FLUID-FILLED VESSELS
G01N 33/52 (2006.01)	3552018	DIAGNOSTIC TESTING ASSAYS AND RELATED DEVICES WITH SECURITY AND METHODS OF USE THEREOF
G01N 33/543 (2006.01)	3552018	DIAGNOSTIC TESTING ASSAYS AND RELATED DEVICES WITH SECURITY AND METHODS OF USE THEREOF
G01N 33/558 (2006.01)	3552018	DIAGNOSTIC TESTING ASSAYS AND RELATED DEVICES WITH SECURITY AND METHODS OF USE THEREOF
A61K 38/46 (2006.01)	3449933	THERAPEUTIC NUCLEASE COMPOSITIONS AND METHODS
A61K 47/68 (2017.01)	3449933	THERAPEUTIC NUCLEASE COMPOSITIONS AND METHODS
C07K 16/44 (2006.01)	3449933	THERAPEUTIC NUCLEASE COMPOSITIONS AND METHODS
C07K 16/46 (2006.01)	3449933	THERAPEUTIC NUCLEASE COMPOSITIONS AND METHODS
C07K 19/00 (2006.01)	3449933	THERAPEUTIC NUCLEASE COMPOSITIONS AND METHODS
C12N 9/22 (2006.01)	3449933	THERAPEUTIC NUCLEASE COMPOSITIONS AND METHODS
C12N 15/55 (2006.01)	3449933	THERAPEUTIC NUCLEASE COMPOSITIONS AND METHODS
C12N 15/62 (2006.01)	3449933	THERAPEUTIC NUCLEASE COMPOSITIONS AND METHODS
F41A 27/08 (2006.01)	3569967	CARDAN MOUNT
F41A 27/10 (2006.01)	3569967	CARDAN MOUNT
A61K 39/395 (2006.01)	3250597	VEGFA/ANG2 COMPOUNDS
A61P 27/02 (2006.01)	3250597	VEGFA/ANG2 COMPOUNDS
A61P 35/00 (2006.01)	3250597	VEGFA/ANG2 COMPOUNDS
C07K 16/22 (2006.01)	3250597	VEGFA/ANG2 COMPOUNDS
C07K 16/00 (2006.01)	3247721	IgG BISPECIFIC ANTIBODIES AND PROCESSES FOR PREPARATION
C07K 16/28 (2006.01)	3247721	IgG BISPECIFIC ANTIBODIES AND PROCESSES FOR PREPARATION
C07K 16/32 (2006.01)	3247721	IgG BISPECIFIC ANTIBODIES AND PROCESSES FOR PREPARATION
A61M 5/20 (2006.01)	3573687	DOSE CONTROL SYSTEM FOR INJECTABLE-DRUG DELIVERY DEVICES AND ASSOCIATED METHODS OF USE
A61M 5/315 (2006.01)	3573687	DOSE CONTROL SYSTEM FOR INJECTABLE-DRUG DELIVERY

MKP (51)	Broj objave evropske prijave patenta (97)	Naziv pronalaska (54)
A47J 47/00 (2006.01)	3552529	DEVICES AND ASSOCIATED METHODS OF USE AN INNOVATIVE CHOPPING BOARD EQUIPPED WITH A PROTECTIVE EDGE
B66F 7/06 (2006.01)	3573919	IMPROVED INDUSTRIAL TRUCK
B66F 9/06 (2006.01)	3573919	IMPROVED INDUSTRIAL TRUCK
B66F 9/075 (2006.01)	3573919	IMPROVED INDUSTRIAL TRUCK
F16M 11/04 (2006.01)	3566000	DEVICE FOR SNAP-FIT FASTENING OF AN ACCESSORY ON A WALL
F16M 13/02 (2006.01)	3566000	DEVICE FOR SNAP-FIT FASTENING OF AN ACCESSORY ON A WALL
A61K 31/337 (2006.01)	3565547	COMBINATION OF A MCL-1 INHIBITOR AND A TAXANE COMPOUND, USES AND PHARMACEUTICAL COMPOSITIONS THEREOF
A61K 31/519 (2006.01)	3565547	COMBINATION OF A MCL-1 INHIBITOR AND A TAXANE COMPOUND, USES AND PHARMACEUTICAL COMPOSITIONS THEREOF
A61K 45/06 (2006.01)	3565547	COMBINATION OF A MCL-1 INHIBITOR AND A TAXANE COMPOUND, USES AND PHARMACEUTICAL COMPOSITIONS THEREOF
A61P 35/00 (2006.01)	3565547	COMBINATION OF A MCL-1 INHIBITOR AND A TAXANE COMPOUND, USES AND PHARMACEUTICAL COMPOSITIONS THEREOF
A61K 31/255 (2006.01)	3565545	IL-8 INHIBITORS FOR USE IN THE TREATMENT OF SOME UROLOGICAL DISORDERS
A61K 31/421 (2006.01)	3565545	IL-8 INHIBITORS FOR USE IN THE TREATMENT OF SOME UROLOGICAL DISORDERS
A61K 31/427 (2006.01)	3565545	IL-8 INHIBITORS FOR USE IN THE TREATMENT OF SOME UROLOGICAL DISORDERS
A61P 13/08 (2006.01)	3565545	IL-8 INHIBITORS FOR USE IN THE TREATMENT OF SOME UROLOGICAL DISORDERS
G06F 3/03 (2006.01)	3568780	METHOD OF KITCHEN PLANNING
G06F 17/50 (2006.01)	3568780	METHOD OF KITCHEN PLANNING
A61K 31/506 (2006.01)	3571192	JAK1 SELECTIVE INHIBITORS
A61P 17/14 (2006.01)	3571192	JAK1 SELECTIVE INHIBITORS
A61P 37/00 (2006.01)	3571192	JAK1 SELECTIVE INHIBITORS
C07D 403/04 (2006.01)	3571192	JAK1 SELECTIVE INHIBITORS
C07D 403/14 (2006.01)	3571192	JAK1 SELECTIVE INHIBITORS
A61K 35/12 (2015.01)	3571296	ENGINEERED CELLS FOR INDUCING TOLERANCE
A61K 35/15 (2015.01)	3571296	ENGINEERED CELLS FOR INDUCING TOLERANCE
A61K 35/28 (2015.01)	3571296	ENGINEERED CELLS FOR INDUCING TOLERANCE
A61K 48/00 (2006.01)	3571296	ENGINEERED CELLS FOR INDUCING TOLERANCE
C07K 14/435 (2006.01)	3571296	ENGINEERED CELLS FOR INDUCING TOLERANCE
C12N 5/0775 (2010.01)	3571296	ENGINEERED CELLS FOR INDUCING TOLERANCE
C12N 5/0786 (2010.01)	3571296	ENGINEERED CELLS FOR INDUCING TOLERANCE
A61L 2/07 (2006.01)	3576797	STERILIZING APPARATUS FOR THE STERILIZATION OF POST- CONSUMER ABSORBENT SANITARY PRODUCTS
A61L 11/00 (2006.01)	3576797	STERILIZING APPARATUS FOR THE STERILIZATION OF POST- CONSUMER ABSORBENT SANITARY PRODUCTS
B25B 27/30 (2006.01)	3568264	TENSIONING DEVICE FOR TENSIONING A HELICAL SPRING
E05D 13/00 (2006.01)	3568264	TENSIONING DEVICE FOR TENSIONING A HELICAL SPRING
A61K 31/437 (2006.01)	3577112	ARYL HYDROCARBON RECEPTOR (AHR) MODULATOR COMPOUNDS
A61P 35/00 (2006.01)	3577112	ARYL HYDROCARBON RECEPTOR (AHR) MODULATOR COMPOUNDS
C07D 471/04 (2006.01)	3577112	ARYL HYDROCARBON RECEPTOR (AHR) MODULATOR COMPOUNDS
A61K 39/00 (2006.01)	3565835	HUMAN ANTIBODIES TO S.AUREUS HEMOLYSIN A TOXIN
A61P 31/04 (2006.01)	3565835	HUMAN ANTIBODIES TO S.AUREUS HEMOLYSIN A TOXIN
C07K 16/12 (2006.01)	3565835	HUMAN ANTIBODIES TO S.AUREUS HEMOLYSIN A TOXIN
A61K 9/00 (2006.01)	3565526	TOPICAL DETOMIDINE FORMULATIONS
A61K 31/00 (2006.01)	3565526	TOPICAL DETOMIDINE FORMULATIONS
A61K 47/10 (2017.01)	3565526	TOPICAL DETOMIDINE FORMULATIONS
A61K 47/32 (2006.01)	3565526	TOPICAL DETOMIDINE FORMULATIONS
A61K 47/38 (2006.01)	3565526	TOPICAL DETOMIDINE FORMULATIONS
A61K 39/00 (2006.01)	3568698	DIAGNOSTIC
C07K 14/35 (2006.01)	3568698	DIAGNOSTIC
C07K 16/12 (2006.01)	3568698	DIAGNOSTIC
G01N 33/569 (2006.01)	3568698	DIAGNOSTIC

MKP	Broj objave evropske prijave patenta	Naziv pronalaska
(51)	(97)	(54)
A61K 31/4725 (2006.01)	3565811	INHIBITORS OF NHE-MEDIATED ANTIPORT
A61P 1/10 (2006.01)	3565811	INHIBITORS OF NHE-MEDIATED ANTIPORT
A61P 9/12 (2006.01)	3565811	INHIBITORS OF NHE-MEDIATED ANTIPORT
C07D 401/12 (2006.01)	3565811	INHIBITORS OF NHE-MEDIATED ANTIPORT
C07D 401/14 (2006.01)	3565811	INHIBITORS OF NHE-MEDIATED ANTIPORT
A61K 31/437 (2006.01)	3568135	BICYCLIC INHIBITORS OF HISTONE DEACETYLASE
A61K 31/4439 (2006.01)	3568135	BICYCLIC INHIBITORS OF HISTONE DEACETYLASE
A61K 31/519 (2006.01)	3568135	BICYCLIC INHIBITORS OF HISTONE DEACETYLASE
A61P 25/28 (2006.01)	3568135	BICYCLIC INHIBITORS OF HISTONE DEACETYLASE
B60L 5/42 (2006.01)	3568313	CONTACT UNIT FOR A CHARGING STATION, AND METHOD FOR MAKING CONTACT
B60L 11/18 (2006.01)	3568313	CONTACT UNIT FOR A CHARGING STATION, AND METHOD FOR MAKING CONTACT
A61K 31/498 (2006.01)	3576740	CANCER TREATMENT
A61P 35/00 (2006.01)	3576740	CANCER TREATMENT
G01N 33/574 (2006.01)	3576740	CANCER TREATMENT
A61K 31/01 (2006.01)	3570823	USE OF CAROTENOID DERIVATIVES TO REDUCE THE TOXICITY AND INCREASE THE EFFICACY OF ANTI-EGFR ANTITUMOR TREATMENTS
A61K 31/4745 (2006.01)	3570823	USE OF CAROTENOID DERIVATIVES TO REDUCE THE TOXICITY AND INCREASE THE EFFICACY OF ANTI-EGFR ANTITUMOR TREATMENTS
A61K 31/513 (2006.01)	3570823	USE OF CAROTENOID DERIVATIVES TO REDUCE THE TOXICITY AND INCREASE THE EFFICACY OF ANTI-EGFR ANTITUMOR TREATMENTS
A61K 31/555 (2006.01)	3570823	USE OF CAROTENOID DERIVATIVES TO REDUCE THE TOXICITY AND INCREASE THE EFFICACY OF ANTI-EGFR ANTITUMOR TREATMENTS
A61K 45/06 (2006.01)	3570823	USE OF CAROTENOID DERIVATIVES TO REDUCE THE TOXICITY AND INCREASE THE EFFICACY OF ANTI-EGFR ANTITUMOR TREATMENTS
A61P 35/00 (2006.01)	3570823	USE OF CAROTENOID DERIVATIVES TO REDUCE THE TOXICITY AND INCREASE THE EFFICACY OF ANTI-EGFR ANTITUMOR TREATMENTS
B29C 49/06 (2006.01)	3571036	IMPROVED MACHINE FOR THE PRODUCTION OF CONTAINERS AND CHECKING METHOD
B29C 49/36 (2006.01)	3571036	IMPROVED MACHINE FOR THE PRODUCTION OF CONTAINERS AND CHECKING METHOD
B29C 49/42 (2006.01)	3571036	IMPROVED MACHINE FOR THE PRODUCTION OF CONTAINERS AND CHECKING METHOD
B29C 49/80 (2006.01)	3571036	IMPROVED MACHINE FOR THE PRODUCTION OF CONTAINERS AND CHECKING METHOD
A61K 38/17 (2006.01)	3573716	BIOLOGICALLY ACTIVE FUSION PEPTIDE FOR USE IN THE TREATMENT OF SPINAL MUSCULAR ATROPHY (SMA)
A61P 21/00 (2006.01)	3573716	BIOLOGICALLY ACTIVE FUSION PEPTIDE FOR USE IN THE TREATMENT OF SPINAL MUSCULAR ATROPHY (SMA)
A61K 35/17 (2015.01)	3565888	EXPANSION OF TUMOR INFILTRATING LYMPHOCYTES (TILS) WITH TUMOR NECROSIS FACTOR RECEPTOR SUPERFAMILY (TNFRSF) AGONISTS AND THERAPEUTIC COMBINATIONS OF TILS AND TNFRSF AGONISTS
C12N 5/078 (2010.01)	3565888	EXPANSION OF TUMOR INFILTRATING LYMPHOCYTES (TILS) WITH TUMOR NECROSIS FACTOR RECEPTOR SUPERFAMILY (TNFRSF) AGONISTS AND THERAPEUTIC COMBINATIONS OF TILS AND TNFRSF AGONISTS
C12N 5/0783 (2010.01)	3565888	EXPANSION OF TUMOR INFILTRATING LYMPHOCYTES (TILS) WITH TUMOR NECROSIS FACTOR RECEPTOR SUPERFAMILY (TNFRSF) AGONISTS AND THERAPEUTIC COMBINATIONS OF TILS AND TNFRSF AGONISTS
A61P 25/28 (2006.01)	3565836	ANTIBODIES SPECIFIC FOR HYPERPHOSPHORYLATED TAU FOR THE TREATMENT OF OCULAR DISEASES
C07K 16/18 (2006.01)	3565836	ANTIBODIES SPECIFIC FOR HYPERPHOSPHORYLATED TAU FOR THE TREATMENT OF OCULAR DISEASES
G01N 33/68 (2006.01)	3565836	ANTIBODIES SPECIFIC FOR HYPERPHOSPHORYLATED TAU FOR THE TREATMENT OF OCULAR DISEASES
A61K 39/395 (2006.01)	3570882	NOVEL STABLE FORMULATION FOR FXIA ANTIBODIES
A61P 7/02 (2006.01)	3570882	NOVEL STABLE FORMULATION FOR FXIA ANTIBODIES
C07K 16/36 (2006.01)	3570882	NOVEL STABLE FORMULATION FOR FXIA ANTIBODIES
A61K 39/00 (2006.01)	3573647	NOVEL PEPTIDES AND COMBINATION OF PEPTIDES FOR USE IN

MKP	Broj objave evropske prijave patenta (97)	Naziv pronalaska (54)
(51)		
C07K 7/06 (2006.01)	3573647	IMMUNOTHERAPY AGAINST OVARIAN CANCER AND OTHER CANCERS
C07K 7/08 (2006.01)	3573647	NOVEL PEPTIDES AND COMBINATION OF PEPTIDES FOR USE IN IMMUNOTHERAPY AGAINST OVARIAN CANCER AND OTHER CANCERS
C07K 14/47 (2006.01)	3573647	NOVEL PEPTIDES AND COMBINATION OF PEPTIDES FOR USE IN IMMUNOTHERAPY AGAINST OVARIAN CANCER AND OTHER CANCERS
C07K 14/705 (2006.01)	3573647	NOVEL PEPTIDES AND COMBINATION OF PEPTIDES FOR USE IN IMMUNOTHERAPY AGAINST OVARIAN CANCER AND OTHER CANCERS
A61K 31/437 (2006.01)	3570834	BICYCLIC INHIBITORS OF HISTONE DEACETYLASE
A61K 31/519 (2006.01)	3570834	BICYCLIC INHIBITORS OF HISTONE DEACETYLASE
A61P 25/28 (2006.01)	3570834	BICYCLIC INHIBITORS OF HISTONE DEACETYLASE
A61K 31/4545 (2006.01)	3570839	SOLID DISPERSIONS OF (R)-N-((4-METHOXY-6-METHYL-2-OXO-1,2-DIHYDROPYRIDIN-3-YL)METHYL)-2-METHYL-1-(1-(1-(2,2,2-TRIFLUOROETHYL)PIPERIDIN-4-YL)ETHYL)-1H-INDOLE-3-CARBOXAMIDE
A61P 35/00 (2006.01)	3570839	SOLID DISPERSIONS OF (R)-N-((4-METHOXY-6-METHYL-2-OXO-1,2-DIHYDROPYRIDIN-3-YL)METHYL)-2-METHYL-1-(1-(1-(2,2,2-TRIFLUOROETHYL)PIPERIDIN-4-YL)ETHYL)-1H-INDOLE-3-CARBOXAMIDE
A61K 8/00 (2006.01)	3568146	VEGETABLE EXTRACT TO PREVENT AND TREAT HAIR LOSS
A61K 9/00 (2006.01)	3568146	VEGETABLE EXTRACT TO PREVENT AND TREAT HAIR LOSS
A61K 36/53 (2006.01)	3568146	VEGETABLE EXTRACT TO PREVENT AND TREAT HAIR LOSS
A61P 17/14 (2006.01)	3568146	VEGETABLE EXTRACT TO PREVENT AND TREAT HAIR LOSS
C07K 14/64 (2006.01)	3574004	RELAXIN FUSION POLYPEPTIDES AND USES THEREOF
A61J 1/14 (2006.01)	3582825	DRUG DELIVERY DEVICE WITH STERILE FLUID FLOWPATH AND RELATED METHOD OF ASSEMBLY
A61J 1/20 (2006.01)	3582825	DRUG DELIVERY DEVICE WITH STERILE FLUID FLOWPATH AND RELATED METHOD OF ASSEMBLY
A61M 5/145 (2006.01)	3582825	DRUG DELIVERY DEVICE WITH STERILE FLUID FLOWPATH AND RELATED METHOD OF ASSEMBLY
A61M 5/28 (2006.01)	3582825	DRUG DELIVERY DEVICE WITH STERILE FLUID FLOWPATH AND RELATED METHOD OF ASSEMBLY
A61K 31/445 (2006.01)	3573983	N-[4-FLUORO-5-[[[(2S,4S)-2-METHYL-4-[(5-METHYL-1,2,4-OXADIAZOL-3-YL)METHOXY]-1-PIPERIDYL]METHYL]THIAZOL-2-YL]ACETAMIDE AS OGA INHIBITOR
A61P 25/00 (2006.01)	3573983	N-[4-FLUORO-5-[[[(2S,4S)-2-METHYL-4-[(5-METHYL-1,2,4-OXADIAZOL-3-YL)METHOXY]-1-PIPERIDYL]METHYL]THIAZOL-2-YL]ACETAMIDE AS OGA INHIBITOR
A61P 25/28 (2006.01)	3573983	N-[4-FLUORO-5-[[[(2S,4S)-2-METHYL-4-[(5-METHYL-1,2,4-OXADIAZOL-3-YL)METHOXY]-1-PIPERIDYL]METHYL]THIAZOL-2-YL]ACETAMIDE AS OGA INHIBITOR
C07D 417/14 (2006.01)	3573983	N-[4-FLUORO-5-[[[(2S,4S)-2-METHYL-4-[(5-METHYL-1,2,4-OXADIAZOL-3-YL)METHOXY]-1-PIPERIDYL]METHYL]THIAZOL-2-YL]ACETAMIDE AS OGA INHIBITOR
A61K 31/496 (2006.01)	3573981	ALKOXY BIS-HETEROARYL DERIVATIVES AS MODULATORS OF PROTEIN AGGREGATION
A61P 25/28 (2006.01)	3573981	ALKOXY BIS-HETEROARYL DERIVATIVES AS MODULATORS OF PROTEIN AGGREGATION
C07D 417/12 (2006.01)	3573981	ALKOXY BIS-HETEROARYL DERIVATIVES AS MODULATORS OF PROTEIN AGGREGATION
C07D 417/14 (2006.01)	3573981	ALKOXY BIS-HETEROARYL DERIVATIVES AS MODULATORS OF PROTEIN AGGREGATION
A61K 31/496 (2006.01)	3573982	BIS-HETEROARYL DERIVATIVES AS MODULATORS OF PROTEIN AGGREGATION
A61K 31/501 (2006.01)	3573982	BIS-HETEROARYL DERIVATIVES AS MODULATORS OF PROTEIN AGGREGATION
A61K 31/506 (2006.01)	3573982	BIS-HETEROARYL DERIVATIVES AS MODULATORS OF PROTEIN AGGREGATION
A61P 25/28 (2006.01)	3573982	BIS-HETEROARYL DERIVATIVES AS MODULATORS OF PROTEIN AGGREGATION
A61P 35/00 (2006.01)	3573982	BIS-HETEROARYL DERIVATIVES AS MODULATORS OF PROTEIN AGGREGATION

MKP	Broj objave evropske prijave patenta (97)	Naziv pronalaska (54)
(51)		(54)
C07D 417/12 (2006.01)	3573982	BIS-HETEROARYL DERIVATIVES AS MODULATORS OF PROTEIN AGGREGATION
C07D 417/14 (2006.01)	3573982	BIS-HETEROARYL DERIVATIVES AS MODULATORS OF PROTEIN AGGREGATION
C07D 471/04 (2006.01)	3573986	BICYCLIC BIS-HETEROARYL DERIVATIVES AS MODULATORS OF PROTEIN AGGREGATION
C07D 487/04 (2006.01)	3573986	BICYCLIC BIS-HETEROARYL DERIVATIVES AS MODULATORS OF PROTEIN AGGREGATION
C07D 498/04 (2006.01)	3573986	BICYCLIC BIS-HETEROARYL DERIVATIVES AS MODULATORS OF PROTEIN AGGREGATION
C12N 15/113 (2010.01)	3577222	NOVEL METHODS FOR SUB-TYPING AND TREATING CANCER
G01N 33/574 (2006.01)	3577222	NOVEL METHODS FOR SUB-TYPING AND TREATING CANCER
A61K 8/02 (2006.01)	3579928	FUNCTIONALIZED CALCIUM CARBONATE FOR SUN PROTECTION BOOSTING
A61K 8/19 (2006.01)	3579928	FUNCTIONALIZED CALCIUM CARBONATE FOR SUN PROTECTION BOOSTING
A61K 8/29 (2006.01)	3579928	FUNCTIONALIZED CALCIUM CARBONATE FOR SUN PROTECTION BOOSTING
A61Q 17/04 (2006.01)	3579928	FUNCTIONALIZED CALCIUM CARBONATE FOR SUN PROTECTION BOOSTING
A61K 39/395 (2006.01)	3565594	METHODS OF TREATING CANCER WITH ANTI-TIM-3 ANTIBODIES
A61P 35/00 (2006.01)	3565594	METHODS OF TREATING CANCER WITH ANTI-TIM-3 ANTIBODIES
C07K 16/28 (2006.01)	3565594	METHODS OF TREATING CANCER WITH ANTI-TIM-3 ANTIBODIES
A61K 31/437 (2006.01)	3573987	TYROSINE AMIDE DERIVATIVES AS RHO- KINASE INHIBITORS
A61K 31/519 (2006.01)	3573987	TYROSINE AMIDE DERIVATIVES AS RHO- KINASE INHIBITORS
A61P 11/06 (2006.01)	3573987	TYROSINE AMIDE DERIVATIVES AS RHO- KINASE INHIBITORS
C07D 471/04 (2006.01)	3573987	TYROSINE AMIDE DERIVATIVES AS RHO- KINASE INHIBITORS
C07D 487/04 (2006.01)	3573987	TYROSINE AMIDE DERIVATIVES AS RHO- KINASE INHIBITORS
C07D 519/00 (2006.01)	3573987	TYROSINE AMIDE DERIVATIVES AS RHO- KINASE INHIBITORS
H01R 4/36 (2006.01)	3583662	CONNECTOR FOR PRINTED CIRCUIT BOARDS
H01R 12/51 (2011.01)	3583662	CONNECTOR FOR PRINTED CIRCUIT BOARDS
H01R 12/75 (2011.01)	3583662	CONNECTOR FOR PRINTED CIRCUIT BOARDS
A61K 9/00 (2006.01)	3573597	TEAR SUBSTITUTE
A61K 47/32 (2006.01)	3573597	TEAR SUBSTITUTE
A61K 47/36 (2006.01)	3573597	TEAR SUBSTITUTE
A61K 31/40 (2006.01)	3565808	COMPOUNDS USEFUL FOR TREATING GASTROINTESTINAL TRACT DISORDERS
A61K 31/41 (2006.01)	3565808	COMPOUNDS USEFUL FOR TREATING GASTROINTESTINAL TRACT DISORDERS
A61K 31/435 (2006.01)	3565808	COMPOUNDS USEFUL FOR TREATING GASTROINTESTINAL TRACT DISORDERS
A61K 31/445 (2006.01)	3565808	COMPOUNDS USEFUL FOR TREATING GASTROINTESTINAL TRACT DISORDERS
A61K 31/4462 (2006.01)	3565808	COMPOUNDS USEFUL FOR TREATING GASTROINTESTINAL TRACT DISORDERS
C07D 207/12 (2006.01)	3565808	COMPOUNDS USEFUL FOR TREATING GASTROINTESTINAL TRACT DISORDERS
C07D 211/56 (2006.01)	3565808	COMPOUNDS USEFUL FOR TREATING GASTROINTESTINAL TRACT DISORDERS
C07D 225/02 (2006.01)	3565808	COMPOUNDS USEFUL FOR TREATING GASTROINTESTINAL TRACT DISORDERS
C07D 249/04 (2006.01)	3565808	COMPOUNDS USEFUL FOR TREATING GASTROINTESTINAL TRACT DISORDERS
C07D 295/033 (2006.01)	3565808	COMPOUNDS USEFUL FOR TREATING GASTROINTESTINAL TRACT DISORDERS
C07D 317/26 (2006.01)	3565808	COMPOUNDS USEFUL FOR TREATING GASTROINTESTINAL TRACT DISORDERS
C12P 7/22 (2006.01)	3571307	ENZYME-ASSISTED LIPID-BASED EXTRACTION AND STABILIZATION OF PHYTO-CANNABINOIDS AND TERPENS AND PRODUCTS OBTAINED THEREOF
C12P 17/06 (2006.01)	3571307	ENZYME-ASSISTED LIPID-BASED EXTRACTION AND STABILIZATION OF PHYTO-CANNABINOIDS AND TERPENS AND PRODUCTS OBTAINED THEREOF
A61K 31/501 (2006.01)	3580211	2-HETEROARYL-3-OXO-2,3-DIHYDROPYRIDAZINE-4-CARBOXAMIDES FOR THE TREATMENT OF CANCER
A61P 35/00 (2006.01)	3580211	2-HETEROARYL-3-OXO-2,3-DIHYDROPYRIDAZINE-4-CARBOXAMIDES FOR THE TREATMENT OF CANCER
C07D 237/04 (2006.01)	3580211	2-HETEROARYL-3-OXO-2,3-DIHYDROPYRIDAZINE-4-

MKP (51)	Broj objave evropske prijave patenta (97)	Naziv pronalaska (54)
C07D 237/24 (2006.01)	3580211	CARBOXAMIDES FOR THE TREATMENT OF CANCER
C07D 401/04 (2006.01)	3580211	2-HETEROARYL-3-OXO-2,3-DIHYDROPYRIDAZINE-4-CARBOXAMIDES FOR THE TREATMENT OF CANCER
C07D 401/14 (2006.01)	3580211	2-HETEROARYL-3-OXO-2,3-DIHYDROPYRIDAZINE-4-CARBOXAMIDES FOR THE TREATMENT OF CANCER
C07D 403/04 (2006.01)	3580211	2-HETEROARYL-3-OXO-2,3-DIHYDROPYRIDAZINE-4-CARBOXAMIDES FOR THE TREATMENT OF CANCER
C07D 405/14 (2006.01)	3580211	2-HETEROARYL-3-OXO-2,3-DIHYDROPYRIDAZINE-4-CARBOXAMIDES FOR THE TREATMENT OF CANCER
C07D 409/04 (2006.01)	3580211	2-HETEROARYL-3-OXO-2,3-DIHYDROPYRIDAZINE-4-CARBOXAMIDES FOR THE TREATMENT OF CANCER
C07D 413/04 (2006.01)	3580211	2-HETEROARYL-3-OXO-2,3-DIHYDROPYRIDAZINE-4-CARBOXAMIDES FOR THE TREATMENT OF CANCER
C07D 417/04 (2006.01)	3580211	2-HETEROARYL-3-OXO-2,3-DIHYDROPYRIDAZINE-4-CARBOXAMIDES FOR THE TREATMENT OF CANCER
C07D 417/14 (2006.01)	3580211	2-HETEROARYL-3-OXO-2,3-DIHYDROPYRIDAZINE-4-CARBOXAMIDES FOR THE TREATMENT OF CANCER
A61P 35/00 (2006.01)	3565844	METHODS OF TREATING CANCER WITH ANTI-PD-1 ANTIBODIES
C07K 16/28 (2006.01)	3565844	METHODS OF TREATING CANCER WITH ANTI-PD-1 ANTIBODIES
C12P 19/24 (2006.01)	3583224	PROCESS FOR PRODUCTION OF A SOLID MATERIAL CONTAINING ISOMALTULOSE CRYSTALS AND TREHALULOSE
A61K 31/416 (2006.01)	3571187	CHEMICAL COMPOUNDS AS INHIBITORS OF INTERLEUKIN-1 ACTIVITY
A61K 31/4162 (2006.01)	3571187	CHEMICAL COMPOUNDS AS INHIBITORS OF INTERLEUKIN-1 ACTIVITY
A61K 31/424 (2006.01)	3571187	CHEMICAL COMPOUNDS AS INHIBITORS OF INTERLEUKIN-1 ACTIVITY
A61K 31/429 (2006.01)	3571187	CHEMICAL COMPOUNDS AS INHIBITORS OF INTERLEUKIN-1 ACTIVITY
A61P 1/00 (2006.01)	3571187	CHEMICAL COMPOUNDS AS INHIBITORS OF INTERLEUKIN-1 ACTIVITY
A61P 5/00 (2006.01)	3571187	CHEMICAL COMPOUNDS AS INHIBITORS OF INTERLEUKIN-1 ACTIVITY
A61P 11/00 (2006.01)	3571187	CHEMICAL COMPOUNDS AS INHIBITORS OF INTERLEUKIN-1 ACTIVITY
A61P 13/00 (2006.01)	3571187	CHEMICAL COMPOUNDS AS INHIBITORS OF INTERLEUKIN-1 ACTIVITY
A61P 17/00 (2006.01)	3571187	CHEMICAL COMPOUNDS AS INHIBITORS OF INTERLEUKIN-1 ACTIVITY
A61P 25/00 (2006.01)	3571187	CHEMICAL COMPOUNDS AS INHIBITORS OF INTERLEUKIN-1 ACTIVITY
A61P 31/00 (2006.01)	3571187	CHEMICAL COMPOUNDS AS INHIBITORS OF INTERLEUKIN-1 ACTIVITY
A61P 35/00 (2006.01)	3571187	CHEMICAL COMPOUNDS AS INHIBITORS OF INTERLEUKIN-1 ACTIVITY
C07D 231/56 (2006.01)	3571187	CHEMICAL COMPOUNDS AS INHIBITORS OF INTERLEUKIN-1 ACTIVITY
C07D 263/52 (2006.01)	3571187	CHEMICAL COMPOUNDS AS INHIBITORS OF INTERLEUKIN-1 ACTIVITY
C07D 265/12 (2006.01)	3571187	CHEMICAL COMPOUNDS AS INHIBITORS OF INTERLEUKIN-1 ACTIVITY
C07D 487/04 (2006.01)	3571187	CHEMICAL COMPOUNDS AS INHIBITORS OF INTERLEUKIN-1 ACTIVITY
C07D 498/04 (2006.01)	3571187	CHEMICAL COMPOUNDS AS INHIBITORS OF INTERLEUKIN-1 ACTIVITY
C07D 498/20 (2006.01)	3571187	CHEMICAL COMPOUNDS AS INHIBITORS OF INTERLEUKIN-1 ACTIVITY
C07D 513/04 (2006.01)	3571187	CHEMICAL COMPOUNDS AS INHIBITORS OF INTERLEUKIN-1 ACTIVITY
C07C 205/19 (2006.01)	3573948	METHODS OF PREPARING CYTOTOXIC BENZODIAZEPINE DERIVATIVES
C07D 207/452 (2006.01)	3573948	METHODS OF PREPARING CYTOTOXIC BENZODIAZEPINE DERIVATIVES
C07D 487/04 (2006.01)	3573948	METHODS OF PREPARING CYTOTOXIC BENZODIAZEPINE DERIVATIVES
C07D 519/04 (2006.01)	3573948	METHODS OF PREPARING CYTOTOXIC BENZODIAZEPINE

MKP (51)	Broj objave evropske prijave patenta (97)	Naziv pronalaska (54)
A61K 39/00 (2006.01)	3577136	DERIVATIVES INHIBITION OF PLATELET AGGREGATION USING ANTI-HUMAN GPVI ANTIBODIES
A61K 39/395 (2006.01)	3577136	INHIBITION OF PLATELET AGGREGATION USING ANTI-HUMAN GPVI ANTIBODIES
C07K 16/28 (2006.01)	3577136	INHIBITION OF PLATELET AGGREGATION USING ANTI-HUMAN GPVI ANTIBODIES
G01N 33/36 (2006.01)	3586127	MODULABLE SYSTEM FOR IDENTIFYING AND CERTIFYING GARMENTS
A61K 9/00 (2006.01)	3576762	FACTOR IX FUSION PROTEINS AND METHODS OF MAKING AND USING SAME
A61K 38/00 (2006.01)	3576762	FACTOR IX FUSION PROTEINS AND METHODS OF MAKING AND USING SAME
C12N 9/64 (2006.01)	3576762	FACTOR IX FUSION PROTEINS AND METHODS OF MAKING AND USING SAME
C04B 18/16 (2006.01)	3577169	BITUMINOUS EMULSIONS CONTAINING STEROL ADDITIVE FOR ASPHALT PAVEMENT
C04B 26/26 (2006.01)	3577169	BITUMINOUS EMULSIONS CONTAINING STEROL ADDITIVE FOR ASPHALT PAVEMENT
C08L 91/00 (2006.01)	3577169	BITUMINOUS EMULSIONS CONTAINING STEROL ADDITIVE FOR ASPHALT PAVEMENT
C08L 95/00 (2006.01)	3577169	BITUMINOUS EMULSIONS CONTAINING STEROL ADDITIVE FOR ASPHALT PAVEMENT
E01C 1/00 (2006.01)	3577169	BITUMINOUS EMULSIONS CONTAINING STEROL ADDITIVE FOR ASPHALT PAVEMENT
E01C 7/35 (2006.01)	3577169	BITUMINOUS EMULSIONS CONTAINING STEROL ADDITIVE FOR ASPHALT PAVEMENT
A61K 31/215 (2006.01)	3576770	COMPOUNDS AND COMPOSITIONS FOR THE TREATMENT OF OPHTHALMIC DISORDERS
A61K 31/5377 (2006.01)	3576770	COMPOUNDS AND COMPOSITIONS FOR THE TREATMENT OF OPHTHALMIC DISORDERS
A61K 38/08 (2019.01)	3576770	COMPOUNDS AND COMPOSITIONS FOR THE TREATMENT OF OPHTHALMIC DISORDERS
A61P 27/02 (2006.01)	3576770	COMPOUNDS AND COMPOSITIONS FOR THE TREATMENT OF OPHTHALMIC DISORDERS
A61P 27/06 (2006.01)	3576770	COMPOUNDS AND COMPOSITIONS FOR THE TREATMENT OF OPHTHALMIC DISORDERS
A61K 31/454 (2006.01)	3568414	EPIGENETIC ANALYSIS OF CELL THERAPY AND RELATED METHODS
A61K 39/00 (2006.01)	3568414	EPIGENETIC ANALYSIS OF CELL THERAPY AND RELATED METHODS
A61P 35/00 (2006.01)	3568414	EPIGENETIC ANALYSIS OF CELL THERAPY AND RELATED METHODS
C07K 16/28 (2006.01)	3568414	EPIGENETIC ANALYSIS OF CELL THERAPY AND RELATED METHODS
C12Q 1/6869 (2018.01)	3568414	EPIGENETIC ANALYSIS OF CELL THERAPY AND RELATED METHODS
C08J 7/04 (2006.01)	3585844	MINERAL OIL BARRIER
C09D 151/02 (2006.01)	3585844	MINERAL OIL BARRIER
C07D 487/10 (2006.01)	3577121	OGA INHIBITOR COMPOUNDS
C07K 16/00 (2006.01)	3580233	POLYPEPTIDE VARIANTS AND USES THEREOF
C07K 16/10 (2006.01)	3580233	POLYPEPTIDE VARIANTS AND USES THEREOF
C07K 16/28 (2006.01)	3580233	POLYPEPTIDE VARIANTS AND USES THEREOF
A61K 31/44 (2006.01)	3580204	SULFINYL PYRIDINES AND THEIR USE IN THE TREATMENT OF CANCER
A61P 35/00 (2006.01)	3580204	SULFINYL PYRIDINES AND THEIR USE IN THE TREATMENT OF CANCER
C07D 213/72 (2006.01)	3580204	SULFINYL PYRIDINES AND THEIR USE IN THE TREATMENT OF CANCER
A61K 31/427 (2006.01)	3580215	HETEROARYLSULFONYL-SUBSTITUTED PYRIDINES AND THEIR USE IN THE TREATMENT OF CANCER
A61K 31/44 (2006.01)	3580215	HETEROARYLSULFONYL-SUBSTITUTED PYRIDINES AND THEIR USE IN THE TREATMENT OF CANCER
A61P 35/00 (2006.01)	3580215	HETEROARYLSULFONYL-SUBSTITUTED PYRIDINES AND THEIR USE IN THE TREATMENT OF CANCER
C07D 401/12 (2006.01)	3580215	HETEROARYLSULFONYL-SUBSTITUTED PYRIDINES AND THEIR USE IN THE TREATMENT OF CANCER
C07D 403/12 (2006.01)	3580215	HETEROARYLSULFONYL-SUBSTITUTED PYRIDINES AND THEIR

MKP	Broj objave evropske prijave patenta (97)	Naziv pronalaska (54)
(51)		(54)
C07D 417/12 (2006.01)	3580215	USE IN THE TREATMENT OF CANCER
A61K 31/44 (2006.01)	3580209	HETEROARYLSULFONYL-SUBSTITUTED PYRIDINES AND THEIR USE IN THE TREATMENT OF CANCER
A61P 35/00 (2006.01)	3580209	HETEROARYLSULFONYL-SUBSTITUTED PYRIDINES AND THEIR USE IN THE TREATMENT OF CANCER
C07D 401/12 (2006.01)	3580209	HETEROARYLSULFONYL-SUBSTITUTED PYRIDINES AND THEIR USE IN THE TREATMENT OF CANCER
C07D 407/12 (2006.01)	3580209	HETEROARYLSULFONYL-SUBSTITUTED PYRIDINES AND THEIR USE IN THE TREATMENT OF CANCER
B01D 53/14 (2006.01)	3579964	DEVICE FOR PRODUCING AND TREATING A GAS STREAM THROUGH AN AUTOMATICALLY CONTROLLED VOLUME OF LIQUID
B01D 53/50 (2006.01)	3579964	DEVICE FOR PRODUCING AND TREATING A GAS STREAM THROUGH AN AUTOMATICALLY CONTROLLED VOLUME OF LIQUID
B01D 53/78 (2006.01)	3579964	DEVICE FOR PRODUCING AND TREATING A GAS STREAM THROUGH AN AUTOMATICALLY CONTROLLED VOLUME OF LIQUID
B01J 4/00 (2006.01)	3579964	DEVICE FOR PRODUCING AND TREATING A GAS STREAM THROUGH AN AUTOMATICALLY CONTROLLED VOLUME OF LIQUID
B01J 19/24 (2006.01)	3579964	DEVICE FOR PRODUCING AND TREATING A GAS STREAM THROUGH AN AUTOMATICALLY CONTROLLED VOLUME OF LIQUID
A61K 31/664 (2006.01)	3473636	NUCLEOTIDES CONTAINING AN N-[(S)-1-CYCLOBUTOXYCARBONYL]PHOSPHORAMIDATE FRAGMENT, ANALOGS THEREOF, AND USE THEREOF
A61K 31/675 (2006.01)	3473636	NUCLEOTIDES CONTAINING AN N-[(S)-1-CYCLOBUTOXYCARBONYL]PHOSPHORAMIDATE FRAGMENT, ANALOGS THEREOF, AND USE THEREOF
A61K 31/7072 (2006.01)	3473636	NUCLEOTIDES CONTAINING AN N-[(S)-1-CYCLOBUTOXYCARBONYL]PHOSPHORAMIDATE FRAGMENT, ANALOGS THEREOF, AND USE THEREOF
A61K 31/7076 (2006.01)	3473636	NUCLEOTIDES CONTAINING AN N-[(S)-1-CYCLOBUTOXYCARBONYL]PHOSPHORAMIDATE FRAGMENT, ANALOGS THEREOF, AND USE THEREOF
A61K 31/708 (2006.01)	3473636	NUCLEOTIDES CONTAINING AN N-[(S)-1-CYCLOBUTOXYCARBONYL]PHOSPHORAMIDATE FRAGMENT, ANALOGS THEREOF, AND USE THEREOF
A61P 31/18 (2006.01)	3473636	NUCLEOTIDES CONTAINING AN N-[(S)-1-CYCLOBUTOXYCARBONYL]PHOSPHORAMIDATE FRAGMENT, ANALOGS THEREOF, AND USE THEREOF
A61P 31/20 (2006.01)	3473636	NUCLEOTIDES CONTAINING AN N-[(S)-1-CYCLOBUTOXYCARBONYL]PHOSPHORAMIDATE FRAGMENT, ANALOGS THEREOF, AND USE THEREOF
C07F 9/36 (2006.01)	3473636	NUCLEOTIDES CONTAINING AN N-[(S)-1-CYCLOBUTOXYCARBONYL]PHOSPHORAMIDATE FRAGMENT, ANALOGS THEREOF, AND USE THEREOF
C07F 9/44 (2006.01)	3473636	NUCLEOTIDES CONTAINING AN N-[(S)-1-CYCLOBUTOXYCARBONYL]PHOSPHORAMIDATE FRAGMENT, ANALOGS THEREOF, AND USE THEREOF
C07F 9/6561 (2006.01)	3473636	NUCLEOTIDES CONTAINING AN N-[(S)-1-CYCLOBUTOXYCARBONYL]PHOSPHORAMIDATE FRAGMENT, ANALOGS THEREOF, AND USE THEREOF
C07H 19/10 (2006.01)	3473636	NUCLEOTIDES CONTAINING AN N-[(S)-1-CYCLOBUTOXYCARBONYL]PHOSPHORAMIDATE FRAGMENT, ANALOGS THEREOF, AND USE THEREOF
C07H 19/20 (2006.01)	3473636	NUCLEOTIDES CONTAINING AN N-[(S)-1-CYCLOBUTOXYCARBONYL]PHOSPHORAMIDATE FRAGMENT, ANALOGS THEREOF, AND USE THEREOF
A61F 2/24 (2006.01)	3592287	METHOD FOR GENERATING A MITRAL REPAIR RING, AND MITRAL REPAIR RING
A61K 31/426 (2006.01)	3551626	BENZENESULFONAMIDE COMPOUNDS AND THEIR USE AS THERAPEUTIC AGENTS
A61P 25/08 (2006.01)	3551626	BENZENESULFONAMIDE COMPOUNDS AND THEIR USE AS THERAPEUTIC AGENTS

MKP	Broj objave evropske prijave patenta (97)	Naziv pronalaska (54)
(51)		
C07D 213/76 (2006.01)	3551626	BENZENESULFONAMIDE COMPOUNDS AND THEIR USE AS THERAPEUTIC AGENTS
C07D 237/20 (2006.01)	3551626	BENZENESULFONAMIDE COMPOUNDS AND THEIR USE AS THERAPEUTIC AGENTS
C07D 239/69 (2006.01)	3551626	BENZENESULFONAMIDE COMPOUNDS AND THEIR USE AS THERAPEUTIC AGENTS
C07D 261/16 (2006.01)	3551626	BENZENESULFONAMIDE COMPOUNDS AND THEIR USE AS THERAPEUTIC AGENTS
C07D 277/52 (2006.01)	3551626	BENZENESULFONAMIDE COMPOUNDS AND THEIR USE AS THERAPEUTIC AGENTS
C07D 285/08 (2006.01)	3551626	BENZENESULFONAMIDE COMPOUNDS AND THEIR USE AS THERAPEUTIC AGENTS
C07D 403/12 (2006.01)	3551626	BENZENESULFONAMIDE COMPOUNDS AND THEIR USE AS THERAPEUTIC AGENTS
C07D 413/12 (2006.01)	3551626	BENZENESULFONAMIDE COMPOUNDS AND THEIR USE AS THERAPEUTIC AGENTS
C07D 493/10 (2006.01)	3551626	BENZENESULFONAMIDE COMPOUNDS AND THEIR USE AS THERAPEUTIC AGENTS
G06K 9/00 (2006.01)	3457314	BODY INFORMATION ANALYSIS APPARATUS AND METHOD OF DETECTING FACE SHAPE BY USING SAME
G06T 7/00 (2017.01)	3454297	BODY INFORMATION ANALYSIS APPARATUS AND METHOD OF ANALYZING HAND SKIN USING SAME
A01G 2/30 (2018.01)	3456178	NURSERY FRUIT TREE OF AT LEAST DOUBLE TRUNK TYPE
G06F 21/33 (2013.01)	3461073	PLATFORM AND METHOD OF CERTIFICATION OF AN ELECTRONIC NOTICE FOR ELECTRONIC IDENTIFICATION AND TRUST SERVICES (EIDAS)
G06Q 10/10 (2012.01)	3461073	PLATFORM AND METHOD OF CERTIFICATION OF AN ELECTRONIC NOTICE FOR ELECTRONIC IDENTIFICATION AND TRUST SERVICES (EIDAS)
H04L 12/58 (2006.01)	3461073	PLATFORM AND METHOD OF CERTIFICATION OF AN ELECTRONIC NOTICE FOR ELECTRONIC IDENTIFICATION AND TRUST SERVICES (EIDAS)
H04L 29/06 (2006.01)	3461073	PLATFORM AND METHOD OF CERTIFICATION OF AN ELECTRONIC NOTICE FOR ELECTRONIC IDENTIFICATION AND TRUST SERVICES (EIDAS)
H04W 4/14 (2009.01)	3461073	PLATFORM AND METHOD OF CERTIFICATION OF AN ELECTRONIC NOTICE FOR ELECTRONIC IDENTIFICATION AND TRUST SERVICES (EIDAS)
H04W 12/06 (2009.01)	3461073	PLATFORM AND METHOD OF CERTIFICATION OF AN ELECTRONIC NOTICE FOR ELECTRONIC IDENTIFICATION AND TRUST SERVICES (EIDAS)
G06F 21/33 (2013.01)	3461074	PLATFORM AND METHOD OF CERTIFICATION OF AN ELECTRONIC CONTRACT FOR ELECTRONIC IDENTIFICATION AND TRUST SERVICES (EIDAS)
G06Q 10/10 (2012.01)	3461074	PLATFORM AND METHOD OF CERTIFICATION OF AN ELECTRONIC CONTRACT FOR ELECTRONIC IDENTIFICATION AND TRUST SERVICES (EIDAS)
H04L 12/58 (2006.01)	3461074	PLATFORM AND METHOD OF CERTIFICATION OF AN ELECTRONIC CONTRACT FOR ELECTRONIC IDENTIFICATION AND TRUST SERVICES (EIDAS)
H04L 29/06 (2006.01)	3461074	PLATFORM AND METHOD OF CERTIFICATION OF AN ELECTRONIC CONTRACT FOR ELECTRONIC IDENTIFICATION AND TRUST SERVICES (EIDAS)
H04W 4/14 (2009.01)	3461074	PLATFORM AND METHOD OF CERTIFICATION OF AN ELECTRONIC CONTRACT FOR ELECTRONIC IDENTIFICATION AND TRUST SERVICES (EIDAS)
H04W 12/06 (2009.01)	3461074	PLATFORM AND METHOD OF CERTIFICATION OF AN ELECTRONIC CONTRACT FOR ELECTRONIC IDENTIFICATION AND TRUST SERVICES (EIDAS)
A61K 31/4164 (2006.01)	3498276	ECTOINE AND ECTOINE DERIVATIVES FOR USE IN VULVOVAGINAL CONDITIONS
A61K 31/505 (2006.01)	3498276	ECTOINE AND ECTOINE DERIVATIVES FOR USE IN VULVOVAGINAL CONDITIONS
A61P 15/02 (2006.01)	3498276	ECTOINE AND ECTOINE DERIVATIVES FOR USE IN VULVOVAGINAL CONDITIONS
A61K 9/107 (2006.01)	3466409	SELF-EMULSIFYING COMPOSITIONS OF WEAKLY IONIZABLE OR NON-IONIZABLE ACTIVE PHARMACEUTICAL INGREDIENTS
A61K 9/16 (2006.01)	3466409	SELF-EMULSIFYING COMPOSITIONS OF WEAKLY IONIZABLE OR

MKP (51)	Broj objave evropske prijave patenta (97)	Naziv pronalaska (54)
A61K 9/20 (2006.01)	3466409	NON-IONIZABLE ACTIVE PHARMACEUTICAL INGREDIENTS
A61K 9/50 (2006.01)	3466409	SELF-EMULSIFYING COMPOSITIONS OF WEAKLY IONIZABLE OR NON-IONIZABLE ACTIVE PHARMACEUTICAL INGREDIENTS
A61K 31/192 (2006.01)	3466409	SELF-EMULSIFYING COMPOSITIONS OF WEAKLY IONIZABLE OR NON-IONIZABLE ACTIVE PHARMACEUTICAL INGREDIENTS
A61K 31/519 (2006.01)	3466409	SELF-EMULSIFYING COMPOSITIONS OF WEAKLY IONIZABLE OR NON-IONIZABLE ACTIVE PHARMACEUTICAL INGREDIENTS
A23G 9/08 (2006.01)	3565418	COMPOSITION AND PROCESS FOR PRODUCING ARTISAN ICE CREAM FOR BATCH FREEZING
A23G 9/40 (2006.01)	3565418	COMPOSITION AND PROCESS FOR PRODUCING ARTISAN ICE CREAM FOR BATCH FREEZING
A23G 9/52 (2006.01)	3565418	COMPOSITION AND PROCESS FOR PRODUCING ARTISAN ICE CREAM FOR BATCH FREEZING
A61K 47/00 (2006.01)	3570891	MEDICAMENTS AND USES IN TREATMENT OF CANCER AND OTHER PATHOLOGICAL CONDITIONS ASSOCIATED WITH AGING
A61P 35/00 (2006.01)	3570891	MEDICAMENTS AND USES IN TREATMENT OF CANCER AND OTHER PATHOLOGICAL CONDITIONS ASSOCIATED WITH AGING
C07C 291/02 (2006.01)	3530649	PROCESS FOR THE PREPARATION OF A NITRIC OXIDE DONATING PROSTAGLANDIN ANALOGUE
C07C 405/00 (2006.01)	3530649	PROCESS FOR THE PREPARATION OF A NITRIC OXIDE DONATING PROSTAGLANDIN ANALOGUE
G06K 9/00 (2006.01)	3457318	BODY INFORMATION ANALYSIS APPARATUS AND BLUSH ANALYSIS METHOD THEREOF
A61K 31/33 (2006.01)	3456325	GAMMA-DIKETONES AS WNT/BETA-CATENIN SIGNALLING PATHWAY ACTIVATORS
A61P 25/00 (2006.01)	3456325	GAMMA-DIKETONES AS WNT/BETA-CATENIN SIGNALLING PATHWAY ACTIVATORS
C07D 213/50 (2006.01)	3456325	GAMMA-DIKETONES AS WNT/BETA-CATENIN SIGNALLING PATHWAY ACTIVATORS
C07D 231/56 (2006.01)	3456325	GAMMA-DIKETONES AS WNT/BETA-CATENIN SIGNALLING PATHWAY ACTIVATORS
C07D 235/06 (2006.01)	3456325	GAMMA-DIKETONES AS WNT/BETA-CATENIN SIGNALLING PATHWAY ACTIVATORS
C07D 263/56 (2006.01)	3456325	GAMMA-DIKETONES AS WNT/BETA-CATENIN SIGNALLING PATHWAY ACTIVATORS
C07D 307/80 (2006.01)	3456325	GAMMA-DIKETONES AS WNT/BETA-CATENIN SIGNALLING PATHWAY ACTIVATORS
C07D 311/58 (2006.01)	3456325	GAMMA-DIKETONES AS WNT/BETA-CATENIN SIGNALLING PATHWAY ACTIVATORS
C07D 317/54 (2006.01)	3456325	GAMMA-DIKETONES AS WNT/BETA-CATENIN SIGNALLING PATHWAY ACTIVATORS
C07D 319/18 (2006.01)	3456325	GAMMA-DIKETONES AS WNT/BETA-CATENIN SIGNALLING PATHWAY ACTIVATORS
C07D 327/06 (2006.01)	3456325	GAMMA-DIKETONES AS WNT/BETA-CATENIN SIGNALLING PATHWAY ACTIVATORS
C07D 333/54 (2006.01)	3456325	GAMMA-DIKETONES AS WNT/BETA-CATENIN SIGNALLING PATHWAY ACTIVATORS
C07D 339/08 (2006.01)	3456325	GAMMA-DIKETONES AS WNT/BETA-CATENIN SIGNALLING PATHWAY ACTIVATORS
C07D 401/06 (2006.01)	3456325	GAMMA-DIKETONES AS WNT/BETA-CATENIN SIGNALLING PATHWAY ACTIVATORS
C07D 405/06 (2006.01)	3456325	GAMMA-DIKETONES AS WNT/BETA-CATENIN SIGNALLING PATHWAY ACTIVATORS
C07D 407/06 (2006.01)	3456325	GAMMA-DIKETONES AS WNT/BETA-CATENIN SIGNALLING PATHWAY ACTIVATORS
C07D 409/06 (2006.01)	3456325	GAMMA-DIKETONES AS WNT/BETA-CATENIN SIGNALLING PATHWAY ACTIVATORS
C07D 411/06 (2006.01)	3456325	GAMMA-DIKETONES AS WNT/BETA-CATENIN SIGNALLING PATHWAY ACTIVATORS
C07D 413/06 (2006.01)	3456325	GAMMA-DIKETONES AS WNT/BETA-CATENIN SIGNALLING PATHWAY ACTIVATORS
A61K 9/14 (2006.01)	3456318	SOLID COMPOSITIONS
A61K 9/16 (2006.01)	3456318	SOLID COMPOSITIONS
A61K 9/20 (2006.01)	3456318	SOLID COMPOSITIONS
A61K 31/00 (2006.01)	3456318	SOLID COMPOSITIONS
C07K 16/28 (2006.01)	3456743	ONCOSTATIN M RECEPTOR ANTIGEN BINDING PROTEINS

MKP	Broj objave evropske prijave patenta (97)	Naziv pronalaska (54)
(51)		
A61K 31/506 (2006.01)	3453708	PROCESS FOR THE PREPARATION OF 5-CHLORO-N-(2-ISOPROPOXY-5-METHYL-4-PIPERIDIN-4-YL-PHENYL)-N-2-(ISOPROPYLSULFONYL)PHENYL)-2,4-DIAMINE DI-HYDROCHLORIDE
A61P 35/00 (2006.01)	3453708	PROCESS FOR THE PREPARATION OF 5-CHLORO-N-(2-ISOPROPOXY-5-METHYL-4-PIPERIDIN-4-YL-PHENYL)-N-2-(ISOPROPYLSULFONYL)PHENYL)-2,4-DIAMINE DI-HYDROCHLORIDE
C07D 401/12 (2006.01)	3453708	PROCESS FOR THE PREPARATION OF 5-CHLORO-N-(2-ISOPROPOXY-5-METHYL-4-PIPERIDIN-4-YL-PHENYL)-N-2-(ISOPROPYLSULFONYL)PHENYL)-2,4-DIAMINE DI-HYDROCHLORIDE
C07K 14/00 (2006.01)	3461889	COMPOSITIONS FOR INCREASING POLYPEPTIDE STABILITY AND ACTIVITY, AND RELATED METHODS
C07K 19/00 (2006.01)	3461889	COMPOSITIONS FOR INCREASING POLYPEPTIDE STABILITY AND ACTIVITY, AND RELATED METHODS
C12N 9/00 (2006.01)	3461889	COMPOSITIONS FOR INCREASING POLYPEPTIDE STABILITY AND ACTIVITY, AND RELATED METHODS
C12N 9/12 (2006.01)	3461889	COMPOSITIONS FOR INCREASING POLYPEPTIDE STABILITY AND ACTIVITY, AND RELATED METHODS
C12N 9/96 (2006.01)	3461889	COMPOSITIONS FOR INCREASING POLYPEPTIDE STABILITY AND ACTIVITY, AND RELATED METHODS
C07F 9/576 (2006.01)	3459958	PROCESS AND INTERMEDIATES FOR PREPARING PRODRUGS OF PYRIDONE AMIDES USEFUL AS MODULATORS OF SODIUM CHANNELS
C07F 9/58 (2006.01)	3459958	PROCESS AND INTERMEDIATES FOR PREPARING PRODRUGS OF PYRIDONE AMIDES USEFUL AS MODULATORS OF SODIUM CHANNELS
A01K 29/00 (2006.01)	3449720	DEVICE FOR THE TREATMENT OF PET FOOD FOR CARNIVORES
A01K 63/00 (2017.01)	3449720	DEVICE FOR THE TREATMENT OF PET FOOD FOR CARNIVORES
A22B 3/00 (2006.01)	3449720	DEVICE FOR THE TREATMENT OF PET FOOD FOR CARNIVORES
A23B 4/06 (2006.01)	3449720	DEVICE FOR THE TREATMENT OF PET FOOD FOR CARNIVORES
F17C 5/02 (2006.01)	3450819	METHOD FOR FILLING A MOBILE COOLANT TANK WITH A CRYOGENIC COOLANT
A61K 9/20 (2006.01)	3456321	OPIOID RECEPTOR MODULATOR DOSAGE FORMULATIONS
A61K 9/28 (2006.01)	3456321	OPIOID RECEPTOR MODULATOR DOSAGE FORMULATIONS
A61K 31/4174 (2006.01)	3456321	OPIOID RECEPTOR MODULATOR DOSAGE FORMULATIONS
A61P 25/04 (2006.01)	3456321	OPIOID RECEPTOR MODULATOR DOSAGE FORMULATIONS
A61K 31/519 (2006.01)	3450434	DEUTERATED DERIVATIVES OF RUXOLITINIB
A61P 35/02 (2006.01)	3450434	DEUTERATED DERIVATIVES OF RUXOLITINIB
C07B 59/00 (2006.01)	3450434	DEUTERATED DERIVATIVES OF RUXOLITINIB
C07D 487/04 (2006.01)	3450434	DEUTERATED DERIVATIVES OF RUXOLITINIB
C07K 16/24 (2006.01)	3456740	ANTI-IL-23 ANTIBODIES
C07D 403/14 (2006.01)	3555087	MONOCYCLIC OGA INHIBITOR COMPOUNDS
C07D 417/12 (2006.01)	3555087	MONOCYCLIC OGA INHIBITOR COMPOUNDS
C07D 417/14 (2006.01)	3555087	MONOCYCLIC OGA INHIBITOR COMPOUNDS
A61K 31/4427 (2006.01)	3555064	GLP-1 RECEPTOR AGONISTS AND USES THEREOF
A61K 31/497 (2006.01)	3555064	GLP-1 RECEPTOR AGONISTS AND USES THEREOF
A61P 3/00 (2006.01)	3555064	GLP-1 RECEPTOR AGONISTS AND USES THEREOF
C07D 401/14 (2006.01)	3555064	GLP-1 RECEPTOR AGONISTS AND USES THEREOF
C07D 405/14 (2006.01)	3555064	GLP-1 RECEPTOR AGONISTS AND USES THEREOF
C07D 413/14 (2006.01)	3555064	GLP-1 RECEPTOR AGONISTS AND USES THEREOF
C07D 471/04 (2006.01)	3555064	GLP-1 RECEPTOR AGONISTS AND USES THEREOF
C07D 487/04 (2006.01)	3555064	GLP-1 RECEPTOR AGONISTS AND USES THEREOF
A61K 39/395 (2006.01)	3551225	ANTIBODIES AND METHODS OF USE THEREOF
C07K 16/28 (2006.01)	3551225	ANTIBODIES AND METHODS OF USE THEREOF
A61K 31/513 (2006.01)	3558316	USE OF CHYMASE INHIBITORS FOR THE TREATMENT OF ENDOMETRIOSIS, POST-OPERATIVE FIBROSIS AND DISEASES WHICH ARE CHARACTERIZED BY FIBROSIS FORMATION
A61P 15/00 (2006.01)	3558316	USE OF CHYMASE INHIBITORS FOR THE TREATMENT OF ENDOMETRIOSIS, POST-OPERATIVE FIBROSIS AND DISEASES WHICH ARE CHARACTERIZED BY FIBROSIS FORMATION
A61K 31/5365 (2006.01)	3555104	NRF2 COMPOUNDS
A61P 1/16 (2006.01)	3555104	NRF2 COMPOUNDS
A61P 9/00 (2006.01)	3555104	NRF2 COMPOUNDS
A61P 11/00 (2006.01)	3555104	NRF2 COMPOUNDS
A61P 11/06 (2006.01)	3555104	NRF2 COMPOUNDS
A61P 13/12 (2006.01)	3555104	NRF2 COMPOUNDS

MKP	Broj objave evropske prijave patenta	Naziv pronalaska
(51)	(97)	(54)
A61P 17/06 (2006.01)	3555104	NRF2 COMPOUNDS
A61P 35/00 (2006.01)	3555104	NRF2 COMPOUNDS
C07D 498/04 (2006.01)	3555104	NRF2 COMPOUNDS
A61K 31/554 (2006.01)	3555088	BISARYL AMIDES AS NRF2 REGULATORS
A61P 1/16 (2006.01)	3555088	BISARYL AMIDES AS NRF2 REGULATORS
A61P 9/00 (2006.01)	3555088	BISARYL AMIDES AS NRF2 REGULATORS
A61P 11/00 (2006.01)	3555088	BISARYL AMIDES AS NRF2 REGULATORS
A61P 11/06 (2006.01)	3555088	BISARYL AMIDES AS NRF2 REGULATORS
A61P 13/12 (2006.01)	3555088	BISARYL AMIDES AS NRF2 REGULATORS
A61P 17/06 (2006.01)	3555088	BISARYL AMIDES AS NRF2 REGULATORS
A61P 35/00 (2006.01)	3555088	BISARYL AMIDES AS NRF2 REGULATORS
C07D 417/12 (2006.01)	3555088	BISARYL AMIDES AS NRF2 REGULATORS
C07D 417/14 (2006.01)	3555088	BISARYL AMIDES AS NRF2 REGULATORS
C07D 498/04 (2006.01)	3555088	BISARYL AMIDES AS NRF2 REGULATORS
A61K 39/00 (2006.01)	3551660	ANTI-CTLA-4 ANTIBODIES AND METHODS OF USE THEREOF
C07K 16/28 (2006.01)	3551660	ANTI-CTLA-4 ANTIBODIES AND METHODS OF USE THEREOF
A61K 31/55 (2006.01)	3558948	NEW SALT OF IVABRADINE AND USES THEREOF
A61P 9/10 (2006.01)	3558948	NEW SALT OF IVABRADINE AND USES THEREOF
C07D 223/16 (2006.01)	3558948	NEW SALT OF IVABRADINE AND USES THEREOF
A61K 31/551 (2006.01)	3555068	3-OXO-1,4-DIAZEPINYLE COMPOUNDS AS NRF2 ACTIVATORS
A61P 9/04 (2006.01)	3555068	3-OXO-1,4-DIAZEPINYLE COMPOUNDS AS NRF2 ACTIVATORS
A61P 11/00 (2006.01)	3555068	3-OXO-1,4-DIAZEPINYLE COMPOUNDS AS NRF2 ACTIVATORS
C07D 403/10 (2006.01)	3555068	3-OXO-1,4-DIAZEPINYLE COMPOUNDS AS NRF2 ACTIVATORS
C07D 403/12 (2006.01)	3555068	3-OXO-1,4-DIAZEPINYLE COMPOUNDS AS NRF2 ACTIVATORS
A61K 31/553 (2006.01)	3555082	ETHER LINKED TRIAZOLES AS NRF2 REGULATORS
A61K 31/554 (2006.01)	3555082	ETHER LINKED TRIAZOLES AS NRF2 REGULATORS
A61P 9/04 (2006.01)	3555082	ETHER LINKED TRIAZOLES AS NRF2 REGULATORS
A61P 11/00 (2006.01)	3555082	ETHER LINKED TRIAZOLES AS NRF2 REGULATORS
C07D 249/04 (2006.01)	3555082	ETHER LINKED TRIAZOLES AS NRF2 REGULATORS
C07D 413/12 (2006.01)	3555082	ETHER LINKED TRIAZOLES AS NRF2 REGULATORS
C07D 419/12 (2006.01)	3555082	ETHER LINKED TRIAZOLES AS NRF2 REGULATORS
C07D 419/14 (2006.01)	3555082	ETHER LINKED TRIAZOLES AS NRF2 REGULATORS
C07D 471/04 (2006.01)	3555082	ETHER LINKED TRIAZOLES AS NRF2 REGULATORS
C07D 498/04 (2006.01)	3555082	ETHER LINKED TRIAZOLES AS NRF2 REGULATORS
A61K 31/496 (2006.01)	3585779	SUBSTITUTED DIHYDROBENZOFURAN GLYCOSIDASE INHIBITORS
A61K 31/497 (2006.01)	3585779	SUBSTITUTED DIHYDROBENZOFURAN GLYCOSIDASE INHIBITORS
A61K 31/501 (2006.01)	3585779	SUBSTITUTED DIHYDROBENZOFURAN GLYCOSIDASE INHIBITORS
A61K 31/506 (2006.01)	3585779	SUBSTITUTED DIHYDROBENZOFURAN GLYCOSIDASE INHIBITORS
C07B 59/00 (2006.01)	3585779	SUBSTITUTED DIHYDROBENZOFURAN GLYCOSIDASE INHIBITORS
C07D 401/12 (2006.01)	3585779	SUBSTITUTED DIHYDROBENZOFURAN GLYCOSIDASE INHIBITORS
C07D 403/12 (2006.01)	3585779	SUBSTITUTED DIHYDROBENZOFURAN GLYCOSIDASE INHIBITORS
C07D 405/12 (2006.01)	3585779	SUBSTITUTED DIHYDROBENZOFURAN GLYCOSIDASE INHIBITORS
C07D 405/14 (2006.01)	3585779	SUBSTITUTED DIHYDROBENZOFURAN GLYCOSIDASE INHIBITORS
C07D 407/12 (2006.01)	3585779	SUBSTITUTED DIHYDROBENZOFURAN GLYCOSIDASE INHIBITORS
C07D 413/12 (2006.01)	3585779	SUBSTITUTED DIHYDROBENZOFURAN GLYCOSIDASE INHIBITORS
C07D 417/12 (2006.01)	3585779	SUBSTITUTED DIHYDROBENZOFURAN GLYCOSIDASE INHIBITORS
C07D 417/14 (2006.01)	3585779	SUBSTITUTED DIHYDROBENZOFURAN GLYCOSIDASE INHIBITORS
C07D 471/04 (2006.01)	3585779	SUBSTITUTED DIHYDROBENZOFURAN GLYCOSIDASE INHIBITORS
C07D 475/04 (2006.01)	3585779	SUBSTITUTED DIHYDROBENZOFURAN GLYCOSIDASE INHIBITORS
C07D 487/04 (2006.01)	3585779	SUBSTITUTED DIHYDROBENZOFURAN GLYCOSIDASE INHIBITORS
C07D 495/04 (2006.01)	3585779	SUBSTITUTED DIHYDROBENZOFURAN GLYCOSIDASE INHIBITORS

MKP	Broj objave evropske prijave patenta (97)	Naziv pronalaska (54)
(51)		(54)
C07D 498/04 (2006.01)	3585779	SUBSTITUTED DIHYDROBENZOFURAN GLYCOSIDASE INHIBITORS
C07D 513/04 (2006.01)	3585779	SUBSTITUTED DIHYDROBENZOFURAN GLYCOSIDASE INHIBITORS
C07D 401/12 (2006.01)	3585783	SULFOXIMINE GLYCOSIDASE INHIBITORS
C07D 405/12 (2006.01)	3585783	SULFOXIMINE GLYCOSIDASE INHIBITORS
C07D 413/12 (2006.01)	3585783	SULFOXIMINE GLYCOSIDASE INHIBITORS
C07D 417/12 (2006.01)	3585783	SULFOXIMINE GLYCOSIDASE INHIBITORS
C07D 417/14 (2006.01)	3585783	SULFOXIMINE GLYCOSIDASE INHIBITORS
C07D 495/04 (2006.01)	3585783	SULFOXIMINE GLYCOSIDASE INHIBITORS
A21D 13/80 (2017.01)	3566583	CHILDREN'S BISCUIT WITH NO ADDED SUGAR AND METHOD OF PREPARING IT
A23L 5/40 (2016.01)	3566583	CHILDREN'S BISCUIT WITH NO ADDED SUGAR AND METHOD OF PREPARING IT
A23L 33/00 (2016.01)	3566583	CHILDREN'S BISCUIT WITH NO ADDED SUGAR AND METHOD OF PREPARING IT
A23L 33/21 (2016.01)	3566583	CHILDREN'S BISCUIT WITH NO ADDED SUGAR AND METHOD OF PREPARING IT
H02K 3/52 (2006.01)	3552303	STATOR OF AN ELECTRICAL MACHINE, ELECTRICAL MACHINE, AND ROUTING AND CONTACTING DEVICE FOR AN ELECTRICAL MACHINE
A61K 31/165 (2006.01)	3574898	SAFINAMIDE FOR THE TREATING MYOTONIA
A61P 25/14 (2006.01)	3574898	SAFINAMIDE FOR THE TREATING MYOTONIA
A61K 31/4045 (2006.01)	3461821	INDOLE CARBOXAMIDE COMPOUNDS USEFUL AS KINASE INHIBITORS
A61P 29/00 (2006.01)	3461821	INDOLE CARBOXAMIDE COMPOUNDS USEFUL AS KINASE INHIBITORS
A61P 37/00 (2006.01)	3461821	INDOLE CARBOXAMIDE COMPOUNDS USEFUL AS KINASE INHIBITORS
C07D 209/18 (2006.01)	3461821	INDOLE CARBOXAMIDE COMPOUNDS USEFUL AS KINASE INHIBITORS
C07D 401/04 (2006.01)	3461821	INDOLE CARBOXAMIDE COMPOUNDS USEFUL AS KINASE INHIBITORS
C07D 401/06 (2006.01)	3461821	INDOLE CARBOXAMIDE COMPOUNDS USEFUL AS KINASE INHIBITORS
C07D 401/12 (2006.01)	3461821	INDOLE CARBOXAMIDE COMPOUNDS USEFUL AS KINASE INHIBITORS
C07D 403/04 (2006.01)	3461821	INDOLE CARBOXAMIDE COMPOUNDS USEFUL AS KINASE INHIBITORS
C07D 403/10 (2006.01)	3461821	INDOLE CARBOXAMIDE COMPOUNDS USEFUL AS KINASE INHIBITORS
C07D 403/12 (2006.01)	3461821	INDOLE CARBOXAMIDE COMPOUNDS USEFUL AS KINASE INHIBITORS
C07D 413/04 (2006.01)	3461821	INDOLE CARBOXAMIDE COMPOUNDS USEFUL AS KINASE INHIBITORS
C07D 417/04 (2006.01)	3461821	INDOLE CARBOXAMIDE COMPOUNDS USEFUL AS KINASE INHIBITORS
C07D 471/04 (2006.01)	3461821	INDOLE CARBOXAMIDE COMPOUNDS USEFUL AS KINASE INHIBITORS
C07D 487/04 (2006.01)	3461821	INDOLE CARBOXAMIDE COMPOUNDS USEFUL AS KINASE INHIBITORS
C07D 487/10 (2006.01)	3461821	INDOLE CARBOXAMIDE COMPOUNDS USEFUL AS KINASE INHIBITORS
C07K 16/28 (2006.01)	3466977	ANTI-VLA-4 ANTIBODIES
C07D 207/06 (2006.01)	3461828	METHODS OF PREPARING TOLL-LIKE RECEPTOR MODULATORS
C07D 239/46 (2006.01)	3461828	METHODS OF PREPARING TOLL-LIKE RECEPTOR MODULATORS
C07D 239/47 (2006.01)	3461828	METHODS OF PREPARING TOLL-LIKE RECEPTOR MODULATORS
C07D 239/48 (2006.01)	3461828	METHODS OF PREPARING TOLL-LIKE RECEPTOR MODULATORS
C07D 239/545 (2006.01)	3461828	METHODS OF PREPARING TOLL-LIKE RECEPTOR MODULATORS
C07D 487/04 (2006.01)	3461828	METHODS OF PREPARING TOLL-LIKE RECEPTOR MODULATORS
A61L 27/36 (2006.01)	3476410	COMPOSITIONS AND METHODS FOR TREATING AND PREVENTING TISSUE INJURY AND DISEASE
A61L 27/38 (2006.01)	3476410	COMPOSITIONS AND METHODS FOR TREATING AND PREVENTING TISSUE INJURY AND DISEASE
A61L 27/54 (2006.01)	3476410	COMPOSITIONS AND METHODS FOR TREATING AND PREVENTING TISSUE INJURY AND DISEASE
A61K 31/225 (2006.01)	3466420	DIMETHYL FUMARATE FOR THE TREATMENT OF FRIEDREICH ATAXIA

MKP	Broj objave evropske prijave patenta (97)	Naziv pronalaska (54)
(51)		
A61P 25/14 (2006.01)	3466420	DIMETHYL FUMARATE FOR THE TREATMENT OF FRIEDREICH ATAXIA
A61P 25/28 (2006.01)	3466420	DIMETHYL FUMARATE FOR THE TREATMENT OF FRIEDREICH ATAXIA
A61K 31/7088 (2006.01)	3483273	CANCER TREATMENT
A61P 35/00 (2006.01)	3483273	CANCER TREATMENT
C07K 14/47 (2006.01)	3483273	CANCER TREATMENT
C12N 15/113 (2010.01)	3483273	CANCER TREATMENT
A61K 39/00 (2006.01)	3473648	HUMAN ANTIBODIES TO PD-L1
A61K 39/395 (2006.01)	3473648	HUMAN ANTIBODIES TO PD-L1
A61P 35/00 (2006.01)	3473648	HUMAN ANTIBODIES TO PD-L1
C07K 16/22 (2006.01)	3473648	HUMAN ANTIBODIES TO PD-L1
C07K 16/28 (2006.01)	3473648	HUMAN ANTIBODIES TO PD-L1
C07K 16/30 (2006.01)	3473648	HUMAN ANTIBODIES TO PD-L1
B29C 31/04 (2006.01)	3486076	RESIN SUPPLY SYSTEM FOR RTM (RESIN-TRANSFER-MOLDING) AND RELATED METHOD
B29C 70/48 (2006.01)	3486076	RESIN SUPPLY SYSTEM FOR RTM (RESIN-TRANSFER-MOLDING) AND RELATED METHOD
B29C 70/54 (2006.01)	3486076	RESIN SUPPLY SYSTEM FOR RTM (RESIN-TRANSFER-MOLDING) AND RELATED METHOD
C12Q 1/6804 (2018.01)	3495505	QUANTITATIVE ASSESSMENT FOR CAP EFFICIENCY OF MESSENGER RNA
B03C 1/033 (2006.01)	3488932	SEPARATION OF COMPONENTS OF A MIXTURE CONTAINING METAL
B03C 1/22 (2006.01)	3488932	SEPARATION OF COMPONENTS OF A MIXTURE CONTAINING METAL
B03C 1/23 (2006.01)	3488932	SEPARATION OF COMPONENTS OF A MIXTURE CONTAINING METAL
A61K 31/4375 (2006.01)	3466490	POLYCYCLIC-CARBAMOYLPIRIDONE COMPOUNDS AND THEIR PHARMACEUTICAL USE
A61K 31/4985 (2006.01)	3466490	POLYCYCLIC-CARBAMOYLPIRIDONE COMPOUNDS AND THEIR PHARMACEUTICAL USE
A61K 31/5365 (2006.01)	3466490	POLYCYCLIC-CARBAMOYLPIRIDONE COMPOUNDS AND THEIR PHARMACEUTICAL USE
A61K 45/06 (2006.01)	3466490	POLYCYCLIC-CARBAMOYLPIRIDONE COMPOUNDS AND THEIR PHARMACEUTICAL USE
A61P 31/18 (2006.01)	3466490	POLYCYCLIC-CARBAMOYLPIRIDONE COMPOUNDS AND THEIR PHARMACEUTICAL USE
C07D 491/14 (2006.01)	3466490	POLYCYCLIC-CARBAMOYLPIRIDONE COMPOUNDS AND THEIR PHARMACEUTICAL USE
C07D 491/22 (2006.01)	3466490	POLYCYCLIC-CARBAMOYLPIRIDONE COMPOUNDS AND THEIR PHARMACEUTICAL USE
C07D 498/14 (2006.01)	3466490	POLYCYCLIC-CARBAMOYLPIRIDONE COMPOUNDS AND THEIR PHARMACEUTICAL USE
C07D 498/16 (2006.01)	3466490	POLYCYCLIC-CARBAMOYLPIRIDONE COMPOUNDS AND THEIR PHARMACEUTICAL USE
C07D 498/22 (2006.01)	3466490	POLYCYCLIC-CARBAMOYLPIRIDONE COMPOUNDS AND THEIR PHARMACEUTICAL USE
C07D 513/22 (2006.01)	3466490	POLYCYCLIC-CARBAMOYLPIRIDONE COMPOUNDS AND THEIR PHARMACEUTICAL USE
A61K 35/37 (2015.01)	3495385	VIRAL INACTIVATION USING IMPROVED SOLVENT-DETERGENT METHOD
A61L 2/00 (2006.01)	3495385	VIRAL INACTIVATION USING IMPROVED SOLVENT-DETERGENT METHOD
C07K 14/755 (2006.01)	3495385	VIRAL INACTIVATION USING IMPROVED SOLVENT-DETERGENT METHOD
A23B 5/005 (2006.01)	3491933	A METHOD OF MICROBIOLOGICAL SANITISATION OF THE SURFACE OF WHOLE EGGS IN SHELL
A23B 5/01 (2006.01)	3491933	A METHOD OF MICROBIOLOGICAL SANITISATION OF THE SURFACE OF WHOLE EGGS IN SHELL
A23L 3/005 (2006.01)	3491933	A METHOD OF MICROBIOLOGICAL SANITISATION OF THE SURFACE OF WHOLE EGGS IN SHELL
A23L 15/00 (2016.01)	3491933	A METHOD OF MICROBIOLOGICAL SANITISATION OF THE SURFACE OF WHOLE EGGS IN SHELL
G01V 5/00 (2006.01)	3483635	METHOD AND SYSTEM FOR USE IN PERFORMING SECURITY SCREENING
A61K 31/519 (2006.01)	3492472	DEUTERATED BARICITINIB WITH IMPROVED METABOLIC STABILITY AS JAK1 AND JAK2 KINASE INHIBITOR FOR TREATING

MKP	Broj objave evropske prijave patenta (97)	Naziv pronalaska (54)
(51)		(54)
A61P 17/06 (2006.01)	3492472	E.G. RHEUMATOID ARTHRITIS DEUTERATED BARICITINIB WITH IMPROVED METABOLIC STABILITY AS JAK1 AND JAK2 KINASE INHIBITOR FOR TREATING
A61P 19/02 (2006.01)	3492472	E.G. RHEUMATOID ARTHRITIS DEUTERATED BARICITINIB WITH IMPROVED METABOLIC STABILITY AS JAK1 AND JAK2 KINASE INHIBITOR FOR TREATING
C07B 59/00 (2006.01)	3492472	E.G. RHEUMATOID ARTHRITIS DEUTERATED BARICITINIB WITH IMPROVED METABOLIC STABILITY AS JAK1 AND JAK2 KINASE INHIBITOR FOR TREATING
C07D 471/04 (2006.01)	3492472	E.G. RHEUMATOID ARTHRITIS DEUTERATED BARICITINIB WITH IMPROVED METABOLIC STABILITY AS JAK1 AND JAK2 KINASE INHIBITOR FOR TREATING
C07D 487/04 (2006.01)	3492472	E.G. RHEUMATOID ARTHRITIS DEUTERATED BARICITINIB WITH IMPROVED METABOLIC STABILITY AS JAK1 AND JAK2 KINASE INHIBITOR FOR TREATING
C07D 498/16 (2006.01)	3486248	IMPROVED METHODS FOR THE ACYLATION OF MAYTANSINOL
C07D 498/18 (2006.01)	3486248	IMPROVED METHODS FOR THE ACYLATION OF MAYTANSINOL
A61P 35/00 (2006.01)	3489362	BIPARTITE AND TRIPARTITE SIGNALING IMMUNE CELLS
C12N 15/85 (2006.01)	3489362	BIPARTITE AND TRIPARTITE SIGNALING IMMUNE CELLS
A61K 31/135 (2006.01)	3501542	ESKETAMINE FOR THE TREATMENT OF DEPRESSION
A61K 45/06 (2006.01)	3501542	ESKETAMINE FOR THE TREATMENT OF DEPRESSION
A61P 25/24 (2006.01)	3501542	ESKETAMINE FOR THE TREATMENT OF DEPRESSION
A61K 9/00 (2006.01)	3558379	PHARMACEUTICAL DOSAGE FORMS CONTAINING TASK-1 AND TASK-3 CHANNEL INHIBITORS, AND THE USE OF SAME IN BREATHING DISORDER THERAPY
A61K 9/08 (2006.01)	3558379	PHARMACEUTICAL DOSAGE FORMS CONTAINING TASK-1 AND TASK-3 CHANNEL INHIBITORS, AND THE USE OF SAME IN BREATHING DISORDER THERAPY
A61K 31/496 (2006.01)	3558379	PHARMACEUTICAL DOSAGE FORMS CONTAINING TASK-1 AND TASK-3 CHANNEL INHIBITORS, AND THE USE OF SAME IN BREATHING DISORDER THERAPY
A61K 47/10 (2017.01)	3558379	PHARMACEUTICAL DOSAGE FORMS CONTAINING TASK-1 AND TASK-3 CHANNEL INHIBITORS, AND THE USE OF SAME IN BREATHING DISORDER THERAPY
A61K 31/437 (2006.01)	3558988	PYRAZOLO[3,4-B]PYRIDINES AND IMIDAZO[1,5-B]PYRIDAZINES AS PDE1 INHIBITORS
A61K 31/4985 (2006.01)	3558988	PYRAZOLO[3,4-B]PYRIDINES AND IMIDAZO[1,5-B]PYRIDAZINES AS PDE1 INHIBITORS
A61P 25/00 (2006.01)	3558988	PYRAZOLO[3,4-B]PYRIDINES AND IMIDAZO[1,5-B]PYRIDAZINES AS PDE1 INHIBITORS
A61P 25/16 (2006.01)	3558988	PYRAZOLO[3,4-B]PYRIDINES AND IMIDAZO[1,5-B]PYRIDAZINES AS PDE1 INHIBITORS
A61P 25/28 (2006.01)	3558988	PYRAZOLO[3,4-B]PYRIDINES AND IMIDAZO[1,5-B]PYRIDAZINES AS PDE1 INHIBITORS
C07D 471/04 (2006.01)	3558988	PYRAZOLO[3,4-B]PYRIDINES AND IMIDAZO[1,5-B]PYRIDAZINES AS PDE1 INHIBITORS
C07D 487/04 (2006.01)	3558988	PYRAZOLO[3,4-B]PYRIDINES AND IMIDAZO[1,5-B]PYRIDAZINES AS PDE1 INHIBITORS
C07D 519/00 (2006.01)	3558988	PYRAZOLO[3,4-B]PYRIDINES AND IMIDAZO[1,5-B]PYRIDAZINES AS PDE1 INHIBITORS
A61K 31/5375 (2006.01)	3558951	METHOD FOR THE MANUFACTURING OF DELMOPINOL
C07C 21/00 (2006.01)	3558951	METHOD FOR THE MANUFACTURING OF DELMOPINOL
C07D 265/30 (2006.01)	3558951	METHOD FOR THE MANUFACTURING OF DELMOPINOL
B30B 11/20 (2006.01)	3551444	DEVICE FOR PRODUCING PELLETS
C07K 1/14 (2006.01)	3555114	PROCESS FOR THE PURIFICATION OF LIPOPOLYPEPTIDE ANTIBIOTICS
C07K 7/08 (2006.01)	3555114	PROCESS FOR THE PURIFICATION OF LIPOPOLYPEPTIDE ANTIBIOTICS
C07K 7/56 (2006.01)	3555114	PROCESS FOR THE PURIFICATION OF LIPOPOLYPEPTIDE ANTIBIOTICS
G01R 15/26 (2006.01)	3552030	DEVICE FOR MEASURING A RADIOELECTRIC DOSE ON A SURFACE, IN PARTICULAR FOR MEASURING THE RADIOLOGICAL DOSE FOR A PATIENT DURING A RADIOLOGY OPERATION
G01R 29/08 (2006.01)	3552030	DEVICE FOR MEASURING A RADIOELECTRIC DOSE ON A SURFACE, IN PARTICULAR FOR MEASURING THE RADIOLOGICAL DOSE FOR A PATIENT DURING A RADIOLOGY OPERATION
C07K 14/47 (2006.01)	3551754	METHODS AND COMPOSITIONS FOR ENHANCING FUNCTIONAL

MKP	Broj objave evropske prijave patenta (97)	Naziv pronalaska (54)
(51)		(54)
C12N 15/10 (2006.01)	3551754	MYELIN PRODUCTION METHODS AND COMPOSITIONS FOR ENHANCING FUNCTIONAL MYELIN PRODUCTION
C12N 15/63 (2006.01)	3551754	METHODS AND COMPOSITIONS FOR ENHANCING FUNCTIONAL MYELIN PRODUCTION
C12N 15/864 (2006.01)	3551754	METHODS AND COMPOSITIONS FOR ENHANCING FUNCTIONAL MYELIN PRODUCTION
A61K 9/08 (2006.01)	3558380	PHARMACEUTICAL DOSAGE FORMS CONTAINING TASK-1 AND TASK-3 CHANNEL INHIBITORS, AND THE USE OF SAME IN BREATHING DISORDER THERAPY
A61K 31/496 (2006.01)	3558380	PHARMACEUTICAL DOSAGE FORMS CONTAINING TASK-1 AND TASK-3 CHANNEL INHIBITORS, AND THE USE OF SAME IN BREATHING DISORDER THERAPY
A61K 47/10 (2017.01)	3558380	PHARMACEUTICAL DOSAGE FORMS CONTAINING TASK-1 AND TASK-3 CHANNEL INHIBITORS, AND THE USE OF SAME IN BREATHING DISORDER THERAPY
E05F 11/38 (2006.01)	3555400	RAIL SLIDER FOR A CABLE-TYPE WINDOW LIFTER OF A MOTOR VEHICLE
E05F 11/48 (2006.01)	3555400	RAIL SLIDER FOR A CABLE-TYPE WINDOW LIFTER OF A MOTOR VEHICLE
C07C 21/04 (2006.01)	3558952	METHOD FOR THE MANUFACTURING OF DELMOPINOL INTERMEDIATES
C07C 21/17 (2006.01)	3558952	METHOD FOR THE MANUFACTURING OF DELMOPINOL INTERMEDIATES
C07D 265/30 (2006.01)	3558952	METHOD FOR THE MANUFACTURING OF DELMOPINOL INTERMEDIATES
A47K 3/28 (2006.01)	3555389	ANTI SEISMIC PROTECTION DEVICE
E03C 1/04 (2006.01)	3555389	ANTI SEISMIC PROTECTION DEVICE
E04H 1/12 (2006.01)	3555389	ANTI SEISMIC PROTECTION DEVICE
E04H 9/02 (2006.01)	3555389	ANTI SEISMIC PROTECTION DEVICE
A61K 31/5365 (2006.01)	3555105	7-PHENYLETHYLAMINO-4H-PYRIMIDO[4,5-D][1,3]OXAZIN-2-ONE COMPOUNDS AS MUTANT IDH1 AND IDH2 INHIBITORS
A61P 35/00 (2006.01)	3555105	7-PHENYLETHYLAMINO-4H-PYRIMIDO[4,5-D][1,3]OXAZIN-2-ONE COMPOUNDS AS MUTANT IDH1 AND IDH2 INHIBITORS
C07D 498/04 (2006.01)	3555105	7-PHENYLETHYLAMINO-4H-PYRIMIDO[4,5-D][1,3]OXAZIN-2-ONE COMPOUNDS AS MUTANT IDH1 AND IDH2 INHIBITORS
A61K 31/5355 (2006.01)	3555080	OXAZINE DERIVATIVES AS BETA-SECRETASE INHIBITORS AND METHODS OF USE
A61K 31/5377 (2006.01)	3555080	OXAZINE DERIVATIVES AS BETA-SECRETASE INHIBITORS AND METHODS OF USE
A61P 25/28 (2006.01)	3555080	OXAZINE DERIVATIVES AS BETA-SECRETASE INHIBITORS AND METHODS OF USE
C07D 265/08 (2006.01)	3555080	OXAZINE DERIVATIVES AS BETA-SECRETASE INHIBITORS AND METHODS OF USE
C07D 265/12 (2006.01)	3555080	OXAZINE DERIVATIVES AS BETA-SECRETASE INHIBITORS AND METHODS OF USE
C07D 265/30 (2006.01)	3555080	OXAZINE DERIVATIVES AS BETA-SECRETASE INHIBITORS AND METHODS OF USE
C07D 413/10 (2006.01)	3555080	OXAZINE DERIVATIVES AS BETA-SECRETASE INHIBITORS AND METHODS OF USE
A61K 31/541 (2006.01)	3555084	THIAZINE DERIVATIVES AS BETA-SECRETASE INHIBITORS AND METHODS OF USE
A61P 25/00 (2006.01)	3555084	THIAZINE DERIVATIVES AS BETA-SECRETASE INHIBITORS AND METHODS OF USE
A61P 25/28 (2006.01)	3555084	THIAZINE DERIVATIVES AS BETA-SECRETASE INHIBITORS AND METHODS OF USE
C07D 417/10 (2006.01)	3555084	THIAZINE DERIVATIVES AS BETA-SECRETASE INHIBITORS AND METHODS OF USE
A61K 31/5365 (2006.01)	3555106	BICYCLIC THIAZINE AND OXAZINE DERIVATIVES AS BETA-SECRETASE INHIBITORS AND METHODS OF USE
A61K 31/542 (2006.01)	3555106	BICYCLIC THIAZINE AND OXAZINE DERIVATIVES AS BETA-SECRETASE INHIBITORS AND METHODS OF USE
A61P 25/00 (2006.01)	3555106	BICYCLIC THIAZINE AND OXAZINE DERIVATIVES AS BETA-SECRETASE INHIBITORS AND METHODS OF USE
A61P 25/28 (2006.01)	3555106	BICYCLIC THIAZINE AND OXAZINE DERIVATIVES AS BETA-SECRETASE INHIBITORS AND METHODS OF USE
C07D 498/04 (2006.01)	3555106	BICYCLIC THIAZINE AND OXAZINE DERIVATIVES AS BETA-SECRETASE INHIBITORS AND METHODS OF USE

MKP (51)	Broj objave evropske prijave patenta (97)	Naziv pronalaska (54)
C07D 513/04 (2006.01)	3555106	BICYCLIC THIAZINE AND OXAZINE DERIVATIVES AS BETA-SECRETASE INHIBITORS AND METHODS OF USE
A61K 31/5415 (2006.01)	3555085	CYCLOPROPYL FUSED THIAZINE DERIVATIVES AS BETA-SECRETASE INHIBITORS AND METHODS OF USE
A61P 25/28 (2006.01)	3555085	CYCLOPROPYL FUSED THIAZINE DERIVATIVES AS BETA-SECRETASE INHIBITORS AND METHODS OF USE
C07D 279/08 (2006.01)	3555085	CYCLOPROPYL FUSED THIAZINE DERIVATIVES AS BETA-SECRETASE INHIBITORS AND METHODS OF USE
C07D 417/10 (2006.01)	3555085	CYCLOPROPYL FUSED THIAZINE DERIVATIVES AS BETA-SECRETASE INHIBITORS AND METHODS OF USE
C07D 417/14 (2006.01)	3555085	CYCLOPROPYL FUSED THIAZINE DERIVATIVES AS BETA-SECRETASE INHIBITORS AND METHODS OF USE
A61K 31/54 (2006.01)	3555086	1,4-THIAZINE DIOXIDE AND 1,2,4-THIADIAZINE DIOXIDE DERIVATIVES AS BETA-SECRETASE INHIBITORS AND METHODS OF USE
A61P 25/28 (2006.01)	3555086	1,4-THIAZINE DIOXIDE AND 1,2,4-THIADIAZINE DIOXIDE DERIVATIVES AS BETA-SECRETASE INHIBITORS AND METHODS OF USE
C07D 417/10 (2006.01)	3555086	1,4-THIAZINE DIOXIDE AND 1,2,4-THIADIAZINE DIOXIDE DERIVATIVES AS BETA-SECRETASE INHIBITORS AND METHODS OF USE
C07D 417/14 (2006.01)	3555086	1,4-THIAZINE DIOXIDE AND 1,2,4-THIADIAZINE DIOXIDE DERIVATIVES AS BETA-SECRETASE INHIBITORS AND METHODS OF USE
C07D 471/04 (2006.01)	3555086	1,4-THIAZINE DIOXIDE AND 1,2,4-THIADIAZINE DIOXIDE DERIVATIVES AS BETA-SECRETASE INHIBITORS AND METHODS OF USE
C07D 491/056 (2006.01)	3555086	1,4-THIAZINE DIOXIDE AND 1,2,4-THIADIAZINE DIOXIDE DERIVATIVES AS BETA-SECRETASE INHIBITORS AND METHODS OF USE
C07D 498/08 (2006.01)	3555086	1,4-THIAZINE DIOXIDE AND 1,2,4-THIADIAZINE DIOXIDE DERIVATIVES AS BETA-SECRETASE INHIBITORS AND METHODS OF USE
C07D 513/04 (2006.01)	3555086	1,4-THIAZINE DIOXIDE AND 1,2,4-THIADIAZINE DIOXIDE DERIVATIVES AS BETA-SECRETASE INHIBITORS AND METHODS OF USE
A61K 31/4184 (2006.01)	3555066	BENZIMIDAZOLE COMPOUNDS AS C-KIT INHIBITORS
A61P 11/06 (2006.01)	3555066	BENZIMIDAZOLE COMPOUNDS AS C-KIT INHIBITORS
A61P 35/00 (2006.01)	3555066	BENZIMIDAZOLE COMPOUNDS AS C-KIT INHIBITORS
C07D 235/08 (2006.01)	3555066	BENZIMIDAZOLE COMPOUNDS AS C-KIT INHIBITORS
C07D 401/12 (2006.01)	3555066	BENZIMIDAZOLE COMPOUNDS AS C-KIT INHIBITORS
C07D 401/14 (2006.01)	3555066	BENZIMIDAZOLE COMPOUNDS AS C-KIT INHIBITORS
C07D 403/04 (2006.01)	3555066	BENZIMIDAZOLE COMPOUNDS AS C-KIT INHIBITORS
F24F 3/00 (2006.01)	3563094	FACILITY FOR PRODUCING AND TREATING A GAS STREAM THROUGH A VOLUME OF LIQUID
F24F 3/14 (2006.01)	3563094	FACILITY FOR PRODUCING AND TREATING A GAS STREAM THROUGH A VOLUME OF LIQUID
F24F 3/16 (2006.01)	3563094	FACILITY FOR PRODUCING AND TREATING A GAS STREAM THROUGH A VOLUME OF LIQUID
F24F 5/00 (2006.01)	3563094	FACILITY FOR PRODUCING AND TREATING A GAS STREAM THROUGH A VOLUME OF LIQUID
F24F 6/00 (2006.01)	3563094	FACILITY FOR PRODUCING AND TREATING A GAS STREAM THROUGH A VOLUME OF LIQUID
F28C 3/06 (2006.01)	3563094	FACILITY FOR PRODUCING AND TREATING A GAS STREAM THROUGH A VOLUME OF LIQUID
A61K 39/12 (2006.01)	3554536	RECOMBINANT HVT VECTORS EXPRESSING MULTIPLE ANTIGENS OF AVIAN PATHOGENS, AND VACCINES COMPRISING THEM
A61K 39/155 (2006.01)	3554536	RECOMBINANT HVT VECTORS EXPRESSING MULTIPLE ANTIGENS OF AVIAN PATHOGENS, AND VACCINES COMPRISING THEM
A61K 39/245 (2006.01)	3554536	RECOMBINANT HVT VECTORS EXPRESSING MULTIPLE ANTIGENS OF AVIAN PATHOGENS, AND VACCINES COMPRISING THEM
A61K 39/295 (2006.01)	3554536	RECOMBINANT HVT VECTORS EXPRESSING MULTIPLE ANTIGENS OF AVIAN PATHOGENS, AND VACCINES COMPRISING THEM
C07K 14/03 (2006.01)	3554536	RECOMBINANT HVT VECTORS EXPRESSING MULTIPLE

MKP	Broj objave evropske prijave patenta (97)	Naziv pronalaska (54)
(51)		
C07K 14/08 (2006.01)	3554536	ANTIGENS OF AVIAN PATHOGENS, AND VACCINES COMPRISING THEM RECOMBINANT HVT VECTORS EXPRESSING MULTIPLE ANTIGENS OF AVIAN PATHOGENS, AND VACCINES COMPRISING THEM
C12N 7/00 (2006.01)	3554536	RECOMBINANT HVT VECTORS EXPRESSING MULTIPLE ANTIGENS OF AVIAN PATHOGENS, AND VACCINES COMPRISING THEM
A61K 39/395 (2006.01)	3555129	GREMLIN-1 CRYSTAL STRUCTURE AND INHIBITORY ANTIBODY
C07K 16/22 (2006.01)	3555129	GREMLIN-1 CRYSTAL STRUCTURE AND INHIBITORY ANTIBODY
B29C 45/17 (2006.01)	3558622	METHOD FOR THE INJECTION MOLDING OF INTERNALLY HOLLOW PARTS
C07K 14/725 (2006.01)	3551653	T CELL RECEPTORS WITH IMPROVED PAIRING
C12N 15/09 (2006.01)	3551653	T CELL RECEPTORS WITH IMPROVED PAIRING
C07K 14/725 (2006.01)	3551654	NOVEL T CELL RECEPTORS AND IMMUNE THERAPY USING THE SAME
C07K 16/30 (2006.01)	3551654	NOVEL T CELL RECEPTORS AND IMMUNE THERAPY USING THE SAME
A61K 31/437 (2006.01)	3555094	BICYCLIC OGA INHIBITOR COMPOUNDS
A61P 25/00 (2006.01)	3555094	BICYCLIC OGA INHIBITOR COMPOUNDS
C07D 471/04 (2006.01)	3555094	BICYCLIC OGA INHIBITOR COMPOUNDS
C07D 493/04 (2006.01)	3555094	BICYCLIC OGA INHIBITOR COMPOUNDS
A61K 31/522 (2006.01)	3558997	AMINO-TRIAZOLOPYRIDINE COMPOUNDS AND THEIR USE IN TREATING CANCER
A61P 35/00 (2006.01)	3558997	AMINO-TRIAZOLOPYRIDINE COMPOUNDS AND THEIR USE IN TREATING CANCER
C07D 473/18 (2006.01)	3558997	AMINO-TRIAZOLOPYRIDINE COMPOUNDS AND THEIR USE IN TREATING CANCER
C07D 519/00 (2006.01)	3558997	AMINO-TRIAZOLOPYRIDINE COMPOUNDS AND THEIR USE IN TREATING CANCER
C01F 11/18 (2006.01)	3573928	PROCESS FOR THE PREPARATION OF FRAGMENTED NATURAL CALCIUM CARBONATE WITH A REDUCED CONTENT OF IMPURITIES AND PRODUCTS OBTAINED THEREOF
C09C 1/02 (2006.01)	3573928	PROCESS FOR THE PREPARATION OF FRAGMENTED NATURAL CALCIUM CARBONATE WITH A REDUCED CONTENT OF IMPURITIES AND PRODUCTS OBTAINED THEREOF
A61L 9/12 (2006.01)	3562519	PERFUME TESTERS
C10J 3/26 (2006.01)	3551733	SYSTEM FOR TRANSFORMING AN ORGANIC MATERIAL INTO SYNGAS
C10J 3/30 (2006.01)	3551733	SYSTEM FOR TRANSFORMING AN ORGANIC MATERIAL INTO SYNGAS
C10J 3/36 (2006.01)	3551733	SYSTEM FOR TRANSFORMING AN ORGANIC MATERIAL INTO SYNGAS
C10J 3/86 (2006.01)	3551733	SYSTEM FOR TRANSFORMING AN ORGANIC MATERIAL INTO SYNGAS
C10K 1/04 (2006.01)	3551733	SYSTEM FOR TRANSFORMING AN ORGANIC MATERIAL INTO SYNGAS
A61K 31/437 (2006.01)	3555096	IMIDAZOPYRROLOPYRIDINE AS INHIBITORS OF THE JAK FAMILY OF KINASES
A61P 35/00 (2006.01)	3555096	IMIDAZOPYRROLOPYRIDINE AS INHIBITORS OF THE JAK FAMILY OF KINASES
A61P 37/00 (2006.01)	3555096	IMIDAZOPYRROLOPYRIDINE AS INHIBITORS OF THE JAK FAMILY OF KINASES
C07D 471/14 (2006.01)	3555096	IMIDAZOPYRROLOPYRIDINE AS INHIBITORS OF THE JAK FAMILY OF KINASES
A61K 31/415 (2006.01)	3558960	CARBOXYLIC ACID AROMATIC AMIDES AS ANTAGONISTS OF BRADYKININ B1 RECEPTOR
A61P 29/00 (2006.01)	3558960	CARBOXYLIC ACID AROMATIC AMIDES AS ANTAGONISTS OF BRADYKININ B1 RECEPTOR
C07D 213/56 (2006.01)	3558960	CARBOXYLIC ACID AROMATIC AMIDES AS ANTAGONISTS OF BRADYKININ B1 RECEPTOR
C07D 231/12 (2006.01)	3558960	CARBOXYLIC ACID AROMATIC AMIDES AS ANTAGONISTS OF BRADYKININ B1 RECEPTOR
C07D 231/56 (2006.01)	3558960	CARBOXYLIC ACID AROMATIC AMIDES AS ANTAGONISTS OF BRADYKININ B1 RECEPTOR
C07D 233/64 (2006.01)	3558960	CARBOXYLIC ACID AROMATIC AMIDES AS ANTAGONISTS OF BRADYKININ B1 RECEPTOR
C07D 241/12 (2006.01)	3558960	CARBOXYLIC ACID AROMATIC AMIDES AS ANTAGONISTS OF

MKP	Broj objave evropske prijave patenta (97)	Naziv pronalaska (54)
(51)		(54)
C07D 277/56 (2006.01)	3558960	BRADYKININ B1 RECEPTOR
C07D 333/28 (2006.01)	3558960	CARBOXYLIC ACID AROMATIC AMIDES AS ANTAGONISTS OF BRADYKININ B1 RECEPTOR
C07D 333/38 (2006.01)	3558960	CARBOXYLIC ACID AROMATIC AMIDES AS ANTAGONISTS OF BRADYKININ B1 RECEPTOR
C07D 333/58 (2006.01)	3558960	CARBOXYLIC ACID AROMATIC AMIDES AS ANTAGONISTS OF BRADYKININ B1 RECEPTOR
C07D 495/04 (2006.01)	3558960	CARBOXYLIC ACID AROMATIC AMIDES AS ANTAGONISTS OF BRADYKININ B1 RECEPTOR
C07C 211/63 (2006.01)	3555325	SEPARATION OF RARE EARTH METALS
C22B 3/26 (2006.01)	3555325	SEPARATION OF RARE EARTH METALS
C22B 59/00 (2006.01)	3555325	SEPARATION OF RARE EARTH METALS
A61K 31/455 (2006.01)	3551622	MODULATOR OF CYSTIC FIBROSIS TRANSMEMBRANE CONDUCTANCE REGULATOR, PHARMACEUTICAL COMPOSITIONS, METHODS OF TREATMENT, AND PROCESS FOR MAKING THE MODULATOR
A61P 11/00 (2006.01)	3551622	MODULATOR OF CYSTIC FIBROSIS TRANSMEMBRANE CONDUCTANCE REGULATOR, PHARMACEUTICAL COMPOSITIONS, METHODS OF TREATMENT, AND PROCESS FOR MAKING THE MODULATOR
C07D 231/20 (2006.01)	3551622	MODULATOR OF CYSTIC FIBROSIS TRANSMEMBRANE CONDUCTANCE REGULATOR, PHARMACEUTICAL COMPOSITIONS, METHODS OF TREATMENT, AND PROCESS FOR MAKING THE MODULATOR
C07D 401/04 (2006.01)	3551622	MODULATOR OF CYSTIC FIBROSIS TRANSMEMBRANE CONDUCTANCE REGULATOR, PHARMACEUTICAL COMPOSITIONS, METHODS OF TREATMENT, AND PROCESS FOR MAKING THE MODULATOR
C07D 401/14 (2006.01)	3551622	MODULATOR OF CYSTIC FIBROSIS TRANSMEMBRANE CONDUCTANCE REGULATOR, PHARMACEUTICAL COMPOSITIONS, METHODS OF TREATMENT, AND PROCESS FOR MAKING THE MODULATOR
A61K 47/64 (2017.01)	3554552	EXON SKIPPING OLIGOMER CONJUGATES FOR MUSCULAR DYSTROPHY
A61P 21/00 (2006.01)	3554552	EXON SKIPPING OLIGOMER CONJUGATES FOR MUSCULAR DYSTROPHY
C07C 201/08 (2006.01)	3555039	METHOD AND SYSTEM FOR ADIABATIC NITRIDING OF AROMATES
C07C 205/06 (2006.01)	3555039	METHOD AND SYSTEM FOR ADIABATIC NITRIDING OF AROMATES
C12Q 1/68 (2018.01)	3555307	METHODS OF DETERMINING COLORECTAL CANCER STATUS IN AN INDIVIDUAL
A61K 31/519 (2006.01)	3558999	BICYCLIC DIHYDROPYRIMIDINE-CARBOXAMIDE DERIVATIVES AS RHO-KINASE INHIBITORS
A61P 11/00 (2006.01)	3558999	BICYCLIC DIHYDROPYRIMIDINE-CARBOXAMIDE DERIVATIVES AS RHO-KINASE INHIBITORS
A61P 37/00 (2006.01)	3558999	BICYCLIC DIHYDROPYRIMIDINE-CARBOXAMIDE DERIVATIVES AS RHO-KINASE INHIBITORS
C07D 487/04 (2006.01)	3558999	BICYCLIC DIHYDROPYRIMIDINE-CARBOXAMIDE DERIVATIVES AS RHO-KINASE INHIBITORS
A23L 33/135 (2016.01)	3554522	PROBIOTICS FOR USE IN THE TREATMENT OF DIVERTICULOSIS AND DIVERTICULAR DISEASE
A61K 9/00 (2006.01)	3554522	PROBIOTICS FOR USE IN THE TREATMENT OF DIVERTICULOSIS AND DIVERTICULAR DISEASE
A61K 9/14 (2006.01)	3554522	PROBIOTICS FOR USE IN THE TREATMENT OF DIVERTICULOSIS AND DIVERTICULAR DISEASE
A61K 9/20 (2006.01)	3554522	PROBIOTICS FOR USE IN THE TREATMENT OF DIVERTICULOSIS AND DIVERTICULAR DISEASE
A61K 35/741 (2015.01)	3554522	PROBIOTICS FOR USE IN THE TREATMENT OF DIVERTICULOSIS AND DIVERTICULAR DISEASE
A61K 35/744 (2015.01)	3554522	PROBIOTICS FOR USE IN THE TREATMENT OF DIVERTICULOSIS AND DIVERTICULAR DISEASE
A61K 35/745 (2015.01)	3554522	PROBIOTICS FOR USE IN THE TREATMENT OF DIVERTICULOSIS AND DIVERTICULAR DISEASE
A61K 35/747 (2015.01)	3554522	PROBIOTICS FOR USE IN THE TREATMENT OF DIVERTICULOSIS AND DIVERTICULAR DISEASE
A61K 36/06 (2006.01)	3554522	PROBIOTICS FOR USE IN THE TREATMENT OF DIVERTICULOSIS AND DIVERTICULAR DISEASE

MKP	Broj objave evropske prijave patenta	Naziv pronalaska
(51)	(97)	(54)
A61P 1/00 (2006.01)	3554522	PROBIOTICS FOR USE IN THE TREATMENT OF DIVERTICULOSIS AND DIVERTICULAR DISEASE
A61K 47/68 (2017.01)	3558389	ANTIBODY DRUG CONJUGATES FOR ABLATING HEMATOPOIETIC STEM CELLS
A61P 43/00 (2006.01)	3558389	ANTIBODY DRUG CONJUGATES FOR ABLATING HEMATOPOIETIC STEM CELLS
C07K 16/28 (2006.01)	3558389	ANTIBODY DRUG CONJUGATES FOR ABLATING HEMATOPOIETIC STEM CELLS
A61K 31/427 (2006.01)	3555090	AMINOTHIAZOLE COMPOUNDS AS C-KIT INHIBITORS
A61P 35/00 (2006.01)	3555090	AMINOTHIAZOLE COMPOUNDS AS C-KIT INHIBITORS
C07D 277/44 (2006.01)	3555090	AMINOTHIAZOLE COMPOUNDS AS C-KIT INHIBITORS
C07D 417/12 (2006.01)	3555090	AMINOTHIAZOLE COMPOUNDS AS C-KIT INHIBITORS
A23L 33/175 (2016.01)	3554492	AMINO ACID COMPOSITIONS AND METHODS FOR THE TREATMENT OF LIVER DISEASES
A23L 33/18 (2016.01)	3554492	AMINO ACID COMPOSITIONS AND METHODS FOR THE TREATMENT OF LIVER DISEASES
A61K 31/198 (2006.01)	3554492	AMINO ACID COMPOSITIONS AND METHODS FOR THE TREATMENT OF LIVER DISEASES
A61P 1/16 (2006.01)	3554492	AMINO ACID COMPOSITIONS AND METHODS FOR THE TREATMENT OF LIVER DISEASES
A61K 31/352 (2006.01)	3558982	DEUTERATED CFTR MODULATORS AND METHODS OF USE
A61P 11/00 (2006.01)	3558982	DEUTERATED CFTR MODULATORS AND METHODS OF USE
A61P 11/12 (2006.01)	3558982	DEUTERATED CFTR MODULATORS AND METHODS OF USE
C07D 407/12 (2006.01)	3558982	DEUTERATED CFTR MODULATORS AND METHODS OF USE
A61K 39/395 (2006.01)	3558361	MYOSTATIN, ACTIVIN OR ACTIVIN RECEPTOR ANTAGONISTS FOR USE IN TREATING OBESITY AND RELATED CONDITIONS
A61K 45/00 (2006.01)	3558361	MYOSTATIN, ACTIVIN OR ACTIVIN RECEPTOR ANTAGONISTS FOR USE IN TREATING OBESITY AND RELATED CONDITIONS
A61P 3/04 (2006.01)	3558361	MYOSTATIN, ACTIVIN OR ACTIVIN RECEPTOR ANTAGONISTS FOR USE IN TREATING OBESITY AND RELATED CONDITIONS
A61P 35/00 (2006.01)	3558968	IMIDAZOPYRAZINE INHIBITORS OF BRUTON'S TYROSINE KINASE
A61P 37/00 (2006.01)	3558968	IMIDAZOPYRAZINE INHIBITORS OF BRUTON'S TYROSINE KINASE
C07D 401/12 (2006.01)	3558968	IMIDAZOPYRAZINE INHIBITORS OF BRUTON'S TYROSINE KINASE
A61K 31/444 (2006.01)	3551617	COMPOSITIONS AND METHODS RELATED TO PYRIDINOYLPIPERIDINE 5-HT _{1F} AGONISTS
A61P 25/06 (2006.01)	3551617	COMPOSITIONS AND METHODS RELATED TO PYRIDINOYLPIPERIDINE 5-HT _{1F} AGONISTS
C07D 401/06 (2006.01)	3551617	COMPOSITIONS AND METHODS RELATED TO PYRIDINOYLPIPERIDINE 5-HT _{1F} AGONISTS
B32B 5/02 (2006.01)	3554822	PLASTER BOARDS AND METHODS FOR MAKING THEM
B32B 5/20 (2006.01)	3554822	PLASTER BOARDS AND METHODS FOR MAKING THEM
B32B 5/26 (2006.01)	3554822	PLASTER BOARDS AND METHODS FOR MAKING THEM
B32B 13/02 (2006.01)	3554822	PLASTER BOARDS AND METHODS FOR MAKING THEM
B32B 13/04 (2006.01)	3554822	PLASTER BOARDS AND METHODS FOR MAKING THEM
B32B 13/08 (2006.01)	3554822	PLASTER BOARDS AND METHODS FOR MAKING THEM
B32B 13/14 (2006.01)	3554822	PLASTER BOARDS AND METHODS FOR MAKING THEM
B32B 27/28 (2006.01)	3554822	PLASTER BOARDS AND METHODS FOR MAKING THEM
B32B 27/30 (2006.01)	3554822	PLASTER BOARDS AND METHODS FOR MAKING THEM
B32B 29/00 (2006.01)	3554822	PLASTER BOARDS AND METHODS FOR MAKING THEM
B32B 29/02 (2006.01)	3554822	PLASTER BOARDS AND METHODS FOR MAKING THEM
C04B 2/02 (2006.01)	3554822	PLASTER BOARDS AND METHODS FOR MAKING THEM
C04B 2/04 (2006.01)	3554822	PLASTER BOARDS AND METHODS FOR MAKING THEM
C04B 28/14 (2006.01)	3554822	PLASTER BOARDS AND METHODS FOR MAKING THEM
E04C 2/04 (2006.01)	3554822	PLASTER BOARDS AND METHODS FOR MAKING THEM
A61K 31/519 (2006.01)	3555070	AMINE-SUBSTITUTED HETEROCYCLIC COMPOUNDS AS EHMT2 INHIBITORS AND METHODS OF USE THEREOF
A61P 35/00 (2006.01)	3555070	AMINE-SUBSTITUTED HETEROCYCLIC COMPOUNDS AS EHMT2 INHIBITORS AND METHODS OF USE THEREOF
C07D 403/12 (2006.01)	3555070	AMINE-SUBSTITUTED HETEROCYCLIC COMPOUNDS AS EHMT2 INHIBITORS AND METHODS OF USE THEREOF
C07D 403/14 (2006.01)	3555070	AMINE-SUBSTITUTED HETEROCYCLIC COMPOUNDS AS EHMT2 INHIBITORS AND METHODS OF USE THEREOF
C07D 413/12 (2006.01)	3555070	AMINE-SUBSTITUTED HETEROCYCLIC COMPOUNDS AS EHMT2 INHIBITORS AND METHODS OF USE THEREOF
C07D 471/04 (2006.01)	3555070	AMINE-SUBSTITUTED HETEROCYCLIC COMPOUNDS AS EHMT2 INHIBITORS AND METHODS OF USE THEREOF
C07D 487/04 (2006.01)	3555070	AMINE-SUBSTITUTED HETEROCYCLIC COMPOUNDS AS EHMT2 INHIBITORS AND METHODS OF USE THEREOF

MKP	Broj objave evropske prijave patenta (97)	Naziv pronalaska (54)
(51)		
C07D 491/04 (2006.01)	3555070	AMINE-SUBSTITUTED HETEROCYCLIC COMPOUNDS AS EHMT2 INHIBITORS AND METHODS OF USE THEREOF
C07D 491/14 (2006.01)	3555070	AMINE-SUBSTITUTED HETEROCYCLIC COMPOUNDS AS EHMT2 INHIBITORS AND METHODS OF USE THEREOF
C07D 498/04 (2006.01)	3555070	AMINE-SUBSTITUTED HETEROCYCLIC COMPOUNDS AS EHMT2 INHIBITORS AND METHODS OF USE THEREOF
A61K 31/675 (2006.01)	3559011	ANTIVIRAL ALIPHATIC ESTER PRODRUGS OF TENOFOVIR
A61P 31/18 (2006.01)	3559011	ANTIVIRAL ALIPHATIC ESTER PRODRUGS OF TENOFOVIR
C07F 9/6561 (2006.01)	3559011	ANTIVIRAL ALIPHATIC ESTER PRODRUGS OF TENOFOVIR
A61K 31/437 (2006.01)	3558989	TRIAZOLO[1,5-A]PYRIDINE DERIVATIVES AS IMMUNOMODULATORS
A61P 37/00 (2006.01)	3558989	TRIAZOLO[1,5-A]PYRIDINE DERIVATIVES AS IMMUNOMODULATORS
C07D 471/04 (2006.01)	3558989	TRIAZOLO[1,5-A]PYRIDINE DERIVATIVES AS IMMUNOMODULATORS
A61K 31/69 (2006.01)	3559009	COMPOSITIONS AND METHODS FOR INHIBITING ARGINASE ACTIVITY
A61P 35/00 (2006.01)	3559009	COMPOSITIONS AND METHODS FOR INHIBITING ARGINASE ACTIVITY
C07F 5/02 (2006.01)	3559009	COMPOSITIONS AND METHODS FOR INHIBITING ARGINASE ACTIVITY
A61K 39/00 (2006.01)	3551221	NOVEL T CELL RECEPTORS AND IMMUNE THERAPY USING THE SAME
C07K 14/47 (2006.01)	3551221	NOVEL T CELL RECEPTORS AND IMMUNE THERAPY USING THE SAME
C07K 14/725 (2006.01)	3551221	NOVEL T CELL RECEPTORS AND IMMUNE THERAPY USING THE SAME
A61K 31/407 (2006.01)	3559003	CRYSTALLINE FORMS OF A JANUS KINASE INHIBITOR
A61K 31/519 (2006.01)	3559003	CRYSTALLINE FORMS OF A JANUS KINASE INHIBITOR
A61P 17/06 (2006.01)	3559003	CRYSTALLINE FORMS OF A JANUS KINASE INHIBITOR
A61P 17/14 (2006.01)	3559003	CRYSTALLINE FORMS OF A JANUS KINASE INHIBITOR
C07D 487/10 (2006.01)	3559003	CRYSTALLINE FORMS OF A JANUS KINASE INHIBITOR
A61K 39/00 (2006.01)	3551662	ANTI-TIM-3 ANTIBODIES FOR COMBINATION WITH ANTI-PD-1 ANTIBODIES
A61P 35/00 (2006.01)	3551662	ANTI-TIM-3 ANTIBODIES FOR COMBINATION WITH ANTI-PD-1 ANTIBODIES
C07K 16/28 (2006.01)	3551662	ANTI-TIM-3 ANTIBODIES FOR COMBINATION WITH ANTI-PD-1 ANTIBODIES
A61K 31/4375 (2006.01)	3558963	BICYCLIC HETEROAROMATIC COMPOUNDS AS IMMUNOMODULATORS
A61K 31/519 (2006.01)	3558963	BICYCLIC HETEROAROMATIC COMPOUNDS AS IMMUNOMODULATORS
A61P 37/00 (2006.01)	3558963	BICYCLIC HETEROAROMATIC COMPOUNDS AS IMMUNOMODULATORS
C07D 401/04 (2006.01)	3558963	BICYCLIC HETEROAROMATIC COMPOUNDS AS IMMUNOMODULATORS
C07D 519/00 (2006.01)	3558963	BICYCLIC HETEROAROMATIC COMPOUNDS AS IMMUNOMODULATORS
A61K 31/4035 (2006.01)	3558981	PYRAN DERIVATIVES AS CYP11A1 (CYTOCHROME P450 MONOOXYGENASE 11A1) INHIBITORS
A61K 31/4155 (2006.01)	3558981	PYRAN DERIVATIVES AS CYP11A1 (CYTOCHROME P450 MONOOXYGENASE 11A1) INHIBITORS
A61K 31/4709 (2006.01)	3558981	PYRAN DERIVATIVES AS CYP11A1 (CYTOCHROME P450 MONOOXYGENASE 11A1) INHIBITORS
A61P 35/00 (2006.01)	3558981	PYRAN DERIVATIVES AS CYP11A1 (CYTOCHROME P450 MONOOXYGENASE 11A1) INHIBITORS
C07D 405/06 (2006.01)	3558981	PYRAN DERIVATIVES AS CYP11A1 (CYTOCHROME P450 MONOOXYGENASE 11A1) INHIBITORS
C07D 405/14 (2006.01)	3558981	PYRAN DERIVATIVES AS CYP11A1 (CYTOCHROME P450 MONOOXYGENASE 11A1) INHIBITORS
C07D 409/14 (2006.01)	3558981	PYRAN DERIVATIVES AS CYP11A1 (CYTOCHROME P450 MONOOXYGENASE 11A1) INHIBITORS
C07D 413/14 (2006.01)	3558981	PYRAN DERIVATIVES AS CYP11A1 (CYTOCHROME P450 MONOOXYGENASE 11A1) INHIBITORS
C07D 417/14 (2006.01)	3558981	PYRAN DERIVATIVES AS CYP11A1 (CYTOCHROME P450 MONOOXYGENASE 11A1) INHIBITORS
C07D 451/02 (2006.01)	3558981	PYRAN DERIVATIVES AS CYP11A1 (CYTOCHROME P450 MONOOXYGENASE 11A1) INHIBITORS

MKP	Broj objave evropske prijave patenta (97)	Naziv pronalaska (54)
(51)		(54)
A61K 31/70 (2006.01)	3558459	COMPOSITION FOR USE IN THE TREATMENT OF DISORDERS OF THE UROGENITAL APPARATUS
A61K 36/45 (2006.01)	3558459	COMPOSITION FOR USE IN THE TREATMENT OF DISORDERS OF THE UROGENITAL APPARATUS
A61K 36/63 (2006.01)	3558459	COMPOSITION FOR USE IN THE TREATMENT OF DISORDERS OF THE UROGENITAL APPARATUS
A61P 13/10 (2006.01)	3558459	COMPOSITION FOR USE IN THE TREATMENT OF DISORDERS OF THE UROGENITAL APPARATUS
A61P 31/04 (2006.01)	3558459	COMPOSITION FOR USE IN THE TREATMENT OF DISORDERS OF THE UROGENITAL APPARATUS
A61K 47/64 (2017.01)	3554553	EXON SKIPPING OLIGOMER CONJUGATES FOR MUSCULAR DYSTROPHY
A61P 21/00 (2006.01)	3554553	EXON SKIPPING OLIGOMER CONJUGATES FOR MUSCULAR DYSTROPHY
A61K 47/64 (2017.01)	3554554	EXON SKIPPING OLIGOMER CONJUGATES FOR MUSCULAR DYSTROPHY
A61P 21/00 (2006.01)	3554554	EXON SKIPPING OLIGOMER CONJUGATES FOR MUSCULAR DYSTROPHY
A61K 31/713 (2006.01)	3555292	METHODS FOR TREATING OR PREVENTING TTR-ASSOCIATED DISEASES USING TRANSTHYRETIN (TTR) IRNA COMPOSITIONS
C07H 21/02 (2006.01)	3555292	METHODS FOR TREATING OR PREVENTING TTR-ASSOCIATED DISEASES USING TRANSTHYRETIN (TTR) IRNA COMPOSITIONS
C12N 15/113 (2010.01)	3555292	METHODS FOR TREATING OR PREVENTING TTR-ASSOCIATED DISEASES USING TRANSTHYRETIN (TTR) IRNA COMPOSITIONS
A61K 9/00 (2006.01)	3558363	ANTI-TNF ALPHA ANTIBODY FORMULATIONS
A61K 9/08 (2006.01)	3558363	ANTI-TNF ALPHA ANTIBODY FORMULATIONS
A61K 39/395 (2006.01)	3558363	ANTI-TNF ALPHA ANTIBODY FORMULATIONS
C07K 16/24 (2006.01)	3558363	ANTI-TNF ALPHA ANTIBODY FORMULATIONS
A61K 31/13 (2006.01)	3551178	MARKERS FOR PERSONALIZED CANCER TREATMENT WITH LSD1 INHIBITORS
A61K 31/16 (2006.01)	3551178	MARKERS FOR PERSONALIZED CANCER TREATMENT WITH LSD1 INHIBITORS
A61K 31/20 (2006.01)	3551178	MARKERS FOR PERSONALIZED CANCER TREATMENT WITH LSD1 INHIBITORS
A61K 31/345 (2006.01)	3551178	MARKERS FOR PERSONALIZED CANCER TREATMENT WITH LSD1 INHIBITORS
A61P 35/00 (2006.01)	3551178	MARKERS FOR PERSONALIZED CANCER TREATMENT WITH LSD1 INHIBITORS
C07K 14/71 (2006.01)	3562840	STABILIZED PROTEOLYTICALLY ACTIVATED GROWTH DIFFERENTIATION FACTOR 11
A61K 31/428 (2006.01)	3558955	BENZISOTHIAZOLE, ISOTHIAZOLO[3,4-B]PYRIDINE, QUINAZOLINE, PHTHALAZINE, PYRIDO[2,3-D]PYRIDAZINE AND PYRIDO[2,3-D]PYRIMIDINE DERIVATIVES AS KRAS G12C INHIBITORS FOR TREATING LUNG, PANCREATIC OR COLORECTAL CANCER
A61K 31/429 (2006.01)	3558955	BENZISOTHIAZOLE, ISOTHIAZOLO[3,4-B]PYRIDINE, QUINAZOLINE, PHTHALAZINE, PYRIDO[2,3-D]PYRIDAZINE AND PYRIDO[2,3-D]PYRIMIDINE DERIVATIVES AS KRAS G12C INHIBITORS FOR TREATING LUNG, PANCREATIC OR COLORECTAL CANCER
A61K 31/437 (2006.01)	3558955	BENZISOTHIAZOLE, ISOTHIAZOLO[3,4-B]PYRIDINE, QUINAZOLINE, PHTHALAZINE, PYRIDO[2,3-D]PYRIDAZINE AND PYRIDO[2,3-D]PYRIMIDINE DERIVATIVES AS KRAS G12C INHIBITORS FOR TREATING LUNG, PANCREATIC OR COLORECTAL CANCER
A61K 31/498 (2006.01)	3558955	BENZISOTHIAZOLE, ISOTHIAZOLO[3,4-B]PYRIDINE, QUINAZOLINE, PHTHALAZINE, PYRIDO[2,3-D]PYRIDAZINE AND PYRIDO[2,3-D]PYRIMIDINE DERIVATIVES AS KRAS G12C INHIBITORS FOR TREATING LUNG, PANCREATIC OR COLORECTAL CANCER
A61K 31/4985 (2006.01)	3558955	BENZISOTHIAZOLE, ISOTHIAZOLO[3,4-B]PYRIDINE, QUINAZOLINE, PHTHALAZINE, PYRIDO[2,3-D]PYRIDAZINE AND PYRIDO[2,3-D]PYRIMIDINE DERIVATIVES AS KRAS G12C INHIBITORS FOR TREATING LUNG, PANCREATIC OR COLORECTAL CANCER
A61K 31/517 (2006.01)	3558955	BENZISOTHIAZOLE, ISOTHIAZOLO[3,4-B]PYRIDINE, QUINAZOLINE, PHTHALAZINE, PYRIDO[2,3-D]PYRIDAZINE AND PYRIDO[2,3-D]PYRIMIDINE DERIVATIVES AS KRAS G12C INHIBITORS FOR TREATING LUNG, PANCREATIC OR COLORECTAL CANCER
A61K 31/519 (2006.01)	3558955	BENZISOTHIAZOLE, ISOTHIAZOLO[3,4-B]PYRIDINE, QUINAZOLINE, PHTHALAZINE, PYRIDO[2,3-D]PYRIDAZINE AND PYRIDO[2,3-D]PYRIMIDINE DERIVATIVES AS KRAS G12C INHIBITORS FOR TREATING LUNG, PANCREATIC OR COLORECTAL CANCER

MKP	Broj objave evropske prijave patenta (97)	Naziv pronalaska (54)
(51)		
A61P 35/00 (2006.01)	3558955	BENZISOTHIAZOLE, ISOTHIAZOLO[3,4-B]PYRIDINE, QUINAZOLINE, PHTHALAZINE, PYRIDO[2,3-D]PYRIDAZINE AND PYRIDO[2,3-D]PYRIMIDINE DERIVATIVES AS KRAS G12C INHIBITORS FOR TREATING LUNG, PANCREATIC OR COLORECTAL CANCER
C07D 239/80 (2006.01)	3558955	BENZISOTHIAZOLE, ISOTHIAZOLO[3,4-B]PYRIDINE, QUINAZOLINE, PHTHALAZINE, PYRIDO[2,3-D]PYRIDAZINE AND PYRIDO[2,3-D]PYRIMIDINE DERIVATIVES AS KRAS G12C INHIBITORS FOR TREATING LUNG, PANCREATIC OR COLORECTAL CANCER
C07D 275/04 (2006.01)	3558955	BENZISOTHIAZOLE, ISOTHIAZOLO[3,4-B]PYRIDINE, QUINAZOLINE, PHTHALAZINE, PYRIDO[2,3-D]PYRIDAZINE AND PYRIDO[2,3-D]PYRIMIDINE DERIVATIVES AS KRAS G12C INHIBITORS FOR TREATING LUNG, PANCREATIC OR COLORECTAL CANCER
C07D 401/04 (2006.01)	3558955	BENZISOTHIAZOLE, ISOTHIAZOLO[3,4-B]PYRIDINE, QUINAZOLINE, PHTHALAZINE, PYRIDO[2,3-D]PYRIDAZINE AND PYRIDO[2,3-D]PYRIMIDINE DERIVATIVES AS KRAS G12C INHIBITORS FOR TREATING LUNG, PANCREATIC OR COLORECTAL CANCER
C07D 403/04 (2006.01)	3558955	BENZISOTHIAZOLE, ISOTHIAZOLO[3,4-B]PYRIDINE, QUINAZOLINE, PHTHALAZINE, PYRIDO[2,3-D]PYRIDAZINE AND PYRIDO[2,3-D]PYRIMIDINE DERIVATIVES AS KRAS G12C INHIBITORS FOR TREATING LUNG, PANCREATIC OR COLORECTAL CANCER
C07D 417/04 (2006.01)	3558955	BENZISOTHIAZOLE, ISOTHIAZOLO[3,4-B]PYRIDINE, QUINAZOLINE, PHTHALAZINE, PYRIDO[2,3-D]PYRIDAZINE AND PYRIDO[2,3-D]PYRIMIDINE DERIVATIVES AS KRAS G12C INHIBITORS FOR TREATING LUNG, PANCREATIC OR COLORECTAL CANCER
C07D 471/04 (2006.01)	3558955	BENZISOTHIAZOLE, ISOTHIAZOLO[3,4-B]PYRIDINE, QUINAZOLINE, PHTHALAZINE, PYRIDO[2,3-D]PYRIDAZINE AND PYRIDO[2,3-D]PYRIMIDINE DERIVATIVES AS KRAS G12C INHIBITORS FOR TREATING LUNG, PANCREATIC OR COLORECTAL CANCER
C07D 471/08 (2006.01)	3558955	BENZISOTHIAZOLE, ISOTHIAZOLO[3,4-B]PYRIDINE, QUINAZOLINE, PHTHALAZINE, PYRIDO[2,3-D]PYRIDAZINE AND PYRIDO[2,3-D]PYRIMIDINE DERIVATIVES AS KRAS G12C INHIBITORS FOR TREATING LUNG, PANCREATIC OR COLORECTAL CANCER
C07D 487/04 (2006.01)	3558955	BENZISOTHIAZOLE, ISOTHIAZOLO[3,4-B]PYRIDINE, QUINAZOLINE, PHTHALAZINE, PYRIDO[2,3-D]PYRIDAZINE AND PYRIDO[2,3-D]PYRIMIDINE DERIVATIVES AS KRAS G12C INHIBITORS FOR TREATING LUNG, PANCREATIC OR COLORECTAL CANCER
C07D 487/10 (2006.01)	3558955	BENZISOTHIAZOLE, ISOTHIAZOLO[3,4-B]PYRIDINE, QUINAZOLINE, PHTHALAZINE, PYRIDO[2,3-D]PYRIDAZINE AND PYRIDO[2,3-D]PYRIMIDINE DERIVATIVES AS KRAS G12C INHIBITORS FOR TREATING LUNG, PANCREATIC OR COLORECTAL CANCER
C07D 513/04 (2006.01)	3558955	BENZISOTHIAZOLE, ISOTHIAZOLO[3,4-B]PYRIDINE, QUINAZOLINE, PHTHALAZINE, PYRIDO[2,3-D]PYRIDAZINE AND PYRIDO[2,3-D]PYRIMIDINE DERIVATIVES AS KRAS G12C INHIBITORS FOR TREATING LUNG, PANCREATIC OR COLORECTAL CANCER
A61K 31/352 (2006.01)	3562816	NRF2 ACTIVATOR
A61K 31/47 (2006.01)	3562816	NRF2 ACTIVATOR
C07D 217/04 (2006.01)	3562816	NRF2 ACTIVATOR
C07D 217/08 (2006.01)	3562816	NRF2 ACTIVATOR
C07D 223/16 (2006.01)	3562816	NRF2 ACTIVATOR
C07D 311/76 (2006.01)	3562816	NRF2 ACTIVATOR
C07D 498/14 (2006.01)	3562816	NRF2 ACTIVATOR
A61K 31/517 (2006.01)	3562822	POLY-ADP RIBOSE POLYMERASE (PARP) INHIBITORS
A61P 35/00 (2006.01)	3562822	POLY-ADP RIBOSE POLYMERASE (PARP) INHIBITORS
C07D 239/74 (2006.01)	3562822	POLY-ADP RIBOSE POLYMERASE (PARP) INHIBITORS
C07D 401/08 (2006.01)	3562822	POLY-ADP RIBOSE POLYMERASE (PARP) INHIBITORS
C07D 401/14 (2006.01)	3562822	POLY-ADP RIBOSE POLYMERASE (PARP) INHIBITORS
C07D 403/08 (2006.01)	3562822	POLY-ADP RIBOSE POLYMERASE (PARP) INHIBITORS
C07D 405/10 (2006.01)	3562822	POLY-ADP RIBOSE POLYMERASE (PARP) INHIBITORS
C07D 417/08 (2006.01)	3562822	POLY-ADP RIBOSE POLYMERASE (PARP) INHIBITORS
C07D 487/04 (2006.01)	3562822	POLY-ADP RIBOSE POLYMERASE (PARP) INHIBITORS
A61K 31/437 (2006.01)	3555097	SMALL MOLECULE INHIBITORS OF THE JAK FAMILY OF KINASES
A61P 29/00 (2006.01)	3555097	SMALL MOLECULE INHIBITORS OF THE JAK FAMILY OF KINASES
C07D 471/14 (2006.01)	3555097	SMALL MOLECULE INHIBITORS OF THE JAK FAMILY OF KINASES
A47J 37/04 (2006.01)	3551019	WIRE-STICK WITH A RING FOR EASY REMOVAL OF GRILLED MEAT AND VEGETABLES KEBABS
A47J 43/18 (2006.01)	3551019	WIRE-STICK WITH A RING FOR EASY REMOVAL OF GRILLED MEAT AND VEGETABLES KEBABS
A61K 31/4365 (2006.01)	3558309	POSITIVE ALLOSTERIC MODULATORS OF THE MUSCARINIC

MKP (51)	Broj objave evropske prijave patenta (97)	Naziv pronalaska (54)
C07D 495/04 (2006.01)	3558309	ACETYLCHOLINE RECEPTOR M4 POSITIVE ALLOSTERIC MODULATORS OF THE MUSCARINIC ACETYLCHOLINE RECEPTOR M4
A61K 36/31 (2006.01)	3562496	COMPOSITIONS AND METHODS FOR TREATMENT OF INTESTINAL INFLAMMATION AND COLON CANCER
A61K 35/76 (2015.01)	3551750	GENE THERAPY FOR MUCOPOLYSACCHARIDOSIS, TYPE I
A61K 38/43 (2006.01)	3551750	GENE THERAPY FOR MUCOPOLYSACCHARIDOSIS, TYPE I
C12N 7/00 (2006.01)	3551750	GENE THERAPY FOR MUCOPOLYSACCHARIDOSIS, TYPE I
C12N 15/86 (2006.01)	3551750	GENE THERAPY FOR MUCOPOLYSACCHARIDOSIS, TYPE I
A61K 9/51 (2006.01)	3551193	RESPIRATORY VIRUS NUCLEIC ACID VACCINES
A61K 31/7105 (2006.01)	3551193	RESPIRATORY VIRUS NUCLEIC ACID VACCINES
A61K 31/7115 (2006.01)	3551193	RESPIRATORY VIRUS NUCLEIC ACID VACCINES
A61P 31/14 (2006.01)	3551193	RESPIRATORY VIRUS NUCLEIC ACID VACCINES
E01B 9/28 (2006.01)	3551800	RAIL MOUNTING DEVICE AND METHOD FOR FIXING RAILS TO REINFORCED CONCRETE RAILWAY SLEEPER
E01B 9/30 (2006.01)	3551800	RAIL MOUNTING DEVICE AND METHOD FOR FIXING RAILS TO REINFORCED CONCRETE RAILWAY SLEEPER
E01B 9/60 (2006.01)	3551800	RAIL MOUNTING DEVICE AND METHOD FOR FIXING RAILS TO REINFORCED CONCRETE RAILWAY SLEEPER
E01B 13/02 (2006.01)	3551800	RAIL MOUNTING DEVICE AND METHOD FOR FIXING RAILS TO REINFORCED CONCRETE RAILWAY SLEEPER
A61K 35/76 (2015.01)	3562937	GENE THERAPY FOR MUCOPOLYSACCHARIDOSIS, TYPE II
A61K 38/43 (2006.01)	3562937	GENE THERAPY FOR MUCOPOLYSACCHARIDOSIS, TYPE II
C12N 7/00 (2006.01)	3562937	GENE THERAPY FOR MUCOPOLYSACCHARIDOSIS, TYPE II
C12N 15/86 (2006.01)	3562937	GENE THERAPY FOR MUCOPOLYSACCHARIDOSIS, TYPE II
A61F 13/15 (2006.01)	3551149	BIODEGRADABLE SANITARY ARTICLES WITH HIGHER BIOBASED CONTENT
A61F 13/51 (2006.01)	3551149	BIODEGRADABLE SANITARY ARTICLES WITH HIGHER BIOBASED CONTENT
A61F 13/511 (2006.01)	3551149	BIODEGRADABLE SANITARY ARTICLES WITH HIGHER BIOBASED CONTENT
A61F 13/514 (2006.01)	3551149	BIODEGRADABLE SANITARY ARTICLES WITH HIGHER BIOBASED CONTENT
A61F 13/53 (2006.01)	3551149	BIODEGRADABLE SANITARY ARTICLES WITH HIGHER BIOBASED CONTENT
A61K 35/16 (2015.01)	3551215	METHOD FOR THE PREPARATION AND PROLONGED STORAGE OF GROWTH FACTORS AND CYTOKINES OBTAINED FROM PLATELET RICH PLASMA
A61K 38/18 (2006.01)	3551215	METHOD FOR THE PREPARATION AND PROLONGED STORAGE OF GROWTH FACTORS AND CYTOKINES OBTAINED FROM PLATELET RICH PLASMA
A61K 38/19 (2006.01)	3551215	METHOD FOR THE PREPARATION AND PROLONGED STORAGE OF GROWTH FACTORS AND CYTOKINES OBTAINED FROM PLATELET RICH PLASMA
A61K 38/20 (2006.01)	3551215	METHOD FOR THE PREPARATION AND PROLONGED STORAGE OF GROWTH FACTORS AND CYTOKINES OBTAINED FROM PLATELET RICH PLASMA
A61K 39/395 (2006.01)	3551667	BIVALENT ANTIBODIES MASKED BY COILED COILS
C07K 16/18 (2006.01)	3551667	BIVALENT ANTIBODIES MASKED BY COILED COILS
C07K 16/28 (2006.01)	3551667	BIVALENT ANTIBODIES MASKED BY COILED COILS
C07K 16/46 (2006.01)	3551667	BIVALENT ANTIBODIES MASKED BY COILED COILS
C07K 7/08 (2006.01)	3556766	CYTOPLASMIC TRANSDUCTION PEPTIDE AND INTRACELLULAR MESSENGER COMPRISING SAME
C07K 14/005 (2006.01)	3556766	CYTOPLASMIC TRANSDUCTION PEPTIDE AND INTRACELLULAR MESSENGER COMPRISING SAME
C07K 19/00 (2006.01)	3556766	CYTOPLASMIC TRANSDUCTION PEPTIDE AND INTRACELLULAR MESSENGER COMPRISING SAME
A23K 50/10 (2016.01)	3554266	MULTI-DRUG ANTIBODY DRUG CONJUGATES
A61K 31/351 (2006.01)	3554266	MULTI-DRUG ANTIBODY DRUG CONJUGATES
A61K 38/00 (2006.01)	3554266	MULTI-DRUG ANTIBODY DRUG CONJUGATES
A61K 39/00 (2006.01)	3554266	MULTI-DRUG ANTIBODY DRUG CONJUGATES
A61K 39/395 (2006.01)	3554544	ANTI-CUB DOMAIN-CONTAINING PROTEIN 1 (CDCP1) ANTIBODIES, ANTIBODY DRUG CONJUGATES, AND METHODS OF USE THEREOF
A61P 35/00 (2006.01)	3554544	ANTI-CUB DOMAIN-CONTAINING PROTEIN 1 (CDCP1) ANTIBODIES, ANTIBODY DRUG CONJUGATES, AND METHODS OF USE THEREOF
C07K 16/18 (2006.01)	3554544	ANTI-CUB DOMAIN-CONTAINING PROTEIN 1 (CDCP1)

MKP	Broj objave evropske prijave patenta (97)	Naziv pronalaska (54)
(51)		(54)
C07K 16/30 (2006.01)	3554544	ANTIBODIES, ANTIBODY DRUG CONJUGATES, AND METHODS OF USE THEREOF ANTI-CUB DOMAIN-CONTAINING PROTEIN 1 (CDCP1)
A61K 35/545 (2015.01)	3555273	ANTIBODIES, ANTIBODY DRUG CONJUGATES, AND METHODS OF USE THEREOF ENHANCED hAT FAMILY TRANSPOSON-MEDIATED GENE TRANSFER AND ASSOCIATED COMPOSITIONS, SYSTEMS, AND METHODS
C07K 14/705 (2006.01)	3555273	ENHANCED hAT FAMILY TRANSPOSON-MEDIATED GENE TRANSFER AND ASSOCIATED COMPOSITIONS, SYSTEMS, AND METHODS
C12N 5/074 (2010.01)	3555273	ENHANCED hAT FAMILY TRANSPOSON-MEDIATED GENE TRANSFER AND ASSOCIATED COMPOSITIONS, SYSTEMS, AND METHODS
C12N 9/12 (2006.01)	3555273	ENHANCED hAT FAMILY TRANSPOSON-MEDIATED GENE TRANSFER AND ASSOCIATED COMPOSITIONS, SYSTEMS, AND METHODS
C07D 215/12 (2006.01)	3558946	POSITIVE ALLOSTERIC MODULATORS OF THE MUSCARINIC ACETYLCHOLINE RECEPTOR M4
C07D 215/38 (2006.01)	3558946	POSITIVE ALLOSTERIC MODULATORS OF THE MUSCARINIC ACETYLCHOLINE RECEPTOR M4
C12N 9/22 (2006.01)	3555289	RNA AFFINITY PURIFICATION
C12N 11/14 (2006.01)	3555289	RNA AFFINITY PURIFICATION
C12N 15/10 (2006.01)	3555289	RNA AFFINITY PURIFICATION
C12Q 1/34 (2006.01)	3555289	RNA AFFINITY PURIFICATION
C12Q 1/68 (2018.01)	3555289	RNA AFFINITY PURIFICATION
A61K 9/00 (2006.01)	3556370	OPHTHALMIC COMPOSITION CONTAINING SULFASALAZINE AND HYALURONIC ACID
A61K 9/08 (2006.01)	3556370	OPHTHALMIC COMPOSITION CONTAINING SULFASALAZINE AND HYALURONIC ACID
A61K 31/635 (2006.01)	3556370	OPHTHALMIC COMPOSITION CONTAINING SULFASALAZINE AND HYALURONIC ACID
A61K 31/728 (2006.01)	3556370	OPHTHALMIC COMPOSITION CONTAINING SULFASALAZINE AND HYALURONIC ACID
A61K 31/4545 (2006.01)	3560919	SALT OF SUBSTITUTED PIPERIDINE COMPOUND
A61P 35/00 (2006.01)	3560919	SALT OF SUBSTITUTED PIPERIDINE COMPOUND
C07D 401/14 (2006.01)	3560919	SALT OF SUBSTITUTED PIPERIDINE COMPOUND
B05D 1/00 (2006.01)	3558864	NANOPARTICLES
B82B 3/00 (2006.01)	3558864	NANOPARTICLES
B82Y 40/00 (2011.01)	3558864	NANOPARTICLES
C08F 2/34 (2006.01)	3558864	NANOPARTICLES
C08F 2/46 (2006.01)	3558864	NANOPARTICLES
C08F 2/58 (2006.01)	3558864	NANOPARTICLES
C23C 14/00 (2006.01)	3558864	NANOPARTICLES
C23C 16/455 (2006.01)	3558864	NANOPARTICLES
C23C 16/50 (2006.01)	3558864	NANOPARTICLES
H05H 1/24 (2006.01)	3558864	NANOPARTICLES
A61K 31/519 (2006.01)	3560931	METHOD FOR PRODUCING 7H-PYRROLO[2,3-D]PYRIMIDINE DERIVATIVE, AND COCRYSTAL OF SAID DERIVATIVE
A61P 43/00 (2006.01)	3560931	METHOD FOR PRODUCING 7H-PYRROLO[2,3-D]PYRIMIDINE DERIVATIVE, AND COCRYSTAL OF SAID DERIVATIVE
C07D 231/12 (2006.01)	3560931	METHOD FOR PRODUCING 7H-PYRROLO[2,3-D]PYRIMIDINE DERIVATIVE, AND COCRYSTAL OF SAID DERIVATIVE
C07D 519/00 (2006.01)	3560931	METHOD FOR PRODUCING 7H-PYRROLO[2,3-D]PYRIMIDINE DERIVATIVE, AND COCRYSTAL OF SAID DERIVATIVE
A61K 39/395 (2006.01)	3558369	ANTIBODIES THAT SPECIFICALLY BIND TO HUMAN IL-15 AND USES THEREOF
A61P 19/02 (2006.01)	3558369	ANTIBODIES THAT SPECIFICALLY BIND TO HUMAN IL-15 AND USES THEREOF
C07K 16/24 (2006.01)	3558369	ANTIBODIES THAT SPECIFICALLY BIND TO HUMAN IL-15 AND USES THEREOF
G01N 33/53 (2006.01)	3558369	ANTIBODIES THAT SPECIFICALLY BIND TO HUMAN IL-15 AND USES THEREOF
A61K 31/685 (2006.01)	3558322	ANTIVIRAL BENZYL-AMINE PHOSPHODIAMIDE COMPOUNDS
A61P 31/18 (2006.01)	3558322	ANTIVIRAL BENZYL-AMINE PHOSPHODIAMIDE COMPOUNDS
A61P 31/20 (2006.01)	3558322	ANTIVIRAL BENZYL-AMINE PHOSPHODIAMIDE COMPOUNDS
C07F 9/6561 (2006.01)	3558322	ANTIVIRAL BENZYL-AMINE PHOSPHODIAMIDE COMPOUNDS
C07C 271/22 (2006.01)	3560932	METHOD FOR PRODUCING 7H-PYRROLO[2,3-D]PYRIMIDINE

MKP (51)	Broj objave evropske prijave patenta (97)	Naziv pronalaska (54)
C07D 307/33 (2006.01)	3560932	DERIVATIVE AND SYNTHETIC INTERMEDIATE OF SAME METHOD FOR PRODUCING 7H-PYRROLO[2,3-D]PYRIMIDINE
C07D 403/06 (2006.01)	3560932	DERIVATIVE AND SYNTHETIC INTERMEDIATE OF SAME METHOD FOR PRODUCING 7H-PYRROLO[2,3-D]PYRIMIDINE
C07D 487/10 (2006.01)	3560932	DERIVATIVE AND SYNTHETIC INTERMEDIATE OF SAME METHOD FOR PRODUCING 7H-PYRROLO[2,3-D]PYRIMIDINE
C07D 491/10 (2006.01)	3560932	DERIVATIVE AND SYNTHETIC INTERMEDIATE OF SAME METHOD FOR PRODUCING 7H-PYRROLO[2,3-D]PYRIMIDINE
C07D 519/00 (2006.01)	3560932	DERIVATIVE AND SYNTHETIC INTERMEDIATE OF SAME METHOD FOR PRODUCING 7H-PYRROLO[2,3-D]PYRIMIDINE
A61K 31/415 (2006.01)	3562486	DERIVATIVE AND SYNTHETIC INTERMEDIATE OF SAME USE OF SUBLINGUAL DEXMEDETOMIDINE FOR THE TREATMENT OF AGITATION
A61K 31/4174 (2006.01)	3562486	USE OF SUBLINGUAL DEXMEDETOMIDINE FOR THE TREATMENT OF AGITATION
G06F 17/30 (2006.01)	3563379	DYNAMIC SEARCH AND RETRIEVAL OF QUESTIONS
G16H 10/20 (2018.01)	3563379	DYNAMIC SEARCH AND RETRIEVAL OF QUESTIONS
G16H 15/00 (2018.01)	3563379	DYNAMIC SEARCH AND RETRIEVAL OF QUESTIONS
H04L 29/06 (2006.01)	3570512	DOMAIN NAME RESOLUTION METHOD, SERVER AND STORAGE MEDIUM
H04L 29/12 (2006.01)	3570512	DOMAIN NAME RESOLUTION METHOD, SERVER AND STORAGE MEDIUM
A61K 39/395 (2006.01)	3573658	ANTI-TNF ANTIBODIES, COMPOSITIONS, AND METHODS FOR THE TREATMENT OF ACTIVE PSORIATIC ARTHRITIS
C07K 14/525 (2006.01)	3573658	ANTI-TNF ANTIBODIES, COMPOSITIONS, AND METHODS FOR THE TREATMENT OF ACTIVE PSORIATIC ARTHRITIS
C07K 16/24 (2006.01)	3573658	ANTI-TNF ANTIBODIES, COMPOSITIONS, AND METHODS FOR THE TREATMENT OF ACTIVE PSORIATIC ARTHRITIS
A61K 31/7088 (2006.01)	3576751	RNA CANCER VACCINES
A61K 31/7105 (2006.01)	3576751	RNA CANCER VACCINES
A61K 39/00 (2006.01)	3576751	RNA CANCER VACCINES
A61K 39/39 (2006.01)	3576751	RNA CANCER VACCINES
A61P 35/00 (2006.01)	3576751	RNA CANCER VACCINES
A61K 39/395 (2006.01)	3579871	ANTI-TNF ANTIBODIES, COMPOSITIONS, AND METHODS FOR THE TREATMENT OF ACTIVE ANKYLOSING SPONDYLITIS
C07K 16/18 (2006.01)	3579871	ANTI-TNF ANTIBODIES, COMPOSITIONS, AND METHODS FOR THE TREATMENT OF ACTIVE ANKYLOSING SPONDYLITIS
C07K 16/24 (2006.01)	3579871	ANTI-TNF ANTIBODIES, COMPOSITIONS, AND METHODS FOR THE TREATMENT OF ACTIVE ANKYLOSING SPONDYLITIS
A21C 9/00 (2006.01)	3581030	METHOD FOR PREPARING FOODS BASED ON DOUGHS FROZEN IN PORTIONS AND MACHINE FOR PREPARING AND SELLING SAID FOODS
A21D 8/02 (2006.01)	3581030	METHOD FOR PREPARING FOODS BASED ON DOUGHS FROZEN IN PORTIONS AND MACHINE FOR PREPARING AND SELLING SAID FOODS
A21D 8/06 (2006.01)	3581030	METHOD FOR PREPARING FOODS BASED ON DOUGHS FROZEN IN PORTIONS AND MACHINE FOR PREPARING AND SELLING SAID FOODS
A21D 10/02 (2006.01)	3581030	METHOD FOR PREPARING FOODS BASED ON DOUGHS FROZEN IN PORTIONS AND MACHINE FOR PREPARING AND SELLING SAID FOODS
G07F 9/10 (2006.01)	3581030	METHOD FOR PREPARING FOODS BASED ON DOUGHS FROZEN IN PORTIONS AND MACHINE FOR PREPARING AND SELLING SAID FOODS
G07F 11/70 (2006.01)	3581030	METHOD FOR PREPARING FOODS BASED ON DOUGHS FROZEN IN PORTIONS AND MACHINE FOR PREPARING AND SELLING SAID FOODS
G07F 17/00 (2006.01)	3581030	METHOD FOR PREPARING FOODS BASED ON DOUGHS FROZEN IN PORTIONS AND MACHINE FOR PREPARING AND SELLING SAID FOODS
C07D 217/26 (2006.01)	3470397	CRYSTALLINE FORMS OF A PROLYL HYDROXYLASE INHIBITOR
A61K 39/00 (2006.01)	3485902	METHODS FOR TREATING CHRONIC OBSTRUCTIVE PULMONARY DISEASE USING BENRALIZUMAB
A61K 39/395 (2006.01)	3485902	METHODS FOR TREATING CHRONIC OBSTRUCTIVE PULMONARY DISEASE USING BENRALIZUMAB
A61P 11/00 (2006.01)	3485902	METHODS FOR TREATING CHRONIC OBSTRUCTIVE PULMONARY DISEASE USING BENRALIZUMAB
G01N 33/48 (2006.01)	3485902	METHODS FOR TREATING CHRONIC OBSTRUCTIVE PULMONARY

MKP	Broj objave evropske prijave patenta	Naziv pronalaska
(51)	(97)	(54)
A61B 17/34 (2006.01)	3459475	DISEASE USING BENRALIZUMAB
G01N 33/533 (2006.01)	3467501	SURGICAL ACCESS DEVICES WITH SORBENTS
A01N 43/56 (2006.01)	3473099	ASSAY FOR DETECTING TH1 AND TH2 CELL POPULATIONS
A61K 31/415 (2006.01)	3473099	INDAZOLE-3-CARBOXAMIDES AND THEIR USE AS WNT/B-CATENIN SIGNALING PATHWAY INHIBITORS
A61K 45/06 (2006.01)	3473099	INDAZOLE-3-CARBOXAMIDES AND THEIR USE AS WNT/B-CATENIN SIGNALING PATHWAY INHIBITORS
A61P 35/00 (2006.01)	3473099	INDAZOLE-3-CARBOXAMIDES AND THEIR USE AS WNT/B-CATENIN SIGNALING PATHWAY INHIBITORS
C07D 401/04 (2006.01)	3473099	INDAZOLE-3-CARBOXAMIDES AND THEIR USE AS WNT/B-CATENIN SIGNALING PATHWAY INHIBITORS
C07D 401/10 (2006.01)	3473099	INDAZOLE-3-CARBOXAMIDES AND THEIR USE AS WNT/B-CATENIN SIGNALING PATHWAY INHIBITORS
C07D 401/14 (2006.01)	3473099	INDAZOLE-3-CARBOXAMIDES AND THEIR USE AS WNT/B-CATENIN SIGNALING PATHWAY INHIBITORS
C07D 405/14 (2006.01)	3473099	INDAZOLE-3-CARBOXAMIDES AND THEIR USE AS WNT/B-CATENIN SIGNALING PATHWAY INHIBITORS
C07D 413/12 (2006.01)	3473099	INDAZOLE-3-CARBOXAMIDES AND THEIR USE AS WNT/B-CATENIN SIGNALING PATHWAY INHIBITORS
A61K 9/20 (2006.01)	3470063	PHARMACEUTICAL COMPOSITIONS FOR THE TREATMENT OF CFTR MEDIATED DISEASES
A61K 31/443 (2006.01)	3470063	PHARMACEUTICAL COMPOSITIONS FOR THE TREATMENT OF CFTR MEDIATED DISEASES
A61K 31/47 (2006.01)	3470063	PHARMACEUTICAL COMPOSITIONS FOR THE TREATMENT OF CFTR MEDIATED DISEASES
A61K 45/06 (2006.01)	3470063	PHARMACEUTICAL COMPOSITIONS FOR THE TREATMENT OF CFTR MEDIATED DISEASES
C12Q 1/68 (2018.01)	3467500	CO-BINDER ASSISTED ASSAY METHODS
G01N 33/52 (2006.01)	3467500	CO-BINDER ASSISTED ASSAY METHODS
G01N 33/53 (2006.01)	3467500	CO-BINDER ASSISTED ASSAY METHODS
G01N 33/543 (2006.01)	3467500	CO-BINDER ASSISTED ASSAY METHODS
A61K 48/00 (2006.01)	3461838	RECOMBINANT ADENO-ASSOCIATED VIRUS DELIVERY OF EXON 2-TARGETED U7SNRNA POLYNUCLEOTIDE CONSTRUCTS
C07K 14/47 (2006.01)	3461838	RECOMBINANT ADENO-ASSOCIATED VIRUS DELIVERY OF EXON 2-TARGETED U7SNRNA POLYNUCLEOTIDE CONSTRUCTS
C12N 15/113 (2010.01)	3461838	RECOMBINANT ADENO-ASSOCIATED VIRUS DELIVERY OF EXON 2-TARGETED U7SNRNA POLYNUCLEOTIDE CONSTRUCTS
C12N 15/86 (2006.01)	3461838	RECOMBINANT ADENO-ASSOCIATED VIRUS DELIVERY OF EXON 2-TARGETED U7SNRNA POLYNUCLEOTIDE CONSTRUCTS
A01N 37/34 (2006.01)	3437474	HERBICIDAL COMPOSITION
A01N 37/40 (2006.01)	3437474	HERBICIDAL COMPOSITION
A01N 41/10 (2006.01)	3437474	HERBICIDAL COMPOSITION
A01N 43/40 (2006.01)	3437474	HERBICIDAL COMPOSITION
A01N 47/36 (2006.01)	3437474	HERBICIDAL COMPOSITION
A01P 13/00 (2006.01)	3437474	HERBICIDAL COMPOSITION
A61P 11/00 (2006.01)	3460054	HISTIDYL-TRNA SYNTHETASE-FC CONJUGATES
A61P 21/00 (2006.01)	3460054	HISTIDYL-TRNA SYNTHETASE-FC CONJUGATES
A61P 29/00 (2006.01)	3460054	HISTIDYL-TRNA SYNTHETASE-FC CONJUGATES
A61P 37/00 (2006.01)	3460054	HISTIDYL-TRNA SYNTHETASE-FC CONJUGATES
C12N 9/00 (2006.01)	3460054	HISTIDYL-TRNA SYNTHETASE-FC CONJUGATES
C12N 9/96 (2006.01)	3460054	HISTIDYL-TRNA SYNTHETASE-FC CONJUGATES
B01L 3/00 (2006.01)	3450980	METHOD OF HOSTING A STABLE DROPLET PATTERN
C12Q 1/68 (2018.01)	3450980	METHOD OF HOSTING A STABLE DROPLET PATTERN
G01N 33/52 (2006.01)	3450980	METHOD OF HOSTING A STABLE DROPLET PATTERN
G01N 33/543 (2006.01)	3450980	METHOD OF HOSTING A STABLE DROPLET PATTERN
G01N 33/68 (2006.01)	3483611	INTACT MASS DETERMINATION OF PROTEIN CONJUGATED AGENT COMPOUNDS
A61K 9/14 (2006.01)	3470370	MICROPOROUS ZIRCONIUM SILICATE FOR THE TREATMENT OF HYPERKALEMIA
A61K 33/00 (2006.01)	3470370	MICROPOROUS ZIRCONIUM SILICATE FOR THE TREATMENT OF HYPERKALEMIA
A61K 33/24 (2019.01)	3470370	MICROPOROUS ZIRCONIUM SILICATE FOR THE TREATMENT OF HYPERKALEMIA
A61K 45/06 (2006.01)	3470370	MICROPOROUS ZIRCONIUM SILICATE FOR THE TREATMENT OF HYPERKALEMIA
B01J 19/00 (2006.01)	3470370	MICROPOROUS ZIRCONIUM SILICATE FOR THE TREATMENT OF

MKP	Broj objave evropske prijave patenta (97)	Naziv pronalaska (54)
(51)		(54)
B01J 19/18 (2006.01)	3470370	HYPERKALEMIA MICROPOROUS ZIRCONIUM SILICATE FOR THE TREATMENT OF HYPERKALEMIA
B01J 39/02 (2006.01)	3470370	MICROPOROUS ZIRCONIUM SILICATE FOR THE TREATMENT OF HYPERKALEMIA
B01J 39/14 (2006.01)	3470370	MICROPOROUS ZIRCONIUM SILICATE FOR THE TREATMENT OF HYPERKALEMIA
C01B 33/20 (2006.01)	3470370	MICROPOROUS ZIRCONIUM SILICATE FOR THE TREATMENT OF HYPERKALEMIA
C01B 39/02 (2006.01)	3470370	MICROPOROUS ZIRCONIUM SILICATE FOR THE TREATMENT OF HYPERKALEMIA
C01B 39/46 (2006.01)	3470370	MICROPOROUS ZIRCONIUM SILICATE FOR THE TREATMENT OF HYPERKALEMIA
C07F 7/02 (2006.01)	3470370	MICROPOROUS ZIRCONIUM SILICATE FOR THE TREATMENT OF HYPERKALEMIA
A61K 39/285 (2006.01)	3456349	OPTIMIZED EARLY-LATE PROMOTER COMBINED WITH REPEATED VACCINATION FAVORS CYTOTOXIC T CELL RESPONSE AGAINST RECOMBINANT ANTIGEN IN MVA VACCINES
C07K 14/07 (2006.01)	3456349	OPTIMIZED EARLY-LATE PROMOTER COMBINED WITH REPEATED VACCINATION FAVORS CYTOTOXIC T CELL RESPONSE AGAINST RECOMBINANT ANTIGEN IN MVA VACCINES
C12N 15/863 (2006.01)	3456349	OPTIMIZED EARLY-LATE PROMOTER COMBINED WITH REPEATED VACCINATION FAVORS CYTOTOXIC T CELL RESPONSE AGAINST RECOMBINANT ANTIGEN IN MVA VACCINES
A61K 39/395 (2006.01)	3480202	CONJUGATION METHODS
A61K 47/50 (2017.01)	3480202	CONJUGATION METHODS
A61K 51/00 (2006.01)	3480202	CONJUGATION METHODS
C07D 498/14 (2006.01)	3480202	CONJUGATION METHODS
A61K 31/4412 (2006.01)	3483143	PIPERIDINONE DERIVATIVES AS MDM2 INHIBITORS FOR THE TREATMENT OF CANCER
A61P 35/00 (2006.01)	3483143	PIPERIDINONE DERIVATIVES AS MDM2 INHIBITORS FOR THE TREATMENT OF CANCER
C07D 211/40 (2006.01)	3483143	PIPERIDINONE DERIVATIVES AS MDM2 INHIBITORS FOR THE TREATMENT OF CANCER
C07D 279/02 (2006.01)	3483143	PIPERIDINONE DERIVATIVES AS MDM2 INHIBITORS FOR THE TREATMENT OF CANCER
C07D 401/04 (2006.01)	3483143	PIPERIDINONE DERIVATIVES AS MDM2 INHIBITORS FOR THE TREATMENT OF CANCER
C07D 401/06 (2006.01)	3483143	PIPERIDINONE DERIVATIVES AS MDM2 INHIBITORS FOR THE TREATMENT OF CANCER
C07D 401/12 (2006.01)	3483143	PIPERIDINONE DERIVATIVES AS MDM2 INHIBITORS FOR THE TREATMENT OF CANCER
C07D 407/04 (2006.01)	3483143	PIPERIDINONE DERIVATIVES AS MDM2 INHIBITORS FOR THE TREATMENT OF CANCER
C07D 407/06 (2006.01)	3483143	PIPERIDINONE DERIVATIVES AS MDM2 INHIBITORS FOR THE TREATMENT OF CANCER
C07D 409/04 (2006.01)	3483143	PIPERIDINONE DERIVATIVES AS MDM2 INHIBITORS FOR THE TREATMENT OF CANCER
C07D 413/06 (2006.01)	3483143	PIPERIDINONE DERIVATIVES AS MDM2 INHIBITORS FOR THE TREATMENT OF CANCER
C07D 417/06 (2006.01)	3483143	PIPERIDINONE DERIVATIVES AS MDM2 INHIBITORS FOR THE TREATMENT OF CANCER
C07D 471/20 (2006.01)	3483143	PIPERIDINONE DERIVATIVES AS MDM2 INHIBITORS FOR THE TREATMENT OF CANCER
C07D 498/08 (2006.01)	3483143	PIPERIDINONE DERIVATIVES AS MDM2 INHIBITORS FOR THE TREATMENT OF CANCER
C07D 498/20 (2006.01)	3483143	PIPERIDINONE DERIVATIVES AS MDM2 INHIBITORS FOR THE TREATMENT OF CANCER
A61K 39/00 (2006.01)	3485903	VEGF/DLL4 BINDING AGENTS AND USES THEREOF
A61P 35/00 (2006.01)	3485903	VEGF/DLL4 BINDING AGENTS AND USES THEREOF
C07K 16/00 (2006.01)	3485903	VEGF/DLL4 BINDING AGENTS AND USES THEREOF
C12P 21/08 (2006.01)	3485903	VEGF/DLL4 BINDING AGENTS AND USES THEREOF
A61F 13/00 (2006.01)	3461465	EXTENSIBLE DRESSINGS
A43B 1/04 (2006.01)	3470563	METHOD FOR PRODUCING A CRIMPED UPPER
D04B 1/10 (2006.01)	3470563	METHOD FOR PRODUCING A CRIMPED UPPER
D04B 1/22 (2006.01)	3470563	METHOD FOR PRODUCING A CRIMPED UPPER
A61K 38/00 (2006.01)	3485901	EGFR AND C-MET-FIBRONECTIN TYPE III DOMAIN BINDING MOLECULES

MKP	Broj objave evropske prijave patenta (97)	Naziv pronalaska (54)
(51)		(54)
A61K 38/39 (2006.01)	3485901	EGFR AND C-MET-FIBRONECTIN TYPE III DOMAIN BINDING MOLECULES
A61K 39/395 (2006.01)	3485901	EGFR AND C-MET-FIBRONECTIN TYPE III DOMAIN BINDING MOLECULES
A61K 45/06 (2006.01)	3485901	EGFR AND C-MET-FIBRONECTIN TYPE III DOMAIN BINDING MOLECULES
A61P 35/00 (2006.01)	3485901	EGFR AND C-MET-FIBRONECTIN TYPE III DOMAIN BINDING MOLECULES
C07K 14/78 (2006.01)	3485901	EGFR AND C-MET-FIBRONECTIN TYPE III DOMAIN BINDING MOLECULES
C07K 16/28 (2006.01)	3485901	EGFR AND C-MET-FIBRONECTIN TYPE III DOMAIN BINDING MOLECULES
H04B 1/69 (2011.01)	3468051	SYSTEM AND METHOD FOR OPTIMISING THE USE OF THE RADIO SPECTRUM AS A FUNCTION OF THE AIR TRANSMISSION TIMES
H04J 13/18 (2011.01)	3468051	SYSTEM AND METHOD FOR OPTIMISING THE USE OF THE RADIO SPECTRUM AS A FUNCTION OF THE AIR TRANSMISSION TIMES
H04L 5/00 (2006.01)	3468051	SYSTEM AND METHOD FOR OPTIMISING THE USE OF THE RADIO SPECTRUM AS A FUNCTION OF THE AIR TRANSMISSION TIMES
A61K 31/444 (2006.01)	3461483	SOLID DOSAGE FORMS OF 2-AMINO-6-(DIFLUOROMETHYL)-5,5-DIFLUORO-6-PHENYL-3,4,5,6- TETRAHYDROPYRIDINE BACE1 INHIBITORS
A61K 31/497 (2006.01)	3461483	SOLID DOSAGE FORMS OF 2-AMINO-6-(DIFLUOROMETHYL)-5,5-DIFLUORO-6-PHENYL-3,4,5,6- TETRAHYDROPYRIDINE BACE1 INHIBITORS
A61P 25/28 (2006.01)	3461483	SOLID DOSAGE FORMS OF 2-AMINO-6-(DIFLUOROMETHYL)-5,5-DIFLUORO-6-PHENYL-3,4,5,6- TETRAHYDROPYRIDINE BACE1 INHIBITORS
C07D 401/12 (2006.01)	3461483	SOLID DOSAGE FORMS OF 2-AMINO-6-(DIFLUOROMETHYL)-5,5-DIFLUORO-6-PHENYL-3,4,5,6- TETRAHYDROPYRIDINE BACE1 INHIBITORS
A23D 7/00 (2006.01)	3466278	IMITATION WHIPPING CREAM
A23L 9/20 (2016.01)	3466278	IMITATION WHIPPING CREAM
A23L 33/115 (2016.01)	3466278	IMITATION WHIPPING CREAM
C11C 3/10 (2006.01)	3466278	IMITATION WHIPPING CREAM
A61K 39/00 (2006.01)	3456346	PD-1 AND LAG-3 BINDING MOLECULES AND METHODS OF USE THEREOF
A61K 39/395 (2006.01)	3456346	PD-1 AND LAG-3 BINDING MOLECULES AND METHODS OF USE THEREOF
C07K 16/28 (2006.01)	3456346	PD-1 AND LAG-3 BINDING MOLECULES AND METHODS OF USE THEREOF
A61K 39/395 (2006.01)	3450458	HUMAN ANTIBODIES TO GFR 3 AND METHODS OF USE THEREOF
A61P 29/00 (2006.01)	3450458	HUMAN ANTIBODIES TO GFR 3 AND METHODS OF USE THEREOF
C07K 16/28 (2006.01)	3450458	HUMAN ANTIBODIES TO GFR 3 AND METHODS OF USE THEREOF
A61K 39/00 (2006.01)	3480316	LENTIVIRAL VECTOR PARTICLES HAVING IMPROVED TRANSDUCTION EFFICIENCY FOR CELLS EXPRESSING DC-SIGN
C12N 15/867 (2006.01)	3480316	LENTIVIRAL VECTOR PARTICLES HAVING IMPROVED TRANSDUCTION EFFICIENCY FOR CELLS EXPRESSING DC-SIGN
C07F 9/40 (2006.01)	3450438	PROCESSES AND INTERMEDIATES FOR PREPARING ANTI-HIV AGENTS
C07F 9/44 (2006.01)	3450438	PROCESSES AND INTERMEDIATES FOR PREPARING ANTI-HIV AGENTS
C07H 19/20 (2006.01)	3450438	PROCESSES AND INTERMEDIATES FOR PREPARING ANTI-HIV AGENTS
A23L 29/00 (2016.01)	3476388	COMPOSITION COMPRISING COENZYME Q10 AND PIPERINE
A23L 33/10 (2016.01)	3476388	COMPOSITION COMPRISING COENZYME Q10 AND PIPERINE
A61K 9/16 (2006.01)	3476388	COMPOSITION COMPRISING COENZYME Q10 AND PIPERINE
A61K 31/122 (2006.01)	3476388	COMPOSITION COMPRISING COENZYME Q10 AND PIPERINE
A61K 31/70 (2006.01)	3466431	CRYSTALLINE FORMS AND METHODS FOR PREPARING SGLT2 INHIBITORS
C07D 317/26 (2006.01)	3466431	CRYSTALLINE FORMS AND METHODS FOR PREPARING SGLT2 INHIBITORS
C07H 21/04 (2006.01)	3466960	MODULATION OF SIGNAL TRANSDUCER AND ACTIVATOR OF TRANSCRIPTION 3 (STAT3) EXPRESSION
C12N 15/11 (2006.01)	3466960	MODULATION OF SIGNAL TRANSDUCER AND ACTIVATOR OF TRANSCRIPTION 3 (STAT3) EXPRESSION
A23C 9/152 (2006.01)	3456386	COMPOSITIONS COMPRISING BACTERIAL STRAINS
A23L 33/135 (2016.01)	3456386	COMPOSITIONS COMPRISING BACTERIAL STRAINS
A61K 9/19 (2006.01)	3456386	COMPOSITIONS COMPRISING BACTERIAL STRAINS

MKP	Broj objave evropske prijave patenta	Naziv pronalaska
(51)	(97)	(54)
A61K 31/00 (2006.01)	3456386	COMPOSITIONS COMPRISING BACTERIAL STRAINS
A61K 35/74 (2015.01)	3456386	COMPOSITIONS COMPRISING BACTERIAL STRAINS
A61K 39/00 (2006.01)	3456386	COMPOSITIONS COMPRISING BACTERIAL STRAINS
A61K 39/08 (2006.01)	3456386	COMPOSITIONS COMPRISING BACTERIAL STRAINS
A61P 11/06 (2006.01)	3456386	COMPOSITIONS COMPRISING BACTERIAL STRAINS
A61P 19/00 (2006.01)	3456386	COMPOSITIONS COMPRISING BACTERIAL STRAINS
A61P 27/02 (2006.01)	3456386	COMPOSITIONS COMPRISING BACTERIAL STRAINS
A61P 29/00 (2006.01)	3456386	COMPOSITIONS COMPRISING BACTERIAL STRAINS
A61K 31/497 (2006.01)	3492455	1,2,4-TRIAZOLES AS NUCLEAR TRANSPORT MODULATORS AND USE IN THE TREATMENT OF SPECIFIC FORMS OF CANCER
A61P 35/00 (2006.01)	3492455	1,2,4-TRIAZOLES AS NUCLEAR TRANSPORT MODULATORS AND USE IN THE TREATMENT OF SPECIFIC FORMS OF CANCER
C07D 249/08 (2006.01)	3492455	1,2,4-TRIAZOLES AS NUCLEAR TRANSPORT MODULATORS AND USE IN THE TREATMENT OF SPECIFIC FORMS OF CANCER
C07D 401/06 (2006.01)	3492455	1,2,4-TRIAZOLES AS NUCLEAR TRANSPORT MODULATORS AND USE IN THE TREATMENT OF SPECIFIC FORMS OF CANCER
C07D 403/06 (2006.01)	3492455	1,2,4-TRIAZOLES AS NUCLEAR TRANSPORT MODULATORS AND USE IN THE TREATMENT OF SPECIFIC FORMS OF CANCER
C07D 405/06 (2006.01)	3492455	1,2,4-TRIAZOLES AS NUCLEAR TRANSPORT MODULATORS AND USE IN THE TREATMENT OF SPECIFIC FORMS OF CANCER
C07D 413/06 (2006.01)	3492455	1,2,4-TRIAZOLES AS NUCLEAR TRANSPORT MODULATORS AND USE IN THE TREATMENT OF SPECIFIC FORMS OF CANCER
C07D 417/06 (2006.01)	3492455	1,2,4-TRIAZOLES AS NUCLEAR TRANSPORT MODULATORS AND USE IN THE TREATMENT OF SPECIFIC FORMS OF CANCER
A01K 67/027 (2006.01)	3456832	MICE EXPRESSING AN IMMUNOGLOBULIN HYBRID LIGHT CHAIN
C07K 16/00 (2006.01)	3456832	MICE EXPRESSING AN IMMUNOGLOBULIN HYBRID LIGHT CHAIN
C07K 16/18 (2006.01)	3456832	MICE EXPRESSING AN IMMUNOGLOBULIN HYBRID LIGHT CHAIN
C07K 16/46 (2006.01)	3456832	MICE EXPRESSING AN IMMUNOGLOBULIN HYBRID LIGHT CHAIN
C12N 15/10 (2006.01)	3456832	MICE EXPRESSING AN IMMUNOGLOBULIN HYBRID LIGHT CHAIN
C12N 15/85 (2006.01)	3456832	MICE EXPRESSING AN IMMUNOGLOBULIN HYBRID LIGHT CHAIN
A61K 31/4985 (2006.01)	3495368	(S)-4-(8-AMINO-3-(1-(BUT-2-YNOYL)PYRROLIDIN-2-YL)IMIDAZO[1,5-A]PYRAZIN-1-YL)-2-METHOXY-N-(PYRIDIN-2-YL)BENZAMIDE AS BTK-INHIBITOR
A61P 19/08 (2006.01)	3495368	(S)-4-(8-AMINO-3-(1-(BUT-2-YNOYL)PYRROLIDIN-2-YL)IMIDAZO[1,5-A]PYRAZIN-1-YL)-2-METHOXY-N-(PYRIDIN-2-YL)BENZAMIDE AS BTK-INHIBITOR
A61P 29/00 (2006.01)	3495368	(S)-4-(8-AMINO-3-(1-(BUT-2-YNOYL)PYRROLIDIN-2-YL)IMIDAZO[1,5-A]PYRAZIN-1-YL)-2-METHOXY-N-(PYRIDIN-2-YL)BENZAMIDE AS BTK-INHIBITOR
A61P 31/00 (2006.01)	3495368	(S)-4-(8-AMINO-3-(1-(BUT-2-YNOYL)PYRROLIDIN-2-YL)IMIDAZO[1,5-A]PYRAZIN-1-YL)-2-METHOXY-N-(PYRIDIN-2-YL)BENZAMIDE AS BTK-INHIBITOR
A61P 35/00 (2006.01)	3495368	(S)-4-(8-AMINO-3-(1-(BUT-2-YNOYL)PYRROLIDIN-2-YL)IMIDAZO[1,5-A]PYRAZIN-1-YL)-2-METHOXY-N-(PYRIDIN-2-YL)BENZAMIDE AS BTK-INHIBITOR
A61P 37/00 (2006.01)	3495368	(S)-4-(8-AMINO-3-(1-(BUT-2-YNOYL)PYRROLIDIN-2-YL)IMIDAZO[1,5-A]PYRAZIN-1-YL)-2-METHOXY-N-(PYRIDIN-2-YL)BENZAMIDE AS BTK-INHIBITOR
C07D 487/04 (2006.01)	3495368	(S)-4-(8-AMINO-3-(1-(BUT-2-YNOYL)PYRROLIDIN-2-YL)IMIDAZO[1,5-A]PYRAZIN-1-YL)-2-METHOXY-N-(PYRIDIN-2-YL)BENZAMIDE AS BTK-INHIBITOR
C07D 519/00 (2006.01)	3495368	(S)-4-(8-AMINO-3-(1-(BUT-2-YNOYL)PYRROLIDIN-2-YL)IMIDAZO[1,5-A]PYRAZIN-1-YL)-2-METHOXY-N-(PYRIDIN-2-YL)BENZAMIDE AS BTK-INHIBITOR
A61P 21/00 (2006.01)	3498857	DUAL RECEPTOR ANTAGONISTIC ANTIGEN-BINDING PROTEINS AND USES THEREOF
C07H 21/04 (2006.01)	3498857	DUAL RECEPTOR ANTAGONISTIC ANTIGEN-BINDING PROTEINS AND USES THEREOF
C07K 16/00 (2006.01)	3498857	DUAL RECEPTOR ANTAGONISTIC ANTIGEN-BINDING PROTEINS AND USES THEREOF
C12P 21/08 (2006.01)	3498857	DUAL RECEPTOR ANTAGONISTIC ANTIGEN-BINDING PROTEINS AND USES THEREOF
C07D 209/08 (2006.01)	3492474	INTERMEDIATES USED IN THE PRODUCTION OF DIACYLGLYCEROL ACYLTRANSFERASE INHIBITORS
C07D 403/12 (2006.01)	3492474	INTERMEDIATES USED IN THE PRODUCTION OF DIACYLGLYCEROL ACYLTRANSFERASE INHIBITORS
C07D 498/04 (2006.01)	3492474	INTERMEDIATES USED IN THE PRODUCTION OF DIACYLGLYCEROL ACYLTRANSFERASE INHIBITORS

MKP	Broj objave evropske prijave patenta	Naziv pronalaska
(51)	(97)	(54)
C07D 401/14 (2006.01)	3489239	PROCESSES AND INTERMEDIATES FOR MAKING A JAK INHIBITOR
C07D 487/04 (2006.01)	3489239	PROCESSES AND INTERMEDIATES FOR MAKING A JAK INHIBITOR
C07F 5/04 (2006.01)	3489239	PROCESSES AND INTERMEDIATES FOR MAKING A JAK INHIBITOR
A61B 17/072 (2006.01)	3479780	MULTI-LAYER TISSUE THICKNESS COMPENSATOR COMPRISING RESILIENT AND SACRIFICIAL COLLAPSIBLE LAYERS
A61K 31/4545 (2006.01)	3473619	AURORA A KINASE INHIBITOR
A61P 35/00 (2006.01)	3473619	AURORA A KINASE INHIBITOR
C07D 401/14 (2006.01)	3473619	AURORA A KINASE INHIBITOR
B01D 11/02 (2006.01)	3482808	CLOSED-LOOP MULTI-STAGE CHILLED FILTER SYSTEM
B01D 11/04 (2006.01)	3482808	CLOSED-LOOP MULTI-STAGE CHILLED FILTER SYSTEM
B01D 24/00 (2006.01)	3482808	CLOSED-LOOP MULTI-STAGE CHILLED FILTER SYSTEM
B01D 29/56 (2006.01)	3482808	CLOSED-LOOP MULTI-STAGE CHILLED FILTER SYSTEM
B01D 35/18 (2006.01)	3482808	CLOSED-LOOP MULTI-STAGE CHILLED FILTER SYSTEM
F25B 9/00 (2006.01)	3483529	LUBRICANT MONITORING SYSTEM FOR A CIRCUIT COMPRESSOR
F25B 31/00 (2006.01)	3483529	LUBRICANT MONITORING SYSTEM FOR A CIRCUIT COMPRESSOR
F25B 49/00 (2006.01)	3483529	LUBRICANT MONITORING SYSTEM FOR A CIRCUIT COMPRESSOR
C12N 15/10 (2006.01)	3467108	METHODS FOR PURIFICATION OF MESSENGER RNA
A47C 1/032 (2006.01)	3476254	SEATING FURNITURE, IN PARTICULAR AN OFFICE CHAIR
A47C 7/02 (2006.01)	3476254	SEATING FURNITURE, IN PARTICULAR AN OFFICE CHAIR
C09D 5/33 (2006.01)	3555218	COATING REFLECTING SOLAR RADIATION, AND USE THEREOF
C09D 133/02 (2006.01)	3555218	COATING REFLECTING SOLAR RADIATION, AND USE THEREOF
C09D 201/00 (2006.01)	3555218	COATING REFLECTING SOLAR RADIATION, AND USE THEREOF
E01B 19/00 (2006.01)	3555218	COATING REFLECTING SOLAR RADIATION, AND USE THEREOF
A61K 39/395 (2006.01)	3558364	MONOCLONAL ANTI-ALPHA-SYNUCLEIN ANTIBODIES FOR PREVENTING TAU AGGREGATION
A61P 25/28 (2006.01)	3558364	MONOCLONAL ANTI-ALPHA-SYNUCLEIN ANTIBODIES FOR PREVENTING TAU AGGREGATION
C07K 16/18 (2006.01)	3558364	MONOCLONAL ANTI-ALPHA-SYNUCLEIN ANTIBODIES FOR PREVENTING TAU AGGREGATION
A61K 31/427 (2006.01)	3558987	COMBINATION THERAPY WITH AMIDINE SUBSTITUTED β -LACTAM COMPOUNDS AND β -LACTAMASE INHIBITORS FOR INFECTIONS WITH ANTIBIOTIC RESISTANT BACTERIAL STRAINS
A61P 31/04 (2006.01)	3558987	COMBINATION THERAPY WITH AMIDINE SUBSTITUTED β -LACTAM COMPOUNDS AND β -LACTAMASE INHIBITORS FOR INFECTIONS WITH ANTIBIOTIC RESISTANT BACTERIAL STRAINS
C07D 417/12 (2006.01)	3558987	COMBINATION THERAPY WITH AMIDINE SUBSTITUTED β -LACTAM COMPOUNDS AND β -LACTAMASE INHIBITORS FOR INFECTIONS WITH ANTIBIOTIC RESISTANT BACTERIAL STRAINS
A61K 39/00 (2006.01)	3559037	SIRP-GAMMA TARGETED AGENTS FOR USE IN THE TREATMENT OF CANCER
C07K 16/28 (2006.01)	3559037	SIRP-GAMMA TARGETED AGENTS FOR USE IN THE TREATMENT OF CANCER
A61K 38/10 (2006.01)	3558337	METHODS OF TREATING IRRITABLE BOWEL SYNDROME WITH MODIFIED OR DELAYED RELEASE FORMULATIONS OF LINACLOTIDE
A61K 47/32 (2006.01)	3558337	METHODS OF TREATING IRRITABLE BOWEL SYNDROME WITH MODIFIED OR DELAYED RELEASE FORMULATIONS OF LINACLOTIDE
A61P 1/10 (2006.01)	3558337	METHODS OF TREATING IRRITABLE BOWEL SYNDROME WITH MODIFIED OR DELAYED RELEASE FORMULATIONS OF LINACLOTIDE
A23L 33/175 (2016.01)	3554493	AMINO ACID COMPOSITIONS AND METHODS FOR THE TREATMENT OF MUSCLE DISEASES AND DISORDERS
A23L 33/18 (2016.01)	3554493	AMINO ACID COMPOSITIONS AND METHODS FOR THE TREATMENT OF MUSCLE DISEASES AND DISORDERS
A61K 31/198 (2006.01)	3554493	AMINO ACID COMPOSITIONS AND METHODS FOR THE TREATMENT OF MUSCLE DISEASES AND DISORDERS
A61P 21/00 (2006.01)	3554493	AMINO ACID COMPOSITIONS AND METHODS FOR THE TREATMENT OF MUSCLE DISEASES AND DISORDERS
A61P 21/06 (2006.01)	3554493	AMINO ACID COMPOSITIONS AND METHODS FOR THE TREATMENT OF MUSCLE DISEASES AND DISORDERS
A61K 39/00 (2006.01)	3558365	ANTI-NEUROFILIN ANTIGEN-BINDING PROTEINS AND METHODS OF USE THEREOF
A61K 39/395 (2006.01)	3558365	ANTI-NEUROFILIN ANTIGEN-BINDING PROTEINS AND METHODS OF USE THEREOF
A61P 35/00 (2006.01)	3558365	ANTI-NEUROFILIN ANTIGEN-BINDING PROTEINS AND METHODS OF USE THEREOF
C07K 16/28 (2006.01)	3558365	ANTI-NEUROFILIN ANTIGEN-BINDING PROTEINS AND METHODS

MKP (51)	Broj objave evropske prijave patenta (97)	Naziv pronalaska (54)
G01N 33/53 (2006.01)	3558365	OF USE THEREOF
A61K 47/68 (2017.01)	3558391	ANTI-NEUROFILIN ANTIGEN-BINDING PROTEINS AND METHODS OF USE THEREOF
A61P 35/00 (2006.01)	3558391	IMMUNOCONJUGATES TARGETING ADAM9 AND METHODS OF USE THEREOF
C07K 16/28 (2006.01)	3558391	IMMUNOCONJUGATES TARGETING ADAM9 AND METHODS OF USE THEREOF
C07K 16/30 (2006.01)	3558391	IMMUNOCONJUGATES TARGETING ADAM9 AND METHODS OF USE THEREOF
C07K 16/40 (2006.01)	3558391	IMMUNOCONJUGATES TARGETING ADAM9 AND METHODS OF USE THEREOF
A61P 37/00 (2006.01)	3551664	ANTIBODIES AND POLYPEPTIDES DIRECTED AGAINST CD127
C07K 16/28 (2006.01)	3551664	ANTIBODIES AND POLYPEPTIDES DIRECTED AGAINST CD127
A61P 25/16 (2006.01)	3555127	AGENTS, USES AND METHODS
C07K 16/18 (2006.01)	3555127	AGENTS, USES AND METHODS
A61K 31/437 (2006.01)	3558990	TETRAHYDRO IMIDAZO[4,5-C]PYRIDINE DERIVATIVES AS PD-L1 INTERNALIZATION INDUCERS
A61P 35/00 (2006.01)	3558990	TETRAHYDRO IMIDAZO[4,5-C]PYRIDINE DERIVATIVES AS PD-L1 INTERNALIZATION INDUCERS
A61P 37/00 (2006.01)	3558990	TETRAHYDRO IMIDAZO[4,5-C]PYRIDINE DERIVATIVES AS PD-L1 INTERNALIZATION INDUCERS
C07D 471/04 (2006.01)	3558990	TETRAHYDRO IMIDAZO[4,5-C]PYRIDINE DERIVATIVES AS PD-L1 INTERNALIZATION INDUCERS
A01M 29/28 (2011.01)	3550965	METHOD AND DEVICE FOR INFLUENCING INSECTS
A61K 31/4178 (2006.01)	3562490	COMBINATION THERAPY FOR NONALCOHOLIC STEATOHEPATITIS (NASH) AND LIVER FIBROSIS
A61K 31/4375 (2006.01)	3562490	COMBINATION THERAPY FOR NONALCOHOLIC STEATOHEPATITIS (NASH) AND LIVER FIBROSIS
A61K 31/46 (2006.01)	3562490	COMBINATION THERAPY FOR NONALCOHOLIC STEATOHEPATITIS (NASH) AND LIVER FIBROSIS
A61K 31/506 (2006.01)	3562490	COMBINATION THERAPY FOR NONALCOHOLIC STEATOHEPATITIS (NASH) AND LIVER FIBROSIS
A61K 31/575 (2006.01)	3562490	COMBINATION THERAPY FOR NONALCOHOLIC STEATOHEPATITIS (NASH) AND LIVER FIBROSIS
A61P 1/16 (2006.01)	3562490	COMBINATION THERAPY FOR NONALCOHOLIC STEATOHEPATITIS (NASH) AND LIVER FIBROSIS
A61P 11/00 (2006.01)	3562490	COMBINATION THERAPY FOR NONALCOHOLIC STEATOHEPATITIS (NASH) AND LIVER FIBROSIS
A61P 13/12 (2006.01)	3562490	COMBINATION THERAPY FOR NONALCOHOLIC STEATOHEPATITIS (NASH) AND LIVER FIBROSIS
C07D 265/30 (2006.01)	3558953	METHOD FOR THE MANUFACTURING OF 2-(3-(ALKYL AND ALKENYL)MORPHOLINO)-ETHAN-1-OLS
C07D 498/04 (2006.01)	3558953	METHOD FOR THE MANUFACTURING OF 2-(3-(ALKYL AND ALKENYL)MORPHOLINO)-ETHAN-1-OLS
A41D 13/05 (2006.01)	3562344	UNDERGARMENT
A61K 35/26 (2015.01)	3514172	CLAUDIN-6-SPECIFIC IMMUNORECEPTORS AND T CELL EPITOPES
A61P 35/00 (2006.01)	3514172	CLAUDIN-6-SPECIFIC IMMUNORECEPTORS AND T CELL EPITOPES
C07K 14/47 (2006.01)	3514172	CLAUDIN-6-SPECIFIC IMMUNORECEPTORS AND T CELL EPITOPES
C07K 14/725 (2006.01)	3514172	CLAUDIN-6-SPECIFIC IMMUNORECEPTORS AND T CELL EPITOPES
A61K 31/58 (2006.01)	3517541	POLYMORPHIC FORM OF FLUTICASONE PROPIONATE
A61P 5/44 (2006.01)	3517541	POLYMORPHIC FORM OF FLUTICASONE PROPIONATE
C07J 31/00 (2006.01)	3517541	POLYMORPHIC FORM OF FLUTICASONE PROPIONATE
C07J 71/00 (2006.01)	3517541	POLYMORPHIC FORM OF FLUTICASONE PROPIONATE
A61B 1/00 (2006.01)	3539448	METHOD FOR IDENTIFYING OBJECTS IN A SUBJECT'S EAR
A61B 1/05 (2006.01)	3539448	METHOD FOR IDENTIFYING OBJECTS IN A SUBJECT'S EAR
A61B 1/227 (2006.01)	3539448	METHOD FOR IDENTIFYING OBJECTS IN A SUBJECT'S EAR
B65B 25/14 (2006.01)	3530576	TRAY FILLING APPARATUS FOR LEAFLETS
B65B 35/36 (2006.01)	3530576	TRAY FILLING APPARATUS FOR LEAFLETS
B65B 35/50 (2006.01)	3530576	TRAY FILLING APPARATUS FOR LEAFLETS
B65B 43/26 (2006.01)	3530576	TRAY FILLING APPARATUS FOR LEAFLETS
B65G 61/00 (2006.01)	3530576	TRAY FILLING APPARATUS FOR LEAFLETS
B62D 55/28 (2006.01)	3552931	CLIMBING AID

MKP	Broj objave evropske prijave patenta	Naziv pronalaska
(51)	(97)	(54)
A61K 39/00 (2006.01)	3552665	ANTIBODIES
A61P 35/00 (2006.01)	3552665	ANTIBODIES
C07K 16/28 (2006.01)	3552665	ANTIBODIES
A61K 39/00 (2006.01)	3552665	ANTIBODIES
A61P 35/00 (2006.01)	3552665	ANTIBODIES
C07K 16/28 (2006.01)	3552665	ANTIBODIES
A61K 31/713 (2006.01)	3587578	TMPRSS6 IRNA COMPOSITIONS AND METHODS OF USE THEREOF
C12N 9/64 (2006.01)	3587578	TMPRSS6 IRNA COMPOSITIONS AND METHODS OF USE THEREOF
C12N 15/113 (2010.01)	3587578	TMPRSS6 IRNA COMPOSITIONS AND METHODS OF USE THEREOF
A61K 31/506 (2006.01)	3578554	INHIBITORS OF INFLUENZA VIRUSES REPLICATION
A61P 31/16 (2006.01)	3578554	INHIBITORS OF INFLUENZA VIRUSES REPLICATION
C07D 403/04 (2006.01)	3578554	INHIBITORS OF INFLUENZA VIRUSES REPLICATION
C07D 471/04 (2006.01)	3578554	INHIBITORS OF INFLUENZA VIRUSES REPLICATION
A61J 1/10 (2006.01)	3545935	STERILE FLEXIBLE PACKAGE WITH PRESSURE COMPENSATOR FOR THE DOSED RECONSTITUTION OF FLUID MEDICINAL OR NUTRITIONAL SUBSTANCES TO BE ADMINISTERED TO PATIENTS BY INFUSION OR INJECTION
A61J 1/14 (2006.01)	3545935	STERILE FLEXIBLE PACKAGE WITH PRESSURE COMPENSATOR FOR THE DOSED RECONSTITUTION OF FLUID MEDICINAL OR NUTRITIONAL SUBSTANCES TO BE ADMINISTERED TO PATIENTS BY INFUSION OR INJECTION
A61J 1/20 (2006.01)	3545935	STERILE FLEXIBLE PACKAGE WITH PRESSURE COMPENSATOR FOR THE DOSED RECONSTITUTION OF FLUID MEDICINAL OR NUTRITIONAL SUBSTANCES TO BE ADMINISTERED TO PATIENTS BY INFUSION OR INJECTION
A61J 1/22 (2006.01)	3545935	STERILE FLEXIBLE PACKAGE WITH PRESSURE COMPENSATOR FOR THE DOSED RECONSTITUTION OF FLUID MEDICINAL OR NUTRITIONAL SUBSTANCES TO BE ADMINISTERED TO PATIENTS BY INFUSION OR INJECTION
A61K 38/17 (2006.01)	3539979	PERSONALIZED IMMUNOTHERAPY AGAINST SEVERAL NEURONAL AND BRAIN TUMORS
A61K 39/00 (2006.01)	3539979	PERSONALIZED IMMUNOTHERAPY AGAINST SEVERAL NEURONAL AND BRAIN TUMORS
C07K 7/06 (2006.01)	3539979	PERSONALIZED IMMUNOTHERAPY AGAINST SEVERAL NEURONAL AND BRAIN TUMORS
C07K 7/08 (2006.01)	3539979	PERSONALIZED IMMUNOTHERAPY AGAINST SEVERAL NEURONAL AND BRAIN TUMORS
C07K 14/47 (2006.01)	3539979	PERSONALIZED IMMUNOTHERAPY AGAINST SEVERAL NEURONAL AND BRAIN TUMORS
A61K 51/04 (2006.01)	3533473	COMPOUNDS FOR POSITRON EMISSION TOMOGRAPHY
A61K 39/00 (2006.01)	3539988	MONOCLONAL ANTIBODIES AGAINST HER2
C07K 16/28 (2006.01)	3539988	MONOCLONAL ANTIBODIES AGAINST HER2
C07K 16/32 (2006.01)	3539988	MONOCLONAL ANTIBODIES AGAINST HER2
E06B 3/66 (2006.01)	3567200	PRESSURE COMPENSATED GLASS UNIT
E06B 3/663 (2006.01)	3567200	PRESSURE COMPENSATED GLASS UNIT
E06B 3/667 (2006.01)	3567200	PRESSURE COMPENSATED GLASS UNIT
E06B 3/67 (2006.01)	3567200	PRESSURE COMPENSATED GLASS UNIT
E06B 3/677 (2006.01)	3567200	PRESSURE COMPENSATED GLASS UNIT
A61K 38/04 (2006.01)	3545965	NOVEL PEPTIDES AND COMBINATION OF PEPTIDES FOR USE IN IMMUNOTHERAPY AGAINST HEPATOCELLULAR CARCINOMA (HCC) AND OTHER CANCERS
A61P 35/00 (2006.01)	3545965	NOVEL PEPTIDES AND COMBINATION OF PEPTIDES FOR USE IN IMMUNOTHERAPY AGAINST HEPATOCELLULAR CARCINOMA (HCC) AND OTHER CANCERS
C07K 7/00 (2006.01)	3545965	NOVEL PEPTIDES AND COMBINATION OF PEPTIDES FOR USE IN IMMUNOTHERAPY AGAINST HEPATOCELLULAR CARCINOMA (HCC) AND OTHER CANCERS
C07K 7/06 (2006.01)	3545965	NOVEL PEPTIDES AND COMBINATION OF PEPTIDES FOR USE IN IMMUNOTHERAPY AGAINST HEPATOCELLULAR CARCINOMA (HCC) AND OTHER CANCERS
C07K 7/08 (2006.01)	3545965	NOVEL PEPTIDES AND COMBINATION OF PEPTIDES FOR USE IN IMMUNOTHERAPY AGAINST HEPATOCELLULAR CARCINOMA (HCC) AND OTHER CANCERS
B28B 7/36 (2006.01)	3536867	METHOD FOR PRODUCING A MOULDED ARTICLE
E03F 5/02 (2006.01)	3536867	METHOD FOR PRODUCING A MOULDED ARTICLE

MKP	Broj objave evropske prijave patenta	Naziv pronalaska
(51)	(97)	(54)
C12N 15/67 (2006.01)	3578659	ARTIFICIAL NUCLEIC ACID MOLECULES FOR IMPROVED PROTEIN OR PEPTIDE EXPRESSION
A61K 38/17 (2006.01)	3578196	NOVEL IMMUNOTHERAPY AGAINST SEVERAL TUMORS, SUCH AS LUNG CANCER, INCLUDING NSCLC
A61K 39/00 (2006.01)	3578196	NOVEL IMMUNOTHERAPY AGAINST SEVERAL TUMORS, SUCH AS LUNG CANCER, INCLUDING NSCLC
C07K 7/06 (2006.01)	3578196	NOVEL IMMUNOTHERAPY AGAINST SEVERAL TUMORS, SUCH AS LUNG CANCER, INCLUDING NSCLC
C07K 7/08 (2006.01)	3578196	NOVEL IMMUNOTHERAPY AGAINST SEVERAL TUMORS, SUCH AS LUNG CANCER, INCLUDING NSCLC
C12N 5/0783 (2010.01)	3578196	NOVEL IMMUNOTHERAPY AGAINST SEVERAL TUMORS, SUCH AS LUNG CANCER, INCLUDING NSCLC
C12N 9/64 (2006.01)	3578196	NOVEL IMMUNOTHERAPY AGAINST SEVERAL TUMORS, SUCH AS LUNG CANCER, INCLUDING NSCLC
C12N 5/0735 (2010.01)	3578988	METHOD OF NOCICEPTOR DIFFERENTIATION OF HUMAN EMBRYONIC STEM CELLS AND USES THEREOF
C12Q 1/68 (2018.01)	3578988	METHOD OF NOCICEPTOR DIFFERENTIATION OF HUMAN EMBRYONIC STEM CELLS AND USES THEREOF
G01N 33/15 (2006.01)	3578988	METHOD OF NOCICEPTOR DIFFERENTIATION OF HUMAN EMBRYONIC STEM CELLS AND USES THEREOF
G01N 33/68 (2006.01)	3578988	METHOD OF NOCICEPTOR DIFFERENTIATION OF HUMAN EMBRYONIC STEM CELLS AND USES THEREOF
A61K 39/00 (2006.01)	3574916	COMPOSITION AND VACCINE FOR TREATING LUNG CANCER
A61P 35/00 (2006.01)	3574916	COMPOSITION AND VACCINE FOR TREATING LUNG CANCER
A61K 39/395 (2006.01)	3572093	FGFR FUSIONS
C07K 14/435 (2006.01)	3572093	FGFR FUSIONS
A61K 39/395 (2006.01)	3572093	FGFR FUSIONS
C07K 14/435 (2006.01)	3572093	FGFR FUSIONS
A61K 31/13 (2006.01)	3583940	THERAPEUTIC AGENTS FOR NEURODEGENERATIVE DISEASES
A61P 25/28 (2006.01)	3583940	THERAPEUTIC AGENTS FOR NEURODEGENERATIVE DISEASES
A61K 39/12 (2006.01)	3566714	INFLUENZA VIRUS VACCINES AND USES THEREOF
C07K 14/005 (2006.01)	3566714	INFLUENZA VIRUS VACCINES AND USES THEREOF
A61K 31/415 (2006.01)	3556752	N-((HET)ARYLMETHYL)-HETEROARYL-CARBOXAMIDES COMPOUNDS AS PLASMA KALLIKREIN INHIBITORS
A61K 31/454 (2006.01)	3556752	N-((HET)ARYLMETHYL)-HETEROARYL-CARBOXAMIDES COMPOUNDS AS PLASMA KALLIKREIN INHIBITORS
A61K 31/4709 (2006.01)	3556752	N-((HET)ARYLMETHYL)-HETEROARYL-CARBOXAMIDES COMPOUNDS AS PLASMA KALLIKREIN INHIBITORS
A61K 31/497 (2006.01)	3556752	N-((HET)ARYLMETHYL)-HETEROARYL-CARBOXAMIDES COMPOUNDS AS PLASMA KALLIKREIN INHIBITORS
A61K 31/506 (2006.01)	3556752	N-((HET)ARYLMETHYL)-HETEROARYL-CARBOXAMIDES COMPOUNDS AS PLASMA KALLIKREIN INHIBITORS
C07D 231/14 (2006.01)	3556752	N-((HET)ARYLMETHYL)-HETEROARYL-CARBOXAMIDES COMPOUNDS AS PLASMA KALLIKREIN INHIBITORS
C07D 401/06 (2006.01)	3556752	N-((HET)ARYLMETHYL)-HETEROARYL-CARBOXAMIDES COMPOUNDS AS PLASMA KALLIKREIN INHIBITORS
C07D 401/10 (2006.01)	3556752	N-((HET)ARYLMETHYL)-HETEROARYL-CARBOXAMIDES COMPOUNDS AS PLASMA KALLIKREIN INHIBITORS
C07D 401/14 (2006.01)	3556752	N-((HET)ARYLMETHYL)-HETEROARYL-CARBOXAMIDES COMPOUNDS AS PLASMA KALLIKREIN INHIBITORS
C07D 403/10 (2006.01)	3556752	N-((HET)ARYLMETHYL)-HETEROARYL-CARBOXAMIDES COMPOUNDS AS PLASMA KALLIKREIN INHIBITORS
C07D 409/14 (2006.01)	3556752	N-((HET)ARYLMETHYL)-HETEROARYL-CARBOXAMIDES COMPOUNDS AS PLASMA KALLIKREIN INHIBITORS
C07D 413/14 (2006.01)	3556752	N-((HET)ARYLMETHYL)-HETEROARYL-CARBOXAMIDES COMPOUNDS AS PLASMA KALLIKREIN INHIBITORS
C07K 16/12 (2006.01)	3594232	METHODS AND MEANS FOR THE PRODUCTION OF IG-LIKE MOLECULES
C07K 16/26 (2006.01)	3594232	METHODS AND MEANS FOR THE PRODUCTION OF IG-LIKE MOLECULES
C07K 16/36 (2006.01)	3594232	METHODS AND MEANS FOR THE PRODUCTION OF IG-LIKE MOLECULES
C07K 16/46 (2006.01)	3594232	METHODS AND MEANS FOR THE PRODUCTION OF IG-LIKE MOLECULES
C01B 32/20 (2017.01)	3578512	GRAPHITE PRODUCTION FROM BIOMASS
C01B 32/205 (2017.01)	3578512	GRAPHITE PRODUCTION FROM BIOMASS
C07K 16/12 (2006.01)	3594232	METHODS AND MEANS FOR THE PRODUCTION OF IG-LIKE MOLECULES

MKP	Broj objave evropske prijave patenta (97)	Naziv pronalaska (54)
(51)		
C07K 16/26 (2006.01)	3594233	METHODS AND MEANS FOR THE PRODUCTION OF IG-LIKE MOLECULES
C07K 16/36 (2006.01)	3594233	METHODS AND MEANS FOR THE PRODUCTION OF IG-LIKE MOLECULES
C07K 16/46 (2006.01)	3594233	METHODS AND MEANS FOR THE PRODUCTION OF IG-LIKE MOLECULES
A61K 31/7088 (2006.01)	3564380	RECOMBINANT ADENOVIRUSES AND USE THEREOF
A61K 35/76 (2015.01)	3564380	RECOMBINANT ADENOVIRUSES AND USE THEREOF
C12N 7/01 (2006.01)	3564380	RECOMBINANT ADENOVIRUSES AND USE THEREOF
C12N 15/861 (2006.01)	3564380	RECOMBINANT ADENOVIRUSES AND USE THEREOF
A61K 39/00 (2006.01)	3564378	IMMUNOGENIC COMPOSITION
A61K 39/08 (2006.01)	3564378	IMMUNOGENIC COMPOSITION
C07K 14/33 (2006.01)	3564378	IMMUNOGENIC COMPOSITION
C07K 16/12 (2006.01)	3564378	IMMUNOGENIC COMPOSITION
C12N 15/62 (2006.01)	3564378	IMMUNOGENIC COMPOSITION
C12N 15/70 (2006.01)	3564378	IMMUNOGENIC COMPOSITION
C04B 28/14 (2006.01)	3564199	CONSTRUCTION PANEL HAVING IMPROVED FIXING STRENGTH AND METHOD FOR THE MANUFACTURE THEREOF
C04B 111/00 (2006.01)	3564199	CONSTRUCTION PANEL HAVING IMPROVED FIXING STRENGTH AND METHOD FOR THE MANUFACTURE THEREOF
A61K 39/00 (2006.01)	3572432	ICOS BINDING PROTEINS
A61P 31/00 (2006.01)	3572432	ICOS BINDING PROTEINS
A61P 35/00 (2006.01)	3572432	ICOS BINDING PROTEINS
A61P 37/00 (2006.01)	3572432	ICOS BINDING PROTEINS
C07K 16/28 (2006.01)	3572432	ICOS BINDING PROTEINS
A61K 39/00 (2006.01)	3575324	ICOS BINDING PROTEINS
A61P 31/00 (2006.01)	3575324	ICOS BINDING PROTEINS
A61P 35/00 (2006.01)	3575324	ICOS BINDING PROTEINS
A61P 37/00 (2006.01)	3575324	ICOS BINDING PROTEINS
C07K 16/28 (2006.01)	3575324	ICOS BINDING PROTEINS
A61K 31/415 (2006.01)	3567037	N-((HET)ARYLMETHYL)-HETEROARYL-CARBOXAMIDES COMPOUNDS AS PLASMA KALLIKREIN INHIBITORS
A61K 31/454 (2006.01)	3567037	N-((HET)ARYLMETHYL)-HETEROARYL-CARBOXAMIDES COMPOUNDS AS PLASMA KALLIKREIN INHIBITORS
A61K 31/4709 (2006.01)	3567037	N-((HET)ARYLMETHYL)-HETEROARYL-CARBOXAMIDES COMPOUNDS AS PLASMA KALLIKREIN INHIBITORS
A61K 31/497 (2006.01)	3567037	N-((HET)ARYLMETHYL)-HETEROARYL-CARBOXAMIDES COMPOUNDS AS PLASMA KALLIKREIN INHIBITORS
A61K 31/506 (2006.01)	3567037	N-((HET)ARYLMETHYL)-HETEROARYL-CARBOXAMIDES COMPOUNDS AS PLASMA KALLIKREIN INHIBITORS
C07D 231/14 (2006.01)	3567037	N-((HET)ARYLMETHYL)-HETEROARYL-CARBOXAMIDES COMPOUNDS AS PLASMA KALLIKREIN INHIBITORS
C07D 401/06 (2006.01)	3567037	N-((HET)ARYLMETHYL)-HETEROARYL-CARBOXAMIDES COMPOUNDS AS PLASMA KALLIKREIN INHIBITORS
C07D 401/10 (2006.01)	3567037	N-((HET)ARYLMETHYL)-HETEROARYL-CARBOXAMIDES COMPOUNDS AS PLASMA KALLIKREIN INHIBITORS
C07D 401/14 (2006.01)	3567037	N-((HET)ARYLMETHYL)-HETEROARYL-CARBOXAMIDES COMPOUNDS AS PLASMA KALLIKREIN INHIBITORS
C07D 403/10 (2006.01)	3567037	N-((HET)ARYLMETHYL)-HETEROARYL-CARBOXAMIDES COMPOUNDS AS PLASMA KALLIKREIN INHIBITORS
C07D 409/14 (2006.01)	3567037	N-((HET)ARYLMETHYL)-HETEROARYL-CARBOXAMIDES COMPOUNDS AS PLASMA KALLIKREIN INHIBITORS
C07D 413/14 (2006.01)	3567037	N-((HET)ARYLMETHYL)-HETEROARYL-CARBOXAMIDES COMPOUNDS AS PLASMA KALLIKREIN INHIBITORS
F16L 41/08 (2006.01)	3567293	SYSTEM FOR COOLING A FLOW OR FOR EXTRACTING HEAT OUT OF A FLOW THROUGH A PIPELINE AND/OR FOR EXTRACTING HEAT OUT OF A SURROUNDING OF A PIPELINE AND A METHOD FOR PROVIDING SUCH A SYSTEM
A61K 9/00 (2006.01)	3593788	OPHTHALMIC COMPOSITIONS CONTAINING A NITRIC OXIDE RELEASING PROSTAMIDE
A61K 9/08 (2006.01)	3593788	OPHTHALMIC COMPOSITIONS CONTAINING A NITRIC OXIDE RELEASING PROSTAMIDE
A61K 31/5575 (2006.01)	3593788	OPHTHALMIC COMPOSITIONS CONTAINING A NITRIC OXIDE RELEASING PROSTAMIDE
A61K 47/14 (2017.01)	3593788	OPHTHALMIC COMPOSITIONS CONTAINING A NITRIC OXIDE RELEASING PROSTAMIDE
A61P 27/06 (2006.01)	3593788	OPHTHALMIC COMPOSITIONS CONTAINING A NITRIC OXIDE RELEASING PROSTAMIDE

MKP	Broj objave evropske prijave patenta (97)	Naziv pronalaska (54)
(51)		(54)
G06Q 20/32 (2012.01)	3594881	PROCEDURE TO EFFECT AUTHENTICATED PAYMENTS WITH A MOBILE DEVICE OF THE PURCHASER
G06Q 20/38 (2012.01)	3594881	PROCEDURE TO EFFECT AUTHENTICATED PAYMENTS WITH A MOBILE DEVICE OF THE PURCHASER
G06Q 20/42 (2012.01)	3594881	PROCEDURE TO EFFECT AUTHENTICATED PAYMENTS WITH A MOBILE DEVICE OF THE PURCHASER
C07K 14/16 (2006.01)	3584252	HUMAN IMMUNODEFICIENCY VIRUS ANTIGENS, VECTORS, COMPOSITIONS, AND METHODS OF USE THEREOF
C07D 231/18 (2006.01)	3578547	SULFONYLUREAS AND RELATED COMPOUNDS AND USE OF SAME
A61K 31/422 (2006.01)	3587412	FXR (NR1H4) MODULATING COMPOUNDS
A61K 31/4439 (2006.01)	3587412	FXR (NR1H4) MODULATING COMPOUNDS
A61P 1/16 (2006.01)	3587412	FXR (NR1H4) MODULATING COMPOUNDS
A61P 3/04 (2006.01)	3587412	FXR (NR1H4) MODULATING COMPOUNDS
A61P 3/10 (2006.01)	3587412	FXR (NR1H4) MODULATING COMPOUNDS
A61P 29/00 (2006.01)	3587412	FXR (NR1H4) MODULATING COMPOUNDS
A61P 35/00 (2006.01)	3587412	FXR (NR1H4) MODULATING COMPOUNDS
C07D 401/14 (2006.01)	3587412	FXR (NR1H4) MODULATING COMPOUNDS
C07D 413/12 (2006.01)	3587412	FXR (NR1H4) MODULATING COMPOUNDS
C07D 413/14 (2006.01)	3587412	FXR (NR1H4) MODULATING COMPOUNDS
A61K 31/437 (2006.01)	3581573	SYNTHESIS OF A COMPOUND THAT MODULATES KINASES
A61P 35/00 (2006.01)	3581573	SYNTHESIS OF A COMPOUND THAT MODULATES KINASES
C07D 471/04 (2006.01)	3581573	SYNTHESIS OF A COMPOUND THAT MODULATES KINASES
A61B 17/17 (2006.01)	3573548	APPARATUS AND METHODS WITH SURGICAL GUIDES HAVING ROUTED LIQUID COOLANT IRRIGATION
A61B 17/56 (2006.01)	3573548	APPARATUS AND METHODS WITH SURGICAL GUIDES HAVING ROUTED LIQUID COOLANT IRRIGATION
A61B 17/88 (2006.01)	3573548	APPARATUS AND METHODS WITH SURGICAL GUIDES HAVING ROUTED LIQUID COOLANT IRRIGATION
A61B 17/90 (2006.01)	3573548	APPARATUS AND METHODS WITH SURGICAL GUIDES HAVING ROUTED LIQUID COOLANT IRRIGATION
A61C 3/04 (2006.01)	3573548	APPARATUS AND METHODS WITH SURGICAL GUIDES HAVING ROUTED LIQUID COOLANT IRRIGATION
A61C 8/00 (2006.01)	3573548	APPARATUS AND METHODS WITH SURGICAL GUIDES HAVING ROUTED LIQUID COOLANT IRRIGATION
C09K 11/08 (2006.01)	3592825	GARNET SCINTILLATOR CO-DOPED WITH MONOVALENT ION
C09K 11/77 (2006.01)	3592825	GARNET SCINTILLATOR CO-DOPED WITH MONOVALENT ION
C09K 11/80 (2006.01)	3592825	GARNET SCINTILLATOR CO-DOPED WITH MONOVALENT ION
G01T 1/00 (2006.01)	3592825	GARNET SCINTILLATOR CO-DOPED WITH MONOVALENT ION
G01T 1/02 (2006.01)	3592825	GARNET SCINTILLATOR CO-DOPED WITH MONOVALENT ION
G01T 1/20 (2006.01)	3592825	GARNET SCINTILLATOR CO-DOPED WITH MONOVALENT ION
F01K 25/10 (2006.01)	3587752	WORKING MEDIUM CHARACTERISTIC DIFFERENCE POWER GENERATION SYSTEM AND WORKING MEDIUM CHARACTERISTIC DIFFERENCE POWER GENERATION METHOD IN WHICH SAID POWER GENERATION SYSTEM IS USED
H02K 7/18 (2006.01)	3587752	WORKING MEDIUM CHARACTERISTIC DIFFERENCE POWER GENERATION SYSTEM AND WORKING MEDIUM CHARACTERISTIC DIFFERENCE POWER GENERATION METHOD IN WHICH SAID POWER GENERATION SYSTEM IS USED
H02K 35/02 (2006.01)	3587752	WORKING MEDIUM CHARACTERISTIC DIFFERENCE POWER GENERATION SYSTEM AND WORKING MEDIUM CHARACTERISTIC DIFFERENCE POWER GENERATION METHOD IN WHICH SAID POWER GENERATION SYSTEM IS USED
A61K 31/53 (2006.01)	3556761	PYRROLO-AROMATIC HETEROCYCLIC COMPOUND, PREPARATION METHOD THEREFOR, AND MEDICAL USE THEREOF
A61P 35/00 (2006.01)	3556761	PYRROLO-AROMATIC HETEROCYCLIC COMPOUND, PREPARATION METHOD THEREFOR, AND MEDICAL USE THEREOF
C07D 487/04 (2006.01)	3556761	PYRROLO-AROMATIC HETEROCYCLIC COMPOUND, PREPARATION METHOD THEREFOR, AND MEDICAL USE THEREOF
A61K 31/133 (2006.01)	3592357	METHODS OF TREATING CANCER
A61K 31/56 (2006.01)	3592357	METHODS OF TREATING CANCER
A61K 31/575 (2006.01)	3592357	METHODS OF TREATING CANCER
C07J 5/00 (2006.01)	3592357	METHODS OF TREATING CANCER
C07J 9/00 (2006.01)	3592357	METHODS OF TREATING CANCER
C07J 31/00 (2006.01)	3592357	METHODS OF TREATING CANCER

MKP	Broj objave evropske prijave patenta (97)	Naziv pronalaska (54)
(51)		(54)
A61K 31/337 (2006.01)	3577110	ATAZANAVIR (ATV) ANALOGUES FOR TREATING HIV INFECTIONS
A61K 31/4155 (2006.01)	3577110	ATAZANAVIR (ATV) ANALOGUES FOR TREATING HIV INFECTIONS
A61K 31/495 (2006.01)	3577110	ATAZANAVIR (ATV) ANALOGUES FOR TREATING HIV INFECTIONS
A61K 31/504 (2006.01)	3577110	ATAZANAVIR (ATV) ANALOGUES FOR TREATING HIV INFECTIONS
A61K 31/506 (2006.01)	3577110	ATAZANAVIR (ATV) ANALOGUES FOR TREATING HIV INFECTIONS
A61K 31/5365 (2006.01)	3577110	ATAZANAVIR (ATV) ANALOGUES FOR TREATING HIV INFECTIONS
C07C 243/28 (2006.01)	3577110	ATAZANAVIR (ATV) ANALOGUES FOR TREATING HIV INFECTIONS
C07C 275/16 (2006.01)	3577110	ATAZANAVIR (ATV) ANALOGUES FOR TREATING HIV INFECTIONS
C07D 401/12 (2006.01)	3577110	ATAZANAVIR (ATV) ANALOGUES FOR TREATING HIV INFECTIONS
C07D 403/12 (2006.01)	3577110	ATAZANAVIR (ATV) ANALOGUES FOR TREATING HIV INFECTIONS
C07D 405/14 (2006.01)	3577110	ATAZANAVIR (ATV) ANALOGUES FOR TREATING HIV INFECTIONS
C07D 471/08 (2006.01)	3577110	ATAZANAVIR (ATV) ANALOGUES FOR TREATING HIV INFECTIONS
C07D 487/08 (2006.01)	3577110	ATAZANAVIR (ATV) ANALOGUES FOR TREATING HIV INFECTIONS
C07D 487/10 (2006.01)	3577110	ATAZANAVIR (ATV) ANALOGUES FOR TREATING HIV INFECTIONS
C07D 491/04 (2006.01)	3577110	ATAZANAVIR (ATV) ANALOGUES FOR TREATING HIV INFECTIONS
A61L 17/00 (2006.01)	3579889	BRAIDED SUTURE WITH FILAMENT CONTAINING A MEDICANT
A61L 17/10 (2006.01)	3579889	BRAIDED SUTURE WITH FILAMENT CONTAINING A MEDICANT
A61L 17/14 (2006.01)	3579889	BRAIDED SUTURE WITH FILAMENT CONTAINING A MEDICANT
A61K 39/00 (2006.01)	3580238	RADIOLABELED ANTI-LAG3 ANTIBODIES FOR IMMUNO-PET IMAGING
A61K 51/10 (2006.01)	3580238	RADIOLABELED ANTI-LAG3 ANTIBODIES FOR IMMUNO-PET IMAGING
C07C 259/00 (2006.01)	3580238	RADIOLABELED ANTI-LAG3 ANTIBODIES FOR IMMUNO-PET IMAGING
C07K 16/28 (2006.01)	3580238	RADIOLABELED ANTI-LAG3 ANTIBODIES FOR IMMUNO-PET IMAGING
C07D 209/10 (2006.01)	3585780	ARYL HYDROCARBON RECEPTOR (AHR) MODULATOR COMPOUNDS
C07D 401/12 (2006.01)	3585780	ARYL HYDROCARBON RECEPTOR (AHR) MODULATOR COMPOUNDS
C07D 403/12 (2006.01)	3585780	ARYL HYDROCARBON RECEPTOR (AHR) MODULATOR COMPOUNDS
C07D 405/12 (2006.01)	3585780	ARYL HYDROCARBON RECEPTOR (AHR) MODULATOR COMPOUNDS
A61K 39/395 (2006.01)	3576788	LOW PH PHARMACEUTICAL COMPOSITION COMPRISING T CELL ENGAGING ANTIBODY CONSTRUCTS
C07K 16/28 (2006.01)	3576788	LOW PH PHARMACEUTICAL COMPOSITION COMPRISING T CELL ENGAGING ANTIBODY CONSTRUCTS
C12Q 1/6886 (2018.01)	3585908	AN INHIBITOR OF ATR KINASE FOR USE IN A METHOD OF TREATING A HYPER-PROLIFERATIVE DISEASE
B24B 3/54 (2006.01)	3576907	SHARPENING DEVICE
A61K 31/44 (2006.01)	3580203	HYDROCARBYLSULFONYL-SUBSTITUTED PYRIDINES AND THEIR USE IN THE TREATMENT OF CANCER
A61P 35/00 (2006.01)	3580203	HYDROCARBYLSULFONYL-SUBSTITUTED PYRIDINES AND THEIR USE IN THE TREATMENT OF CANCER
C07D 213/71 (2006.01)	3580203	HYDROCARBYLSULFONYL-SUBSTITUTED PYRIDINES AND THEIR USE IN THE TREATMENT OF CANCER
C07D 401/12 (2006.01)	3580203	HYDROCARBYLSULFONYL-SUBSTITUTED PYRIDINES AND THEIR USE IN THE TREATMENT OF CANCER
C07D 405/12 (2006.01)	3580203	HYDROCARBYLSULFONYL-SUBSTITUTED PYRIDINES AND THEIR USE IN THE TREATMENT OF CANCER
B42C 7/00 (2006.01)	3573840	AUTOMATIC MACHINE AND METHOD FOR COVERING THE COVERS OF BOOKS
B42C 15/00 (2006.01)	3573840	AUTOMATIC MACHINE AND METHOD FOR COVERING THE COVERS OF BOOKS
A61K 31/437 (2006.01)	3577115	ARYL HYDROCARBON RECEPTOR (AHR) MODULATOR COMPOUNDS
A61P 35/00 (2006.01)	3577115	ARYL HYDROCARBON RECEPTOR (AHR) MODULATOR COMPOUNDS
C07D 471/04 (2006.01)	3577115	ARYL HYDROCARBON RECEPTOR (AHR) MODULATOR COMPOUNDS
A61P 37/06 (2006.01)	3583128	NEW USES OF ANTI-SIRPG ANTIBODIES
C07K 16/28 (2006.01)	3583128	NEW USES OF ANTI-SIRPG ANTIBODIES
A61K 38/09 (2006.01)	3573663	A composition comprising at least one GNRH antagonist
A61K 45/06 (2006.01)	3573663	A composition comprising at least one GNRH antagonist
A61P 35/00 (2006.01)	3573663	A composition comprising at least one GNRH antagonist
A61K 39/395 (2006.01)	3577139	ANTI-CCR7 ANTIBODY DRUG CONJUGATES
A61K 47/68 (2017.01)	3577139	ANTI-CCR7 ANTIBODY DRUG CONJUGATES

MKP	Broj objave evropske prijave patenta	Naziv pronalaska
(51)	(97)	(54)
C07K 16/28 (2006.01)	3577139	ANTI-CCR7 ANTIBODY DRUG CONJUGATES
A61D 1/02 (2006.01)	3579787	LIQUID APPLICATOR FOR DELIVERING VACCINES
A61D 7/00 (2006.01)	3579787	LIQUID APPLICATOR FOR DELIVERING VACCINES
A61J 1/06 (2006.01)	3579787	LIQUID APPLICATOR FOR DELIVERING VACCINES
A61K 47/60 (2017.01)	3585441	THERAPEUTIC DENDRIMERS
A61P 35/00 (2006.01)	3585441	THERAPEUTIC DENDRIMERS
C08G 69/10 (2006.01)	3585441	THERAPEUTIC DENDRIMERS
C08G 69/40 (2006.01)	3585441	THERAPEUTIC DENDRIMERS
C08G 83/00 (2006.01)	3585441	THERAPEUTIC DENDRIMERS
A61K 31/437 (2006.01)	3589323	COMBINATION THERAPY
A61K 31/438 (2006.01)	3589323	COMBINATION THERAPY
A61K 31/4545 (2006.01)	3589323	COMBINATION THERAPY
A61K 31/47 (2006.01)	3589323	COMBINATION THERAPY
A61K 31/4965 (2006.01)	3589323	COMBINATION THERAPY
A61K 31/498 (2006.01)	3589323	COMBINATION THERAPY
A61K 45/06 (2006.01)	3589323	COMBINATION THERAPY
A61P 31/06 (2006.01)	3589323	COMBINATION THERAPY
A61K 38/00 (2006.01)	3589954	PEPTIDE VACCINES
G01N 33/569 (2006.01)	3589954	PEPTIDE VACCINES
A61K 39/00 (2006.01)	3589310	PERSONALISED IMMUNOGENIC PEPTIDE IDENTIFICATION PLATFORM
A61K 39/12 (2006.01)	3589310	PERSONALISED IMMUNOGENIC PEPTIDE IDENTIFICATION PLATFORM
G01N 33/50 (2006.01)	3589310	PERSONALISED IMMUNOGENIC PEPTIDE IDENTIFICATION PLATFORM
G01N 33/569 (2006.01)	3589310	PERSONALISED IMMUNOGENIC PEPTIDE IDENTIFICATION PLATFORM
A61K 31/444 (2006.01)	3582775	ANTI-INFLAMMATORY COMPOSITIONS COMPRISING IRAK AND JAK INHIBITORS
A61K 31/541 (2006.01)	3582775	ANTI-INFLAMMATORY COMPOSITIONS COMPRISING IRAK AND JAK INHIBITORS
A61K 45/06 (2006.01)	3582775	ANTI-INFLAMMATORY COMPOSITIONS COMPRISING IRAK AND JAK INHIBITORS
A61P 29/00 (2006.01)	3582775	ANTI-INFLAMMATORY COMPOSITIONS COMPRISING IRAK AND JAK INHIBITORS
A61P 35/00 (2006.01)	3582775	ANTI-INFLAMMATORY COMPOSITIONS COMPRISING IRAK AND JAK INHIBITORS
A61P 37/00 (2006.01)	3582775	ANTI-INFLAMMATORY COMPOSITIONS COMPRISING IRAK AND JAK INHIBITORS
A61P 37/06 (2006.01)	3582775	ANTI-INFLAMMATORY COMPOSITIONS COMPRISING IRAK AND JAK INHIBITORS
A61P 37/08 (2006.01)	3582775	ANTI-INFLAMMATORY COMPOSITIONS COMPRISING IRAK AND JAK INHIBITORS
A61P 43/00 (2006.01)	3582775	ANTI-INFLAMMATORY COMPOSITIONS COMPRISING IRAK AND JAK INHIBITORS
A61K 38/22 (2006.01)	3580232	MODIFIED RELAXIN POLYPEPTIDES COMPRISING A PHARMACOKINETIC ENHANCER AND USES THEREOF
C07K 14/64 (2006.01)	3580232	MODIFIED RELAXIN POLYPEPTIDES COMPRISING A PHARMACOKINETIC ENHANCER AND USES THEREOF
A61K 38/40 (2006.01)	3583120	ENGINEERED TRANSFERRIN RECEPTOR BINDING POLYPEPTIDES
A61K 39/00 (2006.01)	3583120	ENGINEERED TRANSFERRIN RECEPTOR BINDING POLYPEPTIDES
C07K 14/705 (2006.01)	3583120	ENGINEERED TRANSFERRIN RECEPTOR BINDING POLYPEPTIDES
C07K 14/79 (2006.01)	3583120	ENGINEERED TRANSFERRIN RECEPTOR BINDING POLYPEPTIDES
A61K 31/7084 (2006.01)	3582853	CYCLIC DI-NUCLEOTIDES COMPOUNDS FOR THE TREATMENT OF CANCER
A61P 31/04 (2006.01)	3582853	CYCLIC DI-NUCLEOTIDES COMPOUNDS FOR THE TREATMENT OF CANCER
A61P 37/04 (2006.01)	3582853	CYCLIC DI-NUCLEOTIDES COMPOUNDS FOR THE TREATMENT OF CANCER
C07F 9/6527 (2006.01)	3582853	CYCLIC DI-NUCLEOTIDES COMPOUNDS FOR THE TREATMENT OF CANCER
C07F 9/6574 (2006.01)	3582853	CYCLIC DI-NUCLEOTIDES COMPOUNDS FOR THE TREATMENT OF CANCER
C07H 19/213 (2006.01)	3582853	CYCLIC DI-NUCLEOTIDES COMPOUNDS FOR THE TREATMENT OF

MKP (51)	Broj objave evropske prijave patenta (97)	Naziv pronalaska (54)
A61K 31/713 (2006.01)	3577223	CANCER COMPOSITIONS AND METHODS FOR THE TREATMENT OF HEMOGLOBINOPATHIES
A61P 7/00 (2006.01)	3577223	COMPOSITIONS AND METHODS FOR THE TREATMENT OF HEMOGLOBINOPATHIES
C12N 15/113 (2010.01)	3577223	COMPOSITIONS AND METHODS FOR THE TREATMENT OF HEMOGLOBINOPATHIES
A61K 31/519 (2006.01)	3585790	[1,2,4]-TRIAZOLO [1,5-A]-PYRIMIDINYL DERIVATIVES SUBSTITUTED WITH PIPERIDINE, MORPHOLINE OR PIPERAZINE AS OGA INHIBITORS
A61P 25/28 (2006.01)	3585790	[1,2,4]-TRIAZOLO [1,5-A]-PYRIMIDINYL DERIVATIVES SUBSTITUTED WITH PIPERIDINE, MORPHOLINE OR PIPERAZINE AS OGA INHIBITORS
C07D 487/04 (2006.01)	3585790	[1,2,4]-TRIAZOLO [1,5-A]-PYRIMIDINYL DERIVATIVES SUBSTITUTED WITH PIPERIDINE, MORPHOLINE OR PIPERAZINE AS OGA INHIBITORS
C07D 519/00 (2006.01)	3585790	[1,2,4]-TRIAZOLO [1,5-A]-PYRIMIDINYL DERIVATIVES SUBSTITUTED WITH PIPERIDINE, MORPHOLINE OR PIPERAZINE AS OGA INHIBITORS
A61K 31/4184 (2006.01)	3585772	1, 4, 6-TRISUBSTITUTED-2-ALKYL-1H-BENZO[D]IMIDAZOLE DERIVATIVES AS DIHYDROOROTATE OXYGENASE INHIBITORS
C07D 235/08 (2006.01)	3585772	1, 4, 6-TRISUBSTITUTED-2-ALKYL-1H-BENZO[D]IMIDAZOLE DERIVATIVES AS DIHYDROOROTATE OXYGENASE INHIBITORS
C07D 401/10 (2006.01)	3585772	1, 4, 6-TRISUBSTITUTED-2-ALKYL-1H-BENZO[D]IMIDAZOLE DERIVATIVES AS DIHYDROOROTATE OXYGENASE INHIBITORS
C07D 403/10 (2006.01)	3585772	1, 4, 6-TRISUBSTITUTED-2-ALKYL-1H-BENZO[D]IMIDAZOLE DERIVATIVES AS DIHYDROOROTATE OXYGENASE INHIBITORS
C07D 413/10 (2006.01)	3585772	1, 4, 6-TRISUBSTITUTED-2-ALKYL-1H-BENZO[D]IMIDAZOLE DERIVATIVES AS DIHYDROOROTATE OXYGENASE INHIBITORS
C07D 417/10 (2006.01)	3585772	1, 4, 6-TRISUBSTITUTED-2-ALKYL-1H-BENZO[D]IMIDAZOLE DERIVATIVES AS DIHYDROOROTATE OXYGENASE INHIBITORS
C12Q 1/48 (2006.01)	3585904	USE OF BIOMARKERS IN IDENTIFYING CANCER PATIENTS THAT WILL BE RESPONSIVE TO TREATMENT WITH A PRMT5 INHIBITOR
C12Q 1/68 (2018.01)	3585904	USE OF BIOMARKERS IN IDENTIFYING CANCER PATIENTS THAT WILL BE RESPONSIVE TO TREATMENT WITH A PRMT5 INHIBITOR
G01N 33/574 (2006.01)	3585904	USE OF BIOMARKERS IN IDENTIFYING CANCER PATIENTS THAT WILL BE RESPONSIVE TO TREATMENT WITH A PRMT5 INHIBITOR
A61P 25/28 (2006.01)	3583123	ANTI-TAU ANTIBODIES AND METHODS OF USE THEREOF
C07K 16/18 (2006.01)	3583123	ANTI-TAU ANTIBODIES AND METHODS OF USE THEREOF
A61M 5/315 (2006.01)	3589340	DOSE DETECTION AND DRUG IDENTIFICATION FOR A MEDICATION DELIVERY DEVICE
A61K 31/185 (2006.01)	3585373	METHODS FOR TREATING NEURODEGENERATIVE DISORDERS
A61K 31/381 (2006.01)	3585373	METHODS FOR TREATING NEURODEGENERATIVE DISORDERS
A61K 31/404 (2006.01)	3585373	METHODS FOR TREATING NEURODEGENERATIVE DISORDERS
A61K 31/415 (2006.01)	3585373	METHODS FOR TREATING NEURODEGENERATIVE DISORDERS
A61K 31/4152 (2006.01)	3585373	METHODS FOR TREATING NEURODEGENERATIVE DISORDERS
A61K 31/4168 (2006.01)	3585373	METHODS FOR TREATING NEURODEGENERATIVE DISORDERS
A61K 31/4184 (2006.01)	3585373	METHODS FOR TREATING NEURODEGENERATIVE DISORDERS
A61K 31/4196 (2006.01)	3585373	METHODS FOR TREATING NEURODEGENERATIVE DISORDERS
A61K 31/42 (2006.01)	3585373	METHODS FOR TREATING NEURODEGENERATIVE DISORDERS
A61K 31/423 (2006.01)	3585373	METHODS FOR TREATING NEURODEGENERATIVE DISORDERS
A61K 31/426 (2006.01)	3585373	METHODS FOR TREATING NEURODEGENERATIVE DISORDERS
A61K 31/428 (2006.01)	3585373	METHODS FOR TREATING NEURODEGENERATIVE DISORDERS
A61K 31/433 (2006.01)	3585373	METHODS FOR TREATING NEURODEGENERATIVE DISORDERS
A61K 31/44 (2006.01)	3585373	METHODS FOR TREATING NEURODEGENERATIVE DISORDERS
A61K 31/4425 (2006.01)	3585373	METHODS FOR TREATING NEURODEGENERATIVE DISORDERS
A61K 31/505 (2006.01)	3585373	METHODS FOR TREATING NEURODEGENERATIVE DISORDERS
A61K 31/52 (2006.01)	3585373	METHODS FOR TREATING NEURODEGENERATIVE DISORDERS
A61K 31/53 (2006.01)	3585373	METHODS FOR TREATING NEURODEGENERATIVE DISORDERS
A61K 31/536 (2006.01)	3585373	METHODS FOR TREATING NEURODEGENERATIVE DISORDERS
A61K 31/5377 (2006.01)	3585373	METHODS FOR TREATING NEURODEGENERATIVE DISORDERS
A61P 25/28 (2006.01)	3585373	METHODS FOR TREATING NEURODEGENERATIVE DISORDERS
A61K 48/00 (2006.01)	3589329	CONCEPT FOR THE TREATMENT OF MONOGENETIC DISORDERS
C07K 14/745 (2006.01)	3589329	CONCEPT FOR THE TREATMENT OF MONOGENETIC DISORDERS
C07K 14/755 (2006.01)	3589329	CONCEPT FOR THE TREATMENT OF MONOGENETIC DISORDERS
C12N 15/85 (2006.01)	3589329	CONCEPT FOR THE TREATMENT OF MONOGENETIC DISORDERS
C12N 15/88 (2006.01)	3589329	CONCEPT FOR THE TREATMENT OF MONOGENETIC DISORDERS
B01F 3/04 (2006.01)	3580183	DEVICE FOR SEWAGE TREATMENT

MKP	Broj objave evropske prijave patenta	Naziv pronalaska
(51)	(97)	(54)
C02F 3/20 (2006.01)	3580183	DEVICE FOR SEWAGE TREATMENT
C02F 3/22 (2006.01)	3580183	DEVICE FOR SEWAGE TREATMENT
A61K 9/00 (2006.01)	3570840	COMBINATIONS OF CABOZANTINIB AND ATEZOLIZUMAB TO TREAT CANCER
A61K 31/47 (2006.01)	3570840	COMBINATIONS OF CABOZANTINIB AND ATEZOLIZUMAB TO TREAT CANCER
A61K 45/06 (2006.01)	3570840	COMBINATIONS OF CABOZANTINIB AND ATEZOLIZUMAB TO TREAT CANCER
A61P 35/00 (2006.01)	3570840	COMBINATIONS OF CABOZANTINIB AND ATEZOLIZUMAB TO TREAT CANCER
A61P 35/04 (2006.01)	3570840	COMBINATIONS OF CABOZANTINIB AND ATEZOLIZUMAB TO TREAT CANCER
A61K 38/19 (2006.01)	3589308	THERAPEUTIC RNA
A61K 38/20 (2006.01)	3589308	THERAPEUTIC RNA
A61K 38/21 (2006.01)	3589308	THERAPEUTIC RNA
C07K 14/535 (2006.01)	3589308	THERAPEUTIC RNA
C07K 14/54 (2006.01)	3589308	THERAPEUTIC RNA
C07K 14/56 (2006.01)	3589308	THERAPEUTIC RNA
C12N 15/67 (2006.01)	3589308	THERAPEUTIC RNA
A61K 39/00 (2006.01)	3571226	BONE-TARGETING ANTIBODIES
A61P 19/08 (2006.01)	3571226	BONE-TARGETING ANTIBODIES
C07K 16/22 (2006.01)	3571226	BONE-TARGETING ANTIBODIES
A61K 31/4152 (2006.01)	3592732	MANUFACTURE OF A CRYSTALLINE PHARMACEUTICAL PRODUCT
A61P 35/00 (2006.01)	3592732	MANUFACTURE OF A CRYSTALLINE PHARMACEUTICAL PRODUCT
C07D 231/14 (2006.01)	3592732	MANUFACTURE OF A CRYSTALLINE PHARMACEUTICAL PRODUCT
B29C 45/16 (2006.01)	3585583	MULTI-STEP METHOD FOR PRODUCING A SOUNDPROOF COMPOSITE COVER FOR INTERNAL COMBUSTION ENGINES AND PRODUCT THUS OBTAINED
B29C 45/17 (2006.01)	3585583	MULTI-STEP METHOD FOR PRODUCING A SOUNDPROOF COMPOSITE COVER FOR INTERNAL COMBUSTION ENGINES AND PRODUCT THUS OBTAINED
B29K 23/00 (2006.01)	3585583	MULTI-STEP METHOD FOR PRODUCING A SOUNDPROOF COMPOSITE COVER FOR INTERNAL COMBUSTION ENGINES AND PRODUCT THUS OBTAINED
B29K 75/00 (2006.01)	3585583	MULTI-STEP METHOD FOR PRODUCING A SOUNDPROOF COMPOSITE COVER FOR INTERNAL COMBUSTION ENGINES AND PRODUCT THUS OBTAINED
B29K 77/00 (2006.01)	3585583	MULTI-STEP METHOD FOR PRODUCING A SOUNDPROOF COMPOSITE COVER FOR INTERNAL COMBUSTION ENGINES AND PRODUCT THUS OBTAINED
B29K 105/04 (2006.01)	3585583	MULTI-STEP METHOD FOR PRODUCING A SOUNDPROOF COMPOSITE COVER FOR INTERNAL COMBUSTION ENGINES AND PRODUCT THUS OBTAINED
G10K 11/00 (2006.01)	3585583	MULTI-STEP METHOD FOR PRODUCING A SOUNDPROOF COMPOSITE COVER FOR INTERNAL COMBUSTION ENGINES AND PRODUCT THUS OBTAINED
B29C 45/16 (2006.01)	3585584	MULTI-STEP METHOD FOR PRODUCING A COMPOSITE COMPONENT FOR VEHICLES AND PRODUCT THUS OBTAINED
B29C 45/17 (2006.01)	3585584	MULTI-STEP METHOD FOR PRODUCING A COMPOSITE COMPONENT FOR VEHICLES AND PRODUCT THUS OBTAINED
B29C 45/26 (2006.01)	3585584	MULTI-STEP METHOD FOR PRODUCING A COMPOSITE COMPONENT FOR VEHICLES AND PRODUCT THUS OBTAINED
B29K 23/00 (2006.01)	3585584	MULTI-STEP METHOD FOR PRODUCING A COMPOSITE COMPONENT FOR VEHICLES AND PRODUCT THUS OBTAINED
B29K 75/00 (2006.01)	3585584	MULTI-STEP METHOD FOR PRODUCING A COMPOSITE COMPONENT FOR VEHICLES AND PRODUCT THUS OBTAINED
B29K 77/00 (2006.01)	3585584	MULTI-STEP METHOD FOR PRODUCING A COMPOSITE COMPONENT FOR VEHICLES AND PRODUCT THUS OBTAINED
B29K 105/04 (2006.01)	3585584	MULTI-STEP METHOD FOR PRODUCING A COMPOSITE COMPONENT FOR VEHICLES AND PRODUCT THUS OBTAINED
B60R 13/08 (2006.01)	3585584	MULTI-STEP METHOD FOR PRODUCING A COMPOSITE COMPONENT FOR VEHICLES AND PRODUCT THUS OBTAINED
F02B 77/11 (2006.01)	3585584	MULTI-STEP METHOD FOR PRODUCING A COMPOSITE COMPONENT FOR VEHICLES AND PRODUCT THUS OBTAINED
G10K 11/00 (2006.01)	3585584	MULTI-STEP METHOD FOR PRODUCING A COMPOSITE

MKP (51)	Broj objave evropske prijave patenta (97)	Naziv pronalaska (54)
A01N 43/72 (2006.01)	3579696	COMPONENT FOR VEHICLES AND PRODUCT THUS OBTAINED IN VIVO MODEL FOR PARASITIC WORM INFECTION AND METHODS FOR EVALUATING ANTIPARASITIC COMPOUNDS, INCLUDING COMPOUNDS ACTIVE AGAINST CANINE HEARTWORM
A01N 43/90 (2006.01)	3579696	IN VIVO MODEL FOR PARASITIC WORM INFECTION AND METHODS FOR EVALUATING ANTIPARASITIC COMPOUNDS, INCLUDING COMPOUNDS ACTIVE AGAINST CANINE HEARTWORM
A01N 47/18 (2006.01)	3579696	IN VIVO MODEL FOR PARASITIC WORM INFECTION AND METHODS FOR EVALUATING ANTIPARASITIC COMPOUNDS, INCLUDING COMPOUNDS ACTIVE AGAINST CANINE HEARTWORM
A01P 5/00 (2006.01)	3579696	IN VIVO MODEL FOR PARASITIC WORM INFECTION AND METHODS FOR EVALUATING ANTIPARASITIC COMPOUNDS, INCLUDING COMPOUNDS ACTIVE AGAINST CANINE HEARTWORM
A61K 31/7084 (2006.01)	3582854	CYCLIC DI-NUCLEOTIDES DERIVATIVE FOR THE TREATMENT OF CANCER
A61P 31/04 (2006.01)	3582854	CYCLIC DI-NUCLEOTIDES DERIVATIVE FOR THE TREATMENT OF CANCER
A61P 37/04 (2006.01)	3582854	CYCLIC DI-NUCLEOTIDES DERIVATIVE FOR THE TREATMENT OF CANCER
C07F 9/6527 (2006.01)	3582854	CYCLIC DI-NUCLEOTIDES DERIVATIVE FOR THE TREATMENT OF CANCER
C07F 9/6536 (2006.01)	3582854	CYCLIC DI-NUCLEOTIDES DERIVATIVE FOR THE TREATMENT OF CANCER
C07F 9/6574 (2006.01)	3582854	CYCLIC DI-NUCLEOTIDES DERIVATIVE FOR THE TREATMENT OF CANCER
C07H 19/213 (2006.01)	3582854	CYCLIC DI-NUCLEOTIDES DERIVATIVE FOR THE TREATMENT OF CANCER
A61K 31/357 (2006.01)	3582804	PHARMACEUTICAL COMBINATIONS FOR TREATING CANCER
A61K 39/00 (2006.01)	3582804	PHARMACEUTICAL COMBINATIONS FOR TREATING CANCER
A61P 35/00 (2006.01)	3582804	PHARMACEUTICAL COMBINATIONS FOR TREATING CANCER
A61K 31/542 (2006.01)	3592750	INHIBITORS OF BETA SECRETASE
A61P 25/28 (2006.01)	3592750	INHIBITORS OF BETA SECRETASE
C07D 498/04 (2006.01)	3592750	INHIBITORS OF BETA SECRETASE
C07D 513/04 (2006.01)	3592750	INHIBITORS OF BETA SECRETASE
A61K 31/542 (2006.01)	3592751	INHIBITORS OF BETA SECRETASE
A61P 25/28 (2006.01)	3592751	INHIBITORS OF BETA SECRETASE
C07D 513/04 (2006.01)	3592751	INHIBITORS OF BETA SECRETASE
A61K 31/542 (2006.01)	3592752	INHIBITORS OF BETA SECRETASE
A61P 25/28 (2006.01)	3592752	INHIBITORS OF BETA SECRETASE
C07D 513/04 (2006.01)	3592752	INHIBITORS OF BETA SECRETASE
A61K 31/426 (2006.01)	3592734	AMINE SALT OF (1R,3S)-3-(5-CYANO-4-PHENYL-1,3-THIAZOL-2-YLCARBAMOYL)CYCLOPENTANE CARBOXYLIC ACID
A61P 9/00 (2006.01)	3592734	AMINE SALT OF (1R,3S)-3-(5-CYANO-4-PHENYL-1,3-THIAZOL-2-YLCARBAMOYL)CYCLOPENTANE CARBOXYLIC ACID
C07D 277/56 (2006.01)	3592734	AMINE SALT OF (1R,3S)-3-(5-CYANO-4-PHENYL-1,3-THIAZOL-2-YLCARBAMOYL)CYCLOPENTANE CARBOXYLIC ACID
A22C 17/00 (2006.01)	3582620	CUTTING DEVICE WITH MONOLITHIC STRUCTURE
B02C 18/36 (2006.01)	3582620	CUTTING DEVICE WITH MONOLITHIC STRUCTURE
C25B 1/06 (2006.01)	3585926	ELECTROLYSIS HEATING SYSTEM
C25B 9/06 (2006.01)	3585926	ELECTROLYSIS HEATING SYSTEM
C25B 15/02 (2006.01)	3585926	ELECTROLYSIS HEATING SYSTEM
C25B 15/08 (2006.01)	3585926	ELECTROLYSIS HEATING SYSTEM
A61K 39/395 (2006.01)	3585821	LOW-VISCOSITY, HIGH-CONCENTRATION EVOLOCUMAB FORMULATIONS AND METHODS OF MAKING THE SAME
A61K 47/18 (2017.01)	3585821	LOW-VISCOSITY, HIGH-CONCENTRATION EVOLOCUMAB FORMULATIONS AND METHODS OF MAKING THE SAME
C07K 16/40 (2006.01)	3585821	LOW-VISCOSITY, HIGH-CONCENTRATION EVOLOCUMAB FORMULATIONS AND METHODS OF MAKING THE SAME
A61K 47/65 (2017.01)	3589328	MAYTANSINOID DERIVATIVES WITH SELF-IMMOLATIVE PEPTIDE LINKERS AND CONJUGATES THEREOF
A61K 47/68 (2017.01)	3589328	MAYTANSINOID DERIVATIVES WITH SELF-IMMOLATIVE PEPTIDE LINKERS AND CONJUGATES THEREOF
A61P 35/00 (2006.01)	3589328	MAYTANSINOID DERIVATIVES WITH SELF-IMMOLATIVE PEPTIDE LINKERS AND CONJUGATES THEREOF
A61K 35/17 (2015.01)	3585402	COMPOSITIONS, ARTICLES OF MANUFACTURE AND METHODS RELATED TO DOSING IN CELL THERAPY
A61K 39/00 (2006.01)	3589951	POPULATION-BASED IMMUNOGENIC PEPTIDE IDENTIFICATION PLATFORM

MKP	Broj objave evropske prijave patenta (97)	Naziv pronalaska (54)
(51)		
G01N 33/50 (2006.01)	3589951	POPULATION-BASED IMMUNOGENIC PEPTIDE IDENTIFICATION PLATFORM
G01N 33/569 (2006.01)	3589951	POPULATION-BASED IMMUNOGENIC PEPTIDE IDENTIFICATION PLATFORM
A61K 38/10 (2006.01)	3589305	SPECIFIC INCREASE OF DOPAMINE SYNTHESIS THROUGH TARGETING OF THE GUANYLATE CYCLASE 2C RECEPTOR IN THE TREATMENT OF PARKINSON'S DISEASE
A61K 45/06 (2006.01)	3589305	SPECIFIC INCREASE OF DOPAMINE SYNTHESIS THROUGH TARGETING OF THE GUANYLATE CYCLASE 2C RECEPTOR IN THE TREATMENT OF PARKINSON'S DISEASE
C12Q 1/6886 (2018.01)	3592867	A METHYLATION CLASSIFIER FOR DETECTION OF HPV-INDUCED INVASIVE CANCERS, NONHPV- INDUCED GYNAECOLOGICAL AND ANOGENITAL CANCERS AND THEIR HIGH-GRADE PRECURSOR LESIONS
B61K 7/04 (2006.01)	3558786	LAMELLA OF RAIL ELEMENT, PREFERABLY RAIL BRAKE AND METHOD OF ITS USE
F16D 65/00 (2006.01)	3558786	LAMELLA OF RAIL ELEMENT, PREFERABLY RAIL BRAKE AND METHOD OF ITS USE
F16D 65/04 (2006.01)	3558786	LAMELLA OF RAIL ELEMENT, PREFERABLY RAIL BRAKE AND METHOD OF ITS USE
A61K 9/20 (2006.01)	3582814	COMPOUNDS AND METHODS FOR TREATMENT OF INFLAMMATORY BOWEL DISEASE WITH EXTRA-INTESTINAL MANIFESTATIONS
A61K 31/404 (2006.01)	3582814	COMPOUNDS AND METHODS FOR TREATMENT OF INFLAMMATORY BOWEL DISEASE WITH EXTRA-INTESTINAL MANIFESTATIONS
A61K 45/06 (2006.01)	3582814	COMPOUNDS AND METHODS FOR TREATMENT OF INFLAMMATORY BOWEL DISEASE WITH EXTRA-INTESTINAL MANIFESTATIONS
A61P 1/00 (2006.01)	3582814	COMPOUNDS AND METHODS FOR TREATMENT OF INFLAMMATORY BOWEL DISEASE WITH EXTRA-INTESTINAL MANIFESTATIONS
A61P 1/04 (2006.01)	3582814	COMPOUNDS AND METHODS FOR TREATMENT OF INFLAMMATORY BOWEL DISEASE WITH EXTRA-INTESTINAL MANIFESTATIONS
A61P 17/00 (2006.01)	3582814	COMPOUNDS AND METHODS FOR TREATMENT OF INFLAMMATORY BOWEL DISEASE WITH EXTRA-INTESTINAL MANIFESTATIONS
A61P 17/02 (2006.01)	3582814	COMPOUNDS AND METHODS FOR TREATMENT OF INFLAMMATORY BOWEL DISEASE WITH EXTRA-INTESTINAL MANIFESTATIONS
A61P 37/00 (2006.01)	3582814	COMPOUNDS AND METHODS FOR TREATMENT OF INFLAMMATORY BOWEL DISEASE WITH EXTRA-INTESTINAL MANIFESTATIONS
A61K 9/127 (2006.01)	3585417	NOVEL CODON-OPTIMIZED CFTR MRNA
A61K 38/17 (2006.01)	3585417	NOVEL CODON-OPTIMIZED CFTR MRNA
C07K 14/47 (2006.01)	3585417	NOVEL CODON-OPTIMIZED CFTR MRNA
C12N 15/10 (2006.01)	3585417	NOVEL CODON-OPTIMIZED CFTR MRNA
A61K 9/16 (2006.01)	3589274	COMPOSITIONS COMPRISING PGI ₂ -RECEPTOR AGONISTS AND PROCESSES FOR THE PREPARATION THEREOF
A61K 9/20 (2006.01)	3589274	COMPOSITIONS COMPRISING PGI ₂ -RECEPTOR AGONISTS AND PROCESSES FOR THE PREPARATION THEREOF
A61K 9/28 (2006.01)	3589274	COMPOSITIONS COMPRISING PGI ₂ -RECEPTOR AGONISTS AND PROCESSES FOR THE PREPARATION THEREOF
A61K 9/48 (2006.01)	3589274	COMPOSITIONS COMPRISING PGI ₂ -RECEPTOR AGONISTS AND PROCESSES FOR THE PREPARATION THEREOF
A61K 31/27 (2006.01)	3589274	COMPOSITIONS COMPRISING PGI ₂ -RECEPTOR AGONISTS AND PROCESSES FOR THE PREPARATION THEREOF
A61K 9/107 (2006.01)	3573600	METHOD FOR MANUFACTURING A STABLE EMULSION FOR PEPTIDE DELIVERY
A61K 38/10 (2006.01)	3573600	METHOD FOR MANUFACTURING A STABLE EMULSION FOR PEPTIDE DELIVERY
A61K 38/17 (2006.01)	3573600	METHOD FOR MANUFACTURING A STABLE EMULSION FOR PEPTIDE DELIVERY
A61K 31/505 (2006.01)	3592774	PHARMACEUTICAL COMBINATIONS COMPRISING AN ANTI-LY75 ANTIBODY
A61K 39/395 (2006.01)	3592774	PHARMACEUTICAL COMBINATIONS COMPRISING AN ANTI-LY75 ANTIBODY

MKP	Broj objave evropske prijave patenta (97)	Naziv pronalaska (54)
(51)		(54)
A61K 47/68 (2017.01)	3592774	PHARMACEUTICAL COMBINATIONS COMPRISING AN ANTI-LY75 ANTIBODY
A61P 35/00 (2006.01)	3592774	PHARMACEUTICAL COMBINATIONS COMPRISING AN ANTI-LY75 ANTIBODY
A61P 35/02 (2006.01)	3592774	PHARMACEUTICAL COMBINATIONS COMPRISING AN ANTI-LY75 ANTIBODY
C07K 16/28 (2006.01)	3592774	PHARMACEUTICAL COMBINATIONS COMPRISING AN ANTI-LY75 ANTIBODY
C07K 16/46 (2006.01)	3592774	PHARMACEUTICAL COMBINATIONS COMPRISING AN ANTI-LY75 ANTIBODY
C12N 15/10 (2006.01)	3583230	SYSTEMS AND PROCESSES FOR RAPID NUCLEIC ACID EXTRACTION, PURIFICATION, AND ANALYSIS
C12Q 1/6806 (2018.01)	3583230	SYSTEMS AND PROCESSES FOR RAPID NUCLEIC ACID EXTRACTION, PURIFICATION, AND ANALYSIS
C12N 15/10 (2006.01)	3585891	METHODS FOR PURIFICATION OF MESSENGER RNA
A61K 35/76 (2015.01)	3589730	ADENO-ASSOCIATED VIRUS (AAV) CLADE F VECTOR AND USES THEREFOR
A61K 48/00 (2006.01)	3589730	ADENO-ASSOCIATED VIRUS (AAV) CLADE F VECTOR AND USES THEREFOR
C12N 7/00 (2006.01)	3589730	ADENO-ASSOCIATED VIRUS (AAV) CLADE F VECTOR AND USES THEREFOR
A61K 9/19 (2006.01)	3592391	PHARMACEUTICAL COMPOSITION COMPRISING SELEXIPAG
A61K 31/4965 (2006.01)	3592391	PHARMACEUTICAL COMPOSITION COMPRISING SELEXIPAG
A61K 47/10 (2017.01)	3592391	PHARMACEUTICAL COMPOSITION COMPRISING SELEXIPAG
A61P 9/12 (2006.01)	3592391	PHARMACEUTICAL COMPOSITION COMPRISING SELEXIPAG
A61P 17/02 (2006.01)	3592391	PHARMACEUTICAL COMPOSITION COMPRISING SELEXIPAG
A61K 31/045 (2006.01)	3585367	CINEOLE-CONTAINING COMPOSITION FOR TREATING NASAL DISEASES
A61K 36/185 (2006.01)	3585367	CINEOLE-CONTAINING COMPOSITION FOR TREATING NASAL DISEASES
A61P 11/00 (2006.01)	3585367	CINEOLE-CONTAINING COMPOSITION FOR TREATING NASAL DISEASES
A61P 35/00 (2006.01)	3571227	ANTI-TGF-BETA ANTIBODIES AND THEIR USE
C07K 16/22 (2006.01)	3571227	ANTI-TGF-BETA ANTIBODIES AND THEIR USE
C07K 16/28 (2006.01)	3571227	ANTI-TGF-BETA ANTIBODIES AND THEIR USE
G16H 50/20 (2018.01)	3571700	METHOD AND SYSTEM FOR PREDICTING REFRACTORY EPILEPSY STATUS
G16H 50/30 (2018.01)	3571700	METHOD AND SYSTEM FOR PREDICTING REFRACTORY EPILEPSY STATUS
G16H 50/70 (2018.01)	3571700	METHOD AND SYSTEM FOR PREDICTING REFRACTORY EPILEPSY STATUS
A61K 39/00 (2006.01)	3568412	T CELL RECEPTORS THAT BIND TO NY-ESO-1 AND METHODS OF USE THEREOF
C07K 14/725 (2006.01)	3568412	T CELL RECEPTORS THAT BIND TO NY-ESO-1 AND METHODS OF USE THEREOF
C07K 16/30 (2006.01)	3568412	T CELL RECEPTORS THAT BIND TO NY-ESO-1 AND METHODS OF USE THEREOF
C12N 5/16 (2006.01)	3568412	T CELL RECEPTORS THAT BIND TO NY-ESO-1 AND METHODS OF USE THEREOF
A61K 31/519 (2006.01)	3592745	PYRIMIDOPYRIMIDINONES USEFUL AS WEE-1 KINASE INHIBITORS
A61P 35/00 (2006.01)	3592745	PYRIMIDOPYRIMIDINONES USEFUL AS WEE-1 KINASE INHIBITORS
C07D 487/04 (2006.01)	3592745	PYRIMIDOPYRIMIDINONES USEFUL AS WEE-1 KINASE INHIBITORS
C07H 1/06 (2006.01)	3585892	METHODS FOR PURIFICATION OF MESSENGER RNA
C12N 15/10 (2006.01)	3585892	METHODS FOR PURIFICATION OF MESSENGER RNA
C12P 19/34 (2006.01)	3585892	METHODS FOR PURIFICATION OF MESSENGER RNA
A61K 31/397 (2006.01)	3592742	JAK INHIBITORS CONTAINING A 4-MEMBERED HETEROCYCLIC AMIDE
A61K 31/437 (2006.01)	3592742	JAK INHIBITORS CONTAINING A 4-MEMBERED HETEROCYCLIC AMIDE
A61P 11/00 (2006.01)	3592742	JAK INHIBITORS CONTAINING A 4-MEMBERED HETEROCYCLIC AMIDE
C07D 471/04 (2006.01)	3592742	JAK INHIBITORS CONTAINING A 4-MEMBERED HETEROCYCLIC AMIDE
A61K 31/415 (2006.01)	3589618	PYRAZOLE DERIVATIVES AS BROMODOMAIN INHIBITORS
A61K 31/4155 (2006.01)	3589618	PYRAZOLE DERIVATIVES AS BROMODOMAIN INHIBITORS

MKP	Broj objave evropske prijave patenta	Naziv pronalaska
(51)	(97)	(54)
C07D 231/14 (2006.01)	3589618	PYRAZOLE DERIVATIVES AS BROMODOMAIN INHIBITORS
C07D 401/12 (2006.01)	3589618	PYRAZOLE DERIVATIVES AS BROMODOMAIN INHIBITORS
C07D 401/14 (2006.01)	3589618	PYRAZOLE DERIVATIVES AS BROMODOMAIN INHIBITORS
C07D 403/12 (2006.01)	3589618	PYRAZOLE DERIVATIVES AS BROMODOMAIN INHIBITORS
C07D 403/14 (2006.01)	3589618	PYRAZOLE DERIVATIVES AS BROMODOMAIN INHIBITORS
C07D 405/12 (2006.01)	3589618	PYRAZOLE DERIVATIVES AS BROMODOMAIN INHIBITORS
C07D 405/14 (2006.01)	3589618	PYRAZOLE DERIVATIVES AS BROMODOMAIN INHIBITORS
C07D 413/12 (2006.01)	3589618	PYRAZOLE DERIVATIVES AS BROMODOMAIN INHIBITORS
C07D 417/12 (2006.01)	3589618	PYRAZOLE DERIVATIVES AS BROMODOMAIN INHIBITORS
C07D 471/04 (2006.01)	3589618	PYRAZOLE DERIVATIVES AS BROMODOMAIN INHIBITORS
C07K 16/10 (2006.01)	3592769	ANTIBODIES AGAINST PD-L1
C07K 16/28 (2006.01)	3592769	ANTIBODIES AGAINST PD-L1
A61K 31/437 (2006.01)	3592743	FUSED IMIDAZO-PIPERIDINE JAK INHIBITORS
A61P 11/00 (2006.01)	3592743	FUSED IMIDAZO-PIPERIDINE JAK INHIBITORS
C07D 471/04 (2006.01)	3592743	FUSED IMIDAZO-PIPERIDINE JAK INHIBITORS
A61K 9/127 (2006.01)	3592728	POLYANIONIC DELIVERY OF NUCLEIC ACIDS
A61K 47/20 (2006.01)	3592728	POLYANIONIC DELIVERY OF NUCLEIC ACIDS
A61K 47/54 (2017.01)	3592728	POLYANIONIC DELIVERY OF NUCLEIC ACIDS
C07C 305/06 (2006.01)	3592728	POLYANIONIC DELIVERY OF NUCLEIC ACIDS
C07C 317/18 (2006.01)	3592728	POLYANIONIC DELIVERY OF NUCLEIC ACIDS
C08G 65/00 (2006.01)	3592728	POLYANIONIC DELIVERY OF NUCLEIC ACIDS
G01N 35/00 (2006.01)	3593403	CONTAINER LABELS
G06K 19/077 (2006.01)	3593403	CONTAINER LABELS
H01Q 1/22 (2006.01)	3593403	CONTAINER LABELS
H01Q 7/00 (2006.01)	3593403	CONTAINER LABELS
C12N 15/864 (2006.01)	3589739	COMPOSITIONS USEFUL IN TREATMENT OF SPINAL MUSCULAR ATROPHY
C12N 9/12 (2006.01)	3585886	LARGE SCALE SYNTHESIS OF MESSENGER RNA
C12P 19/34 (2006.01)	3585886	LARGE SCALE SYNTHESIS OF MESSENGER RNA
A61K 39/395 (2006.01)	3570885	METHOD OF TREATING OR AMELIORATING METABOLIC DISORDERS USING GLP-1 RECEPTOR AGONISTS CONJUGATED TO ANTAGONISTS FOR GASTRIC INHIBITORY PEPTIDE RECEPTOR (GIPR)
A61P 3/10 (2006.01)	3570885	METHOD OF TREATING OR AMELIORATING METABOLIC DISORDERS USING GLP-1 RECEPTOR AGONISTS CONJUGATED TO ANTAGONISTS FOR GASTRIC INHIBITORY PEPTIDE RECEPTOR (GIPR)
C07K 16/28 (2006.01)	3570885	METHOD OF TREATING OR AMELIORATING METABOLIC DISORDERS USING GLP-1 RECEPTOR AGONISTS CONJUGATED TO ANTAGONISTS FOR GASTRIC INHIBITORY PEPTIDE RECEPTOR (GIPR)
A61N 5/10 (2006.01)	3585482	RADIATION TREATMENT PLANNING AND DELIVERY USING COLLISION FREE REGIONS
A61K 31/404 (2006.01)	3582772	COMPOUNDS AND METHODS FOR TREATMENT OF PRIMARY BILIARY CHOLANGITIS
A61K 31/575 (2006.01)	3582772	COMPOUNDS AND METHODS FOR TREATMENT OF PRIMARY BILIARY CHOLANGITIS
A61P 1/16 (2006.01)	3582772	COMPOUNDS AND METHODS FOR TREATMENT OF PRIMARY BILIARY CHOLANGITIS
C12Q 1/6883 (2018.01)	3571321	HYDROXYSTEROID 17-BETA DEHYDROGENASE 13 (HSD17B13) VARIANTS AND USES THEREOF
A61H 33/00 (2006.01)	3576708	APPARATUS FOR TRANSCUTANEOUS TREATMENT BY GAS
A61H 33/14 (2006.01)	3576708	APPARATUS FOR TRANSCUTANEOUS TREATMENT BY GAS
A61H 35/00 (2006.01)	3576708	APPARATUS FOR TRANSCUTANEOUS TREATMENT BY GAS
F28D 1/04 (2006.01)	3593075	WALL-MOUNTED RADIANT COOLING DEVICE
F28F 1/16 (2006.01)	3593075	WALL-MOUNTED RADIANT COOLING DEVICE
A61K 31/444 (2006.01)	3581572	ADENOSINE A3 RECEPTOR MODULATORS
A61P 11/06 (2006.01)	3581572	ADENOSINE A3 RECEPTOR MODULATORS
A61P 13/12 (2006.01)	3581572	ADENOSINE A3 RECEPTOR MODULATORS
A61P 17/06 (2006.01)	3581572	ADENOSINE A3 RECEPTOR MODULATORS
A61P 19/02 (2006.01)	3581572	ADENOSINE A3 RECEPTOR MODULATORS
A61P 27/02 (2006.01)	3581572	ADENOSINE A3 RECEPTOR MODULATORS
A61P 29/00 (2006.01)	3581572	ADENOSINE A3 RECEPTOR MODULATORS
A61P 35/00 (2006.01)	3581572	ADENOSINE A3 RECEPTOR MODULATORS
C07D 417/14 (2006.01)	3581572	ADENOSINE A3 RECEPTOR MODULATORS
A63C 19/00 (2006.01)	3582863	SPORTS FACILITY FOR KINDERGARTNERS
A63C 19/08 (2006.01)	3582863	SPORTS FACILITY FOR KINDERGARTNERS
G01R 1/04 (2006.01)	3568707	ENCLOSURE ASSEMBLY AND METERING APPARATUS

MKP	Broj objave evropske prijave patenta (97)	Naziv pronalaska (54)
(51)		(54)
G01R 11/04 (2006.01)	3568707	COMPRISING SAME ENCLOSURE ASSEMBLY AND METERING APPARATUS COMPRISING SAME
G01R 11/24 (2006.01)	3568707	ENCLOSURE ASSEMBLY AND METERING APPARATUS COMPRISING SAME
G01R 22/06 (2006.01)	3568707	ENCLOSURE ASSEMBLY AND METERING APPARATUS COMPRISING SAME
C08G 8/22 (2006.01)	3589668	NOVOLAC RESINS AND USE IN RUBBER COMPOSITIONS
C08L 21/00 (2006.01)	3589668	NOVOLAC RESINS AND USE IN RUBBER COMPOSITIONS
C08L 61/12 (2006.01)	3589668	NOVOLAC RESINS AND USE IN RUBBER COMPOSITIONS
C08L 61/14 (2006.01)	3589668	NOVOLAC RESINS AND USE IN RUBBER COMPOSITIONS
C08L 77/00 (2006.01)	3589668	NOVOLAC RESINS AND USE IN RUBBER COMPOSITIONS
C09J 161/14 (2006.01)	3589668	NOVOLAC RESINS AND USE IN RUBBER COMPOSITIONS
A01K 87/04 (2006.01)	3585166	GUIDING DEVICE FOR FISHING RODS
A41D 13/06 (2006.01)	3582645	INSOLE AND ITS PROCESS OF MANUFACTURING
A43B 3/10 (2006.01)	3582645	INSOLE AND ITS PROCESS OF MANUFACTURING
A61K 39/00 (2006.01)	3571221	CELL SURFACE CONJUGATES AND RELATED CELL COMPOSITIONS AND METHODS
C07K 14/47 (2006.01)	3571221	CELL SURFACE CONJUGATES AND RELATED CELL COMPOSITIONS AND METHODS
C07K 14/705 (2006.01)	3571221	CELL SURFACE CONJUGATES AND RELATED CELL COMPOSITIONS AND METHODS
C12N 5/0783 (2010.01)	3571221	CELL SURFACE CONJUGATES AND RELATED CELL COMPOSITIONS AND METHODS
C23C 2/00 (2006.01)	3592878	HOT-DIP GALVANIZING METHOD AND CARRYING AND/OR HOLDING MEANS FOR THE HOT-DIP GALVANIZING
C23C 2/02 (2006.01)	3592878	HOT-DIP GALVANIZING METHOD AND CARRYING AND/OR HOLDING MEANS FOR THE HOT-DIP GALVANIZING
C23C 2/04 (2006.01)	3592878	HOT-DIP GALVANIZING METHOD AND CARRYING AND/OR HOLDING MEANS FOR THE HOT-DIP GALVANIZING
C23C 2/06 (2006.01)	3592878	HOT-DIP GALVANIZING METHOD AND CARRYING AND/OR HOLDING MEANS FOR THE HOT-DIP GALVANIZING
C23C 2/26 (2006.01)	3592878	HOT-DIP GALVANIZING METHOD AND CARRYING AND/OR HOLDING MEANS FOR THE HOT-DIP GALVANIZING
C25D 17/06 (2006.01)	3592878	HOT-DIP GALVANIZING METHOD AND CARRYING AND/OR HOLDING MEANS FOR THE HOT-DIP GALVANIZING
C25D 17/08 (2006.01)	3592878	HOT-DIP GALVANIZING METHOD AND CARRYING AND/OR HOLDING MEANS FOR THE HOT-DIP GALVANIZING
F16B 45/00 (2006.01)	3592878	HOT-DIP GALVANIZING METHOD AND CARRYING AND/OR HOLDING MEANS FOR THE HOT-DIP GALVANIZING
A61K 31/454 (2006.01)	3566055	METHODS FOR THE TREATMENT OF NEUROLOGICAL DISORDERS
C07D 413/14 (2006.01)	3566055	METHODS FOR THE TREATMENT OF NEUROLOGICAL DISORDERS
C07D 417/14 (2006.01)	3566055	METHODS FOR THE TREATMENT OF NEUROLOGICAL DISORDERS
G01N 33/68 (2006.01)	3566055	METHODS FOR THE TREATMENT OF NEUROLOGICAL DISORDERS
A61K 31/407 (2006.01)	3565551	METHODS OF TREATING BACTERIAL INFECTIONS
A61K 31/69 (2006.01)	3565551	METHODS OF TREATING BACTERIAL INFECTIONS
A61P 13/02 (2006.01)	3565551	METHODS OF TREATING BACTERIAL INFECTIONS
A61P 13/12 (2006.01)	3565551	METHODS OF TREATING BACTERIAL INFECTIONS
A61P 31/04 (2006.01)	3565551	METHODS OF TREATING BACTERIAL INFECTIONS
A61K 31/65 (2006.01)	3582786	CO-ADMINISTRATION OF MINOCYCLINE AND COLISTIN TO REDUCE ACUTE KIDNEY INJURY
A61K 38/12 (2006.01)	3582786	CO-ADMINISTRATION OF MINOCYCLINE AND COLISTIN TO REDUCE ACUTE KIDNEY INJURY
A61P 31/04 (2006.01)	3582786	CO-ADMINISTRATION OF MINOCYCLINE AND COLISTIN TO REDUCE ACUTE KIDNEY INJURY
A61K 31/58 (2006.01)	3565560	PREDICTIVE AND DIAGNOSTIC METHODS FOR PROSTATE CANCER
A61K 31/69 (2006.01)	3565560	PREDICTIVE AND DIAGNOSTIC METHODS FOR PROSTATE CANCER
A61K 39/395 (2006.01)	3565560	PREDICTIVE AND DIAGNOSTIC METHODS FOR PROSTATE CANCER
C07J 43/00 (2006.01)	3565560	PREDICTIVE AND DIAGNOSTIC METHODS FOR PROSTATE CANCER
C07K 16/28 (2006.01)	3565560	PREDICTIVE AND DIAGNOSTIC METHODS FOR PROSTATE

MKP	Broj objave evropske prijave patenta (97)	Naziv pronalaska (54)
(51)		(54)
C12Q 1/68 (2018.01)	3565560	CANCER PREDICTIVE AND DIAGNOSTIC METHODS FOR PROSTATE CANCER
E01F 9/30 (2016.01)	3567162	IMPROVED ROAD PROTECTION BARRIER
E01F 15/02 (2006.01)	3567162	IMPROVED ROAD PROTECTION BARRIER
G08B 1/08 (2006.01)	3567162	IMPROVED ROAD PROTECTION BARRIER
A61N 5/00 (2006.01)	3568199	MITIGATION OF INTERPLAY EFFECT IN PARTICLE RADIATION THERAPY
C07K 16/18 (2006.01)	3569709	ANTI-GPC3 ANTIBODY
C12N 1/15 (2006.01)	3569709	ANTI-GPC3 ANTIBODY
C12N 1/19 (2006.01)	3569709	ANTI-GPC3 ANTIBODY
C12N 1/21 (2006.01)	3569709	ANTI-GPC3 ANTIBODY
C12N 5/10 (2006.01)	3569709	ANTI-GPC3 ANTIBODY
C12N 15/09 (2006.01)	3569709	ANTI-GPC3 ANTIBODY
C12P 21/08 (2006.01)	3569709	ANTI-GPC3 ANTIBODY
G01N 33/574 (2006.01)	3569709	ANTI-GPC3 ANTIBODY
A61P 35/00 (2006.01)	3568471	PERSONALIZED VACCINES
C12N 5/09 (2010.01)	3568471	PERSONALIZED VACCINES
C12N 15/02 (2006.01)	3568471	PERSONALIZED VACCINES
A61K 39/02 (2006.01)	3571288	INDUCTION OF PROTECTIVE IMMUNITY AGAINST ANTIGENS
C12N 1/15 (2006.01)	3571288	INDUCTION OF PROTECTIVE IMMUNITY AGAINST ANTIGENS
C12N 1/38 (2006.01)	3571288	INDUCTION OF PROTECTIVE IMMUNITY AGAINST ANTIGENS
C12N 15/03 (2006.01)	3571288	INDUCTION OF PROTECTIVE IMMUNITY AGAINST ANTIGENS
A61K 47/68 (2017.01)	3571230	COMPOSITIONS AND METHODS FOR THE DEPLETION OF CD137+ CELLS
C07K 16/28 (2006.01)	3571230	COMPOSITIONS AND METHODS FOR THE DEPLETION OF CD137+ CELLS
C12N 5/00 (2006.01)	3571230	COMPOSITIONS AND METHODS FOR THE DEPLETION OF CD137+ CELLS
A01H 5/00 (2018.01)	3570664	COMPOSITIONS AND METHODS FOR PROTECTING HOSTS AGAINST PATHOGEN INFECTIONS
A01N 37/18 (2006.01)	3570664	COMPOSITIONS AND METHODS FOR PROTECTING HOSTS AGAINST PATHOGEN INFECTIONS
A01N 61/00 (2006.01)	3570664	COMPOSITIONS AND METHODS FOR PROTECTING HOSTS AGAINST PATHOGEN INFECTIONS
C02F 1/44 (2006.01)	3571163	METHODS AND SYSTEMS FOR TREATMENT OF ETHYLENE OXIDE
C07D 301/32 (2006.01)	3571163	METHODS AND SYSTEMS FOR TREATMENT OF ETHYLENE OXIDE
G01N 33/00 (2006.01)	3571163	METHODS AND SYSTEMS FOR TREATMENT OF ETHYLENE OXIDE
A61K 38/08 (2019.01)	3570873	COMPOSITIONS AND METHODS FOR TREATING IRON OVERLOAD
A61K 38/10 (2006.01)	3570873	COMPOSITIONS AND METHODS FOR TREATING IRON OVERLOAD
A61K 38/16 (2006.01)	3570873	COMPOSITIONS AND METHODS FOR TREATING IRON OVERLOAD
A61K 38/17 (2006.01)	3570873	COMPOSITIONS AND METHODS FOR TREATING IRON OVERLOAD
A61K 38/22 (2006.01)	3570873	COMPOSITIONS AND METHODS FOR TREATING IRON OVERLOAD
A61P 3/00 (2006.01)	3570873	COMPOSITIONS AND METHODS FOR TREATING IRON OVERLOAD
A61P 7/06 (2006.01)	3570873	COMPOSITIONS AND METHODS FOR TREATING IRON OVERLOAD
A61P 13/12 (2006.01)	3570873	COMPOSITIONS AND METHODS FOR TREATING IRON OVERLOAD
H04L 29/08 (2006.01)	3576377	GAME SERVER SWITCHING METHOD, RELEVANT DEVICE AND SYSTEM
A61K 31/4439 (2006.01)	3575284	PHENYLDIFLUOROMETHYL-SUBSTITUTED PROLINEAMIDE COMPOUND
A61K 31/496 (2006.01)	3575284	PHENYLDIFLUOROMETHYL-SUBSTITUTED PROLINEAMIDE COMPOUND
A61P 13/12 (2006.01)	3575284	PHENYLDIFLUOROMETHYL-SUBSTITUTED PROLINEAMIDE COMPOUND
A61P 37/06 (2006.01)	3575284	PHENYLDIFLUOROMETHYL-SUBSTITUTED PROLINEAMIDE COMPOUND
A61P 37/08 (2006.01)	3575284	PHENYLDIFLUOROMETHYL-SUBSTITUTED PROLINEAMIDE COMPOUND
C07D 207/16 (2006.01)	3575284	PHENYLDIFLUOROMETHYL-SUBSTITUTED PROLINEAMIDE COMPOUND
C07D 401/10 (2006.01)	3575284	PHENYLDIFLUOROMETHYL-SUBSTITUTED PROLINEAMIDE COMPOUND
C07D 403/10 (2006.01)	3575284	PHENYLDIFLUOROMETHYL-SUBSTITUTED PROLINEAMIDE COMPOUND
B65G 1/04 (2006.01)	3573906	SYSTEM FOR AN AUTOMATED STORAGE
B65G 1/06 (2006.01)	3573906	SYSTEM FOR AN AUTOMATED STORAGE
C12N 1/00 (2006.01)	3574081	METHODS AND MICROORGANISMS FOR MAKING 2,3-BUTANEDIOL AND DERIVATIVES THEREOF FROM C1 CARBONS

MKP	Broj objave evropske prijave patenta	Naziv pronalaska
(51)	(97)	(54)
C12N 1/21 (2006.01)	3574081	METHODS AND MICROORGANISMS FOR MAKING 2,3-BUTANEDIOL AND DERIVATIVES THEREOF FROM C1 CARBONS
C12N 9/00 (2006.01)	3574081	METHODS AND MICROORGANISMS FOR MAKING 2,3-BUTANEDIOL AND DERIVATIVES THEREOF FROM C1 CARBONS
C12N 9/04 (2006.01)	3574081	METHODS AND MICROORGANISMS FOR MAKING 2,3-BUTANEDIOL AND DERIVATIVES THEREOF FROM C1 CARBONS
C12N 15/52 (2006.01)	3574081	METHODS AND MICROORGANISMS FOR MAKING 2,3-BUTANEDIOL AND DERIVATIVES THEREOF FROM C1 CARBONS
C12N 15/63 (2006.01)	3574081	METHODS AND MICROORGANISMS FOR MAKING 2,3-BUTANEDIOL AND DERIVATIVES THEREOF FROM C1 CARBONS
C12P 7/16 (2006.01)	3574081	METHODS AND MICROORGANISMS FOR MAKING 2,3-BUTANEDIOL AND DERIVATIVES THEREOF FROM C1 CARBONS
G06F 3/06 (2006.01)	3575948	SHARED DATA RECOVERY METHOD, DEVICE, COMPUTER EQUIPMENT AND STORAGE MEDIUM
A61K 39/02 (2006.01)	3573654	A FOOD SAFETY VACCINE TO CONTROL SALMONELLA ENTERICA AND REDUCE CAMPYLOBACTER IN POULTRY
C07K 14/205 (2006.01)	3573654	A FOOD SAFETY VACCINE TO CONTROL SALMONELLA ENTERICA AND REDUCE CAMPYLOBACTER IN POULTRY
C12N 15/74 (2006.01)	3573654	A FOOD SAFETY VACCINE TO CONTROL SALMONELLA ENTERICA AND REDUCE CAMPYLOBACTER IN POULTRY
A63F 13/822 (2014.01)	3574966	PROCESSING METHOD FOR DISPLAYING DATA AT CLIENT, AND RELATED DEVICE
A61K 9/00 (2006.01)	3576721	COMPOSITION COMPRISING IMMEDIATE RELEASE AND EXTENDED RELEASE CAPECITABINE
A61K 31/00 (2006.01)	3576721	COMPOSITION COMPRISING IMMEDIATE RELEASE AND EXTENDED RELEASE CAPECITABINE
C07D 487/22 (2006.01)	3565818	HYDROPORPHYRINS FOR PHOTOACOUSTIC IMAGING
G01N 21/64 (2006.01)	3565818	HYDROPORPHYRINS FOR PHOTOACOUSTIC IMAGING
A61K 31/517 (2006.01)	3578560	QUINAZOLINE COMPOUND
A61P 35/00 (2006.01)	3578560	QUINAZOLINE COMPOUND
C07D 471/10 (2006.01)	3578560	QUINAZOLINE COMPOUND
C07F 5/04 (2006.01)	3577122	APPARATUS AND CONTINUOUS FLOW PROCESS FOR PRODUCTION OF BORONIC ACID DERIVATIVE
F41G 1/387 (2006.01)	3577509	VIEWING OPTIC WITH AN INTEGRATED DISPLAY SYSTEM
F41G 3/06 (2006.01)	3577509	VIEWING OPTIC WITH AN INTEGRATED DISPLAY SYSTEM
F41G 11/00 (2006.01)	3577509	VIEWING OPTIC WITH AN INTEGRATED DISPLAY SYSTEM
G02B 7/00 (2006.01)	3577509	VIEWING OPTIC WITH AN INTEGRATED DISPLAY SYSTEM
G02B 27/01 (2006.01)	3577509	VIEWING OPTIC WITH AN INTEGRATED DISPLAY SYSTEM
A61K 38/00 (2006.01)	3576768	TREATMENT OF MUCOPOLYSACCHARIDOSIS I WITH FULLY-HUMAN GLYCOSYLATED HUMAN ALPHA-L-IDURONIDASE (IDUA)
A61K 38/43 (2006.01)	3576768	TREATMENT OF MUCOPOLYSACCHARIDOSIS I WITH FULLY-HUMAN GLYCOSYLATED HUMAN ALPHA-L-IDURONIDASE (IDUA)
A61K 48/00 (2006.01)	3576768	TREATMENT OF MUCOPOLYSACCHARIDOSIS I WITH FULLY-HUMAN GLYCOSYLATED HUMAN ALPHA-L-IDURONIDASE (IDUA)
A61P 25/00 (2006.01)	3576768	TREATMENT OF MUCOPOLYSACCHARIDOSIS I WITH FULLY-HUMAN GLYCOSYLATED HUMAN ALPHA-L-IDURONIDASE (IDUA)
A61P 25/28 (2006.01)	3576768	TREATMENT OF MUCOPOLYSACCHARIDOSIS I WITH FULLY-HUMAN GLYCOSYLATED HUMAN ALPHA-L-IDURONIDASE (IDUA)
C12N 15/09 (2006.01)	3576768	TREATMENT OF MUCOPOLYSACCHARIDOSIS I WITH FULLY-HUMAN GLYCOSYLATED HUMAN ALPHA-L-IDURONIDASE (IDUA)
C07K 7/60 (2006.01)	3577129	METHODS FOR TREATING FUNGAL INFECTIONS
A61K 48/00 (2006.01)	3577221	POLYNUCLEOTIDE SECONDARY STRUCTURE
C07H 19/02 (2006.01)	3577221	POLYNUCLEOTIDE SECONDARY STRUCTURE
C07H 21/00 (2006.01)	3577221	POLYNUCLEOTIDE SECONDARY STRUCTURE
C12N 15/11 (2006.01)	3577221	POLYNUCLEOTIDE SECONDARY STRUCTURE
A61P 31/04 (2006.01)	3577213	MICROBIAL CELLS, METHODS OF PRODUCING THE SAME, AND USES THEREOF
C12N 1/00 (2006.01)	3577213	MICROBIAL CELLS, METHODS OF PRODUCING THE SAME, AND USES THEREOF
C12N 1/04 (2006.01)	3577213	MICROBIAL CELLS, METHODS OF PRODUCING THE SAME, AND USES THEREOF
C12N 1/14 (2006.01)	3577213	MICROBIAL CELLS, METHODS OF PRODUCING THE SAME, AND USES THEREOF
C12N 1/21 (2006.01)	3577213	MICROBIAL CELLS, METHODS OF PRODUCING THE SAME, AND USES THEREOF
A61K 39/395 (2006.01)	3579876	PROTEINS BINDING BCMA, NKG2D AND CD16
C07K 16/28 (2006.01)	3579876	PROTEINS BINDING BCMA, NKG2D AND CD16
G06K 9/62 (2006.01)	3582144	SAMPLE SELECTION METHOD, APPARATUS AND SERVER

MKP	Broj objave evropske prijave patenta (97)	Naziv pronalaska (54)
(51)		
A61K 31/395 (2006.01)	3579835	HERBAL COMPOSITIONS OF CALIFORNIA POPPY AND METHOD FOR THE TREATMENT OF SLEEP AND DREAM-RELATED DISORDERS
A61K 31/4748 (2006.01)	3579835	HERBAL COMPOSITIONS OF CALIFORNIA POPPY AND METHOD FOR THE TREATMENT OF SLEEP AND DREAM-RELATED DISORDERS
A61K 36/71 (2006.01)	3579835	HERBAL COMPOSITIONS OF CALIFORNIA POPPY AND METHOD FOR THE TREATMENT OF SLEEP AND DREAM-RELATED DISORDERS
A61P 25/20 (2006.01)	3579835	HERBAL COMPOSITIONS OF CALIFORNIA POPPY AND METHOD FOR THE TREATMENT OF SLEEP AND DREAM-RELATED DISORDERS
C07D 451/14 (2006.01)	3579835	HERBAL COMPOSITIONS OF CALIFORNIA POPPY AND METHOD FOR THE TREATMENT OF SLEEP AND DREAM-RELATED DISORDERS
C07D 491/153 (2006.01)	3579835	HERBAL COMPOSITIONS OF CALIFORNIA POPPY AND METHOD FOR THE TREATMENT OF SLEEP AND DREAM-RELATED DISORDERS
C07K 16/28 (2006.01)	3580239	ANTI-ILT3 ANTIBODIES AND ANTIBODY DRUG CONJUGATES
A47J 43/046 (2006.01)	3579731	VACUUM BLENDER
A47J 43/07 (2006.01)	3579731	VACUUM BLENDER
A61K 39/395 (2006.01)	3582813	TREATMENT OF HIDRADENITIS SUPPURATIVA
A61P 17/00 (2006.01)	3582813	TREATMENT OF HIDRADENITIS SUPPURATIVA
C07K 16/24 (2006.01)	3582813	TREATMENT OF HIDRADENITIS SUPPURATIVA
C07K 16/28 (2006.01)	3583131	PROTEINS BINDING CD33, NKG2D AND CD16
C07K 16/32 (2006.01)	3583131	PROTEINS BINDING CD33, NKG2D AND CD16
A61K 39/00 (2006.01)	3582805	ANTI-PD-L1 ANTIBODY TREATMENT OF BLADDER CANCER
A61K 39/395 (2006.01)	3582805	ANTI-PD-L1 ANTIBODY TREATMENT OF BLADDER CANCER
C07K 16/28 (2006.01)	3582805	ANTI-PD-L1 ANTIBODY TREATMENT OF BLADDER CANCER
C07K 16/30 (2006.01)	3582805	ANTI-PD-L1 ANTIBODY TREATMENT OF BLADDER CANCER
G01N 33/574 (2006.01)	3582805	ANTI-PD-L1 ANTIBODY TREATMENT OF BLADDER CANCER
A61K 31/415 (2006.01)	3582773	PROCESSES FOR PREPARING AG-10, ITS INTERMEDIATES, AND SALTS THEREOF
A61P 13/12 (2006.01)	3582773	PROCESSES FOR PREPARING AG-10, ITS INTERMEDIATES, AND SALTS THEREOF
A61P 17/06 (2006.01)	3582773	PROCESSES FOR PREPARING AG-10, ITS INTERMEDIATES, AND SALTS THEREOF
H04N 7/18 (2006.01)	3585052	IMAGE IDENTIFICATION METHOD, DEVICE, APPARATUS, AND DATA STORAGE MEDIUM
G07C 5/08 (2006.01)	3584768	METHOD OF DETECTING PHOTOGRAPHIC DIRECTION SHIFT, DEVICE, APPARATUS, AND DATA STORAGE MEDIUM
A61K 31/7105 (2006.01)	3582790	HIGH POTENCY IMMUNOGENIC COMPOSITIONS
A61K 39/12 (2006.01)	3582790	HIGH POTENCY IMMUNOGENIC COMPOSITIONS
A61P 31/14 (2006.01)	3582790	HIGH POTENCY IMMUNOGENIC COMPOSITIONS
A61K 31/47 (2006.01)	3583943	PHARMACEUTICAL COMPOSITION
A61K 47/04 (2006.01)	3583943	PHARMACEUTICAL COMPOSITION
A61K 47/38 (2006.01)	3583943	PHARMACEUTICAL COMPOSITION
A61K 47/40 (2006.01)	3583943	PHARMACEUTICAL COMPOSITION
A61P 35/00 (2006.01)	3583943	PHARMACEUTICAL COMPOSITION
C07K 16/28 (2006.01)	3589658	ANTI-CD33 ANTIBODIES AND METHODS OF USE THEREOF
A61K 39/395 (2006.01)	3585429	ANTI-IL31 ANTIBODIES FOR VETERINARY USE
C07K 16/18 (2006.01)	3585429	ANTI-IL31 ANTIBODIES FOR VETERINARY USE
A61K 31/573 (2006.01)	3585405	PHARMACEUTICAL COMPOSITIONS OF A BILE ACID DERIVATIVE AND MICROBIOME AND USES THEREOF
A61K 35/74 (2015.01)	3585405	PHARMACEUTICAL COMPOSITIONS OF A BILE ACID DERIVATIVE AND MICROBIOME AND USES THEREOF
A61K 39/00 (2006.01)	3585426	COMPOSITIONS AND METHODS FOR TUMOR TRANSDUCTION
A61K 39/395 (2006.01)	3585426	COMPOSITIONS AND METHODS FOR TUMOR TRANSDUCTION
C07K 16/30 (2006.01)	3585426	COMPOSITIONS AND METHODS FOR TUMOR TRANSDUCTION
A61K 39/395 (2006.01)	3585431	BISPECIFIC BINDING MOLECULES THAT ARE CAPABLE OF BINDING CD137 AND TUMOR ANTIGENS, AND USES THEREOF
A61P 35/00 (2006.01)	3585431	BISPECIFIC BINDING MOLECULES THAT ARE CAPABLE OF BINDING CD137 AND TUMOR ANTIGENS, AND USES THEREOF
C07K 16/28 (2006.01)	3585817	COMPOSITIONS AND METHODS FOR TREATMENT OF CANCER
C07K 16/30 (2006.01)	3585817	COMPOSITIONS AND METHODS FOR TREATMENT OF CANCER
C07K 16/32 (2006.01)	3585817	COMPOSITIONS AND METHODS FOR TREATMENT OF CANCER
C07K 16/42 (2006.01)	3585817	COMPOSITIONS AND METHODS FOR TREATMENT OF CANCER
C07K 16/46 (2006.01)	3585817	COMPOSITIONS AND METHODS FOR TREATMENT OF CANCER

MKP	Broj objave evropske prijave patenta	Naziv pronalaska
(51)	(97)	(54)
C07K 19/00 (2006.01)	3585817	COMPOSITIONS AND METHODS FOR TREATMENT OF CANCER
A61K 31/4745 (2006.01)	3589285	INHIBITORS OF (ALPHA-V)(BETA-6) INTEGRIN
C07D 401/12 (2006.01)	3589285	INHIBITORS OF (ALPHA-V)(BETA-6) INTEGRIN
C07D 471/04 (2006.01)	3589285	INHIBITORS OF (ALPHA-V)(BETA-6) INTEGRIN
A61K 35/14 (2015.01)	3589646	CD19 COMPOSITIONS AND METHODS FOR IMMUNOTHERAPY
A61K 38/17 (2006.01)	3589646	CD19 COMPOSITIONS AND METHODS FOR IMMUNOTHERAPY
A61K 38/43 (2006.01)	3589646	CD19 COMPOSITIONS AND METHODS FOR IMMUNOTHERAPY
C07K 14/505 (2006.01)	3589646	CD19 COMPOSITIONS AND METHODS FOR IMMUNOTHERAPY
C07K 14/705 (2006.01)	3589646	CD19 COMPOSITIONS AND METHODS FOR IMMUNOTHERAPY
C07K 14/725 (2006.01)	3589646	CD19 COMPOSITIONS AND METHODS FOR IMMUNOTHERAPY
C07K 16/18 (2006.01)	3589646	CD19 COMPOSITIONS AND METHODS FOR IMMUNOTHERAPY
C07K 16/28 (2006.01)	3589646	CD19 COMPOSITIONS AND METHODS FOR IMMUNOTHERAPY
C07K 16/30 (2006.01)	3589646	CD19 COMPOSITIONS AND METHODS FOR IMMUNOTHERAPY
C07K 16/46 (2006.01)	3589646	CD19 COMPOSITIONS AND METHODS FOR IMMUNOTHERAPY
A61K 39/44 (2006.01)	3589952	IMPROVED KITS AND ASSAYS TO DETECT CIRCULATING MULTIPLE MYELOMA CELLS FROM BLOOD
A61K 51/10 (2006.01)	3589952	IMPROVED KITS AND ASSAYS TO DETECT CIRCULATING MULTIPLE MYELOMA CELLS FROM BLOOD
B03C 1/005 (2006.01)	3589952	IMPROVED KITS AND ASSAYS TO DETECT CIRCULATING MULTIPLE MYELOMA CELLS FROM BLOOD
C12N 15/13 (2006.01)	3589952	IMPROVED KITS AND ASSAYS TO DETECT CIRCULATING MULTIPLE MYELOMA CELLS FROM BLOOD
G01N 33/50 (2006.01)	3589952	IMPROVED KITS AND ASSAYS TO DETECT CIRCULATING MULTIPLE MYELOMA CELLS FROM BLOOD
G01N 33/574 (2006.01)	3589952	IMPROVED KITS AND ASSAYS TO DETECT CIRCULATING MULTIPLE MYELOMA CELLS FROM BLOOD
A61K 31/519 (2006.01)	3590516	ANTITUMOR-EFFECT ENHANCER USING PYRAZOLO[3,4-D]PYRIMIDINE COMPOUND
A61K 33/24 (2019.01)	3590516	ANTITUMOR-EFFECT ENHANCER USING PYRAZOLO[3,4-D]PYRIMIDINE COMPOUND
A61K 45/00 (2006.01)	3590516	ANTITUMOR-EFFECT ENHANCER USING PYRAZOLO[3,4-D]PYRIMIDINE COMPOUND
A61P 35/00 (2006.01)	3590516	ANTITUMOR-EFFECT ENHANCER USING PYRAZOLO[3,4-D]PYRIMIDINE COMPOUND
A61P 43/00 (2006.01)	3590516	ANTITUMOR-EFFECT ENHANCER USING PYRAZOLO[3,4-D]PYRIMIDINE COMPOUND
C07D 487/04 (2006.01)	3590516	ANTITUMOR-EFFECT ENHANCER USING PYRAZOLO[3,4-D]PYRIMIDINE COMPOUND
C07D 401/12 (2006.01)	3589627	INHIBITORS OF (ALPHA-V)(BETA-6) INTEGRIN
C07D 471/04 (2006.01)	3589627	INHIBITORS OF (ALPHA-V)(BETA-6) INTEGRIN
A61K 38/16 (2006.01)	3589648	ANTI-RSV MONOCLONAL ANTIBODY FORMULATION
A61K 39/395 (2006.01)	3589648	ANTI-RSV MONOCLONAL ANTIBODY FORMULATION
A61K 39/42 (2006.01)	3589648	ANTI-RSV MONOCLONAL ANTIBODY FORMULATION
A61P 31/12 (2006.01)	3589648	ANTI-RSV MONOCLONAL ANTIBODY FORMULATION
A61P 31/14 (2006.01)	3589648	ANTI-RSV MONOCLONAL ANTIBODY FORMULATION
C07K 16/08 (2006.01)	3589648	ANTI-RSV MONOCLONAL ANTIBODY FORMULATION
C07K 16/10 (2006.01)	3589648	ANTI-RSV MONOCLONAL ANTIBODY FORMULATION
A61K 31/546 (2006.01)	3592362	SOLID FORMS AND COMBINATION COMPOSITIONS COMPRISING A BETA-LACTAMASE INHIBITOR AND USES THEREOF
A61K 31/69 (2006.01)	3592362	SOLID FORMS AND COMBINATION COMPOSITIONS COMPRISING A BETA-LACTAMASE INHIBITOR AND USES THEREOF
A61P 31/04 (2006.01)	3592362	SOLID FORMS AND COMBINATION COMPOSITIONS COMPRISING A BETA-LACTAMASE INHIBITOR AND USES THEREOF
E21B 34/14 (2006.01)	3592945	A PROCESS FOR PRODUCING HYDROCARBON MATERIAL FROM A SUBTERRANEAN FORMATION WHILE EMPLOYING SOLIDS CONTROL
E21B 43/12 (2006.01)	3592945	A PROCESS FOR PRODUCING HYDROCARBON MATERIAL FROM A SUBTERRANEAN FORMATION WHILE EMPLOYING SOLIDS CONTROL
E21B 43/267 (2006.01)	3592945	A PROCESS FOR PRODUCING HYDROCARBON MATERIAL FROM A SUBTERRANEAN FORMATION WHILE EMPLOYING SOLIDS CONTROL
H04N 19/146 (2014.01)	3595307	METHOD FOR VIDEO CODING CODE RATE ALLOCATION AND CODING UNIT CODE RATE ALLOCATION, AND COMPUTER EQUIPMENT
H04N 19/147 (2014.01)	3595307	METHOD FOR VIDEO CODING CODE RATE ALLOCATION AND CODING UNIT CODE RATE ALLOCATION, AND COMPUTER EQUIPMENT

MKP	Broj objave evropske prijave patenta (97)	Naziv pronalaska (54)
(51)		
H04N 19/159 (2014.01)	3595307	METHOD FOR VIDEO CODING CODE RATE ALLOCATION AND CODING UNIT CODE RATE ALLOCATION, AND COMPUTER EQUIPMENT
H04N 19/176 (2014.01)	3595307	METHOD FOR VIDEO CODING CODE RATE ALLOCATION AND CODING UNIT CODE RATE ALLOCATION, AND COMPUTER EQUIPMENT
A61K 31/575 (2006.01)	3592359	CRYSTALLINE FORMS OF OBETICHOLIC ACID
C07J 9/00 (2006.01)	3592359	CRYSTALLINE FORMS OF OBETICHOLIC ACID
E21B 34/06 (2006.01)	3592946	APPARATUSES, SYSTEMS AND METHODS FOR PRODUCING HYDROCARBON MATERIAL FROM A SUBTERRANEAN FORMATION
E21B 43/12 (2006.01)	3592946	APPARATUSES, SYSTEMS AND METHODS FOR PRODUCING HYDROCARBON MATERIAL FROM A SUBTERRANEAN FORMATION
A61M 1/36 (2006.01)	3579897	SHORT-ACTING HEPARIN-BASED ANTICOAGULANT COMPOUNDS AND METHODS
B01D 15/36 (2006.01)	3579897	SHORT-ACTING HEPARIN-BASED ANTICOAGULANT COMPOUNDS AND METHODS
B28B 13/02 (2006.01)	3592522	APPARATUS AND METHOD FOR PRODUCING A PAVER BLOCK HAVING VEINED TREAD SURFACE
A61K 38/00 (2006.01)	3592373	TYPE X COLLAGEN ASSAYS AND METHODS OF USE THEREOF
A61K 48/00 (2006.01)	3592373	TYPE X COLLAGEN ASSAYS AND METHODS OF USE THEREOF
C07K 14/78 (2006.01)	3592373	TYPE X COLLAGEN ASSAYS AND METHODS OF USE THEREOF
C12N 15/12 (2006.01)	3592373	TYPE X COLLAGEN ASSAYS AND METHODS OF USE THEREOF
C12N 15/85 (2006.01)	3592373	TYPE X COLLAGEN ASSAYS AND METHODS OF USE THEREOF
G01N 33/53 (2006.01)	3592373	TYPE X COLLAGEN ASSAYS AND METHODS OF USE THEREOF
G01N 33/68 (2006.01)	3592373	TYPE X COLLAGEN ASSAYS AND METHODS OF USE THEREOF
G06F 17/10 (2006.01)	3559821	BACKWARD-COMPATIBLE INTEGRATION OF HARMONIC TRANSPOSER FOR HIGH FREQUENCY RECONSTRUCTION OF AUDIO SIGNALS
G10L 19/02 (2013.01)	3559821	BACKWARD-COMPATIBLE INTEGRATION OF HARMONIC TRANSPOSER FOR HIGH FREQUENCY RECONSTRUCTION OF AUDIO SIGNALS
G10L 19/22 (2013.01)	3559821	BACKWARD-COMPATIBLE INTEGRATION OF HARMONIC TRANSPOSER FOR HIGH FREQUENCY RECONSTRUCTION OF AUDIO SIGNALS
G10L 19/24 (2013.01)	3559821	BACKWARD-COMPATIBLE INTEGRATION OF HARMONIC TRANSPOSER FOR HIGH FREQUENCY RECONSTRUCTION OF AUDIO SIGNALS
G10L 19/26 (2013.01)	3559821	BACKWARD-COMPATIBLE INTEGRATION OF HARMONIC TRANSPOSER FOR HIGH FREQUENCY RECONSTRUCTION OF AUDIO SIGNALS
E21D 11/10 (2006.01)	3580429	REINFORCEMENT SYSTEM FOR THE CONCRETE LINING OF THE INNER SHELL OF A TUNNEL CONSTRUCTION
A01G 24/12 (2018.01)	3560908	SOIL BUILDER
A01G 24/15 (2018.01)	3560908	SOIL BUILDER
A01G 24/22 (2018.01)	3560908	SOIL BUILDER
C05D 1/04 (2006.01)	3560908	SOIL BUILDER
C05D 9/00 (2006.01)	3560908	SOIL BUILDER
C05F 1/00 (2006.01)	3560908	SOIL BUILDER
C05F 3/00 (2006.01)	3560908	SOIL BUILDER
C05F 5/00 (2006.01)	3560908	SOIL BUILDER
C05G 1/00 (2006.01)	3560908	SOIL BUILDER
C05G 3/04 (2006.01)	3560908	SOIL BUILDER
C09K 17/00 (2006.01)	3560908	SOIL BUILDER
C09K 17/40 (2006.01)	3560908	SOIL BUILDER
B28B 11/00 (2006.01)	3584383	MULTILAYER STRUCTURAL ELEMENT, METHOD AND PRODUCTION LINE FOR PRODUCTION THEREOF
B32B 3/08 (2006.01)	3584383	MULTILAYER STRUCTURAL ELEMENT, METHOD AND PRODUCTION LINE FOR PRODUCTION THEREOF
B65G 47/00 (2006.01)	3584383	MULTILAYER STRUCTURAL ELEMENT, METHOD AND PRODUCTION LINE FOR PRODUCTION THEREOF
E04C 1/40 (2006.01)	3584383	MULTILAYER STRUCTURAL ELEMENT, METHOD AND PRODUCTION LINE FOR PRODUCTION THEREOF
A61K 9/00 (2006.01)	3498268	PHARMACEUTICAL COMPOSITION OF S-KETAMINE HYDROCHLORIDE
A61K 31/135 (2006.01)	3498268	PHARMACEUTICAL COMPOSITION OF S-KETAMINE HYDROCHLORIDE

MKP	Broj objave evropske prijave	Naziv pronalaska
(51)	(97)	(54)
A61K 47/12 (2006.01)	3498268	PHARMACEUTICAL COMPOSITION OF S-KETAMINE HYDROCHLORIDE
A61P 25/24 (2006.01)	3498268	PHARMACEUTICAL COMPOSITION OF S-KETAMINE HYDROCHLORIDE

Indeks podnosioca zahtjeva za proširenje evropskih prijava patenta

Indeks podnosioca zahtjeva za proširenje evropskih prijava patenta

Podnosilac evropske prijave patenta (71)	MKP (51)	Broj objave evropske prijave patenta (97)	Naziv pronalaska (54)
	B32B 5/14 (2006.01) C04B 28/14 (2006.01)	3559365	GYPSUM PLASTERBOARD
UCB Biopharma SRL LTS Lohmann Therapie- Systeme AG Tuma Pumpensysteme GmbH	E04C 2/04 (2006.01) A61K 9/70 (2006.01) A61K 31/381 (2006.01)	3257504	POLYVINYLPIRROLIDONE FOR THE STABILIZATION OF A SOLID DISPERSION OF THE NON-CRYSTALLINE FORM OF ROTIGOTINE
	B01J 8/10 (2006.01) B01J 8/22 (2006.01) B01J 8/38 (2006.01) B01J 19/18 (2006.01) C10L 1/08 (2006.01) F04C 7/00 (2006.01) F04C 19/00 (2006.01)	3441136	DEVICE FOR CRUSHING AND MIXING, SYSTEM AND METHOD FOR CATALYTIC PRESSURELESS OILING
Steinbeis Interagierende Systeme GmbH	G06F 8/35 (2018.01) G06F 11/36 (2006.01) G06F 17/50 (2006.01) G06Q 30/08 (2012.01)	3486766	COMPUTER-IMPLEMENTED METHOD OF AUGMENTING A SIMULATION MODEL OF A PHYSICAL ENVIRONMENT OF A VEHICLE
Jakschies, Detlef von Mutius, Dietrich Erber, Walter	G01N 33/558 (2006.01) G01N 33/569 (2006.01)	3489686	METHOD AND DEVICE FOR DISCRIMINATING BETWEEN VIRAL AND BACTERIAL INFECTIONS
NautiBuoy Marine Limited	B29C 65/48 (2006.01) B29D 22/02 (2006.01) B29K 105/04 (2006.01) B63B 7/08 (2006.01) B63C 1/02 (2006.01) A61K 8/04 (2006.01) A61K 8/73 (2006.01) A61Q 11/00 (2006.01) A61K 31/58 (2006.01) A61K 35/00 (2006.01) A61K 45/06 (2006.01) A61K 47/65 (2017.01) A61P 35/00 (2006.01) C07K 14/195 (2006.01) C07K 14/52 (2006.01) C12N 15/70 (2006.01) C12N 15/74 (2006.01) A61K 31/4439 (2006.01) A61K 31/444 (2006.01) A61P 37/00 (2006.01) C07D 213/81 (2006.01) C07D 401/12 (2006.01) C07D 401/14 (2006.01) C07D 413/14 (2006.01) C07D 513/04	3489003	METHOD OF MANUFACTURE OF AN INFLATABLE PRODUCT WITH AN ATTACHABLE FOAM FINISH
	A61K 8/04 (2006.01) A61K 8/73 (2006.01) A61Q 11/00 (2006.01) A61K 31/58 (2006.01) A61K 35/00 (2006.01) A61K 45/06 (2006.01) A61K 47/65 (2017.01) A61P 35/00 (2006.01) C07K 14/195 (2006.01) C07K 14/52 (2006.01) C12N 15/70 (2006.01) C12N 15/74 (2006.01) A61K 31/4439 (2006.01) A61K 31/444 (2006.01) A61P 37/00 (2006.01) C07D 213/81 (2006.01) C07D 401/12 (2006.01) C07D 401/14 (2006.01) C07D 413/14 (2006.01) C07D 513/04	3492143	LOW VISCOSITY DENTAL CARE COMPOSITION
	A61K 31/58 (2006.01) A61K 35/00 (2006.01) A61K 45/06 (2006.01) A61K 47/65 (2017.01) A61P 35/00 (2006.01) C07K 14/195 (2006.01) C07K 14/52 (2006.01) C12N 15/70 (2006.01) C12N 15/74 (2006.01) A61K 31/4439 (2006.01) A61K 31/444 (2006.01) A61P 37/00 (2006.01) C07D 213/81 (2006.01) C07D 401/12 (2006.01) C07D 401/14 (2006.01) C07D 413/14 (2006.01) C07D 513/04	3558376	A THERAPEUTIC COMBINATION COMPRISING A PULMONARY SURFACTANT AND A STEROID FOR THE TREATMENT OF EVOLVING BPD
	A61K 47/65 (2017.01) A61P 35/00 (2006.01) C07K 14/195 (2006.01) C07K 14/52 (2006.01) C12N 15/70 (2006.01) C12N 15/74 (2006.01) A61K 31/4439 (2006.01) A61K 31/444 (2006.01) A61P 37/00 (2006.01) C07D 213/81 (2006.01) C07D 401/12 (2006.01) C07D 401/14 (2006.01) C07D 413/14 (2006.01) C07D 513/04	3558388	ANTIBODY DRUG CONJUGATES (ADCS) HAVING ENZYMATICALLY CLEAVABLE GROUPS
	A61K 47/65 (2017.01) A61P 35/00 (2006.01) C07K 14/195 (2006.01) C07K 14/52 (2006.01) C12N 15/70 (2006.01) C12N 15/74 (2006.01) A61K 31/4439 (2006.01) A61K 31/444 (2006.01) A61P 37/00 (2006.01) C07D 213/81 (2006.01) C07D 401/12 (2006.01) C07D 401/14 (2006.01) C07D 413/14 (2006.01) C07D 513/04	3559022	VIRULENCE ATTENUATED BACTERIA BASED PROTEIN DELIVERY
	A61K 47/65 (2017.01) A61P 35/00 (2006.01) C07K 14/195 (2006.01) C07K 14/52 (2006.01) C12N 15/70 (2006.01) C12N 15/74 (2006.01) A61K 31/4439 (2006.01) A61K 31/444 (2006.01) A61P 37/00 (2006.01) C07D 213/81 (2006.01) C07D 401/12 (2006.01) C07D 401/14 (2006.01) C07D 413/14 (2006.01) C07D 513/04	3558973	PYRIDINE DERIVATIVES AS IMMUNOMODULATORS

Podnosilac evropske prijave patenta (71)	MKP (51)	Broj objave evropske prijave patenta (97)	Naziv pronalaska (54)
	(2006.01) A61P 35/00 (2006.01) C07K 16/28 (2006.01)	3559040	BINDING MOLECULES FOR THE TREATMENT OF CANCER
	(2006.01) A61K 39/12 (2006.01) A61K 39/235 (2006.01) C07K 14/075 (2006.01) C12N 15/861 (2006.01)	3551224	ADENOVIRUS POLYNUCLEOTIDES AND POLYPEPTIDES
Gas Teh Ltd	F16K 1/12 (2006.01) G05D 16/06 (2006.01) G05D 16/16 (2006.01)	3563208	AXIAL GAS PRESSURE REGULATOR
	(2006.01) A61K 31/423 (2006.01) A61P 37/00 (2006.01) C07D 413/06 (2006.01) C07D 413/12 (2006.01) C07D 413/14 (2006.01) C07D 471/04 (2006.01) C07D 487/04 (2006.01) C07D 498/04 (2006.01) C07D 513/04 (2006.01)	3558985	BENZOOXAZOLE DERIVATIVES AS IMMUNOMODULATORS
Sutrovax, Inc.	A61K 39/09 (2006.01) A61K 47/64 (2017.01) A61P 31/04 (2006.01)	3562503	POLYPEPTIDE-ANTIGEN CONJUGATES WITH NON-NATURAL AMINO ACIDS
	B60K 6/48 (2007.01)	3551489	APPARATUS FOR SELECTIVELY SHARING THE POWER OF A MULTIDRIVE UNIT VEHICLE
	A61K 31/4439 (2006.01) A61K 31/444 (2006.01) A61K 31/4725 (2006.01) A61K 31/538 (2006.01) A61P 35/00 (2006.01) C07D 401/12 (2006.01) C07D 401/14 (2006.01) C07D 405/14 (2006.01) C07D 413/14 (2006.01) C07D 417/14 (2006.01) C07D 471/04 (2006.01) C07D 487/04 (2006.01) C07D 491/04 (2006.01)	3558969	PYRAZOLE DERIVATIVES AS MALT1 INHIBITORS

Podnosilac evropske prijave patenta (71)	MKP (51)	Broj objave evropske prijave patenta (97)	Naziv pronalaska (54)		
Bayer Consumer Care AG	C07D 495/04 (2006.01)	3453381	METHOD AND USE OF A COMPOSITION FOR IMPROVING HAIR APPEARANCE		
	A23L 33/105 (2016.01)				
	A23L 33/15 (2016.01)				
	A23L 33/175 (2016.01)				
	A61K 8/97 (2017.01)				
	A61K 9/48 (2006.01)				
	A61K 31/197 (2006.01)				
	A61K 31/4188 (2006.01)				
	A61K 47/18 (2017.01)				
	C07K 16/24 (2006.01)			3456736	ANTIBODY VARIANTS
	C07K 16/24 (2006.01)			3456737	ANTIBODY VARIANTS
	C07K 16/24 (2006.01)			3456738	ANTIBODY VARIANTS
	A61K 9/16 (2006.01)			3459527	METHOD FOR PREPARING A SOLID DOSAGE FORM COMPRISING ANTIBODIES BY WET GRANULATION, EXTRUSION AND SPHERONIZATION
	A61K 39/00 (2006.01)			3459528	PREPARATION OF SOLID DOSAGE FORMS COMPRISING ANTIBODIES BY SOLUTION/SUSPENSION LAYERING
A61K 9/16 (2006.01)					
A61K 39/00 (2006.01)	3459529	PREPARATION OF SUSTAINED RELEASE SOLID DOSAGE FORMS COMPRISING ANTIBODIES BY SPRAY DRYING			
Cellmic, LLC	C07K 16/24 (2006.01)	3580550	IMAGING SYSTEM FOR COUNTING AND SIZING PARTICLES IN FLUID-FILLED VESSELS		
	G01N 15/02 (2006.01)				
	G01N 15/14 (2006.01)				
	G01N 21/47 (2006.01)				
	G01N 21/51 (2006.01)				
	G01N 35/00 (2006.01)				
	G01N 35/04 (2006.01)				
	G01N 33/52 (2006.01)			3552018	DIAGNOSTIC TESTING ASSAYS AND RELATED DEVICES WITH SECURITY AND METHODS OF USE THEREOF
	G01N 33/543 (2006.01)				
	G01N 33/558 (2006.01)				
University of Washington	A61K 38/46 (2006.01)	3449933	THERAPEUTIC NUCLEASE COMPOSITIONS AND METHODS		
	A61K 47/68 (2017.01)				
	C07K 16/44 (2006.01)				
	C07K 16/46 (2006.01)				
	C07K 19/00 (2006.01)				
	C12N 9/22 (2006.01)				
	C12N 15/55 (2006.01)				
	C12N 15/62 (2006.01)				
Achleitner, Franz	F41A 27/08 (2006.01)	3569967	CARDAN MOUNT		
	F41A 27/10 (2006.01)	3250597	VEGFA/ANG2 COMPOUNDS		
	A61K 39/395 (2006.01)				

Podnosilac evropske prijave patenta (71)	MKP (51)	Broj objave evropske prijave patenta (97)	Naziv pronalaska (54)
	A61P 27/02 (2006.01)		
	A61P 35/00 (2006.01)		
	C07K 16/22 (2006.01)		
	C07K 16/00 (2006.01)	3247721	IgG BISPECIFIC ANTIBODIES AND PROCESSES FOR PREPARATION
	C07K 16/28 (2006.01)		
	C07K 16/32 (2006.01)		
	A61M 5/20 (2006.01)	3573687	DOSE CONTROL SYSTEM FOR INJECTABLE- DRUG DELIVERY DEVICES AND ASSOCIATED METHODS OF USE
	A61M 5/315 (2006.01)		
Cheli, Gabriele	A47J 47/00 (2006.01)	3552529	AN INNOVATIVE CHOPPING BOARD EQUIPPED WITH A PROTECTIVE EDGE
Robert Bosch GmbH	B66F 7/06 (2006.01)	3573919	IMPROVED INDUSTRIAL TRUCK
	B66F 9/06 (2006.01)		
	B66F 9/075 (2006.01)		
MXS Group	F16M 11/04 (2006.01)	3566000	DEVICE FOR SNAP-FIT FASTENING OF AN ACCESSORY ON A WALL
	F16M 13/02 (2006.01)		
	A61K 31/337 (2006.01)	3565547	COMBINATION OF A MCL-1 INHIBITOR AND A TAXANE COMPOUND, USES AND PHARMACEUTICAL COMPOSITIONS THEREOF
	A61K 31/519 (2006.01)		
	A61K 45/06 (2006.01)		
	A61P 35/00 (2006.01)		
	A61K 31/255 (2006.01)	3565545	IL-8 INHIBITORS FOR USE IN THE TREATMENT OF SOME UROLOGICAL DISORDERS
	A61K 31/421 (2006.01)		
	A61K 31/427 (2006.01)		
	A61P 13/08 (2006.01)		
Küchenatlas Portal Betriebs GmbH	G06F 3/03 (2006.01)	3568780	METHOD OF KITCHEN PLANNING
	G06F 17/50 (2006.01)		
	A61K 31/506 (2006.01)	3571192	JAK1 SELECTIVE INHIBITORS
	A61P 17/14 (2006.01)		
	A61P 37/00 (2006.01)		
	C07D 403/04 (2006.01)		
	C07D 403/14 (2006.01)		
Biontech SE University Of Verona	A61K 35/12 (2015.01)	3571296	ENGINEERED CELLS FOR INDUCING TOLERANCE
	A61K 35/15 (2015.01)		
	A61K 35/28 (2015.01)		
	A61K 48/00 (2006.01)		
	C07K 14/435 (2006.01)		
	C12N 5/0775 (2010.01)		
	C12N 5/0786 (2010.01)		
	A61L 2/07 (2006.01)	3576797	STERILIZING APPARATUS FOR THE STERILIZATION OF POST-CONSUMER
	A61L 11/00 (2006.01)		

Podnosilac evropske prijave patenta (71)	MKP (51)	Broj objave evropske prijave patenta (97)	Naziv pronalaska (54)
Gruner, Andreas Heiko	B25B 27/30 (2006.01)	3568264	ABSORBENT SANITARY PRODUCTS TENSIONING DEVICE FOR TENSIONING A HELICAL SPRING
	E05D 13/00 (2006.01)		
	A61K 31/437 (2006.01)	3577112	ARYL HYDROCARBON RECEPTOR (AHR) MODULATOR COMPOUNDS
	A61P 35/00 (2006.01)		
	C07D 471/04 (2006.01)		
	A61K 39/00 (2006.01)	3565835	HUMAN ANTIBODIES TO S.AUREUS HEMOLYSIN A TOXIN
	A61P 31/04 (2006.01)		
	C07K 16/12 (2006.01)	3565526	TOPICAL DETOMIDINE FORMULATIONS
	A61K 9/00 (2006.01)		
	A61K 31/00 (2006.01)		
A61K 47/10 (2017.01)			
A61K 47/32 (2006.01)			
A61K 47/38 (2006.01)			
A61K 39/00 (2006.01)			
Hav Vaccines Limited	C07K 14/35 (2006.01)	3568698	DIAGNOSTIC
	C07K 16/12 (2006.01)		
	G01N 33/569 (2006.01)	3565811	INHIBITORS OF NHE-MEDIATED ANTIPORT
	A61K 31/4725 (2006.01)		
	A61P 1/10 (2006.01)		
	A61P 9/12 (2006.01)		
	C07D 401/12 (2006.01)		
C07D 401/14 (2006.01)			
Rodin Therapeutics, Inc.	A61K 31/437 (2006.01)	3568135	BICYCLIC INHIBITORS OF HISTONE DEACETYLASE
	A61K 31/4439 (2006.01)		
	A61K 31/519 (2006.01)		
	A61P 25/28 (2006.01)		
Schunk Bahn- und Industrietechnik GmbH	B60L 5/42 (2006.01)	3568313	CONTACT UNIT FOR A CHARGING STATION, AND METHOD FOR MAKING CONTACT CANCER TREATMENT
	B60L 11/18 (2006.01)	3576740	
	A61K 31/498 (2006.01)		
	A61P 35/00 (2006.01)		
Associazione Oncologica Milanese Amo La Vita Onlus	G01N 33/574 (2006.01)	3570823	USE OF CAROTENOID DERIVATIVES TO REDUCE THE TOXICITY AND INCREASE THE EFFICACY OF ANTI-EGFR ANTITUMOR TREATMENTS
	A61K 31/01 (2006.01)		
	A61K 31/4745 (2006.01)		
	A61K 31/513 (2006.01)		
	A61K 31/555 (2006.01)		
	A61K 45/06 (2006.01)		
	A61P 35/00 (2006.01)		

Podnosilac evropske prijave patenta (71)	MKP (51)	Broj objave evropske prijave patenta (97)	Naziv pronalaska (54)
Verve SpA	B29C 49/06 (2006.01) B29C 49/36 (2006.01) B29C 49/42 (2006.01) B29C 49/80 (2006.01)	3571036	IMPROVED MACHINE FOR THE PRODUCTION OF CONTAINERS AND CHECKING METHOD
Istituti Clinici Scientifici Maugeri Spa Società Benefit	A61K 38/17 (2006.01) A61P 21/00 (2006.01) A61K 35/17 (2015.01) C12N 5/078 (2010.01) C12N 5/0783 (2010.01) A61P 25/28 (2006.01) C07K 16/18 (2006.01) G01N 33/68 (2006.01) A61K 39/395 (2006.01) A61P 7/02 (2006.01) C07K 16/36 (2006.01) A61K 39/00 (2006.01) C07K 7/06 (2006.01) C07K 7/08 (2006.01) C07K 14/47 (2006.01) C07K 14/705 (2006.01) A61K 31/437 (2006.01) A61K 31/519 (2006.01) A61P 25/28 (2006.01) A61K 31/4545 (2006.01) A61P 35/00 (2006.01) A61K 8/00 (2006.01) A61K 9/00 (2006.01) A61K 36/53 (2006.01) A61P 17/14 (2006.01) C07K 14/64 (2006.01) A61J 1/14 (2006.01) A61J 1/20 (2006.01) A61M 5/145 (2006.01) A61M 5/28 (2006.01) A61K 31/445 (2006.01) A61P 25/00 (2006.01) A61P 25/28 (2006.01) C07D 417/14 (2006.01) A61K 31/496	3573716 3565888 3565836 3570882 3573647 3570834 3570839 3568146 3574004 3582825 3573983 3573981	BIOLOGICALLY ACTIVE FUSION PEPTIDE FOR USE IN THE TREATMENT OF SPINAL MUSCULAR ATROPHY (SMA) EXPANSION OF TUMOR INFILTRATING LYMPHOCYTES (TILS) WITH TUMOR NECROSIS FACTOR RECEPTOR SUPERFAMILY (TNFRSF) AGONISTS AND THERAPEUTIC COMBINATIONS OF TILS AND TNFRSF AGONISTS ANTIBODIES SPECIFIC FOR HYPERPHOSPHORYLATED TAU FOR THE TREATMENT OF OCULAR DISEASES NOVEL STABLE FORMULATION FOR FXIA ANTIBODIES NOVEL PEPTIDES AND COMBINATION OF PEPTIDES FOR USE IN IMMUNOTHERAPY AGAINST OVARIAN CANCER AND OTHER CANCERS BICYCLIC INHIBITORS OF HISTONE DEACETYLASE SOLID DISPERSIONS OF (R)-N-((4-METHOXY-6-METHYL-2-OXO-1,2-DIHYDROPIRIDIN-3-YL)METHYL)-2-METHYL-1-(1-(1-(2,2,2-TRIFLUOROETHYL)PIPERIDIN-4-YL)ETHYL)-1H-INDOLE-3-CARBOXAMIDE VEGETABLE EXTRACT TO PREVENT AND TREAT HAIR LOSS RELAXIN FUSION POLYPEPTIDES AND USES THEREOF DRUG DELIVERY DEVICE WITH STERILE FLUID FLOWPATH AND RELATED METHOD OF ASSEMBLY N-[4-FLUORO-5-[[[(2S,4S)-2-METHYL-4-[(5-METHYL-1,2,4-OXADIAZOL-3-YL)METHOXY]-1-PIPERIDYL]METHYL]THIAZOL-2-YL]ACETAMIDE AS OGA INHIBITOR ALKOXY BIS-HETEROARYL DERIVATIVES AS

Podnosilac evropske prijave patenta (71)	MKP (51)	Broj objave evropske prijave patenta (97)	Naziv pronalaska (54)
	(2006.01) A61P 25/28 (2006.01) C07D 417/12 (2006.01) C07D 417/14 (2006.01) A61K 31/496 (2006.01) A61K 31/501 (2006.01) A61K 31/506 (2006.01) A61P 25/28 (2006.01) A61P 35/00 (2006.01) C07D 417/12 (2006.01) C07D 417/14 (2006.01) C07D 471/04 (2006.01) C07D 487/04 (2006.01) C07D 498/04 (2006.01)	3573982	MODULATORS OF PROTEIN AGGREGATION BIS-HETEROARYL DERIVATIVES AS MODULATORS OF PROTEIN AGGREGATION
Hi-stem GgmbH	C07D 471/04 (2006.01) C07D 487/04 (2006.01) C07D 498/04 (2006.01) C12N 15/113 (2010.01) G01N 33/574 (2006.01)	3573986 3577222	BICYCLIC BIS-HETEROARYL DERIVATIVES AS MODULATORS OF PROTEIN AGGREGATION NOVEL METHODS FOR SUB-TYPING AND TREATING CANCER
	A61K 8/02 (2006.01) A61K 8/19 (2006.01) A61K 8/29 (2006.01) A61Q 17/04 (2006.01)	3579928	FUNCTIONALIZED CALCIUM CARBONATE FOR SUN PROTECTION BOOSTING
	A61K 39/395 (2006.01) A61P 35/00 (2006.01) C07K 16/28 (2006.01)	3565594	METHODS OF TREATING CANCER WITH ANTI- TIM-3 ANTIBODIES
	A61K 31/437 (2006.01) A61K 31/519 (2006.01) A61P 11/06 (2006.01) C07D 471/04 (2006.01) C07D 487/04 (2006.01) C07D 519/00 (2006.01)	3573987	TYROSINE AMIDE DERIVATIVES AS RHO- KINASE INHIBITORS
Sauro S.r.l.	H01R 4/36 (2006.01) H01R 12/51 (2011.01) H01R 12/75 (2011.01)	3583662	CONNECTOR FOR PRINTED CIRCUIT BOARDS
For Health Pharma S.r.l.	A61K 9/00 (2006.01) A61K 47/32 (2006.01) A61K 47/36 (2006.01)	3573597	TEAR SUBSTITUTE
	A61K 31/40 (2006.01) A61K 31/41 (2006.01) A61K 31/435 (2006.01)	3565808	COMPOUNDS USEFUL FOR TREATING GASTROINTESTINAL TRACT DISORDERS

Podnosilac evropske prijave patenta (71)	MKP (51)	Broj objave evropske prijave patenta (97)	Naziv pronalaska (54)
	A61K 31/445 (2006.01)		
	A61K 31/4462 (2006.01)		
	C07D 207/12 (2006.01)		
	C07D 211/56 (2006.01)		
	C07D 225/02 (2006.01)		
	C07D 249/04 (2006.01)		
	C07D 295/033 (2006.01)		
	C07D 317/26 (2006.01)		
Herbolea Biotech S.R.L.	C12P 7/22 (2006.01) C12P 17/06 (2006.01)	3571307	ENZYME-ASSISTED LIPID-BASED EXTRACTION AND STABILIZATION OF PHYTO-CANNABINOIDS AND TERPENS AND PRODUCTS OBTAINED THEREOF
Deutsches Krebsforschungszentrum	A61K 31/501 (2006.01) A61P 35/00 (2006.01) C07D 237/04 (2006.01) C07D 237/24 (2006.01) C07D 401/04 (2006.01) C07D 401/14 (2006.01) C07D 403/04 (2006.01) C07D 405/14 (2006.01) C07D 409/04 (2006.01) C07D 413/04 (2006.01) C07D 417/04 (2006.01) C07D 417/14 (2006.01)	3580211	2-HETEROARYL-3-OXO-2,3-DIHYDROPYRIDAZINE-4-CARBOXAMIDES FOR THE TREATMENT OF CANCER
	A61P 35/00 (2006.01) C07K 16/28 (2006.01)	3565844	METHODS OF TREATING CANCER WITH ANTI-PD-1 ANTIBODIES
Evonik Operations GmbH	C12P 19/24 (2006.01)	3583224	PROCESS FOR PRODUCTION OF A SOLID MATERIAL CONTAINING ISOMALTULOSE CRYSTALS AND TREHALULOSE
	A61K 31/416 (2006.01) A61K 31/4162 (2006.01) A61K 31/424 (2006.01) A61K 31/429 (2006.01) A61P 1/00 (2006.01) A61P 5/00 (2006.01) A61P 11/00 (2006.01) A61P 13/00 (2006.01) A61P 17/00 (2006.01) A61P 25/00 (2006.01) A61P 31/00	3571187	CHEMICAL COMPOUNDS AS INHIBITORS OF INTERLEUKIN-1 ACTIVITY

Podnosilac evropske prijave patenta (71)	MKP (51)	Broj objave evropske prijave patenta (97)	Naziv pronalaska (54)
	(2006.01) A61P 35/00 (2006.01) C07D 231/56 (2006.01) C07D 263/52 (2006.01) C07D 265/12 (2006.01) C07D 487/04 (2006.01) C07D 498/04 (2006.01) C07D 498/20 (2006.01) C07D 513/04 (2006.01) C07C 205/19 (2006.01) C07D 207/452 (2006.01) C07D 487/04 (2006.01) C07D 519/04 (2006.01)		
	A61K 39/00 (2006.01) A61K 39/395 (2006.01) C07K 16/28 (2006.01)	3573948	METHODS OF PREPARING CYTOTOXIC BENZODIAZEPINE DERIVATIVES
Acticor Biotech Université Paris Diderot Paris 7 Université Paris XIII INSERM (Institut National de la Santé et de la Recherche Scientifique) Université Paris Sud 11 Adapta SPA	G01N 33/36 (2006.01) A61K 9/00 (2006.01) A61K 38/00 (2006.01) C12N 9/64 (2006.01) C04B 18/16 (2006.01) C04B 26/26 (2006.01) C08L 91/00 (2006.01) C08L 95/00 (2006.01) E01C 1/00 (2006.01) E01C 7/35 (2006.01) A61K 31/215 (2006.01) A61K 31/5377 (2006.01) A61K 38/08 (2019.01) A61P 27/02 (2006.01) A61P 27/06 (2006.01) A61K 31/454 (2006.01) A61K 39/00 (2006.01) A61P 35/00 (2006.01) C07K 16/28 (2006.01) C12Q 1/6869 (2018.01) C08J 7/04 (2006.01) C09D 151/02 (2006.01)	3577136	INHIBITION OF PLATELET AGGREGATION USING ANTI-HUMAN GPVI ANTIBODIES
		3586127	MODULABLE SYSTEM FOR IDENTIFYING AND CERTIFYING GARMENTS
		3576762	FACTOR IX FUSION PROTEINS AND METHODS OF MAKING AND USING SAME
		3577169	BITUMINOUS EMULSIONS CONTAINING STEROL ADDITIVE FOR ASPHALT PAVEMENT
		3576770	COMPOUNDS AND COMPOSITIONS FOR THE TREATMENT OF OPHTHALMIC DISORDERS
		3568414	EPIGENETIC ANALYSIS OF CELL THERAPY AND RELATED METHODS
		3585844	MINERAL OIL BARRIER

Podnositelj evropske prijave patenta (71)	MKP (51)	Broj objave evropske prijave patenta (97)	Naziv pronalaska (54)
Genmab B.V.	C07D 487/10 (2006.01)	3577121	OGA INHIBITOR COMPOUNDS
	C07K 16/00 (2006.01)	3580233	POLYPEPTIDE VARIANTS AND USES THEREOF
	C07K 16/10 (2006.01)		
	C07K 16/28 (2006.01)		
	A61K 31/44 (2006.01)	3580204	SULFINYLPIRIDINES AND THEIR USE IN THE TREATMENT OF CANCER
	A61P 35/00 (2006.01)		
	C07D 213/72 (2006.01)		
	A61K 31/427 (2006.01)	3580215	HETEROARYLSULFONYL-SUBSTITUTED PYRIDINES AND THEIR USE IN THE TREATMENT OF CANCER
	A61K 31/44 (2006.01)		
	A61P 35/00 (2006.01)		
	C07D 401/12 (2006.01)		
	C07D 403/12 (2006.01)		
	C07D 417/12 (2006.01)		
	A61K 31/44 (2006.01)	3580209	HETEROCYCLYSULFONYL-SUBSTITUTED PYRIDINES AND THEIR USE IN THE TREATMENT OF CANCER
A61P 35/00 (2006.01)			
C07D 401/12 (2006.01)			
C07D 407/12 (2006.01)			
B01D 53/14 (2006.01)	3579964	DEVICE FOR PRODUCING AND TREATING A GAS STREAM THROUGH AN AUTOMATICALLY CONTROLLED VOLUME OF LIQUID	
B01D 53/50 (2006.01)			
B01D 53/78 (2006.01)			
B01J 4/00 (2006.01)			
B01J 19/24 (2006.01)			
Alla Chem, LLC	A61K 31/664 (2006.01)	3473636	NUCLEOTIDES CONTAINING AN N-[(S)-1-CYCLOBUTOXYCARBONYL]PHOSPHORAMIDATE FRAGMENT, ANALOGS THEREOF, AND USE THEREOF
	A61K 31/675 (2006.01)		
	A61K 31/7072 (2006.01)		
	A61K 31/7076 (2006.01)		
	A61K 31/708 (2006.01)		
	A61P 31/18 (2006.01)		
	A61P 31/20 (2006.01)		
	C07F 9/36 (2006.01)		
	C07F 9/44 (2006.01)		
	C07F 9/6561 (2006.01)		
	C07H 19/10 (2006.01)		
	C07H 19/20 (2006.01)		
	A61F 2/24 (2006.01)	3592287	METHOD FOR GENERATING A MITRAL REPAIR RING, AND MITRAL REPAIR RING
	A61K 31/426 (2006.01)	3551626	BENZENESULFONAMIDE COMPOUNDS AND THEIR USE AS THERAPEUTIC AGENTS
A61P 25/08 (2006.01)			
CD Med S.r.l.			

Podnosilac evropske prijave patenta (71)	MKP (51)	Broj objave evropske prijave patenta (97)	Naziv pronalaska (54)
	C07D 213/76 (2006.01)		
	C07D 237/20 (2006.01)		
	C07D 239/69 (2006.01)		
	C07D 261/16 (2006.01)		
	C07D 277/52 (2006.01)		
	C07D 285/08 (2006.01)		
	C07D 403/12 (2006.01)		
	C07D 413/12 (2006.01)		
	C07D 493/10 (2006.01)		
	G06K 9/00 (2006.01)	3457314	BODY INFORMATION ANALYSIS APPARATUS AND METHOD OF DETECTING FACE SHAPE BY USING SAME
CAL-COMP BIG DATA, INC	G06T 7/00 (2017.01)	3454297	BODY INFORMATION ANALYSIS APPARATUS AND METHOD OF ANALYZING HAND SKIN USING SAME
Gradilis Recherche SARL	A01G 2/30 (2018.01)	3456178	NURSERY FRUIT TREE OF AT LEAST DOUBLE TRUNK TYPE
	G06F 21/33 (2013.01)	3461073	PLATFORM AND METHOD OF CERTIFICATION OF AN ELECTRONIC NOTICE FOR ELECTRONIC IDENTIFICATION AND TRUST SERVICES (EIDAS)
	G06Q 10/10 (2012.01)		
	H04L 12/58 (2006.01)		
	H04L 29/06 (2006.01)		
	H04W 4/14 (2009.01)		
	H04W 12/06 (2009.01)		
Lleidanetworks Serveis Telemàtics S.A.	G06F 21/33 (2013.01)	3461074	PLATFORM AND METHOD OF CERTIFICATION OF AN ELECTRONIC CONTRACT FOR ELECTRONIC IDENTIFICATION AND TRUST SERVICES (EIDAS)
	G06Q 10/10 (2012.01)		
	H04L 12/58 (2006.01)		
	H04L 29/06 (2006.01)		
	H04W 4/14 (2009.01)		
	H04W 12/06 (2009.01)		
Laboratorios Litaphar, S.L. Disproquima, S.A.	A61K 31/4164 (2006.01)	3498276	ECTOINE AND ECTOINE DERIVATIVES FOR USE IN VULVOVAGINAL CONDITIONS
	A61K 31/505 (2006.01)		
	A61P 15/02 (2006.01)		
Vianex S.A.	A61K 9/107 (2006.01)	3466409	SELF-EMULSIFYING COMPOSITIONS OF WEAKLY IONIZABLE OR NON-IONIZABLE ACTIVE PHARMACEUTICAL INGREDIENTS
	A61K 9/16 (2006.01)		
	A61K 9/20 (2006.01)		
	A61K 9/50 (2006.01)		
	A61K 31/192 (2006.01)		
	A61K 31/519 (2006.01)		
Argenti Italian Food S.r.l.	A23G 9/08 (2006.01)	3565418	COMPOSITION AND PROCESS FOR PRODUCING ARTISAN ICE CREAM FOR BATCH FREEZING
	A23G 9/40 (2006.01)		
	A23G 9/52 (2006.01)		
Tas, Sinan	A61K 47/00 (2006.01)	3570891	MEDICAMENTS AND USES IN TREATMENT OF CANCER AND OTHER PATHOLOGICAL CONDITIONS ASSOCIATED WITH AGING
	A61P 35/00 (2006.01)		
Nicox S.A.	C07C 291/02 (2006.01)	3530649	PROCESS FOR THE PREPARATION OF A NITRIC OXIDE DONATING PROSTAGLANDIN ANALOGUE

Podnosilac evropske prijave patenta (71)	MKP (51)	Broj objave evropske prijave patenta (97)	Naziv pronalaska (54)
	C07C 405/00 (2006.01)		
	G06K 9/00 (2006.01)	3457318	BODY INFORMATION ANALYSIS APPARATUS AND BLUSH ANALYSIS METHOD THEREOF
	A61K 31/33 (2006.01)	3456325	GAMMA-DIKETONES AS WNT/BETA-CATENIN SIGNALLING PATHWAY ACTIVATORS
	A61P 25/00 (2006.01)		
	C07D 213/50 (2006.01)		
	C07D 231/56 (2006.01)		
	C07D 235/06 (2006.01)		
	C07D 263/56 (2006.01)		
	C07D 307/80 (2006.01)		
	C07D 311/58 (2006.01)		
	C07D 317/54 (2006.01)		
	C07D 319/18 (2006.01)		
	C07D 327/06 (2006.01)		
	C07D 333/54 (2006.01)		
	C07D 339/08 (2006.01)		
	C07D 401/06 (2006.01)		
	C07D 405/06 (2006.01)		
	C07D 407/06 (2006.01)		
	C07D 409/06 (2006.01)		
	C07D 411/06 (2006.01)		
	C07D 413/06 (2006.01)		
	A61K 9/14 (2006.01)	3456318	SOLID COMPOSITIONS
	A61K 9/16 (2006.01)		
	A61K 9/20 (2006.01)		
	A61K 31/00 (2006.01)		
Kiniksa Pharmaceuticals, Ltd.	C07K 16/28 (2006.01)	3456743	ONCOSTATIN M RECEPTOR ANTIGEN BINDING PROTEINS
	A61K 31/506 (2006.01)	3453708	PROCESS FOR THE PREPARATION OF 5- CHLORO-N-(2-ISOPROPOXY-5-METHYL-4- PIPERIDIN-4-YL-PHENYL)-N-2- (ISOPROPYLSULFONYL)PHENYL)-2,4-DIAMINE DI-HYDROCHLORIDE
	A61P 35/00 (2006.01)		
	C07D 401/12 (2006.01)		
	C07K 14/00 (2006.01)	3461889	COMPOSITIONS FOR INCREASING POLYPEPTIDE STABILITY AND ACTIVITY, AND RELATED METHODS
	C07K 19/00 (2006.01)		
	C12N 9/00 (2006.01)		
	C12N 9/12 (2006.01)		
	C12N 9/96 (2006.01)		
	C07F 9/576 (2006.01)	3459958	PROCESS AND INTERMEDIATES FOR PREPARING PRODRUGS OF PYRIDONE AMIDES USEFUL AS MODULATORS OF SODIUM CHANNELS
	C07F 9/58 (2006.01)		
Messer Tatrugas spol. s. r.o.	A01K 29/00 (2006.01)	3449720	DEVICE FOR THE TREATMENT OF PET FOOD FOR CARNIVORES
	A01K 63/00 (2017.01)		

Podnositelj evropske prijave patenta (71)	MKP (51)	Broj objave evropske prijave patenta (97)	Naziv pronalaska (54)
	A22B 3/00 (2006.01)	3450819	METHOD FOR FILLING A MOBILE COOLANT TANK WITH A CRYOGENIC COOLANT
	A23B 4/06 (2006.01)		
	F17C 5/02 (2006.01)		
Allergan Holdings Unlimited Company	A61K 9/20 (2006.01)	3456321	OPIOID RECEPTOR MODULATOR DOSAGE FORMULATIONS
	A61K 9/28 (2006.01)		
	A61K 31/4174 (2006.01)		
CoNCERT Pharmaceuticals, Inc.	A61P 25/04 (2006.01)	3450434	DEUTERATED DERIVATIVES OF RUXOLITINIB
	A61K 31/519 (2006.01)		
	A61P 35/02 (2006.01)		
	C07B 59/00 (2006.01)	3456740	ANTI-IL-23 ANTIBODIES
	C07D 487/04 (2006.01)		
	C07K 16/24 (2006.01)		
	C07D 403/14 (2006.01)	3555087	MONOCYCLIC OGA INHIBITOR COMPOUNDS
	C07D 417/12 (2006.01)		
	C07D 417/14 (2006.01)		
	A61K 31/4427 (2006.01)	3555064	GLP-1 RECEPTOR AGONISTS AND USES THEREOF
	A61K 31/497 (2006.01)		
	A61P 3/00 (2006.01)		
	C07D 401/14 (2006.01)	3551225	ANTIBODIES AND METHODS OF USE THEREOF
	C07D 405/14 (2006.01)		
	C07D 413/14 (2006.01)		
C07D 471/04 (2006.01)	3558316	USE OF CHYMASE INHIBITORS FOR THE TREATMENT OF ENDOMETRIOSIS, POST- OPERATIVE FIBROSIS AND DISEASES WHICH ARE CHARACTERIZED BY FIBROSIS FORMATION	
C07D 487/04 (2006.01)			
A61K 39/395 (2006.01)			
C07K 16/28 (2006.01)	3555104	NRF2 COMPOUNDS	
A61K 31/513 (2006.01)			
A61P 15/00 (2006.01)			
A61K 31/5365 (2006.01)	3555088	BISARYL AMIDES AS NRF2 REGULATORS	
A61P 1/16 (2006.01)			
A61P 9/00 (2006.01)			
A61P 11/00 (2006.01)			
A61P 11/06 (2006.01)			
A61P 13/12 (2006.01)			
A61P 17/06 (2006.01)			
A61P 35/00 (2006.01)			
C07D 498/04 (2006.01)			
A61K 31/554 (2006.01)			
A61P 1/16 (2006.01)			
A61P 9/00 (2006.01)			

Podnosilac evropske prijave patenta (71)	MKP (51)	Broj objave evropske prijave patenta (97)	Naziv pronalaska (54)
Biogena (A.P.I) Ltd	A61P 11/00 (2006.01)		
	A61P 11/06 (2006.01)		
	A61P 13/12 (2006.01)		
	A61P 17/06 (2006.01)		
	A61P 35/00 (2006.01)		
	C07D 417/12 (2006.01)		
	C07D 417/14 (2006.01)		
	C07D 498/04 (2006.01)		
	A61K 39/00 (2006.01)	3551660	ANTI-CTLA-4 ANTIBODIES AND METHODS OF USE THEREOF
	C07K 16/28 (2006.01)		
	A61K 31/55 (2006.01)	3558948	NEW SALT OF IVABRADINE AND USES THEREOF
	A61P 9/10 (2006.01)		
	C07D 223/16 (2006.01)		
	A61K 31/551 (2006.01)	3555068	3-OXO-1,4-DIAZEPINYLE COMPOUNDS AS NRF2 ACTIVATORS
	A61P 9/04 (2006.01)		
	A61P 11/00 (2006.01)		
	C07D 403/10 (2006.01)		
	C07D 403/12 (2006.01)		
	A61K 31/553 (2006.01)	3555082	ETHER LINKED TRIAZOLES AS NRF2 REGULATORS
	A61K 31/554 (2006.01)		
A61P 9/04 (2006.01)			
A61P 11/00 (2006.01)			
C07D 249/04 (2006.01)			
C07D 413/12 (2006.01)			
C07D 419/12 (2006.01)			
C07D 419/14 (2006.01)			
C07D 471/04 (2006.01)			
C07D 498/04 (2006.01)			
Asceneuron S.A.	A61K 31/496 (2006.01)	3585779	SUBSTITUTED DIHYDROBENZOFURAN GLYCOSIDASE INHIBITORS
	A61K 31/497 (2006.01)		
	A61K 31/501 (2006.01)		
	A61K 31/506 (2006.01)		
	C07B 59/00 (2006.01)		
	C07D 401/12 (2006.01)		
	C07D 403/12 (2006.01)		
	C07D 405/12 (2006.01)		
	C07D 405/14		

Podnosilac evropske prijave patenta (71)	MKP (51)	Broj objave evropske prijave patenta (97)	Naziv pronalaska (54)
	(2006.01) C07D 407/12		
	(2006.01) C07D 413/12		
	(2006.01) C07D 417/12		
	(2006.01) C07D 417/14		
	(2006.01) C07D 471/04		
	(2006.01) C07D 475/04		
	(2006.01) C07D 487/04		
	(2006.01) C07D 495/04		
	(2006.01) C07D 498/04		
	(2006.01) C07D 513/04		
	(2006.01) C07D 401/12	3585783	SULFOXIMINE GLYCOSIDASE INHIBITORS
	(2006.01) C07D 405/12		
	(2006.01) C07D 413/12		
	(2006.01) C07D 417/12		
	(2006.01) C07D 417/14		
	(2006.01) C07D 495/04		
Cuetara, S.L	(2006.01) A21D 13/80	3566583	CHILDREN'S BISCUIT WITH NO ADDED SUGAR AND METHOD OF PREPARING IT
	(2017.01) A23L 5/40 (2016.01)		
	A23L 33/00 (2016.01)		
	A23L 33/21 (2016.01)		
	H02K 3/52 (2006.01)	3552303	STATOR OF AN ELECTRICAL MACHINE, ELECTRICAL MACHINE, AND ROUTING AND CONTACTING DEVICE FOR AN ELECTRICAL MACHINE
	A61K 31/165	3574898	SAFINAMIDE FOR THE TREATING MYOTONIA
	(2006.01) A61P 25/14		
	(2006.01) A61K 31/4045	3461821	INDOLE CARBOXAMIDE COMPOUNDS USEFUL AS KINASE INHIBITORS
	(2006.01) A61P 29/00		
	(2006.01) A61P 37/00		
	(2006.01) C07D 209/18		
	(2006.01) C07D 401/04		
	(2006.01) C07D 401/06		
	(2006.01) C07D 401/12		
	(2006.01) C07D 403/04		
	(2006.01) C07D 403/10		
	(2006.01) C07D 403/12		
	(2006.01) C07D 413/04		
	(2006.01) C07D 417/04		
	(2006.01)		

Podnosilac evropske prijave patenta (71)	MKP (51)	Broj objave evropske prijave patenta (97)	Naziv pronalaska (54)
	C07D 471/04 (2006.01)		
	C07D 487/04 (2006.01)		
	C07D 487/10 (2006.01)		
	C07K 16/28 (2006.01)	3466977	ANTI-VLA-4 ANTIBODIES
	C07D 207/06 (2006.01)	3461828	METHODS OF PREPARING TOLL-LIKE RECEPTOR MODULATORS
	C07D 239/46 (2006.01)		
	C07D 239/47 (2006.01)		
	C07D 239/48 (2006.01)		
	C07D 239/545 (2006.01)		
	C07D 487/04 (2006.01)		
MicroVascular Tissues, Inc.	A61L 27/36 (2006.01)	3476410	COMPOSITIONS AND METHODS FOR TREATING AND PREVENTING TISSUE INJURY AND DISEASE
	A61L 27/38 (2006.01)		
	A61L 27/54 (2006.01)		
	A61K 31/225 (2006.01)	3466420	DIMETHYL FUMARATE FOR THE TREATMENT OF FRIEDREICH ATAXIA
	A61P 25/14 (2006.01)		
	A61P 25/28 (2006.01)		
	A61K 31/7088 (2006.01)	3483273	CANCER TREATMENT
	A61P 35/00 (2006.01)		
	C07K 14/47 (2006.01)		
	C12N 15/113 (2010.01)		
	A61K 39/00 (2006.01)	3473648	HUMAN ANTIBODIES TO PD-L1
	A61K 39/395 (2006.01)		
	A61P 35/00 (2006.01)		
	C07K 16/22 (2006.01)		
	C07K 16/28 (2006.01)		
	C07K 16/30 (2006.01)		
Coexpair S.A.	B29C 31/04 (2006.01)	3486076	RESIN SUPPLY SYSTEM FOR RTM (RESIN- TRANSFER-MOLDING) AND RELATED METHOD
	B29C 70/48 (2006.01)		
	B29C 70/54 (2006.01)		
	C12Q 1/6804 (2018.01)	3495505	QUANTITATIVE ASSESSMENT FOR CAP EFFICIENCY OF MESSENGER RNA
IFE Aufbereitungstechnik GmbH	B03C 1/033 (2006.01)	3488932	SEPARATION OF COMPONENTS OF A MIXTURE CONTAINING METAL
	B03C 1/22 (2006.01)		
	B03C 1/23 (2006.01)		
	A61K 31/4375 (2006.01)	3466490	POLYCYCLIC-CARBAMOYLPIRIDONE COMPOUNDS AND THEIR PHARMACEUTICAL USE
	A61K 31/4985 (2006.01)		
	A61K 31/5365 (2006.01)		
	A61K 45/06 (2006.01)		
	A61P 31/18		

Podnosilac evropske prijave patenta (71)	MKP (51)	Broj objave evropske prijave patenta (97)	Naziv pronalaska (54)
	(2006.01) C07D 491/14 (2006.01) C07D 491/22 (2006.01) C07D 498/14 (2006.01) C07D 498/16 (2006.01) C07D 498/22 (2006.01) C07D 513/22 (2006.01) A61K 35/37 (2015.01) A61L 2/00 (2006.01) C07K 14/755 (2006.01)		
	A23B 5/005 (2006.01)	3495385	VIRAL INACTIVATION USING IMPROVED SOLVENT-DETERGENT METHOD
Fontana, Mauro Bisotti, Stefano Branciaroli, Osvaldo	A23B 5/01 (2006.01) A23L 3/005 (2006.01) A23L 15/00 (2016.01)	3491933	A METHOD OF MICROBIOLOGICAL SANITISATION OF THE SURFACE OF WHOLE EGGS IN SHELL
Vanderlande APC Inc.	G01V 5/00 (2006.01)	3483635	METHOD AND SYSTEM FOR USE IN PERFORMING SECURITY SCREENING
Concert Pharmaceuticals Inc.	A61K 31/519 (2006.01) A61P 17/06 (2006.01) A61P 19/02 (2006.01) C07B 59/00 (2006.01) C07D 471/04 (2006.01) C07D 487/04 (2006.01) C07D 498/16 (2006.01) C07D 498/18 (2006.01)	3492472	DEUTERATED BARICITINIB WITH IMPROVED METABOLIC STABILITY AS JAK1 AND JAK2 KINASE INHIBITOR FOR TREATING E.G. RHEUMATOID ARTHRITIS
	A61P 35/00 (2006.01) C12N 15/85 (2006.01) A61K 31/135 (2006.01) A61K 45/06 (2006.01) A61P 25/24 (2006.01)	3486248	IMPROVED METHODS FOR THE ACYLATION OF MAYTANSINOL
	A61K 9/00 (2006.01) A61K 9/08 (2006.01) A61K 31/496 (2006.01) A61K 47/10 (2017.01)	3489362	BIPARTITE AND TRIPARTITE SIGNALING IMMUNE CELLS
	A61K 31/437 (2006.01) A61K 31/4985 (2006.01) A61P 25/00 (2006.01) A61P 25/16 (2006.01) A61P 25/28 (2006.01) C07D 471/04 (2006.01)	3501542	ESKETAMINE FOR THE TREATMENT OF DEPRESSION
		3558379	PHARMACEUTICAL DOSAGE FORMS CONTAINING TASK-1 AND TASK-3 CHANNEL INHIBITORS, AND THE USE OF SAME IN BREATHING DISORDER THERAPY
		3558988	PYRAZOLO[3,4-B]PYRIDINES AND IMIDAZO[1,5- B]PYRIDAZINES AS PDE1 INHIBITORS

Podnositelj evropske prijave patenta (71)	MKP (51)	Broj objave evropske prijave patenta (97)	Naziv pronalaska (54)
Josef Schaidler Privatstiftung Gnosis S.p.A.	C07D 487/04 (2006.01)	3558951	METHOD FOR THE MANUFACTURING OF DELMOPINOL
	C07D 519/00 (2006.01)		
	A61K 31/5375 (2006.01)		
	C07C 21/00 (2006.01)		
	C07D 265/30 (2006.01)		
	B30B 11/20 (2006.01)		
	C07K 1/14 (2006.01)		
	C07K 7/08 (2006.01)		
	C07K 7/56 (2006.01)		
	G01R 15/26 (2006.01)		
G01R 29/08 (2006.01)			
C07K 14/47 (2006.01)			
C12N 15/10 (2006.01)			
C12N 15/63 (2006.01)			
C12N 15/864 (2006.01)			
A61K 9/08 (2006.01)			
A61K 31/496 (2006.01)			
A61K 47/10 (2017.01)			
E05F 11/38 (2006.01)	3558380	PHARMACEUTICAL DOSAGE FORMS CONTAINING TASK-1 AND TASK-3 CHANNEL INHIBITORS, AND THE USE OF SAME IN BREATHING DISORDER THERAPY	
E05F 11/48 (2006.01)			
C07C 21/04 (2006.01)			
C07C 21/17 (2006.01)			
C07D 265/30 (2006.01)			
A47K 3/28 (2006.01)			
E03C 1/04 (2006.01)			
E04H 1/12 (2006.01)			
E04H 9/02 (2006.01)			
A61K 31/5365 (2006.01)			3555389
A61P 35/00 (2006.01)			
C07D 498/04 (2006.01)			
A61K 31/5355 (2006.01)			
A61K 31/5377 (2006.01)			
A61P 25/28 (2006.01)			
C07D 265/08 (2006.01)			
C07D 265/12 (2006.01)			
C07D 265/30 (2006.01)			
C07D 413/10 (2006.01)			
A61K 31/541 (2006.01)	3555105	7-PHENYLETHYLAMINO-4H-PYRIMIDO[4,5- D][1,3]OXAZIN-2-ONE COMPOUNDS AS MUTANT IDH1 AND IDH2 INHIBITORS	
A61P 25/00 (2006.01)			
Brose Fahrzeugteile GmbH & Co. Kommanditgesellschaft, Bamberg	A61K 31/5375 (2006.01)	3555080	OXAZINE DERIVATIVES AS BETA-SECRETASE INHIBITORS AND METHODS OF USE
	C07D 498/04 (2006.01)		
	A61K 31/5377 (2006.01)		
	A61P 25/28 (2006.01)		
	C07D 265/08 (2006.01)		
	C07D 265/12 (2006.01)		
	C07D 265/30 (2006.01)		
	C07D 413/10 (2006.01)		
	A61K 31/541 (2006.01)		
	A61P 25/00 (2006.01)		
Borri, Sabina	A61K 31/5365 (2006.01)	3555084	THIAZINE DERIVATIVES AS BETA-SECRETASE INHIBITORS AND METHODS OF USE
	A61P 35/00 (2006.01)		
	C07D 498/04 (2006.01)		
	A61K 31/5355 (2006.01)		
	A61K 31/5377 (2006.01)		
	A61P 25/28 (2006.01)		
	C07D 265/08 (2006.01)		
	C07D 265/12 (2006.01)		
	C07D 265/30 (2006.01)		
	C07D 413/10 (2006.01)		

Podnositelj evropske prijave patenta (71)	MKP (51)	Broj objave evropske prijave patenta (97)	Naziv pronalaska (54)
	A61P 25/28 (2006.01)		
	C07D 417/10 (2006.01)		
	A61K 31/5365 (2006.01)	3555106	BICYCLIC THIAZINE AND OXAZINE DERIVATIVES AS BETA-SECRETASE INHIBITORS AND METHODS OF USE
	A61K 31/542 (2006.01)		
	A61P 25/00 (2006.01)		
	A61P 25/28 (2006.01)		
	C07D 498/04 (2006.01)		
	C07D 513/04 (2006.01)		
	A61K 31/5415 (2006.01)	3555085	CYCLOPROPYL FUSED THIAZINE DERIVATIVES AS BETA-SECRETASE INHIBITORS AND METHODS OF USE
	A61P 25/28 (2006.01)		
	C07D 279/08 (2006.01)		
	C07D 417/10 (2006.01)		
	C07D 417/14 (2006.01)		
	A61K 31/54 (2006.01)	3555086	1,4-THIAZINE DIOXIDE AND 1,2,4-THIADIAZINE DIOXIDE DERIVATIVES AS BETA-SECRETASE INHIBITORS AND METHODS OF USE
	A61P 25/28 (2006.01)		
	C07D 417/10 (2006.01)		
	C07D 417/14 (2006.01)		
	C07D 471/04 (2006.01)		
	C07D 491/056 (2006.01)		
	C07D 498/08 (2006.01)		
	C07D 513/04 (2006.01)		
	A61K 31/4184 (2006.01)	3555066	BENZIMIDAZOLE COMPOUNDS AS C-KIT INHIBITORS
	A61P 11/06 (2006.01)		
	A61P 35/00 (2006.01)		
	C07D 235/08 (2006.01)		
	C07D 401/12 (2006.01)		
	C07D 401/14 (2006.01)		
	C07D 403/04 (2006.01)		
Starklab	F24F 3/00 (2006.01)	3563094	FACILITY FOR PRODUCING AND TREATING A GAS STREAM THROUGH A VOLUME OF LIQUID
	F24F 3/14 (2006.01)		
	F24F 3/16 (2006.01)		
	F24F 5/00 (2006.01)		
	F24F 6/00 (2006.01)		
	F28C 3/06 (2006.01)		
Boehringer Ingelheim Animal Health USA Inc.	A61K 39/12 (2006.01)	3554536	RECOMBINANT HVT VECTORS EXPRESSING MULTIPLE ANTIGENS OF AVIAN PATHOGENS, AND VACCINES COMPRISING THEM
	A61K 39/155 (2006.01)		
	A61K 39/245 (2006.01)		
	A61K 39/295 (2006.01)		

Podnositelj evropske prijave patenta (71)	MKP (51)	Broj objave evropske prijave patenta (97)	Naziv pronalaska (54)					
Sapa S.P.A.	C07K 14/03 (2006.01)	3555129	GREMLIN-1 CRYSTAL STRUCTURE AND INHIBITORY ANTIBODY					
	C07K 14/08 (2006.01)							
	C12N 7/00 (2006.01)							
	A61K 39/395 (2006.01)							
	C07K 16/22 (2006.01)							
	B29C 45/17 (2006.01)			3558622	METHOD FOR THE INJECTION MOLDING OF INTERNALLY HOLLOW PARTS			
	C07K 14/725 (2006.01)			3551653	T CELL RECEPTORS WITH IMPROVED PAIRING			
	C12N 15/09 (2006.01)			3551654	NOVEL T CELL RECEPTORS AND IMMUNE THERAPY USING THE SAME			
	C07K 14/725 (2006.01)							
	C07K 16/30 (2006.01)							
	A61K 31/437 (2006.01)					3555094	BICYCLIC OGA INHIBITOR COMPOUNDS	
	A61P 25/00 (2006.01)					3558997	AMINO-TRIAZOLOPYRIDINE COMPOUNDS AND THEIR USE IN TREATING CANCER	
	C07D 471/04 (2006.01)							
	C07D 493/04 (2006.01)							
	A61K 31/522 (2006.01)							
	A61P 35/00 (2006.01)							
	C07D 473/18 (2006.01)							
C07D 519/00 (2006.01)								
C01F 11/18 (2006.01)	3573928	PROCESS FOR THE PREPARATION OF FRAGMENTED NATURAL CALCIUM CARBONATE WITH A REDUCED CONTENT OF IMPURITIES AND PRODUCTS OBTAINED THEREOF						
C09C 1/02 (2006.01)	3562519	PERFUME TESTERS SYSTEM FOR TRANSFORMING AN ORGANIC MATERIAL INTO SYNGAS						
A61L 9/12 (2006.01)								
C10J 3/26 (2006.01)			3551733					
C10J 3/30 (2006.01)			3555096					IMIDAZOPYRROLOPYRIDINE AS INHIBITORS OF THE JAK FAMILY OF KINASES
C10J 3/36 (2006.01)								
C10J 3/86 (2006.01)								
C10K 1/04 (2006.01)								
A61K 31/437 (2006.01)								
A61P 35/00 (2006.01)								
A61P 37/00 (2006.01)								
C07D 471/14 (2006.01)								
A61K 31/415 (2006.01)				3558960	CARBOXYLIC ACID AROMATIC AMIDES AS ANTAGONISTS OF BRADYKININ B1 RECEPTOR			
A61P 29/00 (2006.01)				3558960	CARBOXYLIC ACID AROMATIC AMIDES AS ANTAGONISTS OF BRADYKININ B1 RECEPTOR			
C07D 213/56 (2006.01)								
C07D 231/12 (2006.01)								
C07D 231/56 (2006.01)								
C07D 233/64 (2006.01)								
C07D 241/12 (2006.01)								
C07D 277/56 (2006.01)								
C07D 333/28								

Podnosilac evropske prijave patenta (71)	MKP (51)	Broj objave evropske prijave patenta (97)	Naziv pronalaska (54)	
The Queen's University Of Belfast	(2006.01) C07D 333/38 (2006.01) C07D 333/58 (2006.01) C07D 495/04 (2006.01) C07C 211/63	3555325	SEPARATION OF RARE EARTH METALS	
	(2006.01) C22B 3/26 (2006.01) C22B 59/00 (2006.01) A61K 31/455 (2006.01) A61P 11/00 (2006.01) C07D 231/20 (2006.01) C07D 401/04 (2006.01) C07D 401/14 (2006.01) A61K 47/64 (2017.01) A61P 21/00 (2006.01) C07C 201/08 (2006.01) C07C 205/06 (2006.01)			3551622
	C12Q 1/68 (2018.01)	3554552	EXON SKIPPING OLIGOMER CONJUGATES FOR MUSCULAR DYSTROPHY	
	University College Cork- National University of Ireland, Cork	C12Q 1/68 (2018.01)	3555039	METHOD AND SYSTEM FOR ADIABATIC NITRIDING OF AROMATES
		A61K 31/519 (2006.01) A61P 11/00 (2006.01) A61P 37/00 (2006.01) C07D 487/04 (2006.01) A23L 33/135 (2016.01) A61K 9/00 (2006.01) A61K 9/14 (2006.01) A61K 9/20 (2006.01) A61K 35/741 (2015.01) A61K 35/744 (2015.01) A61K 35/745 (2015.01) A61K 35/747 (2015.01) A61K 36/06 (2006.01) A61P 1/00 (2006.01) A61K 47/68 (2017.01) A61P 43/00 (2006.01) C07K 16/28 (2006.01) A61K 31/427 (2006.01) A61P 35/00 (2006.01) C07D 277/44 (2006.01) C07D 417/12	3555307	METHODS OF DETERMINING COLORECTAL CANCER STATUS IN AN INDIVIDUAL
		A61K 31/519 (2006.01) A61P 11/00 (2006.01) A61P 37/00 (2006.01) C07D 487/04 (2006.01) A23L 33/135 (2016.01) A61K 9/00 (2006.01) A61K 9/14 (2006.01) A61K 9/20 (2006.01) A61K 35/741 (2015.01) A61K 35/744 (2015.01) A61K 35/745 (2015.01) A61K 35/747 (2015.01) A61K 36/06 (2006.01) A61P 1/00 (2006.01) A61K 47/68 (2017.01) A61P 43/00 (2006.01) C07K 16/28 (2006.01) A61K 31/427 (2006.01) A61P 35/00 (2006.01) C07D 277/44 (2006.01) C07D 417/12	3558999	BICYCLIC DIHYDROPYRIMIDINE-CARBOXAMIDE DERIVATIVES AS RHO-KINASE INHIBITORS
		A61K 31/519 (2006.01) A61P 11/00 (2006.01) A61P 37/00 (2006.01) C07D 487/04 (2006.01) A23L 33/135 (2016.01) A61K 9/00 (2006.01) A61K 9/14 (2006.01) A61K 9/20 (2006.01) A61K 35/741 (2015.01) A61K 35/744 (2015.01) A61K 35/745 (2015.01) A61K 35/747 (2015.01) A61K 36/06 (2006.01) A61P 1/00 (2006.01) A61K 47/68 (2017.01) A61P 43/00 (2006.01) C07K 16/28 (2006.01) A61K 31/427 (2006.01) A61P 35/00 (2006.01) C07D 277/44 (2006.01) C07D 417/12	3554522	PROBIOTICS FOR USE IN THE TREATMENT OF DIVERTICULOSIS AND DIVERTICULAR DISEASE
		A61K 31/519 (2006.01) A61P 11/00 (2006.01) A61P 37/00 (2006.01) C07D 487/04 (2006.01) A23L 33/135 (2016.01) A61K 9/00 (2006.01) A61K 9/14 (2006.01) A61K 9/20 (2006.01) A61K 35/741 (2015.01) A61K 35/744 (2015.01) A61K 35/745 (2015.01) A61K 35/747 (2015.01) A61K 36/06 (2006.01) A61P 1/00 (2006.01) A61K 47/68 (2017.01) A61P 43/00 (2006.01) C07K 16/28 (2006.01) A61K 31/427 (2006.01) A61P 35/00 (2006.01) C07D 277/44 (2006.01) C07D 417/12	3558389	ANTIBODY DRUG CONJUGATES FOR ABLATING HEMATOPOIETIC STEM CELLS
		A61K 31/519 (2006.01) A61P 11/00 (2006.01) A61P 37/00 (2006.01) C07D 487/04 (2006.01) A23L 33/135 (2016.01) A61K 9/00 (2006.01) A61K 9/14 (2006.01) A61K 9/20 (2006.01) A61K 35/741 (2015.01) A61K 35/744 (2015.01) A61K 35/745 (2015.01) A61K 35/747 (2015.01) A61K 36/06 (2006.01) A61P 1/00 (2006.01) A61K 47/68 (2017.01) A61P 43/00 (2006.01) C07K 16/28 (2006.01) A61K 31/427 (2006.01) A61P 35/00 (2006.01) C07D 277/44 (2006.01) C07D 417/12	3555090	AMINOTHIAZOLE COMPOUNDS AS C-KIT INHIBITORS

Podnosilac evropske prijave patenta (71)	MKP (51)	Broj objave evropske prijave patenta (97)	Naziv pronalaska (54)
CoLucid Pharmaceuticals, Inc.	(2006.01) A23L 33/175 (2016.01) A23L 33/18 (2016.01) A61K 31/198 (2006.01) A61P 1/16 (2006.01) A61K 31/352 (2006.01) A61P 11/00 (2006.01) A61P 11/12 (2006.01) C07D 407/12 (2006.01) A61K 39/395 (2006.01) A61K 45/00 (2006.01) A61P 3/04 (2006.01) A61P 35/00 (2006.01) A61P 37/00 (2006.01) C07D 401/12 (2006.01) A61K 31/444 (2006.01) A61P 25/06 (2006.01) C07D 401/06 (2006.01) B32B 5/02 (2006.01) B32B 5/20 (2006.01) B32B 5/26 (2006.01) B32B 13/02 (2006.01) B32B 13/04 (2006.01) B32B 13/08 (2006.01) B32B 13/14 (2006.01) B32B 27/28 (2006.01) B32B 27/30 (2006.01) B32B 29/00 (2006.01) B32B 29/02 (2006.01) C04B 2/02 (2006.01) C04B 2/04 (2006.01) C04B 28/14 (2006.01) E04C 2/04 (2006.01) A61K 31/519 (2006.01) A61P 35/00 (2006.01) C07D 403/12 (2006.01) C07D 403/14 (2006.01) C07D 413/12 (2006.01) C07D 471/04 (2006.01) C07D 487/04 (2006.01)	3554492	AMINO ACID COMPOSITIONS AND METHODS FOR THE TREATMENT OF LIVER DISEASES
	3558982	DEUTERATED CFTR MODULATORS AND METHODS OF USE	
	3558361	MYOSTATIN, ACTIVIN OR ACTIVIN RECEPTOR ANTAGONISTS FOR USE IN TREATING OBESITY AND RELATED CONDITIONS	
	3558968	IMIDAZOPYRAZINE INHIBITORS OF BRUTON'S TYROSINE KINASE	
	3551617	COMPOSITIONS AND METHODS RELATED TO PYRIDINOYLPIPERIDINE 5-HT1F AGONISTS	
	3554822	PLASTER BOARDS AND METHODS FOR MAKING THEM	
	3555070	AMINE-SUBSTITUTED HETEROCYCLIC COMPOUNDS AS EHMT2 INHIBITORS AND METHODS OF USE THEREOF	

Podnosilac evropske prijave patenta (71)	MKP (51)	Broj objave evropske prijave patenta (97)	Naziv pronalaska (54)		
Idenix Pharmaceuticals LLC	C07D 491/04 (2006.01)	3559011	ANTIVIRAL ALIPHATIC ESTER PRODRUGS OF TENOFIVIR		
	C07D 491/14 (2006.01)				
	C07D 498/04 (2006.01)				
	A61K 31/675 (2006.01)				
	A61P 31/18 (2006.01)				
	C07F 9/6561 (2006.01)				
	A61K 31/437 (2006.01)			3558989	TRIAZOLO[1,5-A]PYRIDINE DERIVATIVES AS IMMUNOMODULATORS
	A61P 37/00 (2006.01)				
	C07D 471/04 (2006.01)				
	A61K 31/69 (2006.01)			3559009	COMPOSITIONS AND METHODS FOR INHIBITING ARGINASE ACTIVITY
	A61P 35/00 (2006.01)				
	C07F 5/02 (2006.01)			3551221	NOVEL T CELL RECEPTORS AND IMMUNE THERAPY USING THE SAME
	A61K 39/00 (2006.01)				
	C07K 14/47 (2006.01)				
C07K 14/725 (2006.01)					
A61K 31/407 (2006.01)	3559003	CRYSTALLINE FORMS OF A JANUS KINASE INHIBITOR			
A61K 31/519 (2006.01)					
A61P 17/06 (2006.01)					
A61P 17/14 (2006.01)					
C07D 487/10 (2006.01)	3551662	ANTI-TIM-3 ANTIBODIES FOR COMBINATION WITH ANTI-PD-1 ANTIBODIES			
A61K 39/00 (2006.01)					
A61P 35/00 (2006.01)					
C07K 16/28 (2006.01)	3558963	BICYCLIC HETEROAROMATIC COMPOUNDS AS IMMUNOMODULATORS			
A61K 31/4375 (2006.01)					
A61K 31/519 (2006.01)					
A61P 37/00 (2006.01)					
C07D 401/04 (2006.01)					
C07D 519/00 (2006.01)					
A61K 31/4035 (2006.01)			3558981	PYRAN DERIVATIVES AS CYP11A1 (CYTOCHROME P450 MONOOXYGENASE 11A1) INHIBITORS	
A61K 31/4155 (2006.01)					
A61K 31/4709 (2006.01)					
A61P 35/00 (2006.01)					
C07D 405/06 (2006.01)					
C07D 405/14 (2006.01)					
C07D 409/14 (2006.01)					
C07D 413/14					

Podnosilac evropske prijave patenta (71)	MKP (51)	Broj objave evropske prijave patenta (97)	Naziv pronalaska (54)
	(2006.01) C07D 417/04 (2006.01) C07D 471/04 (2006.01) C07D 471/08 (2006.01) C07D 487/04 (2006.01) C07D 487/10 (2006.01) C07D 513/04 (2006.01) A61K 31/352 (2006.01) A61K 31/47 (2006.01) C07D 217/04 (2006.01) C07D 217/08 (2006.01) C07D 223/16 (2006.01) C07D 311/76 (2006.01) C07D 498/14 (2006.01) A61K 31/517 (2006.01) A61P 35/00 (2006.01) C07D 239/74 (2006.01) C07D 401/08 (2006.01) C07D 401/14 (2006.01) C07D 403/08 (2006.01) C07D 405/10 (2006.01) C07D 417/08 (2006.01) C07D 487/04 (2006.01) A61K 31/437 (2006.01) A61P 29/00 (2006.01) C07D 471/14 (2006.01)	3562816	NRF2 ACTIVATOR
	(2006.01) A61K 31/517 (2006.01) A61P 35/00 (2006.01) C07D 239/74 (2006.01) C07D 401/08 (2006.01) C07D 401/14 (2006.01) C07D 403/08 (2006.01) C07D 405/10 (2006.01) C07D 417/08 (2006.01) C07D 487/04 (2006.01) A61K 31/437 (2006.01) A61P 29/00 (2006.01) C07D 471/14 (2006.01)	3562822	POLY-ADP RIBOSE POLYMERASE (PARP) INHIBITORS
	(2006.01) A61K 31/437 (2006.01) A61P 29/00 (2006.01) C07D 471/14 (2006.01)	3555097	SMALL MOLECULE INHIBITORS OF THE JAK FAMILY OF KINASES
KALIC, Samir	A47J 37/04 (2006.01) A47J 43/18 (2006.01)	3551019	WIRE-STICK WITH A RING FOR EASY REMOVAL OF GRILLED MEAT AND VEGETABLES KEBABS
	A61K 31/4365 (2006.01) C07D 495/04 (2006.01)	3558309	POSITIVE ALLOSTERIC MODULATORS OF THE MUSCARINIC ACETYLCHOLINE RECEPTOR M4
University of Louisville Research Foundation, Inc.	A61K 36/31 (2006.01)	3562496	COMPOSITIONS AND METHODS FOR TREATMENT OF INTESTINAL INFLAMMATION AND COLON CANCER
	A61K 35/76 (2015.01) A61K 38/43 (2006.01) C12N 7/00 (2006.01) C12N 15/86 (2006.01)	3551750	GENE THERAPY FOR MUCOPOLYSACCHARIDOSIS, TYPE I
	A61K 9/51 (2006.01) A61K 31/7105 (2006.01)	3551193	RESPIRATORY VIRUS NUCLEIC ACID VACCINES

Podnosilac evropske prijave patenta (71)	MKP (51)	Broj objave evropske prijave patenta (97)	Naziv pronalaska (54)		
HR System Hungary Zrt.	A61K 31/7115 (2006.01)	3551800	RAIL MOUNTING DEVICE AND METHOD FOR FIXING RAILS TO REINFORCED CONCRETE RAILWAY SLEEPER		
	A61P 31/14 (2006.01)				
	E01B 9/28 (2006.01)				
	E01B 9/30 (2006.01)				
	E01B 9/60 (2006.01)				
	E01B 13/02 (2006.01)				
	A61K 35/76 (2015.01)			3562937	GENE THERAPY FOR MUCOPOLYSACCHARIDOSIS, TYPE II
	A61K 38/43 (2006.01)				
	C12N 7/00 (2006.01)			3551149	BIODEGRADABLE SANITARY ARTICLES WITH HIGHER BIOBASED CONTENT
	C12N 15/86 (2006.01)				
	A61F 13/15 (2006.01)			3551215	METHOD FOR THE PREPARATION AND PROLONGED STORAGE OF GROWTH FACTORS AND CYTOKINES OBTAINED FROM PLATELET RICH PLASMA
	A61F 13/51 (2006.01)				
	A61F 13/511 (2006.01)				
	A61F 13/514 (2006.01)				
A61F 13/53 (2006.01)					
A61K 35/16 (2015.01)					
Avixgen Inc.	A61K 38/18 (2006.01)	3551667	BIVALENT ANTIBODIES MASKED BY COILED COILS		
	A61K 38/19 (2006.01)				
	A61K 38/20 (2006.01)				
	A61K 39/395 (2006.01)				
	C07K 16/18 (2006.01)				
	C07K 16/28 (2006.01)				
	C07K 16/46 (2006.01)				
	C07K 7/08 (2006.01)			3556766	CYTOPLASMIC TRANSDUCTION PEPTIDE AND INTRACELLULAR MESSENGER COMPRISING SAME
	C07K 14/005 (2006.01)				
	C07K 19/00 (2006.01)				
Bluefin Biomedicine, Inc.	A23K 50/10 (2016.01)	3554266	MULTI-DRUG ANTIBODY DRUG CONJUGATES		
	A61K 31/351 (2006.01)				
	A61K 38/00 (2006.01)				
	A61K 39/00 (2006.01)				
	A61K 39/395 (2006.01)			3554544	ANTI-CUB DOMAIN-CONTAINING PROTEIN 1 (CDCP1) ANTIBODIES, ANTIBODY DRUG CONJUGATES, AND METHODS OF USE THEREOF
	A61P 35/00 (2006.01)				
	C07K 16/18 (2006.01)				
B-Mogen Biotechnologies, Inc.	C07K 16/30 (2006.01)	3555273	ENHANCED hAT FAMILY TRANSPOSON- MEDIATED GENE TRANSFER AND ASSOCIATED COMPOSITIONS, SYSTEMS, AND METHODS		
	A61K 35/545 (2015.01)				
	C07K 14/705 (2006.01)				
	C12N 5/074 (2010.01)				
	C12N 9/12 (2006.01)			3558946	POSITIVE ALLOSTERIC MODULATORS OF THE MUSCARINIC ACETYLCHOLINE RECEPTOR M4
	C07D 215/12 (2006.01)				
	C07D 215/38				

Podnosilac evropske prijave patenta (71)	MKP (51)	Broj objave evropske prijave patenta (97)	Naziv pronalaska (54)
UNIVERSAL RESEARCH SOLUTIONS, LLC	A61K 31/415 (2006.01)	3562486	USE OF SUBLINGUAL DEXMEDETOMIDINE FOR THE TREATMENT OF AGITATION
	A61K 31/4174 (2006.01)		
	G06F 17/30 (2006.01)	3563379	DYNAMIC SEARCH AND RETRIEVAL OF QUESTIONS
	G16H 10/20 (2018.01)		
Tencent Technology (Shenzhen) Company Limited	G16H 15/00 (2018.01)		
	H04L 29/06 (2006.01) H04L 29/12 (2006.01)	3570512	DOMAIN NAME RESOLUTION METHOD, SERVER AND STORAGE MEDIUM
Rodriguez Barbero Moreno, Luis Miguel Serrano Vacas, Juan Carlos Monferrer Tena, Joan Antoni	A61K 39/395 (2006.01)	3573658	ANTI-TNF ANTIBODIES, COMPOSITIONS, AND METHODS FOR THE TREATMENT OF ACTIVE PSORIATIC ARTHRITIS
	C07K 14/525 (2006.01)		
	C07K 16/24 (2006.01)		
	A61K 31/7088 (2006.01)	3576751	RNA CANCER VACCINES
	A61K 31/7105 (2006.01)		
	A61K 39/00 (2006.01)		
	A61K 39/39 (2006.01)		
	A61P 35/00 (2006.01)		
	A61K 39/395 (2006.01)	3579871	ANTI-TNF ANTIBODIES, COMPOSITIONS, AND METHODS FOR THE TREATMENT OF ACTIVE ANKYLOSING SPONDYLITIS
	C07K 16/18 (2006.01)		
Samumed, LLC	C07K 16/24 (2006.01)		
	A21C 9/00 (2006.01) A21D 8/02 (2006.01)	3581030	METHOD FOR PREPARING FOODS BASED ON DOUGHS FROZEN IN PORTIONS AND MACHINE FOR PREPARING AND SELLING SAID FOODS
	A21D 8/06 (2006.01) A21D 10/02 (2006.01)		
	G07F 9/10 (2006.01) G07F 11/70 (2006.01)		
	G07F 17/00 (2006.01)		
	C07D 217/26 (2006.01)	3470397	CRYSTALLINE FORMS OF A PROLYL HYDROXYLASE INHIBITOR
	A61K 39/00 (2006.01)	3485902	METHODS FOR TREATING CHRONIC OBSTRUCTIVE PULMONARY DISEASE USING BENRALIZUMAB
	A61K 39/395 (2006.01)		
	A61P 11/00 (2006.01)		
	G01N 33/48 (2006.01)		
Samumed, LLC	A61B 17/34 (2006.01)	3459475	SURGICAL ACCESS DEVICES WITH SORBENTS
	G01N 33/533 (2006.01)	3467501	ASSAY FOR DETECTING TH1 AND TH2 CELL POPULATIONS
	A01N 43/56 (2006.01)	3473099	INDAZOLE-3-CARBOXAMIDES AND THEIR USE AS WNT/B-CATENIN SIGNALING PATHWAY INHIBITORS
	A61K 31/415 (2006.01)		
	A61K 45/06 (2006.01)		
	A61P 35/00 (2006.01)		
	C07D 401/04 (2006.01) C07D 401/10		

Podnosilac evropske prijave patenta (71)	MKP (51)	Broj objave evropske prijave patenta (97)	Naziv pronalaska (54)
	(2006.01) C07D 401/14 (2006.01) C07D 405/14 (2006.01) C07D 413/12 (2006.01)		
	A61K 9/20 (2006.01) A61K 31/443 (2006.01) A61K 31/47 (2006.01) A61K 45/06 (2006.01)	3470063	PHARMACEUTICAL COMPOSITIONS FOR THE TREATMENT OF CFTR MEDIATED DISEASES
	C12Q 1/68 (2018.01) G01N 33/52 (2006.01) G01N 33/53 (2006.01) G01N 33/543 (2006.01)	3467500	CO-BINDER ASSISTED ASSAY METHODS
	A61K 48/00 (2006.01) C07K 14/47 (2006.01) C12N 15/113 (2010.01) C12N 15/86 (2006.01)	3461838	RECOMBINANT ADENO-ASSOCIATED VIRUS DELIVERY OF EXON 2-TARGETED U7SNRNA POLYNUCLEOTIDE CONSTRUCTS
	A01N 37/34 (2006.01) A01N 37/40 (2006.01) A01N 41/10 (2006.01) A01N 43/40 (2006.01) A01N 47/36 (2006.01) A01P 13/00 (2006.01)	3437474	HERBICIDAL COMPOSITION
Atry Pharma, Inc.	A61P 11/00 (2006.01) A61P 21/00 (2006.01) A61P 29/00 (2006.01) A61P 37/00 (2006.01)	3460054	HISTIDYL-TRNA SYNTHETASE-FC CONJUGATES
	C12N 9/00 (2006.01) C12N 9/96 (2006.01) B01L 3/00 (2006.01) C12Q 1/68 (2018.01) G01N 33/52 (2006.01) G01N 33/543 (2006.01)	3450980	METHOD OF HOSTING A STABLE DROPLET PATTERN
	G01N 33/68 (2006.01)	3483611	INTACT MASS DETERMINATION OF PROTEIN CONJUGATED AGENT COMPOUNDS
ZS Pharma, Inc	A61K 9/14 (2006.01) A61K 33/00 (2006.01) A61K 33/24 (2019.01) A61K 45/06 (2006.01) B01J 19/00 (2006.01) B01J 19/18 (2006.01) B01J 39/02 (2006.01) B01J 39/14 (2006.01)	3470370	MICROPOROUS ZIRCONIUM SILICATE FOR THE TREATMENT OF HYPERKALEMIA

Podnosilac evropske prijave patenta (71)	MKP (51)	Broj objave evropske prijave patenta (97)	Naziv pronalaska (54)
	C01B 33/20 (2006.01)		
	C01B 39/02 (2006.01)		
	C01B 39/46 (2006.01)		
	C07F 7/02 (2006.01)		
	A61K 39/285 (2006.01)	3456349	OPTIMIZED EARLY-LATE PROMOTER COMBINED WITH REPEATED VACCINATION FAVORS CYTOTOXIC T CELL RESPONSE AGAINST RECOMBINANT ANTIGEN IN MVA VACCINES
	C07K 14/07 (2006.01)		
	C12N 15/863 (2006.01)		
	A61K 39/395 (2006.01)	3480202	CONJUGATION METHODS
	A61K 47/50 (2017.01)		
	A61K 51/00 (2006.01)		
	C07D 498/14 (2006.01)		
	A61K 31/4412 (2006.01)	3483143	PIPERIDINONE DERIVATIVES AS MDM2 INHIBITORS FOR THE TREATMENT OF CANCER
	A61P 35/00 (2006.01)		
	C07D 211/40 (2006.01)		
	C07D 279/02 (2006.01)		
	C07D 401/04 (2006.01)		
	C07D 401/06 (2006.01)		
	C07D 401/12 (2006.01)		
	C07D 407/04 (2006.01)		
	C07D 407/06 (2006.01)		
	C07D 409/04 (2006.01)		
	C07D 413/06 (2006.01)		
	C07D 417/06 (2006.01)		
	C07D 471/20 (2006.01)		
	C07D 498/08 (2006.01)		
	C07D 498/20 (2006.01)		
	A61K 39/00 (2006.01)	3485903	VEGF/DLL4 BINDING AGENTS AND USES THEREOF
	A61P 35/00 (2006.01)		
	C07K 16/00 (2006.01)		
	C12P 21/08 (2006.01)		
	A61F 13/00 (2006.01)	3461465	EXTENSIBLE DRESSINGS
Vueffe Studio SRL	A43B 1/04 (2006.01)	3470563	METHOD FOR PRODUCING A CRIMPED UPPER
	D04B 1/10 (2006.01)		
	D04B 1/22 (2006.01)		
	A61K 38/00 (2006.01)	3485901	EGFR AND C-MET-FIBRONECTIN TYPE III DOMAIN BINDING MOLECULES
	A61K 38/39 (2006.01)		
	A61K 39/395 (2006.01)		
	A61K 45/06		

Podnosilac evropske prijave patenta (71)	MKP (51)	Broj objave evropske prijave patenta (97)	Naziv pronalaska (54)
Unidata S.p.A.	(2006.01) A61P 35/00 (2006.01) C07K 14/78 (2006.01) C07K 16/28 (2006.01) H04B 1/69 (2011.01) H04J 13/18 (2011.01) H04L 5/00 (2006.01)	3468051	SYSTEM AND METHOD FOR OPTIMISING THE USE OF THE RADIO SPECTRUM AS A FUNCTION OF THE AIR TRANSMISSION TIMES
	A61K 31/444 (2006.01) A61K 31/497 (2006.01) A61P 25/28 (2006.01) C07D 401/12 (2006.01) A23D 7/00 (2006.01) A23L 9/20 (2016.01) A23L 33/115 (2016.01) C11C 3/10 (2006.01)	3461483	SOLID DOSAGE FORMS OF 2-AMINO-6-(DIFLUOROMETHYL)-5,5-DIFLUORO-6-PHENYL-3,4,5,6-TETRAHYDROPYRIDINE BACE1 INHIBITORS
	A61K 39/00 (2006.01) A61K 39/395 (2006.01) C07K 16/28 (2006.01) A61K 39/395 (2006.01) A61P 29/00 (2006.01) C07K 16/28 (2006.01) A61K 39/00 (2006.01) C12N 15/867 (2006.01) C07F 9/40 (2006.01) C07F 9/44 (2006.01) C07H 19/20 (2006.01)	3466278	IMITATION WHIPPING CREAM
	A61K 39/00 (2006.01) A61K 39/395 (2006.01) C07K 16/28 (2006.01) A61K 39/395 (2006.01) A61P 29/00 (2006.01) C07K 16/28 (2006.01) A61K 39/00 (2006.01) C12N 15/867 (2006.01) C07F 9/40 (2006.01) C07F 9/44 (2006.01) C07H 19/20 (2006.01)	3456346	PD-1 AND LAG-3 BINDING MOLECULES AND METHODS OF USE THEREOF
	A23L 29/00 (2016.01) A23L 33/10 (2016.01) A61K 9/16 (2006.01) A61K 31/122 (2006.01) A61K 31/70 (2006.01) C07D 317/26 (2006.01) C07H 21/04 (2006.01) C12N 15/11 (2006.01) A23C 9/152 (2006.01) A23L 33/135 (2016.01) A61K 9/19 (2006.01) A61K 31/00 (2006.01) A61K 35/74 (2015.01) A61K 39/00 (2006.01) A61K 39/08 (2006.01) A61P 11/06	3450458	HUMAN ANTIBODIES TO GFR 3 AND METHODS OF USE THEREOF
	A23L 29/00 (2016.01) A23L 33/10 (2016.01) A61K 9/16 (2006.01) A61K 31/122 (2006.01) A61K 31/70 (2006.01) C07D 317/26 (2006.01) C07H 21/04 (2006.01) C12N 15/11 (2006.01) A23C 9/152 (2006.01) A23L 33/135 (2016.01) A61K 9/19 (2006.01) A61K 31/00 (2006.01) A61K 35/74 (2015.01) A61K 39/00 (2006.01) A61K 39/08 (2006.01) A61P 11/06	3480316	LENTIVIRAL VECTOR PARTICLES HAVING IMPROVED TRANSDUCTION EFFICIENCY FOR CELLS EXPRESSING DC-SIGN
	A23L 29/00 (2016.01) A23L 33/10 (2016.01) A61K 9/16 (2006.01) A61K 31/122 (2006.01) A61K 31/70 (2006.01) C07D 317/26 (2006.01) C07H 21/04 (2006.01) C12N 15/11 (2006.01) A23C 9/152 (2006.01) A23L 33/135 (2016.01) A61K 9/19 (2006.01) A61K 31/00 (2006.01) A61K 35/74 (2015.01) A61K 39/00 (2006.01) A61K 39/08 (2006.01) A61P 11/06	3450438	PROCESSES AND INTERMEDIATES FOR PREPARING ANTI-HIV AGENTS
	A23L 29/00 (2016.01) A23L 33/10 (2016.01) A61K 9/16 (2006.01) A61K 31/122 (2006.01) A61K 31/70 (2006.01) C07D 317/26 (2006.01) C07H 21/04 (2006.01) C12N 15/11 (2006.01) A23C 9/152 (2006.01) A23L 33/135 (2016.01) A61K 9/19 (2006.01) A61K 31/00 (2006.01) A61K 35/74 (2015.01) A61K 39/00 (2006.01) A61K 39/08 (2006.01) A61P 11/06	3476388	COMPOSITION COMPRISING COENZYME Q10 AND PIPERINE
	A23L 29/00 (2016.01) A23L 33/10 (2016.01) A61K 9/16 (2006.01) A61K 31/122 (2006.01) A61K 31/70 (2006.01) C07D 317/26 (2006.01) C07H 21/04 (2006.01) C12N 15/11 (2006.01) A23C 9/152 (2006.01) A23L 33/135 (2016.01) A61K 9/19 (2006.01) A61K 31/00 (2006.01) A61K 35/74 (2015.01) A61K 39/00 (2006.01) A61K 39/08 (2006.01) A61P 11/06	3466431	CRYSTALLINE FORMS AND METHODS FOR PREPARING SGLT2 INHIBITORS
	A23L 29/00 (2016.01) A23L 33/10 (2016.01) A61K 9/16 (2006.01) A61K 31/122 (2006.01) A61K 31/70 (2006.01) C07D 317/26 (2006.01) C07H 21/04 (2006.01) C12N 15/11 (2006.01) A23C 9/152 (2006.01) A23L 33/135 (2016.01) A61K 9/19 (2006.01) A61K 31/00 (2006.01) A61K 35/74 (2015.01) A61K 39/00 (2006.01) A61K 39/08 (2006.01) A61P 11/06	3466960	MODULATION OF SIGNAL TRANSDUCER AND ACTIVATOR OF TRANSCRIPTION 3 (STAT3) EXPRESSION
	A23L 29/00 (2016.01) A23L 33/10 (2016.01) A61K 9/16 (2006.01) A61K 31/122 (2006.01) A61K 31/70 (2006.01) C07D 317/26 (2006.01) C07H 21/04 (2006.01) C12N 15/11 (2006.01) A23C 9/152 (2006.01) A23L 33/135 (2016.01) A61K 9/19 (2006.01) A61K 31/00 (2006.01) A61K 35/74 (2015.01) A61K 39/00 (2006.01) A61K 39/08 (2006.01) A61P 11/06	3456386	COMPOSITIONS COMPRISING BACTERIAL STRAINS

Podnosilac evropske prijave patenta (71)	MKP (51)	Broj objave evropske prijave patenta (97)	Naziv pronalaska (54)
Karyopharm Therapeutics Inc.	(2006.01) A61P 19/00 (2006.01) A61P 27/02 (2006.01) A61P 29/00 (2006.01) A61K 31/497 (2006.01) A61P 35/00 (2006.01) C07D 249/08 (2006.01) C07D 401/06 (2006.01) C07D 403/06 (2006.01) C07D 405/06 (2006.01) C07D 413/06 (2006.01) C07D 417/06 (2006.01) A01K 67/027 (2006.01) C07K 16/00 (2006.01) C07K 16/18 (2006.01) C07K 16/46 (2006.01) C12N 15/10 (2006.01) C12N 15/85 (2006.01) A61K 31/4985 (2006.01) A61P 19/08 (2006.01) A61P 29/00 (2006.01) A61P 31/00 (2006.01) A61P 35/00 (2006.01) A61P 37/00 (2006.01) C07D 487/04 (2006.01) C07D 519/00 (2006.01) A61P 21/00 (2006.01) C07H 21/04 (2006.01) C07K 16/00 (2006.01) C12P 21/08 (2006.01) C07D 209/08 (2006.01) C07D 403/12 (2006.01) C07D 498/04 (2006.01) C07D 401/14 (2006.01) C07D 487/04 (2006.01) C07F 5/04 (2006.01)	3492455	1,2,4-TRIAZOLES AS NUCLEAR TRANSPORT MODULATORS AND USE IN THE TREATMENT OF SPECIFIC FORMS OF CANCER
	3456832	MICE EXPRESSING AN IMMUNOGLOBULIN HYBRID LIGHT CHAIN	
	3495368	(S)-4-(8-AMINO-3-(1-(BUT-2-YNOYL)PYRROLIDIN- 2-YL)IMIDAZO[1,5-A]PYRAZIN-1-YL)-2-METHOXY- N-(PYRIDIN-2-YL)BENZAMIDE AS BTK-INHIBITOR	
	3498857	DUAL RECEPTOR ANTAGONISTIC ANTIGEN- BINDING PROTEINS AND USES THEREOF	
	3492474	INTERMEDIATES USED IN THE PRODUCTION OF DIACYLGLYCEROL ACYLTRANSFERASE INHIBITORS	
	3489239	PROCESSES AND INTERMEDIATES FOR MAKING A JAK INHIBITOR	

Podnosilac evropske prijave patenta (71)	MKP (51)	Broj objave evropske prijave patenta (97)	Naziv pronalaska (54)
	A61B 17/072 (2006.01)	3479780	MULTI-LAYER TISSUE THICKNESS COMPENSATOR COMPRISING RESILIENT AND SACRIFICIAL COLLAPSIBLE LAYERS
	A61K 31/4545 (2006.01)	3473619	AURORA A KINASE INHIBITOR
	A61P 35/00 (2006.01)		
	C07D 401/14 (2006.01)		
NextLeaf Solutions Ltd.	B01D 11/02 (2006.01)	3482808	CLOSED-LOOP MULTI-STAGE CHILLED FILTER SYSTEM
	B01D 11/04 (2006.01)		
	B01D 24/00 (2006.01)		
	B01D 29/56 (2006.01)		
	B01D 35/18 (2006.01)		
Rivacold S.R.L.	F25B 9/00 (2006.01)	3483529	LUBRICANT MONITORING SYSTEM FOR A CIRCUIT COMPRESSOR
	F25B 31/00 (2006.01)		
	F25B 49/00 (2006.01)		
	C12N 15/10 (2006.01)	3467108	METHODS FOR PURIFICATION OF MESSENGER RNA
	A47C 1/032 (2006.01)	3476254	SEATING FURNITURE, IN PARTICULAR AN OFFICE CHAIR
	A47C 7/02 (2006.01)		
Joint Stock Company Railway Research Institute	C09D 5/33 (2006.01)	3555218	COATING REFLECTING SOLAR RADIATION, AND USE THEREOF
	C09D 133/02 (2006.01)		
	C09D 201/00 (2006.01)		
	E01B 19/00 (2006.01)		
	A61K 39/395 (2006.01)	3558364	MONOCLONAL ANTI-ALPHA-SYNUCLEIN ANTIBODIES FOR PREVENTING TAU AGGREGATION
	A61P 25/28 (2006.01)		
	C07K 16/18 (2006.01)		
	A61K 31/427 (2006.01)	3558987	COMBINATION THERAPY WITH AMIDINE SUBSTITUTED β -LACTAM COMPOUNDS AND β - LACTAMASE INHIBITORS FOR INFECTIONS WITH ANTIBIOTIC RESISTANT BACTERIAL STRAINS
	A61P 31/04 (2006.01)		
	C07D 417/12 (2006.01)		
	A61K 39/00 (2006.01)	3559037	SIRP-GAMMA TARGETED AGENTS FOR USE IN THE TREATMENT OF CANCER
	C07K 16/28 (2006.01)		
	A61K 38/10 (2006.01)	3558337	METHODS OF TREATING IRRITABLE BOWEL SYNDROME WITH MODIFIED OR DELAYED RELEASE FORMULATIONS OF LINACLOTIDE
	A61K 47/32 (2006.01)		
	A61P 1/10 (2006.01)		
Axcella Health Inc.	A23L 33/175 (2016.01)	3554493	AMINO ACID COMPOSITIONS AND METHODS FOR THE TREATMENT OF MUSCLE DISEASES AND DISORDERS
	A23L 33/18 (2016.01)		
	A61K 31/198 (2006.01)		
	A61P 21/00 (2006.01)		
	A61P 21/06 (2006.01)		
	A61K 39/00 (2006.01)	3558365	ANTI-NEUROPIILIN ANTIGEN-BINDING PROTEINS AND METHODS OF USE THEREOF
	A61K 39/395 (2006.01)		
	A61P 35/00 (2006.01)		

Podnosilac evropske prijave patenta (71)	MKP (51)	Broj objave evropske prijave patenta (97)	Naziv pronalaska (54)
	C07K 16/28 (2006.01)		
	G01N 33/53 (2006.01)		
	A61K 47/68 (2017.01)	3558391	IMMUNOCONJUGATES TARGETING ADAM9 AND METHODS OF USE THEREOF
	A61P 35/00 (2006.01)		
	C07K 16/28 (2006.01)		
	C07K 16/30 (2006.01)		
	C07K 16/40 (2006.01)		
	A61P 37/00 (2006.01)	3551664	ANTIBODIES AND POLYPEPTIDES DIRECTED AGAINST CD127
	C07K 16/28 (2006.01)		
	A61P 25/16 (2006.01)	3555127	AGENTS, USES AND METHODS
	C07K 16/18 (2006.01)		
	A61K 31/437 (2006.01)	3558990	TETRAHYDRO IMIDAZO[4,5-C]PYRIDINE DERIVATIVES AS PD-L1 INTERNALIZATION INDUCERS
	A61P 35/00 (2006.01)		
	A61P 37/00 (2006.01)		
	C07D 471/04 (2006.01)		
Nopixglobal AG	A01M 29/28 (2011.01)	3550965	METHOD AND DEVICE FOR INFLUENCING INSECTS
Modunex Bio Corp.	A61K 31/4178 (2006.01)	3562490	COMBINATION THERAPY FOR NONALCOHOLIC STEATOHEPATITIS (NASH) AND LIVER FIBROSIS
	A61K 31/4375 (2006.01)		
	A61K 31/46 (2006.01)		
	A61K 31/506 (2006.01)		
	A61K 31/575 (2006.01)		
	A61P 1/16 (2006.01)		
	A61P 11/00 (2006.01)		
	A61P 13/12 (2006.01)		
	C07D 265/30 (2006.01)	3558953	METHOD FOR THE MANUFACTURING OF 2-(3-(ALKYL AND ALKENYL)MORPHOLINO)-ETHAN-1-OLS
	C07D 498/04 (2006.01)		
Tekath, Anneliese	A41D 13/05 (2006.01)	3562344	UNDERGARMENT
	A61K 35/26 (2015.01)	3514172	CLAUDIN-6-SPECIFIC IMMUNORECEPTORS AND T CELL EPITOPES
	A61P 35/00 (2006.01)		
	C07K 14/47 (2006.01)		
	C07K 14/725 (2006.01)		
Nicox Ophthalmics, Inc.	A61K 31/58 (2006.01)	3517541	POLYMORPHIC FORM OF FLUTICASONE PROPIONATE
	A61P 5/44 (2006.01)		
	C07J 31/00 (2006.01)		
	C07J 71/00 (2006.01)		
Helen of Troy, Limited	A61B 1/00 (2006.01)	3539448	METHOD FOR IDENTIFYING OBJECTS IN A SUBJECT'S EAR
	A61B 1/05 (2006.01)		
	A61B 1/227 (2006.01)		

Podnosilac evropske prijave patenta (71)	MKP (51)	Broj objave evropske prijave patenta (97)	Naziv pronalaska (54)
The Challenge Printing Company	B65B 25/14 (2006.01) B65B 35/36 (2006.01) B65B 35/50 (2006.01) B65B 43/26 (2006.01) B65G 61/00 (2006.01)	3530576	TRAY FILLING APPARATUS FOR LEAFLETS
Hettegger, Rupert	B62D 55/28 (2006.01) A61K 39/00 (2006.01) A61P 35/00 (2006.01) C07K 16/28 (2006.01) A61K 39/00 (2006.01) A61P 35/00 (2006.01) C07K 16/28 (2006.01) A61K 31/713 (2006.01) C12N 9/64 (2006.01) C12N 15/113 (2010.01) A61K 31/506 (2006.01) A61P 31/16 (2006.01) C07D 403/04 (2006.01) C07D 471/04 (2006.01) A61J 1/10 (2006.01) A61J 1/14 (2006.01) A61J 1/20 (2006.01) A61J 1/22 (2006.01) A61K 38/17 (2006.01) A61K 39/00 (2006.01) C07K 7/06 (2006.01) C07K 7/08 (2006.01) C07K 14/47 (2006.01) A61K 51/04 (2006.01) A61K 39/00 (2006.01) C07K 16/28 (2006.01) C07K 16/32 (2006.01) E06B 3/66 (2006.01) E06B 3/663 (2006.01) E06B 3/667 (2006.01) E06B 3/67 (2006.01) E06B 3/677 (2006.01) A61K 38/04 (2006.01) A61P 35/00	3552931 3552665 3552665 3587578 3578554 3545935 3539979 3533473 3539988 3567200 3545965	CLIMBING AID ANTIBODIES ANTIBODIES TMPRSS6 IRNA COMPOSITIONS AND METHODS OF USE THEREOF INHIBITORS OF INFLUENZA VIRUSES REPLICATION STERILE FLEXIBLE PACKAGE WITH PRESSURE COMPENSATOR FOR THE DOSED RECONSTITUTION OF FLUID MEDICINAL OR NUTRITIONAL SUBSTANCES TO BE ADMINISTERED TO PATIENTS BY INFUSION OR INJECTION PERSONALIZED IMMUNOTHERAPY AGAINST SEVERAL NEURONAL AND BRAIN TUMORS COMPOUNDS FOR POSITRON EMISSION TOMOGRAPHY MONOCLONAL ANTIBODIES AGAINST HER2 PRESSURE COMPENSATED GLASS UNIT NOVEL PEPTIDES AND COMBINATION OF PEPTIDES FOR USE IN IMMUNOTHERAPY AGAINST HEPATOCELLULAR CARCINOMA (HCC)

Podnosilac evropske prijave patenta (71)	MKP (51)	Broj objave evropske prijave patenta (97)	Naziv pronalaska (54)
	(2006.01)		AND OTHER CANCERS
	C07K 7/00 (2006.01)		
	C07K 7/06 (2006.01)		
	C07K 7/08 (2006.01)		
	B28B 7/36 (2006.01)	3536867	METHOD FOR PRODUCING A MOULDED ARTICLE
	E03F 5/02 (2006.01)		
	C12N 15/67 (2006.01)	3578659	ARTIFICIAL NUCLEIC ACID MOLECULES FOR IMPROVED PROTEIN OR PEPTIDE EXPRESSION
	A61K 38/17 (2006.01)	3578196	NOVEL IMMUNOTHERAPY AGAINST SEVERAL TUMORS, SUCH AS LUNG CANCER, INCLUDING NSCLC
	A61K 39/00 (2006.01)		
	C07K 7/06 (2006.01)		
	C07K 7/08 (2006.01)		
	C12N 5/0783 (2010.01)		
	C12N 9/64 (2006.01)		
	C12N 5/0735 (2010.01)	3578988	METHOD OF NOCICEPTOR DIFFERENTIATION OF HUMAN EMBRYONIC STEM CELLS AND USES THEREOF
	C12Q 1/68 (2018.01)		
	G01N 33/15 (2006.01)		
	G01N 33/68 (2006.01)		
	A61K 39/00 (2006.01)	3574916	COMPOSITION AND VACCINE FOR TREATING LUNG CANCER
	A61P 35/00 (2006.01)		
	A61K 39/395 (2006.01)	3572093	FGFR FUSIONS
	C07K 14/435 (2006.01)		
	A61K 39/395 (2006.01)	3572093	FGFR FUSIONS
	C07K 14/435 (2006.01)		
	A61K 31/13 (2006.01)	3583940	THERAPEUTIC AGENTS FOR NEURODEGENERATIVE DISEASES
	A61P 25/28 (2006.01)		
	A61K 39/12 (2006.01)	3566714	INFLUENZA VIRUS VACCINES AND USES THEREOF
	C07K 14/005 (2006.01)		
	A61K 31/415 (2006.01)	3556752	N-((HET)ARYLMETHYL)-HETEROARYL- CARBOXAMIDES COMPOUNDS AS PLASMA KALLIKREIN INHIBITORS
	A61K 31/454 (2006.01)		
	A61K 31/4709 (2006.01)		
	A61K 31/497 (2006.01)		
	A61K 31/506 (2006.01)		
	C07D 231/14 (2006.01)		
	C07D 401/06 (2006.01)		
	C07D 401/10 (2006.01)		
	C07D 401/14 (2006.01)		
	C07D 403/10 (2006.01)		
	C07D 409/14 (2006.01)		
	C07D 413/14 (2006.01)		
	C07K 16/12 (2006.01)	3594232	METHODS AND MEANS FOR THE PRODUCTION OF IG-LIKE MOLECULES

Podnosilac evropske prijave patenta (71)	MKP (51)	Broj objave evropske prijave patenta (97)	Naziv pronalaska (54)
Centre National de la Recherche Scientifique	C07K 16/26 (2006.01)		
	C07K 16/36 (2006.01)		
	C07K 16/46 (2006.01)		
	C01B 32/20 (2017.01)	3578512	GRAPHITE PRODUCTION FROM BIOMASS
	C01B 32/205 (2017.01)		
	C07K 16/12 (2006.01)	3594233	METHODS AND MEANS FOR THE PRODUCTION OF IG-LIKE MOLECULES
	C07K 16/26 (2006.01)		
	C07K 16/36 (2006.01)		
	C07K 16/46 (2006.01)		
	A61K 31/7088 (2006.01)	3564380	RECOMBINANT ADENOVIRUSES AND USE THEREOF
	A61K 35/76 (2015.01)		
	C12N 7/01 (2006.01)		
	C12N 15/861 (2006.01)		
	A61K 39/00 (2006.01)	3564378	IMMUNOGENIC COMPOSITION
	A61K 39/08 (2006.01)		
	C07K 14/33 (2006.01)		
	C07K 16/12 (2006.01)		
	C12N 15/62 (2006.01)		
	C12N 15/70 (2006.01)		
	C04B 28/14 (2006.01)	3564199	CONSTRUCTION PANEL HAVING IMPROVED FIXING STRENGTH AND METHOD FOR THE MANUFACTURE THEREOF
	C04B 111/00 (2006.01)		
	A61K 39/00 (2006.01)	3572432	ICOS BINDING PROTEINS
	A61P 31/00 (2006.01)		
	A61P 35/00 (2006.01)		
	A61P 37/00 (2006.01)		
	C07K 16/28 (2006.01)		
	A61K 39/00 (2006.01)	3575324	ICOS BINDING PROTEINS
	A61P 31/00 (2006.01)		
	A61P 35/00 (2006.01)		
	A61P 37/00 (2006.01)		
	C07K 16/28 (2006.01)		
	A61K 31/415 (2006.01)	3567037	N-((HET)ARYLMETHYL)-HETEROARYL- CARBOXAMIDES COMPOUNDS AS PLASMA KALLIKREIN INHIBITORS
	A61K 31/454 (2006.01)		
A61K 31/4709 (2006.01)			
A61K 31/497 (2006.01)			
A61K 31/506			

Podnosilac evropske prijave patenta (71)	MKP (51)	Broj objave evropske prijave patenta (97)	Naziv pronalaska (54)
	(2006.01) C07D 231/14 (2006.01) C07D 401/06 (2006.01) C07D 401/10 (2006.01) C07D 401/14 (2006.01) C07D 403/10 (2006.01) C07D 409/14 (2006.01) C07D 413/14 (2006.01) F16L 41/08 (2006.01)	3567293	SYSTEM FOR COOLING A FLOW OR FOR EXTRACTING HEAT OUT OF A FLOW THROUGH A PIPELINE AND/OR FOR EXTRACTING HEAT OUT OF A SURROUNDING OF A PIPELINE AND A METHOD FOR PROVIDING SUCH A SYSTEM
	A61K 9/00 (2006.01) A61K 9/08 (2006.01) A61K 31/5575 (2006.01) A61K 47/14 (2017.01) A61P 27/06 (2006.01)	3593788	OPHTHALMIC COMPOSITIONS CONTAINING A NITRIC OXIDE RELEASING PROSTAMIDE
Hermanns, Matthias	G06Q 20/32 (2012.01) G06Q 20/38 (2012.01) G06Q 20/42 (2012.01) C07K 14/16 (2006.01)	3594881	PROCEDURE TO EFFECT AUTHENTICATED PAYMENTS WITH A MOBILE DEVICE OF THE PURCHASER
The University of Queensland	C07D 231/18 (2006.01)	3578547	HUMAN IMMUNODEFICIENCY VIRUS ANTIGENS, VECTORS, COMPOSITIONS, AND METHODS OF USE THEREOF
	A61K 31/422 (2006.01) A61K 31/4439 (2006.01) A61P 1/16 (2006.01) A61P 3/04 (2006.01) A61P 3/10 (2006.01) A61P 29/00 (2006.01) A61P 35/00 (2006.01) C07D 401/14 (2006.01) C07D 413/12 (2006.01) C07D 413/14 (2006.01)	3587412	SULFONYLUREAS AND RELATED COMPOUNDS AND USE OF SAME FXR (NR1H4) MODULATING COMPOUNDS
Daiichi Sankyo Company, Limited	A61K 31/437 (2006.01) A61P 35/00 (2006.01) C07D 471/04 (2006.01)	3581573	SYNTHESIS OF A COMPOUND THAT MODULATES KINASES
MUSC Foundation for Research Development	A61B 17/17 (2006.01) A61B 17/56 (2006.01) A61B 17/88 (2006.01) A61B 17/90 (2006.01)	3573548	APPARATUS AND METHODS WITH SURGICAL GUIDES HAVING ROUTED LIQUID COOLANT IRRIGATION

Podnosilac evropske prijave patenta (71)	MKP (51)	Broj objave evropske prijave patenta (97)	Naziv pronalaska (54)				
University of Tennessee Research Foundation	A61C 3/04 (2006.01)	3592825	GARNET SCINTILLATOR CO-DOPED WITH MONOVALENT ION				
	A61C 8/00 (2006.01)						
	C09K 11/08 (2006.01)						
	C09K 11/77 (2006.01)						
	C09K 11/80 (2006.01)						
Kobayashi, Takaitu	G01T 1/00 (2006.01)	3587752	WORKING MEDIUM CHARACTERISTIC DIFFERENCE POWER GENERATION SYSTEM AND WORKING MEDIUM CHARACTERISTIC DIFFERENCE POWER GENERATION METHOD IN WHICH SAID POWER GENERATION SYSTEM IS USED				
	G01T 1/02 (2006.01)						
	G01T 1/20 (2006.01)						
	F01K 25/10 (2006.01)						
	H02K 7/18 (2006.01)						
The National Institutes Of Pharmaceutical Research	H02K 35/02 (2006.01)	3556761	PYRROLO-AROMATIC HETEROCYCLIC COMPOUND, PREPARATION METHOD THEREFOR, AND MEDICAL USE THEREOF				
	A61K 31/53 (2006.01)						
	A61P 35/00 (2006.01)	3592357	METHODS OF TREATING CANCER				
	C07D 487/04 (2006.01)						
	A61K 31/133 (2006.01)						
	A61K 31/56 (2006.01)						
	A61K 31/575 (2006.01)						
	C07J 5/00 (2006.01)						
	C07J 9/00 (2006.01)						
	C07J 31/00 (2006.01)						
	A61K 31/337 (2006.01)			3577110	ATAZANAVIR (ATV) ANALOGUES FOR TREATING HIV INFECTIONS		
	A61K 31/4155 (2006.01)						
	A61K 31/495 (2006.01)						
	A61K 31/504 (2006.01)						
	A61K 31/506 (2006.01)						
	A61K 31/5365 (2006.01)						
	C07C 243/28 (2006.01)						
	C07C 275/16 (2006.01)						
	C07D 401/12 (2006.01)						
	C07D 403/12 (2006.01)						
	C07D 405/14 (2006.01)						
	C07D 471/08 (2006.01)						
	C07D 487/08 (2006.01)						
	C07D 487/10 (2006.01)						
	C07D 491/04 (2006.01)						
	A61L 17/00 (2006.01)					3579889	BRAIDED SUTURE WITH FILAMENT CONTAINING A MEDICANT
	A61L 17/10 (2006.01)						
	A61L 17/14 (2006.01)						
	A61K 39/00 (2006.01)					3580238	RADIOLABELED ANTI-LAG3 ANTIBODIES FOR IMMUNO-PET IMAGING
A61K 51/10 (2006.01)							
C07C 259/00							

Podnosilac evropske prijave patenta (71)	MKP (51)	Broj objave evropske prijave patenta (97)	Naziv pronalaska (54)
	(2006.01) C07K 16/28 (2006.01) C07D 209/10 (2006.01) C07D 401/12 (2006.01) C07D 403/12 (2006.01) C07D 405/12 (2006.01) A61K 39/395 (2006.01) C07K 16/28 (2006.01) C12Q 1/6886 (2018.01)	3585780	ARYL HYDROCARBON RECEPTOR (AHR) MODULATOR COMPOUNDS
Sogest	B24B 3/54 (2006.01) A61K 31/44 (2006.01) A61P 35/00 (2006.01) C07D 213/71 (2006.01) C07D 401/12 (2006.01) C07D 405/12 (2006.01)	3576907 3580203	LOW PH PHARMACEUTICAL COMPOSITION COMPRISING T CELL ENGAGING ANTIBODY CONSTRUCTS SHARPENING DEVICE HYDROCARBYLSULFONYL-SUBSTITUTED PYRIDINES AND THEIR USE IN THE TREATMENT OF CANCER
Colibri' System S.p.A.	B42C 7/00 (2006.01) B42C 15/00 (2006.01) A61K 31/437 (2006.01) A61P 35/00 (2006.01) C07D 471/04 (2006.01) A61P 37/06 (2006.01) C07K 16/28 (2006.01) A61K 38/09 (2006.01) A61K 45/06 (2006.01) A61P 35/00 (2006.01) A61K 39/395 (2006.01) A61K 47/68 (2017.01) C07K 16/28 (2006.01) A61D 1/02 (2006.01) A61D 7/00 (2006.01) A61J 1/06 (2006.01)	3573840 3577115 3583128	AUTOMATIC MACHINE AND METHOD FOR COVERING THE COVERS OF BOOKS ARYL HYDROCARBON RECEPTOR (AHR) MODULATOR COMPOUNDS NEW USES OF ANTI-SIRPG ANTIBODIES
Antev Limited	A61K 38/09 (2006.01) A61K 45/06 (2006.01) A61P 35/00 (2006.01) A61K 39/395 (2006.01) A61K 47/68 (2017.01) C07K 16/28 (2006.01) A61D 1/02 (2006.01) A61D 7/00 (2006.01) A61J 1/06 (2006.01) A61K 47/60 (2017.01) A61P 35/00 (2006.01) C08G 69/10 (2006.01) C08G 69/40 (2006.01) C08G 83/00 (2006.01)	3573663 3577139 3579787 3585441	A composition comprising at least one GNRH antagonist ANTI-CCR7 ANTIBODY DRUG CONJUGATES LIQUID APPLICATOR FOR DELIVERING VACCINES THERAPEUTIC DENDRIMERS
Janssen Sciences Ireland Unlimited Company	A61K 31/437 (2006.01) A61K 31/438	3589323	COMBINATION THERAPY

Podnosilac evropske prijave patenta (71)	MKP (51)	Broj objave evropske prijave patenta (97)	Naziv pronalaska (54)
	(2006.01) A61K 31/4545		
	(2006.01) A61K 31/47		
	(2006.01) A61K 31/4965		
	(2006.01) A61K 31/498		
	(2006.01) A61K 45/06		
	(2006.01) A61P 31/06		
	(2006.01) A61K 38/00	3589954	PEPTIDE VACCINES
	(2006.01) G01N 33/569		
	(2006.01) A61K 39/00	3589310	PERSONALISED IMMUNOGENIC PEPTIDE IDENTIFICATION PLATFORM
	(2006.01) A61K 39/12		
	(2006.01) G01N 33/50		
	(2006.01) G01N 33/569		
	(2006.01) A61K 31/444	3582775	ANTI-INFLAMMATORY COMPOSITIONS COMPRISING IRAK AND JAK INHIBITORS
	(2006.01) A61K 31/541		
	(2006.01) A61K 45/06		
	(2006.01) A61P 29/00		
	(2006.01) A61P 35/00		
	(2006.01) A61P 37/00		
	(2006.01) A61P 37/06		
	(2006.01) A61P 37/08		
	(2006.01) A61P 43/00		
	(2006.01) A61K 38/22	3580232	MODIFIED RELAXIN POLYPEPTIDES COMPRISING A PHARMACOKINETIC ENHANCER AND USES THEREOF
	(2006.01) C07K 14/64		
	(2006.01) A61K 38/40	3583120	ENGINEERED TRANSFERRIN RECEPTOR BINDING POLYPEPTIDES
	(2006.01) A61K 39/00		
	(2006.01) C07K 14/705		
	(2006.01) C07K 14/79		
	(2006.01) A61K 31/7084	3582853	CYCLIC DI-NUCLEOTIDES COMPOUNDS FOR THE TREATMENT OF CANCER
	(2006.01) A61P 31/04		
	(2006.01) A61P 37/04		
	(2006.01) C07F 9/6527		
	(2006.01) C07F 9/6574		
	(2006.01) C07H 19/213		
	(2006.01) A61K 31/713	3577223	COMPOSITIONS AND METHODS FOR THE TREATMENT OF HEMOGLOBINOPATHIES
Intellia Therapeutics, Inc.	(2006.01) A61P 7/00 (2006.01)		

Podnosilac evropske prijave patenta (71)	MKP (51)	Broj objave evropske prijave patenta (97)	Naziv pronalaska (54)
	C12N 15/113 (2010.01)		
	A61K 31/519 (2006.01)	3585790	[1,2,4]-TRIAZOLO [1,5-A]-PYRIMIDINYL DERIVATIVES SUBSTITUTED WITH PIPERIDINE, MORPHOLINE OR PIPERAZINE AS OGA INHIBITORS
	A61P 25/28 (2006.01)		
	C07D 487/04 (2006.01)		
	C07D 519/00 (2006.01)		
	A61K 31/4184 (2006.01)	3585772	1, 4, 6-TRISUBSTITUTED-2-ALKYL-1H- BENZO[D]IMIDAZOLE DERIVATIVES AS DIHYDROOROTATE OXYGENASE INHIBITORS
	C07D 235/08 (2006.01)		
	C07D 401/10 (2006.01)		
	C07D 403/10 (2006.01)		
	C07D 413/10 (2006.01)		
	C07D 417/10 (2006.01)		
	C12Q 1/48 (2006.01)	3585904	USE OF BIOMARKERS IN IDENTIFYING CANCER PATIENTS THAT WILL BE RESPONSIVE TO TREATMENT WITH A PRMT5 INHIBITOR
	C12Q 1/68 (2018.01)		
	G01N 33/574 (2006.01)		
Denali Therapeutics Inc.	A61P 25/28 (2006.01)	3583123	ANTI-TAU ANTIBODIES AND METHODS OF USE THEREOF
	C07K 16/18 (2006.01)		
	A61M 5/315 (2006.01)	3589340	DOSE DETECTION AND DRUG IDENTIFICATION FOR A MEDICATION DELIVERY DEVICE
	A61K 31/185 (2006.01)	3585373	METHODS FOR TREATING NEURODEGENERATIVE DISORDERS
	A61K 31/381 (2006.01)		
	A61K 31/404 (2006.01)		
	A61K 31/415 (2006.01)		
	A61K 31/4152 (2006.01)		
	A61K 31/4168 (2006.01)		
	A61K 31/4184 (2006.01)		
	A61K 31/4196 (2006.01)		
	A61K 31/42 (2006.01)		
	A61K 31/423 (2006.01)		
	A61K 31/426 (2006.01)		
	A61K 31/428 (2006.01)		
	A61K 31/433 (2006.01)		
	A61K 31/44 (2006.01)		
	A61K 31/4425 (2006.01)		
	A61K 31/505 (2006.01)		
	A61K 31/52 (2006.01)		
	A61K 31/53 (2006.01)		
	A61K 31/536 (2006.01)		

Podnosilac evropske prijave patenta (71)	MKP (51)	Broj objave evropske prijave patenta (97)	Naziv pronalaska (54)						
Zentrum für Forschungsförderung in der Pädiatrie GmbH	A61K 31/5377 (2006.01)	3589329	CONCEPT FOR THE TREATMENT OF MONOGENETIC DISORDERS						
	A61P 25/28 (2006.01)								
	A61K 48/00 (2006.01)								
	C07K 14/745 (2006.01)								
	C07K 14/755 (2006.01)								
	C12N 15/85 (2006.01)								
Novideas S.r.l.	C12N 15/88 (2006.01)	3580183	DEVICE FOR SEWAGE TREATMENT						
	B01F 3/04 (2006.01)								
	C02F 3/20 (2006.01)								
Exelixis, Inc.	C02F 3/22 (2006.01)	3570840	COMBINATIONS OF CABOZANTINIB AND ATEZOLIZUMAB TO TREAT CANCER						
	A61K 9/00 (2006.01)								
	A61K 31/47 (2006.01)								
	A61K 45/06 (2006.01)								
	A61P 35/00 (2006.01)								
	A61P 35/04 (2006.01)								
	A61K 38/19 (2006.01)			3589308	THERAPEUTIC RNA				
	A61K 38/20 (2006.01)								
	A61K 38/21 (2006.01)								
	C07K 14/535 (2006.01)								
	C07K 14/54 (2006.01)								
	C07K 14/56 (2006.01)								
	C12N 15/67 (2006.01)								
	A61K 39/00 (2006.01)					3571226	BONE-TARGETING ANTIBODIES		
	A61P 19/08 (2006.01)								
	C07K 16/22 (2006.01)								
	A61K 31/4152 (2006.01)							3592732	MANUFACTURE OF A CRYSTALLINE PHARMACEUTICAL PRODUCT
	A61P 35/00 (2006.01)								
	C07D 231/14 (2006.01)								
B29C 45/16 (2006.01)	3585583	MULTI-STEP METHOD FOR PRODUCING A SOUNDPROOF COMPOSITE COVER FOR INTERNAL COMBUSTION ENGINES AND PRODUCT THUS OBTAINED							
B29C 45/17 (2006.01)									
B29K 23/00 (2006.01)									
B29K 75/00 (2006.01)									
B29K 77/00 (2006.01)									
B29K 105/04 (2006.01)									
G10K 11/00 (2006.01)									
B29C 45/16 (2006.01)			3585584	MULTI-STEP METHOD FOR PRODUCING A COMPOSITE COMPONENT FOR VEHICLES AND PRODUCT THUS OBTAINED					
B29C 45/17 (2006.01)									
B29C 45/17 (2006.01)									

Podnosilac evropske prijave patenta (71)	MKP (51)	Broj objave evropske prijave patenta (97)	Naziv pronalaska (54)
Thomas Jefferson University	B29C 45/26 (2006.01)		
	B29K 23/00 (2006.01)		
	B29K 75/00 (2006.01)		
	B29K 77/00 (2006.01)		
	B29K 105/04 (2006.01)		
	B60R 13/08 (2006.01)		
	F02B 77/11 (2006.01)		
	G10K 11/00 (2006.01)		
	A01N 43/72 (2006.01)	3579696	IN VIVO MODEL FOR PARASITIC WORM INFECTION AND METHODS FOR EVALUATING ANTIPARASITIC COMPOUNDS, INCLUDING COMPOUNDS ACTIVE AGAINST CANINE HEARTWORM
	A01N 43/90 (2006.01)		
	A01N 47/18 (2006.01)		
	A01P 5/00 (2006.01)		
	A61K 31/7084 (2006.01)	3582854	CYCLIC DI-NUCLEOTIDES DERIVATIVE FOR THE TREATMENT OF CANCER
	A61P 31/04 (2006.01)		
	A61P 37/04 (2006.01)		
	C07F 9/6527 (2006.01)		
	C07F 9/6536 (2006.01)		
	C07F 9/6574 (2006.01)		
	C07H 19/213 (2006.01)		
	A61K 31/357 (2006.01)	3582804	PHARMACEUTICAL COMBINATIONS FOR TREATING CANCER
	A61K 39/00 (2006.01)		
	A61P 35/00 (2006.01)		
	A61K 31/542 (2006.01)	3592750	INHIBITORS OF BETA SECRETASE
	A61P 25/28 (2006.01)		
	C07D 498/04 (2006.01)		
	C07D 513/04 (2006.01)		
	A61K 31/542 (2006.01)	3592751	INHIBITORS OF BETA SECRETASE
A61P 25/28 (2006.01)			
C07D 513/04 (2006.01)			
A61K 31/542 (2006.01)	3592752	INHIBITORS OF BETA SECRETASE	
A61P 25/28 (2006.01)			
C07D 513/04 (2006.01)			
A61K 31/426 (2006.01)	3592734	AMINE SALT OF (1R,3S)-3-(5-CYANO-4-PHENYL- 1,3-THIAZOL-2-YLCARBAMOYL)CYCLOPENTANE CARBOXYLIC ACID	
A61P 9/00 (2006.01)			
C07D 277/56 (2006.01)			
A22C 17/00 (2006.01)	3582620	CUTTING DEVICE WITH MONOLITHIC STRUCTURE	
B02C 18/36			

Podnosilac evropske prijave patenta (71)	MKP (51)	Broj objave evropske prijave patenta (97)	Naziv pronalaska (54)
	(2006.01) C25B 1/06 (2006.01) C25B 9/06 (2006.01) C25B 15/02 (2006.01) C25B 15/08 (2006.01)	3585926	ELECTROLYSIS HEATING SYSTEM
	A61K 39/395 (2006.01) A61K 47/18 (2017.01) C07K 16/40 (2006.01)	3585821	LOW-VISCOSITY, HIGH-CONCENTRATION EVOLOCUMAB FORMULATIONS AND METHODS OF MAKING THE SAME
	A61K 47/65 (2017.01) A61K 47/68 (2017.01) A61P 35/00 (2006.01)	3589328	MAYTANSINOID DERIVATIVES WITH SELF- IMMOLATIVE PEPTIDE LINKERS AND CONJUGATES THEREOF
Juno Therapeutics, Inc.	A61K 35/17 (2015.01)	3585402	COMPOSITIONS, ARTICLES OF MANUFACTURE AND METHODS RELATED TO DOSING IN CELL THERAPY
Treos Bio Zrt.	A61K 39/00 (2006.01) G01N 33/50 (2006.01) G01N 33/569 (2006.01)	3589951	POPULATION-BASED IMMUNOGENIC PEPTIDE IDENTIFICATION PLATFORM
Universiteit van Amsterdam	A61K 38/10 (2006.01) A61K 45/06 (2006.01) C12Q 1/6886 (2018.01)	3589305	SPECIFIC INCREASE OF DOPAMINE SYNTHESIS THROUGH TARGETING OF THE GUANYLATE CYCLASE 2C RECEPTOR IN THE TREATMENT OF PARKINSON'S DISEASE
	B61K 7/04 (2006.01) F16D 65/00 (2006.01) F16D 65/04 (2006.01)	3558786	A METHYLATION CLASSIFIER FOR DETECTION OF HPV-INDUCED INVASIVE CANCERS, NONHPV- INDUCED GYNAECOLOGICAL AND ANOGENITAL CANCERS AND THEIR HIGH- GRADE PRECURSOR LESIONS
	A61K 9/20 (2006.01) A61K 31/404 (2006.01) A61K 45/06 (2006.01) A61P 1/00 (2006.01) A61P 1/04 (2006.01) A61P 17/00 (2006.01) A61P 17/02 (2006.01) A61P 37/00 (2006.01)	3582814	LAMELLA OF RAIL ELEMENT, PREFERABLY RAIL BRAKE AND METHOD OF ITS USE
	A61K 9/127 (2006.01) A61K 38/17 (2006.01) C07K 14/47 (2006.01) C12N 15/10 (2006.01)	3585417	COMPOUNDS AND METHODS FOR TREATMENT OF INFLAMMATORY BOWEL DISEASE WITH EXTRA-INTESTINAL MANIFESTATIONS
	A61K 9/16 (2006.01) A61K 9/20 (2006.01) A61K 9/28 (2006.01) A61K 9/48 (2006.01) A61K 31/27 (2006.01)	3589274	NOVEL CODON-OPTIMIZED CFTR MRNA
	A61K 9/107 (2006.01) A61K 38/10	3573600	COMPOSITIONS COMPRISING PGI2-RECEPTOR AGONISTS AND PROCESSES FOR THE PREPARATION THEREOF
			METHOD FOR MANUFACTURING A STABLE EMULSION FOR PEPTIDE DELIVERY

Podnosilac evropske prijave patenta (71)	MKP (51)	Broj objave evropske prijave patenta (97)	Naziv pronalaska (54)	
Berlin-Chemie AG	(2006.01) A61K 38/17	3592774	PHARMACEUTICAL COMBINATIONS COMPRISING AN ANTI-LY75 ANTIBODY	
	(2006.01) A61K 31/505			
	(2006.01) A61K 39/395			
	(2006.01) A61K 47/68			
	(2017.01) A61P 35/00			
	(2006.01) A61P 35/02			
	(2006.01) C07K 16/28			
ANDE Corporation	(2006.01) C07K 16/46	3583230	SYSTEMS AND PROCESSES FOR RAPID NUCLEIC ACID EXTRACTION, PURIFICATION, AND ANALYSIS	
	(2006.01) C12N 15/10			
	(2018.01) C12Q 1/6806			
	(2018.01) C12N 15/10			
Actelion Pharmaceuticals Ltd	(2006.01) A61K 35/76	3585891	METHODS FOR PURIFICATION OF MESSENGER RNA	
	(2015.01) A61K 48/00	3589730	ADENO-ASSOCIATED VIRUS (AAV) CLADE F VECTOR AND USES THEREFOR	
	(2006.01) C12N 7/00 (2006.01)	3592391	PHARMACEUTICAL COMPOSITION COMPRISING SELEXIPAG	
	(2006.01) A61K 9/19 (2006.01)			
	(2006.01) A61K 31/4965			
	(2017.01) A61K 47/10	3585367	CINEOLE-CONTAINING COMPOSITION FOR TREATING NASAL DISEASES	
	(2006.01) A61P 9/12 (2006.01)			
	(2006.01) A61P 17/02			
	(2006.01) A61K 31/045			
	Almac Discovery Limited	(2006.01) A61K 36/185	3571227	ANTI-TGF-BETA ANTIBODIES AND THEIR USE
(2006.01) A61P 11/00				
(2006.01) A61P 35/00				
(2006.01) C07K 16/22		3571700	METHOD AND SYSTEM FOR PREDICTING REFRACTORY EPILEPSY STATUS	
(2006.01) C07K 16/28				
(2006.01) G16H 50/20				
(2018.01) G16H 50/30				
Almac Discovery Limited		(2018.01) G16H 50/70	3568412	T CELL RECEPTORS THAT BIND TO NY-ESO-1 AND METHODS OF USE THEREOF
		(2018.01) A61K 39/00		
		(2006.01) C07K 14/725		
	(2006.01) C07K 16/30			
	(2006.01) C12N 5/16 (2006.01)			
	(2006.01) A61K 31/519			
	(2006.01) A61P 35/00			
Almac Discovery Limited	(2006.01) C07D 487/04	3592745	PYRIMIDOPYRIMIDINONES USEFUL AS WEE-1 KINASE INHIBITORS	
	(2006.01) C07H 1/06 (2006.01)	3585892	METHODS FOR PURIFICATION OF MESSENGER RNA	
	(2006.01) C12N 15/10			

Podnosilac evropske prijave patenta (71)	MKP (51)	Broj objave evropske prijave patenta (97)	Naziv pronalaska (54)
	C12P 19/34 (2006.01)		
	A61K 31/397 (2006.01)	3592742	JAK INHIBITORS CONTAINING A 4-MEMBERED HETEROCYCLIC AMIDE
	A61K 31/437 (2006.01)		
	A61P 11/00 (2006.01)		
	C07D 471/04 (2006.01)		
	A61K 31/415 (2006.01)	3589618	PYRAZOLE DERIVATIVES AS BROMODOMAIN INHIBITORS
	A61K 31/4155 (2006.01)		
	C07D 231/14 (2006.01)		
	C07D 401/12 (2006.01)		
	C07D 401/14 (2006.01)		
	C07D 403/12 (2006.01)		
	C07D 403/14 (2006.01)		
	C07D 405/12 (2006.01)		
	C07D 405/14 (2006.01)		
	C07D 413/12 (2006.01)		
	C07D 417/12 (2006.01)		
	C07D 471/04 (2006.01)		
	C07K 16/10 (2006.01)	3592769	ANTIBODIES AGAINST PD-L1
	C07K 16/28 (2006.01)		
	A61K 31/437 (2006.01)	3592743	FUSED IMIDAZO-PIPERIDINE JAK INHIBITORS
	A61P 11/00 (2006.01)		
	C07D 471/04 (2006.01)		
	A61K 9/127 (2006.01)	3592728	POLYANIONIC DELIVERY OF NUCLEIC ACIDS
	A61K 47/20 (2006.01)		
	A61K 47/54 (2017.01)		
	C07C 305/06 (2006.01)		
	C07C 317/18 (2006.01)		
	C08G 65/00 (2006.01)		
Sato Holdings Kabushiki Kaisha	G01N 35/00 (2006.01)	3593403	CONTAINER LABELS
	G06K 19/077 (2006.01)		
	H01Q 1/22 (2006.01)		
	H01Q 7/00 (2006.01)		
	C12N 15/864 (2006.01)	3589739	COMPOSITIONS USEFUL IN TREATMENT OF SPINAL MUSCULAR ATROPHY
	C12N 9/12 (2006.01)	3585886	LARGE SCALE SYNTHESIS OF MESSENGER RNA
	C12P 19/34 (2006.01)		
	A61K 39/395 (2006.01)	3570885	METHOD OF TREATING OR AMELIORATING METABOLIC DISORDERS USING GLP-1 RECEPTOR AGONISTS CONJUGATED TO
	A61P 3/10 (2006.01)		

Podnosilac evropske prijave patenta (71)	MKP (51)	Broj objave evropske prijave patenta (97)	Naziv pronalaska (54)
Varian Medical Systems International AG Varian Medical Systems Inc	C07K 16/28 (2006.01)	3585482	ANTAGONISTS FOR GASTRIC INHIBITORY PEPTIDE RECEPTOR (GIPR) RADIATION TREATMENT PLANNING AND DELIVERY USING COLLISION FREE REGIONS
	A61N 5/10 (2006.01)		
	A61K 31/404 (2006.01)		
Berta, Zsolt Zoltán Tóth, Béla Ern	A61K 31/575 (2006.01)	3571321	HYDROXYSTEROID 17-BETA DEHYDROGENASE 13 (HSD17B13) VARIANTS AND USES THEREOF
	A61P 1/16 (2006.01)		
	C12Q 1/6883 (2018.01)		
	A61H 33/00 (2006.01)		
Equoclima Srl	A61H 33/14 (2006.01)	3593075	WALL-MOUNTED RADIANT COOLING DEVICE
	A61H 35/00 (2006.01)		
	F28D 1/04 (2006.01)		
	F28F 1/16 (2006.01)		
	A61K 31/444 (2006.01)		
	A61P 11/06 (2006.01)		
	A61P 13/12 (2006.01)		
	A61P 17/06 (2006.01)		
	A61P 19/02 (2006.01)		
	A61P 27/02 (2006.01)		
	A61P 29/00 (2006.01)		
	A61P 35/00 (2006.01)		
	C07D 417/14 (2006.01)		
	A63C 19/00 (2006.01)		
A63C 19/08 (2006.01)			
Globál Sport KFT.	G01R 1/04 (2006.01)	3568707	ENCLOSURE ASSEMBLY AND METERING APPARATUS COMPRISING SAME
	G01R 11/04 (2006.01)		
	G01R 11/24 (2006.01)		
	G01R 22/06 (2006.01)		
Landis+Gyr AG	C08G 8/22 (2006.01)	3589668	NOVOLAC RESINS AND USE IN RUBBER COMPOSITIONS
	C08L 21/00 (2006.01)		
	C08L 61/12 (2006.01)		
	C08L 61/14 (2006.01)		
	C08L 77/00 (2006.01)		
Sumitomo Chemical Advanced Technologies LLC	C09J 161/14 (2006.01)	3585166	GUIDING DEVICE FOR FISHING RODS
	A01K 87/04 (2006.01)		
Val Mar S.r.l.	A41D 13/06 (2006.01)	3582645	INSOLE AND ITS PROCESS OF MANUFACTURING
	A43B 3/10 (2006.01)		
Juno Therapeutics GmbH	A61K 39/00 (2006.01)	3571221	CELL SURFACE CONJUGATES AND RELATED CELL COMPOSITIONS AND METHODS
	C07K 14/47 (2006.01)		
	C07K 14/705 (2006.01)		
	C12N 5/0783 (2010.01)		
	C23C 2/00 (2006.01)		
		3592878	HOT-DIP GALVANIZING METHOD AND

Podnosilac evropske prijave patenta (71)	MKP (51)	Broj objave evropske prijave patenta (97)	Naziv pronalaska (54)
Rempex Pharmaceuticals, Inc.	C23C 2/02 (2006.01)	3566055	CARRYING AND/OR HOLDING MEANS FOR THE HOT-DIP GALVANIZING
	C23C 2/04 (2006.01)		
	C23C 2/06 (2006.01)		
	C23C 2/26 (2006.01)		
	C25D 17/06 (2006.01)		
	C25D 17/08 (2006.01)		
	F16B 45/00 (2006.01)		
	A61K 31/454 (2006.01)		
	C07D 413/14 (2006.01)		
	C07D 417/14 (2006.01)		
	G01N 33/68 (2006.01)		
	A61K 31/407 (2006.01)		
	A61K 31/69 (2006.01)		
	A61P 13/02 (2006.01)		
A61P 13/12 (2006.01)			
A61P 31/04 (2006.01)	3565551	METHODS OF TREATING BACTERIAL INFECTIONS	
A61K 31/65 (2006.01)			
A61K 38/12 (2006.01)			
A61P 31/04 (2006.01)			
A61K 31/58 (2006.01)			
A61K 31/69 (2006.01)			
A61K 39/395 (2006.01)			
C07J 43/00 (2006.01)			
C07K 16/28 (2006.01)			
C12Q 1/68 (2018.01)			
E01F 9/30 (2016.01)			
E01F 15/02 (2006.01)			
G08B 1/08 (2006.01)			
A61N 5/00 (2006.01)			3582786
C07K 16/18 (2006.01)			
C12N 1/15 (2006.01)			
C12N 1/19 (2006.01)			
C12N 1/21 (2006.01)			
C12N 5/10 (2006.01)			
C12N 15/09 (2006.01)			
C12P 21/08 (2006.01)			
G01N 33/574 (2006.01)			
A61P 35/00 (2006.01)			
C12N 5/09 (2010.01)			
C12N 15/02 (2006.01)			
A61K 39/02 (2006.01)			
C12N 1/15 (2006.01)			
C12N 1/38 (2006.01)			
C12N 15/03	3565560	PREDICTIVE AND DIAGNOSTIC METHODS FOR PROSTATE CANCER	
C07K 16/18 (2006.01)			
C12N 1/15 (2006.01)			
C12N 1/19 (2006.01)			
C12N 1/21 (2006.01)			
C12N 5/10 (2006.01)			
C12N 15/09 (2006.01)			
C12P 21/08 (2006.01)			
G01N 33/574 (2006.01)			
A61P 35/00 (2006.01)			
C12N 5/09 (2010.01)			
C12N 15/02 (2006.01)			
A61K 39/02 (2006.01)			
C12N 1/15 (2006.01)			
C12N 1/38 (2006.01)			
C12N 15/03	3567162	IMPROVED ROAD PROTECTION BARRIER	
C07K 16/18 (2006.01)			
C12N 1/15 (2006.01)			
C12N 1/19 (2006.01)			
C12N 1/21 (2006.01)			
C12N 5/10 (2006.01)			
C12N 15/09 (2006.01)			
C12P 21/08 (2006.01)			
G01N 33/574 (2006.01)			
A61P 35/00 (2006.01)			
C12N 5/09 (2010.01)			
C12N 15/02 (2006.01)			
A61K 39/02 (2006.01)			
C12N 1/15 (2006.01)			
C12N 1/38 (2006.01)			
C12N 15/03	3568199	MITIGATION OF INTERPLAY EFFECT IN PARTICLE RADIATION THERAPY	
C07K 16/18 (2006.01)			
C12N 1/15 (2006.01)			
C12N 1/19 (2006.01)			
C12N 1/21 (2006.01)			
C12N 5/10 (2006.01)			
C12N 15/09 (2006.01)			
C12P 21/08 (2006.01)			
G01N 33/574 (2006.01)			
A61P 35/00 (2006.01)			
C12N 5/09 (2010.01)			
C12N 15/02 (2006.01)			
A61K 39/02 (2006.01)			
C12N 1/15 (2006.01)			
C12N 1/38 (2006.01)			
C12N 15/03	3569709	ANTI-GPC3 ANTIBODY	
C07K 16/18 (2006.01)			
C12N 1/15 (2006.01)			
C12N 1/19 (2006.01)			
C12N 1/21 (2006.01)			
C12N 5/10 (2006.01)			
C12N 15/09 (2006.01)			
C12P 21/08 (2006.01)			
G01N 33/574 (2006.01)			
A61P 35/00 (2006.01)			
C12N 5/09 (2010.01)			
C12N 15/02 (2006.01)			
A61K 39/02 (2006.01)			
C12N 1/15 (2006.01)			
C12N 1/38 (2006.01)			
C12N 15/03	3568471	PERSONALIZED VACCINES	
C07K 16/18 (2006.01)			
C12N 1/15 (2006.01)			
C12N 1/19 (2006.01)			
C12N 1/21 (2006.01)			
C12N 5/10 (2006.01)			
C12N 15/09 (2006.01)			
C12P 21/08 (2006.01)			
G01N 33/574 (2006.01)			
A61P 35/00 (2006.01)			
C12N 5/09 (2010.01)			
C12N 15/02 (2006.01)			
A61K 39/02 (2006.01)			
C12N 1/15 (2006.01)			
C12N 1/38 (2006.01)			
C12N 15/03	3571288	INDUCTION OF PROTECTIVE IMMUNITY AGAINST ANTIGENS	
C07K 16/18 (2006.01)			
C12N 1/15 (2006.01)			
C12N 1/19 (2006.01)			
C12N 1/21 (2006.01)			
C12N 5/10 (2006.01)			
C12N 15/09 (2006.01)			
C12P 21/08 (2006.01)			
G01N 33/574 (2006.01)			
A61P 35/00 (2006.01)			
C12N 5/09 (2010.01)			
C12N 15/02 (2006.01)			
A61K 39/02 (2006.01)			
C12N 1/15 (2006.01)			
C12N 1/38 (2006.01)			
C12N 15/03			

Podnosilac evropske prijave patenta (71)	MKP (51)	Broj objave evropske prijave patenta (97)	Naziv pronalaska (54)
Magenta Therapeutics, Inc.	(2006.01) A61K 47/68 (2017.01) C07K 16/28 (2006.01)	3571230	COMPOSITIONS AND METHODS FOR THE DEPLETION OF CD137+ CELLS
Innate Immunity LLC	C12N 5/00 (2006.01) A01H 5/00 (2018.01) A01N 37/18 (2006.01) A01N 61/00 (2006.01)	3570664	COMPOSITIONS AND METHODS FOR PROTECTING HOSTS AGAINST PATHOGEN INFECTIONS
	C02F 1/44 (2006.01) C07D 301/32 (2006.01) G01N 33/00 (2006.01)	3571163	METHODS AND SYSTEMS FOR TREATMENT OF ETHYLENE OXIDE
La Jolla Pharmaceutical Company	A61K 38/08 (2019.01) A61K 38/10 (2006.01) A61K 38/16 (2006.01) A61K 38/17 (2006.01) A61K 38/22 (2006.01) A61P 3/00 (2006.01) A61P 7/06 (2006.01) A61P 13/12 (2006.01) H04L 29/08 (2006.01)	3570873	COMPOSITIONS AND METHODS FOR TREATING IRON OVERLOAD
	A61K 31/4439 (2006.01) A61K 31/496 (2006.01) A61P 13/12 (2006.01) A61P 37/06 (2006.01) A61P 37/08 (2006.01) C07D 207/16 (2006.01) C07D 401/10 (2006.01) C07D 403/10 (2006.01)	3576377 3575284	GAME SERVER SWITCHING METHOD, RELEVANT DEVICE AND SYSTEM PHENYLDIFLUOROMETHYL-SUBSTITUTED PROLINEAMIDE COMPOUND
	B65G 1/04 (2006.01) B65G 1/06 (2006.01)	3573906	SYSTEM FOR AN AUTOMATED STORAGE
	C12N 1/00 (2006.01) C12N 1/21 (2006.01) C12N 9/00 (2006.01) C12N 9/04 (2006.01) C12N 15/52 (2006.01) C12N 15/63 (2006.01) C12P 7/16 (2006.01) G06F 3/06 (2006.01)	3574081	METHODS AND MICROORGANISMS FOR MAKING 2,3-BUTANEDIOL AND DERIVATIVES THEREOF FROM C1 CARBONS
		3575948	SHARED DATA RECOVERY METHOD, DEVICE, COMPUTER EQUIPMENT AND STORAGE MEDIUM
University of Florida Research Foundation, Incorporated	A61K 39/02 (2006.01) C07K 14/205 (2006.01) C12N 15/74 (2006.01) A63F 13/822 (2014.01)	3573654	A FOOD SAFETY VACCINE TO CONTROL SALMONELLA ENTERICA AND REDUCE CAMPYLOBACTER IN POULTRY
		3574966	PROCESSING METHOD FOR DISPLAYING DATA AT CLIENT, AND RELATED DEVICE

Podnosilac evropske prijave patenta (71)	MKP (51)	Broj objave evropske prijave patenta (97)	Naziv pronalaska (54)
NIRvana Sciences Inc.	A61K 9/00 (2006.01)	3576721	COMPOSITION COMPRISING IMMEDIATE RELEASE AND EXTENDED RELEASE CAPECITABINE
	A61K 31/00 (2006.01)		
	C07D 487/22 (2006.01)	3565818	HYDROPORPHYRINS FOR PHOTOACOUSTIC IMAGING
	G01N 21/64 (2006.01)		
	A61K 31/517 (2006.01)	3578560	QUINAZOLINE COMPOUND
	A61P 35/00 (2006.01)		
	C07D 471/10 (2006.01)		
	C07F 5/04 (2006.01)	3577122	APPARATUS AND CONTINUOUS FLOW PROCESS FOR PRODUCTION OF BORONIC ACID DERIVATIVE
Sheltered Wings, Inc. D/b/a/ Vortex Optics	F41G 1/387 (2006.01)	3577509	VIEWING OPTIC WITH AN INTEGRATED DISPLAY SYSTEM
	F41G 3/06 (2006.01)		
	F41G 11/00 (2006.01)		
	G02B 7/00 (2006.01)		
	G02B 27/01 (2006.01)		
	A61K 38/00 (2006.01)	3576768	TREATMENT OF MUCOPOLYSACCHARIDOSIS I WITH FULLY-HUMAN GLYCOSYLATED HUMAN ALPHA-L-IDURONIDASE (IDUA)
	A61K 38/43 (2006.01)		
	A61K 48/00 (2006.01)		
	A61P 25/00 (2006.01)		
	A61P 25/28 (2006.01)		
	C12N 15/09 (2006.01)		
	C07K 7/60 (2006.01)	3577129	METHODS FOR TREATING FUNGAL INFECTIONS
	A61K 48/00 (2006.01)	3577221	POLYNUCLEOTIDE SECONDARY STRUCTURE
	C07H 19/02 (2006.01)		
	C07H 21/00 (2006.01)		
	C12N 15/11 (2006.01)		
Kansas State University Research Foundation MS Biotech, Inc.	A61P 31/04 (2006.01)	3577213	MICROBIAL CELLS, METHODS OF PRODUCING THE SAME, AND USES THEREOF
	C12N 1/00 (2006.01)		
	C12N 1/04 (2006.01)		
	C12N 1/14 (2006.01)		
Dragonfly Therapeutics, Inc.	C12N 1/21 (2006.01)		
	A61K 39/395 (2006.01)	3579876	PROTEINS BINDING BCMA, NKG2D AND CD16
	C07K 16/28 (2006.01)		
	G06K 9/62 (2006.01)	3582144	SAMPLE SELECTION METHOD, APPARATUS AND SERVER
Nanjing University of Aeronautics and Astronautics	A61K 31/395 (2006.01)	3579835	HERBAL COMPOSITIONS OF CALIFORNIA POPPY AND METHOD FOR THE TREATMENT OF SLEEP AND DREAM-RELATED DISORDERS
Mondias Naturels Inc.	A61K 31/4748 (2006.01)		
	A61K 36/71 (2006.01)		
	A61P 25/20 (2006.01)		
	C07D 451/14 (2006.01)		
	C07D 491/153 (2006.01)		

Podnositelj evropske prijave patenta (71)	MKP (51)	Broj objave evropske prijave patenta (97)	Naziv pronalaska (54)
Trojan, R., Joseph	C07K 16/28 (2006.01)	3580239	ANTI-ILT3 ANTIBODIES AND ANTIBODY DRUG CONJUGATES VACUUM BLENDER
	A47J 43/046 (2006.01)	3579731	
	A47J 43/07 (2006.01) A61K 39/395 (2006.01)	3582813	TREATMENT OF HIDRADENITIS SUPPURATIVA
Dragonfly Therapeutics, Inc.	A61P 17/00 (2006.01)	3583131	PROTEINS BINDING CD33, NKG2D AND CD16
	C07K 16/24 (2006.01)		
	C07K 16/28 (2006.01)		
Eidos Therapeutics, Inc.	C07K 16/32 (2006.01)	3582805	ANTI-PD-L1 ANTIBODY TREATMENT OF BLADDER CANCER
	A61K 39/00 (2006.01)		
	A61K 39/395 (2006.01)		
	C07K 16/28 (2006.01)	3582773	PROCESSES FOR PREPARING AG-10, ITS INTERMEDIATES, AND SALTS THEREOF
	C07K 16/30 (2006.01)		
	G01N 33/574 (2006.01)		
	A61K 31/415 (2006.01)		
A61P 13/12 (2006.01)	3585052	IMAGE IDENTIFICATION METHOD, DEVICE, APPARATUS, AND DATA STORAGE MEDIUM METHOD OF DETECTING PHOTOGRAPHIC DIRECTION SHIFT, DEVICE, APPARATUS, AND DATA STORAGE MEDIUM	
A61P 17/06 (2006.01)			
Alector LLC	H04N 7/18 (2006.01)	3584768	HIGH POTENCY IMMUNOGENIC COMPOSITIONS
	G07C 5/08 (2006.01)	3582790	
	A61K 31/7105 (2006.01)	3583943	
	A61K 39/12 (2006.01)		
	A61P 31/14 (2006.01)		
	A61K 31/47 (2006.01)		
	A61K 47/04 (2006.01)		
	A61K 47/38 (2006.01)		
	A61K 47/40 (2006.01)		
	A61P 35/00 (2006.01)	3589658	
C07K 16/28 (2006.01)			
Kindred Biosciences, Inc.	A61K 39/395 (2006.01)	3585429	ANTI-IL31 ANTIBODIES FOR VETERINARY USE
	C07K 16/18 (2006.01)	3585405	PHARMACEUTICAL COMPOSITIONS OF A BILE ACID DERIVATIVE AND MICROBIOME AND USES THEREOF
	A61K 31/573 (2006.01)		
Aleta Biotherapeutics Inc.	A61K 35/74 (2015.01)	3585426	COMPOSITIONS AND METHODS FOR TUMOR TRANSDUCTION
	A61K 39/00 (2006.01)		
	A61K 39/395 (2006.01)	3585431	BISPECIFIC BINDING MOLECULES THAT ARE CAPABLE OF BINDING CD137 AND TUMOR
	C07K 16/30 (2006.01)		
	A61K 39/395 (2006.01)		

Podnosilac evropske prijave patenta (71)	MKP (51)	Broj objave evropske prijave patenta (97)	Naziv pronalaska (54)
	A61P 35/00 (2006.01)		ANTIGENS, AND USES THEREOF
	C07K 16/28 (2006.01)	3585817	COMPOSITIONS AND METHODS FOR TREATMENT OF CANCER
	C07K 16/30 (2006.01)		
	C07K 16/32 (2006.01)		
	C07K 16/42 (2006.01)		
	C07K 16/46 (2006.01)		
	C07K 19/00 (2006.01)		
Morphic Therapeutic, Inc.	A61K 31/4745 (2006.01)	3589285	INHIBITORS OF (ALPHA-V)(BETA-6) INTEGRIN
	C07D 401/12 (2006.01)		
	C07D 471/04 (2006.01)		
Obsidian Therapeutics, Inc.	A61K 35/14 (2015.01)	3589646	CD19 COMPOSITIONS AND METHODS FOR IMMUNOTHERAPY
	A61K 38/17 (2006.01)		
	A61K 38/43 (2006.01)		
	C07K 14/505 (2006.01)		
	C07K 14/705 (2006.01)		
	C07K 14/725 (2006.01)		
	C07K 16/18 (2006.01)		
	C07K 16/28 (2006.01)		
	C07K 16/30 (2006.01)		
	C07K 16/46 (2006.01)		
Menarini Silicon Biosystems S.p.A.	A61K 39/44 (2006.01)	3589952	IMPROVED KITS AND ASSAYS TO DETECT CIRCULATING MULTIPLE MYELOMA CELLS FROM BLOOD
	A61K 51/10 (2006.01)		
	B03C 1/005 (2006.01)		
	C12N 15/13 (2006.01)		
	G01N 33/50 (2006.01)		
	G01N 33/574 (2006.01)		
	A61K 31/519 (2006.01)	3590516	ANTITUMOR-EFFECT ENHANCER USING PYRAZOLO[3,4-D]PYRIMIDINE COMPOUND
	A61K 33/24 (2019.01)		
	A61K 45/00 (2006.01)		
	A61P 35/00 (2006.01)		
	A61P 43/00 (2006.01)		
	C07D 487/04 (2006.01)		
	C07D 401/12 (2006.01)	3589627	INHIBITORS OF (ALPHA-V)(BETA-6) INTEGRIN
	C07D 471/04 (2006.01)		
Medimmune Limited	A61K 38/16 (2006.01)	3589648	ANTI-RSV MONOCLONAL ANTIBODY FORMULATION

Podnosilac evropske prijave patenta (71)	MKP (51)	Broj objave evropske prijave patenta (97)	Naziv pronalaska (54)
	A61K 39/395 (2006.01)		
	A61K 39/42 (2006.01)		
	A61P 31/12 (2006.01)		
	A61P 31/14 (2006.01)		
	C07K 16/08 (2006.01)		
	C07K 16/10 (2006.01)		
	A61K 31/546 (2006.01)	3592362	SOLID FORMS AND COMBINATION COMPOSITIONS COMPRISING A BETA- LACTAMASE INHIBITOR AND USES THEREOF
	A61K 31/69 (2006.01)		
	A61P 31/04 (2006.01)		
	E21B 34/14 (2006.01)	3592945	A PROCESS FOR PRODUCING HYDROCARBON MATERIAL FROM A SUBTERRANEAN FORMATION WHILE EMPLOYING SOLIDS CONTROL
	E21B 43/12 (2006.01)		
	E21B 43/267 (2006.01)		
	H04N 19/146 (2014.01)	3595307	METHOD FOR VIDEO CODING CODE RATE ALLOCATION AND CODING UNIT CODE RATE ALLOCATION, AND COMPUTER EQUIPMENT
	H04N 19/147 (2014.01)		
	H04N 19/159 (2014.01)		
	H04N 19/176 (2014.01)		
	A61K 31/575 (2006.01)	3592359	CRYSTALLINE FORMS OF OBETICHOLIC ACID
	C07J 9/00 (2006.01)		
	E21B 34/06 (2006.01)	3592946	APPARATUSES, SYSTEMS AND METHODS FOR PRODUCING HYDROCARBON MATERIAL FROM A SUBTERRANEAN FORMATION
	E21B 43/12 (2006.01)		
The University of North Carolina at Chapel Hill	A61M 1/36 (2006.01)	3579897	SHORT-ACTING HEPARIN-BASED ANTICOAGULANT COMPOUNDS AND METHODS
	B01D 15/36 (2006.01)		
Barabás, Árpád	B28B 13/02 (2006.01)	3592522	APPARATUS AND METHOD FOR PRODUCING A PAVER BLOCK HAVING VEINED TREAD SURFACE
Shriners Hospitals for Children	A61K 38/00 (2006.01)	3592373	TYPE X COLLAGEN ASSAYS AND METHODS OF USE THEREOF
	A61K 48/00 (2006.01)		
	C07K 14/78 (2006.01)		
	C12N 15/12 (2006.01)		
	C12N 15/85 (2006.01)		
	G01N 33/53 (2006.01)		
	G01N 33/68 (2006.01)		
	G06F 17/10 (2006.01)	3559821	BACKWARD-COMPATIBLE INTEGRATION OF HARMONIC TRANSPOSER FOR HIGH FREQUENCY RECONSTRUCTION OF AUDIO SIGNALS
	G10L 19/02 (2013.01)		
	G10L 19/22 (2013.01)		
	G10L 19/24 (2013.01)		
	G10L 19/26 (2013.01)		
BAG Bauartikel GmbH	E21D 11/10	3580429	REINFORCEMENT SYSTEM FOR THE

Podnosilac evropske prijave patenta (71)	MKP (51)	Broj objave evropske prijave patenta (97)	Naziv pronalaska (54)
	(2006.01)		CONCRETE LINING OF THE INNER SHELL OF A TUNNEL CONSTRUCTION SOIL BUILDER
Ganadera y Multiplicadora Genética Bio-Ñuble S.A.	A01G 24/12 (2018.01) A01G 24/15 (2018.01) A01G 24/22 (2018.01) C05D 1/04 (2006.01) C05D 9/00 (2006.01) C05F 1/00 (2006.01) C05F 3/00 (2006.01) C05F 5/00 (2006.01) C05G 1/00 (2006.01) C05G 3/04 (2006.01) C09K 17/00 (2006.01) C09K 17/40 (2006.01)	3560908	
Makhalin, Alexei Igorevich	B28B 11/00 (2006.01) B32B 3/08 (2006.01) B65G 47/00 (2006.01) E04C 1/40 (2006.01)	3584383	MULTILAYER STRUCTURAL ELEMENT, METHOD AND PRODUCTION LINE FOR PRODUCTION THEREOF
	A61K 9/00 (2006.01) A61K 31/135 (2006.01) A61K 47/12 (2006.01) A61P 25/24 (2006.01)	3498268	PHARMACEUTICAL COMPOSITION OF S- KETAMINE HYDROCHLORIDE

ŽIGOVI
TRADEMARKS

MEĐUNARODNI KODOVI ZA IDENTIFIKACIJU BIBLIOGRAFSKIH PODATAKA O ŽIGOVIMA PREMA
WIPO ST 60

RECOMMENDATION CONCERNING BIBLIOGRAFIC DATA RELATING TO TRADEMARKS- WIPO-ST.

60

CRNOGORSKI	MDK	ENGLESKI
REGISTRARSKI BROJ	111	NUMBER OF THE REGISTRATION
DATUM REGISTRACIJE	151	DATE OF THE REGISTRATION
OČEKIVANI DATUM PRESTANKA VAŽENJA ŽIGA	181	EXPECTED EXPIRATION DATE OF THE REGISTRATION
BROJ PRIJAVE	210	NUMBER OF THE APPLICATION
DATUM PODNOŠENJA PRIJAVE	220	DATE OF FILING OF THE APPLICATION
PODACI O IZLOŽBENOM PRAVU PRVENSTVA	230	DATA CONCERNING EXHIBITIONS
PODACI O PRAVU PRVENSTVA NA OSNOVU PARISKE KONVENCIJE	300	DATA RELATING TO PRIORITU UNDER THE PARIS CONVENTION
DATUM OBJAVLJIVANJA PRIJAVE	442	DATA OF PUBLICATION OF APPLICATION
SPISAK ROBA I USLUGA PREMA NIČANSKOJ KLASIFIKACIJI ROBA I USLUGA	511	LIST OF GOODS AND SERVICES ACCORDING THE NICE CLASSIFICATION OF GOODS AND SERVICE
IZJAVA PODNOSIOCA PRIJAVE DA NE TRAŽE EKSKLUZIVNO PRAVO ZA POJEDINE NEDINSTIKTIVNE ELEMENTE ZNAKA	526	DISCLAIMER
IZGLED ZNAKA	540	REPRODUCTION OF THE MARK
NAZNAKA O PRIRODI ILI VRSTI ZNAKA	550	INDICATION RELATING TO THE NATURE OR KIND OF MARK
INFORMACIJA O ZATRAŽENIM BOJAMA NA ZNAKU	591	INFORMATION CONCERNING THE COLORS CLAIMED
PODACI O PODNOSIOCU PRIJAVE	731	NAME AND ADDRESS OF THE APPLICANT
IME I ADRESA NOSIOCA ŽIGA	732	NAME AND ADDRESS OF THE HOLDER OF THE REGISTRATION
INFORMACIJA O ZATRAŽENIM BOJAMA NA ZNAKU	591	INFORMATION CONCERNING THE COLORS CLAIMED
PODACI O PODNOSIOCU PRIJAVE	731	NAME AND ADDRESS OF THE APPLICANT
IME I ADRESA NOSIOCA ŽIGA	732	NAME AND ADDRESS OF THE HOLDER OF THE REGISTRATION
IME I ADRESA PUNOMOĆNIKA	740	NAME AND ADDRESS OF THE REPRESENTATIVE

OBJAVA PRIJAVA ŽIGOVA
PUBLICATION OF TRADEMARK APPLICATIONS

(210) Ž-2017-226

(220) 14.06.2017.

(731) Goodyear Dunlop Tyres UK Limited, 2920 Trident Court Solihull Parkway Birmingham Business Park, B37 7YN, Birmingham, GB

(540) GEOMAX ENDURO

(550) I

(740) Jasna Jusović, advokat, Dalmatinska 2, 81000 Podgorica, ME ;

(511) Klasa 12 Gume.

(210) Ž-2017-398

(220) 10.10.2017.

(731) LEDVANCE GmbH, Parking 29-33, 85748, Garching bei München, DE

(540) LINEARLED FLAT

(550) I

(740) Miladin Popović, Đoka Miraševića 21/III, Podgorica, ME ;

(511) Klasa 9: Aparati i instrumenti naučni, pomorski, geodetski, fotografski, kinematografski, optički, za vaganje, mjerenje, kontrolu, spasavanje i nastavu; aparati i instrumenti za signalizaciju; električni i elektronski aparati i instrumenti; aparati i instrumenti za provođenje, prekid transformaciju, akumulaciju, regulaciju ili kontrolu električne energije; aparati za snimanje, prenos i reprodukciju podataka, zvuka ili slike, bimeri, projektori; projektori za slike; magnetni nosači podataka; LED diode (diode koje emituju svjetlost) i laserske diode (takođe organske LED diode i laserske diode); LED moduli lampi, takođe za svrhe signaliziranja; displeji koji koriste LED tehnologiju; uređaji za obradu podata i kompjuteri; električni i elektronski uređaji i aparati za funkcionisanje, regulaciju i kontrolu osvjetljenja; električni i elektronski uređaji i aparati za funkcionisanje, regulaciju i kontrolu svjetiljki i lampi; električni i elektronski uređaji i aparati za funkcionisanje, regulaciju centralnih kontrolnih sistema zgrada električni i elektronski uređaji i aparati za funkcionisanje, regulaciju i kontrolu građevinskih instalacija, interfejs moduli za gore pomenute aparate i uređaje; provodnici svjetlosti; optičke spojnice; senzori; svjetlosne barijere; električni starteri; drajveri; transformatori; elektronske prigušnice; minijaturni transformatori; kalemovi za prigušivanje; konektori električnih priključaka; kontakti elementi uključujući utikače, terminale, naglavke, komutatore, električne prekidače(prekidače) kompjuterski programi i softveri svih vrsta (uključeni u ovu klasu); softverske aplikacije za električne, elektronske i komunikativne uređaje; softverske aplikacije za funkcionisanje, regulaciju i kontrolu svjetiljki i lampi; softverske aplikacije za funkcionisanje i regulaciju centralnih kontrolnih sistema zgrada; softverske aplikacije za funkcionisanje, regulaciju i kontrolu građevinskih instalacija; djelovi za sve gore pomenute robe uključeni u ovu klasu.

Klasa 11: Aparati za rasvjetu, grijanje, proizvodnju pare, kuvanje, hlađenje, sušenje, ventilaciju, vodosnadbijevanje i za sanitarne namjene; aparati za rasvjetu, posebno lampe i svjetiljke; aparati za rasvjetu i sistemi za rasvjetu sastavljeni od njih, posebno na bazi dioda koje emituju svjetlost (LED), takođe organski LED; LED lampe i LED svjetiljke (uključene u ovu klasu) ; lampe za rasvjetu na LED bazi kao i aparati za rasvjetu i sistemi napravljeni od njih; moduli za rasvjetu, naime moduli na LED bazi(kao i na bazi organskih

LED) sa svjetlosnim funkcijama i sa aplikacijama za osvjetljenje; djelovi za gore pomenute robe uključeni u klasu 11.

(210) 2017-483

(442) 20.01.2019

(220) 6/12/2017

(731) Amazon Europe Core S.à.r.l., 5, Rue Plaetis, L-2338 Luxembourg, LU;

(550) I

ECHO

(540)

(740) Jusić Jasna, Dalmatinska 2, Podgorica ME

(511) Klasa 9: Kontrolni uređaji za kucnu automatizaciju; bežični komunikacioni uređaji za prenos glasa, podataka iii slika; uređaji za prenos i prijem glasa i podataka; samostalni informacioni Uređaji koji se kontrolisu pomocu glasa; nezavisni glasovno-aktivirani lični (virtualni) asistenti koji integriraju usluge koje se pružaju putem aplikacija; zvučnici koji se kontrolisu pomocu glasa; aparati i instrumenti naučni, pomorski, geodetski, fotografski, kinematografski, optički, za vaganje, mjerenje, signalizaciju, kontrolu (inspekciju), spasavanje i nastavu; aparati za snimanje, prenos iii reprodukciju zvuka iii slika; računске mašine; oprema za obradu podataka; kompjuteri; aparati i instrumenti za provodenje, prekid, transformaciju, akumulaciju, regulisanje iii kontrolu elektricne energije; magnetni nosaci podataka; diskovi za snimanje; kompakt diskovi, DVD i drugi digitalni nosaci podataka; mehanizmi za aparate koji se pokrecu novcem; računarski softver; prenosivi elektronski uređaji za prijem, prenos i citanje teksta, slika i zvuka putem bezicnog internet pristupa; daljinski kontrolni uređaji za uređaje za snimanje; daljinski kontrolni uređaji; bežični kontrolni uređaj za daljinski nadzor i kontrolu funkcije i statusa drugih elektricnih, elektronskih, i mehaničkih uređaja i sistema; kompjuterski ekrani osjetljivi na dodir; digitalni audio plejeri; audio rekorderi; digitalni video plejeri; prenosivi uređaji za snimanje, prenos i reprodukciju muzike, slika i videa; elektronski aparati i instrumenti za obuku i nastavu; kamere; digitalne kamere; softver za preusmjeravanje poruka; kompjuterski hardver i softver za obradu, reprodukciju, sinhronizaciju, snimanje, organizovanje, preuzimanje, postavljanje, prenos, striming, prijem, pustanje i gledanje televizijskih emisija, filmova, teksta, slika, digitalnih medija, multimedija, audio, video i fajlova sa podacima; kompjuterski softver za pristup, nadgledanje, pracenje, pretraživanje, čuvanje i dijeljenje informacija u vezi sa temama od opšteg interesa; kompjuterski softver i periferne jedinice za personalizovano, interaktivno televizijsko (TV) programiranje; kompjuterski softver i periferni uređaji za upotrebu kod prikazivanja i manipulisanja vizuelnim medijima, grafičkim slikama, tekstovima, fotografijama, ilustracijama, digitalnim animacijama, video klipovima, filmskim snimcima i audio podacima i za upotrebu kod drustvenog umrežavanja; kompjuterski programi za pristup, pregledanje i pretrazivanje onlajn baza podataka; kompjuterski hardver i softver za pružanje integrirane telefonske komunikacije za kompjuterizovanim globalnim informacionim mrežama; kompjuterski softver koji se koristi za kontrolu nezavisnih glasovno-aktiviranih licnih (virtualnih) asistenata koji integrisu usluge koje se pružaju putem aplikacija; kompjuterski softver koji se koristi u vezi sa uslugama pretplate na digitalne sadržaje, osiguravanjem platforme za pretragu koje omogućavaju korisnicima da traže i primaju sadržaj digitalnih medija; kompjuterski softver za kreiranje, autorstvo, distribuciju, preuzimanje, prenos, prijem, igranje, formatiranje, editovanje, ekstrakciju, kodiranje, dekodiranje, konvertovanje, prikazivanje, skladištenje i organizaciju teksta, vizuelnih, audio i audio-vizuelnih literarnih radova, podataka, fajlova, dokumenata i elektronskih radova i multimedijalnog sadržaja; kompjuterski

softver koji omogućava da se sadržaj, tekst, vizuelni, audio i audio-vizuelni radovi, literarni radovi, podaci, fajlovi, dokumenta i elektronski radovi budu preuzeti na i da im se može pristupiti na kompjuteru ili drugim prenosivim elektronskim Uređajima; kompjuterski softver za prenos, dijeljenje, prijem, preuzimanje, striming, prikazivanje i prebacivanje sadržaja, teksta, vizuelnih, audio i audio-vizuelnih radova, literarnih radova, podataka, fajlova, dokumenata i elektronskih radova putem prenosivih elektronskih Uređaja i kompjutera i globalnih kompjuterskih i komunikacionih mreža; stereo zvučnici za ličnu upotrebu; mikrofoni; softver za prepoznavanje slova, simbola; softver za prepoznavanje glasa; softver za elektronsku poštu i poruke; kompjuterski softver za formatiranje i konvertovanje sadržaja, teksta, vizuelnih, audio i audio-vizuelnih radova, literarnih radova, podataka, fajlova, dokumenata i elektronskih radova u format kompatibilan sa prenosivim elektronskim uređajima i kompjuterima; kompjuterski softver za upravljanje licnim informacijama i za pristup, pregledanje i pretragu audio i multimedijalnog sadržaja, igrica i softverskih aplikacija; softver za prepoznavanje glasa i glasovne komande, softver za pretvaranje govora u tekst i softverske aplikacije koje se aktiviraju putem glasa; softver koji se može preuzeti sa interneta u vidu mobilnih aplikacija za kompjutere ili druge prenosive elektronske uređaje široke potrošnje; kompjuterski softver iz oblasti prenosa i prikaza teksta, slika i zvuka.

Klasa 35: Oglašavanje; marketinške usluge i usluge oglašavanja, naime, promocija proizvoda i usluga drugih strana; usluge za realizaciju porudžbina, naime, usluge u vezi sa prijemom i obradom porudžbina; pružanje informacija o proizvodima u svrhu asistiranja pri odabiru standardne potrošačke robe, a radi zadovoljenja potreba potrošača; obezbjeđivanje usluga za optimizaciju pretraživača; usluge uporedne kupovine, naime, promovisanje roba i usluga drugih strana; elektronsko upravljanje bazama podataka i fajlovima; kreiranje indeksa informacija, sajtova i drugih izvora dostupnih na globalnim kompjuterskim mrežama i drugim elektronskim i komunikacionim mrežama za druge; pružanje informacija o potrošačkim proizvodima u cilju odabira standardne potrošačke robe, a radi zadovoljenja specifikacija i potreba potrošača; komercijalne informacije i savjeti za potrošače, naime, pružanje mogućnosti internet korisnicima da postave ocjene, napisu recenzije i preporuke za širok spektar potrošačkih proizvoda; usluge onlajn maloprodajnih objekata koje nude širok spektar potrošačke robe drugih strana; usluge maloprodajnih objekata koje nude širok spektar potrošačke robe drugih strana; maloprodajne i onlajn maloprodajne usluge u vezi sa knjigama, elektronikom, hranom, vinom i napicima, kuhinjskim 735 proizvodima, proizvodima za šišćenje, posudem za kuvanje, proizvodima za domaćinstvo, odjećom, proizvodima za ličnu njegu, proizvodima za kućne ljubimce, sportskom opremom, opremom za kampovanje, igračkama, nakitom, cvijecem, obućom i pokrivalima za glavu; vodenje poslova, poslovno upravljanje; kancelarijski poslovi; obezbjeđivanje direktorijuma za telefonske brojeve, poslovne adrese, adrese elektronske pošte, adrese internet stranica, adrese i telefonski brojevi ljudi, mjesta i organizacija.

Klasa 38: Telekomunikacione usluge; telekomunikacione usluge, naime, elektronski prenos emitovanih fajlova sa audio, vizuelnim i multimedijalnim sadržajem koji se može preuzimati putem kompjutera i drugih komunikacionih mreža; elektronski prenos poruka, glasa, podataka i slika putem globalnih komunikacionih mreža; elektronska komunikacija; elektronski prenos informacija i podataka; dostava poruka putem elektronskog prenosa; obezbjeđivanje pristupa forumima za diskusiju; obezbjeđivanje onlajn oglasnih tabli za prenos poruka među kompjuterskim korisnicima u vezi sa informacijama o potrošačkim proizvodima; audio emotiviranje izgovorene riječi; audio emitovanje i prenos obrazovnih i zabavnih digitalnih medija; bezicne širokopojasne komunikacione usluge; obezbjeđivanje pristupa interaktivnoj bazi podataka za prenos poruka između kompjuterskih korisnika i pretplatnika a u vezi sa knjigama, filmovima, igranim filmovima, igrama, igračkama, sportskom opremom, elektronikom, multimedijalnim prezentacijama i drugim proizvodima za domaćinstva i potrošačkim proizvodima; obezbjeđivanje pristupa onlajn direktorijumima, bazama podataka, internet stranicama i blogovima na temu aktuelnih događaja i onlajn referentnim materijalima; obezbjeđivanje onlajn portal i internet stranica obrazovnog i zabavnog sadržaja,

naime, filmovi, televizijske emisije, audiovizuelni radovi, muzika, audio radovi, knjige, pozorišni radovi, literarni radovi, sportski događaji, rekreativne aktivnosti, slobodne aktivnosti u vidu hobija, turnira, umjetnosti, plesa, mjuzikala, kulture, sportskih i izložbi aktualnih događaja, sportskih instrukcija, klubova, radio programa, komedija, drama, takmicenja, vizuelnih umjetničkih djela, igara, igrice, festival, muzeja, parkova, kulturnih događaja, koncerata, elektronskih editorijala, animacija, aktualnih događaja, modnih revija, multimedijalnih prezentacija i interaktivnih edukativnih kvizova; prenos podkastova, prenos vebkastova; usluge tekstualnih i numeričkih bežičnih poruka; obezbjeđivanje onlajn mreže koja omogućava korisnicima pristup i dijeljenje sadržaja, teksta, vizuelnih, audio i audiovizuelnih radova, literarnih radova, podataka, fajlova, dokumenata i elektronskih radova; obezbjeđivanje telekomunikacionog vremenskog pristupa korisnicima komunikacionim mrežama putem identifikacije, lociranja, grupisanja, distribuiranja i upravljanja podacima i linkovima kompjuterskih servera trećih strana, kompjuterskih procesora i kompjuterskih korisnika; obezbjeđivanje kompjuterskih direktorijuma za telefonske brojeve, poslovne adrese, adrese elektronske pošte, adrese internet stranica, adrese i telefonske brojeve ljudi, mjesta i organizacija; obezbjeđivanje pristupa pomoćnim Uređajima i elektronskim Uređajima u vidu obezbjeđivanja usluga telekomunikacione povezanosti za prenos slika, poruka, audio, vizuelnih i audiovizuelnih i multimedijalnih radova između čitača elektronskih knjiga, mobilnih telefona, pametnih telefona, prenosivih elektronskih Uređaja, prenosivih digitalnih Uređaja, tableta i kompjutera; emitovanje audio, vizuelnog i audiovizuelnog materijala preko internet i drugih kompjuterskih i komunikacionih mreža; obezbjeđivanje onlajn saba za caskanje, internet foruma i onlajn zajednica za prenos fotografija, videa, teksta, podataka, slika i drugih elektronskih radova; obezbjeđivanje informativnih, konsultacionih i savjetodavnih usluga u vezi sa gore navedenim.

Klasa 41: Obezbjeđivanje informacija koje se odnose na zabavu; izdavanje časopisa; pružanje onlajn elektronskih publikacija (koje se ne mogu preuzeti); objavljivanje elektronskih knjiga, novina; objavljivanje materijala na magnetnim ili optičkim medijima; objavljivanje muzike na mreži; pružanje informacija u oblasti zabave na mreži; obezbjeđivanje unaprijed snimljene muzike i podkastova koji se ne mogu preuzeti; pružanje edukativnih i zabavnih informacija, vijesti i komentara u oblasti aktualnih događaja, 736 zabave, kulturnih događaja, vijesti, sparta, zabave, poslovanja i finansija, politike i javnog upravljanja, zdravlja i fizičke kondicije, vremenskih uslova, nauke i tehnologije, putovanja, umjetnosti i književnosti, nacina života i licnog razvoja, prevoza robe u kopnenim i transportnim vozilima, obrazovanja i razvoja djece, nekretnina, mode i dizajna, recepata, sastojaka i kuvanja, uređenja kuće, muzike i bioskopa, istorije, medicine, prava i pružanja obrazovnih i zabavnih informacija o pravima kupaca; obezbjeđivanje internet stranice sa informacijama, audio sadržajem i publikacijama koje se odnose na zabavu; obezbjeđivanje vijesti i informacija u oblasti zabave u vezi sa informacijama, takmicenjima, tekstovima, zvukom, publikacijama koje se odnose na zabavu; konsultantske usluge u oblasti zabave i industrije zabave; pružanje informacija o zabavi, filmovima i televizijskim emisijama preko društvenih mreža; distribucija radio zabave i interaktivnog oglašavanja; zabavne informativne usluge, naime, pružanje mogućnosti za razmjenu informacija i razgovor o širokom spektru tema putem događaja uživo i informacija putem elektronske pošte; pružanje informacija, pregleda i personalizovanih preporuka iz oblasti zabave putem globalnih komunikacionih mreža; pružanje informacija i komentara u oblasti zabave ili obrazovanja putem globalne računarske mreže, odnosno informacija u oblasti muzike, knjiga, filmova, igranih filmova, igara, igračaka, sportskih proizvoda, elektronike, multimedijalnih prezentacija i drugih proizvoda za domaćinstvo i potrošačkih proizvoda; usluge za zabavu, naime, obezbjeđivanje onlajn unaprijed snimljenih audio programa iz oblasti muzike, knjiga, filmova, igranih filmova, igara, igračaka, sportskih proizvoda, elektronike, multimedijalnih prezentacija i drugih proizvoda za domaćinstvo i potrošačkih proizvoda; usluge zabave, naime, pružanje onlajn kritika, ocjena i preporuka muzike, knjiga, filmova, igranih filmova, igara, igračaka, sportskih proizvoda, elektronike, multimedijalnih prezentacija i drugih proizvoda za domaćinstvo i potrošačkih proizvoda; usluge zabave,

naime, obezbjeđivanje dijela unaprijed snimljenih audio radova putem interneta; izdavanje knjiga, časopisa, periodičnih časopisa, književnih radova, audio radova i audiovizuelnih radova; obezbjeđivanje unaprijed snimljenih audio, vizuelnih i audio-vizuelnih radova koji se ne mogu preuzimati preko bezicnih mreža; pružanje onlajn kompjuterskih igara i onlajn interaktivnih prica; obezbjeđivanje informacija, vijesti, članaka i komentara u oblasti edukacije i obrazovnih institucija; edukativne usluge u ime nastave u ucionici i onlajn učenje na daljinu na temu aktuelnih događaja, obrazovanja, istorije, jezika, liberalnih umjetnosti, matematike, biznisa, nauke, hobija, tehnologije, kulture, sparta, umjetnosti, psihologije i filozofije; interaktivne obrazovne usluge u vidu instrukcija na kompjuterima ili pomoću kompjutera a na temu aktuelnih događaja, obrazovanja, istorije, jezika, liberalnih umjetnosti, književnosti, matematike, biznisa, nauke, hobija, tehnologije, kulture, sparta, umjetnosti, psihologije i filozofije; edukativne i zabavne usluge koje se odnose na podcastove, vebkastove i kontinuirane programe sa vijestima i komentarima iz oblasti muzike, audio radova, knjiga, pozorišta, književnih radova, sportskih događaja, rekreativnih aktivnosti, slobodnih aktivnosti, turnira, umjetnosti, plesa, mjuzikala, izložbi, sportske nastave, klubova, radija, komedije, takmicenja, vizuelnih radova, igara, igrice, festivala, muzeja, parkova, kulturnih događaja, koncerata, izdavaštva, animacija, aktuelnih događaja, mode i multimedijalnih prezentacija koje su dostupne putem interneta ili drugog računara na komunikacionim mrežama; proizvodnja radio programa; radio zabave; usluge studijskog snimanja; pružanje onlajn informacija u vezi sa kompjuterskim igricama i računarskim poboljšanjima za igrice; obezbjeđivanje baze podataka za onlajn zabavu koja se može pretraživati, uključujući onlajn muziku koja se ne može preuzeti i drugi digitalni tekst, audio datoteke sa knjigama, časopisima, vijestima i informacijama; pružanje informacija, konsultantskih i savjetodavnih usluga u vezi sa gore navedenim.

Klasa 42: Obezbeđivanje alata za pretraživanje; kompjuterske usluge, naime, daljinski hosting operativnih sistema i kompjuterskih aplikacija; hosting operativnih sistema i kompjuterskih aplikacija preko interneta; kompjutersko programiranje; konsultantske usluge u vezi sa upravljanjem, prezentacijom i kontrolom multimedijalnih aplikacija; dizajn hardvera, softvera i kompjuterskih sistema; usluge uređivanja, ažuriranja, održavanja i podrške za softverske i kompjuterske sisteme; kompjuterske usluge u vezi sa upravljanjem, prezentacijom i kontrolom multimedijalnih aplikacija, istraživanje, upravljanje bazama podataka, upravljanje objektima, usluge podugovaranja; kompjuterske usluge, naime, hosting preko interneta onlajn baza podataka koje sadrže širok spektar informacija od opšteg interesa; kompjuterske usluge, naime, obezbjeđivanje alata za pretraživanje informacija od opšteg interesa; hosting interaktivne baze podataka za prenos poruka među kompjuterskim korisnicima i pretplatnicima; hosting interaktivne baze podataka za prenos poruka među kompjuterskim korisnicima i pretplatnicima, a u vezi sa knjigama, filmovima, igranim filmovima, televizijskim programima, igrama, igračkama, sportskom opremom, elektronskim uređajima, multimedijalnim prezentacijama i drugom potrošačkom robom i robom za domaćinstvo, ocjenama proizvoda i informacijama o kupovini na internetu; pružanje softvera onlajn internet pregledaca koji se ne može preuzeti; pružanje softvera koji se ne može preuzeti za mobilni komunikacioni uređaj za poboljšanje mobilnog pristupa internetu putem računara, mobilnih računara i mobilnih komunikacionih uređaja; tehnička podrška, naime, rješavanje problema kompjuterskog hardvera i softvera i hardverskih i softverskih problema na mobilnim računarima i mobilnim komunikacionim uređajima; konsultacije i dizajn u vezi sa kompjuterskim hardverom i softverom; dizajn kompjuterskog softvera za druge; konsultacije i dizajn u vezi sa mobilnim računarima i mobilnim komunikacionim uređajima; hosting sadržaja, fotografija, teksta, podataka, slika, internet stranica i drugih elektronskih radova za treća lica; pružanje platformi za pretragu kako bi se korisnicima omogućilo da traže i primaju fotografije, tekst, podatke, slike, elektronske radove, vizuelne radove, audio radove, audio- vizuelne radove, literarne radove i dokumenta; interaktivne hosting usluge koje dozvoljavaju korisnicima da objavljuju i dijele sopstvene fotografije, tekst, podatke i slike onlajn; održavanje i ažuriranje softvera u vezi sa računarima, internetom i sigurnošću lozinki i prevencija rizika za

računare, internet i lozinke; instalacija i održavanje kompjuterskog softvera; pružanje internet stranice koja sadrži tehničke informacije u vezi sa kompjuterskim softverom i hardverom; kompjuterske konsultacije; transfer podataka iz dokumenata iz jednog kompjuterskog sistema u drugi; hosting digitalnog sadržaja na globalnim računarskim mrežama, bezicnim mrežama i mrežama elektronske komunikacije; pružanje privremene upotrebe kompjuterskog softvera i onlajn postrojenja, koji se ne mogu preuzeti, kako bi se korisnicima omogućio pristup i preuzimanje kompjuterskog softvera; pružanje privremene upotrebe kompjuterskog softvera koji se ne može preuzeti, a koji generise prilagodene preporuke softverskih aplikacija na osnovu korisničkih preferenci; pracenje kompjuterizovanih podataka i kompjuterskih sistema i mreža za sigurnosne namjene; hosting, prilagodavanje i održavanje onlajn baza podataka za druge; računarstvo u oblaku sa softverom za upotrebu u upravljanju bazama podataka; hosting elektronskih baza podataka u oblaku; pružanje usluga aplikacija (ASP) za softver za upotrebu u upravljanju bazama podataka; platforma u vidu servisa (PAAS) za kompjuterske softverske platforme za upotrebu u upravljanju bazama podataka; softver u vidu servisa (SAAS za upotrebu u upravljanju bazama podataka; softver u vidu servisa (SaaS) za pristup, monitoring, pracenje, pretragu, čuvanje i dijeljenje informacija o temama od opšteg interesa; softver u vidu servisa (SaaS) za upravljanje licnim informacijama i za pristup, pregled i pretragu onlajn baza podataka, audio i multimedijalnog sadržaja, igara, softverskih aplikacija, tržišta softverskih aplikacija, programskih listi i vodica i videa na zahtjev; softver u vidu servisa (SaaS) koji koristi softver za glasovne komande i prepoznavanje glasa, softver za pretvaranje govora u tekst, softverske aplikacije koje se aktiviraju glasom, upravljanje licnim informacijama i softver za pristup, pregled i pretragu onlajn baza podataka, audio i multimedijalnog sadržaja, igara, softverskih aplikacija, tržišta softverskih aplikacija, programskih listi i vodica i videa na zahtjev; softver u vidu servisa (SaaS) kojim se omogućava preuzimanje pristupa na računaru ili drugom nosivom potrošačkom elektronskom Uređaju audio i multimedijalnih datoteka; softver u vidu servisa (SaaS) za mobilne Uređaje kojim se korisniku dozvoljava da pretražuje sadržaj Uređaja radi informacija, kontakata i aplikacija; softver u vidu servisa (SaaS) za kreiranje indeksa informacija, internet stranica i drugih informativnih resursa; softver u vidu servisa (SaaS) za glasovne komande i prepoznavanje glasa; softver u vidu servisa (SaaS) za kontrolu pametnih audio zvučnika; softver u vidu servisa (SaaS) za upotrebu u vezi sa uslugama pretplate na digitalne sadržaje; softver u vidu servisa (SaaS) za kreiranje, autorstvo, distribuciju, preuzimanje, prenošenje, primanje, reprodukciju, uređivanje, izvlacenje, kodiranje, dekodiranje, prikazivanje, čuvanje i organizaciju audio i multimedijalnog sadržaja; pružanje platformi za pretragu kako bi se korisnicima omogućilo da traže i primaju digitalni medijski sadržaj i aplikacije; pružanje privremene upotrebe onlajn softvera i aplikacija koji se ne mogu preuzeti za pristup strimingu audio i video datoteka, igrama, društvenim mrežama, tekstualnim i multimedijalnim datotekama; kompjuterske usluge, naime, pružanje servera baza podataka razlicitih kapaciteta drugima; pružanje internet stranica na kojima se nalazi softver za upravljanje bazama podataka koji se ne može preuzeti; pružanje operativnih sistema i kompjuterskih aplikacija preko interneta; iznajmljivanje kompjuterskih i postrojenja za čuvanje podataka razlicitih kapaciteta; pružanje, razvijanje i dizajn softvera za upravljanje kompjuterskim aplikacijama, koji se ne može preuzeti, a kojem se može pristupiti preko globalne kompjuterske mreže; dizajn, upravljanje i nadgledanje onlajn foruma za diskusiju; kreiranje internet stranica za onlajn usluge i internet, koje se čuvaju elektronski; skladištenje podataka; razrada i održavanje internet stranica za treća lica; upravljanje internet stranicama za druge; iznajmljivanje veb servera; održavanje internet stranica, usluge kreiranja i hostinga; pružanje usluga aplikacija, naime, pružanje, hosting, upravljanje, razvoj i održavanje aplikacija, softvera, internet stranica i baza podataka u oblasti elektronskog poslovanja, onlajn placanja, redosleda naloga, dizajna internet stranica, čuvanja podataka, prilagodavanje kapaciteta računarstva koje se može dijeliti, usluge poruka i izračunavanje rangiranja internet stranica na osnovu protoka korisnika; hosting internet stranica koje korisniku omogućavaju da ocijeni razlicite stampane, fotografske i grafičke slike i koristi prilagodeni sablon kako bi pružio stav,

svidanje, nesvidanje, uređivanje, promjene, modifikacije, mišljenja, prijedloge i komentare i učestvovao u društvenom, poslovnom i umrežavanju u zajednici; kompjuterske usluge, naime, kreiranje onlajn zajednice za registrovane korisnike kako bi učestvovali u diskusijama, dobili povratnu informaciju od sebi jednakih, formirali virtuelne zajednice i učestvovali u društvenom umrežavanju; dizajn i razvoj kompjuterskog hardvera i softvera; dizajn i razvoj softvera za kompjuterske igre; pružanje privremene upotrebe onlajn alata za razvoj softvera, koji se ne mogu preuzeti, za dizajn i razvoj elektronskih igara; usluge tehničke podrške, naime, rješavanje problema softvera kompjuterskih igara; pružanje softverskih aplikacija koje se ne mogu preuzeti; pružanje privremene upotrebe onlajn softvera za računarstvo u oblaku, koji se ne može preuzeti, za upotrebu u elektronskom skladištenju podataka; razvoj kompjuterskog softvera u oblasti mobilnih aplikacija; pružanje usluga aplikacija, naime, hosting, upravljanje, razvoj i održavanje aplikacija, softvera i internet stranica u oblasti licne produktivnosti, bezicne komunikacije i mobilne tehnologije; naučne i tehnološke usluge i istraživanje i dizajn s tim u vezi; industrijske analize i usluge istraživanja; pružanje informacija, konsultacija i savjetodavnih usluga u vezi sa gore navedenim.

Klasa 45: Usluge predstavljanja, društvenih mreža i upoznavanja putem interneta; pružanje kontakata i olakšavanje upoznavanja u svrhu stvaranja i razvijanja produktivnih licnih odnosa za ljude koji imaju zajedničku zelju da upoznaju druge ljude sa sličnim interesovanjima; upoznavanje, lični odnos i usluge društvenih mreža koje se obezbjeđuju putem interneta iii druge računarske ili komunikacione mreže; usluge onlajn društvenih mreža, naime, olakšavanje društvenih upoznavanja ili interakcija među 739 pojedincima; usluge onlajn društvene mreže; usluge onlajn društvenog umrežavanja u oblasti zabave; usluge društvenih mreža u oblasti zabave obezbjedene putem veb stranice i komunikacionih mreža; usluge licnog konsijerza; pravne usluge; bezbjednosne usluge za zaštitu imovine i pojedinaca; obezbjeđivanje onlajn računarskih baza podataka i onlajn baza podataka koje se mogu pretraživati u oblasti društvenih mreža; obezbjeđivanje veb stranice za društvene mreže za zabavu; obezbjeđivanje usluga društvenog umrežavanja u svrhu komentarisanja, upoređivanja, saradnje, konsultovanja, savjeta, diskusije, istraživanja, razmjene informacija, indeksiranja, informacija o lokaciji i zabave; usluge licne kupovine; obezbjeđivanje baze za pretragu koja sadrži audio, video i audiovizuelne sadržaje dostupne putem interneta, telekomunikacionih mreža i bezicnih telekomunikacionih mreža u oblasti onlajn društvenih mreža.

(210) Ž-2018-155

(220) 03.05.2018.

(731) HILTON WORLDWIDE HOLDING LLP, Maple Court Central Park, WD24 4QQ, Reeds Crescent, Watford, GB

(540) LXR

(550) I

(740) AOD Tripković Raičević, Cetinjski put 40, L5-1, 81000 Podgorica, ME;

(511) Klasa 35: organizacija i sprovođenje poslovnih događaja, konferencija, kongresa, izložbi, seminara i sastanaka.

Klasa 36: usluge brokera za nepokretnosti, usluge menadžmenta u vezi sa nepokretnostima.

Klasa 41: usluge razonode u vidu prezentovanja plesa uživo, varijetea i muzičkih nastupa; usluge noćnih klubova; usluge centara za održavanje zdravlja, naime, davanje instrukcija I obezbjeđivanje opreme u oblasti fizičkih vežbi; organizacija i sprovođenje (uživo) izložbi, poslovnih događaja, konferencija, kongresa, seminara i sastanaka u oblasti obrazovanja, kulture, sporta i razonode za neposlovne i nekomercijalne svrhe; rezervacije pozorišta i opere.

Klasa 43: usluge iznajmljivanja privremenog smještaja; usluge rezervacije privremenog smještaja; usluge hotela, motela, barova, kafea, restorana, banketa i usluge kateringa; usluge iznajmljivanja prostorija za održavanje događaja, konferencija, konvencija, izložbi, seminara i sastanka.

Klasa 44: usluge salona za ljepotu, frizerskih salona, berberske usluge; usluge masaže; zdravstvene usluge spa centara vezane za zdravlje i dobrobit tijela i duha; pružanje usluga sauna, jakuzia, solarijuma i sunčanja; usluge aromaterapije; usluge savjetovanja u vezi sa ljepotom, njegom kose i aromaterapijom.

(210) Ž-2018-161

(220) 04.05.2018.

(731) Adriatic Marinas d.o.o., Obala bb, 85320, Tivat, ME

(540) M Residences

(550) I

(740) David Margason, Dom Vojske, Seljanovo bb, 85320, Tivat, ME;

(511) Klasa 36: Osiguranje; finansijski poslovi; novčani (monetarni) poslovi; poslovi vezani za nepokretnosti.

Klasa 39: Transportne usluge; pakovanje i skladištenje robe; organozovanje putovanja.

Klasa 41: Obrazovne usluge; pripremanje obuke; razonoda; sportske i kulturne aktivnosti.

Klasa 43: Usluge obezbjeđivanja hrane i pića; privremeni smještaj.

Klasa 44: Medicinske usluge; veterinarske usluge; higijenska zaštita i njega ljepote za ljude i životinje; agrikulturne, hortikulturne i šumarske usluge.

(210) Ž-2018-316

(220) 21.08.2018.

(731) D.O.O. "Business Integration & Business Intelligence", Bulevar Pera Četkovića 137, 81000, Podgorica, ME, ME

(540) DIGITALNI KIOSK

(550) I

(740) Petar Minić, Studentska 33/A, 81000 Podgorica, ME ;

(511) Klasa 9: Igre (kompjuterski programi za igre), informatički programi [snimljeni], kompjuteri, kompjuteri (memorije za kompjutere), kompjuteri (pomoćni uređaji kompjutera), kompjuteri (stampaci za kompjutere), kompjuteri, džepni kompjuterski programi (snimljeni kompjuterski programi), kompjuterski programi [radni], kompjuterski programi [snimljeni], kompjuterski programi [za skidanje s udaljenijeg na bliži kompjuter ili s jačeg na slabije kompjuter] mreža, miš (podloge za kompjuterske miševe), miš [informatika] modemi, monitori [kompjuterska oprema], monitori [kompjuterski programi], obrada podataka (uređaji za obradu podataka), optički diskovi [diskovi], oslonci za šaku za rad s informatičkom opremom, periferni kompjuterski uređaji, štampači za kompjutere, tastature kompjutera, USB uređaji [vanjski diskovi, priključci].

Klasa 35: Oglašavanje putem pošte, organizovanje poslova (savjetovanje o organiziranju poslova), osoblje (savjetovanje o osoblju), osoblje (zapošljavanje osoblja), podsticaj prodaje za treće osobe, podugovaranje (usluge podugovaranja) [komercijalna pomoć], poslovi (konsultacije za vođenja poslova), potrošači (pružanje komercijalnih savjeta i informacija potrošačima), predstavljanje proizvoda [demonstracija], preduzeća (usluge preseljenja za preduzeća), preseljavanje preduzeća (usluge preseljavanja preduzeća),

pretplata na telekomunikacione usluge za treća lica, prezentacija proizvoda na svim komunikacionim sredstvima u svrhu, prodaje na malo, reklamiranje (iznajmljivanje prostora za potrebe reklamiranja, reklamiranje on-line na informatičkoj mreži, reklamiranje putem radija, reklamiranje putem televizije, reklamna dokumentacija (uređenje reklamne dokumentacije), reklamna pošta, reklamni oglasi (širenje reklamnih oglasa), reklamni tekstovi (objavljivanje reklamnih tekstova), reklamni tekstovi (uređenje reklamnih tekstova), sajmovi (organizovanje sajmova u komercijalne ili reklamne svrhe), savjetovanje (stručno savjetovanje o poslovima), savjetovanje o osoblju, sistematizovanje podataka za središnju kartoteku, sponzori (traženje sponzora), stručne poslovne konsultacije, telefonski odgovori (usluge telefonskih odgovora) za odsutne pretplatnike, telekomunikacione usluge za treće lica (pretplata na telekomunikacione usluge za treće lica), telemarketing (usluge telemarketinga), televizijsko reklamiranje, teretni vagoni (lociranje teretnih vagona pomoću kompjutera), vođenje informatičkih kartoteka.

Klasa 38: Baze podataka (omogućavanje pristupa bazama podataka), elektronska pošta (omogućavanje elektronske pošte), iznajmljivanje modema, iznajmljivanje telekomunikacijskih uređaja, kompjuter (prijenos poruka i slika uz pomoć kompjutera), kompjuterski prijenos poruka i slika, prijenos digitalnih datoteka.

Klasa 41: Elektronske publikacije (iskorištavanje elektronskih publikacija koje se ne mogu prenositi online), igre (usluge igara) pružene on-line [s jedne informatičke mreže], izdavanje knjiga, knjige (izdavanje knjiga), konferencije (organizovanje i vođenje konferencija), kongresi (organizovanje i vođenje kongresa), objavljivanje knjiga i časopisa elektronski on line, objavljivanje tekstova [osim u reklamne svrhe], obrazovanje (informacije o obrazovanju), obrazovanje [obuka], obuka, obuka [predavanje], obuka putem dopisivanja, organizovanje i vođenje konferencija, organizovanje i vođenje kongresa, organizovanje i vođenje radionica za stručno osposobljavanje, organizovanje i vođenje seminara, pisanje tekstova [ne u reklamne svrhe], praktična obuka [demonstriranje], radioaparati i televizori (iznajmljivanje radioaparata i televizora), seminari (organizovanje i vođenje seminara), simpozijumi (organizacija i vođenje simpozijuma), simpozijumi (organizovanje i vođenje simpozijuma), tekstovi (objavljivanje tekstova) [osim u reklamne svrhe], tekstovi (sastavljanje tekstova) [ne u reklamne svrhe], televizori (iznajmljivanje televizora i radioaparata).

Klasa 42: Analiza kompjuterskih sastava, baze podataka (obnavljanje baza podataka), daljinski nadzor kompjuterskih sistema, digitalizacija dokumenata [skeniranje], dupliciranje informatičkih programa, informatičke stranice (ugoščavanje informatičkih stranica), informatički programi (dupliciranje informatičkih programa), informatički programi (iznajmljivanje informatičkih programa), informatički sistemi (osmišljavanje informatičkih sistema), informatički virusi (zaštita od informatičkih virusa), instaliranje kompjuterskih programa, internet (pružanje alata za pretraživanje na internetu), istraživanja u vezi zaštite okoline, istraživanje i razvoj novih proizvoda [za treće lica], iznajmljivanje informatičkih programa, iznajmljivanje informatičkih programa, iznajmljivanje kompjutera, iznajmljivanje veb server, izrada [koncipiranje] kompjuterskih programa, kompjuteri (iznajmljivanje kompjutera), kompjuteri (programiranje za kompjutere), kompjuterski hardver (savjetovanje u vezi dizajna i razvoja kompjuterskog hardvera), kompjuterski programi (instaliranje kompjuterskih programa), kompjuterski programi (održavanje kompjuterskih programa), kompjuterski programi [softver] (izrada kompjuterskih programa), kompjuterski programi [softver] (osavremenjivanje kompjuterskih programa), konsultacije u vezi kompjuterskih programa [softvera], konverzija informatičkih podataka i programa [nije fi žička konverzija], konverzija podataka ili dokumenata s jednog fi žičkog na elektronski disk, programiranje za kompjuteri, razrada tehničkih projekata, savjetovanje o kompjuterima, savjetovanje u vezi zaštite okoline, tehnički projekti (razrada tehničkih projekata), web serveri (iznajmljivanje web servera), web stranice (kreiranje i održavanja web stranica za druge), zaštita od informatičkih virusa, zaštita okoline (istraživanja u vezi zaštite okoline), zaštita okoline (savjetovanje u vezi zaštite okoline).

(210) Ž-2018-381

(220) 11.10.2018.

(731) Nataša Pajović Krajnović, Gavra Vukovica bb, 81000, Podgorica, ME, ME

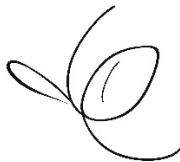

(540)

soočiva

(550) I

(511) Klasa 3: Organski sapun od maslinovog ulja, krema na bazi ekstra djevičanskog maslinovog ulja.

Klasa 29: Jestivo ulje - maslinovo, masline i ostali proizvodi od maslina, naime organsko ekstra djevičansko maslinovo ulje, organske kapsule sa organskim ekstra djevičanskim maslinovim uljem, organske crne masline u salamuri i organske zelene masline u salamuri, organska pašteta od maslina.

Klasa 35: Maloprodaja i veleprodaja svih roba iz klase 29.

(210) Ž-2018-382

(220) 11.10.2018.

(731) FLEKA DOO, Naselje 4 jul S/28/4/12, Cetinje, ME

(540) Made with ♥ by fleka

(550) I

(511) Klasa 35: Oglašavanje i reklamiranje; vođenje komercijalnih poslova; komercijalna administracija; kancelarijski poslovi.

Klasa 41: Obuka; stručno osposobljavanje; razonoda; sportske i kulturne djelatnosti.

Klasa 42: Naučne i tehnološke usluge kao i pripadajuće usluge istraživanja i koncepcije; usluge industrijskih analiza i istraživanja; koncepcija i razvoj računara i računarskih programa/hardvera i softvera/.

(210) Ž-2018-387

(220) 18.10.2018.

(731) P.T. Sumatra Tobacco Trading Company, Jalan Pattimura No. 3, Pematang Siantar, Sumatera Utara, ID

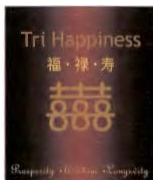

(540)

(550) I

(740) Ana Stanković Mugoša, Trg Nezavisnosti br. 13, 81000 Podgorica, ME;

(511) Klasa 34: Pepeljare (nemetalne), cigare, cigarete, filteri za cigarete, papir za cigarete, upaljači za pušače, šibice, artikli za pušače, duvan.

(210) Ž-2018-417

(220) 07.11.2018.

(731) PHILIP MORRIS PRODUCTS S.A., Quai Jeanrenaud 3, 2000, Neuchâtel, CH



(540)

(550) I

(740) Milena Pejović, Cetinjski put 11, The Capital Plaza IV floor, 81000 Podgorica, ME;

(511) Klasa 9: Aparati i instrumenti naučni, pomorski, geodetski, fotografski, kinematografski, optički, za vaganje, mjerenje, signalizaciju, kontrolu (inspekciju), spasavanje i nastavu; aparati i instrumenti za provođenje, prekid, transformaciju, akumulaciju, regulisanje ili kontrolu električne energije; aparati za snimanje, prienos reprodukciju zvuka ili slike; magnetni nosači podataka, diskovi za snimanje; kompakt diskovi, DVD i drugi digitalni nosači podataka; mehanizmi za aparate koji se pokreću novcem; registar kase, računске mašine, oprema za obradu podataka, računari; računarski softver; aparati za gašenje požara.

Klasa 16: Hartija i karton; štampane stvari, knjigovezački materijal; fotografije; kancelarijski materijal i kancelarijski pribor, osim namještaja; ljepkovi za kancelarijske i kućne potrebe; materijali za crtanje i materijali za umjetnike; kičice; materijali za obuku i nastavu; plastični omotači, folije i kese za umotavanje i pakovanje; štamparska slova, klišeji.

Klasa 34: Duvan, sirov ili prerađen; duvanski proizvodi; cigare, cigarete, cigarilosi, duvan za uvijanje cigareta, duvan za lule, duvan za žvakanje, duvan za šmrkanje, kretek; snus; zamjena za duvan (za nemedicinsku upotrebu); elektronske cigarete; duvanski proizvodi za zagrejanje; elektronski uređaji i njihovi dijelovi koji se koriste za zagrejanje cigareta ili duvana u cilju oslobađanja aerosola koji sadrži nikotin za inhalaciju; tečni nikotinski rastvori za upotrebu u elektronskim cigaretama; artikli za pušače, papir za cigarete, tube za cigarete, filteri za cigarete, kutije za duvan, tabakere (kutije za cigarete), pepeljare, lule, ručni aparati i spravice za uvijanje cigareta, upaljači, šibice.

Klasa 35: Oglašavanje; vođenje poslova; poslovno upravljanje; kancelarijski poslovi.

(210) Ž-2018-448

(220) 15.11.2018.

(731) JADRAN- GALENSKI LABORATORIJ d.d., Svilno 20, 51000, Rijeka, HR



(540)

(550) I

(740) MSA IP - Milojević Sekulić, Karađorđeva 65, 11000 Beograd, RS;

(511) Klasa 3: Toaletni proizvodi; kozmetički proizvodi; parfimerijski proizvodi.

Klasa 5: Medicinska sredstva za higijenu; medicinski preparati; hemijsko-farmaceutski proizvodi; dijetetski i hranljivi dodaci; dijetetske supstance prilagođene za medicinsku upotrebu; dodaci ishrani i dijetetski preparati; lijekovi; lijekovi za ljudsku upotrebu.

Klasa 35: Oglašavanje; reklamiranje i promovisanje.

(210) Ž-2018-452

(220) 19.11.2018.

(731) MERCATOR - CG D.O.O.Podgorica, Put Radomira Ivanovica 2, 81000, Podgorica, ME, ME



(540)

(550) I

(511) Klasa 20: Namještaj , ogledala, okviri za slike, proizvodi (koji nisu obuhvaćeni drugim Klasa ma) od drveta, plute, trske, rogoza, vrbovog pruća, roga, kosti, slonovače, kitove kosti, školjki, ćilibara, sedefa, morske pjene i zamjene svih ovih materijala, ili od plastike.

Klasa 35: Oglašavanje, vođenje poslova, poslovno upravljanje, kancelarijski poslovi.

Klasa 39: Transportne usluge, pakovanje i skladištenje robe, organizovanje putovanja.

Klasa 43: Usluge obezbjeđivanja hrane i pića, privremeni smještaj.

(210) Ž-2018-508

(220) 24.12.2018.

(731) Nataša Grdinić, Jadranski put bb, 85310, Budva, ME



(540)

(550) I

(511) Klasa 36: Upravljanje nekretninama; usluge posrednika za poslove s vrijednosnim papirima i dobrima; usluge administriranja zgradama, to jest usluge iznajmljivanja, procjene nekretnina ili usluge finansiranja.

Klasa 37: Izgradnja;popravke; usluge izgradnje zgrada, puteva, mostova, brana, dalekovoda kao i usluge specijalizovanih preduzeća u području izgradnje, kao sto su moleri, limari, postavljači centralnog grijanja i pokrivači krovova; dodatne građevinske usluge kao što je nadziranje građevinskih projekata; popravke, to jest usluge obnavljanja bilo kojeg dotrajalog, oštećenog ili djelimično razrušenog objekta (prenamjena ili obnavljanje zgrada ili nekog drugog objekta čije prvobitno stanje ne zadovoljava); razne vrste popravaka u području elektrike, pokretnina, mašina, alata itd.; usluge održavanja kojima je cilj dovođenje objekta u njegovo prvobitno stanje bez promjene bilo kojeg njegovog svojstva (radi razlikovanja ove klase od klase 40).

Klasa 39: Prevoz; usluge iznajmljivanja prevoznih sredstava.

Klasa 43: Usluge obezbjeđivanja hrane i pića; privremeno primanje na stan; usluge rezervisanja smještaja za putnike, koje pružaju putničke agencije ili posrednici.

Klasa 45: Pravne usluge; sigurnosne usluge za zaštitu imovine i lica; usluge koje pružaju pravnici pojedincima ili grupama pojedinaca, organizacijama ili preduzećima.

(210) Ž-2019-47

(220) 06.02.2019.

(731) MEGA CONCEPT DOO BEOGRAD - NOVI BEOGRAD, Omladinskih brigada 18/14, Beograd, RS



(540)

(550) I

(740) Miladin Popović, Đoka Miraševića 21/III, 81000, Podgorica, ME

(511) Klasa 6: Bravarski proizvodi, mali metalni građevinski proizvodi, cjevčice i cijevi od metala, prenosive metalne konstrukcije, metalne cijevi za zavjese, metalne garnišne, aluminijumski profili, aluminijumski lančići, sitni djelovi od aluminijuma i drugih metala, aluminijumski poklopci, prozorske roletne od metala, roletne od čelika, roletne od čelika, metalni graničnici za zaustavljanje vrata, metalne šarke za velika vrata, šipke za metalne ograde, prozorske remenice, reze za prozorske okvire, okovi za prozore, zvekiri za vrata, metalni, kapci, zatvarači, od metala, krilni prozori od metala, ramovi za prozore od metala, ramovi za prozore od metala, ramovi, kućišta, za vrata od metala, okviri vrata od metala, djelovi od metala za namještaj, djelovi od metala za krevete, djelovi za vrata od metala, metalni rukohvati za kadu, metalni graničnici za prozorske okvire, metalni graničnici za vrata, metalni nosači za namještaj, metalni okviri kamina [police nad kaminom].

Klasa 16: Hartija i karton, štampane stvari, kancelarijski materijal, umjetnički materijali, štamparska slova, čelična slova [klišeji], nosači ljepljivih traka, oglasni panoi od papira ili kartona, spajalice, heftalice, klipse za olovke, fascikle za spise, spajalice za papir, blokovi, žigovi [pečati], sveske, papir za mašine za snimanje, belježnice, fascikle, korice [kancelarijski materijal], letci, flajeri, natpisi od papira ili kartona, lijepkovi za kancelarijsku ili upotrebu u domaćinstvu.

Klasa 17: Unutrašnje prozorske roletne od PVC-a; garnišne od PVC-a; plastični sitni djelovi; plastični lančići; plastični poklopci, savitljiva crijeva nemetalna, cijevi od tekstilnih materijala, zaptivači za cijevi, spojnice za cijevi, cijevni priključci, nemetalni, gumeni zaustavljači vrata, gumeni graničnici za prozore.

Klasa 20: Kancelarijski stolovi; kancelarijski namještaj; namještaj; pločaste unutrašnje roletne; šine za zavjese (garnišne); šipke za zavjese (garnišne); kukice za zavjese; alke za zavjese; šnale i trake za držanje zavjesa; unutrašnje prozorske roletne (namještaj); unutrašnji prozorski zastori (namještaj); tekstilne roletne za prozore (unutrašnje); držači zavjesa koji nisu od tekstila; prekrivači, jorgani, jastuci za krevete, osim posteljine; dekorativni jastučići; klizači za garnišne; dekorativne zavjese od pedi; zavjese od bambusa; pletene roletne od drva (pokućstvo); papirne roletne, zastori.

Klasa 22: Spoljne roletne od tekstila; nadstrešnice; trake za vezivanje i uvijanje koje nisu od metala; cirade.

Klasa 24: Tekstilni materijali; platno, štof; tkanine; nadstolnjaci koji nisu od papira; pamučne tkanine; jaka pamučna tkanina za zavjese; prekrivači za krevete; prostirke za krevete; zastirači (za krevete); prekrivači za stolove koji nisu od papira; čaršavi (tekstilni); štampane pamučne tkanine; posteljine; peškiri; jastučnice; zavjese od tekstila ili plastike; draperije; mrežaste zavjese; tkanine za tekstilnu upotrebu; pletene tkanine; svilene tkanine; podmetači od tekstila; salvete od tekstila; dekorativna platna za posteljinu; tkanine od vještačke svile; tekstilni prekrivači za namještaj (nepričvršćeni); držači zavjesa od tekstilnih materijala; tkanine koje se lijepe toplotom; platna, rublje za kupatilo, izuzev odjeće; somot, pliše; zastori; zavjese za vrata; zidna tapiserija od tekstila; materijal za baršunaste rese.

Klasa 26: Čipka i vez; trake (pantljičke) i gajtani; rese; baršunaste rese; kukice; kopče; kićanke (galanterija); ukrasne kićanke (pomponi); nabori, ukrasi (čipkani); rozete (galanterija); elastične trake lastiši uzice i gajtani za obrublivanje; trake za pričvršćivanje; trake za zavjese; aplikacije; aplikacije za ukrašavanje tekstilnih proizvoda koje se lijepe toplotom; dekorativni privjesci (osirn za nakit, prstenove za ključeve ili priveske za ključeve).

Klasa 27: Tapete; tekstilne tapete; tepisi, ćilimi; prekrivači za podove; neklizajuće prostirke; podmetači za tepihe; ukrasne zidne dekoracije, netekstilne; podne prostirke; otirači.

Klasa 35: Usluge veleprodaje i maloprodaje bravarskih proizvoda, malih metalnih građevinskih proizvoda, cjevčica i cijevi od metala, metalnih cijevi za zavjese, metalnih garnišni, aluminijumskih profila,

aluminijumskih lančića, sitnih djelova od aluminijuma i drugih metala, aluminijumskih poklopaca, prozorskih roletni od metala, garnišni od PVC-a, plastičnih sitnih djelova, plastičnih lančića, plastičnih poklopaca, tekstilnih roletni za prozore, držača za zavjese od tekstila, mebl štofova, prekrivača za krevete, stolnjaka, posteljina, jastuka, zavjesa, tapeta, tepiha, kancelarijskih stolova, kancelarijskog namještaja, namještaja, pločastih unutrašnjih roletni, šina za zavjese (garnišni), šipki za zavjese, kukica za zavjese, alki za zavjese, šnala i traka za držanje zavjesa, unutrašnjih prozorskih roletni (namještaj), unutrašnjih prozorskih zastora (namještaj), držača zavjesa koji nisu od tekstila, jorgana, dekorativnih jastučića, klizača za garnišne, dekorativnih zavjesa od pedi, zavjesa od bambusa, pletenih roletni od drva (pokućstvo), papirnih roletni, zastora, spoljnih roletni od tekstila, nadstrešnica, traka za vezivanje i uvijanje koje nisu od metala, cirada, tekstilnih materijala, platna, štofova, tkanina, nadstolnjaka koji nisu od papira, pamučnih tkanina, jakih pamučnih tkanina za zavjese, prekrivača za krevete, prostirki za krevete, zastirača (za krevete), prekrivača za stolove koji nisu od papira, čaršava (tekstilnih), štampanih pamučnih tkanina, posteljina, peškira, jastučnica, zavjesa od tekstila ili plastike, draperija, mrežastih zavjesa, tkanina za tekstilnu upotrebu, pletenih tkanina, svilenih tkanina, podmetača od tekstila, salveta od tekstila, dekorativnih platna za posteljinu, tkanina od vještačke svile, tekstilnih prekrivača za namještaj

(nepričvršćenih), tkanina koje se lijepe toplotom, platna, rublja za kupatilo, izuzev odjeće, somota, pliša, zastora, zavjesa za vrata, zidnih tapiserija od tekstila, materijala za baršunaste rese, čipke i veza, traka (pantljička) i gajtana, resa, baršunastih resa, kukica, kopči, kićanki (galanterija), ukrasnih kićanki (pomponi), nabora, ukrasa (čipkanih), rozeta (galanterija), elastičnih traka, lastiša, uzica i gajtana za obrublivanje, traka za pričvršćivanje, traka za zavjese, aplikacija, aplikacija za ukrašavanje tekstilnih proizvoda koje se lijepe toplotom, dekorativnih privezaka (osim za nakit, prstenove za ključeve ili priveske za ključeve), tekstilnih tapeta, ćilima, prekrivača za podove, neklizajućih prostirki, podmetača za tepihe, ukrasnih zidnih dekoracija, netekstilnih, podnih prostirki, otirača.

Klasa 42: Usluge opremanja i dizajna enterijera, naime usluge opremanja i uređenja stanova, kuća, restorana, kafića, hotela i drugih objekata.

(210) Ž-2019-48

(220) 06.02.2019.

(731) MEGA CONCEPT DOO BEOGRAD - NOVI BEOGRAD, Omladinskih brigada 18/14, Beograd, RS



(540)

(550) I

(740) Miladin Popović, Đoka Miraševića 21/III, 81000, Podgorica, ME;

(511) Klasa 6: Bravarski proizvodi, mali metalni građevinski proizvodi, cjevčice i cijevi od metala, prenosive metalne konstrukcije, metalne cijevi za zavjese, metalne garnišne, aluminijumski profili, aluminijumski lančići, sitni djelovi od aluminijuma i drugih metala, aluminijumski poklopci, prozorske roletne od metala, roletne od čelika, roletne od čelika, metalni graničnici za zaustavljanje vrata, metalne šarke za velika vrata, šipke za metalne ograde, prozorske remenice, reze za prozorske okvire, okovi za prozore, zvekiri za vrata, metalni, kapci, zatvarači, od metala, krilni prozori od metala, ramovi za prozore od metala, ramovi za prozore od metala, ramovi, kućišta, za vrata od metala, okviri vrata od metala, djelovi od metala za namještaj, djelovi od metala za krevete, djelovi za vrata od metala, metalni rukohvati za kadu, metalni graničnici za prozorske okvire, metalni graničnici za vrata, metalni nosači za namještaj, metalni okviri kamina [police nad kaminom].

Klasa 16: Hartija i karton, štampane stvari, kancelarijski materijal, umjetnički materijali, štamparska slova, čelična slova [klišeji], nosači ljepljivih traka, oglasni panoi od papira ili kartona, spajalice, heftalice, klipse za olovke, fascikle za spise, spajalice za papir, blokovi, žigovi [pečati], sveske, papir za mašine za snimanje, beljeznice, fascikle, korice [kancelarijski materijal], letci, flajeri, natpisi od papira ili kartona, lijepkovi za kancelarijsku ili upotrebu u domaćinstvu.

Klasa 17: Unutrašnje prozorske roletne od PVC-a; garnišne od PVC-a; plastični sitni djelovi; plastični lančići; plastični poklopci, savitljiva crijeva nemetalna, cijevi od tekstilnih materijala, zaptivači za cijevi, spojnice za cijevi, cijevni priključci, nemetalni, gumeni zaustavljači vrata, gumeni graničnici za prozore.

Klasa 20: Kancelarijski stolovi; kancelarijski namještaj; namještaj; pločaste unutrašnje roletne; šine za zavjese (garnišne); šipke za zavjese (garnišne); kukice za zavjese; alke za zavjese; šnale i trake za držanje zavjesa; unutrašnje prozorske roletne (namještaj); unutrašnji prozorski zastori (namještaj); tekstilne roletne za prozore (unutrašnje); držači zavjesa koji nisu od tekstila; prekrivači, jorgani, jastuci za krevete, osim posteljine; dekorativni jastučići; klizači za garnišne; dekorativne zavjese od pedi; zavjese od bambusa; pletene roletne od drva (pokućstvo); papirne roletne, zastori.

Klasa 22: Spoljne roletne od tekstila; nadstrešnice; trake za vezivanje i uvijanje koje nisu od metala; cirade.

Klasa 24: Tekstilni materijali; platno, štof; tkanine; nadstolnjaci koji nisu od papira; pamučne tkanine; jaka pamučna tkanina za zavjese; prekrivači za krevete; prostirke za krevete; zastirači (za krevete); prekrivači za stolove koji nisu od papira; čaršavi (tekstilni); štampane pamučne tkanine; posteljine; peškiri; jastučnice; zavjese od tekstila ili plastike; draperije; mrežaste zavjese; tkanine za tekstilnu upotrebu; pletene tkanine; svilene tkanine; podmetači od tekstila; salvete od tekstila; dekorativna platna za posteljinu; tkanine od vještačke svile; tekstilni prekrivači za namještaj (nepričvršćeni); držači zavjesa od tekstilnih materijala; tkanine koje se lijepe toplotom; platna, rublje za kupatilo, izuzev odjeće; somot, pliš; zastori; zavjese za vrata; zidna tapiserija od tekstila; materijal za baršunaste rese.

Klasa 26: Čipka i vez; trake (pantljike) i gajtani; rese; baršunaste rese; kukice; kopče; kićanke (galanterija); ukrasne kićanke (pomponi); nabori, ukrasi (čipkani); rozete (galanterija); elastične trake lastiši uzice i gajtani za obrublivanje; trake za pričvršćivanje; trake za zavjese; aplikacije; aplikacije za ukrašavanje tekstilnih proizvoda koje se lijepe toplotom; dekorativni privjesci (osirn za nakit, prstenove za ključeve ili priveske za ključeve).

Klasa 27: Tapete; tekstilne tapete; tepisi, ćilimi; prekrivači za podove; neklizajuće prostirke; podmetači za tepihe; ukrasne zidne dekoracije, netekstilne; podne prostirke; otirači.

Klasa 35: Usluge veleprodaje i maloprodaje bravarskih proizvoda, malih metalnih građevinskih proizvoda, cjevčica i cijevi od metala, metalnih cijevi za zavjese, metalnih garnišni, aluminijumskih profila, aluminijumskih lančića, sitnih djelova od aluminijuma i drugih metala, aluminijumskih poklopaca, prozorskih roletni od metala, garnišni od PVC-a, plastičnih sitnih djelova, plastičnih lančića, plastičnih poklopaca, tekstilnih roletni za prozore, držača za zavjese od tekstila, mebl štofova, prekrivača za krevete, stolnjaka, posteljina, jastuka, zavjesa, tapeta, tepiha, kancelarijskih stolova, kancelarijskog namještaja, namještaja, pločastih unutrašnjih roletni, šina za zavjese (garnišni), šipki za zavjese, kukica za zavjese, alki za zavjese, šnala i traka za držanje zavjesa, unutrašnjih prozorskih roletni (namještaj), unutrašnjih prozorskih zastora (namještaj), držača zavjesa koji nisu od tekstila, jorgana, dekorativnih jastučića, klizača za garnišne, dekorativnih zavjesa od pedi, zavjesa od bambusa, pletenih roletni od drva (pokućstvo), papirnih roletni, zastora, spoljnih roletni od tekstila, nadstrešnica, traka za vezivanje i uvijanje koje nisu od metala, cirada, tekstilnih materijala, platna, štofova, tkanina, nadstolnjaka koji nisu od papira, pamučnih tkanina, jakih pamučnih tkanina za zavjese, prekrivača za krevete, prostirki za krevete, zastirača (za krevete), prekrivača za stolove koji nisu od papira, čaršava (tekstilnih), štampanih pamučnih tkanina, posteljina, peškira, jastučnica, zavjesa od tekstila ili plastike, draperija, mrežastih zavjesa, tkanina za tekstilnu upotrebu,

pletenih tkanina, svilenih tkanina, podmetača od tekstila, salveta od tekstila, dekorativnih platna za posteljinu, tkanina od vještačke svile, tekstilnih prekrivača za namještaj (nepričvršćenih), tkanina koje se lijepe toplotom, platna, rublja za kupatilo, izuzev odjeće, somota, pliša, zastora, zavjesa za vrata, zidnih tapiserija od tekstila, materijala za baršunaste rese, čipke i veza, traka (pantljička) i gajtana, resa, baršunastih resa, kukica, kopči, kičanki (galanterija), ukrasnih kičanki (pomponi), nabora, ukrasa (čipkanih), rozeta (galanterija), elastičnih traka, lastiša, uzica i gajtana za obrublivanje, traka za pričvršćivanje, traka za zavjese, aplikacija, aplikacija za ukrašavanje tekstilnih proizvoda koje se lijepe toplotom, dekorativnih privezaka (osim za nakit, prstenove za ključeve ili priveske za ključeve), tekstilnih tapeta, ćilima, prekrivača za podove, neklizajućih prostirki, podmetača za tepihe, ukrasnih zidnih dekoracija, netekstilnih, podnih prostirki, otirača.

Klasa 42: Usluge opremanja i dizajna enterijera, naime usluge opremanja i uređenja stanova, kuća, restorana, kafića, hotela i drugih objekata.

(210) Ž-2019-62

(220) 20.02.2019.

(731) CRIB & BEER D.O.O. PODGORICA, Njegoševa br.34, 81000, Podgorica, ME



(540)

(550) I

(740) Dragan S. Nikolić, Veliše Mugoše I/9, Podgorica, ME;

(511) Klasa 16: Ambalaža (kartonska ili papirnata za boce); boce (kartonska ili papirna ambalaža za boce); boce (kartonski ili papirni omoti za boce); boce (papirni podmetači za boce); brošure; časopisi (periodični); časopisi (revije); čestitke fascikle (kancelarijski pribor); fascikle (papirni proizvodi); fascikle za papir fotografije (štampane); kalendari (godišnjaci); kalendari kojima se listovi trgaju; katalogi knjige (oznake za stranice u knjigama); knjige sa pjesmama letci, flajeri; naljepnice, štamparski blokovi; novine; novine sa stripovima; olovke; omotači za boce, papirnati ili kartonski; pakovanje hrane (folije od papira ili plastike za održavanje vlage, za pakovanje hrane); pivske čaše (podmetači za pivske čaše); plakati (papirnat ili kartonske podloge za plakate); plakati (poster); plakati, papirni ili kartonski; salvete od papira za stolove; slikarska platna; slikarske četkice; slikarski stalci; slike; stripovi (novine sa stripovima); sveske za pisanje i crtanje; vrećice (omotnice, džepovi) od papira ili plastike za ambalažu.

Klasa 41: Dekor za priredbe (iznajmljivanje dekora za priredbe); digitalne slike (usluge digitalnog snimanja); disk džokeji (usluge disk džokeja) usluge; diskoteke (usluge diskoteka); elektronske publikacije (iskorištavanje elektronskih publikacija koje se ne mogu prenositi on-line); filmovi (prikazivanje igranih filmova); filmovi (proizvodnja filmova); fotografisanje; fotografske reportaže; igre za novac; informacije o obrazovanju; informacije o razonodi; informacije u vezi rekreacije; izdavanje knjiga; izložbe (organizovanje izložbi) u kulturne ili obrazovne svrhe; iznajmljivanje audio uređaja; iznajmljivanje dekora za priredbe; iznajmljivanje igrački; iznajmljivanje kinematografskih filmova; iznajmljivanje videokamera; iznajmljivanje videotraka; iznajmljivanje zvučnih snimaka; klubovi (usluge klubova) [zabava ili obrazovanje]; knjige (izdavanje knjiga); knjige (posuđivanje knjiga); komponovanje muzike; komponovanje muzike (usluge komponovanja muzike); koncerti (organizovanje i vođenje koncerata); konferencije (organizovanje i vođenje konferencija); kongresi (organizovanje i vođenje kongresa); modne revije za zabavne svrhe (organizovanje); montaža radio i televizijskih programa; muzejske usluge [predstavljanje, izložbe]; muzičke sale; noćni klubovi; objavljivanje knjiga i časopisa, elektronski on line; objavljivanje tekstova [osim u

reklamne svrhe]; obrazovanje (informacije o obrazovanju); obrazovanje [obuka]; obuka; obuka [predavanje]; obuka putem dopisivanja; organizovanje i vođenje koncerata; organizovanje i vođenje konferencija; organizovanje i vođenje kongresa; organizovanje i vođenje radionica za stručno osposobljavanje; organizovanje i vođenje razgovora; organizovanje i vođenje seminara; organizovanje izložba u kulturne i obrazovne svrhe; organizovanje javnih konkursa [obrazovanje ili razonoda]; organizovanje konkursa ljepote; organizovanje plesova; organizovanje spektakla [usluge impresarija]; organizovanje sportskih takmičenja; orkestri (usluge orkestra); pisanje tekstova [ne u reklamne svrhe]; planiranje prijema [razonoda]; posuđivanje knjiga; pozorišne predstave; pozorišni dekor (iznajmljivanje pozorišnog dekora); pozorišni glumci (usluge pozorišnih glumaca); pozorišni preduzetnici [impresariji] (usluge pozorišnih preduzetnika); prijemi (planiranje prijema) [razonoda]; priredbe (iznajmljivanje dekora za priredbe); priredbe (održavanje priredbi); priredbe (organizovanje priredbi) [usluge impresarija]; priredbe (proizvodnja priredbi); proizvodnja filmova; proizvodnja filmova na videotrakama; proizvodnja muzike; putujuće biblioteke (usluge putujućih biblioteka); radio televizijski programi (montaža radio televizijskih programa); radioaparati i televizori (iznajmljivanje radioaparata i televizora); razgovori (organizovanje i vođenje razgovora); razonoda; razonoda (informacije u vezi razonode); razonoda posredstvom radija; razonoda posredstvom televizije; rekreacija (obavještenja u vezi rekreacije); reportaže (fotografske reportaže); reporterske usluge; rezervisanje mjesta za priredbe; scenarijumi (izrada scenarijuma); seminari (organizovanje i vođenje seminara); simpozijumi (organizacija i vođenje simpozijuma); simpozijumi (organizovanje i vođenje simpozijuma); slobodno vrijeme (usluge za ispunjavanje slobodnog vremena); snimanje na videotrake; sportska takmičenja (organizovanje sportskih takmičenja); sportska usavršavanja (sportski kampovi za usavršavanje u sportu); sportska oprema (iznajmljivanje sportske opreme osim vozila); studio za snimanje (usluge studija za snimanje); tekstovi (objavljivanje tekstova) [osim u reklamne svrhe]; tekstovi (sastavljanje tekstova) [ne u reklamne svrhe]; televizija (razonoda na televiziji); televizijski programi (montaža radio i televizijskih programa); televizori (iznajmljivanje televizora i radioaparata); titlovanje filmova; ulaznice za priredbe (agencije za ulaznice za priredbe) [razonoda]; videotrake (iznajmljivanje videotraka); videotrake (montaža videotraka); videotrake (proizvodnja filmova na videotrakama); videotrake (snimanje na videotrake); zabavni parkovi [cirkusi]; zdravstveni klubovi (usluge zdravstvenih klubova) [održavanje zdravlja i fizičke forme]; zvučni snimci (iznajmljivanje zvučnih snimaka).

Klasa 43: Agencije za smještaj [hotelski, pansionski]; barovi (usluge barova); hotelske rezervacije (usluge rezervisanja hotela); hotelske usluge; iznajmljivanje aparata za kuvanje iznajmljivanje privremenog smještaja; iznajmljivanje sala, dvorana za sastanke; iznajmljivanje stolaca, stolova, stolnog rublja i staklenog posuđa; kafane [kafeterije]; kafane; restorani; kantine; ljetovališta; ljetovanje (usluge kampova za ljetovanje); moteli (usluge motela); pansion za životinje; pansioni; pansioni (rezervisanje pansiona); privremeni smještaj (rezervisanje privremenog smještaja); restorani; restorani sa samoposluživanjem; restorani za brzo i stalno posluživanje [snek- barovi]; rezervisanje hotela; rezervisanje pansiona; rezervisanje privremenog smještaja; smještaj (agencije za izdavanje smještaja) [hoteli, pansioni]; smještaj (iznajmljivanje privremenog smještaja); ugostitelji (usluge kateringa).

(210) Ž-2019-100

(220) 13.03.2019.

(731) Al-Furat For Tobacco and Cigarettes Industry Co., Al-Basrah Street, Jabal Amman, 5th Circle, P.O. Box 941936, 11194, Amman, JO

(540) ELEGANCE

(550) I

(740) Luka Stijepović, Bulevar Svetog Petra Cetinjskog 130/VII, 81000, Podgorica, ME

(511) Klasa 34: Duvan, sirov ili prerađen; duvanski proizvodi uključujući cigarete, cigare, cigarilosi, duvan za motanje, duvan za lule, duvan za žvakanje, cigarete koje sadrže zamjenu duvana, koje nisu za medicinsku upotrebu; aromatizovani duvan; melasa (zamjena za duvan); burmut; elektronske cigarete; elektronske nargile; glava za elektronske nargile; upaljači za cigarete; artikli za pušače uključujući upijajući papir za duvanske lule, kutije za cigarete (tabakere), sekači za cigare, držači cigara, rezervoari gasa za upaljače, filteri za cigarete, muštikle, usnici za mustikle, papir za cigarete, usnici za cigarete, džepne mašine za uvijanje cigareta, kremen, humidori (kutije za čuvanje cigara), čistači za duvanske lule, stalci za lule, kese za duvan, kutije za burmut, pljuvaonice za pušače, usnici od žutog ćilibara za muštikle, posude za duvan, pepeljare za pušače, tube za cigarete; bilje za pušenje; šibice; kutije za šibice; držači za šibice; duvan za nargile; duvan melasa; supstance za pušenje (koje nisu za medicinsku ili lekovitu upotrebu); aromatizovane mješavine duvana i melase za upotrebu u nargilama; aromatizovane tečnosti i rastvorljivi praškovi za upotrebu u nargilama; elektronske lule; tečnost za elektronsku nargilu sadržana od aroma u tečnom obliku za punjenje električnih nargila ili kertridža za elektronsku nargilu; nargile (šiša); pribor ili djelovi za nargile (uključujući ugalj za nargilu, činije i glave od nargile, cijevi za nargilu, podloge za nargilu, usnici i filteri za nargilu, drške od nargile, torbe i kutije za nargilu, posude od nargile).

(210) Ž-2019-118

(220) 22.03.2019.

(731) EVEREST S.A., of Athens International Airport "Eleftherios Venizelos" Building 14B, 19019, Spata, Attica, GR

(540) **everest**

(550) I

(740) Jasna Jusić, Dalmatinska 2, 81000, Podgorica, ME

(511) Klasa 29: Meso, riba, živina i divljač; mesni ekstrakti; konzervirano, sušeno i kuvano voće i povrće; želei, džemovi, kompoti; jaja; mlijeko i mliječni proizvodi; jestiva ulja i masti.

Klasa 30: Kafa, čaj, kakao i zamjena kafe; pirinač; tapioka i sago; brašno i proizvodi od žitarica; hleb, peciva i konditorski proizvodi; sladoledi; šećer, med, melasa; kvasac, prašak za pecivo; so; senf; sirće, sosovi (dodaci jelu); začini; led.

Klasa 32: Pivo, mineralne i gazirane vade te ostala bezalkoholna pića; voćni napici i voćni sokovi; sirupi i ostali preparati za pripremanje napitaka.

Klasa 35: Oglašavanje; poslovno upravljanje; poslovna administracija; kancelarijski poslovi.

Klasa 39: Usluge dostave hrane.

Klasa 43: Usluge obezbjeđivanja hrane i pića, usluge hrane za ponijeti.

(210) Ž-2019-119

(220) 25.03.2019.

(731) CMM DOO, Jadranski put bb, Budva, ME



(540)

(550) I

(511) Klasa 36: Upravljanje nekretninama (usluge administriranja zgradama, to jest usluge iznajmljivanja, procjene nekretnina ili usluge finansiranja; usluge posrednika za poslove s vrijednosnim papirima i dobrima).

Klasa 37: Izgradnja (usluge izgradnje zgrada, puteva, mostova, brana, dalekovoda kao i usluge specijalizovanih preduzeća u području izgradnje, kao sto su moleri, limari, postavljači centralnog grijanja i pokrivači krovova; dodatne građevinske usluge kao što je nadziranje građevinskih projekata); popravke (popravke, to jest usluge obnavljanja bilo kojeg dotrajalog, oštećenog ili djelimično razrušenog objekta (prenamjena ili obnavljanje zgrada ili nekog drugog objekta čije prvobitno stanje ne zadovoljava); razne vrste popravaka u području elektrike, pokretnina, mašina, alata itd.; usluge održavanja kojima je cilj dovođenje objekta u njegovo prvobitno stanje bez promjene bilo kojeg njegovog svojstva.

Klasa 39: Prevoz (usluge iznajmljivanja prevoznih sredstava).

Klasa 43: Privremeno primanje na stan (usluge rezervisanja smještaja za putnike, koje pružaju putničke agencije ili posrednici).

Klasa 45: Pravne usluge; sigurnosne usluge za zaštitu imovine i lica (usluge koje pružaju pravnici pojedincima ili grupama pojedinaca, organizacijama ili preduzećima).

(210) Ž-2019-131

(220) 26.03.2019.

(731) PFIZER INC., 235 East 42nd Street, 10017, New York, New York, US

(540) LORVIQUA

(550) I

(740) Jasna Jusić, Dalmatinska 2, 81000, Podgorica, ME

(511) Klasa 5: Farmaceutski, medicinski i veterinarski preparati; sanitarni preparati za medicinske svrhe; dijetetska hrana i supstance za medicinsku ili veterinarsku upotrebu, hrana za bebe; dijetetski suplementi za ljude i životinje; flasteri, materijali za zavijanje; materijal za plombiranje zuba, zubarska smola; dezinfekciona sredstva; preparati za uništavanje štetočina; fungicidi, herbicidi.

(210) Ž-2019-132

(220) 26.03.2019.

(731) PFIZER INC., 235 East 42nd Street, 10017, New York, New York, US

(540) LORBRENA

(550) I

(740) Jasna Jusić, Dalmatinska 2, 81000, Podgorica, ME

(511) Klasa 5: Farmaceutski, medicinski i veterinarski preparati; sanitarni preparati za medicinske svrhe; dijetetska hrana i supstance za medicinsku ili veterinarsku upotrebu, hrana za bebe; dijetetski suplementi za ljude i životinje; flasteri, materijali za zavijanje; materijal za plombiranje zuba, zubarska smola; dezinfekciona sredstva; preparati za uništavanje štetočina; fungicidi, herbicidi.

(210) Ž-2019-135

(220) 28.03.2019.

(731) Bosnalijek, farmaceutska i hemijska industrija, dionicko drustvo, Jukićeva 53, 71000, Sarajevo, BA

(540) LYNASE

(550) I

(740) Božidar S. Radulović, Studentska bb, Lamela 3/18, 81000, Podgorica, ME

(511) Klasa 5: Farmaceutski proizvodi.

(210) Ž-2019-137

(220) 01.04.2019.

(731) ADP, LLC, One ADP Boulevard, 07068, Roseland, New Jersey, US

(540) ADP

(550) I

(740) Jasna Jusić, Dalmatinska 2, 81000, Podgorica, ME

(511) Klasa 9: Kompjuterski softver, uključujući kompjuterski softver za korištenje u poslovnom menadžmentu, računovodstvu, obračunu plata, upravljanju naknadama za nezaposlene, vođenju evidencije o radnom vremenu i vremenu koje zaposleni provedu na radnom mjestu, ustupanju zaposlenih, elektronskoj trgovini, upravljanju ljudskim resursima i talentima, administriranju primanja zaposlenih i penzionim planom, zdravstvenom osiguranju i osiguranju radnika, u finansijskom upravljanju i upravljanju podacima; kompjuterski hardver, uključujući kompjuterski hardver za zaposlene da ga koriste u poslovnom menadžmentu, računovodstvu, obračunu plata, upravljanju naknadama za nezaposlene, vođenju evidencije o radnom vremenu i vremenu koje zaposleni provedu na radnom mjestu, ustupanju zaposlenih, elektronskoj trgovini, upravljanju ljudskim resursima i talentima, administriranju primanja zaposlenih i penzionim planom, zdravstvenom osiguranju i osiguranju radnika, u finansijskom upravljanju i upravljanju podacima; elektronske publikacije, podkasti, video i multimedijalno programiranje, koji se mogu preuzimati, u oblasti poslovnog menadžmenta, računovodstva, obračuna plata, upravljanja naknadama za nezaposlene, vođenja evidencije o radnom vremenu i vremenu koje zaposleni provedu na radnom mjestu, ustupanja zaposlenih, elektronskoj trgovini, upravljanja ljudskim resursima i talentima, administriranja primanja zaposlenih i penzionog plana, zdravstvenog osiguranja i osiguranja radnika, finansijskog upravljanja i upravljanja podacima.

Klasa 35: Biznis i analiza ljudskih resursa, konsultacije, informacije, upravljanje, planiranje i istraživanje; usluge konsaltinga u oblasti zapošljavanja, angažovanja, provjere radnog iskustva, upravljanja učinkom, upravljanja naknadama i upravljanja sukcesijom; usluge konsaltinga i evidencije u oblasti raspoređivanja zaposlenih, radnog vremena zaposlenih, prisutnosti zaposlenih na radnom mjestu, odmora i bolovanja zaposlenih; usluge evidencije platnih spiskova, obrade, isplate, administriranja i upravljanja; usluge obrade podataka; usluge anketiranja, istraživanja

i revizije u vezi sa ljudskim resursima i osobljem; usluge evidencije, administriranja i upravljanja primanjima zaposlenih i naknadama za nezaposlene; obezbjeđivanje veb-sajta, onlajn baze podataka i internet portala u oblasti biznisa, ljudskih resursa, platnih spiskova, primanja zaposlenih, naknada za nezaposlene, zapošljavanja, angažovanja, upravljanja učinkom, naknada i sukcesije i u oblasti raspoređivanja zaposlenih, radnog vremena zaposlenih, prisutnosti zaposlenih na radnom mjestu, odmora i bolovanja zaposlenih; usluge davanja informacija i savjeta u vezi sa gorenavedenim uslugama.

Klasa 36: Usluge konsaltinga u vezi osiguranja, istraživanja, informisanja, planiranja, upravljanja i administriranja; usluge finansijskog konsaltinga, istraživanja, informisanja, planiranja, upravljanja, administriranja i izvještavanja; pružanje konsultantskih, računarskih i usluga davanja podataka zaposlenima

u oblasti naplate i poštovanja poreskih obaveza na dohodak, administriranja finansijskih naknada, administriranja zahtjeva radnika za isplatu naknada; administriranja penzionih fondova zaposlenih; obezbjeđivanje vebajta, onlajn baze podataka i internet portala u oblasti osiguranja, finansijskih poslova i penzionih fondova.

Klasa 41: Usluge obrazovanja i usavršavanja, uključujući usluge obrazovanja i usavršavanja u oblasti poslovnog menadžmenta, računovodstva, obračuna plata, upravljanja naknadama za nezaposlene, vođenja evidencije o radnom vremenu i vremenu koje zaposleni provedu na radnom mjestu, ustupanja zaposlenih, elektronske trgovine, upravljanja ljudskim resursima i talentima, administriranja primanja zaposlenih i penzionog plana, zdravstvenog osiguranja i osiguranja radnika, finansijskog upravljanja i upravljanja podacima, administriranja platnim spiskovima, postovanja poreskih obaveza, vođenja evidencije o radnom vremenu i vremenu provedenom na radnom mjestu, administriranja naknada, ustupanja radnika i usavršavanja radnika; ugovaranje, organizovanje, sprovođenje i prezentacija seminara, radionica, časova, vebinara, konferencija, onlajn instrukcija i programa učenja na daljinu; objavljivanje knjiga i časopisa; obezbjeđivanje onlajn elektronskih publikacija, podkasta koji se ne mogu preuzimati i multimedijalnog programiranja u oblasti poslovnog menadžmenta, računovodstva, obračuna plata, upravljanja naknadama za nezaposlene, vođenja evidencije o radnom vremenu i vremenu koje zaposleni provedu na radnom mjestu, ustupanja zaposlenih, elektronske trgovine, upravljanja ljudskim resursima i talentima, administriranja primanja i penzionog plana zaposlenih, zdravstvenog osiguranja i osiguranja radnika, finansijskog upravljanja i upravljanja podacima, administriranja platnih spiskova, poštovanja poreskih obaveza, vođenja evidencije o radnom vremenu i vremenu provedenom na radnom mjestu, administriranja naknada, ustupanja radnika i usavršavanja radnika.

Klasa 42: Dizajn i izrada kompjuterskog hardvera i softvera; ažuriranje, iznajmljivanje, održavanje i implementacija kompjuterskog softvera; usluge podrške kompjuterskom softveru; obezbjeđivanje privremenog korištenja kompjuterskog softvera koji se ne može preuzimati, uključujući kompjuterski softver za korištenje u poslovnom menadžmentu, računovodstvu, obračunu plata, upravljanju naknadama za nezaposlene, vođenju evidencije o radnom vremenu i vremenu koje zaposleni provedu na radnom mjestu, ustupanju zaposlenih, elektronskoj trgovini, upravljanju ljudskim resursima i talentima, administriranju primanja i penzionog plana zaposlenih, zdravstvenom osiguranju i osiguranju radnika, u finansijskom upravljanju i upravljanju podacima; obezbjeđivanje vebajta sa tehnologijom za ljudske resurse, finansijsko upravljanje, zapošljavanje, upravljanje podacima, platne spiskove i naknade, pogodnosti i penzione planove i osiguranje; računarstvo u oblaku i onlajn usluge softvera koji se ne može preuzimati a koji se može koristiti za potrebe ljudskih resursa, finansijskog upravljanja, zapošljavanja, upravljanja podacima, platnih spiskova i naknada, pogodnosti i penzionih planova i osiguranja.

(210) Ž-2019-138

(220) 01.04.2019.

(731) ADP, LLC, One ADP Boulevard, 07068, Roseland, New Jersey, US

(540) 

(550) I

(740) Jasna Jusić, Dalmatinska 2, 81000, Podgorica, ME

(511) Klasa 9: Kompjuterski softver, uključujući kompjuterski softver za korištenje u poslovnom menadžmentu, računovodstvu, obračunu plata, upravljanju naknadama za nezaposlene, vođenju evidencije o radnom vremenu i vremenu koje zaposleni provedu na radnom mjestu, ustupanju zaposlenih,

elektronskoj trgovini, upravljanju ljudskim resursima i talentima, administriranju primanja zaposlenih i penzionim planom, zdravstvenom osiguranju i osiguranju radnika, u finansijskom upravljanju i upravljanju podacima; kompjuterski hardver, uključujući kompjuterski hardver za zaposlene da ga koriste u poslovnom menadžmentu, računovodstvu, obračunu plata, upravljanju naknadama za nezaposlene, vođenju evidencije o radnom vremenu i vremenu koje zaposleni provedu na radnom mjestu, ustupanju zaposlenih, elektronskoj trgovini, upravljanju ljudskim resursima i talentima, administriranju primanja zaposlenih i penzionim planom, zdravstvenom osiguranju i osiguranju radnika, u finansijskom upravljanju i upravljanju podacima; elektronske publikacije, podkasti, video i multimedijalno programiranje, koji se mogu preuzimati, u oblasti poslovnog menadžmenta, računovodstva, obračuna plata, upravljanja naknadama za nezaposlene, vođenja evidencije o radnom vremenu i vremenu koje zaposleni provedu na radnom mjestu, ustupanja zaposlenih, elektronskoj trgovini, upravljanja ljudskim resursima i talentima, administriranja primanja zaposlenih i penzionog plana, zdravstvenog osiguranja i osiguranja radnika, finansijskog upravljanja i upravljanja podacima.

Klasa 35: Biznis i analiza ljudskih resursa, konsultacije, informacije, upravljanje, planiranje i istraživanje; usluge konsaltinga u oblasti zapošljavanja, angažovanja, provjere radnog iskustva, upravljanja učinkom, upravljanja naknadama i upravljanja sukcesijom; usluge konsaltinga i evidencije u oblasti raspoređivanja zaposlenih, radnog vremena zaposlenih, prisutnosti zaposlenih na radnom mjestu, odmora i bolovanja zaposlenih; usluge evidencije platnih spiskova, obrade, isplate, administriranja i upravljanja; usluge obrade podataka; usluge anketiranja, istraživanja

i revizije u vezi sa ljudskim resursima i osobljem; usluge evidencije, administriranja i upravljanja primanjima zaposlenih i naknadama za nezaposlene; obezbjeđivanje vebajta, onlajn baze podataka i internet portala u oblasti biznisa, ljudskih resursa, platnih spiskova, primanja zaposlenih, naknada za nezaposlene, zapošljavanja, angažovanja, upravljanja učinkom, naknada i sukcesije i u oblasti raspoređivanja zaposlenih, radnog vremena zaposlenih, prisutnosti zaposlenih na radnom mjestu, odmora i bolovanja zaposlenih; usluge davanja informacija i savjeta u vezi sa gorenavedenim uslugama.

Klasa 36: Usluge konsaltinga u vezi osiguranja, istraživanja, informisanja, planiranja, upravljanja i administriranja; usluge finansijskog konsaltinga, istraživanja, informisanja, planiranja, upravljanja, administriranja i izvještavanja; pružanje konsultantskih, računarskih i usluga davanja podataka zaposlenima u oblasti naplate i poštovanja poreskih obaveza na dohodak, administriranja finansijskih naknada, administriranja zahtjeva radnika za isplatu naknada; administriranja penzionih fondova zaposlenih; obezbjeđivanje vebajta, onlajn baze podataka i internet portala u oblasti osiguranja, finansijskih poslova i penzionih fondova.

Klasa 41: Usluge obrazovanja i usavršavanja, uključujući usluge obrazovanja i usavršavanja u oblasti poslovnog menadžmenta, računovodstva, obračuna plata, upravljanja naknadama za nezaposlene, vođenja evidencije o radnom vremenu i vremenu koje zaposleni provedu na radnom mjestu, ustupanja zaposlenih, elektronske trgovine, upravljanja ljudskim resursima i talentima, administriranja primanja zaposlenih i penzionog plana, zdravstvenog osiguranja i osiguranja radnika, finansijskog upravljanja i upravljanja podacima, administriranja platnim spiskovima, postovanja poreskih obaveza, vođenja evidencije o radnom vremenu i vremenu provedenom na radnom mjestu, administriranja naknada, ustupanja radnika i usavršavanja radnika; ugovaranje, organizovanje, sprovođenje i prezentacija seminara, radionica, časova, vebinara, konferencija, onlajn instrukcija i programa učenja na daljinu; objavljivanje knjiga i časopisa; obezbjeđivanje onlajn elektronskih publikacija, podkasta koji se ne mogu preuzimati i multimedijalnog programiranja u oblasti poslovnog menadžmenta, računovodstva, obračuna plata, upravljanja naknadama za nezaposlene, vođenja evidencije o radnom vremenu i vremenu koje zaposleni provedu na radnom mjestu, ustupanja zaposlenih, elektronske trgovine, upravljanja ljudskim resursima i talentima, administriranja primanja i penzionog plana zaposlenih, zdravstvenog osiguranja i osiguranja radnika,

finansijskog upravljanja i upravljanja podacima, administriranja platnih spiskova, poštovanja poreskih obaveza, vođenja evidencije o radnom vremenu i vremenu provedenom na radnom mjestu, administriranja naknada, ustupanja radnika i usavršavanja radnika.

Klasa 42: Dizajn i izrada kompjuterskog hardvera i softvera; ažuriranje, iznajmljivanje, održavanje i implementacija kompjuterskog softvera; usluge podrške kompjuterskom softveru; obezbjeđivanje privremenog korištenja kompjuterskog softvera koji se ne može preuzimati, uključujući kompjuterski softver za korištenje u poslovnom menadžmentu, računovodstvu, obračunu plata, upravljanju naknadama za nezaposlene, vođenju evidencije o radnom vremenu i vremenu koje zaposleni provedu na radnom mjestu, ustupanju zaposlenih, elektronskoj trgovini, upravljanju ljudskim resursima i talentima, administriranju primanja i penzionog plana zaposlenih, zdravstvenom osiguranju i osiguranju radnika, u finansijskom upravljanju i upravljanju podacima; obezbjeđivanje vebajta sa tehnologijom za ljudske resurse, finansijsko upravljanje, zapošljavanje, upravljanje podacima, platne spiskove i naknade, pogodnosti i penzione planove i osiguranje; računarstvo u oblaku i onlajn usluge softvera koji se ne može preuzimati a koji se može koristiti za potrebe ljudskih resursa, finansijskog upravljanja, zapošljavanja, upravljanja podacima, platnih spiskova i naknada, pogodnosti i penzionih planova i osiguranja.

(210) Ž-2019-139

(220) 01.04.2019.

(731) ADP, LLC, One ADP Boulevard, 07068, Roseland, New Jersey, US

(540) ALWAYS DESIGNING FOR PEOPLE

(550) I

(740) Jasna Jusić, Dalmatinska 2, 81000, Podgorica, ME

(511) Klasa 9: Kompjuterski softver, uključujući kompjuterski softver za korištenje u poslovnom menadžmentu, računovodstvu, obračunu plata, upravljanju naknadama za nezaposlene, vođenju evidencije o radnom vremenu i vremenu koje zaposleni provedu na radnom mjestu, ustupanju zaposlenih, elektronskoj trgovini, upravljanju ljudskim resursima i talentima, administriranju primanja zaposlenih i penzionim planom, zdravstvenom osiguranju i osiguranju radnika, u finansijskom upravljanju i upravljanju podacima; kompjuterski hardver, uključujući kompjuterski hardver za zaposlene da ga koriste u poslovnom menadžmentu, računovodstvu, obračunu plata, upravljanju naknadama za nezaposlene, vođenju evidencije o radnom vremenu i vremenu koje zaposleni provedu na radnom mjestu, ustupanju zaposlenih, elektronskoj trgovini, upravljanju ljudskim resursima i talentima, administriranju primanja zaposlenih i penzionim planom, zdravstvenom osiguranju i osiguranju radnika, u finansijskom upravljanju i upravljanju podacima; elektronske publikacije, podkasti, video i multimedijalno programiranje, koji se mogu preuzimati, u oblasti poslovnog menadžmenta, računovodstva, obračuna plata, upravljanja naknadama za nezaposlene, vođenja evidencije o radnom vremenu i vremenu koje zaposleni provedu na radnom mjestu, ustupanja zaposlenih, elektronskoj trgovini, upravljanja ljudskim resursima i talentima, administriranja primanja zaposlenih i penzionog plana, zdravstvenog osiguranja i osiguranja radnika, finansijskog upravljanja i upravljanja podacima.

Klasa 35: Biznis i analiza ljudskih resursa, konsultacije, informacije, upravljanje, planiranje i istraživanje; usluge konsaltinga u oblasti zapošljavanja, angažovanja, provjere radnog iskustva, upravljanja učinkom, upravljanja naknadama i upravljanja sukcesijom; usluge konsaltinga i evidencije u oblasti raspoređivanja zaposlenih, radnog vremena zaposlenih, prisutnosti zaposlenih na radnom mjestu, odmora i bolovanja zaposlenih; usluge evidencije platnih spiskova, obrade, isplate, administriranja i upravljanja; usluge obrade podataka; usluge anketiranja, istraživanja

i revizije u vezi sa ljudskim resursima i osobljem; usluge evidencije, administriranja i upravljanja primanjima zaposlenih i naknadama za nezaposlene; obezbjeđivanje vebajta, onlajn baze podataka i internet portala u oblasti biznisa, ljudskih resursa, platnih spiskova, primanja zaposlenih, naknada za nezaposlene, zapošljavanja, angažovanja, upravljanja učinkom, naknada i sukcesije i u oblasti raspoređivanja zaposlenih, radnog vremena zaposlenih, prisutnosti zaposlenih na radnom mjestu, odmora i bolovanja zaposlenih; usluge davanja informacija i savjeta u vezi sa gorenavedenim uslugama.

Klasa 36: Usluge konsaltinga u vezi osiguranja, istraživanja, informisanja, planiranja, upravljanja i administriranja; usluge finansijskog konsaltinga, istraživanja, informisanja, planiranja, upravljanja, administriranja i izvještavanja; pružanje konsultantskih, računarskih i usluga davanja podataka zaposlenima u oblasti naplate i poštovanja poreskih obaveza na dohodak, administriranja finansijskih naknada, administriranja zahtjeva radnika za isplatu naknada; administriranja penzionih fondova zaposlenih; obezbjeđivanje vebajta, onlajn baze podataka i internet portala u oblasti osiguranja, finansijskih poslova i penzionih fondova.

Klasa 41: Usluge obrazovanja i usavršavanja, uključujući usluge obrazovanja i usavršavanja u oblasti poslovnog menadžmenta, računovodstva, obračuna plata, upravljanja naknadama za nezaposlene, vođenja evidencije o radnom vremenu i vremenu koje zaposleni provedu na radnom mjestu, ustupanja zaposlenih, elektronske trgovine, upravljanja ljudskim resursima i talentima, administriranja primanja zaposlenih i penzionog plana, zdravstvenog osiguranja i osiguranja radnika, finansijskog upravljanja i upravljanja podacima, administriranja platnim spiskovima, postovanja poreskih obaveza, vođenja evidencije o radnom vremenu i vremenu provedenom na radnom mjestu, administriranja naknada, ustupanja radnika i usavršavanja radnika; ugovaranje, organizovanje, sprovođenje i prezentacija seminara, radionica, časova, vebinara, konferencija, onlajn instrukcija i programa učenja na daljinu; objavljivanje knjiga i časopisa; obezbjeđivanje onlajn elektronskih publikacija, podkasta koji se ne mogu preuzimati i multimedijalnog programiranja u oblasti poslovnog menadžmenta, računovodstva, obračuna plata, upravljanja naknadama za nezaposlene, vođenja evidencije o radnom vremenu i vremenu koje zaposleni provedu na radnom mjestu, ustupanja zaposlenih, elektronske trgovine, upravljanja ljudskim resursima i talentima, administriranja primanja i penzionog plana zaposlenih, zdravstvenog osiguranja i osiguranja radnika, finansijskog upravljanja i upravljanja podacima, administriranja platnih spiskova, poštovanja poreskih obaveza, vođenja evidencije o radnom vremenu i vremenu provedenom na radnom mjestu, administriranja naknada, ustupanja radnika i usavršavanja radnika.

Klasa 42: Dizajn i izrada kompjuterskog hardvera i softvera; ažuriranje, iznajmljivanje, održavanje i implementacija kompjuterskog softvera; usluge podrške kompjuterskom softveru; obezbjeđivanje privremenog korištenja kompjuterskog softvera koji se ne može preuzimati, uključujući kompjuterski softver za korištenje u poslovnom menadžmentu, računovodstvu, obračunu plata, upravljanju naknadama za nezaposlene, vođenju evidencije o radnom vremenu i vremenu koje zaposleni provedu na radnom mjestu, ustupanju zaposlenih, elektronskoj trgovini, upravljanju ljudskim resursima i talentima, administriranju primanja i penzionog plana zaposlenih, zdravstvenom osiguranju i osiguranju radnika, u finansijskom upravljanju i upravljanju podacima; obezbjeđivanje vebajta sa tehnologijom za ljudske resurse, finansijsko upravljanje, zapošljavanje, upravljanje podacima, platne spiskove i naknade, pogodnosti i penzione planove i osiguranje; računarstvo u oblaku i onlajn usluge softvera koji se ne može preuzimati a koji se može koristiti za potrebe ljudskih resursa, finansijskog upravljanja, zapošljavanja, upravljanja podacima, platnih spiskova i naknada, pogodnosti i penzionih planova i osiguranja.

(210) Ž-2019-140

(220) 01.04.2019.

(731) ADP, LLC, One ADP Boulevard, 07068, Roseland, New Jersey, US



(540)

(550) I

(740) Jasna Jusić, Dalmatinska 2, 81000, Podgorica, ME

(511) Klasa 9: Kompjuterski softver, uključujući kompjuterski softver za korištenje u poslovnom menadžmentu, računovodstvu, obračunu plata, upravljanju naknadama za nezaposlene, vođenju evidencije o radnom vremenu i vremenu koje zaposleni provedu na radnom mjestu, ustupanju zaposlenih, elektronskoj trgovini, upravljanju ljudskim resursima i talentima, administriranju primanja zaposlenih i penzionim planom, zdravstvenom osiguranju i osiguranju radnika, u finansijskom upravljanju i upravljanju podacima; kompjuterski hardver, uključujući kompjuterski hardver za zaposlene da ga koriste u poslovnom menadžmentu, računovodstvu, obračunu plata, upravljanju naknadama za nezaposlene, vođenju evidencije o radnom vremenu i vremenu koje zaposleni provedu na radnom mjestu, ustupanju zaposlenih, elektronskoj trgovini, upravljanju ljudskim resursima i talentima, administriranju primanja zaposlenih i penzionim planom, zdravstvenom osiguranju i osiguranju radnika, u finansijskom upravljanju i upravljanju podacima; elektronske publikacije, podkasti, video i multimedijalno programiranje, koji se mogu preuzimati, u oblasti poslovnog menadžmenta, računovodstva, obračuna plata, upravljanja naknadama za nezaposlene, vođenja evidencije o radnom vremenu i vremenu koje zaposleni provedu na radnom mjestu, ustupanja zaposlenih, elektronskoj trgovini, upravljanja ljudskim resursima i talentima, administriranja primanja zaposlenih i penzionog plana, zdravstvenog osiguranja i osiguranja radnika, finansijskog upravljanja i upravljanja podacima.

Klasa 35: Usluge konsaltinga u oblasti zapošljavanja, angažovanja, provjere radnog iskustva, upravljanja učinkom, upravljanja naknadama i upravljanja sukcesijom; usluge konsaltinga i evidencije u oblasti raspoređivanja zaposlenih, radnog vremena zaposlenih, prisutnosti zaposlenih na radnom mjestu, odmora i bolovanja zaposlenih; usluge evidencije platnih spiskova, obrade, isplate, administriranja i upravljanja; usluge obrade podataka; usluge anketiranja, istraživanja i revizije u vezi sa ljudskim resursima i osobljem; usluge evidencije, administriranja i upravljanja primanjima zaposlenih i naknadama za nezaposlene; obezbjeđivanje vebajta, onlajn baze podataka i internet portala u oblasti biznisa, ljudskih resursa, platnih spiskova, primanja zaposlenih, naknada za nezaposlene, zapošljavanja, angažovanja, upravljanja učinkom, naknada i sukcesije i u oblasti raspoređivanja zaposlenih, radnog vremena zaposlenih, prisutnosti zaposlenih na radnom mjestu, odmora i bolovanja zaposlenih; usluge davanja informacija i savjeta u vezi sa gorenavedenim uslugama.

Klasa 36: Usluge konsaltinga u vezi osiguranja, istraživanja, informisanja, planiranja, upravljanja i administriranja; usluge finansijskog konsaltinga, istraživanja, informisanja, planiranja, upravljanja, administriranja i izvještavanja; pružanje konsultantskih, računarskih i usluga davanja podataka zaposlenima u oblasti naplate i poštovanja poreskih obaveza na dohodak, administriranja finansijskih naknada, administriranja zahtjeva radnika za isplatu naknada; administriranja penzionih fondova zaposlenih; obezbjeđivanje vebajta, onlajn baze podataka i internet portala u oblasti osiguranja, finansijskih poslova i penzionih fondova.

Klasa 41: Usluge obrazovanja i usavršavanja, uključujući usluge obrazovanja i usavršavanja u oblasti poslovnog menadžmenta, računovodstva, obračuna plata, upravljanja naknadama za nezaposlene, vođenja evidencije o radnom vremenu i vremenu koje zaposleni provedu na radnom mjestu, ustupanja zaposlenih, elektronske trgovine, upravljanja ljudskim resursima i talentima, administriranja primanja zaposlenih i penzionog plana, zdravstvenog osiguranja i osiguranja radnika, finansijskog upravljanja i upravljanja

podacima, administriranja platnim spiskovima, postovanja poreskih obaveza, vođenja evidencije o radnom vremenu i vremenu provedenom na radnom mjestu, administriranja naknada, ustupanja radnika i usavršavanja radnika; ugovaranje, organizovanje, sprovođenje i prezentacija seminara, radionica, časova, vebinara, konferencija, onlajn instrukcija i programa učenja na daljinu; objavljivanje knjiga i časopisa; obezbjeđivanje onlajn elektronskih publikacija, podkasta koji se ne mogu preuzimati i multimedijalnog programiranja u oblasti poslovnog menadžmenta, računovodstva, obračuna plata, upravljanja naknadama za nezaposlene, vođenja evidencije o radnom vremenu i vremenu koje zaposleni provedu na radnom mjestu, ustupanja zaposlenih, elektronske trgovine, upravljanja ljudskim resursima i talentima, administriranja primanja i penzionog plana zaposlenih, zdravstvenog osiguranja i osiguranja radnika, finansijskog upravljanja i upravljanja podacima, administriranja platnih spiskova, poštovanja poreskih obaveza, vođenja evidencije o radnom vremenu i vremenu provedenom na radnom mjestu, administriranja naknada, ustupanja radnika i usavršavanja radnika.

Klasa 42: Dizajn i izrada kompjuterskog hardvera i softvera; ažuriranje, iznajmljivanje, održavanje i implementacija kompjuterskog softvera; usluge podrške kompjuterskom softveru; obezbjeđivanje privremenog korištenja kompjuterskog softvera koji se ne može preuzimati, uključujući kompjuterski softver za korištenje u poslovnom menadžmentu, računovodstvu, obračunu plata, upravljanju naknadama za nezaposlene, vođenju evidencije o radnom vremenu i vremenu koje zaposleni provedu na radnom mjestu, ustupanju zaposlenih, elektronskoj trgovini, upravljanju ljudskim resursima i talentima, administriranju primanja i penzionog plana zaposlenih, zdravstvenom osiguranju i osiguranju radnika, u finansijskom upravljanju i upravljanju podacima; obezbjeđivanje vebajta sa tehnologijom za ljudske resurse, finansijsko upravljanje, zapošljavanje, upravljanje podacima, platne spiskove i naknade, pogodnosti i penzione planove i osiguranje; računarstvo u oblaku i onlajn usluge softvera koji se ne može preuzimati a koji se može koristiti za potrebe ljudskih resursa, finansijskog upravljanja, zapošljavanja, upravljanja podacima, platnih spiskova i naknada, pogodnosti i penzionih planova i osiguranja.

(210) Ž-2019-141

(220) 01.04.2019.

(731) AMVAC C.V., 4695 MacArthur Court, Suite 1200, CA 92660, Newport Beach, US



(540)

(550) I

(740) Jasna Jusić, Dalmatinska 2, 81000, Podgorica, ME

(511) Klasa 1: Regulatori rasta biljke i hormoni za korišćenje u poljoprivredi.

Klasa 5: Poljoprivredne hemikalije, naime, insekticidi, pesticidi, herbicidi, fungicidi, nematocidi i moluscidi za korišćenje u komercijalne svrhe, u poljoprivredi i hortikulturi.

Klasa 7: Djelovi za mehaničke poljoprivredne sisteme za raspršivanje hemikalija, naime, plastični kontejneri koji se koriste za skladištenje poljoprivredne hemikalije koja se nanosi pomoću ovog sistema; nemetalni konejneri za pesticide bez mjernog uređaja, koji se koristi sa mehaničkim raspršivačima za doziranje materijala iz kontejnera za korištenje u poljoprivredi, koji se prodaju prazni.

Klasa 9: Sistem za doziranje tečnosti koji se sastoji od nemetalnog kontejnera za pesticide sa mjernim uređajem za doziranje materijala koji se nalazi u kontejneru, za korištenje u poljoprivredi, a prodaje se prazan; kontrolni uređaj za kontrolu doziranja materijala iz sistema za doziranje pesticida i za prikaz podataka koji se odnose na to doziranje, za korištenje u poljoprivredi; elektronski sistem za doziranje pesticida koji se sastoji od jednog ili dva kontejnera i mjernog uređaja za doziranje materijala iz jednog

kontejnera, jednog kontejnera koji je prethodno napunjen pesticidom, za korištenje u poljoprivredi; elektronski sistem za doziranje za korištenje u poljoprivredi koji se sastoji od jednog ili dva kontejnera, jednog kontejnera koji je prethodno napunjen pesticidom, mjernog uređaja za doziranje materijala koji se nalazi u kontejneru, jednog ili više senzora i/ili monitora za praćenje eksternih uslova i rada sistema, kontrolnog uređaja za prikazivanje podataka i kontrolu doziranja i jednog ili više memorijskih uređaja za kalibraciju i snimanje podataka o tretmanu .

(210) Ž-2019-142

(220) 01.04.2019.

(731) AMVAC C.V., 4695 MacArthur Court, Suite 1200, CA 92660, Newport Beach, US

(540) 

(550) I

(740) Jasna Jusić, Dalmatinska 2, 81000, Podgorica, ME

(511) Klasa 1: Regulatori rasta biljke i hormoni za korišćenje u poljoprivredi.

Klasa 5: Poljoprivredne hemikalije, naime, insekticidi, pesticidi, herbicidi, fungicidi, nematocidi i moluscidi za korišćenje u komercijalne svrhe, u poljoprivredi i hortikulturi.

(210) Ž-2019-143

(220) 02.04.2019.

(731) Farmaceutsko hemijska industrija "ZDRAVLJE", akcionarsko društvo, Vlajkova 199, 16000, Leskovac, RS

(540) ATACOR

(550) I

(740) Miladin Popović, Đoka Miraševića 21/III, 81000, Podgorica, ME

(511) Klasa 5: Farmaceutski preparati za tretman i liječenje dislipidemije, hipolipemik.

(210) Ž-2019-144

(220) 03.04.2019.

(731) SAILUN GROUP CO.,LTD., No.588, Maoshan Road, Huangdao District, Qingdao City, Shandong, CN

(540) 

(550) I

(740) Dejan Raičević, Vojvode Boža br.1, 81250, Cetinje

(511) Klasa 12: Automobilske gume; Gume za točkove vozila; Gazeća površina za pneumatske gume; Pneumatske gume; Protetori guma; Unutrašnje gume za bicikle i motocikle; Unutrašnje gume za pneumatske gume; Lanci, kramponi, ekseri i šiljci za gume; Spoljni omotači pnumatskih guma; Oprema za krpjenje i reparaciju unutrašnjih guma.

(210) Ž-2019-145

(220) 03.04.2019.

(731) SAILUN GROUP CO.,LTD., No.588, Maoshan Road, Huangdao District, Qingdao City, Shandong, CN

(540) **RXMOTION**

(550) I

(740) Dejan Raičević, Vojvode Boža br.1, 81250, Cetinje

(511) Klasa 12: Automobilske gume; Gume za točkove vozila; Gazeća površina za pneumatske gume; Pneumatske gume; Protektori guma; Unutrašnje gume za bicikle i motocikle; Unutrašnje gume za pneumatske gume; Lanci, kramponi, ekseri i šiljci za gume; Spoljni omotači pneumatskih guma; Oprema za krpljenje i reparaciju unutrašnjih guma.

(210) Ž-2019-146

(220) 03.04.2019.

(731) SAILUN GROUP CO.,LTD., No.588, Maoshan Road, Huangdao District, Qingdao City, Shandong, CN

(540) **RXQUEST**

(550) I

(740) Dejan Raičević, Vojvode Boža br.1, 81250, Cetinje

(511) Klasa 12: Automobilske gume; Gume za točkove vozila; Gazeća površina za pneumatske gume; Pneumatske gume; Protektori guma; Unutrašnje gume za bicikle i motocikle; Unutrašnje gume za pneumatske gume; Lanci, kramponi, ekseri i šiljci za gume; Spoljni omotači pneumatskih guma; Oprema za krpljenje i reparaciju unutrašnjih guma.

(210) Ž-2019-147

(220) 03.04.2019.

(731) Fidanian, Olga, (Helga Twinkle-fox) Majnski put, 57, st.4, Budva, ME



(540)

(550) I

(740) Milovan Orović, Ul. Filipa Kovačevića 23, Budva, ME;

(511) Klasa 14: Dragoceni metali i njihove legure i proizvodi od dragocenih metala ili sa prevlakom od njih, koji nisu uključeni u druge klase; nakit, drago kamenje, časovničarski i hronometrijski instrumenti; dragocene metale, proizvode od dragocenih metala koji nisu uključeni u druge klase, uopšteno nakit, časovnike i satove; nakit (imitacije nakita i nakit od plemenitih metala i dragulje); dugmad za manžetne, igle za kravate; specijalizovana dizajnerska djelatnost.

Klasa 25: Odjeća, obuća, pokrivala za glavu.

Klasa 28: Igre i igračke; gimnastički i sportski predmeti koji nisu obuhvaćeni drugim klasama; ukrasi za božićne jelke; aparate za razonodu ili za igranje koncipirane za upotrebu s nezavisnim ekranom za prikazivanje ili s monitorom; pribor za pecanje; sprave za sport i zimske igre.

(210) Ž-2019-148

(220) 03.04.2019.

(731) "NEDEM" D.O.O. BUDVA, Trg Sunca br.2, Budva, ME



(540)

(550) I

(740) Milovan Orović, Filipa Kovačevića 23, Budva

(511) Klasa 14: Dragoceni metali i njihove legure i proizvodi od dragocenih metala ili sa prevlakom od njih, koji nisu uključeni u druge klase; nakit, drago kamenje, časovničarski i hronometrijski instrumenti; dragocene metale, proizvode od dragocenih metala koji nisu uključeni u druge klase, uopšteno nakit, časovnike i satove; nakit (imitacije nakita i nakit od plemenitih metala i dragulje); dugmad za manžetne, igle za kravate; specijalizovana dizajnerska djelatnost.

Klasa 25: Odjeća, obuća, pokrivala za glavu.

Klasa 35: Oglašavanje i reklamiranje; vođenje komercijalnih poslova; komercijalna administracija; kancelarijski poslovi; usluge koje pružaju lica ili organizacije, čija je glavna svrha:1) pomoć u radu i upravljanju privrednim društvima, ili 2) pomoć u vođenju poslova ili komercijalnih funkcija industrijskog ili trgovačkog preduzeća, kao i usluge reklamnih ustanova koje se bave uglavnom reklamiranjem proizvoda i usluga putem svih vrsta medija; usluge koje se odnose na registraciju, prijepis, sastavljanje, kompilaciju ili sistematizaciju pisanih saopštenja i zapisa kao i obradu ili kompilaciju matematičkih ili statističkih podataka; usluge agencija za oglašavanje kao i usluge distribuiranja prospekata direktno ili poštom ili distribuiranje uzoraka; oglašavanje u vezi s drugim uslugama kao što su usluge u vezi bankarskih zajmova i oglašavanja putem radija; sortiranje za račun drugih osoba, raznih proizvoda (ne uključuje njihov prevoz) radi omogućavanja potrošaču njihovog lakšeg razgledanja i kupovine; ove usluge se mogu pružati u okviru prodavnica na malo, trgovina na veliko, posredstvom prodajnih kataloga, dopisno ili elektronskim putem, na primjer posredstvom weba ili putem telefona.

(210) Ž-2019-149

(220) 04.04.2019.

(731) W2 Company d.o.o., Dalmatinska bb, 81000, Podgorica, ME, ME

(540) ALEXSHOP

(550) I

(511) Klasa 35: Usluge maloprodaje, i online/internet maloprodaje u vezi sa satovima, nakitom, naočarima za sunce, naočarima za vid, futrolama za naočare i ostalom potrošačkom robom.

(210) Ž-2019-150

(220) 05.04.2019.

(731) Lidl Stiftung & Co. KG, Stiftsbergstraße 1, 74172, Neckarsulm, DE



(540)

(550) I

(740) AOD MSA IP - Milojević Sekulić Advokati, Karađorđeva 65, 11000, Beograd, RS

(511) Klasa 29: Kiseli krastavci svih vrsta; konzervirani proizvodi, koji su obuhvaćeni ovom klasom, a naročito meso, riba, živina, divljač, kobasice, voće i povrće; ukiseljeni proizvodi, koji su obuhvaćeni ovom klasom; gotova jela koja se prvenstveno sastoje od mesa i/ili ribe i/ili živine i/ili divljači i/ili kobasica i/ili voća i/ili povrća sa dodatkom pirinča i/ili testenine; grickalice, koje su obuhvaćene ovom klasom.

Klasa 30: Reliš (dodatak jelu); sosovi; pirinač; gotova jela koja se prvenstveno sastoje od pirinča i/ili testenine i/ili proizvoda od žitarica sa dodatkom mesa i/ili ribe i/ili živine i/ili divljači i/ili kobasica i/ili voća i/ili povrća; umotane punjene tortilje i punjeni takosi; pekarski proizvodi, umotane tortilje, tortilje za takose; grickalice koje su obuhvaćene ovom klasom, nachos (tortilja čips).

Klasa 31: Sveži bademi i sveže orašasto voće svih vrsta.

Klasa 32: Piva, mešana pića koja sadrže piva; mineralne gazirane vode i druga bezalkoholna pića; limunade; voćni napici i voćni sokovi; sirupi i drugi pripravci za pravljenje napitaka.

(210) Ž-2019-151

(220) 05.04.2019.

(731) Reign Beverage Company LLC, a Delaware limited liability company, 1547 N. Knowles Ave., 90063, Los Angeles, California, US

(540) REIGN TOTAL BODY FUEL

(550) I

(740) Božidar S. Radulović, Studentska bb, Lamela 3/18, 81000, Podgorica, ME

(511) Klasa 32: Fitnes napici.

(210) Ž-2019-152

(220) 08.04.2019.

(731) SRP TRADE d.o.o. Budva, Rozino br. 23, Budva, ME



(540)

(550) I

(511) Klasa 43: Usluge obezbjeđivanja hrane i pića; privremeno primanje na stan; usluge koje pružaju lica ili preduzeća čiji cilj je priprema jela ili pića za potrošnju usluge ishrane i smještaja, koje pružaju hoteli, pansioni ili druga preduzeća koja osiguravaju privremeni smještaj; usluge rezervisanja smještaja za putnike, koje pružaju putničke agencije ili posrednici; usluge pansiona za životinje.

(210) Ž-2019-153

(220) 08.04.2019.

(731) Montenegro's one investment and consulting, Bulevar Džordža Vašingtona, Capital Plaza, sprat IV, br. 98, 81000, Podgorica, ME, ME

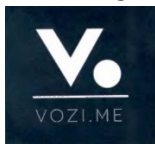

(540)

(550) I

(511) Klasa 35: Oglašavanje i reklamiranje; vođenje komercijalnih poslova; komercijalna administracija; kancelarijski poslovi.

Klasa 36: Osiguranje; finansijski poslovi; monetarni poslovi; upravljanje nekretninama.

Klasa 37: Izgradnja; popravke; usluge postavljanja (instaliranja).

Klasa 38: Telekomunikacije.

Klasa 39: Prevoz; ambalažiranje i skladištenje proizvoda; organizovanje putovanja.

Klasa 41: Obuka; stručno osposobljavanje; razonoda; sportske i kulturne djelatnosti.

Klasa 42: Naučne i tehnološke usluge kao i pripadajuće usluge istraživanja i koncepcije; usluge industrijskih analiza i istraživanja; koncepcija i razvoj računara i računarskih programa /hardvera i softvera/.

Klasa 45: Pravne usluge; sigurnosne usluge za zaštitu imovine i lica; lične i društvene usluge koje pružaju drugi, namijenjene za zadovoljenje ljudskih potreba.

(210) Ž-2019-154

(220) 09.04.2019.

(731) BMJ Industries FZ-LLC, P.O. Box: 31053, Al-Jazeera Al-Hamra, Ras Al Khaimah, AE

(540) 4 K

(550) I

(740) Božidar S. Radulović, Studentska bb, Lamela 3/18, 81000, Podgorica, ME

(511) Klasa 34: Duvan; artikli za pušače; šibice.

(210) Ž-2019-155

(220) 09.04.2019.

(731) Intercontinental Great Brands LLC, 100 Deforest Avenue, 07936, East Hanover, New Jersey, US

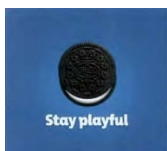

(540)

(550) I

(740) Miladin Popović, Đoka Miraševića 21/III, 81000, Podgorica, ME, ME

(511) Klasa 30: ne-medicinske poslastice; čokolada; čokoladne poslastice; poslastice od šećera; pekarski proizvodi, biskviti, keksi, kolačići, čizkejkovi, mrvice za kolačiće,

pite, hrskave pite; deserti, hladni deserti; kolači; i topla čokolada.

(210) Ž-2019-156

(220) 11.04.2019.

(731) SAVENCIA SA, a French societe anonyme, 42 rue Rieussec, 78220, Viroflay, FR



(540)

(550) I

(740) Branislav Lutovac, Bulevar Ivana Crnojevića 93, 81000, Podgorica, ME

(511) Klasa 29: Sir.

(210) Ž-2019-157

(220) 11.04.2019.

(731) SAVENCIA SA, a French societe anonyme, 42 rue Rieussec, 78220, Viroflay, FR



(540)

(550) I

(740) Branislav Lutovac, Bulevar Ivana Crnojevića 93, 81000, Podgorica, ME

(511) Klasa 29: Sir.

(210) Ž-2019-158

(220) 11.04.2019.

(731) SAVENCIA SA, a French societe anonyme, 42 rue Rieussec, 78220, Viroflay, FR

(540) SVESIRCI

(550) I

(740) Branislav Lutovac, Bulevar Ivana Crnojevića 93, 81000, Podgorica, ME

(511) Klasa 29: Mlijeko, sir i mliječni proizvodi; jestiva ulja i masti; mliječni namazi.

(210) Ž-2019-159

(220) 11.04.2019.

(731) Colgate-Palmolive Company (a Delaware corporation), 300 Park Avenue, 10022, New York, New York, US

(540) COLGATE SENSITIVE PRO-RELIEF

(550) I

(740) Jasna Jusić, Dalmatinska 2, 81000, Podgorica, ME

(511) Klasa 3: Nemedicinska pasta za zube, nemedicinska tečnost za ispiranje usta.

Klasa 5: Medicinska pasta za zube, medicinska tečnost za ispiranje usta.

Klasa 21: Četkice za zube.

(210) Ž-2019-160

(220) 12.04.2019.

(731) Novartis AG, Basel, 4002, CH

(540) DAXPRENAR

(550) I

(740) AOD MSA IP - Milojević Sekulić Advokati, Karađorđeva 65, 11000, Beograd, RS

(511) Klasa 5: Farmaceutski preparati za ljudsku upotrebu.

(210) Ž-2019-161

(220) 12.04.2019.

(731) Novartis AG, Basel, 4002, CH

(540) PERINDASAN

(550) I

(740) AOD MSA IP - Milojević Sekulić Advokati, Karađorđeva 65, 11000, Beograd, RS

(511) Klasa 5: Farmaceutski preparati za ljudsku upotrebu.

(210) Ž-2019-162

(220) 12.04.2019.

(731) ADDIKO BANK AG, Wipplingerstrasse 34/4 OG, 1010, Bec, AT

(540) Synddiko

(550) I

(740) Lana Vukmirović Mišić, Bulevar Džordža Vašingtona, br. 102, A-18, 81000, Podgorica, ME

(511) Klasa 35: Oglašavanje i reklamiranje; vođenje komercijalnih poslova; komercijalna administracija; kancelarijski poslovi.

Klasa 36: Osiguranje; finansijski poslovi; monetarni poslovi; upravljanje nekretninama.

(210) Ž-2019-165

(220) 16.04.2019.

(731) Leisslinger Mineralbrunnen GmbH, Am Frauenholze 2, 06667, Leissling, DE

(540) **Saskia**

(550) I

(740) AOD MSA IP - Milojević Sekulić Advokati, Karađorđeva 65, 11000, Beograd, RS

(511) Klasa 32: Bezalkoholna pića koja su obuhvaćena klasom 32; mineralne vode, sodne vode, vode; voćni napici i voćni sokovi; sirupi i drugi preparati za proizvodnju pića.

(210) Ž-2019-166

(220) 19.04.2019.

(731) Soci t  des Produits Nestl  S.A., ,, 1800, Vevey, CH

(540) PICCOLO

(550) I

(740) AOD MSA IP - Milojević Sekulić Advokati, Karađorđeva 65, 11000, Beograd, RS

(511) Klasa 11: Električni aparati za pripremu toplih, hladnih i rashlađenih napitaka; električni aparati za kafu, električne posude za pripremu kafe i električni filter aparati (perkolatori).

(210) Ž-2019-167

(220) 23.04.2019.

(731) Reign Beverage Company LLC, a Delaware limited liability company, 1547 N. Knowles Ave., 90063, Los Angeles, California, US

(540) REIGN

(550) I

(740) Božidar S. Radulović, Studentska bb, Lamela 3/18, 81000, Podgorica, ME

(511) Klasa 32: Fitnes napici.

(210) Ž-2019-168

(220) 23.04.2019.

(731) PIAGGIO & C.S.P.A., VIALE RINALDO PIAGGIO 25, 56025, PONTEDERA,PISA, IT

(540) VESPA

(550) I

(740) AOD MSA IP - Milojević Sekulić Advokati, Karađorđeva 65, 11000, Beograd, RS

(511) Klasa 18: Torbe; ručne torbice; putne torbe; aktovke; kožne aktovke; kožni držači za kreditne kartice; novčanici; predmeti od kože u vidu futrola za ključeve; ženske tašne; sanduci (prtljag); koferi; neseseri koji se prodaju prazni; sportske torbe; torbe koje se nose preko ramena; kožne torbe za kupovinu; školske torbe; ruksaci; kompleti kožnih putnih torbi; putne torbe za odeću; putne torbe za cipele; torbe za plažu; cilindrične tekstilne torbe; torbe za planinarenje u obliku višenamenskih torbi; kozmetičke torbice, prazne; životinjske kože za izradu krznarskih proizvoda; kožne kutije i futrole za odlaganje; prekrivači za nameštaj od kože koji nisu po meri; kišobrani; suncobrani; povodci od kože.

(210) Ž-2019-170

(220) 25.04.2019.

(731) INNER MONGOLIA YILI INDUSTRIAL GROUP CO., LTD., No. 1 Jinshan Road, Jinshan Development Zone, Hohhot, CN



(540)

(550) I

(740) Božidar S. Radulović, Studentska bb, Lamela 3/18, 81000, Podgorica, ME

(511) Klasa 5: Medicinski preparati; mineralna voda za medicinske svrhe; napici za medicinske svrhe; biljna vlakna, dijetetska; medicinski preparati za mršavljenje; terapijski ili medicinski preparati za ishranu; lijekovi za ljudsku upotrebu; vitaminski preparati; radioaktivne supstance za medicinsku upotrebu; gas za medicinsku upotrebu; hemijski provodnici za elektrokardiografske elektrode; sjeme za vještačku oplodnju; dezinfekciona sredstva; rastvori za upotrebu sa kontaktnim sočivima; podloga za gajenje ćelija u kulturi; medicinske bombone; proteinski dijetetski dodaci; lecitin kao dijetetski dodatak; dijetetski suplement za bijele prione; dodaci ishrani; mineralni dodaci ishrani; medicinski hranljivi napici; medicinski proizvodi za ishranu; dijetetska hrana prilagođena za medicinske svrhe; mliječna hrana u prahu za bebe; hrana za bebe; mliječne formule za bebe; mlijeko u prahu za bebe; preparati za prečišćavanje vazduha; medicinska hrana za životinje; dijetetski dodaci za životinje; insekticidi; pelene za bebe; grudni ulošci za dojenje; stomatološka abrazivna sredstva; pelene za kućne ljubimce; dijetetski suplementi koji stimuliraju rast probiotika; medicinski probiotski preparati.

Klasa 29: Meso; ekstrakti algi za ishranu; riba (koja nije živa); voće u konzervi; konzervisano voće; grickalice na bazi voća i povrća; prerađeni areka orasi; konzervisano povrće; jaja; buter; pavlaka (mliječni proizvod); mlijeko; mliječni proizvodi; jogurt; mućena pavlaka, šlag; mlijeko u prahu; napici od mlijeka u kojima mlijeko preovlađuje; sojino mlijeko; milk-šejk; čaj sa mlijekom u kojem preovlađuje mlijeko; bademovo mlijeko; smetana (kisela pavlaka); mlijeko od kikirikija; sojino mlijeko u prahu; koncentrat sojinog mlijeka; kokosovo mlijeko; pirinčano mlijeko; napici na bazi kokosovog mlijeka; napici na bazi bademovog mlijeka; napici na bazi mlijeka od kikirikija; sir; jestivo ulje; želei za ishranu; prerađeni orašasti plodovi; suve jestive pečurke; tofu proizvodi; prirodna ili veštačka crijeva za kobasice; dezerti napravljeni od mliječnih proizvoda; kozije mlijeko u prahu; pića fermentirana pomoću bakterije mliječne kiseline.

Klasa 30: Napici na bazi kafe; čokoladni napici sa mlijekom; kafa; pečeni kakao, kakao u prahu, kakao napici; napici od čokolade; čaj; napici na bazi čaja; šećer; slatkiši; mliječni desert (slatkiš); med; melasa; kolači; hljeb; poslastice; ovsene pahuljice; instant pirinač; preparati od žitarica; sojino brašno; pirinač; sago; pšenično brašno; instant rezanci; pirinčani rezanci; grickalice na bazi žitarica; grickalice na bazi pirinča; skrob za jelo; sladoled; jestivi led; sladoled na štapiću; so; sirće; soja sos; začini; senf; riblji sos; kvasac; fermenti za tijesto; aromatični dodaci za hranu; esencije za hranu, izuzev etarskih esencija i etarskih ulja; preparati za učvršćivanje mućene pavlake, šlaga; sredstva za omekšavanje mesa za upotrebu u domaćinstvu; gluten pripremljen kao hrana; pirinčano brašno za pirinčane rezance; prah za pravljenje sladoleda.

Klasa 32: Pivo; napici na bazi pirinča, koji nisu zamjena za mlijeko; bezalkoholno pivo; sportska pića; energetska pića; bezalkoholni gazirani napici; bezalkoholni voćni napici; pića od surutke; voda (piće); litijum voda; mineralna voda; kisela voda; stona voda; limunada; soda voda; bezalkoholni napici; gazirana voda; izotonici; kvas (bezalkoholni napitak); smutis (kašasti napitak od voća ili povrća); napici od soje, koji nisu

zamjena za mlijeko; sportska pića obogaćena proteinima; bezalkoholni napici sa ukusom kafe; bezalkoholni napici sa ukusom čaja; osvježavajuća bezalkoholna pića; čaj sa mlijekom, u kojem ne preovlađuje mlijeko; destilovana voda za pravljenje napitaka; destilovana voda za piće; prečišćena voda za piće; pića od povrća; pića od mahunarki; fermentisano piće od pasulja; preparati za pravljenje napitaka; šerbeti (napici).

(210) Ž-2019-171

(220) 25.04.2019.

(731) INNER MONGOLIA YILI INDUSTRIAL GROUP CO., LTD., No. 1 Jinshan Road, Jinshan Development Zone, Hohhot, CN

Yili

(540)

(550) I

(740) Božidar S. Radulović, Studentska bb, Lamela 3/18, 81000, Podgorica, ME

(511) Klasa 5: Medicinski preparati; mineralna voda za medicinske svrhe; napici za medicinske svrhe; biljna vlakna, dijetetska; medicinski preparati za mršavljenje; terapijski ili medicinski preparati za ishranu; lijekovi za ljudsku upotrebu; vitaminski preparati; radioaktivne supstance za medicinsku upotrebu; gas za medicinsku upotrebu; hemijski provodnici za elektrokardiografske elektrode; sjeme za vještačku oplodnju; dezinfekciona sredstva; rastvori za upotrebu sa kontaktnim sočivima; podloga za gajenje ćelija u kulturi; medicinske bombone; proteinski dijetetski dodaci; lecitin kao dijetetski dodatak; dijetetski suplement za bijele prione; dodaci ishrani; mineralni dodaci ishrani; medicinski hranljivi napici; medicinski proizvodi za ishranu; dijetetska hrana prilagođena za medicinske svrhe; mliječna hrana u prahu za bebe; hrana za bebe; mliječne formule za bebe; mlijeko u prahu za bebe; preparati za prečišćavanje vazduha; medicinska hrana za životinje; dijetetski dodaci za životinje; insekticidi; pelene za bebe; grudni ulošci za dojenje; stomatološka abrazivna sredstva; pelene za kućne ljubimce; dijetetski suplementi koji stimuliraju rast probiotika; medicinski probiotski preparati.

Klasa 29: Meso; ekstrakti algi za ishranu; riba (koja nije živa); voće u konzervi; konzervisano voće; grickalice na bazi voća i povrća; prerađeni areka orasi; konzervisano povrće; jaja; buter; pavlaka (mliječni proizvod); mlijeko; mliječni proizvodi; jogurt; mućena pavlaka, šlag; mlijeko u prahu; napici od mlijeka u kojima mlijeko preovlađuje; sojino mlijeko; milk-šejk; čaj sa mlijekom u kojem preovlađuje mlijeko; bademovo mlijeko; smetana (kisela pavlaka); mlijeko od kikirikija; sojino mlijeko u prahu; koncentrat sojinog mlijeka; kokosovo mlijeko; pirinčano mlijeko; napici na bazi kokosovog mlijeka; napici na bazi bademovog mlijeka; napici na bazi mlijeka od kikirikija; sir; jestivo ulje; želei za ishranu; prerađeni orašasti plodovi; suve jestive pečurke; tofu proizvodi; prirodna ili veštačka crijeva za kobasice; dezerti napravljeni od mliječnih proizvoda; kozije mlijeko u prahu; pića fermentirana pomoću bakterije mliječne kiseline.

Klasa 30: Napici na bazi kafe; čokoladni napici sa mlijekom; kafa; pečeni kakao, kakao u prahu, kakao napici; napici od čokolade; čaj; napici na bazi čaja; šećer; slatkiši; mliječni dezert (slatkiš); med; melasa; kolači; hljeb; poslastice; ovsene pahuljice; instant pirinač; preparati od žitarica; sojino brašno; pirinač; sago; pšenično brašno; instant rezanci; pirinčani rezanci; grickalice na bazi žitarica; grickalice na bazi pirinča; skrob za jelo; sladoled; jestivi led; sladoled na štapiću; so; sirće; soja sos; začini; senf; riblji sos; kvasac; fermenti za tijesto; aromatični dodaci za hranu; esencije za hranu, izuzev etarskih esencija i etarskih ulja; preparati za učvršćivanje mućene

pavlake, šlaga; sredstva za omekšavanje mesa za upotrebu u domaćinstvu; gluten pripremljen kao hrana; pirinčano brašno za pirinčane rezance; prah za pravljenje sladoleda.

Klasa 32: Pivo; napici na bazi pirinča, koji nisu zamjena za mlijeko; bezalkoholno pivo; sportska pića; energetska pića; bezalkoholni gazirani napici; bezalkoholni voćni napici; pića od surutke; voda (piće); litijum voda; mineralna voda; kisela voda; stona voda; limunada; soda voda; bezalkoholni napici; gazirana voda; izotonici; kvas (bezalkoholni napitak); smutis (kašasti napitak od voća ili povrća); napici od soje, koji nisu zamjena za mlijeko; sportska pića obogaćena proteinima; bezalkoholni napici sa ukusom kafe; bezalkoholni napici sa ukusom čaja; osvježavajuća bezalkoholna pića; čaj sa mlijekom, u kojem ne preovlađuje mlijeko; destilovana voda za pravljenje napitaka; destilovana voda za piće; prečišćena voda za piće; pića od povrća; pića od mahunarki; fermentisano piće od pasulja; preparati za pravljenje napitaka; šerbeti (napici).

(210) Ž-2019-172

(220) 25.04.2019.

(731) ETI GIDA SANAYI VE TICARET ANONIM SIRKETI, Organize Sanayi Bolgesi 11., Cadde Eskisehir, TR



(540)

(550) I

(740) Miladin Popović, Đoka Miraševića 21/III, 81000, Podgorica, ME, ME

(511) Klasa 30: Biskviti.

(210) Ž-2019-173

(220) 25.04.2019.

(731) Monster Energy Company, a Delaware corporation, 1 Monster Way, 92879, Corona, California, US

(540) MONSTER MANGO LOCO

(550) I

(740) Božidar S. Radulović, Studentska bb, Lamela 3/18, 81000, Podgorica, ME

(511) Klasa 32: Bezalkoholna pića.

(210) Ž-2019-174

(220) 30.04.2019.

(731) Best Western International, Inc., 6201 North 24th Parkway, 85016, Phoenix, Arizona, US



(540)

(550) I

(740) Branislav Lutovac, Bulevar Ivana Crnojevića 93, 81000, Podgorica, ME

(511) Klasa 43: Hotelske usluge.

(210) Ž-2019-175

(220) 30.04.2019.

(731) Lidl Stiftung & Co. KG , Stiftsbergstraße 1, 74172, Neckarsulm, DE



(540)

(550) I

(740) AOD MSA IP - Milojević Sekulić Advokati, Karađorđeva 65, 11000, Beograd, RS

(511) Klasa 1: Đubriva, tečna đubriva, đubrivo u obliku štapića; hemikalije za borbu protiv bolesti biljaka, preparati za poboljšanje rasta biljaka, preparati za jačanje biljaka, hranljive materije za biljke; zemlja za kompost, zemlja za cveće, malč kao đubrivo (obuhvaćeno klasom 1); sva navedena roba namenjena je samo za krajnje korisnike.

Klasa 5: Preparati za uništavanje životinjskih štetočina; fungicidi, herbicidi; preparati za ukljanjanje algi.

Klasa 21: Saksije za cveće, korpe za cveće i prozorske žardinjere od plastike, drveta, plute, trske, rogoza ili vrbovog pruća; saksije za biljke, korpe za biljke i kutije za biljke od plastike, drveta, plute, trske, rogoza ili vrbovog pruća; saksije za cveće i saksije za biljke, korpe i kutije od grnčarije, stakla ili porcelana; keramičke saksije za cveće i biljke; staklarija, porcelan i grnčarija, koji nisu obuhvaćeni drugim Klasa ma.

Klasa 31: Hortikulturni i šumarski proizvodi i zrnevlje (žitarice); seme za travnjake, seme trave; seme, prirodne biljke i cveće; lukovice; zasađene biljke; buketi suvog cveća, aranžmana od suvog cveća za dekorativne svrhe; buketi od trave za dekorativne svrhe; buketi suvog cveća i biljaka za dekorativne svrhe.

(210) Ž-2019-176

(220) 06.05.2019.

(731) R & A Bailey & Co, Nangor House, Western Estate, 12, Dublin, IE

(540) BAILEYS

(550) I

(740) Jasna Jusić, Dalmatinska 2, 81000, Podgorica, ME

(511) Klasa 30: Kafa, čaj, kakao, vještačka kafa; pirinač; tapioca i sago; brašno i proizvodi od žitarica; hljeb; peciva i poslastice; jestivi led; šećer, med mesala; kvasac, prašak za pecivo, so; senf; sirće, sosevi (kao dodaci jelima); začini; led (smrznuta voda).

(210) Ž-2019-177

(220) 07.05.2019.

(731) NIKŠIĆKI MLIN AD, Hercegovački put broj 5, 81400, Nikšić, ME

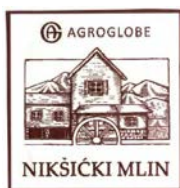

(540)

(550) I

(740) ADVOKATSKA KANCELARIJA VELIMIROVIĆ & PARTNERI, Serdara Jola Piletića VIII/6, 81000, Podgorica, ME

(511) Klasa 30: Brašno i proizvodi od žitarica, hleb, kolači, poslastice, bomboni, sladoled.

(210) Ž-2019-178

(220) 07.05.2019.

(731) Four Seasons Hotels (Barbados) Ltd. a Barbados Company, Chancery House, High Street, Bridgetown, BB



(540)

(550) I

(740) Jasna Jusić, Dalmatinska 2, 81000, Podgorica, ME

(511) Klasa 35: Oglašavanje; vođenje poslova; poslovno upravljanje; kancelarijski poslovi; usluge nabavke; vođenje poslova za druge, uključujući pregovaranje i zaključivanje komercijalnih transakcija, ugovaranje poslova kupovine i prodaje proizvoda; pružanje informacija o proizvodima i uslugama, dobavljačima i poslovima; usluge maloprodajnih objekata; usluge prodaje; usluge poručivanja putem pošte; usluge prodaje putem interneta ili mobilnih telefona; vođenje hotela za druge; upravljanje hotelima; obezbeđivanje prostora za izložbe (administrativne); dijeljenje oglasa/reklama; neposredno oglašavanje putem pošte; pružanje usluga poslovnih centara; promocija apartmana, vlasničkih stanova, tajmšering nekretnina, nekretnina povremenog vlasništva, komercijalnih nekretnina, otvorenih i zatvorenih tržnih centara, i nekretnina svih vrsta, kao i povezanih objekata i pogodnosti, uključujući i takve usluge koje se pružaju onlajn, elektronski ili putem globalne kompjuterske mreže; reklamiranje maloprodajnih šoping centara; pružanje usluga upravljanja vlasnicima radnji i/ili rukovodiocima u tržnim centrima; upravljanje otvorenim i zatvorenim tržnim centrima; organizacija konvencija i izložbi u poslovne i komercijalne svrhe; podsticajni nagradni programi za korisnike kreditnih kartica; upravljanje programima lojalnosti potrošača; izdavanje poklon vaučera i poklon kartica koji se mogu zamijeniti za robu i/ili usluge; usluge reklamiranja; poslovno upravljanje hotelima, spa centrima, službenim stanovima, objektima prodaje hrane objektima prodaje pića, kancelarijama, poslovnim centrima, robnim kućama, tržnim centrima, maloprodajnim i veleprodajnim outletima; onlajn maloprodaja; konsultacije u poslovnom upravljanju, konsultacije u upravljanju hotelima, konsultacije u upravljanju spa centrima, konsultacije u poslovnom upravljanju u vezi sa hranom i pićem; poslovne savjetodavne usluge u vezi sa franšizingom; maloprodajne usluge; sortiranje raznih proizvoda, za račun trećih lica, radi omogućavanja potrošačima da ih lakše razgledaju i kupuju u hotelima, outletima za hranu i piće, poslovnim zgradama, kongresnim centrima, robnim kućama, ili veleprodajnim objektima, iz opštih robnih kataloga, kroz naručivanje putem pošte ili putem sredstava telekomunikacije ili putem internet stanica mreže za globalnu komunikaciju u vezi sa opštom trgovinom; sakupljanje mejling lista; usluge poručivanja putem pošte, telefona i svih drugih komunikacionih i telekomunikacionih sredstava; poslovno savetovanje; usluge prikaza robe; oglasne usluge; marketinške i promotivne usluge, analiza i istraživanje tržišta; usluge agencija koje se bave uvozom i izvozom; nabavka i kupovina robe u ime firmi; uređivanje izloga; usluge privatnih klubova, uključujući obezbeđivanje poslovnih prostora za upotrebu od strane članova i stanara; informacione, savjetodavne i konsalting usluge u vezi sa prethodno pomenutim uslugama; programi članstva, lojalnosti, podsticaja, nagrađivanja i otkupa za potrošače a u promotivne i/ili reklamne svrhe, svi uključeni u klasu 35; uključujući

sve gore pomenute usluge koje se pružaju elektronskim putem ili onlajn putem kompjuterske baze podataka ili putem interneta; informacione, savjetodavne i konsalting usluge u vezi sa gore pomenutim uslugama; sve uključene u klasu 35.

Klasa 36: Osiguranje; finansijski poslovi; novčani [monetarni] poslovi; poslovi vezani za nepokretnosti, razvoj, kupovina, prodaja, upravljanje, iznajmljivanje, promocija i posredovanje na berzi apartmana, vlasničkih stanova, tajmšering nekretnina, komercijalnih nekretnina, zatvorenih i otvorenih tržišnih centara, nekretnina svih tipova kao i povezanih objekata i pogodnosti; razmjena povezanih pogodnosti; aranžmani razmjene za nekretnine, uključujući tajmšering nekretnine i druge nekretnine povremenog vlasništva; poslovi u vezi sa nekretninama; usluge iznajmljivanja smeštaja; upravljanje stambenim zgradama i stambenim objektima; usluge upravljanja smeštajima; prodaja, iznajmljivanje i davanje u zakup apartmana, stanova, zgrada, kuća, vlasničkih stanova i ostalih stambenih smještaja; razvoj, kupovina, prodaja, finansiranje,

upravljanje, rukovođenje, izdavanje, promocija i posredovanje na berzi nekretnina za sve tipove nekretnina; davanje prava i upravljanje pravima drugih kojima je omogućeno da koriste nekretnine; davanje prava i upravljanje pravima korišćenja apartmana, rezidencija, nekretninama frakcionog vlasništva članovima kluba odmorišta; usluge u vezi sa apartmanima,

rezidencijama, nekretninama frakcionog vlasništva, članovima kluba odmorišta, klupskim članstvima, tajmšering nekretninama za odmor, tajmšering nekretninama; obezbeđivanje smještaja za stanovanje; davanje u zakup smještaja u ime drugih; izdavanje apartmana; izdavanje stanova; službeni stanovi; usluge u vezi sa komercijalnim nekretninama, otvorenim i zatvorenim tržišnim centrima i nekretninama svakog tipa, i povezanim objektima; usluge u vezi sa prodajom tajmšering nekretnina i nekretnina povremenog vlasništva; usluge razmjene nekretnina, uključujući tajmšering nekretnine i nekretnine povremenog vlasništva; usluge članstva u vezi sa tajmšeringom nekretnina; pribavljanje informacija u vezi sa nekretninama, apartmanima, objektima tajmšering nekretnina i davanja u zakup apartmana; tajmšering nekretnina; tajmšering nekretnina za odmor; usluge članstva u vezi sa tajmšeringom ; usluge imovine u vezi sa brodovima za krstarenja, naime, listing , davanje u zakup, posredovanje na berzi i upravljanje stambenim i komercijalnim jedinicama na brodovima za krstarenje i finansiranje istih; finansijske usluge; usluge u vezi sa hipotekama; usluge kreditnih kartica; usluge u vezi sa novcem; pružanje usluga čuvanja u sefovima; usluge osiguranja; uključujući sve gore pomenute usluge koje se pružaju elektronski ili onlajn preko kompjuterske baze podataka ili putem interneta; informacione, savjetodavne i konsalting usluge u vezi sa gore pomenutim uslugama; sve uključene u klasu 36.

Klasa 39: Transportne usluge; pakovanje i skladištenje robe; organizovanje putovanja; transport; usluge vezane za iznajmljivanje brodova, organizovanje krstarenja, rad marina; rad turističkih kancelarija i turističkih agencija; organizovanje izleta, pratnja putnika, prevoz putnika; upravljanje garažama, iznajmljivanje parkinga, parkiranje automobila, iznajmljivanje automobila; rezervisanje mjesta za putnike i rezervacije putovanja; vođenje krstarenja; usluge brodova za krstarenje; putničke usluge; putne rezervacije; krstarenja brodovima; upravljanje krstarenjima; usluge turističkih agencijama, naime, rezervacije i bukiranje za krstarenja; organizovanje prevoza za putničke izlete; pakovanje i skladištenje robe; uključujući sve gore navedene usluge koje se pružaju elektronski ili online iz kompjuterske baze podataka ili putem interneta; informacione, savjetodavne i konsalting usluge u vezi sa gore pomenutim uslugama; sve uključeno u klasu 39.

Klasa 41: Obrazovne usluge; pripremanje obuke; razonoda; sportske i kulturne aktivnosti; obezbjeđivanje rekreativnih, zabavnih i sportskih objekata; informativne usluge u vezi sa zabavama; usluge kluba; rezervisanje mjesta za priredbe, predstave, koncerte, sportske događaje, zabavu u obliku nastupa uživo; bioskopske, pozorišne, koncertne i druge zabavne usluge; obezbjeđenje prostorija za teretanu i zdravstveni klub i aktivnosti u vezi s tim; usluge umjetničke galerije; pružanje obrazovnih i predavačkih sadržaja i usluga

obuke; obezbjeđivanje onlajn elektronskih publikacija, uključujući časopise i brošure; pružanje usluga za kazino i video igre; obezbjeđivanje sauna, parnih kupatila i zdravstvenih banja; organizovanje i održavanje konferencija; planiranje proslava; sprovođenje časova fitnesa; obezbjeđivanje golf terena; usluge golf klubova; usluge zdravstvenih klubova [zdravstveni i fitnes trening]; usluge turističkih kampova [zabava]; usluge noćnih klubova [zabava]; organizacija takmičenja [obrazovnih ili zabavnih]; organizacija sportskih takmičenja; usluge ličnih trenera [fitnes trening]; iznajmljivanje opreme za ronjenje; usluge sportskih kampova; iznajmljivanje teniskih terena; zabavne usluge na kruzeru; uključujući sve gore navedene usluge koje se pružaju elektronski ili onlajn iz kompjuterske baze podataka ili putem interneta; informacione, savjetodavne i konsalting usluge u vezi sa gore pomenutim uslugama; sve uključeno u klasu 41.

Klasa 43: Privremeni smještaj; usluge obezbjeđivanje hrane i pića; iznajmljivanje privremenog smještaja; usluge privremenog smještaja; rezervacije za privremeni smještaj; usluge hotela i odmarališta; rezervacije hotela; usluge restorana; usluge barova; usluge prijema za privremeni smještaj [upravljanje dolascima i odlascima]; usluge agencija za smještaj [hoteli, pansioni]; iznajmljivanje prostorija za sastanke; iznajmljivanje rasvjetnih uređaja; iznajmljivanje stolica, stolova, stolanjaka i salveta za stolove, staklarije; iznajmljivanje kuhinjskih uređaja; usluge domova za penzionere; iznajmljivanje šatora; iznajmljivanje prenosivih zgrada; obezbjeđivanje konferencijskih objekata; zbrinjavanje životinja; usluge obdaništa (jaslice); usluge restorana, kateringa i banketa; obezbjeđivanje privremenog stanovanja na kruzeru; usluge restorana i bara koje se pružaju na kruzeru; obezbjeđivanje konferencijskih objekata; uključujući sve gore navedene usluge koje se pružaju elektronski ili onlajn iz kompjuterske baze podataka ili putem interneta; informacione, savjetodavne i konsalting usluge u vezi sa gore pomenutim uslugama.

Klasa 44: Medicinske usluge; veterinarske usluge; higijenska zaštita i nega lepote za ljude ili životinje; usluge poljoprivrede, hortikulture i šumarstva; spa usluge; kozmetički saloni; obezbjeđivanje objekata i usluga za saunu; usluge za gubljenje kilograma i oblikovanja figure; konsultacije i savjeti za ljepotu; usluge aromaterapije; usluge uređivanja kućnih ljubimaca; usluge za oporavak kod kuće; obezbjeđivanje cvjetnih aranžmana; zdravstvene spa usluge; masaža; uređivanje bašte; dizajniranje zelenih površina.

(210) Ž-2019-188

(220) 15.05.2019.

(731) Novartis AG, Basel, 4002, CH

(540) PERAMCARD

(550) I

(740) AOD MSA IP - Milojević Sekulić Advokati, Karađorđeva 65, 11000, Beograd, RS

(511) Klasa 5: Farmaceutski preparati za ljudsku upotrebu.

(210) Ž-2019-189

(220) 15.05.2019.

(731) Spartan Race, Inc., 234 Congress Street, 5th Floor, MA 02110, Boston, US

(540)  **SPARTAN**

(540)

(550) I

(740) Jasna Jusić, Dalmatinska 2, 81000, Podgorica, ME

(511) Klasa 28: Sportska oprema, aparati, oprema, mašine i sprave za dizanje tegova, vježbe snage, atletiku, fizičku kondiciju, vježbanje, postizanje fizičke kondicije, teretanu i trening tijela, naime šipke za dizanje tegova, bučice, tegovi za vježbanje različitih težina, ručni tegovi, ploče tegovi, osigurači i opruge za pričvršćivanje tegova koji se koriste uz šipke za dizanje tegova i koji se prodaju u kompletu sa šipkama za dizanje tegova, kreda za teretanu, posude i stalci koji se koriste za odlaganje i držanje kreda za teretanu, police za skladištenje za atletsku opremu, vijače, remeni za dizanje tegova, roleri od pjene za vježbanje, vrećice od pijeska od neoprena za vježbe tjelesne kondicije, steznici za zglobove koji se stavljaju prilikom dizanja tegova, steznici za koljena koji se stavljaju prilikom dizanja tegova, steznici za laktove koji se stavljaju prilikom dizanja tegova, steznici za cjevanice i listove koji se stavljaju prilikom dizanja tegova, vijače, užad za brzinu, užad za preskakanje, užad za penjanje, užad za vježbanje, užad za kondicijske pripreme, vratila, trake za trčanje, roleri od pjene za vježbanje nogu, roleri od pjene za oblikovanje mišića, girije, medicinske lopte, lopte različitih težina, lopte za vježbanje, trening i pokretljivost, sprave za veslanje, stacionarni bicikli, strunjače za trbušnjake, točkovi za trbušnjake, prostirke koje se stavljaju ispod sprava za vježbanje, lopte za pilates, sprave za vježbanje sa lopticom koja se odbija koja nije za medicinske svrhe, medicinske lopte, lopte za ravnotežu, pliometričke kutije, gimnastičke karike, pojasevi za električnu stimulaciju za jačanje mišića, težine za članke, težine za zglobove, rukavice za dizanje tegova, rukavice za trening, rukavice za vježbanje, rastegljive trake za vježbanje, kaiševi i trake pričvršćene za vrata ili objekte za izvođenje različitih fizičkih vježbi, rastegljivi kaiševi, rastegljiva crijeva, rastegljive vrpce za vježbe snage, čunjevi za vježbe brzine i pokretljivosti, merdevine za vježbanje, prepreke za trening s preprekama, trke i takmičenja, naime, prepone (prepreke) za staze i brzinu, poligoni za pokretljivost, rukavice za rvanje, jastučići za udaranje za borilačke vještine, štitnici za ruke za atletsku upotrebu, štitnici za zglobove za atletsku upotrebu, štitnici za podlakticu za atletsku upotrebu, štitnici za list za atletsku upotrebu, štitnici za potkoljenu i gornji dio stopala za atletsku upotrebu, bacanje koplja za atletska takmičenja i torbe posebno prilagođene za sportsku opremu.

(210) Ž-2019-190

(220) 15.05.2019.

(731) Spartan Race, Inc., 234 Congress Street, 5th Floor, MA 02110, Boston, US



(540)

(550) I

(740) Jasna Jusić, Dalmatinska 2, 81000, Podgorica, ME

(511) Klasa 25: Odjeća; sportska odjeća; šeširi; kape; džemperi; jakne; marame; donje rublje; prsluci; sportske pantalone; sportske košulje; majice kratkih rukava; kupaći kostimi; sportska obuća; obuća; pokrivala za glavu.

(210) Ž-2019-191

(220) 15.05.2019.

(731) Koncern za proizvodnju i promet konditorskih proizvoda Bambi a.d. Požarevac, Đure Đakovića bb, 12000, Požarevac, RS

(540) Ne grizi savest zagrizi Wellness

(550) I

(740) dr Ivan Todorović, Gospodar Jevremova 23/8, 11000, Beograd

(511) Klasa 30: Integralni keks.

(210) Ž-2019-193

(220) 13.05.2019.

(731) Koncern za proizvodnju i promet konditorskih proizvoda Bambi a.d. Požarevac, Đure Đakovića bb, 12000, Požarevac, RS

(540) Zlatni Pek - zlata vredan

(550) I

(740) dr Ivan Todorović, Gospodar Jevremova 23/8, 11000, Beograd

(511) Klasa 30: Keks, mleveni keks, posni keks, posni mleveni keks, posni keks sa kakaom.

(210) Ž-2019-194

(220) 16.05.2019.

(731) Lidl Stiftung & Co. KG, Stiftsbergstrasse 1, 74172, Neckarsulm, DE

(540) TIRADELL

(550) I

(740) Branislav Lutovac, Bulevar Ivana Crnojevića 93, 81000, Podgorica, ME

(511) Klasa 29: Knedle svih vrsta uključene u ovu klasu, naročito knedle od krompira, knedle od jetre, knedle

od slanine, knedle od kajsije, knedle od šljive.

Klasa 30: Tjestenina; gotova jela koja se sastoje od tjestenine; knedle svih vrsta uključene u ovu klasu, naročito knedle od hleba, knedle od pereca, knedle od kvasca; peciva; testa svih vrsta; slatka gotova jela uključena u ovu klasu, naročito "kajzeršmarn (isječena i pošećerena palačinka sa grožđicama); pirinač; proizvodi od pirinča, gotova jela koja sadrže pirinač uključena u ovu klasu; gore navedena roba koja je ohlađena ili zamrznuta.

(210) Ž-2019-195

(220) 16.05.2019.

(731) Colgate-Palmolive Company (a Delaware Corporation), 300 Park Avenue, 10022, New York, New York, US

(540) CATALYST

(550) I

(740) Jasna Jusić, Dalmatinska 2, 81000, Podgorica, ME

(511) Klasa 3: Nemedicinska pasta za zube i nemedicinska tečnost za ispiranje usta.

(210) Ž-2019-196

(220) 17.05.2019.

(731) NEXT AUTO DOO, ĆEMOVSKO POLJE BB (KRUG ZETATRANSA), 81000, Podgorica, ME, ME

(540)  **CARTEX**

(550) I

(511) Klasa 4 Motorna i industrijska ulja za podmazivanje, aditivi za korišćenje u motornim vozilima.

Klasa 7: FILTERI (dijelovi motora), PUMPE (dijelovi motora), VENTILATORI (dijelovi motora), KAIŠEVI (dijelovi motora).

Klasa 12: Kvačila; sajle kvačila; cilindri kvačila; lamele kvačila; viljuške kvačila; mehanizmi kvačila; ležajevi kvačila sve za motorna vozila; kočnice za vozila, dijelovi kočnica kao i komponente kočnica za motorna vozila, kočioni diskovi za vozila, kočioni cilindri za vozila, disk pločice za vozila, kočione obloge za vozila, kočione gurtne za vozila, kočioni doboši za vozila, kočione sajle za vozila, kočioni setovi vozila, dijelovi kočnica vozila; homokinetički zglobovi vozila, zglobovi prji menjaču vozila, poluosovine sa zglobovima vozila, manžetne zglobova vozila amortizeri vozila, opruge amortizera vozila, sistemi ugibljenja vozila; obloge volana vozila; lanci za bolje prijanjanje točkova vozila; presvlake sedišta vozila; brisači vozila, metlice brisača vozila; gume vozila; dijelovi enterijera vozila; dijelovi eksterijera vozila; creva interkulera vozila, creva vode i vazduha u vozilima, kočiona creva vozila; remenice radilice vozila, remenice alternatora vozila; sijalice vozila; dijelovi trapa i upravljanja vozila.

(210) Ž-2019-197

(220) 20.05.2019.

(731) Omega Enterprises, Sarl, 6 Rue Eugene Ruppert, L-2453, Luxembourg, LU

(540) NIKKI BEACH

(550) I

(740) Jasna Jusić, Dalmatinska 2, 81000, Podgorica, ME

(511) Klasa 25: Odjeća, obuća, pokrivala za glavu.

Klasa 41: Obrazovanje; pružanje obuke; zabava; sportske i kulturne aktivnosti.

Klasa 43: Usluge obezbjeđivanja hrane i pića; privremeni smještaj; usluge hotela, bara i restorana.

(210) Ž-2019-198

(220) 20.05.2019.

(731) Reign Beverage Company LLC, a Delaware limited liability company, 1547 N. Knowles Ave., 90063, Los Angeles, California, US

(540) YOUR REIGN, YOUR RULES

(550) I

(740) Božidar S. Radulović, Studentska bb, Lamela 3/18, 81000, Podgorica, ME

(511) Klasa 32: Bezalkoholna pića.

(210) Ž-2019-199

(220) 20.05.2019.

(731) Reign Beverage Company LLC, a Delaware limited liability company, 1547 N. Knowles Ave., 90063, Los Angeles, California, US

(540) REFUEL. REFRESH. RECOVER.

(550) I

(740) Božidar S. Radulović, Studentska bb, Lamela 3/18, 81000, Podgorica, ME

(511) Klasa 32: Bezalkoholna pića.

(210) Ž-2019-200

(220) 20.05.2019.

(731) Reign Beverage Company LLC, a Delaware limited liability company, 1547 N. Knowles Ave., 90063, Los Angeles, California, US



(540)

(550) I

(740) Božidar S. Radulović, Studentska bb, Lamela 3/18, 81000, Podgorica, ME

(511) Klasa 32: Fitnes napici.

(210) Ž-2019-201

(220) 20.05.2019.

(731) Reign Beverage Company LLC, a Delaware limited liability company, 1547 N. Knowles Ave., 90063, Los Angeles, California, US



(540)

(550) I

(740) Božidar S. Radulović, Studentska bb, Lamela 3/18, 81000, Podgorica, ME

(511) Klasa 32: Fitnes napici.

(210) Ž-2019-202

(220) 23.05.2019.

(731) ISHIHARA SANGYO KAISHA, LTD., 3-15, Edobori, 1-chome, Nishi-ku, Osaka, JP

(540) ZENBY

(550) I

(740) Miladin Popović, Đoka Miraševića 21/III, 81000, Podgorica, ME, ME

(511) Klasa 5: Fungicidi kao poljoprivredne hemikalije; insekticidi; nematicidi; herbicidi; pesticidi.

(210) Ž-2019-203

(220) 23.05.2019.

(731) ISHIHARA SANGYO KAISHA,LTD., 3-15, Edobori, 1-chome, Nishi-ku, Osaka, JP

(540) KRYOR

(550) I

(740) Miladin Popović, Đoka Miraševića 21/III , 81000, Podgorica, ME, ME

(511) Klasa 5: Fungicidi kao poljoprivredne hemikalije; insekticidi; nematicidi; herbicidi; pesticidi.

(210) Ž-2019-204

(220) 23.05.2019.

(731) "Banja Komerc Bekament" DOO Banja, Aranđelovac, RS



(540)

(550) I

(740) AOD "Ćupić", Bulevar Džordža Vašingtona 79, 81000, Podgorica, ME

(511) Klasa 1: Lijepkovi za upotrebu u industriji; poludisperzioni i disperzioni premazi od polimera; silikoni.

Klasa 2: Boje, firnajzi i lakovi za industrijsku i ručnu upotrebu u grubim i završnim molerskim radovima, antikoroziivni preparati.

Klasa 17: Materijali za nepropusno zatvaranje, zaptivanje i izolovanje, naročito ekspandirani polistiren, mrežica, pur pjena.

Klasa 19: Fasadni malteri; mašinski malteri; građevinski materijali koji nijesu od metala, naročito tiplovi, ekspandirani polistiren, mrežica, pur pjena.

Klasa 37: Izvođački ili podizvođački radovi pri konstruisanju i izgradnji stalnih građevina, konstruisanje i izgradnja građevina, puteva, mostova.

(210) Ž-2019-205

(220) 24.05.2019.

(731) Toshiba Memory Corporation, 1-1, Shibaura 1-chome, Minato-ku, Tokyo, JP

(540) KIOXIA

(550) I

(740) Božidar S. Radulović, Studentska bb, Lamela 3/18, 81000, Podgorica, ME

(511) Klasa 7: Mašine za brušenje poluprovodničkih pločica; mašine za sečenje poluprovodničkih pločica; mašine za transportovanje poluprovodničkih pločica; mašine i sistemi za proizvodnju poluprovodnika.

Klasa 9: Mašine i instrumenti za analiziranje; mašine i instrumenti za merenje i testiranje; električni i magnetni metri i testeri; telekomunikacione mašine i aparati; SD memorijske kartice; kompjuterski mrežni adapteri; kompjuterski mrežni prekidači; kompjuterska mrežna čvorišta; kompjuterski mrežni ruteri; IC čipovi; memorijske kartice sa integrisani kolima; NAND fleš memorije; NAND fleš uređaji za skladištenje; NAND fleš memorijski kontroleri; NAND memorije; NVM memorije (memorije koje ne gube sadržaj nakon isključenja napajanja); NVM memorijski uređaji; USB fleš memorije; kertridži sa memorijom u čvrstom stanju; fleš memorije; fleš memorijske kartice; memorijske kartice; kućišta za memorijske kartice; poluprovodnici; poluprovodničke memorije; poluprovodnički memorijski uređaji; kompjuterski mediji za skladištenje podataka; uređaji za skladištenje podataka; procesori podataka; kompjuterski memorijski uređaji; kompjuterski periferni uređaji; SSD diskovi; integrisana kola; štampane ploče; kompjuterski hardver; uređaji za praćenje bioloških informacija (koji nisu uključeni u klasu 10); kompjuterski program koji se može preuzeti sa interneta; kompjuterski programi; elektronske mašine, aparati i njihovi delovi; multimedijalne memorijske kartice i drugi mediji sa nasnimljenim podacima; elektronske publikacije.

Klasa 35: Usluge prodaje na malo i usluge prodaje na veliko u vezi sa električnim mašinama i aparatima; pružanje informacija koje se odnose na komercijalnu prodaju.

Klasa 41: Obezbeđivanje elektronskih publikacija; iznajmljivanje memorijskih medija sa nasnimljenim podacima.

Klasa 42: Projektovanje integrisanih kola; projektovanje kompjuterskog softvera, kompjutersko programiranje, i održavanje kompjuterskog softvera; tehničko savetovanje koje se odnosi na kompjutere, automobile i industrijske mašine; obezbeđivanje onlajn softvera koji se ne može preuzeti sa interneta; računarstvo u oblaku; obezbeđivanje kompjuterskih programa na mrežama podataka.

(210) Ž-2019-206

(220) 24.05.2019.

(731) NVU Žene Bara, Bar, Bulevar Dinastije Petrović, H 24, ME



(540)

(550) I

(511) Klasa 3: Preparati za bijeljenje i ostale materije za pranje rublja; preparati za čišćenje, poliranje, odmašćivanje i struganje; sapuni; parfimerijski proizvodi, eterična ulja, kozmetički proizvodi, losioni za kosu; proizvodi za njegu zuba; proizvode za čišćenje i toaletne proizvode; dezodoranse (parfimerija); proizvode za osvježavanje (parfemisanje) prostorija.

Klasa 14: Plemeniti metali i njihove legure i proizvodi od tih metala ili obloženi tim metalima, koji nisu obuhvaćeni drugim klasama; pravi i lažni nakit, drago kamenje; časovničarski proizvodi i hronometrijski instrumenti; plemenite metale, proizvode načinjene od tih metala koji nisu obuhvaćeni drugim klasama i, uopšteno, draguljarske proizvode, nakit i časovničarske proizvode; pravi i lažni nakit; dugmad za manžetne, igle za kravate.

Klasa 15: Muzički instrumenti; mehanički klaviri i njihov pribor; muzičke kutije; električni i elektronski muzički instrumenti.

Klasa 16: Papir, karton i proizvodi od tih materijala koji nisu obuhvaćeni drugim klasama; štamparski proizvodi; proizvodi za uvezivanje knjiga; fotografije; pribor za pisanje; ljepila (ljepljive materije za papirnatu

proizvode ili za kućne potrebe); slikarski pribor; kistovi; pisaće mašine i kancelarijski pribor (osim namještaja); oprema za nastavu i obuku (osim aparata); plastični materijali za ambalažu (koji nisu obuhvaćeni drugim klasama); štamparska slova; klišeji; papir, papirnati proizvodi i kancelarijski pribor; noževi za papir; aparati za umnožavanje; plastične folije, torbe i vrećice od plastičnog materijala, za ambalažu.

Klasa 17: Guma, gutaperka, biljna smola, azbest, liskun i proizvodi od tih materijala koji nisu obuhvaćeni drugim klasama; proizvodi od polu obrađene plastike; materijali za nepropusno zatvaranje, za zaptivanje i za izolaciju; nemetalne savitljive cijevi; električna, termička ili akustična izolacijska sredstva te polu obrađena plastika u listovima, pločama ili štapićima; guma za popravak zračnica; gumene ili plastične materije za punjenje (nabijanje); ploveće barijere protiv zagađenja.

Klasa 18: Koža, imitacije kože, proizvodi od tih materijala koji nisu obuhvaćeni drugim klasama; životinjske kože; koferi i torbe; kišobrani, suncobrani i štapovi za hodanje; bičevi i sedlarsko remenarski proizvodi; koža i kožne imitacije, predmeti za putovanja koji nisu obuhvaćeni drugim klasama i sedlarsko remenarski proizvodi.

Klasa 19: Nemetalni građevinski materijali; čvrste nemetalne cijevi za gradnju; asfalt, katran i bitumen (smola); nemetalne prenosive konstrukcije; nemetalni spomenici; nemetalni građevinski materijali; polu obrađeno drvo (na primjer: grede, daske, ploče); šperploču, furnir; građevinsko staklo (na primjer: pločice, stakleni crijep); granulate stakla za obilježavanje puteva; zidane sandučice za pisma.

Klasa 20: Namještaj, ogledala, okviri; proizvodi koji nijesu obuhvaćeni drugim klasama, od drveta, plute, trske, šiblja, roga, kosti, slonovače, kitove kosti, školjki, ćilibara, sedefa, morske pjene (stive); zamjena svih tih materijala ili plastični proizvodi; namještaj i njegove dijelovi kao i plastični proizvodi koji nijesu obuhvaćeni drugim klasama; metalni namještaj i namještaj za kampove; oprema za krevete (na primjer: strunjače, dušeci, jastuci); ogledala, ukrasna ogledala, toaletna ogledala; nemetalne registarske tablice; sandučići za pisma koji nijesu od metala ili zidani.

Klasa 21: Pribor i posuđe za domaćinstvo ili za kuhinju; češljevi i sunđereri; četke (osim kičica); materijali za četke; pribor za čišćenje; žica za struganje parketa; sirovo ili polu obrađeno staklo (osim građevinskog stakla); stakleni proizvodi, porculansko i keramičko posuđe koje nije obuhvaćeno drugim klasama; sitni pribor i aparati za domaćinstvo i za kuhinju, koji se pokreću ručno, kao i toaletni pribor, stakleni i porculanski proizvodi; pribor i posude za domaćinstvo i za kuhinju, kao na primjer: kuhinjsko metalno posuđe, kante, kotlići limeni, aluminijske, plastične ili od nekog drugog materijala, mali, ručno pokretani aparati za sjeckanje, mljevenje, presovanje i sl.; električni češljevi; električne četkice za zube; podmetači za posude i podmetači za boce (posuđe).

Klasa 22: Konopci, užad, mreže, šatori, cerade, jedra, vreće (koje nisu obuhvaćene drugim klasama); materijali za punjenje madraca (nabijanje) (osim gume i plastike); sirovi vlaknasti, tekstilni, materijali; užad i proizvodi za jedrenje, materijali za punjenje (nabijanje) madraca kao i vlaknasti neobrađeni tekstilni materijali; konopci i kanapi od prirodnog ili vještačkog vlakna, od papira ili od plastike.

Klasa 23: Konac za tekstilnu upotrebu.

Klasa 24: Tkanine i tekstilni proizvodi koji nijesu obuhvaćeni drugim klasama; pokrivači za krevete i stolove; tkanine i pokrivači; papirnata posteljina.

Klasa 25: Odjeća, obuća, pokrivala za glavu.

Klasa 26: Čipka, vez, vrpce i gajtane; dugmad, kopče i petlje, špenadle (duple igle) i igle; vještačko cvijeće; krojački pribor i krojački predmeti; predmeti koji se koriste u krojačke svrhe.

Klasa 27: Tepisi, prostirači, strunjače, linoleumi i ostali pokrivači za podove; zidne tapete koje nijesu od tekstila; proizvodi za pokrivanje ili za oblaganje, u svrhu uređenja već izgrađenih podova i zidova.

Klasa 28: Igre i igračke; gimnastički i sportski predmeti koji nisu obuhvaćeni drugim klasama; ukrasi za božićne jelke; aparati za razonodu ili za igranje koncipirane za upotrebu s nezavisnim ekranom za prikazivanje ili s monitorom; pribor za pecanje; sprave za sport i zimske igre.

Klasa 29: Meso, riba, živina i divljač; mesni ekstrakti; konzervirano, sušeno i kuvano voće i povrće; želei, džemovi, kompoti; jaja, mlijeko i mliječni proizvodi; jestiva ulja i masti, prehrambene namirnice životinjskog porijekla, kao i povrće i ostale jestive poljoprivredne proizvode pripremljene za potrošnju ili za konzerviranje; mliječni napitci u kojima mlijeko prevladava.

Klasa 30: Kafa, čaj, kakao, šećer, riža, tapioka, sago, zamjene za kafu; brašno i proizvodi od žitarica, hleb, kolači, poslastice, bomboni, sladoled; med, sirup od melase; kvasac, prašak za pecivo; so, senf; sirće, prelive, začini, razni začini, led za hlađenje; prehrambene namirnice biljnog porijekla pripremljene za potrošnju ili za konzerviranje, kao i dodatke za poboljšanje ukusa hrane; napitci od kave, kakao ili čokolade ili čaja; žitarice pripremljene za ljudsku prehranu (na primjer: ovsene pahuljice ili pahuljice od drugih žitarica).

Klasa 31: Poljoprivredni, povrtlarski, šumski proizvodi i bobice, koji nisu obuhvaćeni drugim klasama; žive životinje; svježe voće i povrće; sjeme, prirodne biljke i cvijeće; hrana za životinje; slad; plodovi zemlje koji nisu pretrpjeli nikakvu pripremu radi potrošnje, žive životinje i sirove biljke kao i hranu za životinje; neobrađeno drvo; neobrađene žitarice; jaja za plantaže; žive mekušce i rakove.

Klasa 32: Pivo; mineralne i gazirane vode i ostala bezalkoholna pića; pića od voća i voćni sokovi; sirupi i ostali preparati za pripremanje napitaka; bezalkoholna pića, kao i pivo; bezalkoholna pića.

Klasa 33: Alkoholna pića (osim piva).

Klasa 35: Oglašavanje i reklamiranje; vođenje komercijalnih poslova; komercijalna administracija; ka celarijski poslovi; usluge koje pružaju lica ili organizacije, čija je glavna svrha: pomoć u radu i upravljanju privrednim društvima, ili pomoć u vođenju poslova ili komercijalnih funkcija industrijskog ili trgovačkog preduzeća, kao i usluge reklamnih ustanova koje se bave uglavnom reklamiranjem proizvoda i usluga putem svih vrsta medija; usluge koje se odnose na registraciju, prijepis, sastavljanje, kompilaciju ili sistematizaciju pisanih saopštenja i zapisa kao i obradu ili kompilaciju matematičkih ili statističkih podataka; usluge agencija za oglašavanje kao i usluge distribuiranja prospekata direktno ili poštom ili distribuiranje uzoraka; oglašavanja u vezi s drugim uslugama kao što su usluge u vezi bankarskih zajmova i oglašavanja putem radija; sortiranje za račun drugih osoba, raznih proizvoda (ne uključuje njihov prevoz) radi omogućavanja potrošaču njihovog lakšeg razgledanja i kupovine; ove usluge se mogu pružati u okviru prodavnica na malo, trgovina na veliko, posredstvom prodajnih kataloga, dopisno ili elektronskim putem, na primjer posredstvom weba ili putem telefona.

Klasa 36: Osiguranje; finansijski poslovi; monetarni poslovi; upravljanje nekretninama; usluge u vezi sa finansijskim i monetarnim poslovima kao i usluge u vezi ugovora o osiguranju svake vrste; usluge u vezi sa finansijskim i monetarnim poslovima, to jest: usluge svih bankarskih zavoda ili institucija vezanih za njih, kao što su mjenjačnice ili službe za naknade; usluge kreditnih zavoda koji nijesu banke, kao što su kooperativne kreditne zadruge, individualna finansijska društva, zajmodavci itd.; usluge "holding" kompanija; usluge posrednika za poslove s vrijednosnim papirima i dobrima; usluge u vezi monetarnih poslova, koje se obavljaju posredstvom povjerenika; usluge u vezi izdavanja putnih čekova i kreditnih pisama; usluge lizinga [vrsta kreditiranja]; usluge administriranja zgradama, to jest usluge iznajmljivanja, procjene nekretnina ili usluge finansiranja; usluge osiguranja koje obavljaju agenti ili posrednici koji se bave osiguranjem, usluge pružene osiguranicima kao i usluge potpisivanja osiguranja.

Klasa 40: Obrada materijala; usluge koje nijesu navedene u drugim klasama, a obuhvataju mehaničku ili hemijsku obradu ili prenamjenu neorganskih ili organskih materijala ili predmeta; usluge prenamjene proizvoda ili materijala te svaku drugu obradu pri kojoj se mijenjaju njihova bitna svojstva (na primjer bojenje odjeće); usluga održavanja (na primjer hromiranje branika kod automobila); usluge obrade

materijala koje se obavljaju tokom proizvodnje bilo kojeg materijala ili predmeta koji nije građevina, na primjer, usluge rezanja, oblikovanja, poliranja struganjem ili usluge oblaganja metalom.

Klasa 41: Obuka; stručno osposobljavanje; razonoda; sportske i kulturne djelatnosti; usluge osoba ili ustanova koje se bave razvojem mentalnih sposobnosti lica ili životinja, kao i usluge razonode i zaokupljanja pažnje; usluge obučavanja osoba ili uvježbavanja životinja, u svim njihovim vidovima; usluge čiji je osnovni cilj razbibriga, zabava ili rekreacija lica; usluge prikazivanja javnosti umjetničkih i literarnih djela u kulturne i obrazovne svrhe.

Klasa 43: Usluge obezbjeđivanja hrane i pića; privremeno primanje na stan; usluge koje pružaju lica ili preduzeća čiji cilj je priprema jela ili pića za potrošnju kao i usluge ishrane i smještaja, koje pružaju hoteli, pansioni ili druga preduzeća koja osiguravaju privremeni smještaj; usluge rezervisanja smještaja za putnike, koje pružaju putničke agencije ili posrednici; usluge pansiona za životinje.

Klasa 44: Medicinske usluge; veterinarske usluge; higijenska njega i njega ljepote za ljude ili za životinje; usluge poljoprivrede, povrtlarstva i šumarstva; usluge medicinske njege, njege higijene tijela i njege ljepote, koje pružaju osobe ili ustanove ljudima i životinjama; takođe obuhvata usluge koje se tiču područja poljoprivrede, povrtlarstva i šumarstva; usluge medicinske analize koja se odnose na medicinsku obradu osoba (kao što su radiografska ispitivanja i vađenje krvi); usluge vještačke oplodnje; konsultacije u vezi farmacije; uzgajanje životinja; usluge u vezi uzgoja biljaka kao što je povrtlarstvo; usluge u vezi cvjetnog umijeća kao što je pravljenje cvjetnih aranžmana, kao i usluge koje pružaju baštovani pejzažisti.

Klasa 45: Pravne usluge; sigurnosne usluge za zaštitu imovine i lica; lične i društvene usluge koje pružaju drugi, namijenjene za zadovoljenje ljudskih potreba; usluge koje pružaju pravnici pojedincima ili grupama pojedinaca, organizacijama ili preduzećima; usluge sprovođenja anketa i nadzora u vezi sigurnosti osoba i zajednica; usluge koje pružaju osobe u svezi društvenih događanja kao što su usluge pratnje u društvu, usluge bračnih agencija, pogrebne usluge.

(210) Ž-2019-207

(220) 29.05.2019.

(731) Bioverativ Therapeutics Inc., 225 Second Avenue, 02451, Waltham, Massachusetts, US

(540) ENJAYMO

(550) I

(740) Božidar S. Radulović, Studentska bb, Lamela 3/18, 81000, Podgorica, ME

(511) Klasa 5: Farmaceutski preparat za liječenje bolesti hladnih aglutinina.

(210) Ž-2019-208

(220) 29.05.2019.

(731) AstraZeneca AB, ,, SE-151 85, Södertälje, SE

(540) TRIGZALTO

(550) I

(740) Branislav Lutovac, Bulevar Ivana Crnojevića 93, 81000, Podgorica, ME

(511) Klasa 5: Farmaceutski preparati i supstance.

(210) Ž-2019-209

(220) 29.05.2019.

(731) AstraZeneca AB, „ SE-151 85, Södertälje, SE

(540) VEGDURIS

(550) I

(740) Branislav Lutovac, Bulevar Ivana Crnojevića 93, 81000, Podgorica, ME

(511) Klasa 5: Farmaceutski preparati i supstance.

(210) Ž-2019-210

(220) 29.05.2019.

(731) Pharmaceutical chemical cosmetic industry ALKALOID AD Skopje, Blvd. Aleksandar Makedonski 12, 1000, Skopje, MK



(540)

(550) I

(740) Miladin Popović, Đoka Miraševića 21/III , 81000, Podgorica, ME, ME

(511) Klasa 3: Sapuni; šamponi; parfimerija; kozmetički preparati za njegu kože; kozmetički preparati za kupanje; dječje maramice impregnirane sredstvima za čišćenje; maramice impregnirane kozmetičkim losionima; vlažne maramice za kozmetičke svrhe; kozmetika za djecu; vatirani štapići za kozmetičke svrhe; kozmetičke kreme; losioni za kozmetičke svrhe.

Klasa 5: Upijajuće pelene za bebe; pelene za bebe; pelene za inkontinenciju; menstrualni ulošci; maramice impregnirane farmaceutskim losionima; hrana za bebe; sredstva za dezinfekciju; flasteri; medicinski šamponi; farmaceutski preparati za njegu kože.

Upijajuće pelene za bebe; pelene za bebe; pelene za inkontinenciju; menstrualni ulošci; maramice impregnirane farmaceutskim losionima; hrana za bebe; sredstva za dezinfekciju; flasteri; medicinski šamponi; farmaceutski preparati za njegu kože.

Klasa 16: Papirne podloge za mijenjanje pelena; podloge za mijenjanje pelena za jednokratnu upotrebu; plastične vrećice za pelene za jednokratnu upotrebu.

(210) Ž-2019-211

(220) 03.06.2019.

(731) Colgate-Palmolive Company (a Delaware corporation), 300 Park Avenue, 10022, New York, New York, US

(540) PALMOLIVE PURE & DELIGHT

(550) I

(740) Jasna Jusić, Dalmatinska 2, 81000, Podgorica, ME

(511) Klasa 3: Proizvodi za ličnu higijenu, odnosno, preparati za čišćenje kože i tijela; sapun; tečni sapun za ruke; gelovi i kreme za tuširanje; kupke; preparati za njegu kose; dezodoransi, preparati protiv znojenja i sprejevi za ispod pazuha za ličnu upotrebu; preparati za hidrataciju tijela i kože, losioni i kreme; puder u

prahu; preparati za brijanje; preparati za kozmetičko potamnivanje i preparati za zaštitu kože od uticaja sunca; maramice natopljene rastvorom za čišćenje.

(210) Ž-2019-213

(220) 04.06.2019.

(731) BGP Products Operations GmbH , , Turmstrasse 24, 6321, Steinhausen, CH

(540) ROZOR

(550) I

(740) Miladin Popović, Đoka Miraševića 21/III , 81000, Podgorica, ME, ME

(511) Klasa 5: Farmaceutski preparati.

(210) Ž-2019-214

(220) 04.06.2019.

(731) Shamdath Ragoebier, Dr. Sophi Redmondstraat 176 B, Paramaribo, SR



(540)

(550) I

(740) Luka Stijepović, Bulevar Svetog Petra Cetinjskog 130/VII, 81000, Podgorica, ME

(511) Klasa 34: Duvan; cigarete; predmeti za pušače; šibice.

(210) Ž-2019-215

(220) 05.06.2019.

(731) PHARMASCIENCE INC., , 6111 Royalmount Avenue Suite #100, Montreal Quebec H4P 2T 4, CA



(540)

(550) I

(740) Miladin Popović, Đoka Miraševića 21/III , 81000, Podgorica, ME, ME

(511) Klasa 5: Farmaceutski i veterinarski preparati; sanitarni preparati za upotrebu u medicini; dijetetska hrana i supstance prilagođene za upotrebu u medicini ili veterinarsku upotrebu, hrana za bebe; dijetetski dodaci za ljude i životinje; flasteri, materijali za zavijanje; materijali za plombiranje zuba, zubarska smola; dezinfekciona sredstva; preparati za uništavanje štetočina; fungicidi, herbicidi.

(210) Ž-2019-216

(220) 06.06.2019.

(731) NBA Properties, Inc., Olympic Tower- 645 Fifth Avenue, 10022, New York, New York, US



(540)

(550) I

(740) Miladin Popović, Đoka Miraševića 21/III , 81000, Podgorica, ME, ME

(511) Klasa 25: Odjeća, naime čarape, obuća, cipele za košarku, patike za košarku, majice, košulje, polo majice, dukserice, donji djelovi trenerke, pantalone, majice na bretele, dresovi, kratke pantalone, pižame, sportske majice, ragbi majice, džemperi, kaiševi, spavaćice, šeširi, kape, vizir kačketi, trenerke za zagrijavanje, donji djelovi trenerki za zagrijavanja, dresovi za zagrijavanja, majice za vježbanje ubacaja, jakne, blejzeri, kravate (odeća), džepne maramice, maramice, vjetrovke, jakne sa kapuljačom, kaputi, portikle za bebe koje nijesu od papira, oprema za bebe (odjeća), trake za glavu, ručne trake (odjeća), kecelje, donje rublje, bokserice, uske bokserice, široke pantalone, štitnici za uši, rukavice, rukavice samo sa palcem, šalovi, pletene i štrikane majice, haljine od žerseja, haljine, dresovi i uniforme za navijačice, odjeća za plivanje, odijela za plivanje, kupaći kostimi, bikini, tankini kupaći kostimi, gaćice za plivanje, gaćice za kupanje, šorcevi za surfovanje, gumirana odeća za vodu, marama za plažu, pokrivala za kupaći kostim, ogrtači za kupaći kostim, sandale, sandale za plažu, šeširi za plažu, štitnici za sunce sa vizirom, kape za plivanje, kape za kupanje, nova pokrivala za glavu sa prikačenim umecima.

Klasa 28: Igračke, igre i sportske stvari, naime košarkaške lopte, loptice za golf, lopte za igralište, sportske lopte, gumene lopte i pjenaste lopte, plišane lopte za igru, plastične lopte za igru, mrežice za košarku, table za košarku, minijaturne table za košarku, pumpe i igle za naduvavanje košarkaških lopti; štapovi za golf, torbe za golf, podmetači za golf, oprema za golf, naime, alat za popravku golf terena, kupice na koje se stavlja lopta, markeri lopti, pokrivala za torbe za golf, pokrivala za glave golf štapova, rukavice za golf, kutije za golf lopte, posebna zelena staza za golf; držači za bilijarske štapove, kugle za bilijar, trouglovi za bilijar, pikado ormari, elektronske košarkaške igrice na tabli, table za košarkaške igrice, košarkaške igrice, akcione igrice, društvene igrice za odrasle i djecu, trivia informacione igrice i elektronski video arkadni uređaji, košarkaški setovi koji se sastoje od mrežice i zviždaljke, lutke, dekorativne lutke, lutke za kolekciju, akcione figure za igru, akcione figure karikature, punjene igračke, plišane igračke, slagalice, montažni blokovi za igre, ukrasi za božićnu jelku i božićne čarape; vozila za igru u obliku automobila, kamiona, vozova i kombija, svi sa temom košarke, nove pjenaste igračke u obliku prsta ili trofeja, igračke trofeji, karte za igru, igre sa kartama, igračke koje prave zvuk, igračke za kućne ljubimce; igračke za plažu, naime lopte za plažu, lopte na naduvavanje, kantice za igru, lopatice za igru, igračke za pijesak, igračke za bazen sa pijeskom, gumene igračke za vodu; oprema za bazen, naime plivačka oprema za plutanje, oprema za plutanje u bazenu, igračke za splavarenje na vodi, pjenasta oprema za plutanje, kolutovi za plivanje, kolutovi za plivanje u bazenu, pjenasti kolutovi, daske za plivanje, daske za surfovanje, peraja za plivanje, peraja za surfovanje, narukvice za plutanje i narukvice za pomoć pri plivanju, sva navedena roba za rekreaciju; odbojkaški setovi za igru koji se sastoje od lopte, mrežice, traka koje označavaju teren i zviždaljke, i vaterpolo setovi za igru koji se sastoje od lopte, mrežice i zviždaljke; dekorativne igračke od tkanine koje se puštaju da lete na vjetru; minijaturne reprodukcije stadiona, naime, mali plastični modeli stadiona za igru; staklene kugle sa snijegom; džojstici za video igre; džojstici za računarske igre; mašine za video igre za upotrebu sa televizorom i ručni kontroleri za konzole za video igre; trake za trčanje; banke igračke; fidžet spinneri; skejtbordovi.

Klasa 41: Razonoda i obrazovne usluge u vidu televizijskih i radio programa iz oblasti košarke i prikazivanja uživo košarkaških igara i košarkaskih priredbi; usluge produkcije i distribucije radio i televizijskih šou programa sa košarkaškim utakmicama, košarkaškim događajima i programima iz oblasti košarke; usluge vođenja i organizovanja košarkaških klinika i kampova, klinika i kampova za trenere, klinika i kampova za

plesne timove i košarkaške igre; usluge rasonode u vidu ličnog pojavljivanja kostimiziranih maskota ili plesnih timova na košarkaškim utakmicama i priredbama, klinikama, kampovima, promocijama i drugim događajima u vezi sa košarkom, specijalnim događajima i žurkama; usluge kluba obožavalaca; usluge rasonode, naime pružanje vebsajta sa multimedijским sadržajem koji se ne može preuzimati u vidu najvažnijih televizijskih događaja, interaktivnih najvažnijih televizijskih događaja, video snimaka, video strim snimaka, interaktivnih video izbora najvažnijih događaja, radio programa, najvažnijih radijskih događaja i audio snimaka iz oblasti košarke; pružanje vijesti i informacija u vidu statistika i drugih tema iz oblasti košarke; omogućavanje pristupa on-lajn igricama koje se ne mogu preuzimati, naime računarskim igricama, video igricama, interaktivnim video igricama i trivia igricama; usluge rasonode u vidu imaginarnih košarkaskih liga; pružanje onlajn računarske baze podataka iz oblasti košarke.

(210) Ž-2019-217

(220) 07.06.2019.

(731) Novartis AG, Basel, 4002, CH

(540) ACIPAN

(550) I

(740) AOD MSA IP - Milojević Sekulić Advokati, Karađorđeva 65, 11000, Beograd, RS

(511) Klasa 5: Farmaceutski preparati, naime gastrointestinalni preparati.

(210) Ž-2019-218

(220) 10.06.2019.

(731) RA Trupo Holdings LLC, c/o Ripplewood Advisors LLC, 920 Broadway, 6th Floor, NY 10010, New York, US

(540) SME In A Box

(550) I

(740) AOD "Ćupić", Bulevar Džordža Vašingtona 79, 81000, Podgorica, ME

(511) Klasa 36: Bankarske usluge, bankarske konsultacije, on-lajn bankarske usluge, bankarski tenderi, elektronsko bankarstvo putem globalne kompjuterske mreže, usluge finansijskog menadžmenta; finansijske konsultacije.

(210) Ž-2019-219

(220) 10.06.2019.

(731) GABA International Holding GmbH, Grabetsmattweg, 4106, Therwil, CH

(540) ELMEX SENSITIVE PROFESSIONAL

(550) I

(740) Jasna Jusić, Dalmatinska 2, 81000, Podgorica, ME

(511) Klasa 21: Četkice za zube, konac za čišćenje zuba, interdentalna sredstva za čišćenje.

(210) Ž-2019-220

(220) 10.06.2019.

(731) The Ritz-Carlton Hotel Company, L.L.C., 10400 Fernwood Road, 20817, Bethesda, Maryland, US

(540) EVRIMA

(550) I

(740) Jasna Jusić, Dalmatinska 2, 81000, Podgorica, ME

(511) Klasa 39: Prevoz putnika i roba čamcem; pakovanje i skladištenje roba; usluge prevoza putnika kruzerima; usluge kruzera; usluge putničkih agencija, naime, organizovanje, pravljenje i primanje rezervacija za prevoz putnika i roba, usluge krstarenja i kruzera, ekskurzije u vidu prevoza na ture sa vodičem, prevoz za ture sa razgledanjem znamenitosti, godišnji odmori u vidu krstarenja i putničkog prevoza; organizovanje i izvođenje ekskurzija u vidu pružanja prevoza za ekskurzije, ture u vidu obezbjeđivanja prevoza za ture sa razgledanjem znamenitosti, godišnji odmori u vidu krstarenja i organizovanja krstarenja; usluge turističkog vodiča i turističkih informacija; usluge planiranja događaja i rukovođenja, naime, ugovaranje, organizacija, planiranje i osmišljavanje godišnjih odmora u vidu organizovanja putovanja; pružanje informacija i savjeta u vezi sa gorepomenutim uslugama.

Klasa 43: Obezbeđivanje hrane i pića i privremenog smještaja na kruzeru; pružanje usluga rezervacija za druge za privremeni smještaj na kruzeru.

(210) Ž-2019-222

(220) 10.06.2019.

(731) Dow AgroSciences LLC, 9330 Zionsville Road, 46268, Indianapolis, Indiana, US

(540) INSTINCT

(550) I

(740) Božidar S. Radulović, Studentska bb, Lamela 3/18, 81000, Podgorica, ME

(511) Klasa 1: Hemijski proizvod koji se koristi u zemljištu za očuvanje biljnih hranjivih materija.

(210) Ž-2019-223

(220) 14.06.2019.

(731) Four Seasons Hotels (Barbados) Ltd. a Barbados Company, Chancery House, High Street, Bridgetown, BB



(540)

(550) I

(740) Jasna Jusić, Dalmatinska 2, 81000, Podgorica, ME

(511) Klasa 39: Usluge transporta; putnički izleti; krstarenja; usluge vezane za iznajmljivanje brodova; rad marina; rad turističkih kancelarija i turističkih agencija; organizovanje izleta; organizovanje i sprovođenje krstarenja; organizacija izleta; organizacija krstarenja; upravljanje izletima; upravljanje krstarenjima; pratnja putnika; transport putnika; prevoz putnika; upravljanje garažama; iznajmljivanje parking mjesta; parking za

automobile; iznajmljivanje automobila; rezervisanje mjesta za putnike i rezervacije putovanja; usluge turističkih agencija za organizovanje izleta; putnički aranžman; vazdušni saobraćaj; vazdušni transport; usluge prijave prtljaga za avione i kruzere; usluge prijave putnika na aerodromima i krucerima; pružanje informacija o dolasku i odlasku letova i kruczera; usluge aerodroma; organizacija putovanja; usluge kruczera; pružanje informacija o turističkim putovanjima; pomorski transport; isporuka robe; isporuka tovara; pakovanje i skladištenje robe; putničke usluge; usluge turističkih vodiča; razgledanje (turizam); iznajmljivanje ronilačkih odijela; putne rezervacije; krstarenja brodovima; upravljanje krstarenjima; usluge putničkih agencija; rezervacije i bukiranje krstarenja; organizovanje prevoza za putovanja; uključujući sve gore navedene usluge koje se pružaju elektronski ili onlajn iz kompjuterske baze podataka ili putem interneta; informacione, savjetodavne i konsalting usluge u vezi sa gore pomenutim uslugama; sve uključene u klasu 39.

(210) Ž-2019-224

(220) 14.06.2019.

(731) BB&T Corporation, P.O. Box 1255, 27101, Winston-Salem, North Carolina, US

(540) TRUIST

(550) I

(740) Branislav Lutovac, Bulevar Ivana Crnojevića 93, 81000, Podgorica, ME

(511) Klasa 36: Finansijske i osiguravajuće usluge, i to bankarstvo, upravljanje povjerenjem, upravljanje investicijama, investiciono bankarstvo, međunarodno bankarstvo, korporativne finansije, faktoring, hipotekarno kreditiranje, finansijska klirinška kuća, finansiranje lizinga i finansiranje otkupa lizinga, finansijsko planiranje, analiza finansijskog portfelja i savjetovanje, usluge kreditnih kartica, usluge debitnih kartica, brokersko poslovanje i usluge zastupanja u osiguranju; onlajn bankarske usluge; usluge plaćanja računa putem veb stranice; usluge digitalnog bankarstva, naročito onlajn finansijsko upravljanje.

(210) Ž-2019-226

(220) 17.06.2019.

(731) KLIKOVAC D.O.O, Mahala bb, 81000, Podgorica, ME, ME

(540) **®Klikovac**

(550) I

(511) Klasa 33: Vino i rakija.

Klasa 35: Veleprodajne usluge u vezi sa: vinom i rakijom, energetskim pićem, bezalkoholnim pićima, čokoladom i slatkišima, lizalicama, bombonima i žvakama, ovsenim kašama (čokolada, jabuka, malina i lješnik), integralnim štapićima (zdrava ishrana), keksom, integralnim keksom, napolitankama, kroasanima, mliječnim proizvodima, soja napitkom, sojinom mlijekom, šlag kremom, medom, čajem, paradajz sosom, senfom, kenf sosom, polineza sosom, tartar sosom, binačinom, kuvanim paradajzom, majonezom, ajvarom, pinđurom, cveklom, feferonima, kornišonima, crnim i zelenim maslinama, maslinovim uljem, sirom, cherry paradajzom, kremom za kuvanje, miješanom salatam, crvenim fileti paprikama, cijelim i rezanim šampinjonima, jabukovim sirćetom, alkoholnim sirćetom, vinskim sirćetom, margarinom, puterom, aluminijumskom folijom, kozmetičkim proizvodima, uslugama degustacije vina, uslugama vinoteke. Maloprodajne usluge u vezi sa: vinom i rakijom, energetskim pićem, bezalkoholnim pićima, čokoladom i slatkišima, lizalicama, bombonima i žvakama, ovsenim kašama (čokolada, jabuka, malina i lješnik),

integralnim štapićima (zdravaishrana), keksom, integralnim keksom, napolitankama, kroasanima, mliječnim proizvodima, soja napitkom, sojinim mlijekom, šlag kremom, medom, čajem, paradajz sosom, senfom, kenf sosom, polineza sosom, tartar sosom, binačinom, kuvanim paradajzom, majonezom, ajvarom, pindūrom, cvekлом, feferonima, kornišonima, crnim i zelenim maslinama, maslinovim uljem, sirom, cherry paradajzom, kremom za kuvanje, miješanom salatом, crvenim fileti paprikama, cijelim i rezanim šampinjoniima, jabukovim sirćetom, alkoholnim sirćetom, vinskim sirćetom, tartar sosom, margarinom, puterom, aluminijumskom folijom, kozmetičkim proizvodima, uslugama degustacije vina, uslugama vinoteke.

Klasa 41: Organizacija i vođenje manifestacija degustacije vina u svrhu zabave.

Klasa 43: Hoteli, i turistički smještaj, motel usluge (hrana i piće), hotelske usluge (smještaj), hotelske rezervacije, informacije o hotelima, iznajmljivanje prostorija za društvene svečanosti, kafeterija, barovi (usluge bara), organizovanje banketa, organizovanje svadbenih primanja (hrana i piće), usluge restorana koje pružaju hoteli, usluge degustacije vina, usluge vinoteke.

(210) Ž-2019-229

(220) 19.06.2019.

(731) Actavis Group PTC ehf., Reykjavikurvegi 76-78, 220, Hafnarfjordur, IS

(540) GILESTRA DUO

(550) I

(740) Miladin Popović, Đoka Miraševića 21/III, 81000, Podgorica, ME

(511) Klasa 5: Farmaceutski preparati i supstance.

(210) Ž-2019-230

(220) 19.06.2019.

(731) Alcon Inc., Rue Louis-d'Affry 6, CH-1701 Fribourg, Switzerland, CH

(540) See Brilliantly

(550) I

(740) AOD "Ćupić", Bulevar Džordža Vašingtona 79, 81000, Podgorica

(511) Klasa 5: Farmaceutski, medicinski i veterinarski proizvodi; higijenski proizvodi za upotrebu u medicini; dijetetska hrana i supstance za medicinske i veterinarske potrebe, hrana za odojcad; dodaci ishrani za ljude i životinje; flasteri, materijal za previjanje; materijali za plombiranje zuba, i za zubne otiske; dezinfekcijska sredstva; proizvodi za uništavanje životinjskih štetocina; fungicidi, herbicidi.

Klasa 9: Naučni, istraživački, navigacijski, geodetski, fotografski, kinematografski, audiovizuelni i optički aparati i instrumenti kao i aparati i instrumenti za vaganje, mjerenje, signalizaciju, detekciju (otkrivanje), testiranje (kontrolu), inspekciju, za pomoć (spašavanje) i za obuku; aparati i instrumenti za vođenje, distribuiranje, transformisanje, akumuliranje, podešavanje ili upravljanje distribucije i upotrebe električne struje; aparati i instrumenti za snimanje, prenos, reprodukciju ili obradu zvuka, slika ili podataka; snimljeni mediji i mediji koji se mogu preuzimati, računarski softver, prazni digitalni ili analogni mediji za snimanje i pohranjivanje podataka; mehanizmi za uređaje koji se pokreću uz prethodno ubacivanje kovanica; registarske blagajne, računari; kompjuteri i njihovi periferni uređaji; ronilačka odijela, ronilačke maske,

čepići za uši za ronioce, štikaljke za nos za ronioce i plivače, rukavice za ronioce, aparati za disanje za podvodno plivanje; aparati za gašenje požara.

Klasa 10: Hirurški, medicinski, zubarski i veterinarski aparati i instrumenti; vještački udovi, oči i zubi; ortopedski proizvodi; pribor za šivanje rana; terapijske i pomoćne naprave prilagođene osobama s invaliditetom; aparati za masažu; aparati, uređaji i artikli za odojčad; aparati, uređaji i artikli vezani za polne aktivnosti.

Klasa 35: Oglašavanje i reklamiranje, vođenje komercijalnih poslova, komercijalna administracija; kancelarijski poslovi.

Klasa 37: Građevinsko konstruisanje; usluge instalacije i popravke (održavanja) oftalmoloških aparata i instrumenata.

Klasa 41: Obuka, stručno osposobljavanje; razonoda; sportske i kulturne djelatnosti.

(210) Ž-2019-231

(220) 19.06.2019.

(731) Conair Corporation, One Cummings Point Road, CT 06902, Stamford, US

(540) CONAIR

(550) I

(740) Jasna Jusić, Dalmatinska 2, 81000, Podgorica, ME

(511) Klasa 8: Pegle za stilizovanje kose, mašine za šišanje i trimeri.

Klasa 11: Fenovi za kosu.

(210) Ž-2019-232

(220) 19.06.2019.

(731) Babyliiss SARL, 99 Avenue Aristide Briand, 92120, Montrouge, FR

(540) BABYLIISS

(550) I

(740) Jasna Jusić, Dalmatinska 2, 81000, Podgorica, ME

(511) Klasa 8: Pegle za stilizovanje kose, mašine za šišanje i trimeri.

Klasa 11: Fenovi za kosu.

(210) Ž-2019-235

(220) 24.06.2019.

(731) HONGYUNHONGHE TOBACCO (GROUP) CO., LTD, NO. 367 HONGJIN ROAD, WUHUA DISTRICT, KUNMING CITY, YUNNAN PROVINCE, CN

(540) WIN

(550) I

(740) Božidar S. Radulović, Studentska bb, Lamela 3/18, 81000, Podgorica, ME

(511) Klasa 34: Cigarete; upaljači za pušače; šibice; duvan; elektronske cigarete; tečnosti za električne cigarete (e-tečnosti); začini (arome) za duvan, izuzev eteričnih ulja; usnici za cigarete; filteri za cigarete.

(210) Ž-2019-236

(220) 24.06.2019.

(731) HONGTA TOBACCO (GROUP) CO., LTD., NO. 118, HONGTA AVENUE, HONGTA DISTRICT, YUXI, YUNNAN, CN

(540) Ashima

(550) I

(740) Božidar S. Radulović, Studentska bb, Lamela 3/18, 81000, Podgorica, ME

(511) Klasa 11: Grejna tela; grejne ploče; regeneratori toplote; aparati za grejanje na čvrsta, tečna ili gasna goriva; upaljači; instalacije za taloženje u duvanskoj industriji; pržionici duvana; aparati na vruć vazduh; aparati za grejanje, električni; isparivači.

Klasa 34: Cigarete; upaljači za pušače; šibice; duvan; elektronske cigarete; tečnosti za električne cigarete (e-tečnosti); začini (arome) za duvan, izuzev eteričnih ulja; usnici za cigarete; filteri za cigarete

(210) Ž-2019-237

(220) 24.06.2019.

(731) BMJ Industries FZ-LLC, P.O. Box: 31053, Al-Jazeera Al-Hamra, Ras Al Khaimah, AE

(540) 

(550) I

(740) Božidar S. Radulović, Studentska bb, Lamela 3/18, 81000, Podgorica, ME

(511) Klasa 34: Duvan; artikli za pušače; šibice.

(210) Ž-2019-243

(220) 27.06.2019.

(731) Adriatic Marinas d.o.o. Tivat, Obala bb, 85320, Tivat, ME

(540) Captains Walk

(550) I

(511) Klasa 36: (Osiguranje i finansije) osiguranje; finansijski poslovi; novčani (monetarni) poslovi; upravljanje nekretninama.

Klasa 39: (Prevoz i skladištenje) transportne usluge; pakovanje i skladištenje proizvoda; organizovanje putovanja.

Klasa 41: (Obuka i razonoda) obuka; stručno osposobljavanje; razonoda; sportske i kulturne djelatnosti.

Klasa 43: (Hoteli i restorani) usluge obezbjeđivanja hrane i pića; privremeni smještaj.

Klasa 44: (Medicinske usluge, ljepota i poljoprivreda) medicinske usluge; veterinarske usluge; higijenska njega i njega ljepote za ljude ili za životinje; usluge poljoprivrede, povrtlarstva i šumarstva.

(210) Ž-2019-245

(220) 27.06.2019.

(731) Adriatic Marinas d.o.o. Tivat, Obala bb, 85320, Tivat, ME

(540) Hero Court

(550) I

(511) Klasa 36: (Osiguranje i finansije) osiguranje; finansijski poslovi; novčani (monetarni) poslovi; upravljanje nekretninama.

Klasa 39: (Prevoz i skladištenje) transportne usluge; pakovanje i skladištenje proizvoda; organizovanje putovanja.

Klasa 41: (Obuka i razonoda) obuka; stručno osposobljavanje; razonoda; sportske i kulturne djelatnosti.

Klasa 43:

Klasa 44: (Medicinske usluge, ljepota i poljoprivreda) medicinske usluge; veterinarske usluge; higijenska njega i njega ljepote za ljude ili za životinje; usluge poljoprivrede, povrtlarstva i šumarstva.

(210) Ž-2019-246

(220) 27.06.2019.

(731) Adriatic Marinas d.o.o. Tivat, Obala bb, 85320, Tivat, ME

(540) SYNCHRO Plaza

(550) I

(511) Klasa 36: (Osiguranje i finansije) osiguranje; finansijski poslovi; novčani (monetarni) poslovi; upravljanje nekretninama.

Klasa 39: (Prevoz i skladištenje) transportne usluge; pakovanje i skladištenje proizvoda; organizovanje putovanja.

Klasa 41: (Obuka i razonoda) obuka; stručno osposobljavanje; razonoda; sportske i kulturne djelatnosti.

Klasa 43: (Hoteli i restorani) usluge obezbjeđivanja hrane i pića; privremeni smještaj.

Klasa 44: (Medicinske usluge, ljepota i poljoprivreda) medicinske usluge; veterinarske usluge; higijenska njega i njega ljepote za ljude ili za životinje; usluge poljoprivrede, povrtlarstva i šumarstva.

(210) Ž-2019-248

(220) 27.06.2019.

(731) Adriatic Marinas d.o.o. Tivat

, Obala bb, 85320, Tivat, ME

(540) Ozana Club

(550) I

(511) Klasa 36: (Osiguranje i finansije) osiguranje; finansijski poslovi; novčani (monetarni) poslovi; upravljanje nekretninama.

Klasa 39: (Prevoz i skladištenje) transportne usluge; pakovanje i skladištenje proizvoda; organizovanje putovanja.

Klasa 41: (Obuka i razonoda) obuka; stručno osposobljavanje; razonoda; sportske i kulturne djelatnosti.

Klasa 43: (Hoteli i restorani) usluge obezbjeđivanja hrane i pića; privremeni smještaj.

Klasa 44: (Medicinske usluge, ljepota i poljoprivreda) medicinske usluge; veterinarske usluge; higijenska njega i njega ljepote za ljude ili za životinje; usluge poljoprivrede, povrtlarstva i šumarstva.

(210) Ž-2019-256

(220) 27.06.2019.

(731) HONGYUNHONGHE TOBACCO (GROUP) CO., LTD, NO. 367 HONGJIN ROAD, WUHUA DISTRICT, KUNMING CITY, YUNNAN PROVINCE, CN

(540) WIN

(550) I

(740) Božidar S. Radulović, Studentska bb, Lamela 3/18, 81000, Podgorica, ME

(511) Klasa 11 Grejna tela; grejne ploče; regeneratori toplote; aparati za grejanje na čvrsta, tečna ili gasna goriva; upaljači (koji nisu za pušače); instalacije za taloženje u duvanskoj industriji; pržionici duvana; aparati na vruć vazduh; aparati za grejanje, električni; isparivači.

(210) Ž-2019-257

(220) 28.06.2019.

(731) Lidl Stiftung & Co. KG, Stiftsbergstraße 1, 74172, Neckarsulm, DE



(540)

(550) I

(740) AOD MSA IP - Milojević Sekulić Advokati, Karađorđeva 65, 11000, Beograd, RS

(511) Klasa 1: Natrijum bikarbonat.

Klasa 29: Konzervirano voće i povrće; pripremljeno voće i povrće; smrznuto voće, sušeno voće; kandirana kora pomorandže i kandirana kora limuna; mleveni bademi, prerađeni orašasti plodovi; rendani kokos (kokosovo brašno); deserti koji se uglavnom sastoje od voća; proizvodi od krompira, gotove smese koje sadrže proizvode od krompira; gotova punjenja za pečenje, koja se uglavnom sastoje od semena maka, orašastih plodova, badema, kokosovog brašna i/ili voća; želatin (za ishranu); deserti koji se uglavnom sastoje od želatina sa dodatkom šećera; mleveno seme maka; namirnice za aromatizovanje, naime, ekstrakti (sokovi), kora i/ili pulpa citrusa, uključujući u sušenom ili delimično osušenom obliku; ulje za kuvanje, ulja za kuvanje koja se koriste za aromatizovanje; želei.

Klasa 30: Kafa; čaj; šećer; šećer u prahu; tapioka; sago; zamena za kafu; brašno i proizvodi od žitarica, brašno za hleb, kukuruzno brašno, griz, hlebne mrvice; palenta; hleb, rezani hleb, vekne hleba, kolači i poslastice, ražani proizvodi, torte, tart (slatka pita bez gornje kore), peciva, keks (kolači), krutonji; gotove mešavine za pečenje, mešavina za pravljenje kolača, mešavine za pravljenje hleba, gotova peciva, testo za kolače, prehrambena testenina, gotova prehrambena testenina; med, melasa; kvasac, prašak za pecivo, soda bikarbona (za pečenje); so; senf; sirće, sosovi (dodaci jelu); začini; začinski dodaci, dodaci za pića, začini za pečenje, arome i esencije za pečenje; skrob za ishranu, krompirovo brašno, kukuruzni skrob; vezivni agensi za sosove, sos u prahu; dodaci za zgušnjavanje hrane za kuvanje, preparati za učvršćivanje mučene pavlake, šlaga; glazure za torte, čokoladni prelive, fondan, šećerne mrvice, marcipan, bademovo testo, nugat, slatkiši od orašastih plodova, oblada, vanila i vanillin šećer, štapići vanile, čokolada, proizvodi od čokolade, čokoladne mrvice, listići čokolade, granule i pahuljice od čokolade; čokoladni ukrasi za torte i slatkiše, naročito za ukrašavanje deserta; slatkiši; bombone; puding; puding u prahu, mešavine za pripremu pudinga; gotovi deserti od sladoleda; pripremljeni deserti (na bazi čokolade).

Klasa 31: Semenke od maka, orasasto voće, bademi.

Klasa 32: Piva.

(210) Ž-2019-258

(220) 02.07.2019.

(731) "MULTIMAT" DOO PODGORICA , Trg Golootočkih žrtava bb, Podgorica, ME



(540)

(550) I

(511) Klasa 28: Igre i igračke; gimnastički i sportski predmeti koji nisu obuhvaćeni drugim Klasa ma; ukrasi za božićne jelke.

Klasa 41: Obuka; stručno osposobljavanje; razonoda; sportske i kulturne djelatnosti.

(210) Ž-2019-259

(220) 02.07.2019.

(731) ETI GIDA SANAYI VE TICARET ANONIM SIRKETI, Organize Sanayi Bolgesi 11., Cadde Eskisehir, TR



(540)

(550) I

(740) Miladin Popović, Đoka Miraševića 21/III , 81000, Podgorica, ME, ME

(511) Klasa 30: Biskviti; čokolade; peciva; krekeri; vafli; kolači; tartovi; deserti, naime, pekarski deserti, deserti na bazi brašna i čokolade, musevi, ledeni deserti; sladoledi; jestivi led.

(210) Ž-2019-261

(220) 04.07.2019.

(731) "MULTIMAT" DOO PODGORICA, Trg Golootockih žrtava bb, ME



(540)

(550) I

(511) Klasa 28: Igre i igračke; gimnastički i sportski predmeti koji nisu obuhvaćeni drugim Klasa ma; ukrasi za božićne jelke

Klasa 41: Obuka; stručno osposobljavanje; razonoda; sportske i kulturne djelatnosti.

(210) Ž-2019-262

(220) 04.07.2019.

(731) Qatar Sports Investment, Suhaim Bin Hamad Street, Al Saad, Regency Travel and Tours Building, Doha, QA

(540) First Sport Capital - Arabic

(550) I

(740) Božidar S. Radulović, Studentska bb, Lamela 3/18, 81000, Podgorica, ME

(511) Klasa 36: Investiranje, naime investiranje u sportu.

(210) Ž-2019-263

(220) 04.07.2019.

(731) Bosnalijek, farmaceutska i hemijska industrija, dionicko drustvo, Jukićeva 53, 71000, Sarajevo, BA

(540) RINOACT P

(550) I

(740) Božidar S. Radulović, Studentska bb, Lamela 3/18, 81000, Podgorica, ME

(511) Klasa 5: Farmaceutski proizvodi.

(210) Ž-2019-264

(220) 04.07.2019.

(731) Bosnalijek, farmaceutska i hemijska industrija, dionicko drustvo, Jukićeva 53, 71000, Sarajevo, BA

(540) RINOACT

(550) I

(740) Božidar S. Radulović, Studentska bb, Lamela 3/18, 81000, Podgorica, ME

(511) Klasa 5: Farmaceutski proizvodi.

(210) Ž-2019-267

(220) 08.07.2019.

(731) "Roberto's Company" doo, Sunčana obala 152, Zelenika, H.Novi, ME

(540) Roberto's

(550) I

(511) Klasa 43: Kafane [kafeterije]; kafane-restorani; restorani; restorani sa samoposluživanjem; restorani za brzo i stalno posluživanje [snek-barovi]; barovi (usluge barova).

(210) Ž-2019-269

(220) 09.07.2019.

(731) MILAN GOLOVIĆ, Radoja Dakića 5/17 stan 24, ME



(540)

(550) I

(740) Dragan S. Nikolić, Ul. Veliše Mugoše I/9, 81000, Podgorica, ME

(511) Klasa 16: ambalaža (kartonska ili papirnata za boce) boce (kartonska ili papirna ambalaža za boce) boce (kartonski ili papirni omoti za boce) boce (papirni podmetači za boce) – brošure – časopisi [periodični] – časopisi [revije] čestitke fascikle [kancelarijski pribor] fascikle [papirni proizvodi] fascikle za papir fotografije [štampane] kalendari kalendari [godišnjaci] kalendari kojima se listovi trgaju katalogi knjige (oznake za stranice u knjigama) knjige sa pjesmama letci, flajeri – naljepnice, štamparski blokovi – novine – novine sa stripovima – olovke – omotači za boce, papirnati ili kartonski – pakovanje hrane (folije od papira ili plastike za održavanje vlage, za pakovanje hrane) – pivske čaše (podmetači za pivske čaše) – plakati (papirnat ili kartonske podloge za plakate) – plakati [poster] – plakati, papirni ili kartonski –salvete od papira za stolove – slikarska platna – slikarske četkice – slikarski stalci – slike –stripovi (novine sa stripovima) – sveske za pisanje i crtanje – vrećice [omotnice, dzepovi], od papira ili plastike za ambalažu.

Klasa 41: dekor za priredbe (iznajmljivanje dekora za priredbe) - digitalne slike (usluge digitalnog snimanja) - disk džokeji (usluge disk dzokeja) usluge- diskoteke (usluge diskoteka) - elektronske publikacije (iskorištavanje elektronskih publikacija koje se ne mogu prenositi on-line) - filmovi (prikazivanje igranih filmova) - filmovi (proizvodnja filmova) - fotografi sanje - fotografske reportaže – igre za novac - informacije o obrazovanju - informacije o razonodi - informacije u vezi rekreacije - izdavanje knjiga - izložbe (organizovanje izložbi) u kulturne ili obrazovne svrhe - iznajmljivanje audio uređaja - iznajmljivanje dekora za priredbe - iznajmljivanje igrački - iznajmljivanje kinematografskih filmova - iznajmljivanje videokamera - iznajmljivanje videotraka - iznajmljivanje zvučnih snimaka - klubovi (usluge klubova) [zabava ili obrazovanje] - knjige (izdavanje knjiga) - knjige (posuđivanje knjiga) - komponovanje muzike - komponovanje muzike (usluge komponovanja muzike) - koncerti (organizovanje i vođenje koncerata) - konferencije (organizovanje i vođenje konferencija) - kongresi (organizovanje i vođenje kongresa) - modne revije za zabavne svrhe (organizovanje) – montaža radio i televizijskih programa - muzejske usluge [predstavljanje, izložbe] - muzičke sale - noćni klubovi - objavljivanje knjiga i časopisa, elektronski on line - objavljivanje tekstova [osim u reklamne svrhe] - obrazovanje (informacije o obrazovanju) – obrazovanje [obuka] - obuka - obuka [predavanje] - obuka putem dopisivanja - organizovanje i vođenje koncerata - organizovanje i vođenje konferencija - organizovanje i vođenje kongresa - organizovanje i vođenje radionica za stručno osposobljavanje - organizovanje i vođenje razgovora - organizovanje i vođenje seminara - organizovanje izložba u kulturne i obrazovne svrhe - organizovanje javnih konkursa [obrazovanje ili razonoda] - organizovanje konkursa ljepote - organizovanje plesova - organizovanje spektakla [usluge impresarija] - organizovanje sportskih takmičenja - orkestri (usluge orkestra) - pisanje tekstova [ne u reklamne svrhe] - planiranje prijema [razonoda] - posuđivanje knjiga - pozorišne predstave - pozorišni dekor (iznajmljivanje pozorišnog dekora) - pozorišni glumci (usluge pozorišnih glumaca) - pozorišni preduzetnici [impresariji] (usluge pozorišnih preduzetnika) - prijemi (planiranje prijema) [razonoda] - priredbe (iznajmljivanje dekora za priredbe) - priredbe (održavanje priredbi) – priredbe (organizovanje priredbi) [usluge impresarijaja] - priredbe (proizvodnja priredbi) - proizvodnja filmova - proizvodnja filmova na video-trakama - proizvodnja muzike - putujuće biblioteke (usluge putujućih biblioteka) - radio televizijski programi (montaža radio televizijskih programa) - radioaparati i televizori (iznajmljivanje radioaparata i televizora) - razgovori (organizovanje i vođenje razgovora) • -razonoda - razonoda (informacije u vezi razonode) - razonoda

posredstvom radija - razonoda posredstvom televizije - rekreacija (obavještenja u vezi rekreacije) - reportaže (fotografske reportaže) - reporterske usluge - rezervisanje mjesta za priredbe – scenarijumi (izrada scenarijuma) - seminari (organizovanje i vođenje seminara) - simpozijumi (organizacija i vođenje simpozijuma) – simpozijumi (organizovanje i vođenje simpozijuma) - slobodno vrijeme (usluge za ispunjavanje slobodnog vremena) - snimanje na videotrake - sportska takmičenja organizovanje sportskih takmičenja) - sportska usavršavanja (sportski kampovi za usavršavanje u sportu) - sportske opreme (iznajmljivanje sportske opreme osim vozila) - studio za snimanje (usluge studija za snimanje) - tekstovi (objavljivanje tekstova) [osim u reklamne svrhe] - tekstovi (sastavljanje tekstova) [ne u reklamne svrhe] - televizija (razonoda na televiziji) - televizijski programi (montaža radio i televizijskih programa) - televizori (iznajmljivanje televizora i radioaparata) - titlovanje filmova - ulaznice za priredbe (agencije za ulaznice za priredbe) [razonoda] - videotrake (iznajmljivanje videotraka) - videotrake (montaža videotraka) - videotrake (proizvodnja filmova na videotrakama) - videotrake (snimanje na videotrake) – zabavni parkovi [cirkusi]- zdravstveni klubovi (usluge zdravstvenih klubova) [održavanje zdravlja i fizičke forme] - zvučni snimci (iznajmljivanje zvučnih

Klasa 43: agencije za smještaj [hotelski, pansioni] - barovi (usluige barova) - hotelske rezervacije (usluge rezervisanja hotela) - hotelske usluge - iznajmljivanje aparata za kuvanje - iznajmljivanje privremenog smještaja - iznajmljivanje sala, dvorana za sastanke - iznajmljivanje stolaca, stolova, stolnog rublja i staklenog posuđa - kafane [kafeterije] - kafane - restorani -kantine – ljetovališta - ljetovanje (usluge kampova za ljetovanje) - moteli (usluge motela) - pansion za životinje - pansioni - pansioni (rezervisanje pansiona) - privremeni smještaj (rezervisanje privremenog smještaja) -restorani – restorani sa samoposluživanjem - restorani za brzo i stalno posluživanje [snek-barovi] - rezervisanje hotela - rezervisanje pansioria - rezervisanje privremenog smještaja – smještaj (agencije za izdavanje smještaja) [hoteli, pansioni] - smještaj (iznajmljivanje privremenog smještaja) - ugostitelji (usluge keteringa).

(210) Ž-2019-271

(220) 10.07.2019.

(731) Polar Music International AB, Banérgatan 16, 114 83, Stockholm, SE

(540) ABBA

(550) I

(740) Božidar S. Radulović, Studentska bb, Lamela 3/18, 81000, Podgorica, ME

(511) Klasa 9: Nasnimljene audio trake, audio diskovi i audio kasete, video trake, video diskovi i video kasete, digitalne audio i digitalne audio video trake i diskovi, CD-ovi, DVD-ovi, laserski diskovi, gramofonske ploče sa muzičkim i zabavnim sadržajem; pozorišni i muzički zvučni i video zapisi; softver za igre virtuelne realnosti; melodije zvona, muzika, mp3 fajlovi koji sadrže muziku i razonodu, grafike, slike u oblasti muzike i razonode u vezi sa muzikom, video zapisi u oblasti muzike i razonode u vezi sa muzikom i igrice, a koje se mogu preuzeti sa interneta za bežične komunikacijske uređaje; muzika, mp3 fajlovi koji sadrže muziku i razonodu u vezi sa muzikom, grafike, slike u oblasti muzike i razonode u vezi sa muzikom, video zapisi u oblasti muzike i razonode u vezi sa muzikom i kompjuterske igrice, a koje se mogu preuzeti sa interneta; softveri, trake, kertridži i kasete sa kompjuterskim igricama; softveri, trake, kertridži i kasete sa video igricama; okretne ploče kao delovi i oprema za gramofone; podloge za miševе; elektronske publikacije koje se mogu preuzeti sa interneta u obliku knjiga, knjižica, muzičkih partitura, časopisa, žurnala, priručnika, brošura, letaka, pamfleta i novina (biltena), a sve u oblasti muzike i razonode u vezi sa muzikom; mobilne aplikacije, koje se mogu preuzeti sa interneta, za korišćenje u vezi sa pristupom, prikazivanjem,

distribucijom, preuzimanjem, igranjem, primanjem, strimingom i prenosom muzike i razonode u vezi sa muzikom.

Klasa 16: Štampane knjige i časopisi u oblasti muzike, razonode, umetnosti i kulture; štampane muzičke partiture; adresari; rokovnici; kalendari; čestitke, dopisnice; razglednice; pernice za obične i hemijske olovke; rezači za olovke; hemijske olovke; olovke; dnevnicke; nalepnice za branike automobila; crteži koji se kopiraju na podlogu; blokovi za beleške; nalepnice; gumeni pečati; nalepnice za privremenu tetovažu; poster; kolekcionarski kartonski poklopci flaša za mleko za razmenu; kolekcionarske sličice za razmenu; spajalice za novac; kancelarijski materijal i pribor.

Klasa 18: Proizvodi od kože, naročito, tašne, ceger torbe, akten tašne, futrole za kreditne kartice, prenosne čvrste torbe, koferi, tašne za novčiće, putne torbe za odeću, torbe za teretanu, rančevi, torbe za knjige, torbice za nošenje na bokovima, portfelj tašne i novčanici; tašne; ceger torbe; akten tašne; futrole za kreditne kartice; prenosne čvrste torbe; koferi; tašne za novčiće; putne torbe za odeću; torbe za teretanu; rančevi; torbe za knjige; torbice za nošenje na bokovima; portfelj tašne i novčanici; kišobrani; ogrlice i odeća za kućne ljubimce; prazni nesesei; kozmetički koferčići koji se prodaju prazni.

Klasa 25: Odeća, naročito bademantili, bluze, bodi, kaputi, radni mantili, haljine, kućne haljine, kostimi za Noć veštica, čarape, jakne, puloveri, helanke, rukavice sa jednim prstom, rukavice, spavačice, kombinezoni, pidžame, pantalone, sobni ogrtači, marama, šalovi, košulje, šorcevi, suknje, kratke čarape, soknice, tregeri, gornji delovi trenerki, donji delovi trenerki, dukserice, džemper, kupaći kostimi, majice bez rukava, kravate, ženske najlon čarape, gornji delovi odeće, majice, veš, donji veš, prsluci i manžetne; obuća; pokrivala za glavu, naročito bandana marama, kape, štitnici za uši, šeširi i viziri; kaiševi; korseti; ženski donji veš; kecelje; patofnice za bebe; portikle od tkanine; bodi za bebe; odeća za malu decu; jednodelna odela za bebe.

Klasa 35: Usluge distribucije u oblasti muzičkih zvučnih zapisa i video zapisa; usluge reklamiranja i promocije i srodne konsultantske usluge; usluge reklamiranja i publiciteta; usluge udruživanja, naročito promocije interesa muzičara, pevača, kompozitora, tekstopisaca, muzičkih izvođača i umetnika; računarsko naručivanje preko interneta za robu široke potrošnje i dobra široke potrošnje; usluge računarskog naručivanja preko interneta u oblasti muzike; usluge računarske internet prodaje na malo u oblasti muzike; usluge računarskog naručivanja poklona preko interneta koje uklapaju zahteve poklonodavca sa željama i potrebama poklonoprime; sprovođenje zanatske izložbe preko interneta, u oblasti muzike, muzičkih koncerata i spotova; usluge kataloškog naručivanja kompakt-diskova, kasete, DVD-eva, odeće i druge robe; usluge internet prodaje na malo za snimke muzike i audio-vizuelnog sadržaja koji se mogu preuzeti sa interneta, odeću i drugu robu; organizacija promocija pomoću audio-vizuelnih medija; priprema audio-vizuelnih prezentacija za reklamiranje muzike; priprema audio-vizuelnih prezentacija za upotrebu u reklamiranju; organizacija i sprovođenje zanatskih izložbi u oblasti muzike i razonode; organizacija i sprovođenje sajмова i izložbi u poslovne svrhe i svrhe reklamiranja; organizacija i sprovođenje zanatskih izložbi u oblasti muzike; promocija koncerata drugih; promocija dobara i usluga drugih ugovaranjem sa sponzorima koji će povezati svoja dobra i usluge sa koncertima i muzičkim manifestacijama; promovisanje robe drugih pripremom i postavljanjem reklama u elektronski časopis kojem se pristupa preko globalne računarske mreže; obezbeđivanje informacija o proizvodima za potrošače za robu i usluge drugih putem globalne računarske mreže; usluge maloprodajnih objekata dostupne preko računarskih komunikacija i interaktivnih televizijskih programa za kompakt diskove, kasete, DVD-eve, video kasete i licenciranu robu; pretplata na knjige, kritike, novine ili stripove.

Klasa 41: Produkcija televizijskih i radio programa; distribucija televizijskih i radio programa za druge; produkcija i objavljivanje muzike; obezbeđivanje razonode putem interneta, naročito obezbeđivanje zvučnih i video zapisa koji se ne mogu preuzeti u oblasti muzike i zabavnih sadržaja u vezi sa muzikom; usluge razonode, naročito obezbeđivanje muzičkih zvučnih snimaka i video snimaka koji se ne mogu preuzeti preko globalne računarske mreže; usluge klubova za razonodu; razvoj i distribucija obrazovnih

materijala drugih u oblasti muzike i razonode; produkcija i distribucija zabavnih sadržaja za radio; snimanje i produkcija audio i zvučnih zapisa; produkcija zapisa; filmska i video produkcija; produkcija igranih filmova; distribucija igranih filmova; sindikacija u oblasti televizijskog programa; usluge razonode u obliku tekućih televizijskih programa u oblasti muzike i razonode; usluge razonode, naročito, u obliku muzičke i zabavne emisije u nastavcima koja se distribuira putem televizije, satelitskog prenosa, audio i video medija; objavljivanje knjiga i časopisa; usluge razonode u obliku tekućih radio programa u oblasti muzike; usluge razonode u obliku koncerata uživo i nastupa muzičkih umetnika i grupa; usluge razonode, naročito pojavljivanja muzičkih grupa, muzičkih umetnika i poznatih osoba uživo; usluge razonode u obliku nastupa muzičkih umetnika prenesenih putem televizije, radija, audio i video zapisa; usluge razonode, naročito nastupi muzičkih umetnika izvedeni uživo i snimljeni za buduću distribuciju; usluge obrazovanja i razonode, naročito produkcija i prezentacija televizijskih emisija, sportskih događaja, modnih događaja, kvizova, muzičkih emisija, emisija za dodelu nagrada i komičnih emisija uživo pred publikom, koji se emituju u živom prenosu ili se snimaju za kasnije emitovanje; usluge razonode, naročito obezbeđivanje internet sajta sa muzičkim nastupima, muzičkim spotovima, odgovarajućim filmskim snimcima, fotografijama i drugim multimedijalnim materijalima sa muzikom i zabavnim sadržajima koji se ne mogu preuzeti sa interneta; usluge razonode, naročito obezbeđivanje kritika muzike, muzičkih umetnika i muzičkih spotova na internetu; usluge razonode, naročito obezbeđivanje prethodno snimljenih zapisa muzike koji se ne mogu preuzeti, informacija u oblasti muzike i komentara i članaka u vezi sa muzikom, sve to preko interneta putem globalne računarske mreže; usluge razonode, naročito nastupi profesionalnih zabavljača uživo, na televiziji i na filmovima; sprovođenje izložbi zabavnog sadržaja u obliku muzičkih festivala; usluge razonode, naročito izvođenje izložbi u oblasti muzike i umetnosti; organizacija izložbi u svrhe razonode na kojima se pojavljuju muzika i umetnost; objavljivanje internet časopisa.

(210) Ž-2019-272

(220) 11.07.2019.

(731) SMS Tobacco Trading, 28 Jala Teratai J4/3, Taman Indah Jaya, 36000, Teluk Intan, Perak, MY

(540) MAXTRO

(550) I

(740) Dejan Raičević, Vojvode Boža br.1, 81250, Cetinje

(511) Klasa 34: duvan; aritkli za pušače; šibice; cigarete; kutije za cigarete; filteri za cigarete; muštikle; papir za cigarete; usnici za cigarete; usnici za muštikle; lule; cigarilosi; cigare; pepeljare za pušače; upaljači za šišače.

(210) Ž-2019-273

(220) 11.07.2019.

(731) SMS Tobacco Trading, 28 Jala Teratai J4/3, Taman Indah Jaya, 36000, Teluk Intan, Perak, MY

(540) REGO

(550) I

(740) Dejan Raičević, Vojvode Boža br.1, 81250, Cetinje

(511) Klasa 34: duvan; aritkli za pušače; šibice; cigarete; kutije za cigarete; filteri za cigarete; muštikle; papir za cigarete; usnici za cigarete; usnici za muštikle; lule; cigarilosi; cigare; pepeljare za pušače; upaljači za šišače.

(210) Ž-2019-274

(220) 11.07.2019.

(731) SMS Tobacco Trading, 28 Jala Teratai J4/3, Taman Indah Jaya, 36000, Teluk Intan, Perak, MY

(540) SLEVIN

(550) I

(740) Dejan Raičević, Vojvode Boža br.1, 81250, Cetinje

(511) Klasa 34: duvan; aritkli za pušače; šibice; cigarete; kutije za cigarete; filteri za cigarete; muštikle; papir za cigarete; usnici za cigarete; usnici za muštikle; lule; cigarilosi; cigare; pepeljare za pušače; upaljači za šišače.

(210) Ž-2019-275

(220) 11.07.2019.

(731) SMS Tobacco Trading, 28 Jala Teratai J4/3, Taman Indah Jaya, 36000, Teluk Intan, Perak, MY

(540) SPARTON

(550) I

(740) Dejan Raičević, Vojvode Boža br.1, 81250, Cetinje

(511) Klasa 34 duvan; aritkli za pušače; šibice; cigarete; kutije za cigarete; filteri za cigarete; muštikle; papir za cigarete; usnici za cigarete; usnici za muštikle; lule; cigarilosi; cigare; pepeljare za pušače; upaljači za šišače.

(210) Ž-2019-276

(220) 11.07.2019.

(731) Lidl Stiftung & Co. KG, Stiftsbergstraße 1, 74172, Neckarsulm, DE



(540)

(550) I

(740) MSA IP - Milojević Sekulić, Karađorđeva 65, 11000, Beograd, RS

(511) Klasa 16: Kese za smeće i džakovi od papira ili plastike.

(210) Ž-2019-277

(220) 12.07.2019.

(731) Airwair International Limited, Cobb's Lane, Wollaston, Northamptonshire, NN29 7SW, Wellingborough, GB

(540) AIRWAIR

(550) I

(740) Miladin Popović, Đoka Miraševića 21/III, 81000, Podgorica, ME, ME

(511) Klasa 3: Preparati za čišćenje i poliranje cipela; sapuni i deterdženti; krema i sredstva za poliranje čizama; crni lak za obuću (sredstva za poliranje obuće); vosak za cipele; kreme za kožne proizvode, sredstva za poliranje kožnih proizvoda; sredstva za poliranje obuće, sredstva za obnavljanje obuće, sredstva za čišćenje i zaštitu gornjih dijelova obuće koji su od tekstila; sredstva za čišćenje i zaštitu kožnih proizvoda.

Klasa 9: Sigurnosna i obuća i odjeća za upotrebu u industriji; zaštitna i sigurnosna oprema; sigurnosna obuća za zaštitu od nesreća ili povreda; zaštitna obuća za sprečavanje nesreća ili povreda; zaštitne cipele; zaštitne industrijske cipele; zaštitne cipele (od nezgode ili povrede); cipele za zaštitu od nesreća, zračenja i požara; čizme (zaštitna obuća); zaštitne industrijske čizme; sigurnosne čizme za upotrebu u industriji (za zaštitu od nesreće ili povreda); zaštitna odjeća za spriječavanje povreda; zaštitna odjeća za spriječavanje nesreća; odjeća za zaštitu od nesreća, zračenja i požara; izolovana odjeća za zaštitu od nesreća ili povreda; zaštitna radna odjeća (za zaštitu od nesreća ili povreda); odjeća za zaštitu od povreda; đonovi i ulošci za industrijsku obuću; jastučići za kolena za radnike; šlemovi; zaštitne rukavice.

Klasa 18: Koža, neobrađena ili poluobrađena; krzno, neobrađeno ili poluobrađeno; imitacije kože; vještačka koža; moleskin (imitacija kože); torbe; kaiševi za sedla, podesivi kaiševi za prtljag i kožni kaiševi za ramena; ženske tašne; džepni novčanici; kozmetičke torbice [prazne]; novčanici; futrole za ključeve; futrole za vizitkarte; sanduci (prtljag) i koferi; školske torbe i rančevi; školske torbe na rame; torbe na rame; pismo torbe; ruksaci; naprtnjače; torbe za kupovinu; sportske torbe; kontejneri, odnosno putni setovi (kožni proizvodi); putne torbe; kišobrani; suncobrani i štapovi za hodanje; ručke za štapove i štapovi za hodanje; aktovke; ručne torbe; velike torbe; bičevi, remenje i sedlarski proizvodi; kožne vezice; prtljag koji nije kožni; klasične velike torbe (tote).

Klasa 25: Odjeća; sportski dresovi; trikotaža (odjeća); odjeća za bebe; kaputi; ogrtači; majice; košulje; majice; polo majice; trikotaža; jakne; farmerke; topovi; pantalone; konfekcijska odjeća; helanke; najlonske carape; donje rublje; pokrivala za glavu; kape; šeširi; znojnici; kapuljace; male kape uz glavu; marama; šalovi marama (mufovi); marama za vrat; šalovi; rukavice (odjeća);

čarape; čarape (koje upijaju znoj); sokne; kaiševi; kožni remeni (odjeća); obuća; pričvršćivači pete, pomagala za fiksiranje pete; čizme; sportske čizme; podvezice; držači čarapa [tregeri]; pojasevi; sandale; cipele; gornji dijelovi čizama; ulošci za cipele; metalni dijelovi za obuću; đonovi za obuću; ulošci za obuću.

(210) Ž-2019-278

(220) 12.07.2019.

(731) Kite Pharma, Inc. (Delaware corporation), 2400 Broadway, 90404, Santa Monica, California, US



(540)

(550) I

(740) Božidar S. Radulović, Studentska bb, Lamela 3/18, 81000, Podgorica, ME

(511) Klasa 5: Farmaceutski preparati, naročito preparati za tretman kancera i tumora; farmaceutski preparati za imunoterapiju, uključujući terapiju T ćelijama.

Klasa 44: Pružanje medicinskih informacija; obezbeđivanje internet sajta na kome se nalaze medicinske informacije; pružanje medicinskih informacija, konsultantskih i savetodavnih usluga; uzimanje i čuvanje bioloških tkiva, krvi i ćelija.

(210) Ž-2019-281

(220) 16.07.2019.

(731) DOO BUIL'D, Bečići bb, PF 70, Budva, ME



(540)

(550) I

(511) Klasa 43: agencije za smještaj [hotelski, pansioniski]; aparati za kuvanje (iznajmljivanje); barovi (usluge barova); hotelske rezervacije (usluge rezerviranja hotela); hotelske usluge; kafane-restorani; privremeni smještaj (rezerviranje privremenog smještaja); restorani; restorani sa samoposluživanjem; restorani za brzo i stalno posluživanje [snek-barovi]; rezerviranje hotela; rezerviranje pansiona; rezerviranje privremenog smještaja; smještaj (agencije za izdavanje smještaja) [hoteli, pansioni]; smještaj (iznajmljivanje privremenog smještaja).

(210) Ž-2019-282

(220) 16.07.2019.

(731) DOO BUIL'D, Bečići bb, PF 70, Budva, ME



(540)

(550) I

(511) Klasa 36: nekretnine (procjena nekretnina); nekretnine (upravljanje nekretninama); upravljanje imovinom; upravljanje nekretninama; stanarine (naplata stanarina); stanovi (iznajmljivanje stanova); starine (procjena starina); agencije za stanove [nepokretna imovina]; zakup [vrsta iznajmljivanja dobara za profesionalne potrebe, koja temeljem ugovora mogu postati vlasništvo iznajmitelja] [lizing]; zakup nekretnina (davanje u zakup nekretnina) [lizing]

Klasa 43: agencije za smještaj [hotelski, pansioniski]; aparati za kuvanje (iznajmljivanje); barovi (usluge barova); hotelske rezervacije (usluge rezerviranja hotela); hotelske usluge; kafane-restorani; privremeni smještaj (rezerviranje privremenog smještaja); restorani; restorani sa samoposluživanjem; restorani za brzo i stalno posluživanje [snek-barovi]; rezerviranje hotela; rezerviranje pansiona; rezerviranje privremenog smještaja; smještaj (agencije za izdavanje smještaja) [hoteli, pansioni]; smještaj (iznajmljivanje privremenog smještaja).

(210) Ž-2019-283

(220) 16.07.2019.

(731) DOO BUIL'D, Bečići bb, PF 70, Budva, ME



(540)

(550) I

(511) Klasa 43: agencije za smještaj [hotelski, pansioniski]; aparati za kuvanje (iznajmljivanje); barovi (usluge barova); hotelske rezervacije (usluge rezerviranja hotela); hotelske usluge; kafane-restorani; privremeni

smještaj (rezervisanje privremenog smještaja); restorani; restorani sa samoposluživanjem; restorani za brzo i stalno posluživanje [snek-barovi]; rezervisanje hotela; rezervisanje pansiona; rezervisanje privremenog smještaja; smještaj (agencije za izdavanje smještaja) [hoteli, pansioni]; smještaj (iznajmljivanje privremenog smještaja).

(210) Ž-2019-284

(220) 16.07.2019.

(731) DOO BUIL'D, Bečići bb, PF 70, Budva, ME



(540)

(550) I

(511) Klasa 43: agencije za smještaj [hotelski, pansionski]; aparati za kuvanje (iznajmljivanje); barovi (usluge barova); hotelske rezervacije (usluge rezerviranja hotela); hotelske usluge; kafane-restorani; privremeni smještaj (rezervisanje privremenog smještaja); restorani; restorani sa samoposluživanjem; restorani za brzo i stalno posluživanje [snek-barovi]; rezervisanje hotela; rezervisanje pansiona; rezervisanje privremenog smještaja; smještaj (agencije za izdavanje smještaja) [hoteli, pansioni]; smještaj (iznajmljivanje privremenog smještaja).

(210) Ž-2019-285

(220) 17.07.2019.

(731) Reign Beverage Company LLC, a Delaware limited liability company, 1547 N. Knowles Ave., 90063, Los Angeles, California, US



(540)

(550) I

(740) Božidar S. Radulović, Studentska bb, Lamela 3/18, 81000, Podgorica, ME

(511) Klasa 32: Fitnes napici.

(210) Ž-2019-286

(220) 17.07.2019.

(731) Reign Beverage Company LLC, a Delaware limited liability company, 1547 N. Knowles Ave., 90063, Los Angeles, California, US



(540) **REIGN**

(550) I

(740) Božidar S. Radulović, Studentska bb, Lamela 3/18, 81000, Podgorica, ME

(511) Klasa 32: Fitnes napici

(210) Ž-2019-287

(220) 17.07.2019.

(731) Lidl Stiftung & Co. KG, Stiftsbergstrasse 1, 74172, Neckarsulm, DE



Giulio Pasotti

(540)

(550) I

(740) Branislav Lutovac, Bulevar Ivana Crnojevića 93, 81000, Podgorica, ME

(511) Klasa 33: Alkoholna pića (osim piva), naročito vina.

(210) Ž-2019-288

(220) 17.07.2019.

(731) Lidl Stiftung & Co. KG, Stiftsbergstrasse 1, 74172, Neckarsulm, DE



**BOTTE
DEI CONTI**

(540)

(550) I

(740) Branislav Lutovac, Bulevar Ivana Crnojevića 93, 81000, Podgorica, ME

(511) Klasa 33: Alkoholna pića (osim piva), naročito vina.

(210) Ž-2019-289

(220) 17.07.2019.

(731) Lidl Stiftung & Co. KG, Stiftsbergstrasse 1, 74172, Neckarsulm, DE

Casale ai campi

(540)

(550) I

(740) Branislav Lutovac, Bulevar Ivana Crnojevića 93, 81000, Podgorica, ME

(511) Klasa 33: Alkoholna pića (osim piva), naročito vina.

(210) Ž-2019-290

(220) 02.08.2019.

(731) "Plan B" d.o.o., Ul. Mitra Bakića br.40, 81000, Podgorica, ME, ME



(540)

(550) I

(511) Klasa 43: kafane, restorani

(210) Ž-2019-291

(220) 23.07.2019.

(731) 7-Eleven, Inc., 3200 Hackberry Road, 75063, Irving, Texas, US



(540)

(550) I

(740) Božidar S. Radulović, Studentska bb, Lamela 3/18, 81000, Podgorica, ME

(511) Klasa 30: Kafa; čaj; kakao; šećer; pirinač; tapioka; sago; testenina; zamene za kafu; brašno i proizvodi od žitarica; hleb; peciva; poslastice; ledene poslastice; kolači; biskviti, suvi kolačići; med; melasa; kvasac; prašak za pecivo; so; senf; sirće; začini; led; pekarske poslastice, tart (slatka pita bez gornje kore) i pite; salate od makarona, pirinča i testenina; začinski dodaci, naročito kečap (sos), reliš (dodatak jelu), kiseli krastavac; reliš od kiselog krastavca, roštiljski sos, ljuti sos, čili sos, sos od sira i majonez; punjene rolnice i sendviči; sendviči sa viršlama; smrznuti, gotovi ili spakovani obroci koji se prvenstveno sastoje od pirinča, rezanaca i/ili testenine; pirinčane kuglice; zemičke kuvane na pari; takito (mala pržena rolovana punjena tortilja) i sendvič vrapovi; pica; pekarski proizvodi, naime gibanice, fokča, keks, braunis, mafini i krofne; čokolada; koštunjavo voće, grickalice i proizvodi od hleba sa čokoladnim prelivom; slatkiši, čokoladice i zvakaće gume; napici na bazi kafe i čaja; topla čokolada; pločice sa jogurtom; čips i krekeri napravljeni od kukuruza, pšenice i žita; salsa sos; sladoled; pikantne grickalice; pločice od žitarica i energetske pločice; mešavina grickalica koja se prvenstveno sastoji od krekeri, pereca, i/ili gotovih kokica; mešavina grickalica koja se prvenstveno sastoji od koštunjavog voća sa prelivom (poslastica); žitarice, grickalice na bazi žitarica, zrna kukuruza, granole, pirinča i pšenice.

Klasa 35: Oglašavanje; vođenje poslova; poslovno upravljanje; kancelarijski poslovi; usluge maloprodaje u supermarketima u oblasti robe široke potrošnje.

Klasa 43: Usluge obezbeđivanja hrane i pića; privremeni smeštaj; obezbeđivanje privremenog boravka i/ili pansionskog boravka u hotelima, hostelima, pansionima, kampovima, smeštajima za odmor i turističkim smeštajima; usluge rezervisanja privremenog smeštaja za boravak i/ ili pansionski boravak u hotelima, hostelima, pansionima, kampovima, smeštajima za odmor i turističkim smeštajima; pružanje usluga restorana, barova, samouslužnih restorana, kantina, kafića, kafeterija i snek barova; usluge rezervisanja restorana, barova, samouslužnih restorana, kantina, kafića, kafeterija i snek barova.

(210) Ž-2019-292

(220) 25.07.2019.

(731) Marryvale Limited, 1 Mapp Street, Belize City, BZ



(540)

(550) I

(740) Jasna Jusić, Dalmatinska 2, 81000, Podgorica, ME

(511) Klasa 9: Računarski programi i računarski softveri, uključujući softvere koji se mogu preuzeti s interneta; mobilne aplikacije za mobilne telefone, tablete i druge uređaje koji se mogu držati u ruci; interaktivni računarski sistemi koji su povezani sa kockanjem i klađenjem ili ih sadrže, usluge zabave i razonode, igre, igre sa kartama, bingo, kazino igre i sportsko klađenje.

Klasa 41: Zabava; sportske i kulturne aktivnosti; usluge onlajn igara, kockanja i klađenja; kockanje i usluge igara za rad elektronskog binga, mreža sajtova za igranje binga onlajn, virtuelne slot mašine i druge instant igre; sportsko klađenje i lutrije i usluge onlajn kladionice; pružanje usluga kazino igara uključujući rulet igre, slot mašine, bingo igre, blekdžek, keno, bakara, grebalice, poker i sportsko klađenje; obezbjeđivanje usluga poker igre kojoj korisnici na mreži mogu pristupiti širom mreže; obezbjeđivanje igranja karata za više igrača kojima korisnici na mreži mogu pristupiti širom mreže; organizacija, produkcija i prezentacija turnira, takmičenja, igara i događaja; zabava i usluge interaktivne zabave; organizacija zabave, razonode, takmičenja, igara, kockanja, klađenja, igara sa kartama, sportskog klađenja i lutrija; uključujući pružanje svih navedenih usluga pomoću raznovrsnih tehnoloških platformi, uključujući, bez ograničenja, i putem telefona, mobilnih ili drugih uređaja koji se mogu držati u ruci ili onlajn putem iz kompjuterske baze podataka ili preko interneta; usluge podrške i savjetodavne usluge i pružanje informacija u vezi sa svim prethodno navedenim uslugama.

(210) Ž-2019-293

(220) 25.07.2019.

(731) DOO "KAFOTEKA", Vaka Đurovića bb, 81000, Podgorica, ME, ME



(540)

(550) I

(511) Klasa 30: kafa, čaj, kakao, šećer, riža, tapioka, sago, zamjene za kafu; brašno i proizvodi od žitarica, hleb, kolači, poslastice, bomboni, sladoled; med, sirup od melase; kvasac, prašak za pecivo; so, senf; sirće, preliv; začini, razni začini; led za hlađenje.

Klasa 32: pivo; mineralne i gazirane vode i ostala bezalkoholna pića; pića od voća i voćni sokovi; sirupi i ostali preparati za pripremanje napitaka.

Klasa 33: alkoholna pića (osim piva).

Klasa 35: oglašavanje; vođenje poslova; poslovno upravljanje; kancelarijski poslovi; usluge koje pružaju lica ili organizacije u pomoći u radu ili upravljanju preduzećima i u vođenju poslova preduzeća; usluge koje pružaju preduzeća koja se bave oglašavanjem (reklamiranjem), tako što, za račun drugih lica, komuniciraju sa javnošću (reklama) putem prenosa bilo kakvih informacija o proizvodima i uslugama omogućavajući potrošačima prigodan pogled na te proizvode i usluge; usluge koje se sastoje od upisivanja, uređivanja, obrade, prerade ili sistematizacije pisanih informacija i zapisa; usluge reklamnih agencija; distribuciju prospekata i uzoraka direktno ili poštom; izradu i korišćenje matematičkih i statističkih podataka; organizovanje sajmova i izložbi u komercijalne ili reklamne svrhe.

(210) Ž-2019-294

(220) 26.07.2019.

(731) Apivita S.A., Industrial Park of Markopoulo, 19003 , Markopoulo Mesogaias, GR

(540) APIVITA

(550) I

(740) Božidar S. Radulović, Studentska bb, Lamela 3/18, 81000, Podgorica, ME

(511) Klasa 3: Kozmetički preparati za mršavljenje, kozmetika, kozmetika za životinje, kozmetičke kreme, kreme za izbjeljivanje kože, ljepila za kozmetičke svrhe, preparati aloe vere za kozmetičke svrhe, alum kamenčići (astringenti), geraniol, terpeni (eterična ulja), ulja za kozmetičke potrebe, ulja za parfeme i mirise, ulja ruže, eterična ulja, masti za kozmetičke potrebe bergamot ulje, ulje lavande, voda lavande, losioni za kozmetičke svrhe, balzami osim za medicinske svrhe, ulje jasmina, esencija mente (eterično ulje), eterična ulja kedra, aromatična eterična ulja, eterična ulja limuna, eterična ulja citriona, maramice impregnirane kozmetičkim losionima, kozmetički preparati za kupanje i tuširanje, soli za kupanje koje nisu za medicinske potrebe, losioni nakon brijanja, sredstva za izbjeljivanje (dekoloranti) za kozmetičke svrhe, vodonik peroksid za kozmetičke svrhe, pomade za kozmetičke svrhe, bademovo mlijeko za kozmetičke svrhe, bademovo ulje, bademov sapun, eterične esencije, eterična ulja, ekstrakti cvijeća (parfemi) kolonjska voda, parfimerija, baze za cvjetne parfeme, potpuriji (mirisi), preparati za odušivanje zraka, kozmetika za obrve, olovke za obrve, kozmetički proizvodi, sredstva za zaštitu od sunca, preparati za sunčanje (kozmetika), kreme za zaštitu od sunca; kozmetički preparati za zaštitu kože od sunčevih zraka; preparati za zaštitu od sunca; losioni nakon sunčanja; proizvodi nakon sunčanja, uključujući kreme i losione; preparati za njegu kože, preparati za šminkanje, preparati za uklanjanje šminke, mlijeko za skidanje šminke, maskare, maske za ljepotu, temelji, prahovi (kompaktni prašci, praškovi za prašinu), praškovi za lice, kozmetika za oči, kozmetički preparati za trepavice, liiepkovi za pričvršćivanje lažnih trepavica, sjajila za usne, ruževe za usne, olovke za oči i usne, ajlajneri i ruževi za usne, rumenila, olovke za oči, prah za obrve, kozmetičke olovke, neutralizatori za trajno uvijanje, vosak za nausnice, paste za britve, preparati za njegu noktiju, lak za nokte, sjaj za nokte, preparati za uklanjanje laka, kozmetički proizvodi za uklanjanje šminke kao što su kreme, losioni i impregnirana tkanina za kozmetičku upotrebu; adstringensi za kozmetičke svrhe, antiperspirantni sapuni, sprejevi za osvježivanje daha, trake za osvježivanje daha, gelovi za izbjeljivanje zuba, gelovi za masažu, osim za medicinske svrhe, sredstva za ispiranje usta za medicinske potrebe, paste za zube, sredstva za čišćenje zubnih proteza, mlijeko za čišćenje za svrhe lične higijene, talk puder za svrhu lične higijene, sredstva za čišćenje, preparati za brijanje, preparati za suvo čišćenje, preparati za pranje za ličnu higijenu ili dezodorans (toaletne potrepštine), toaletna voda, toaletne potrepštine, antiperspiranti (toaletne potrepštine), ulja za toaletne potrebe, boje za toaletne potrebe, mirisna voda, kozmetički kompleti, pamučni štapići i vata za kozmetičke svrhe, sapun, „kolači od sapuna“, sapun za dezodorans, tečni sapun, sapun za brijanje, sapun za znojenje stopala, šampon, suvi šampon, šampon za kućne ljubimce, dezodorans za osobnu upotrebu, dezodoransi za ljude ili za životinje i kućne ljubimce, depilatori, preparate za depilaciju, depilatorni vosak, kozmetičke boje, puder, proizvodi za zaštitu usana, preparati za uvijanje kose, sredstva za tretiranje kose, boje za kosu, koloranti za kosu, lak za kosu, preparati za uvijanje kose, boje za bradu.

Klasa 5: Medicinski preparati za rast kose, stomatološki mastici, medicinske infuzije, medicinska ulja, medicinski korijeni, medicinski čaj, mlijeko badema za farmaceutske svrhe, sirupi za farmaceutske svrhe, sredstva za vaginalno ispiranje, termalna voda, morska voda za ljekovito kupanje, mineralne vode za medicinske potrebe, sredstva za ispiranje usta za medicinske svrhe, masti za farmaceutske svrhe, pastile za

farmaceutske potrebe, blato za kupanje, ljekovito blato, medicinski sediment, prehrambeni dodaci, dijetetski dodaci propolisa, propolis za farmaceutske svrhe, proteinski dijetetski dodaci, dodaci ishrani od matične mliječi, matična mliječ u farmaceutske svrhe, soli za medicinske svrhe, farmaceutski i veterinarski preparati; dodaci prehrani od polena, sanitarni proizvodi za medicinske potrebe; preparati za žuljeve, biljni čajevi za medicinske svrhe, biološki pripravci za medicinske svrhe, albuminski prehrambeni proizvodi za medicinske svrhe, losioni za farmaceutske potrebe, dijetetske tvari prilagođene za medicinsku upotrebu, farmaceutski pripravci za njegu kože, medicinski pripravci za mršavljenje, masti za opekotine od sunca, preparati za opekotine od sunca za farmaceutske svrhe, balzami za medicinske svrhe, balzamski preparati za medicinske svrhe, pomade za medicinske potrebe, soli za kupanje u medicinske svrhe, preparati od aloe vere za farmaceutske svrhe, pripravci za kupanje s medicinskom terapijom, terapijski pripravci za kupanje, soli mineralne vode, soli za kupke od mineralne vode, slatkiši za medicinske potrebe, žvakaće gume za medicinske potrebe, hrana za bebe; ubrusi za bebe, pelene za bebe, flasteri, materijali za zavoje; dezinficijensi; bakterijski otrovi, bakterijski pripravci za medicinsku i veterinarsku upotrebu, biocidi, preparati za uništavanje štetočina; fungicidi, herbicidi, repelenti za insekte, preparati za ozeblina, preparati za čišćenje kontaktnih sočiva, farmaceutski pripravci za liječenje peruti, pripravci od kuvanih trava za farmaceutske svrhe, sapun za dezinfekciju, sapun za medicinsku njegu, medicinski šampon.

Klasa 35: Maloprodajne usluge, veleprodajne usluge, kataloške maloprodajne usluge i online maloprodajne usluge u odnosu na gore navedene proizvode klase 3 i klase 5.

(210) Ž-2019-295

(220) 26.07.2019.

(731) Apivita S.A., Industrial Park of Markopoulo, 19003 , Markopoulo Mesogaias, GR

APIVITA



(540)

(550) I

(740) Božidar S. Radulović, Studentska bb, Lamela 3/18, 81000, Podgorica, ME

(511) Klasa 3: Kozmetički preparati za mršavljenje, kozmetika, kozmetika za životinje, kozmetičke kreme, kreme za izbjeljivanje kože, ljepila za kozmetičke svrhe, preparati aloe vere za kozmetičke svrhe, alum kamenčići (astringenti), geraniol, terpeni (eterična ulja), ulja za kozmetičke potrebe, ulja za parfeme i mirise, ulja ruže, eterična ulja, masti za kozmetičke potrebe bergamot ulje, ulje lavande, voda lavande, losioni za kozmetičke svrhe, balzami osim za medicinske svrhe, ulje jasmina, esencija mente (eterično ulje), eterična ulja kedra, aromatična eterična ulja, eterična ulja limuna, eterična ulja citriona, maramice impregnirane kozmetičkim losionima, kozmetički preparati za kupanje i tuširanje, soli za kupanje koje nisu za medicinske potrebe, losioni nakon brijanja, sredstva za izbjeljivanje (dekoloranti) za kozmetičke svrhe, vodonik peroksid za kozmetičke svrhe, pomade za kozmetičke svrhe, bademovo mlijeko za kozmetičke svrhe, bademovo ulje, bademov sapun, eterične esencije, eterična ulja, ekstrakti cvijeća (parfemi) kolonjska voda, parfimerija, baze za cvjetne parfeme, potpuriji (mirisi), preparati za odušivanje zraka, kozmetika za obrve, olovke za obrve, kozmetički proizvodi, sredstva za zaštitu od sunca, preparati za sunčanje (kozmetika), kreme za zaštitu od sunca; kozmetički preparati za zaštitu kože od sunčevih zraka; preparati za zaštitu od sunca; losioni nakon sunčanja; proizvodi nakon sunčanja, uključujući kreme i losione; preparati za njegu kože, preparati za šminkanje, preparati za uklanjanje šminke, mlijeko za skidanje šminke, maskare, maske za ljepotu, temelji, prahovi (kompaktni prašci, praškovi za prašinu), praškovi za lice, kozmetika za oči, kozmetički preparati za trepavice, liiepkovi za pričvršćivanje lažnih trepavica, sjajila za usne, ruževe za usne,

olovke za oči i usne, ajlajneri i ruževi za usne, rumenila, olovke za oči, prah za obrve, kozmetičke olovke, neutralizatori za trajno uvijanje, vosak za nausnice, paste za britve, preparati za njegu noktiju, lak za nokte, sjaj za nokte, preparati za uklanjanje laka, kozmetički proizvodi za uklanjanje šminke kao što su kreme, losioni i impregnirana tkanina za kozmetičku upotrebu; adstringensi za kozmetičke svrhe, antiperspirantni sapuni, sprejevi za osvježivanje daha, trake za osvježivanje daha, gelovi za izbjeljivanje zuba, gelovi za masažu, osim za medicinske svrhe, sredstva za ispiranje usta za medicinske potrebe, paste za zube, sredstva za čišćenje zubnih proteza, mlijeko za čišćenje za svrhe lične higijene, talk puder za svrhu lične higijene, sredstva za čišćenje, preparati za brijanje, preparati za suvo čišćenje, preparati za pranje za ličnu higijenu ili dezodorans (toaletne potrepštine), toaletna voda, toaletne potrepštine, antiperspiranti (toaletne potrepštine), ulja za toaletne potrebe, boje za toaletne potrebe, mirisna voda, kozmetički kompleti, pamučni štapići i vata za kozmetičke svrhe, sapun, „kolači od sapuna”, sapun za dezodorans, tečni sapun, sapun za brijanje, sapun za znojenje stopala, šampon, suvi šampon, šampon za kućne ljubimce, dezodorans za osobnu upotrebu, dezodoransi za ljude ili za životinje i kućne ljubimce, depilatori, preparate za depilaciju, depilatorni vosak, kozmetičke boje, puder, proizvodi za zaštitu usana, preparati za uvijanje kose, sredstva za tretiranje kose, boje za kosu, koloranti za kosu, lak za kosu, preparati za uvijanje kose, boje za bradu.

Klasa 5: Medicinski preparati za rast kose, stomatološki mastici, medicinske infuzije, medicinska ulja, medicinski korijeni, medicinski čaj, mlijeko badema za farmaceutske svrhe, sirupi za farmaceutske svrhe, sredstva za vaginalno ispiranje, termalna voda, morska voda za ljekovito kupanje, mineralne vode za medicinske potrebe, sredstva za ispiranje usta za medicinske svrhe, masti za farmaceutske svrhe, pastile za farmaceutske potrebe, blato za kupanje, ljekovito blato, medicinski sediment, prehrambeni dodaci, dijetetski dodaci propolisa, propolis za farmaceutske svrhe, proteinski dijetetski dodaci, dodaci ishrani od matične mliječi, matična mliječ u farmaceutske svrhe, soli za medicinske svrhe, farmaceutski i veterinarski preparati; dodaci prehrani od polena, sanitarni proizvodi za medicinske potrebe; preparati za žuljeve, biljni čajevi za medicinske svrhe, biološki pripravci za medicinske svrhe, albuminski prehrambeni proizvodi za medicinske svrhe, losioni za farmaceutske potrebe, dijetetske tvari prilagođene za medicinsku upotrebu, farmaceutski pripravci za njegu kože, medicinski pripravci za mršavljenje, masti za opekotine od sunca, preparati za opekotine od sunca za farmaceutske svrhe, balzami za medicinske svrhe, balzamski preparati za medicinske svrhe, pomade za medicinske potrebe, soli za kupanje u medicinske svrhe, preparati od aloe vere za farmaceutske svrhe, pripravci za kupanje s medicinskom terapijom, terapijski pripravci za kupanje, soli mineralne vode, soli za kupke od mineralne vode, slatkiši za medicinske potrebe, žvakaće gume za medicinske potrebe, hrana za bebe; ubrusi za bebe, pelene za bebe, flasteri, materijali za zavoje; dezinficijensi; bakterijski otrovi, bakterijski pripravci za medicinsku i veterinarsku upotrebu, biocidi, preparati za uništavanje štetočina; fungicidi, herbicidi, repelenti za insekte, preparati za ozeblina, preparati za čišćenje kontaktnih sočiva, farmaceutski pripravci za liječenje peruti, pripravci od kuvanih trava za farmaceutske svrhe, sapun za dezinfekciju, sapun za medicinsku njegu, medicinski šampon.

Klasa 35: Maloprodajne usluge, veleprodajne usluge, kataloške maloprodajne usluge i online maloprodajne usluge u odnosu na gore navedene proizvode klase 3 i klase 5.

(210) Ž-2019-297

(220) 26.07.2019.

(731) AMGEN İLAÇ TICARET LIMITED SİRKETİ, Is Kuleleri Levent Mah. Meltem Sokak No:10 Kule:2 Kat:25, 4.Levent Besiktas, Istanbul, TR



(540)

(550) I

(740) Božidar S. Radulović, Studentska bb, Lamela 3/18, 81000, Podgorica, ME

(511) Klasa 5: Farmaceutski preparati; farmaceutski preparati za upotrebu u tretmanu bolesti ili poremećaja kostiju, zglobova, kičmenog stuba, tankog creva, debelog creva, kože, pluća, oka, dojke, jajnika, grlića materice, želuca, bešike, bubrega, glave, mozga, vrata, krvi i farmaceutski preparati za lečenje autoimunih bolesti, bolesti imunog sistema, zapaljenskih bolesti, zapaljenske bolesti creva, gastrointestinalnih, genitourinarnih, mišićno-skeletnih, mišićnih, dermatoloških, plućnih, respiratornih, onkoloških, hepatoloških, virusnih, metaboličkih, endokrinih, kardiovaskularnih, kardiopulmonalnih, bolesti seksualne disfunkcije, oftalmoloških, neuroloških, hormonskih i psihijatrijskih bolesti i poremećaja; farmaceutski preparati za lečenje autoimunih bolesti i poremećaja.

Klasa 10: Medicinski uređaji i instrumenti; uređaji za otpuštanje leka; sistemi za dopremanje lekova; uređaji za ubrizgavanje za farmaceutske preparate; medicinski špricevi; hirurški uređaji i instrumenti; hirurški instrumenti i aparati; i hirurški i medicinski aparati i instrumenti za upotrebu u opštoj hirurgiji.

Klasa 35: Usluge distributerstva i usluge koje se sastoje od prikupljanja, za potrebe drugih, farmaceutskih i veterinarskih preparata za medicinske namene, hemijskih preparata za medicinske i veterinarske namene, hemijskih reagenasa za farmaceutske i veterinarske namene, medicinske kozmetike, dijetetskih dodataka ishrani za farmaceutske i veterinarske namene, dijetetskih suplemenata, suplemenata sa hranljivim sastojcima, medicinskih preparata za mršavljenje, hrane za bebe, bilja i biljnih napitaka prilagođenih za medicinske namene, stomatoloških preparata i proizvoda, materijala za stomatološke ispune, materijala za uzimanje dentalnih otisaka, stomatoloških lepkova i materijala za popravku zuba, sanitarnih preparata za medicinsku upotrebu, higijenskih uložaka, higijenskih tampona, flastera, materijala za previjanje, papirnih i tekstilnih pelena za bebe, odrasle osobe i kućne ljubimce, preparata za uništavanje štetočina, herbicida, fungicida, preparata za uništavanje glodara, dezodoranasa osim onih za ljude ili za životinje, preparata za prečišćavanje vazduha, preparata za dezodoraciju vazduha, sredstava za dezinfekciju, antiseptika, detergenata za medicinske namene, medicinskih sapuna, sapuna za dezinfekciju, antibakterijskih losiona za ruke, farmaceutskih preparata, farmaceutskih preparata za upotrebu u tretmanu bolesti ili poremećaja kostiju, zglobova, kičmenog stuba, tankog creva, debelog creva, kože, pluća, oka, dojke, jajnika, grlića materice, želuca, bešike, bubrega, glave, mozga, vrata, i krvi i farmaceutskih preparata za lečenje autoimunih bolesti, bolesti imunog sistema, zapaljenskih bolesti, zapaljenske bolesti creva, gastrointestinalnih, genitourinarnih, mišićno-skeletnih, mišićnih, dermatoloških, plućnih, respiratornih, onkoloških, hepatoloških, virusnih, metaboličkih, endokrinih, kardiovaskularnih, kardiopulmonalnih, bolesti seksualne disfunkcije, oftalmoloških, neuroloških, hormonskih, i psihijatrijskih bolesti i poremećaja, farmaceutskih preparata za lečenje autoimunih bolesti i poremećaja, hirurških, medicinskih, stomatoloških i veterinarskih aparata i instrumenata, nameštaja posebno proizvedenog za medicinske namene, veštačkih udova i proteza, medicinskih ortopedskih proizvoda, steznika za medicinske namene, ortopedskih cipela, elastičnih zavoja i zavoja koji pružaju podršku, hirurških kecelja i hirurških sterilnih čaršafa, seksualnih pomagala za odrasle, kondoma, bočica za bebe, cuclli varalica za bebe, cuclli, igračkaka za bebe za podršku kod rasta zuba, narukvica i prstenova za medicinske namene, antireumatskih narukvica, antireumatskih prstenova, medicinskih uređaja i instrumenata, uređaja za otpuštanje lekova, sistema za dopremanje lekova, uređaja za ubrizgavanje za farmaceutske preparate, medicinskih špriceva, hirurških uređaja i instrumenata, hirurških instrumenata i aparata i hirurških i medicinskih aparata i instrumenata za upotrebu u opštoj hirurgiji, koji omogućavaju klijentima da na jednostavan način pogledaju i kupe robu, gde takve

usluge mogu da budu obezbeđene u maloprodajnim objektima, velikoprodajnim objektima, putem elektronskih medija ili putem kataloga za naručivanje poštom; usluge upućivanja, naročito obezbeđenja informacija o proizvodima klijentima u oblasti farmaceutskih proizvoda, zdravstvenih proizvoda i medicinskih proizvoda; distribucija uzoraka za svrhe ocenjivanja medicinskih proizvoda, kutija za otpad od oštih predmeta za medicinske svrhe i odgovarajućih prenosnih medicinskih frižidera; obezbeđivanje komercijalnog informacionog direktorijuma na internetu za oblasti farmaceutskih proizvoda, zdravstvenih proizvoda i medicinskih proizvoda; usluge oglašavanja i marketinga.

Klasa 41: Obezbeđivanje onlajn publikacija u obliku brošura i biltena u oblasti farmaceutskih sredstava, biološki sličnih sredstava, lekova i zdravlja; organizacija i realizacija časova, seminara i radionica u oblasti farmaceutskih sredstava, biološki sličnih sredstava, lekova i zdravlja; obrazovne usluge, naročito programi o farmaceutskim sredstvima, biološki sličnim sredstvima, lekovima i zdravlju kojima se može pristupiti preko audio, video, i aplikacija na internetu, aplikacija za mobilne telefone i računarskih mreža; obrazovne usluge, naročito realizacija programa u oblasti farmaceutskih sredstava, biološki sličnih sredstava, lekova i zdravlja.

Klasa 42: Istraživanje i razvoj farmaceutskih preparata i biološki sličnih sredstava; istraživanje i razvoj u farmaciji i biotehnologiji; informacije o medicinskim i naučnim istraživanjima u oblasti farmaceutskih sredstava, biološki sličnih sredstava i kliničkih studija; obezbeđivanje veb-sajtova sa informacijama o farmaceutskim preparatima i biološki sličnim sredstvima; usluge podrške u vezi sa farmaceutskim i biološki sličnim sredstvima, naročito usluge podrške za korisnike; obezbeđenje onlajn računarskog softvera koji se koristi za pristup, upravljanje, ažuriranje i prikazivanje elektronskih baza podataka u oblasti farmaceutskih preparata i biološki sličnih sredstava.

Klasa 44: Obezbeđivanje medicinskih informacija i usluge pružanja podrške pacijentima, naročito farmaceutski saveti i konsultacije u vidu obezbeđenja onlajn informacija o farmaceutskim sredstvima i lečenju i prevenciji različitih bolesti, poremećaja i oboljenja; obezbeđivanje zdravstvenih i medicinskih informacija o farmaceutskim sredstvima; usluge informisanja, naročito obezbeđivanja medicinskih informacija pacijentima; obezbeđivanje medicinskih konsultacija i savetodavnih usluga putem globalne računarske mreže u oblasti farmaceutskih sredstava i različitih bolesti, poremećaja i oboljenja; obezbeđivanje medicinskih informacija za pacijente koji pate od kancera; obezbeđivanje usluga podrške pacijentima koje se odnose na kancer i lečenje kancera; obezbeđivanje informacija o zdravlju kostiju kod ležećih pacijenata koji pate od kancera pružanjem lično prilagođenih medicinskih informacija i praktičnih saveta za komunikaciju o zdravlju kostiju sa zdravstvenim radnicima; obezbeđivanje medicinskih saveta i saveta preko globalne računarske mreže u oblasti ustuga informisanja u vezi sa zdravljem kostiju, uključujući i u slučaju kancera; obezbeđivanje medicinskih informacija i usluge pružanja podrške pacijentima uključujući i u oblasti zdravlja kostiju, prevencije osteoporoze, farmaceutskih saveta i savetovanja u obliku informacija na internetu o lečenju osteoporoze i bolesti kostiju i farmaceutskim preparatima za lečenje osteoporoze; obezbeđivanje medicinskih izveštaja o pacijentima lečenim od osteoporoze i bolesti kostiju; medicinski saveti i saveti putem globalne računarske mreže u oblasti lečenja kancera i hemoterapije; obezbeđenje medicinskih informacija i usluga pružanja podrške pacijentima, npr. farmaceutskih saveta i usluga savetovanja kako bi se obezbedile onlajn informacije o imunotrombocitopeniji purpura (ITP); obezbeđivanje zdravstvenih i medicinskih informacija o imunotrombocitopeniji purpura (ITP); obezbeđivanje medicinskih informacija za pacijente koji pate od imunotrombocitopenije purpura (ITP); obezbeđivanje usluga pružanja podrške pacijentima kod lečenja medicinskih stanja, uključujući obezbeđivanje informacija o pacijentima i informacija o primeni lekova za porodice pacijenata, i obezbeđivanje medicinskih informacija za pacijente, kako bi se informisali o medicinskim pitanjima i procesima kod zdravstvenih radnika; usluge u oblasti pružanja informacija o pravilnoj primeni lekova.

(210) Ž-2019-298

(220) 26.07.2019.

(731) 7-Eleven, Inc., 3200 Hackberry Road, 75063, Irving, Texas, US



(550) I

(740) Božidar S. Radulović, Studentska bb, Lamela 3/18, 81000, Podgorica, ME

(511) Klasa 30: Kafa; čaj; kakao; šećer; pirinač ; tapioka; sago; testenina; zamene za kafu; brašno i proizvodi od žitarica; hleb; peciva; poslastice; ledene poslastice; kolači, biskviti, suvi kolačići; med, melasa; kvasac; prašak za pecivo; so, senf; sirće; začini; led; pekarske poslastice, tart (slatka pita bez gornje kore) i pite; salate od makarona, pirinča i testenina; začinski dodaci, naročito kečap (sos), reliš (dodatak jelu), kiseli krastavac, reliš od kiselog krastavca, roštiljski sos, ljuti sos, čili sos, sos od sira i majonez; punjene rolnice i sendviči; sendviči sa viršlama; smrznuti, gotovi ili spakovani obroci koji se prvenstveno sastoje od pirinča, rezanaca i/ili testenine; pirinčane kuglice; zemičke kuvane na pari; takito (mala pržena rolovana punjena tortilja) i sendvič vrapovi; pica; pekarski proizvodi, naime gibanice, fokača, keks, braunis, mafini i krofne; čokolada; koštunjavo voće, grickalice i proizvodi od hleba sa čokoladnim prelivom; slatkiši, čokoladice i zvakaće gume; napici na bazi kafe i čaja; topla čokolada; pločice sa jogurtom; čips i krekeri napravljeni od kukuruza, pšenice i žita; salsa sos; sladoled; pikantne grickalice; pločice od žitarica i energetske pročiće; mešavina grickalica koja se prvenstveno sastoji od krekeri, pereca, i/ili gotovih kokica; mešavina grickalica koja se prvenstveno sastoji od koštunjavog voća sa prelivom (poslastica); žitarice, grickalice na bazi žitarica, zrna kukuruza, granole, pirinča i pšenice.

Klasa 35: Oglašavanje; vođenje poslova; poslovno upravljanje; kancelarijski poslovi; usluge maloprodaje u supermarketima u oblasti robe široke potrošnje.

Klasa 43: Usluge obezbeđivanja hrane i pića; privremeni smeštaj; obezbeđivanje privremenog boravka i/ili pansioniskog boravka u hotelima, hostelima, pansionima, kampovima, smeštajima za odmor i turističkim smeštajima; usluge rezervisanja privremenog smeštaja za boravak i/ili pansioniski boravak u hotelima, hostelima, pansionima, kampovima, smeštajima za odmor i turističkim smeštajima; pružanje usluga restorana, barova, samouslužnih restorana, kantina, kafića, kafeterija i snek barova; usluge rezervisanja restorana, barova, samouslužnih restorana, kantina, kafića, kafeterija i snek barova.

(210) Ž-2019-299

(220) 26.07.2019.

(731) 7-Eleven, Inc., 3200 Hackberry Road, 75063, Irving, Texas, US

(540) 7-ELEVEN

(550) I

(740) Božidar S. Radulović, Studentska bb, Lamela 3/18, 81000, Podgorica, ME

(511) Klasa 30: Kafa; čaj; kakao; šećer; pirinač ; tapioka; sago; testenina; zamene za kafu; brašno i proizvodi od žitarica; hleb; peciva; poslastice; ledene poslastice; kolači, biskviti, suvi kolačići; med, melasa; kvasac; prašak za pecivo; so, senf; sirće; začini; led; pekarske poslastice, tart (slatka pita bez gornje kore) i pite; salate od makarona, pirinča i testenina; začinski dodaci, naročito kečap (sos), reliš (dodatak jelu), kiseli krastavac, reliš od kiselog krastavca, roštiljski sos, ljuti sos, čili sos, sos od sira i majonez; punjene rolnice i

sendviči; sendviči sa viršlama; smrznuti, gotovi ili spakovani obroci koji se prvenstveno sastoje od pirinča, reznaca i/ili testenine; pirinčane kuglice; zemičke kuvane na pari; takito (mala pržena rolovana punjena tortilja) i sendvič vrapovi; pica; pekarski proizvodi, naime gibanice, fokača, keks, braunis, mafini i krofne; čokolada; koštunjavo voće, grickalice i proizvodi od hleba sa čokoladnim prelivom; slatkiši, čokoladice i zvakaće gume; napici na bazi kafe i čaja; topla čokolada; pločice sa jogurtom; čips i krekeri napravljeni od kukuruza, pšenice i žita; salsa sos; sladoled; pikantne grickalice; pločice od žitarica i energetske pročiće; mešavina grickalica koja se prvenstveno sastoji od kreker, pereca, i/ili gotovih kokica; mešavina grickalica koja se prvenstveno sastoji od koštunjavog voća sa prelivom (poslastica); žitarice, grickalice na bazi žitarica, zrna kukuruza, granole, pirinča i pšenice.

Klasa 35: Oglašavanje; vođenje poslova; poslovno upravljanje; kancelarijski poslovi; usluge maloprodaje u supermarketima u oblasti robe široke potrošnje.

Klasa 43: Usluge obezbeđivanja hrane i pića; privremeni smeštaj; obezbeđivanje privremenog boravka i/ili pansionskog boravka u hotelima, hostelima, pansionima, kampovima, smeštajima za odmor i turističkim smeštajima; usluge rezervisanja privremenog smeštaja za boravak i/ili pansionski boravak u hotelima, hostelima, pansionima, kampovima, smeštajima za odmor i turističkim smeštajima; pružanje usluga restorana, barova, samouslužnih restorana, kantina, kafića, kafeterija i snek barova; usluge rezervisanja restorana, barova, samouslužnih restorana, kantina, kafića, kafeterija i snek barova.

(210) Ž-2019-300

(220) 29.07.2019.

(731) Kerzner International Limited, Atlantis Paradise Island, Coral Towers Executive Office, P.O. Box N4777, Nassau, BS

(540) ONLY HERE

(550) I

(740) Jasna Jusić, Dalmatinska 2, 81000, Podgorica, ME

(511) Klasa 43 Pružanje usluga odmarališta i smještaja; pružanje privremenog smještaja; obezbjeđivanje hotelskog smještaja; hotelske usluge; usluge hotela rizorta u vidu organizovanja smještaja u odmaralištima; restoranske i barske usluge; obezbjeđivanje kongresnih objekata, pružanje objekata (smještaja) za priredbe i sastanke; usluge putničkih agencija, naime rezervisanje i bukiranje za privremeni smještaj, rezervisanje i bukiranje za objedovanje.

(210) Ž-2019-301

(220) 31.07.2019.

(731) Kite Pharma, Inc., (Delaware corporation), 2400 Broadway, 90404, Santa Monica, California, US

(540)  YESCARTA

(550) I

(740) Božidar S. Radulović, Studentska bb, Lamela 3/18, 81000, Podgorica, ME

(511) Klasa 5: Farmaceutski preparati za upotrebu u lečenju kancera; farmaceutski preparati za imunoterapiju, uključujući ćelijsku terapiju i gensku terapiju; biološki preparati za lečenje kancera.

Klasa 44: Obezbeđivanje medicinskih i zdravstvenih informacija; obezbeđivanje medicinskih informacija u oblasti farmaceutskih sredstava i ćelijske terapije.

(210) Ž-2019-302

(220) 02.08.2019.

(731) International Foodstuffs Co LLC, P.O. Box No. 4115, Sharjah, AE

(540) QUANTA

(550) I

(740) Miladin Popović, Đoka Miraševića 21/III , 81000, Podgorica, ME, ME

(511) Klasa 30: Čokolade, poslastice, bombone, biskviti (sve vrste), kolači, tjestenina, makaroni, rezanci, instant rezanci, špageti, rezanci za supu, kvasac, prašak za pecivo i drugi pekarski sastojci, prelive za salate, majonez, sirće, kečap i sosevi (začini), polugotovì proizvodi od tijesta, smiznuto tijesto, smrznuto beskvasno indijsko tijesto (parata), sladoledi, smrznuti nemliječni deserti, smrznuti voćni deserti, ledeni deserti, kafa, čaj, kakao, šećer, pirinač, tapioka, sago, zamjene za kafu, hleb, pecivo, sirup, so, senf, brašno napravljeno od žitarica, začini., hranljivi napici (na bazi žitarica i bilja), umaci, biljni čaj, med.

(210) Ž-2019-303

(220) 02.08.2019.

(731) International Foodstuffs Co LLC, P.O. Box No. 4115, Sharjah, AE

(540) TIFFANY BREAK

(550) I

(740) Miladin Popović, Đoka Miraševića 21/III , 81000, Podgorica, ME, ME

(511) Klasa 30: Čokolade, poslastice, bombone, biskviti (sve vrste), kolači, tjestenina, makaroni, rezanci, instant rezanci, špageti, rezanci za supu, kvasac, prašak za pecivo i drugi pekarski sastojci, prelive za salate, majonez, sirće, kečap i sosevi (začini), polugotovì proizvodi od tijesta, smiznuto tijesto, smrznuto beskvasno indijsko tijesto (parata), sladoledi, smrznuti nemliječni deserti, smrznuti voćni deserti, ledeni deserti, kafa, čaj, kakao, šećer, pirinač, tapioka, sago, zamjene za kafu, hleb, pecivo, sirup, so, senf, brašno napravljeno od žitarica, začini., hranljivi napici (na bazi žitarica i bilja), umaci, biljni čaj, med.

(210) Ž-2019-304

(220) 02.08.2019.

(731) THE CAPITAL MAHARAJA ORGANISATION LIMITED, No. 146, Dawson Street, 2, Colombo, LK

(540)  S-Ron
Water for Life

(550) I

(740) Miladin Popović, Đoka Miraševića 21/III , 81000, Podgorica, ME, ME

(511) Klasa 17: Guma, gutaperka, kaučuk, azbest, liskun i proizvodi od ovih materijala koji nijesu obuhvaćeni drugim Klasa ma; poluprerađeni plastični proizvodi koji se koriste u proizvodnji; materijali za nepropusno zatvaranje, zaptivanje i izolovanje; savitljive nemetalne cijevi; savitljive cijevi za šatorska platna; priključci za cijevi za vazduh pod pritiskom, nemetalni; cijevni omotači, nemetalni; spone za cijevi (nemetalne); dihtunzi za cijevi; cijevna izolacija, nemetalna; zaptivači za cijevi; mufovi za cijevi, nemetalni; ojačavajući materijali za cijevi, koji nijesu od metala.

Klasa 19: Građevinski materijali, nemetalni; krute cijevi, nemetalne, za građevinarstvo; asfalt, katran i bitumen (smola); prenosive građevine [konstrukcije], nemetalne; građevinski materijali, nemetalni / konstrukcijski materijali, nemetalni; spomenici, nemetalni; rezervoari za vodu pod pritiskom; cijevi za vodu, nemetalne; ventili za cjevovode, ne od metala ili plastike.

(210) Ž-2019-305

(220) 07.08.2019.

(731) Colgate-Palmolive Company (a Delaware corporation), 300 Park Avenue, 10022, New York, New York, US



(540)

(550) I

(740) Jasna Jusić, Dalmatinska 2, 81000, Podgorica, ME

(511) Klasa 3: nemedicinska pasta za zube i nemedicinska tečnost za ispiranje usta.

(210) Ž-2019-306

(220) 09.08.2019.

(731) Bosnalijek, farmaceutska i hemijska industrija, dionicko drustvo, Jukićeva 53, 71000, Sarajevo, BA

(540) MEMENTO

(550) I

(740) Božidar S. Radulović, Studentska bb, Lamela 3/18, 81000, Podgorica, ME

(511) Klasa 5: farmaceutski proizvodi.

(210) Ž-2019-307

(220) 09.08.2019.

(731) Kite Pharma, Inc. (Delaware corporation), 2400 Broadway, 90404, Santa Monica, California, US



(540)

(550) I

(740) Božidar S. Radulović, Studentska bb, Lamela 3/18, 81000, Podgorica, ME

(511) Klasa 5: Farmaceutski preparati za upotrebu u lečenju kancera; farmaceutski preparati za imunoterapiju, uključujući ćelijsku terapiju i gensku terapiju; biološki preparati za lečenje kancera.

(210) Ž-2019-308

(220) 09.08.2019.

(731) Zdravko Božović, Moskovska 111, Podgorica, ME



(540)

(550) I

(511) Klasa 43: barovi (usluge barova); kafane kafeterije; kafane restorani; restorani.

(210) Ž-2019-309

(220) 12.08.2019.

(731) International Foodstuffs Co LLC, P.O Box No. 4115, Sharjah, AE

(540) MUSA

(550) I

(740) Miladin Popović, Đoka Miraševića 21/III, 81000, Podgorica, ME, ME

(511) Klasa 29: Jestivo ulje.

(210) Ž-2019-310

(220) 12.08.2019.

(731) Lidl Stiftung & Co. KG, Stiftsbergstraße 1, 74172, Neckarsulm, DE

 (540)

(550) I

(740) AOD MSA IP - Milojević Sekulić Advokati, Karađorđeva 65, 11000, Beograd, RS

(511) Klasa 4: Benzin za upaljače.

Klasa 6: Metalni lokoti (katanci) za bicikle; metalni lokoti (katanci) za motocikle; metalni karabinjeri.

Klasa 7: Delovi za podizanje i spuštanje ribarskih mreža, kao delovi mašina.

Klasa 8: Ručni alati i sprave (kojima se ručno upravlja); nožarski proizvodi, a naročito noževi za čišćenje i filetiranje ribe za ribolovce; džepni noževi; harpuni; nožarski proizvodi za kampovanje; koplja za štapove za pecanje.

Klasa 9: Zaštitna odeća za motocikliste; zaštitne kacige za motocikliste; zaštitne rukavice za motocikliste; naočare za sunce; nautički aparati i instrumenti; proizvodi za ronioce, naime ronilačka odela, ronilačke maske, prsluci za spasavanje (na naduvavanje i oni koji se ne mogu naduvati), disaljke za ronjenje, naočare za ronjenje, tegovi, pojasevi sa tegovima za ronjenje, oprema za disanje za plivanje pod vodom, boce sa vazduhom za ronioce, regulatori, dubinomeri (merači dubine mora), manometri, kompasi za određivanje pravca, termometri, čepovi za uši za ronioce, štipaljke za nos, odeća, rukavice za ronioce, obuća i pokrivala za glavu za ronjenje; štitnici za kukove za ribolovce; kamere za podvodno snimanje; aparati i instrumenti fotografski, kinematografski, optički, za vaganje, merenje, signalizaciju, kontrolu (inspekciju), spasavanje i

podučavanje; merači frekvencije; brojači koraka; pametni satovi; uređaji za globalno pozicionirajući sistem (GPS); računar za biciklo; prenosivi računari za upotrebu u sportu; naočare (optika); naočare za sneg; naočare za plivanje; sigurnosne naočare; naočare protiv zaslepljivanja; ramovi za naočare; stakla za naočare; kutije za naočare; kacige za bicikliste; kacige za skijanje i snoubord; tahometri; klizni merači za dubinu; kacige za penjanje; sigurnosni proizvodi, naime, reflektirajuće sigurnosne trake koje se nose na telu; diode koje emituju svetlo.

Klasa 10: Kompresiona odeća; merači pulsa; aparati za masažu.

Klasa 11: Električne lampe; svetla za bicikle; lampe za osvetljenje; dekorativna svetla; aparati za kuvanje, hlađenje, snabdevanje vodom i za sanitarne svrhe; rashladne kutije (električne), roštilji; ventilatori.

Klasa 12: Dodatna oprema i delovi za vozila svih vrsta, a naročito dodatna oprema za motocikle i motocikle sa tri točka, koji su obuhvaćeni ovom klasom; mala električna vozila; oprema za bicikle, a naročito prikolice za bicikle, torbe za bicikle, pumpe za bicikle, montažna postolja dizajnirana za bicikle; oprema i delovi za bicikle u vidu kompleta za popravku; unutrašnje gume za bicikle; čamci i dodatna oprema za čamce; male prikolice za decu; kolica; sprej za popravljavanje guma.

Klasa 14: Hronoskopi.

Klasa 17: Zaptivni materijali.

Klasa 18: Torbe, torbice, a naročito sportske torbe, višenamenske torbe i torbe koje se nose preko ramena; torbe (kovrte-kese) za pakovanje od kože; ruksaci i rančevi; putni rančevi; torbice koje se nose oko vrata; štapovi za hodanje; štapovi za planinarenje; štapovi za pešačenje; sedlarska roba, bičevi, kamdžije; jahački bičevi, uzde za treniranje konja; odeća i garderoba za životinje, prekrivači za konje, štitnici za noge za konje; torbe koje se nose na leđima; torbe za opremu; putne vreće; torbe za sedišta (bisage); kišobrani.

Klasa 19: Paviljoni za dvorište napravljeni od nemetalnih materijala.

Klasa 20: Sedišta i kreveti za upotrebu na otvorenom, a naročito stolice i ležaljke za plažu, stolice i kreveti za kampovanje, poljski kreveti, dušeci za kampovanje, nameštaj za kampovanje, stolovi za kampovanje; dušeci na naduvavanje za kampovanje; jastučići za sedenje na naduvavanje; korpe (za ribolov), korpe u vidu ribolovačkih košara; jastučići za sedenje za ribolovce; futrole i kutije za skladištenje; stolice za ribolov; dušeci na naduvavanje.

Klasa 21: Boce i posude za piće; izotermičke torbe, prenosivi frižideri (neelektrične posude), rashladne patrone za hlađenje jela i pića; lonci, lonci za kampovanje; posude za mešanje mamaca; posude i pribor za ručavanje za kampovanje; posude za piknik; posude za prenošenje i čuvanje tečnosti i namirnica; četke, češljevi i pribor za čišćenje i negu konja.

Klasa 22: Šatori; cirade; mreže; ribarske mreže, mreže za dizanje i spuštanje; nadstrešnice za zaštitu od sunca; šatori za plažu, viseće ležaljke, mreže; vreće; vreće za transport; mreže za hvatanje ribe.

Klasa 24: Tekstil i tekstilni proizvodi koji se koriste za proizvodnju i upotrebu u vidu nadstrešnica i cirada za zaštitu od sunca, tekstil za kupanje; frotirski prekrivači za nameštaj; tekstilni peškiri; vreće za spavanje (koji su obuhvaćeni ovom klasom); vreće za spavanje za kampovanje.

Klasa 25: Odeća, obuća, rukavice [odeća], pokrivala za glavu, pojasevi, sva ispred navedena roba se odnosi isključivo na sportski sektor; motociklističke čizme, kabanice, a naročito odeća otporna na vremenske uslove za motocikliste, odeća za motocikliste; gumene čizme za kišu; odeća, obuća i pokrivala za glavu za ribolov; odeća za plažu; papuče za kupatilo; japanke [obuća]; ulošci za obuću; kramponi za cipele; kamašne, dokolenice i nazuvci; ulošci za obuću sa grejačima.

Klasa 26: Trake za kosu.

Klasa 27: Prostirke, a naročito prostirke za gimnastiku, sport, putovanja, pešačenje i kampovanje.

Klasa 28: Igre; igračke; gimnastički i sportski artikli, koji su obuhvaćeni klasom 28; lopte; reketi za badminton; mreže za badminton; oprema za badminton; reketi za skvoš; oprema za skvoš; reketi za tenis; oprema za tenis; štapovi za golf; loptice za golf; dodatna oprema za golf; reketi za stoni tenis; oprema za

stoni tenis; skije; dodatna oprema za skijanje; krplice za sneg; pojasevi za penjanje; oprema za planinarenje; dodatna oprema za surfovanje; bokserske rukavice; vreće za udaranje; oprema za boks; bejzbol palice; bejzbol rukavice; hokejaški štapovi; oprema za hokej; streličarski pribor (sportski artikli); tetive za lukove; oprema za streličarstvo; oprema za vežbanje i fitnes; tramboline; kanapi za pecanje, pribor za pecanje, štapovi za pecanje i njihovi delovi; ribolovačka oprema, koja nije uključena u druge klase; dodatna oprema za ribolov, kalemovi za pecanje, najlon za pecanje, udice, olovo za ribolov, plovci za ribolov; mamci za pecanje (osim živih mamaca); veštačke muve za ribolov; mamac [veštački]; posude za mamce; držaci za pecaljke; mreže sa drškom za ribolov; varalice za ribolov; veštačke varalice za ribolov, vrše [ribolovačke zamke], rukavice za ribolov, puške (harpuni -) [sportska oprema]; štapovi, a naročito štapovi za ribolov; odela za plivanje; posude i torbe za ribolov i dodatna oprema za ribolov; peraja za plivanje; torbe prilagođene za nošenje sportske opreme; setovi za boćanje; mete i strelice za pikado; sportski rekviziti za plažu; akrobatski zmajevi; plutajuća oprema za plivanje na naduvavanje; šlaufi u obliku prstena za plivanje; bazeni za plivanje (za igranje); bazeni; daske za plivanje; daske za potrbušno plivanje; sanke za sneg; skejtbord; roleri; klizaljke; štitnici, a naročito štitnici za leđa, ramena, laktove, kolena i zglobove (sportski artikli); oprema za golf, naime, golf kolica; oprema za tenis, naime, torbe za tenis; oprema za badminton, naime, torbe za badminton; oprema za skvoš, naime, torbe za skvoš.

Klasa 34: Upaljači; kremen za upaljače.

(210) Ž-2019-311

(220) 15.08.2019.

(731) Nobel Quest International Limited, P.O.BOX 3152, Road Town, Tortola, VG

(540) HUNN

(550) I

(740) Dejan Raičević, Vojvode Boža br.1, 81250, Cetinje

(511) Klasa 9: Baterije za elektronske cigarete; baterije za elektronske uređaje koji se koriste za zagrevanje i paljenje duvana; punjači za elektronske uređaje koji se koriste za zagrevanje i paljenje duvana; USB punjači za elektronske uređaje koji se koriste za zagrevanje i paljenje duvana; auto punjači za elektronske cigarete; auto punjači za uređaje koji se koriste za zagrevanje i paljenje duvana; punjači za baterije za elektronske cigarete.

Klasa 34: Duvan; artikli za pušače; šibice; cigarete; kutije za cigarete; filteri za cigarete; muštikle; papir za cigarete; usnici za cigarete; usnici za muštikle; lule; cigarilos; cigare; pepeljare za pušače; upaljači za pušače.

(210) Ž-2019-312

(220) 19.08.2019.

(731) Arexons S.p.A, Via Antica di Cassano, 23, 20063, Cernusco sul Naviglio MI, IT



(540)

(550) I

(740) Miladin Popović, Đoka Miraševića 21/III, 81000, Podgorica, ME

(511) Klasa 21: Krpe za čišćenje.

(210) Ž-2019-315

(220) 22.08.2019.

(731) Publicis Groupe SA, 133 avenue des Champs-Élysées, 75008, Paris, FR

(540) SAATCHI & SAATCHI

(550) I

(740) Jasna Jusić, Dalmatinska 2, 81000, Podgorica, ME

(511) Klasa 35: Savjetovanje u vezi s poslovanjem i organizacijom; poslovna

administracija; savjetovanje, razvoj i primjena komercijalnih, reklamnih, komunikacionih i marketinških strategija; ekonomske prognoze; istraživanja za poslove; tržišne studije; istraživanje, sastavljanje, obrada i analiza poslovnih podataka; ažuriranje i održavanje podataka u računarskim bazama podataka; usluge oglašavanja i marketinga; promotivne usluge; marketing, oglašavanje, razvoj sadržaja i konsultacije u vezi sa brendovima u oblasti usluga komunikacionih strategija koje se odnose na brendove; usluge brendiranja, naime, analiza i savjetovanje o brendovima za preduzeća; savjetodavne usluge u vezi sa podsticanjem prodaje; analiza poslovnih podataka u oblasti naučnih podataka i konsultantske usluge za njih; marketinška analiza u vidu usluga mjerenja i optimizacije atribucije (ovlašćenja) digitalnih medija; usluge segmentacije potrošača, naime marketinške usluge u obliku sprovođenja praćenja ponašanja potrošača i analize trendova potrošača; poslovno savjetovanje i savjetodavne usluge koje

se odnose na analizu interesa potrošača i navika kupovine; usluge upravljanja reklamama, naime upravljanje komercijalnim i reklamnim materijalima i medijima; usluge kupovine i planiranja medija; iznajmljivanje i kupovina vremena i reklamnog prostora na svim sredstvima komunikacije i medijima; kreiranje, pisanje, uređivanje, objavljivanje i distribucija tekstova, vizuala, sadržaja i reklamnog materijala (brošure, prospekti, štampani materijal, oglašavanje putem pošte, medijski setovi, uzorci); promocija proizvoda i usluga drugih; produkcija, postprodukcija, montaža, objavljivanje, distribucija, iznajmljivanje i projekcija zvučnih, video i kinematografskih djela u reklamne svrhe; pisanje scenarija u reklamne svrhe; usluge modeliranja u reklamne svrhe; konsultantske usluge u vezi sa optimizacijom prometa veb stranica; pružanje, sastavljanje i analiza poslovnih informacija, poslovne statistike i komercijalnih informacija; organizovanje, razvoj i upravljanje događajima u komercijalne ili reklamne svrhe; organizaciono savjetovanje, razvoj i provođenje događaja u komercijalne ili reklamne svrhe; odnosi sa javnošću; usluge komercijalnog lobiranja; usluge poslovnog posrednika koje se odnose na usklađivanje potencijalnih privatnih investitora sa preduzetnicima kojima je potrebno finansiranje; savjetodavne usluge u vezi s oglašavanjem traženja sponzorstva; savjetovanje o strategijama društvenih medija; upravljanje zajednicama društvenih medija; onlajn oglašavanje na računarskoj mreži; poslovne procjene; evaluacije u vezi sa komercijalnim pitanjima; usluge procjene brenda; usluge poslovne strategije; usluge strategije brenda; informativne, savjetodavne i konsultantske usluge u vezi sa gore navedenim uslugama; uključujući sve gore navedene usluge koje se pružaju elektronskim putem ili putem interneta iz računarske baze podataka ili interneta

Klasa 41: Obrazovanje; obezbjeđivanje obuke; zabava; sportske i kulturne aktivnosti; izdavačke usluge; usluge objavljivanja; usluge obuke i podučavanja; stvaranje, pisanje, uređivanje, objavljivanje i distribucija tekstova, vizuala, sadržaja i materijala; objavljivanje uredničkog sadržaja veb-sajtova dostupnih putem globalne računarske mreže; usluge onlajn digitalnog izdavanja; onlajn objavljivanje knjiga i periodičnih publikacija; mikroizdavaštvo; pružanje onlajn elektronskih publikacija, digitalne muzike i digitalne zabave (koja se ne može preuzimati); produkcija, postprodukcija, uređivanje, distribucija, iznajmljivanje i projekcija zvučnih, video i kinematografskih radova, ne samo u reklamne svrhe; organizovanje kulturnih ili sportskih

događaja; organizovanje akademskih skupova, konferencija i kongresa; organizacija radionica za obuku; vođenje kurseva, seminara i radionica koji se odnose na poslovanje, poslovno upravljanje, reklamiranje, marketing i promociju; usluge obrazovanja, davanja instrukcija i podučavanja u vezi sa poslovanjem, poslovnim upravljanjem, reklamiranjem, marketingom i promocijom; usluge obrazovanja, obučavanja i podučavanja koje se odnose na poslovanje, poslovno upravljanje, oglašavanje, marketing i promociju; organizovanje i sprovođenje takmičenja (obrazovanje ili zabava); usluge korporativnog ugostiteljstva; pružanje onlajn tekstova, vizuala i elektronskog sadržaja koji se ne može preuzeti; prevodilačke usluge; planiranje posebnih događaja; pružanje informacija u vezi sa sportom i sportskim događajima; pružanje informacija u vezi sa organizovanjem obrazovnih, kulturnih, sportskih ili zabavnih manifestacija; usluge zabave i produkcije događaja, naime, organizovanje, koordinacija i sprovođenje sportskih događaja u vidu takmičenja u atletskim disciplinama, niza sportskih manifestacija, sportskih i atletskih takmičenja i sportskih događaja u zajednici; izložbene usluge; kulturne izložbe; zabavni nastupi u vidu uživo ili unaprijed snimljenog plesa, muzike, pozorišta, komedije, muzičkog benda i nastupa rok grupa, prikazivanje filmova, emisija, predstava ili muzičkih nastupa; produkcija televizijskih programa; produkcija i udruživanje radio i televizijskih programa i reklama; zvučna, video i pomoćna produkcija i usluge postprodukcije; snimanje muzike; uređivanje i unapređivanje zvuka; miješanje dijaloga, muzike, zvučnih efekata, dijaloga i naracije; automatizovana zamjena

dijaloga; snimanje zvučnih efekata uživo; audio postprodukcija, reprodukcija i poboljšanje kvaliteta audio zapisa; sinhronizacija na stranom jeziku i snimanje; video postprodukcija, audio postprodukcija; dodavanje vizuelnih efekata i grafika video kaseti, audio kaseti, digitalnim medijima i filmu; mastering, uređivanje, poboljšavanje kvaliteta, obnavljanje, pretvaranje i reformatiranje filma, digitalnih medija i video kasete; uređivanje filma, digitalnih medija i video kasete; CD, DVD i mastering elektronskih medija; produkcija i specijalni efekti za reklame, filmove i televiziju; usluge eksploatacije filmova i animacija; iznajmljivanje opreme koja se koristi prilikom stvaranja filma, digitalnih medija i video kasete, kao i za upotrebu u postproduksijskom radu; produkcija, prezentacija, distribucija, udruživanje, umrežavanje i iznajmljivanje televizijskih i radijskih programa koji uključuju reklame, interaktivnu zabavu, filmove, zvučne i video zapise, interaktivne kompakt diskove i CD-ROM-ove; proizvodnja i iznajmljivanje edukativnog i materijala za obuku; iznajmljivanje radio i televizijskih emitterskih instalacija; pisanje scenarija, ne samo u reklamne svrhe; pisanje pjesama; usluge komponovanja muzike; iznajmljivanje audio i video opreme; iznajmljivanje kinematografske opreme; usluge agencija za izdavanje karata [zabava]; usluge snimanja u studiju; mikrofilmovi; titlovanje; fotografske usluge; uključujući sve gore pomenute usluge koje se pružaju onlajn preko

računarske mreže ili putem interneta ili ekstraneta; informativne, savjetodavne i konsultantske usluge u vezi s prethodno navedenim uslugama; uključujući sve gore pomenute usluge koje se pružaju elektronskim putem ili onlajn iz računarske baze podataka ili interneta.

Klasa 42: Savjetovanje u vezi s informacionom tehnologijom; dizajn, razvoj, održavanje, hosting i implementacija veb sajtova, računarskog softvera, računarskih softverskih aplikacija, računarskih platformi i računarskih programa; inženjering u oblasti komunikacije i marketinga, naime tehnička analiza i tehnička obrada podataka; elektronsko čuvanje podataka; stvaranje tekstova, zvukova, muzike i video zapisa za veb stranice i veb sajtove; istraživanje i razvoj novih proizvoda za druge; dizajn, savjetovanje i razvoj aplikacija, softvera i veb sajtova; studije tehničkih projekata; grafički dizajn; programiranje softvera za internet forume; kreiranje programa za obradu podataka; softver kao usluga (SaaS); softver kao usluga (SAAS), naime softver u oblasti oglašavanja i marketinga; softver kao usluga (SAAS), naime, softver za praćenje, monitoring i izvještavanje putem medija, štampe, društvenih medija, trendova; softver kao usluga (SAAS), naime softver za razvoj tehnologije, podataka i analitičkih alata usmjerenih na reklamiranje; alati softverske tehnologije u obliku pretraživača i digitalnog kodiranja; softverske usluge, naime, pružanje onlajn platformi

za praćenje, monitoring i izvještavanje putem medija, štampe, društvenih mreža, trendova; softverske usluge, naime, pružanje onlajn platformi za reklamiranje, marketing, promotivne i svrhe odnosa sa javnošću; softver kao usluga, naime, softver za procjenu ponašanja kupaca i analizu ponašanja na društvenim medijima i društvenim mrežama; softverske usluge, naime, pružanje onlajn platformi za razvoj tehnologije, podataka i analitičkih alata usmjerenih na reklamiranje; pružanje softvera i platformi za kupovinu putem medija; alati (softverske aplikacije) za analizu brenda i društvenih medija; dizajnerska istraživanja; usluge ilustrovanja (dizajn); usluge industrijskog i komercijalnog dizajna; dizajn, kreiranje, istraživanje i razvoj ambalaže; istraživanje i dizajn novih proizvoda; razvoj novih proizvoda; dizajn, crtanje i pisanje po narudžbi, a sve

za sastavljanje veb stranica na internetu; kreiranje veb sadržaja i veb stranica;

računarsko programiranje; računarske usluge, naime, dizajniranje i primjena mrežnih veb sajtova, softverskih aplikacija i računarskih mrežnih sistema informacione tehnologije za druge; usluge dizajniranja Veb sajtova; kompjutersko oblikovanje video grafike; kreiranje, uređivanje i ažuriranje sadržaja veb sajtova; računarske usluge, naime, dizajniranje i primjena reklama na banerima; usluge grafičkog dizajna; iznajmljivanje računarskih instalacija; usluge iznajmljivanja računara; iznajmljivanje računarskog softvera, računarskih platformi i računarskih aparata; informativne, savjetodavne i konsultantske usluge u vezi sa gore navedenim uslugama; uključujući sve gore navedene usluge koje se pružaju elektronskim putem ili putem interneta iz računarske baze podataka ili interneta.

(210) Ž-2019-316

(220) 26.08.2019.

(731) Colgate-Palmolive Company (a Delaware Corporation), 300 Park Avenue, 10022, New York, New York, US

(540) FLOWER LOVE

(550) I

(740) Jasna Jusić, Dalmatinska 2, 81000, Podgorica, ME

(511) Klasa 3: Proizvodi za ličnu higijenu, odnosno, preparati za čišćenje kože i tijela; sapun; tečni sapun za ruke; gelovi i kreme za tuširanje; kupke; preparati za njegu kose; dezodoransi, preparati protiv znojenja i sprejevi za ispod pazuha za ličnu upotrebu; preparati za hidrataciju tijela i kože, losioni i kreme; puder u prahu; preparati za brijanje; preparati za kozmetičko potamnjenje i preparati za zaštitu kože od uticaja sunca; maramice natopljene rastvorom za čišćenje.

(210) Ž-2019-319

(220) 27.08.2019.

(731) BELUPO lijekovi i kozmetika, d.d., Danica 5, 48000, Koprivnica, HR

(540) SILAPEN

(550) I

(740) Miladin Popović, Đoka Miraševića 21/III, 81000, Podgorica, ME, ME

(511) Klasa 5: Farmaceutski proizvodi.

(210) Ž-2019-320

(220) 27.08.2019.

(731) BELUPO lijekovi i kozmetika, d.d., Danica 5, 48000, Koprivnica, HR

(540) AMORA

(550) I

(740) Miladin Popović, Đoka Miraševića 21/III, 81000, Podgorica, ME, ME

(511) Klasa 5: Farmaceutski proizvodi.

(210) Ž-2019-321

(220) 28.08.2019.

(731) Reckitt Benckiser LLC, 399 Interpace Parkway, 07054, Parsippany, New Jersey, US

(540) LYSOL

(550) I

(740) Miladin Popović, Đoka Miraševića 21/III, 81000, Podgorica, ME

(511) Klasa 3: Višenamjenski preparati za čišćenje; preparati za čišćenje, poliranje, ribanje i abrazivni preparati; preparati za čišćenje koji spriječavaju nagomilavanje fleka i kamenca; preparati za dekalifikaciju i uklanjanje kamenca za upotrebu u domaćinstvu; preparati za čišćenje odvoda i sudopere; sredstva za čišćenje toaleta; preparati za čišćenje prozora; preparati za bijeljenje; krpe, vlažne maramice, maramice i sunđer natopljeni preparatima za čišćenje; deterdženti; deterdženti za pranje veša; preparati za pranje sudova; sredstvo za čišćenje, osvežavanje i dezodorisanje mašina za sudove; sredstva za ispiranje za mašine za sudove; preparati za upotrebu u perionicama; sredstva za čišćenje veš mašina; sapuni; antibakterijski sapuni; sapuni za ličnu upotrebu; preparati za čišćenje ruku; sredstva za tuširanje; preparati za njegu kože; parfimisani preparati za atmosferu; parfimisani sprejevi za prostorije; esencijalna ulja; mirisni difuzori; potpuri; tamjan.

Klasa 5: Dezinfekcioni, antibakterijski preparati i preparati za dezodorisanje; dezinfekciona sredstva za kuhinje, toalete i kupatila; sanitarni preparati za upotrebu u domaćinstvu, komercijalnu, industrijsku i institucionalnu upotrebu; sredstva za dezinfekciju veša; preparati za dezinfekciju tvrdih površina za upotrebu u domaćinstvu; dezodoransi za upotrebu u domaćinstvu; krpe, vlažne maramice, maramice i sunđer natopljeni dezinfekcionim sredstvima; krpe, vlažne maramice, maramice i sunđer natopljeni antiseptičkim preparatima; krpe, vlažne maramice, maramice i sunđer natopljeni antibakterijskim preparatima; insekticidi; miticidi; sredstva za zaštitu od insekata; fungicidi; germicidi; preparati za uništavanje i odbijanje štetočina; preparati za osvježavanje vazduha; preparati za neutralisanje mirisa za upotrebu na tekstilu, tepisima i u vazduhu; preparati za neutralisanje mirisa; preparati za prečišćavanje vazduha.

Klasa 21: Krpe i vlažne maramice za čišćenje ili upotrebu u domaćinstvu, naime, krpe i vlažne maramice za čišćenje; krpe za poliranje; krpe za čišćenje; pjalice i krpe za prašinu; sunđer za pranje; držači za krpe, vlažne maramice, maramice i sunđere za čišćenje kuće; dozatori za sredstva za čišćenje domaćinstva; kućne ili kuhinjske sprave i posude; češljevi i sunđer; četke (izuzev kičica); materijali za pravljenje četki; pribor za čišćenje; čelična vuna; staklo, neobrađeno ili poluobrađeno [osim stakla koje se koristi u građevini]; staklarija, porcelan i grnčarija koja nije obuhvaćena drugim Klasama.

(210) Ž-2019-322

(220) 28.08.2019.

(731) Reckitt Benckiser LLC, 399 Interpace Parkway, 07054, Parsippany, New Jersey, US



(540)

(550) I

(740) Miladin Popović, Đoka Miraševića 21/III, 81000, Podgorica, ME

(511) Klasa 3: Višenamjenski preparati za čišćenje; preparati za čišćenje, poliranje, ribanje i abrazivni preparati; preparati za čišćenje koji spriječavaju nagomilavanje fleka i kamenca; preparati za dekalifikaciju i uklanjanje kamenca za upotrebu u domaćinstvu; preparati za čišćenje odvoda i sudopere; sredstva za čišćenje toaleta; preparati za čišćenje prozora; preparati za bijeljenje; krpe, vlažne maramice, maramice i sunđeri natopljeni preparatima za čišćenje; deterdženti; deterdženti za pranje veša; preparati za pranje sudova; sredstvo za čišćenje, osvežavanje i dezodorisanje mašina za sudove; sredstva za ispiranje za mašine za sudove; preparati za upotrebu u perionicama; sredstva za čišćenje veš mašina; sapuni; antibakterijski sapuni; sapuni za ličnu upotrebu; preparati za čišćenje ruku; sredstva za tuširanje; preparati za njegu kože; parfimisani preparati za atmosferu; parfimisani sprejevi za prostorije; esencijalna ulja; mirisni difuzori; potpuri; tamjan.

Klasa 5: Dezinfekcioni, antibakterijski preparati i preparati za dezodorisanje; dezinfekciona sredstva za kuhinje, toalete i kupatila; sanitarni preparati za upotrebu u domaćinstvu, komercijalnu, industrijsku i institucionalnu upotrebu; sredstva za dezinfekciju veša; preparati za dezinfekciju tvrdih površina za upotrebu u domaćinstvu; dezodoransi za upotrebu u domaćinstvu; krpe, vlažne maramice, maramice i sunđeri natopljeni dezinfekcionim sredstvima; krpe, vlažne maramice, maramice i sunđeri natopljeni antiseptičkim preparatima; krpe, vlažne maramice, maramice i sunđeri natopljeni antibakterijskim preparatima; insekticidi; miticidi; sredstva za zaštitu od insekata; fungicidi; germicidi; preparati za uništavanje i odbijanje štetočina; preparati za osvježavanje vazduha; preparati za neutralisanje mirisa za upotrebu na tekstu, tepisima i u vazduhu; preparati za neutralisanje mirisa; preparati za prečišćavanje vazduha.

Klasa 21: Krpe i vlažne maramice za čišćenje ili upotrebu u domaćinstvu, naime, krpe i vlažne maramice za čišćenje; krpe za poliranje; krpe za čišćenje; pjalice i krpe za prašinu; sunđeri za pranje; držači za krpe, vlažne maramice, maramice i sunđere za čišćenje kuće; dozatori za sredstva za čišćenje domaćinstva; kućne ili kuhinjske sprave i posude; češljevi i sunđeri; četke (izuzev kičica); materijali za pravljenje četki; pribor za čišćenje; čelična vuna; staklo, neobrađeno ili poluobrađeno [osim stakla koje se koristi u građevini]; staklarija, porcelan i grnčarija koja nije obuhvaćena drugim Klasama.

(210) Ž-2019-324

(220) 29.08.2019.

(731) Altunis-Trading, Gestão e Serviços, Sociedade Unipessoal, LDA., Avenida Arriaga n° 73, 1° andar, sala 113, 9000-060, Funchal, Madeira, PT

(540) CIPRIANI

(550) I

(740) Jasna Jusić, Dalmatinska 2, 81000, Podgorica, ME

(511) Klasa 43: Usluge obezbjeđivanja hrane i pica; privremeni smještaj.

(210) Ž-2019-326

(220) 03.09.2019.

(731) D.O.O BUIL'D, Bečići bb, PF 70, ME

(540) ANATOLIA

(550) I

(511) Klasa 36: Usluge upravljanja nepokretnostima (administriranje zgradama), tj.usluge izdavanja ili procjene ili finansiranja.

Klasa 43: Usluge obezbjeđivanja hrane i pica; privremeni smještaj; usluge koje pružaju lica ili ustanove čija je namjena pripremanje hrane i pica za potrošnju i usluge obezbjeđivanja ishrane i smještaja u hotelima, pansionima ili drugim ustanovama koje obezbjeđuju privremeni smještaj.

(210) Ž-2019-327

(220) 04.09.2019.

(731) Merck Sharp & Dohme Corp., One Merck Drive, 08889, Whitehouse Station, New Jersey, US

(540) RECARBRIO

(550) I

(740) Jasna Jusić, Dalmatinska 2, 81000, Podgorica, ME

(511) Klasa 5: Farmaceutski preparati.

(210) Ž-2019-329

(220) 04.09.2019.

(731) Merck Sharp & Dohme Corp., One Merck Drive, 08889, Whitehouse Station, New Jersey, US

(540) PREVYMIS

(550) I

(740) Jasna Jusić, Dalmatinska 2, 81000, Podgorica, ME

(511) Klasa 5 Farmaceutski preparati.

(210) Ž-2019-330

(220) 04.09.2019.

(731) Merck Sharp & Dohme Corp., One Merck Drive, 08889, Whitehouse Station, New Jersey, US

(540) PEXETINEM

(550) I

(740) Jasna Jusić, Dalmatinska 2, 81000, Podgorica, ME

(511) Klasa 5 Farmaceutski preparati.

(210) Ž-2019-331

(220) 04.09.2019.

(731) Merck Sharp & Dohme Corp., One Merck Drive, 08889, Whitehouse Station, New Jersey, US

(540) ZEMVETIS

(550) I

(740) Jasna Jusić, Dalmatinska 2, 81000, Podgorica, ME

(511) Klasa 5: Farmaceutski preparati.

(210) Ž-2019-332

(220) 04.09.2019.

(731) United Castle International Company Limited, Room 3101, 31/F, Office Tower, Convention Plaza, 1Harbour Road , HK

(540) 

(550) I

(740) Jasna Jusić, Dalmatinska 2, 81000, Podgorica, ME

(511) Klasa 9: Računarski softver; Baterije za elektronske cigarete; baterije za elektronske uređaje koji se koriste za zagrijavanje duvana, punjači za baterije za elektronske uređaje koji se koriste za zagrijavanje duvana; USB punjači za elektronske uređaje koji se koriste za zagrijavanje duvana; auto punjači za elektronske cigarete; auto punjači za uređaje koji se koriste za zagrijavanje duvana; djelovi i oprema za gore pomenuto.

Klasa 11: Elektronski isparivači; aparati za zagrijavanje tečnosti; aparati za stvaranje isparenja, žičani isparivač; djelovi i oprema za gore pomenuto.

Klasa 34: Duvan; Duvan, sirov ili prerađen, uključujući cigare, cigarete, cigarilose, duvan za savijanje sopstvenih cigareta, duvan za lule, duvan za žvakanje, burmut, duvanske zamjene (nije za medicinske svrhe); artikli za pušače, uključujući papir i fišeke za cigarete, filtere za cigarete, limenke za duvan, kutije za cigarete i pepeljare, a ne od plemenitih metala, njihovih legura ili presvučenih njima; lule, džepni aparat za savijanje cigareta; upaljači; šibice; elektronske cigarete; isparivači za pušenje; djelovi i oprema za gore pomenuto.

Klasa 35: Maloprodajne usluge u vezi sa računarskim softverom, baterije za elektronske cigarete, baterije za elektronske uređaje koji se koriste za zagrijavanje duvana, punjači za baterije za elektronske uređaje koji se koriste za zagrijavanje duvana, USB punjači za elektronske uređaje koji se koriste za zagrijavanje duvana, auto punjači za elektronske cigarete, auto punjači za uređaje koji se koriste za zagrijavanje duvana; Maloprodajne usluge u vezi s elektronskim isparivačima, uređajima za zagrijavanje tečnosti, aparatima za stvaranje isparenja, žičanim isparivačem; Maloprodajne usluge u vezi sa duvanom (sirov), duvanom (prerađeni), cigarima, cigaretama, cigarilosima, duvanom za savijanje sopstvenih cigareta, duvanom za lule, duvanom za žvakanje, burmutom; Maloprodajne usluge u vezi sa zamjenama duvana (ne u medicinske svrhe), artiklima za pušače, papir i fišeci za cigarete, filteri za cigarete, limenke za duvan, kutije za cigarete i pepeljare, lule; Maloprodajne usluge u vezi sa džepnim aparatima za savijanje cigareta, upaljačima, šibicama, elektronskim cigaretama; Maloprodaja elektronskih cigareta; Spajanje, u korist drugih, različitih proizvoda, naime duvana, zamjena za duvan, elektronskih isparivača, baterija i punjača za elektronske cigarete, omogućavajući potrošačima da tu robu lako upoređuju i kupuju; oglašavanje; poslovni menadžment; marketing i promotivne usluge; informativne i savjetodavne usluge u vezi sa prethodno navedenim.

(210) Ž-2019-333

(220) 04.09.2019.

(731) United Castle International Company Limited, Room 3101, 31/F, Office Tower, Convention Plaza, 1 Harbour Road, HK

MOK

(540)

(550) I

(740) Jasna Jusić, Dalmatinska 2, 81000, Podgorica, ME

(511) Klasa 9: Računarski softver; Baterije za elektronske cigarete; baterije za elektronske uređaje koji se koriste za zagrijavanje duvana, punjači za baterije za elektronske uređaje koji se koriste za zagrijavanje duvana; USB punjači za elektronske uređaje koji se koriste za zagrijavanje duvana; auto punjači za elektronske cigarete; auto punjači za uređaje koji se koriste za zagrijavanje duvana; djelovi i oprema za gore pomenuto.

Klasa 11: Elektronski isparivači; aparati za zagrijavanje tečnosti; aparati za stvaranje isparenja, žičani isparivač; djelovi i oprema za gore pomenuto.

Klasa 34: Duvan; Duvan, sirov ili prerađen, uključujući cigare, cigarete, cigarilose, duvan za savijanje sopstvenih cigareta, duvan za lule, duvan za žvakanje, burmut, duvanske zamjene (nije za medicinske svrhe); artikli za pušače, uključujući papir i fišeke za cigarete, filtere za cigarete, limenke za duvan, kutije za cigarete i pepeljare, a ne od plemenitih metala, njihovih legura ili presvučenih njima; lule, džepni aparat za savijanje cigareta; upaljači; šibice; elektronske cigarete; isparivači za pušenje; djelovi i oprema za gore pomenuto.

Klasa 35: Maloprodajne usluge u vezi sa računarskim softverom, baterije za elektronske cigarete, baterije za elektronske uređaje koji se koriste za zagrijavanje duvana, punjači za baterije za elektronske uređaje koji se koriste za zagrijavanje duvana, USB punjači za elektronske uređaje koji se koriste za zagrijavanje duvana, auto punjači za elektronske cigarete, auto punjači za uređaje koji se koriste za zagrijavanje duvana; Maloprodajne usluge u vezi s elektronskim isparivačima, uređajima za zagrijavanje tečnosti, aparatima za stvaranje isparenja, žičanim isparivačem; Maloprodajne usluge u vezi sa duvanom (sirov), duvanom (prerađeni), cigarima, cigaretama, cigarilosima, duvanom za savijanje sopstvenih cigareta, duvanom za lule, duvanom za žvakanje, burmutom; Maloprodajne usluge u vezi sa zamjenama duvana (ne u medicinske svrhe), artiklima za pušače, papir i fišeci za cigarete, filteri za cigarete, limenke za duvan, kutije za cigarete i pepeljare, lule; Maloprodajne usluge u vezi sa džepnim aparatima za savijanje cigareta, upaljačima, šibicama, elektronskim cigaretama; Maloprodaja elektronskih cigareta; Spajanje, u korist drugih, različitih proizvoda, naime duvana, zamjena za duvan, elektronskih isparivača, baterija i punjača za elektronske cigarete, omogućavajući potrošačima da tu robu lako upoređuju i kupuju; oglašavanje; poslovni menadžment; marketing i promotivne usluge; informativne i savjetodavne usluge u vezi sa prethodno navedenim.

(210) Ž-2019-334

(220) 04.09.2019.

(731) United Castle International Company Limited, Room 3101, 31/F, Office Tower, Convention Plaza, 1 Harbour Road, HK



(540)

(550) I

(740) Jasna Jusić, Dalmatinska 2, 81000, Podgorica, ME

(511) Klasa 9: Računarski softver; Baterije za elektronske cigarete; baterije za elektronske uređaje koji se koriste za zagrijavanje duvana, punjači za baterije za elektronske uređaje koji se koriste za zagrijavanje duvana; USB punjači za elektronske uređaje koji se koriste za zagrijavanje duvana; auto punjači za elektronske cigarete; auto punjači za uređaje koji se koriste za zagrijavanje duvana; djelovi i oprema za gore pomenuto.

Klasa 11: Elektronski isparivači; aparati za zagrijavanje tečnosti; aparati za stvaranje isparenja, žičani isparivač; djelovi i oprema za gore pomenuto.

Klasa 34: Duvan; Duvan, sirov ili prerađen, uključujući cigare, cigarete, cigarilose, duvan za savijanje sopstvenih cigareta, duvan za lule, duvan za žvakanje, burmut, duvanske zamjene (nije za medicinske svrhe); artikli za pušače, uključujući papir i fiške za cigarete, filtere za cigarete, limenke za duvan, kutije za cigarete i pepeljare, a ne od plemenitih metala, njihovih legura ili presvučenih njima; lule, džepni aparat za savijanje cigareta; upaljači; šibice; elektronske cigarete; isparivači za pušenje; djelovi i oprema za gore pomenuto.

Klasa 35: Maloprodajne usluge u vezi sa računarskim softverom, baterije za elektronske cigarete, baterije za elektronske uređaje koji se koriste za zagrijavanje duvana, punjači za baterije za elektronske uređaje koji se koriste za zagrijavanje duvana, USB punjači za elektronske uređaje koji se koriste za zagrijavanje duvana, auto punjači za elektronske cigarete, auto punjači za uređaje koji se koriste za zagrijavanje duvana; Maloprodajne usluge u vezi s elektronskim isparivačima, uređajima za zagrijavanje tečnosti, aparatima za stvaranje isparenja, žičanim isparivačem; Maloprodajne usluge u vezi sa duvanom (sirov), duvanom (prerađeni), cigarima, cigaretama, cigarilosima, duvanom za savijanje sopstvenih cigareta, duvanom za lule, duvanom za žvakanje, burmutom; Maloprodajne usluge u vezi sa zamjenama duvana (ne u medicinske svrhe), artiklima za pušače, papir i fišeci za cigarete, filteri za cigarete, limenke za duvan, kutije za cigarete i pepeljare, lule; Maloprodajne usluge u vezi sa džepnim aparatima za savijanje cigareta, upaljačima, šibicama, elektronskim cigaretama; Maloprodaja elektronskih cigareta; Spajanje, u korist drugih, različitih proizvoda, naime duvana, zamjena za duvan, elektronskih isparivača, baterija i punjača za elektronske cigarete, omogućavajući potrošačima da tu robu lako upoređuju i kupuju; oglašavanje; poslovni menadžment; marketing i promotivne usluge; informativne i savjetodavne usluge u vezi sa prethodno navedenim.

(210) Ž-2019-335

(220) 04.09.2019.

(731) United Castle International Company Limited, Room 3101, 31/F, Office Tower, Convention Plaza, 1 Harbour Road, HK



(540)

(550) I

(740) Jasna Jusić, Dalmatinska 2, 81000, Podgorica, ME

(511) Klasa 9: Računarski softver; Baterije za elektronske cigarete; baterije za elektronske uređaje koji se koriste za zagrijavanje duvana, punjači za baterije za elektronske uređaje koji se koriste za zagrijavanje duvana; USB punjači za elektronske uređaje koji se koriste za zagrijavanje duvana; auto punjači za elektronske cigarete; auto punjači za uređaje koji se koriste za zagrijavanje duvana; djelovi i oprema za gore pomenuto.

Klasa 11: Elektronski isparivači; aparati za zagrijavanje tečnosti; aparati za stvaranje isparenja, žičani isparivač; djelovi i oprema za gore pomenuto.

Klasa 34: Duvan; Duvan, sirov ili prerađen, uključujući cigare, cigarete, cigarilose, duvan za savijanje sopstvenih cigareta, duvan za lule, duvan za žvakanje, burmut, duvanske zamjene (nije za medicinske svrhe); artikli za pušače, uključujući papir i fišeke za cigarete, filtere za cigarete, limenke za duvan, kutije za cigarete i pepeljare, a ne od plemenitih metala, njihovih legura ili presvučenih njima; lule, džepni aparat za savijanje cigareta; upaljači; šibice; elektronske cigarete; isparivači za pušenje; djelovi i oprema za gore pomenuto.

Klasa 35: Maloprodajne usluge u vezi sa računarskim softverom, baterije za elektronske cigarete, baterije za elektronske uređaje koji se koriste za zagrijavanje duvana, punjači za baterije za elektronske uređaje koji se koriste za zagrijavanje duvana, USB punjači za elektronske uređaje koji se koriste za zagrijavanje duvana, auto punjači za elektronske cigarete, auto punjači za uređaje koji se koriste za zagrijavanje duvana; Maloprodajne usluge u vezi s elektronskim isparivačima, uređajima za zagrijavanje tečnosti, aparatima za stvaranje isparenja, žičanim isparivačem; Maloprodajne usluge u vezi sa duvanom (sirov), duvanom (prerađeni), cigarima, cigaretama, cigarilosima, duvanom za savijanje sopstvenih cigareta, duvanom za lule, duvanom za žvakanje, burmutom; Maloprodajne usluge u vezi sa zamjenama duvana (ne u medicinske svrhe), artiklima za pušače, papir i fišeci za cigarete, filteri za cigarete, limenke za duvan, kutije za cigarete i pepeljare, lule; Maloprodajne usluge u vezi sa džepnim aparatima za savijanje cigareta, upaljačima, šibicama, elektronskim cigaretama; Maloprodaja elektronskih cigareta; Spajanje, u korist drugih, različitih proizvoda, naime duvana, zamjena za duvan, elektronskih isparivača, baterija i punjača za elektronske cigarete, omogućavajući potrošačima da tu robu lako upoređuju i kupuju; oglašavanje; poslovni menadžment; marketing i promotivne usluge; informativne i savjetodavne usluge u vezi sa prethodno navedenim.

(210) Ž-2019-338

(220) 05.09.2019.

(731) Kent Gıda Maddeleri Sanayii ve Ticaret Anonim Sirketi, Cumhuriyet Mahallesi 2253, Sokak. No.11, 41400, Gebze/Kocaeli, TR

(540) OLIPS

(550) I

(740) Miladin Popović, Đoka Miraševića 21/III, 81000, Podgorica, ME, ME

(511) Klasa 30: Konditorski proizvodi bez medikamenata; čokolada; konditorski proizvodi od čokolade; konditorski proizvodi od šećera, uključujući slatki korijen, karamelu, žele; smrznuti konditorski proizvodi; rashlađeni konditorski proizvodi; sladoled; led; deserti; kolači, biskviti i vafli; žvakaće gume i žvake.

(210) Ž-2019-339

(220) 06.09.2019.

(731) DRUŠTVO SA OGRANIČENOM ODGOVORNOŠĆU "SAVA CAR" PODGORICA, Ul. Vukašina Markovića br.184, 81000, Podgorica, ME, ME

(540) Za svaki slučaj

(550) I

(511) Klasa 42: Naučne i tehnološke usluge kao i pripadajuće usluge istraživanja i koncepcije; usluge industrijskih analiza i istaživanja; koncepcija i razvoj računara i računarskih programa/hardvera i softvera/.

(210) Ž-2019-340

(220) 06.09.2019.

(731) The Procter & Gamble Company, One Procter & Gamble Plaza, 45202, Cincinnati, Ohio, US

(540) VIGANTOLVIT

(550) I

(740) Branislav Lutovac, Bulevar Ivana Crnojevića 93, 81000, Podgorica, ME

(511) Klasa 5: Farmaceutski preparati i lijekovi; dijetalna hrana i supstance za medicinsku upotrebu; dodaci prehrani za ljude i bebe; medicinski gips i medicinski flasteri; vitamini i vitaminski preparati; mineralni dodaci prehrani za medicinske svrhe; preparati sa probiotskim bakterijama za medicinske svrhe.

(210) Ž-2019-341

(220) 06.09.2019.

(731) The Procter & Gamble Company, One Procter & Gamble Plaza, 45202, Cincinnati, Ohio, US

(540) VIGANTOLETTEN

(550) I

(740) Branislav Lutovac, Bulevar Ivana Crnojevića 93, 81000, Podgorica, ME

(511) Klasa 5: Farmaceutski preparati i lijekovi; dijetalna hrana i supstance za medicinsku upotrebu; dodaci prehrani za ljude i bebe; medicinski gips i medicinski flasteri; vitamini i vitaminski preparati; mineralni dodaci prehrani za medicinske svrhe; preparati sa probiotskim bakterijama za medicinske svrhe.

(210) Ž-2019-345

(220) 10.09.2019.

(731) Fujikura Ltd., 5-1, Kiba 1-chome, Koto-ku, 135-8512, Tokyo, JP



(540)

(550) I

(740) Miladin Popović, Đoka Miraševića 21/III, 81000, Podgorica, ME, ME

(511) Klasa 7: Mašinski alati; Mašine za rezanje; Električni aparati za zavarivanje; Kontrolni mehanizam za mašine, motore sa unutrašnjim sagorijevanjem ili motore; Ručni alati, izuzev alata na ručni pogon; Matrice i kalupi (djelovi mašina).

Klasa 9: Kompjuterski programi [softver za preuzimanje]; Optička vlakna; Kablovi od optičkih vlakana; Fuzijske spojnice optičkih vlakana; Laserski generatori, ne za medicinske svrhe; Elektrode za fuzijske spojnice optičkih vlakana; Optička pojačala; Konektori za optička vlakna; Čistači optičkih konektora; Optičke

spojnice za optičku komunikaciju; Fiberskopi, ne za medicinske svrhe; Utikači za električne kablove; Ploče sa elektronskim kolima; Fleksibilne štampane ploče za ožičenje (fleksibilne štampane ploče sa elektronskim kolima); Električne sklopke u obliku nizova metalnih kupola za mobilne telefone, lične digitalne asistente [PDA], automatizovanje kancelarija i mjerne instrumente; Membranske sklopke; Senzori pritiska; Senzori kiseonika, ne za medicinsku upotrebu; Elektronski konektori; Konektori za štampane ploče sa elektronskim kolima; Konektori za koaksialne kablove; Konektori za ravne kablove; Ravni kablovi; Koaksialni kablovi; Kablovski remeni za automobile; Konektori za kablovske remene za automobile; Antene; Filmske antene, naime, antene u obliku električnih krugova koji funkcionišu kao antene formirane na filmskim podlogama; Uređaji za regulaciju toplote, naime radijatori sa toplotnim cijevima za telekomunikacione mašine i aparate i elektronske mašine i aparate; Regulatori temperature za telekomunikacione mašine i aparate i elektronske mašine i aparate; Električni kablovi; Elektronski kablovi; Električne žice.

Klasa 35: Savjetovanje u vezi sa poslovnom organizacijom; Savjetovanje i upravljanje ljudskim resursima; Agencije za uvoz-izvoz; Savjetovanje u vezi sa poslovnim upravljanjem u području informacione tehnologije; Pomoć u poslovnom upravljanju.

Klasa 37: Izvođenje građevinskih radova; Telekomunikacione usluge ožičavanja; Instalacija, popravka i održavanje optičkih vlakana, električnih žica, električnih kablova i računarskih žica i kablova; Polaganje kablova; Instalacija ožičavanja za telekomunikacione uređaje i mreže; Pružanje tehničke podrške i tehničkih savjeta u vezi sa ugradnjom, popravkom i održavanjem systemske opreme koja se odnosi na optička vlakna, električne žice i električne kablovske mreže; Popravljanje i održavanje dalekovoda; Građevinske informacije; Instaliranje, održavanje i popravljanje mašina.

Klasa 38: Savjetovanje u vezi sa telekomunikacijama; Omogućavanje pristupa računarskim mrežama i mrežnim računarskim bazama podataka; Komunikacija optičkim mrežama; Komunikacija putem računarskih terminala; Omogućavanje telekomunikacionih veza sa globalnom računarskom mrežom; Pružanje informacija u vezi sa telekomunikacijama.

Klasa 40: Izrada i obrada optičkih vlakana, električnih žica i električnih kablova po narudžbi i specifikaciji drugih, Prilagođeno sastavljanje materijala za druge; Podaci o obradi materijala.

Klasa 41: Akademski treninzi; Lični treninzi; Pružanje obrazovnih informacija; Organizovanje i sprovođenje seminara; Obezbeđivanje on-line elektronskih publikacija koje nije moguće preuzeti.

Klasa 42: Računarsko programiranje i održavanje računarskog softvera; Savjetovanje u vezi sa informacionom tehnologijom [IT]; Tehničko savjetovanje, podrška i inženjering u vezi sa informacionom tehnologijom; Dizajn i tehničko savjetovanje u vezi sa računarskim hardverom, softverom i periferijama; Pružanje tehnoloških informacija u oblasti telekomunikacija; Istraživanja koja se odnose na telekomunikacione tehnike; Istraživanje u oblasti informacionih tehnologija; Ispitivanje, pregled i istraživanje optičkih vlakana, električnih žica i električnih kablova; Savjetovanje u vezi sa telekomunikacionom tehnologijom.

(210) Ž-2019-433

(220) 06.11.2019.

(731) ALBI COMMERCE sh.p.k., Zona e Re Industriale-Veternik p.n., 10000 Prishtinë, Kosovë



(540)

(550) I

(740) Dalibor Roćen, ul. 13. jula br.10, Podgorica, ME

(511) Klasa 29: Mlijeko; piće u kome dominira mlijeko; mlijeko za kafu; zamjena za mlijeko; mlijeko u prahu; kondenzovano mlijeko; jogurt; maslac; sir; krem(pavlaka); džiza; surutka; jestive masti.

(210) **Ž-2019-346**

(220) 11.09.2019.

(731) Sincerely Ltd. B.V., 116 Ravenhill Road, 94563 CA, Orinda, US

LOVEFROM

(540)

(550) I

(740) Jasna Jusić, Dalmatinska 2, 81000, Podgorica

(511) Klasa 3: Preparati za bijeljenje i ostale tvari za pranje rublja; preparati za čišćenje, poliranje, odmaščivanje i abrazivni preparati; sapuni; parfimerijski proizvodi, eterična ulja, kozmetički proizvodi, proizvodi za njegu zuba; preparati za osvježavanje vazduha; aromati [esencijalna ulja]; tamjan; mirišljavi štapići; ulja za parfeme i mirise; potpuri [mirisi]; mirisne vrećice za rublje; mirišljava vodica; mirisljivo drvo; losioni za poslije brijanja; sredstva protiv znojenja [toaletni proizvodi]; preparati za brijanje; kolonjska voda; maska [parfimerijski proizvod]; kozmetički preparati; losioni za kozmetičke svrhe; šminka; parfemi; sapun; toaletni proizvodi; sprejovi za tijelo; preparati za ljepotu i njegu; ne-medicinski preparati za njegu i nanošenje na kosu, tjeme, kožu i nokte; preparati za sunčanje; preparati za zaštitu od sunca; preparati za osvježavanje daha; preparati za kosu; losioni za kosu; šamponi; regeneratori za kosu; preparati za njegu kože; nemedicinski preparati za nanošenje na, regeneraciju i njegu kose, tjemeni, kože i noktiju; vještački nokti; lak za nokte; preparati za pranje rublja; preparati za struganje; sredstva i preparati za depilaciju; šmirgl papir; kamen za glačanje; preparati za pranje vozila; regeneratori za tkaninu; sapun deterdžent; omekšivači tkanine; preparati za bijeljenje rublja; sapuni u prahu; prašak za pranje; soda za pranje; preparati za čišćenje i poliranje kože i cipela; abrazivna krpa; abrazivni papir; ljepila za kozmetičke svrhe; antistatički preparati za upotrebu u domaćinstvu; krpa za struganje; šmirgl papir; preparati za uklanjanje laka; šamponi za kućne ljubimce; odmaščivači i preparati za struganje; preparati za rast kose.

Klasa 7: Mašinske alatke; motori i mašine [osim za kopnena vozila]; kvačila i prenosne komponente [osim za kopnena vozila]; poljoprivredna oruđa koja se ne pokreću ručno; inkubatori za jaja; automatski prodajni automati; roboti; industrijski roboti; laboratorijski roboti; transportni roboti; automatizovani sistemi za rukovanje materijalima koji se sastoje od industrijske opreme, naime, jedinice na mobilni pogon, podesivi inventorski spremnici, inventorske stanice i stanice za održavanje, sve to za potrebe obrade i podnošenja naloga magacinima za obavljanje distribucije i proizvodnje; mješalice; aparati za pripremanje pića, električne mješalice za domaćinstva; aparati za rezanje hljeba; aparati za kuvanje; električni otvarači konzervi; uređaji za potkresivanje [uređaji]; mlinovi za kafu, koji nijesu ručni; aparati za drobljenje; aparati za rezanje; aparati za punjenje; filter aparati; električni aparati za spremanje hrane; električni kuhinjski aparati; aparati za mljevenje; aparati koji se drže u ruci, a koji se ne pokreću ručno; aparati za peglanje; električni kuhinjski mlinovi; električni kuhinjski aparati; električni noževi; električni kuhinjski aparati za rezanje; električni uređaji i aparati za čišćenje; uređaji i aparati za poliranje [električni]; aparati za pravljenje pašte; sjeckalica za meso [uređaj]; mikseri [uređaji]; uređaji za miješanje; pumpe [uređaji]; uređaji za ispiranje; uređaji za oštrenje; usisivači; električne mutilice za korištenje u domaćinstvima; kosilice za travu; kultivatori; električni uređaji za podrezivanje; električni motori; uređaji za bušenje, rezanje i sitnjenje; aparati za friziranje kose; uređaji za predenje; uređaji za prskanje; uređaji za razastiranje đubriva; pletaće

mašine; šivaće mašine; aparati za zaptivanje i čepljenje boca; aparati za duvanje; pištolj za raspršivanje farbe; raspršivači (uređaji); sakupljači kamenca u kotlovima; uređaji za šišanje životinja; uređaji za pravljenje slika; kvačila i mjenjači (osim za kopnena vozila); kese (usisivači —); kertridži za uređaje za filtriranje; otvarači i zatvarači vrata [uređaji]; glave za bušilice [djelovi mašina]; rezači/svrkla za burgije [djelovi mašina]; grijači za dizel motore; oprema za paljenje motora sa unutrašnjim sagorijevanjem; točkovi za oštrenje [djelovi mašina]; crijeva za usisivače; djelovi i oprema za sve naprijed pomenute robe.

Klasa 8: Ručni alat i pribor [ručni]; pribor za ručavanje; vatreno oružje; brijajući; ručne sjeckalice; ručno pokretani prerađivači hrane; ručno pokretani rezači hrane; ne- električni otvarači konzervi; mesarske sjekire/satare; alat za rezanje [ručni]; turpije [alat]; ručno pokretani baštenski alat; ručne pumpe; pegle [ne-električne ručne]; viljuške; noževi; kašike; alati za bušenje rupa [ručni alati]; ne-električni rezači pica; probijači [ručni alat]; makaze; strugači [ručni alat]; instrumenti za oštrenje; strigači [ručni alat]; kašike; escajg [noževi, viljuške i kašike]; pribor za ručavanje u kantinama; kutije prilagođene za pribor za ručavanje; sjeckalice za povrće; sjekači za povrće; noževi za rezanje šnicli; pribor za šišanje i uklanjanje dlaka; uređaji za friziranje kose; alat za manikir; alat za pedikir; pribor za čuvanje; ručni poljoprivredni uređaji i alati; ručni uređaji i alati za baštovanstvo; ručni uređaji i alati za pejzažno uređenje; uređaji za održavanje kamina; ručni alati za rezanje, bušenje, sitnjenje, oštrenje i površinsku obradu; alati za stezanje i pričvršćivanje; alati i uređaji za podizanje; makazice za bradu; uređaji za oštrenje sječiva; štipaljke za stolare ili bačvare; gvozdeni savijači; električne pegle; glačala; rudarske poluge; klješta za uvijanje; klješta za uklanjanje kožice oko noktiju; strugarske šipke; sjekači; sjekači za šipke/bonsek; alat za rezanje [ručni]; turpijice od šmirgle; makazice za šišanje za ličnu upotrebu; pincete za uklanjanje dlaka; čelik za noževe; pincete i klješta za uklanjanje kožice oko noktiju; pincete za uklanjanje dlaka; komplet za pedikir; turpije za nokte; sprave za uvlačenje konca u iglu; makaze; makaze za nokte; pribor za jelo za bebe, novorođenčad i djecu; plastično stono posuđe (pribor za jelo) za jednokratnu upotrebu; kašike sa zaobljenim vrhom za bebe, novorođenčad i djecu; avani za tučenje; pribor za brijanje; kutije za žilete; djelovi i oprema za sve naprijed pomenute robe.

Klasa 9: Računari; računarski hardver; ručni računari; tablet računari; telekomunikacioni uređaji i instrumenti; telefoni; mobilni telefoni; pametni telefoni; uređaji za bežičnu komunikaciju za prenos glasa, podataka, slika, audio, video i multimedijalnog sadržaja; mrežni komunikacioni uređaji; ručni digitalni elektronski uređaji koji omogućavaju pristup internetu i koji služe za slanje, prijem i čuvanje telefonskih poziva, elektronske pošte i drugih digitalnih podataka; nosivi računarski hardver; nosivi digitalni elektronski uređaji koji omogućavaju pristup internetu i koji služe za slanje, prijem i čuvanje telefonskih poziva, elektronske pošte i drugih digitalnih podataka; pametni satovi; pametne naočare; pametni prstenovi; nosivi uređaji za praćenje aktivnosti; pametne narukvice [mjerni instrumenti]; elektronski čitači knjiga; računarski softver; računarski softver za postavljanje, konfiguraciju, rad i upravljanje računarima, računarskim vanjskim jedinicama, mobilnim uređajima, mobilnim telefonima, pametnim satovima, pametnim naočarima, nosivim uređajima, slušalicama koje se umeću u uši, slušalicama koje se stavljaju na glavu, televizorima, upravljačkim kutijama za televizore, audio i video plejerima i rekorderima, sistemima kućnog bioskopa i sistemima za zabavu; softver za izradu aplikacija; softver za kompjuterske igrice; prethodno snimljeni audio, video i multimedijalni sadržaj koji se može preuzimati; računarske vanjske jedinice; vanjske jedinice za računare, mobilne telefone, mobilne elektronske uređaje, nosive elektronske uređaje, pametne satove, pametne naočare, slušalice koje se umeću u uši, slušalice koje se stavljaju na glavu, televizije, upravljačke kutije za televizore i audio i video plejere i rekordera; nosive vanjske jedinice za korištenje sa računarima, mobilnim telefonima, mobilnim elektronskim uređajima, pametnim satovima, pametnim naočarima, pametnim prstenovima, slušalicama koje se umeću u uši, slušalicama koje se stavljaju na glavu, televizorima, upravljačkim kutijama za televizore i audio i video plejerima i rekorderima; biometrijski aparati za utvrđivanje i provjeru identiteta; mjerači ubrzanja; visinomjeri; aparat za mjerenje rastojanja; aparat za bilježenje rastojanja; pedometri; aparat za mjerenje pritiska; pokazivači pritiska; monitori, ekrani,

ekrani koji se nose na glavi i slušalice koje se stavljaju na glavu za korištenje sa računarima, pametnim telefonima, mobilnim elektronskim uređajima, nosivim elektronskim uređajima, pametnim satovima, pametnim naočarima, televizorima, upravljačkim kutijama za televizore i audio i video plejerima i rekorderima; ekrani, naočare, upravljači i slušalice za virtuelni i prošireni prikaz realnosti; 3D naočare; naočare; naočare za sunce; sočiva za naočare; optičko staklo; optička roba; optički aparati i instrumenti; fotoaparati; blicevi za fotoaparate; tastature, miševi, podmetači za miševе, štampači, disk drajvz i hard drajvz; uređaji za snimanje i reprodukciju zvuka; digitalni audio i video plejeri i rekorderi; audiozvučnici; audio pojačivači i prijemnici; audio aparati za motorna vozila; aparati za snimanje i prepoznavanje glasa; slušalice koje se umeću u uši; slušalice koje se stavljaju na glavu; mikrofoni; televizori; televizijski prijemnici i monitori; upravljačke kutije za televizore; radija; radio prenosnici i prijemnici; korisnički interfejsi za računare i elektronske uređaje ugrađene u motorna vozila, naime, elektronske kontrolne table, monitori, ekrani osjetljivi na dodir, daljinski upravljači, priključne stanice, konektori, prekidači i upravljači koji se glasovno aktiviraju; globalni pozicioni sistemi (GPS uređaji); navigacioni instrumenti; navigacioni aparati za vozila unutrašnji [računari]; daljinski upravljači za upravljanje računarima, mobilnim telefonima, mobilnim elektronskim uređajima, nosivim elektronskim uređajima, pametnim satovima, pametnim naočarima, slušalicama koje se umeću u uši, slušalicama koje se stavljaju na glavu, audio i video plejerima i rekorderima, televizorima, upravljačkim kutijama za televizore, zvučnicima, pojačivačima, sistemima kućnih bioskopa i sistemima za zabavu; nosivi uređaji za upravljanje računarima, mobilnim telefonima, mobilnim elektronskim uređajima, pametnim satovima, pametnim naočarima, slušalicama koje se umeću u uši, slušalicama koje se stavljaju na glavu, audio i video plejerima i rekorderima, televizorima, upravljačkim kutijama za televizore, zvučnicima, pojačivačima, sistemima kućnih bioskopa i sistemima za zabavu; aparati za smještaj podataka; računarski čipovi; baterije; punjači za baterije; električni i elektronski konektori, spojnice, žice, kablovi, punjači, priključci, priključne stanice i adapteri za korištenje sa računarima, mobilnim telefonima, ručnim računarima, računarskim vanjskim jedinicama, mobilnim elektronskim uređajima, nosivim elektronskim uređajima, pametnim telefonima, pametnim naočarima, slušalicama koje se umeću u uši, slušalicama koje se stavljaju na glavu, audio i video plejerima i rekorderima, televizorima, upravljačkim kutijama za televizore; interaktivni ekrani osjetljivi na dodir; interfejsi za računare, računarski ekrani, mobilni telefoni, mobilni elektronski uređaji, nosivi elektronski uređaji, pametni satovi, pametne naočare, televizori, upravljačke kutije za televizore i audio i video plejeri i rekorderi; zaštitni filmovi prilagođeni za računarske ekrane, ekrane mobilnih telefona i ekrane pametnih satova; djelovi i pribor za računare, računarske vanjske jedinice, mobilne telefone, mobilne elektronske uređaje, nosive elektronske uređaje, pametne satove, pametne naočare, slušalice koje se umeću u uši, slušalice koje se stavljaju na glavu, audio i video plejere i rekordere, televizore i upravljačke kutije za televizore; navlake, kese, kutije, omoti, trake i uzice za računare, mobilne telefone, mobilne elektronske uređaje, nosive elektronske uređaje, pametne satove, pametne naočare, slušalice koje se umeću u uši, slušalice koje se stavljaju na glavu, upravljačke kutije za televizore i audio i video plejere i rekordere; štapovi za držanje mobilnih telefona prilikom pravljenja selfia; punjači za elektronske cigarete; elektronske kragne za dresiranje životinja; elektronske agende; aparati za provjeru markica na pošti; registarske kase; mehanizmi za aparate za kovani novac; mašine za diktiranje; markeri za obilježavanje ivica; glasačke mašine; elektronski očitivači robe (etikete); faksimil mašine; aparati i instrumenti za mjerenje težine; instrumenti za mjerenje; elektronske table za obavještavanje; aparati za mjerenje; podmetači [silikonske ploče]; integrisana kola; pojačivači; fluorescentni ekrani; daljinski upravljači; optička vlakna; električne instalacije za daljinsko upravljanje industrijskim procesima; svjetlosni zaustavljači; elektrolizeri; uređaji za gašenje požara; radiološki aparati za industrijsku upotrebu; aparati i oprema za spašavanje; zviždeći alarmi; crtani filmovi; jajoliki svijećnaci; zviždaljke za pse; ukrasni magneti; elektrificirane ograde; prenosivi retarderi za automobile na daljinsko upravljanje; računarski hardver za

reprodukciju, organizaciju, preuzimanje, prenošenje, manipulaciju i pregled audio datoteka i medijskih datoteka; elektronski uređaji koji omogućavaju pristup internetu i slanje, prijem i smještaj digitalnih podataka; pametni audio zvučnici kojima se upravlja glasom sa sposobnostima virtuelnog personalnog asistenta; personalni digitalni asistenti; elektronski aparati za glasovne komande i prepoznavanje glasa za upravljanje radom elektronskih uređaja za široku upotrebu i sistemima stambenih zgrada; elektronski aparati za glasovne komande i prepoznavanje glasa i uređaji za daljinsko upravljanje za upravljanje i praćenje elektronskih uređaja, rasvjete, kućanskih aparata, termostata, sistema za grijanje i hlađenje, alarma i kućnih sigurnosnih i nadzornih sistema, detektora dima i ugljen monoksida, brava i reza za vrata i prozora i kućnih automatskih sistema za široku upotrebu: pribor za pametne audio zvučnike; programi za kompjuterske igrice, prenosive igrice sa ekranima od tečnog kristala.

Klasa 10: Osnovni instrumenti za wellness, naime, zdravlje, fitnis, vježbanje i velnis senzori, monitori i ekrani za mjerenje, prikazivanje, praćenje, monitoring, čuvanje i prenos biometrijskih podataka, otkucaja srca, pokreta tijela i sagorelih kalorija; osnovni aparati i uređaji za velnis za mjerenje, prikazivanje, praćenje, monitoring, čuvanje i prenos biometrijskih podataka, otkucaja srca, pokreta tijela i sagorelih kalorija.

Klasa 11: Aparati za rasvjetu, grijanje, proizvodnju pare, kuvanje, hlađenje, sušenje, ventilaciju, snabdijevanje vodom i sanitarne potrebe; roštilji; oprema za kupatila; instalacije za kupatila; oprema za tuševе; oprema za lavaboe; aparati za hlađenje pića; pijaća voda (filteri za -); električna čebad, (nijeku za medicinsku upotrebu); mašine za pravljenje hljeba; tosteri za hljeb; električna svjetla; plafonska svjetla; zidna svjetla; električna svjetla; ukrasna svjetla; solarna svjetla; svijećnaci; električni aparati za kuvanje kafe; šporeti; aspiratori za eliminisanje mirisa i pare u kuhinjama; električne sprave za kuvanje; frižideri; zamrzivači; oprema i instalacije za hlađenje; električne friteze; električni ventilatori za ličnu upotrebu; sobni ventilatori; električne lampe; električne lampice za božićnu jelku; električni aparati za kuvanje na paru; boce za vruću vodu; kutije za led; lampe; držači abažura; fenjeri za osvjetljavanje; sijalice; mikrotalasne pećnice [aparati za kuvanje]; višenamjenska kuvala; plotne; električne džepne lampe; električni lonci za kuvanje pod pritiskom; čajnici; električni čajnici; kuhinjski šporeti [peći]; lampe; držači abažura; sijalice; električne sijalice; daske za wc šolje; električne kafetijere (posude za kuvanje kafe); kade; tuševi; daske za wc šolje i prenosive sanitarne instalacije; sanitarni aparati i instalacije; adapteri za daske za wc šolje i adapteri za daske za wc šolje za djecu; sterilizatori i aparati i oprema za sterilizaciju; sterilizatori za bočice za bebe; vrećice za sterilizaciju za jednokratnu upotrebu; uređaji za sterilizaciju na pari; uređaji za sterilizaciju ultraljubičastim zracima; uređaji za sterilizaciju na putovanju za bočice i opremu za hranjenje beba; svjetla na biciklima; mašine za pravljenje kafe; kupatilske instalacije i oprema uključujući wc šolje; djelovi i oprema za sve gore navedene robe.

Klasa 12: Vozila; aparati za kretanje po kopnu, vazduhu, vodi ili šinama; letjelice; automobili; bicikla; kola; dronovi; dronovi sa kamerama; civilni dronovi; vozila na električni pogon; motocikli; kamioni; vozila bez vozača; bespilotne letjelice; električna vozila; kombiji; dostavni kombiji; vozila na daljinsko upravljanje koja nijeku igračke; gume i točkovi za vozila i bicikla; alarmi i uređaji protiv krađe za vozila; ljepljive gumene zakrpe za popravku unutrašnjih guma; vazdušne pumpe [pribor za vozila]; oprema protiv zasljepljivanja za vozila; lanci protiv klizanja; automobilske gume; kočione pločice za automobile (sigurnosne); navlake (za sjedišta) za vozila; navlake za volane; sigurnosni pojasevi za sjedišta vozila; brisači farova; nasloni za glavu za sjedišta u vozilima; rodkapne; nosači prtljaga za vozila; mreže za prtljag kod vozila; nosači skija za automobile; kolica za transport; prozori za vozila; brisači vjetrombrana; vjetrombrani; brisači vjetrombrana; pretinci u kolima; spremnici za prtljažnik; držači vozačkih dozvola; vrpce za zaštitu od sunca; pomični krovovi; roletne; držači boca pića kod vozila po kopnu; pregrade za pse u vozilima; gepek na krovu vozila; krovni nosači; nosači na krovu; blatobrani; antistatičke trake; nasloni i jastuci prilagođeni za vozila po kopnu; pribor za popravku probušene gume; prikolice; sirene za maglu; neklizajući podovi; pokrivači za

vjetrobrane ili zaštita od mraza i/ili sunca; navlake za vozila; lanci za snijeg; profili guma; pomoćno dječije sjedište u kolima; nosiljke za djecu; pokazivači širine za bicikla, aerodinamički profil za kopnena vozila; zvučni sistemi upozorenja za bicikla; korpe prilagođene za korištenje na biciklima; zvona za bicikla; kočnice za bicikla; lanci za bicikla; ramovi za bicikla; ručke od bicikala; pumpe za bicikla; felge bicikala; sjedišta za bicikla; osovine za bicikla; postolja za bicikla; gume za bicikla; unutrašnje gume za bicikla; pumpe za bicikla; držači boca za vode na motociklima; dječija kolica; kolica za bebe; nosiljke za bebe; navlake za nosiljke za bebe; kabanice za nosiljke za bebe; navlake za kolica za bebe; kabanice za kolica za bebe; invalidska kolica; ručna kolica sa jednim točkom (tačke); kolica za transport; djelovi i pribor za sve naprijed navedene robe.

Klasa 14: Plemeniti metali i njihove legure; nakit; nakit, drago kamenje; bedževi od plemenitog metala; perlice za izradu nakita; kutije od plemenitog metala; imitacija zlata (predmeti napravljeni od-); slonovača [za nakit]; kutije za nakit; privjesci za ključeve [obični ili ukrasni]; medalje; predmeti od imitacije zlata; poludrago kamenje; statue/statuete od plemenitog metala; horološki i hronometarski instrumenti; satovi; ručni satovi; časovnici; klatna za časovnike i satove; kutije za časovnike i klatna; kutije za časovnike i klatna; kutije za satove [reklamne]; kaiševi za ručne satove; narukvice za satove; kutije za satove; lanci za satove; djelovi i pribor za sve naprijed pomenute robe.

Klasa 15: Muzički instrumenti; palice za bubnjeve; gudala za muzičke instrumente; kutije za muzičke instrumente; klavijature za muzičke instrumente; dirke za muzičke instrumente; piskovi za muzičke instrumente; muzički pultovi; muzički sintisajzeri; muzičke kutije; prigušivači za muzičke instrumenti; pedale za muzičke instrumente; čivije (ključevi za zatezanje žica) za muzičke instrumente; perforirane muzičke rolne; klavijatura za pijano; dirke za klavir; žice za klavir; trzalice; duvačke svirale; rolne (perforirane muzičke-); postolja za muzičke instrumente; zvučne viljuške; ključevi za štimovanje; aparat za okretanje muzičkih nota; ventili za muzičke instrumente; djelovi i pribor za sve naprijed pomenute robe.

Klasa 16: Papir, karton; štampane stvari i knjige; materijal za korićenje knjiga; fotografije; kancelarijski pribor; naljepnice i ljepila za upotrebu u kancelariji ili domaćinstvu; umjetnički materijali; slikarske četkice; pisaće mašine i kancelarijski pribor; materijal za poduku i nastavu; plastični materijali za pakovanje; štamparska slova, štamparski blokovi; štampane publikacije; knjige; časopisi; bilteni; periodične publikacije; brošure; knjižice; pamfleti; priručnici; dnevnic; leci; čestitke; reklamni i promotivni materijal; katalogi; knjige iz oblasti fikcije i publicistike na različite teme; serije knjiga iz oblasti fikcije i publicistike, stripovi, romani sa ilustracijama, ilustrovane priče i priče u stripu, priče u crtežima i grafike; periodične publikacije iz oblasti stripova, priča u crtežima i grafici; štampane stvari iz oblasti računara; štampane stvari iz oblasti tablet računara; štampane stvari iz oblasti multimedijalnih proizvoda, interaktivnih proizvoda i usluga putem interneta; katalogi u vezi sa računarskim softverom; računarske brošure; priručnici o računarima; publikacije o računarskom hardveru; priručnici za računarski hardver; uputstva za korisnike računarskih hardvera; uputstva za korištenje računara; priručnici za računare; publikacije u vezi sa tehnologijom, digitalnom tehnologijom i malim aparatima; uputstva za korisnike u elektronski čitljivom, mašinski čitljivom ili računarski čitljivom formatu za korištenje ili za prodaju uz nosive i ručne elektronske uređaje i računare; katalogi muzičkih aparata i instrumenata; katalogi telekomunikacionih aparata, mobilnih telefona, ručnih i mobilnih digitalnih elektronskih uređaja za slanje i primanje telefonskih poziva, faksova, elektronske pošte, videa, instant poruka, muzičkih, audiovizuelnih i drugih multimedijalnih djela i drugih digitalnih podataka; muzičke knjige; muzički priručnici; muzički časopis; pisaći pribor; telefonski adresari; planovi rada (agende); dnevnic; kalendari; poster; okačene i neokačene fotografije; štampani uzorci za majice i trik majice; štampani uzorci za šivenje; materijali za izlaganje; preslikači i naljepnice; knjižice za prodaju sa audio trakama; preslikači; dnevnic; poklon čestitke; poklon vaučeri; etikete; mape; dnevnic; rječnici; lični organajzeri; poštanske markice; razglednice; poster; zamjenjive papirne kese za usisivače; papirne kese za spremanje hrane u mikrotalasnoj pećnici; papirni proizvodi za jednokratnu upotrebu; upijajući papir; papirne maramice; papirni ubrusi; vaučeri; kutije za pokolone; vrećice za poklone; fotografski štamparski

papir; papirni stolnjaci; papirni podmetači; papirni uski dugački stolnjaci; djelovi i pribor za sve naprijed navedene robe.

Klasa 18: Koža i imitacija kože; životinjska koža, štavljena koža; koferi i putne torbe; kišobrani i suncobrani; štapovi; bičevi, remenje i sedlarska roba; akten tašne; vreće, vreće za kampere; vreće za sport; vreće za plažu; kutije od kože ili kožni adresari; omoti i korice za blokove [bilježnice]; kutije od kože ili kožni adresari, imenici ili albumi; prekrivači namještaja od kože ili imitacije kože; putne torbe za odjeću; kutije za šešire od kože ili imitacije kože; ranci; futrole za ključeve; privjesci za prtljag; suncobrani; novčanici; tašne; ruksaci; torbe za kupovinu; rameni kaiševi od kože ili imitacije kože; koferi; kaiševi - remenici za nošenje novorodenčadi; torbe za alat, prazne; putni kompleti [kožna roba]; akten tašne; kaiševi; kožni kaiševi; ogrlice i povoci za životinje; futrole za ključeve; pertle; muzičke kutije; tašne; školske torbe; novčanici; krzno i odjeća i artikli napravljeni od krzna; putne torbe; neseseri, prazni; torbe za kupovinu na točkicama; djelovi i pribor za sve naprijed pomenute robe.

Klasa 20: Namještaj; ogledala, ramovi za slike; neobrađena ili poluobrađena kost, rog, slonovača, kitova kost ili sedef; školjke; morska pjena; žuti ćilibar; fotelje; bačve, nemetalne; korpe, nemetalne; okviri za krevete; točkici za krevete, nemetalni; navlake za krevet osim posteljine; oprema za krevet, nemetalna; kreveti; kreveti za kućne ljubimce; drveni okviri kreveta; klupe [namještaj]; jastuci; stalci za boce; kutije od drveta ili plastike; drške za metle, nemetalne; burad, nemetalna; stolice [sjedišta]; sanduci, nemetalni; komode; daske za sječenje [stolovi]; spone i zatege za kablove i cijevi, koji nijesu od metala; zatvarači kontejnera, nemetalni; kuke za kačenje odjeće, nemetalne; vješaonici za kapute; stalci za kapute; kontejneri, nemetalni [za skladištenje, transport]; plutani čepovi; navlake za garderobu [garderob]; sanduci (gajbe); ormani; držači zavjesa, koji nijesu od tekstila; kuke za zavjese; šipke za zavjese; alke za zavjese; šipke za zavjese; omče i petlje za zavjese; jastuci; stolice za ležanje (ligeštuli); dekoracije od plastike za hranu; pisaci stolovi; oglasne table; divani; zvona na vratima, nemetalna i ne-električna; klinovi za vrata, nemetalni; zatvarači za vrata, nemetalni; djelovi za vrata, nemetalni; kvake za vrata, nemetalne; sprave za kucanje na vratima; toaletni stočići; naslonjače (ležaljke); ventilatori za ličnu upotrebu, koji nijesu električni; figurice [statuete] od drveta, voska, gipsa ili plastike; ormani za dokumenta; postolja za saksije; postolja za saksije [namještaj]; oprema za namještaj, nemetalna; namještaj od metala; police; korpe za rublje sa poklopcem; kućice i kontejneri za kućne ljubimce; ručna ogledala [toaletna ogledala]; držači za šešire; kuke, nemetalne, za vješanje odjeće; kućni brojevi, nemetalni, koji ne svijetle; unutrašnje prozorske roletne [za zamračenje] [namještaj]; namještaj na naduvavanje; reklamni predmeti na naduvavanje; platnene unutrašnje prozorske roletne; okrugle ručke, nemetalne; merdevine od drveta ili plastike; stalci za časopise; krojačke lutke; dušeci; ormarići za lijekove; ogledala; pločice od ogledala; skulpture [ukras]; kancelarijski namještaj; plastični kontejneri za pakovanje; papirne roletne; kočici [igle], nemetalni; jastuci; stalci za tanjire; stubovi, nemetalni; stalci [namještaj]; ratan; podmetači ili pokrivači za sudopere koji se mogu uklanjati; paravani za kamine [namještaj]; paravani [namještaj]; sofe, divani i klupe; police za skladištenje; djelovi polica; vitrine [namještaj]; ormani, kredenci za posude; vreće za spavanje u šatoru; podmetači za spavanje; sofe; statue od drveta, voska, gipsa ili plastike; stepenice [merdevine], nemetalne; pomoćne male merdevine, nemetalne; stolice; stolovi; ploče od stola; kutije za alat, nemetalne, prazne; držači za peškire, pričvršćeni, nemetalni; stalci za peškire [namještaj]; tacne, nemetalne; kolica [namještaj]; stalci za kišobrane; umivaonici [namještaj]; zvonca pokretana vjetrom [ukrasna]; zatvarači za prozore, nemetalni; oprema za prozore, nemetalna; umjetnička djela od drveta, voska, gipsa ili plastike; nemetalne kante; namještaj za kupatila; namještaj za skladišta; kontejneri za drenažu ulja; čepovi za zatvaranje; nemetalne L table i tablice sa oznakom zemlje na vozilima; nemetalne oznake; držači vozačke dozvole (nemetalni), nemetalni zatvarači, matice i podloške; posude za vodu; kutije za alat i kolica (nemetalna); unutrašnje roletne od letvica; radne klupe; vreće za spavanje, stolice na rasklapanje, stoličice na rasklapanje i kreveti na rasklapanje; jastuci; vazdušni kreveti; korpe; vješaonici za odjeću; tablice sa brojevima; nemetalne trake

za kablove; police (rafovi); ormarići; kutije za odlaganje; gajbice; ogledala; kontejneri za gorivo; držači za knjige, korpe; djelovi i pribor za sve naprijed pomenute robe.

Klasa 21: Kućne ili kuhinjske potrepštine i posude; češljevi i sunđer; četke [osim slikarskih četki]; materijali za pravljenje četaka; artikli za čišćenje; čelična vuna; neobrađeno ili poluobrađeno staklo [osim građevinskog stakla]; staklarija, porcelan i grnčarija; abrazivni jastučići za upotrebu u kuhinji; posude [za čuvanje hrane]; korpe za upotrebu u domaćinstvu; kašike za prelivanje [pribor za kuvanje]; mutilice, ne-električne; krigle za pivo; čaše za pivo; vrčevi za pivo; mješalice, ne-električne, za upotrebu u domaćinstvu; otvarači za boce, električni i ne-električni; boce; zdjele [činije]; korpice za hljeb, za kućnu upotrebu; kutije za hljeb; daske za sječenje hljeba; metle; četkarska roba; kofe; kandelabri [svijećnaci]; sprave za gašenje svijeća; teglice sa svijećom [držači]; prstenovi za svijeće; uređaji za čišćenje tepiha; kazani (kotlovi); keramički proizvodi za upotrebu u domaćinstvu; kofe za šampanjac; čaše za šampanjac; porcelanski ukrasi; štapići za jelo; instrumenti za čišćenje, ručni; vješalice za veš; krpe za čišćenje; podmetači koji nijesu od papira i koji nijesu stono platno; ručni mikseri za koktele; posude za miješanje koktela; filteri za kafu, ne-električni; mlinovi za kafu, ručni; filteri za kafu, ne-električni; džezve za kafu, ne-električne; servisi za kafu [stono posuđe]; posuđe za upotrebu u domaćinstvu ili kuhinji; šerpe; kompleti šerpi; kuhinjske metalne igle (za ražanj); pribor za kuvanje, ne-električni; hladionica [posude za led]; vadičepovi, električni i ne-električni; flašice; mlinovi za upotrebu u kuhinji; ne-električni; kristal [staklarija]; šolje; poslužavnici za escajg; kuhinjske daske za sječenje; bokali; friteze, ne-električne; aparati za dezodorans za ličnu upotrebu; pokrivači za sudove; posude; tanjiri za jednokratnu upotrebu; čaše za piće; slamke za piće; posude za piće i pribor za barove; kante za otpatke; zemljane posude; čašice za jaja; figurice [statuete] porcelanske, keramičke, zemljane ili staklene; izletničke korpe zajedno sa posuđem; bočice; saksije za cvijeće; posude za kuvanje na pari, ne-električne; tiganji; lijevci; baštovanske rukavice; presa za bijeli luk [kuhinjski pribor]; staklene zdjele; staklene posude [za čuvanje hrane]; staklo, obrađeno ili neobrađeno, osim stakla u građevinarstvu; rukavice za domaćinstvo; rende za kuhinjsku upotrebu; roštilji [pribor za kuvanje]; toplotno-izolacione posude; posude za čuvanje toplote pića; pljoske; držači za cvijeće i biljke [za cvjetne aranžmane]; tople posude, bez električnog zagrijavanja; kalupi za kocke leda; sobni akvarijumi; sobni terarijumi [za uzgajanje biljaka]; navlake za daske za peglanje; daske za peglanje; čajnici, ne-električni; kuhinjske posude; kuhinjski mlinovi, ne-električni; kuhinjske potrepštine; kutije za hranu; mlinovi za korištenje u domaćinstvu, ručni; kašike za miješanje [kuhinjske potrepštine]; brisači poda sa resama od tkanine; šolje; kompleti šolja; četkice za nokte; držači za salvete; prstenovi za salvete; rukavice za pećnice; papirni tanjiri; noževi za kolače; mlinci za biber, ručni; sprejovi za parfeme; lopatice za posluživanje pite; pehari (bokali za piće); aparati i mašine za poliranje u domaćinstvu, ne-električni; porcelansko posude; podmetači za vruće šerpe; poklopci za šerpe; šerpe; lonci; uređaji za kuvanje pod pritiskom [autoklavi], ne-električni; oklagije, kućne; činije za salatu; slanici; tacne; kutlače [stono posuđe]; servisi [posuđe], četke za brijanje; stalci za četke za brijanje; kutije za sapun; dozeri za sapun; držači za sapun; zdjele za sapun; špatule [kuhinjske potrepštine]; kompleti začina; porcelanske, keramičke, zemljane ili staklene figurice; cediljke za upotrebu u domaćinstvu; posude za šećer; tanjiri; pribor za jelo osim noževa, viljušaka i kašika; vrčevi; čajnici; servisi za čaj [posuđe]; četke za toalet; neseseri sa toaletnim priborom; držači toalet papira; toaletne potrepštine; četkice za zube; držači za peškire u vidu šipki i prstenova; poslužavnici za domaćinstvo; potrepštine za domaćinstvo; vaze; činije za povrće; korita za pranje rublja; korpe za bacanje papira; uređaji za zalivanje; hladionici za vino; bokali za vino; čaše za vino; prozorske kutije za cvijeće; umjetnička djela od porcelana, keramike, pečene gline ili stakla; tegle; krčazi; boce; vaze; posude za biljke; ukrasne ploče; rukavice za vađenje hrane iz pećnice; komplet posuda; limene kutije za kolače; limovi za pečenje u domaćinstvu; kontejneri za odlaganje hrane; spremnici za hranu; tegle za držanje hrane; tacne za domaćinstva; poslužavnici za hranu; porcelansko posuđe; ukrasni predmeti od porcelana; kafetijere; kante za otpatke sa pedalom; kante za rublje; korpe za rublje; artikli za kupatila; artikli za tuševu; krpe za prašinu,

krpe za brisanje i jelenska koža, sve za čišćenje; kofe; strugači leda; čelična vuna, nemetalni pribor i posuđe, uključujući boce za vodu; neelektrične džezvem pribor za nošenje vode za kampovanje i izlete i metalne tacne za izlete; krpe i podmetače od staklenog vlakna za upotrebu prilikom popravki motora vozila i slično; držači čaša; dozatori i aparati za doziranje; deodorisajući aparati; djelovi i pribor za sve naprijed pomenute robe.

Klasa 24: Tekstili i zamjene za tekstile; prekrivači za krevete; stolnjaci; posteljina; tekstili za kupatilo, izuzev odjeće; rukavice za tuširanje i kupanje; ćebad za krevete; posteljino rublje; posteljina; platno; podmetači [stono platno]; navlake za jastuke; prekrivači za namještaj [nepričvršćeni]; držači zavjesa od tekstila; zavjese od tekstila ili plastike; platno (tkanine); tkanine za tekstilnu upotrebu; peškiri za lice od tekstila; flanel [tkanina]; maramice od tekstila; rublje za domaćinstvo; pokrivači za dušeke; mrežaste zavjese; nepredena tekstilna platna; jastučnice; otirači koji nijesu od papira; zavjese za tuš od tekstila ili plastike; postava za vreće za spavanje; stolnjaci koji nijesu od papira; stono platno koje nije od papira; podmetači za sto koji nijesu od papira; stone salvete od tekstila; dugački uski stolnjaci; tekstilni materijal; peškiri od tekstila; prekrivači za putovanja [za preko krila]; ćebenca; kuhinjske krpe; peškiri za kupanje; peškiri za plažu; tapiserije zidne od tekstila; ćebad za kućne ljubimce; tkanina za zastave i ukrasne zastavice; platna za tapete ili vezenje; gaza; ubrusi od tkanine za uklanjanje šminke; pelene za bebe; platno za pelene; maramice od tekstila; mreže protiv komaraca.

Klasa 25: Odjeća, obuća, pokrivala za glavu; kecelje [odjeća]; bandane [marama za oko vrata]; bademantili; pojasevi [odjeća]; portikle, ne od papira; čizme; vrhovi kapa; kape [pokrivala za glavu]; kaputi; sobni ogrtači; haljine; štitnici za uši [odjeća]; rukavice [odjeća]; šeširi; vrpce za glavu [odjeća]; kabanice [odjeća]; čarape; jakne [odjeća]; dresovi [odjeća]; pletenina [odjeća]; dokoljenice [grijači nogu]; helanke [pantalone]; kostimi za maskenbal; pojasevi za nošenje novca [odjeća]; mufovi [odjeća]; spoljna odjeća; radni kombinezoni; ogrtači, kaputi; pidžame; papirna odjeća; papirni šeširi [odjeća]; gotova, konfekcijska odjeća; sandale; ešarpe za nošenje; marama, šalovi; šalovi; košulje; cipele; košulje kratkih rukava; kape za tuširanje; suknje; maske za spavanje; odjeća za spavanje; negližei s gaćicama; sobne papuče; čarape; džemper; majice; pantalone; donji veš; uniforme; prsluci; viziri [pokrivala za glavu]; voodootporna odjeća; pelene za bebe od tekstila; kostimi za maskenbal; pojasevi za novac; kamašne / dokoljenice; podvezice za čarape; kramponi za kopačke; naramenice za odjeću; vrhovi obuće; djelovi i pribor za sve naprijed pomenute robe.

Klasa 26: Čipka i vez, trake i gajtani; dugmad, kukice i očice, špenadle i igle; vještačko cvijeće; prekrivači za čajnike; galanterija izuzev konaca; drikeri i kopče za gornje djelove odjeće; kopče za odjeću; elastične trake za držanje rukava; vještačke brade; vještačka kosa; vještački brkovi; šnale, ukosnice; kape za farbanje kose; uvijači kose, vikleri, koji nijesu ručni ne-električni pribor; papiri za uvijanje kose; igle za kovrdžanje kose; produžeci kose; držači za kosu [pokretni]; mrežice za kosu; ukrasi za kosu; šnale za kosu; ukosnice; trake za kosu; zakrpe za popravku tekstilnih proizvoda koje se lijepe pomoću toplote; ljudska kosa; igle za pletenje; jastučići za igle; uzice i povoci za djecu; kutije za šivenje; naprsci za šivenje; kopče za cipele; rupice za pertle za cipele; elementi za kopčanje cipela; pertle za cipele; ukrasi za cipele; ukrasi za odjeću; pantalone za bicikliste; perike; patentni zatvarači; patentni zatvarači za torbe; patentni zatvarači; patentni zatvarači za torbe; djelovi i pribor za sve naprijed pomenute robe.

Klasa 27: Tepisi, ćilimi, otirači i prostirke, linoleum i drugi materijali za prekrivanje podova; zidne tapete [koje nijesu od tekstila]; prostirke za kupatila; tepih pločice; dekorativne zidne tapete koje nijesu od tekstila; otirači; podne obloge; otirači koji se ne klizaju; tekstilne tapete; podovi od vinila; tapete; podne pločice; zidne i plafonske obloge; prostirke; vještačka trava; djelovi i pribor za sve naprijed navedene robe.

Klasa 28: Igre i igračke; aparati za video igre; gimnastička i sportska oprema; ukrasi za božićnu jelku; elektronske ručne konzole za igrice; električne kompjuterske igrice, osim onih koje su podešene za korištenje sa televizijskim prijemnicima; električni i elektronski aparati za zabavu (automatski, koji se pokreću ubacivanjem metalnih novčića); video igrice, osim onih koje su podešene samo za korištenje sa

televizijskim prijemnicima; kompjuterski aparati za igranje osim onih koji se pokreću ubacivanjem metalnih novčića ili su podešeni za korištenje sa televizijskim prijemnicima; igračke i igre za video izlazom; interaktivne kompjuterske igračke i igrice; samostalni uređaji za video igrice sa ugrađenim ekranom; kompjuterski aparati za igranje, elektronski aparati za igranje i aparati za video igrice koji nijesu obuhvaćeni drugim klasama; konzole za igranje; zaštitni filmovi prilagođeni za ekrane za nosive igrice; upravljači za konzole za igranje; konji za klackanje, fliperi; aparati za igranje flipera (igračke); muzičke igračke, igrice i predmeti za igranje; audio uređaj kao igračka; muzičke kutije kao igračke; muzički instrumenti kao igračke; gramofoni igračke i za kasetofoni; igračke na baterije; elektronske igračke; elektronski pokretane igračke; kompjuteri igračke (koji ne rade); mobilni telefoni igračke (koji ne rade); lutke; neobične maske za lice (igračka); drangulije u obliku suvenira; staklene sniježne kugle; akcione figurice i dodaci za akcione figurice; odjeća i dodaci za lutke koji nijesu obuhvaćeni drugim klasama, a sve za lutke; hokej igrice; kamioni igračke; vozila na elektronski pogon, štitnici za vožnju bicikla, vozila igračke u kojima se može voziti, makete vozila, vozova i aviona, modeli vozova, kompleti za izradu modela vozila, igračke na naduvavanje, odjeća za lutke i druge igračke i lutke, vozila igračke; sezonski i praznični ukrasi; baloni; društvene igre; slagalice; plišane igračke, kasice prasice, kompleti za modelovanje; lopte; leteći tanjiri, društvene igre, modeli liveni u kalupu, građevinske kocke za igranje za, kutije za igračke, tiketi za loto, leteći tanjiri, slagalice, igračke psi; igračke mačke; dronovi [igračke], igračke, upravljači za igračke; društvene igre za stolom; igranje karata; loptice za igre, bilijarski stolovi, bilijarske loptice, bilijarski štapovi i ostala oprema za bilijar, loptice za golf, držači golf loptica, oznake za golf loptice, uređaj za izbacivanje loptica; bilijarski stolovi i štapovi, stalci za bilijarske štapove i loptice; sprave za bodi bilding; sprave za rehabilitaciju tijela; sprave za vježbanje; sprave za jačanje grudnih mišića [sprave za vježbanje]; pojasevi za dizanje tegova [sportski artikli]; pojasevi za dizanje tegova i druga sportska i gimnastička oprema; streličarski pribor; gimnastički i sportski artikli koji nijesu obuhvaćeni drugim klasama; skejboardovi; tobogani i sanke; bob sanke, pikado strelice, meta za pikado; igre lovačkih vabilica, bazeni [artikli za igranje]; plastične piste; bejzbol rukavice; sličuge; praskave božićne bombone; štapovi i pribor za pecanje; čigre; paravani za kamuflažu [sportski artikli]; grebalice za lutriju; traka za upijanje znoja za palicu ili reket; kompjuterski i video uređaji za igranje igrice, osim onih koji se pokreću ubacivanjem kovanog novčića ili onih koji su prilagođeni za korištenje sa televizijskim prijemnicima.

Klasa 30: Kafa, čaj, kako i zamjena za kafu; riža; tapioka, sago (skrob iz sjemena palme sago), brašno i pripravci od žitarica; hljeb, kolači i konditorski proizvodi; sladoledi; šećer, med, melasa; kvasac, prašak za pečenje; so; senf; sirće, sosovi (začinski dodaci); začini; led; mirođije; slatkiši od badema; pasta od badema; anisovo sjeme; aromatični preparati za prehrambene proizvode; zamjena za kafu; prašak za pecivo; soda bikarbona; ječmeno brašno; brašno od boba; propolis; pivsko sirće; vezivni agensi za sladoled; hljeb; kifle; prezla; zemičke; glazure za kolače; prah za kolače (prašak za pecivo); bonbone; kapar; pločice od žitarica; grickalice od žitarica; proizvodi od žitarica; burgeri od sira [sendviči]; žvakaće gume; čips [proizvodi od žitarica]; čokoladni napici; čokoladni musevi; kakao; napici od kakaoa; kafa; napici od kafe; začinski dodaci; keksi; so za kuvanje; kukuruzne pahuljice (konrflejs); kukuruzno brašno; kuskus [griz, krupica]; krekeri; krem od vanile; dezertni musevi [konditorski proizvodi]; tijesto; prelive za salate; arome za slatkiše, osim esencijalnih ulja; zamrznuti jogurti [ledeni konditorski proizvodi]; baštenske trave, konzervirane [začinske]; đumbir [začin]; kolačići od đumbira; glukoza za upotrebu u kulinarstvu; aditivi sa glutenom za upotrebu u kulinarstvu; gluten spremljen kao hrana; šećerni sirup; glazura za šunke; visokoproteinske pločice od žitarica; med; sladoled; led za hlađenje napitaka; prirodni ili vještački led; ledeni čaj; infuzije (nemedicinske); kečap [paradajz sos]; pastile [konditorski proizvodi]; marcipan; majonez; sokovi od mesa; pite od mesa; musli; prirodni zaslađivači; obroci spremljeni sa rezancima; rezanci; oraščić; proizvodi od ovsu; ovsene pahuljice; ovsena kaša; palmin šećer; palačinke; pašta; sos za paštu; tjestenina; peciva; poslastice od kikirikija; biber; slatkiši sa mentom; biberi [začini]; pesto [sos]; pite; pice; kokice; praline; pudinzi; kiševi;

ravioli; začinski umak [začinski dodatak]; rižini kolači; matični mliječ; dvopek; sago; sendviči; sosevi [začinski dodaci]; začini; griz, krupica; sorbeti [ledeni]; soja sos; špegete; prolječne rolnice; šećer; suši; takosi; tapioka; tartevi; čaj; napici sa čajem; sredstva za zgušnjavanje za kuvanje hrane; sos od paradajza; tortilje; kurkuma za hranu; nepržena kafa; sirće; vafli; pšenično brašno; pšenične klice za ljudsku ishranu; germa; konditorski proizvodi; nemedicinski konditorski proizvodi; smrznuti konditorski proizvodi; konditorski proizvodi od šećera; čokolada; čokoladni konditorski proizvodi; konditorski proizvodi u zamrznutom stanju; konditorske pločice; pastile; slatke tablete; slatkiši; sladoledi na štapiću; čokolade; keksi; torte; slatka peciva; napolitanke; grickalice od riže; grickalice od pšenice; grickalice od rezanaca; sladoled i proizvodi od sladoleda, rashlađeni i zamrznuti konditorski proizvodi i dezerti; hladni čaj.

Klasa 32: Piva; mineralne i gazirane vode i druga bezalkoholna pića; voćni napici i voćni sokovi; sirupi i drugi proizvodi za pravljenje napitaka; englesko pivo; pivo; plzensko pivo; tarnno pivo; radler (miješano piće od piva i gaziranog bezalkoholnog pića); crno pivo; kvas; pivo sa niskim procentom alkohola; bezalkoholno jabukovo vino; bezalkoholna vina; bezalkoholni aperitivi; napici koji sadrže vitamine; napici obogaćeni vitaminima; pića od surutke; bezalkoholni kokteli; energetska pića; energetska pića koja sadrže kofein; aromatizirana gazirana pića; voćni sokovi; pića od guarane; napici na bazi meda; izotonični napici; izotonična pića; hipertonična i hipotonična pića (za upotrebu od strane ili po potrebi sportista); sportska pića; bezalkoholna pića bez slada; biljno mlijeko; stona voda; sok od paradajza [napitak]; sokovi od povrća; vode; šumeće tablete (šerbetne) i šumeći prah za pića; frapei (bezalkoholni voćni napici); sladovina; pivo od slada; kokteli sa pivom; pivo od đumbira; ekstrakti hmelja za proizvodnju piva.

Klasa 33: Alkoholna pića (osim piva); alkoholna pića sa sadržajem voća; alkoholne esencije; alkoholni ekstrati; aperitivi; gorka pića; konjak; cachaca (vrsta brazilskog alkoholnog pića); kalvados; krem likeri; pivo od jabuke; kokteli; kurakao; digestivi [likeri i alkoholna pića]; destilisana pića; alkoholni voćni ekstrati; džin; rakija; medovina; trešnjavača; likeri; nira [alkoholno piće na bazi šećerne trske]; likeri od metvice; kruškovača; vina od komine; unaprijed pomiješana alkoholna pića (koja u sebi nemaju pivo); rižin alkohol; rum; sake; žestoka alkoholna pića; tekila; votka; viski; vino; alkoholna energetska pića; alkoholni punčevi; miješani viski; burbon viski; kalvados; gazirana alkoholna pića; destilovani napici i žestoka pića; aromatični žestoka alkoholna pića; rakija; likeri koji sadrže krem; pića sa niskim procentom alkohola; vino sa niskim procentom alkohola; viski od slada; kuvana vina; porto; vino iz Porta; rum punč; sangria, šneps; šeri; pjenušava vina; tekila; vermut.

Klasa 34: Duvan; pribor za pušače; šibice; držači za šibice; lule za duvan; lule za duvan (upijajući papir za -); čistači za lule; kese za duvan; cigarete; cigarete koje sadrže zamjene duvana, koji nijesu za medicinsku upotrebu; cigaret papir; filteri za cigarete; cigare; tabakere; sjekači za cigare; cigarilosi; trave za pušenje; pepeljare za pušače; elektronske cigarete; elektronske cigare; raspršivači elektronskih cigareta; kartomizeri elektronskih cigareta; čistači elektronskih cigareta; elektronske lule; elektronske nargile; arome, koje nijesu esencijalna ulja, za korištenje u elektronskim cigaretama; tečni nikotinski rastvori za korištenje u električnim cigaretama; ovlaživači (tabakera); upaljači za pušače; burmut; burmutice.

Klasa 35: Reklamiranje; poslovni menadžment; poslovna administracija; kancelarijski poslovi; oglašavanje putem pošte; vođenje poslova oglašavanja; reklamne usluge, naime, promovisanje roba i usluga trećih lica; usluge oglašavanja po kategorijama; prezentacija roba; razvijanje reklamnih artikala; distribucija uzoraka; oglašavanje direktnom poštom; distribucija reklamnog sadržaja; distribucija reklama za treća lica putem elektronske komunikacione mreže; usluge preloma za reklamne svrhe; usluge modela za reklamne svrhe ili prodajne promocije; iznajmljivanje reklamnog prostora; oglašavanje putem interneta na računarskim mrežama; oglašavanje na internetu i globalnim računarski mrežnim sistemima; organizacija izložbi za komercijalne ili reklamne svrhe; organizacija sajmova za komercijalne ili reklamne svrhe; oglašavanje na otvorenom; promovisanje roba i usluga trećih lica putem ograničene dostupnosti; ponude nižih cijena putem onlajn elektronske komunikacione mreže; obezbjeđivanje onlajn reklamnog vodiča koji

se može pretraživati a koji sadrži robe i usluge trećih lica; reklamiranje na radiju; iznajmljivanje reklamnih termina na komunikacionim medijima; maloprodajne usluge oglašavanja, naime, distribucija reklamnih materijala za treće strane putem elektronske komunikacione mreže; ažuriranje reklamnog materijala; televizijsko reklamiranje; analiza tržišta; istraživanje tržišta; usluge istraživanja tržišta i informisanja; ispitivanje javnog mnjenja; odnosi sa javnošću; usuge odnosa sa javnošću; objavljivanje reklamnih tekstova; reklamne agencije; transkribovanje; reklamni tekstovi (pisanje -); iznajmljivanje reklamnog materijala; agencije za zapošljavanje; zapošljavanje osoblja; psihološki testovi u vezi sa izborom osoblja; konsultantske usluge u vezi sa zapošljavanjem osoblja; promovisanje korištenja energije sa farmi vjetroturbina; promovisanje korištenja energije iz solarnih farmi; računovodstvo; administrativna obrada narudžbenica; pomoć kod nabavke roba i usluga za treća lica; pomoć u kupovini roba i usluga za treća lica; usluge revizije; knjigovodstvo; poslovna pomoć za umjetnike i izvođače; procjene poslovanja; usluge pružanja poslovnih informacija; ispitivanje poslovanja; poslovno istraživanje; usluge pomoći u upravljanju poslovanjem; konsultantske usluge u poslovnom upravljanju; konsultantske usluge u organizaciji poslovanja; komercijalno upravljanje licenciranjem rob i usluga trećih lica; usluge agancija za pružanje komercijalnih informacija; pomoć u komercijalnom upravljanju; prikupljanje analiza troškova; kopiranje dokumenata; analiza troškova; umnožavanje dokumenata; sastavljanje izvoda sa računa; ekonomska predviđanja; usluge stručnjaka za efikasnost; pomoć u industrijskom upravljanju; usluge fakturisanja; fotokopiranje; izrada platnih spiskova; izrada poreskih prijava; usluge poslovnog konsultovanja; obezbjeđivanje internetskog imenika komercijalnih informacija; usluge promjena poslovnog sjedišta; iznajmljivanje aparata za kopiranje; iznajmljivanje automata za prodaju; istraživanja za sponzorstva; sekretarske usluge; stenografske usluge; telefonski odgovori za nedostupne pretplatnike; transkribovanje; daktilografske usluge; obrada teksta; prikupljanje i sistematizacija podataka u računarske baze podataka; prikupljanje poslovnih informacija u bazu podataka dostupnu preko globalne računarske mreže, koja se može pretraživati; prikupljanje računarskih baza podataka za prenošenje, prikazivanje i smještanje transakcionih, identifikacionih i finansijskih informacija; prikupljanje informacija u računarske baze podataka; prikupljanje statističkih podataka; kompjuterizovano upravljanje podacima; usluge kompjuterizovanog upravljanja bazama podataka; kompjuterizovana obrada narudžbenica dobijenih putem interneta; usluge upravljanja bazama podataka; obezbjeđivanje internetskog imenika komercijalnih informacija; pružanje poslovnih informacija putem baze podataka koja se može pretraživati i putem globalne računarske mreže; pretraživanje podataka u računarskoj bazi podataka, za treća lica; pretraživanje podataka u računarskim datotekama, za treća lica; sortiranje i uređivanje informacije u računarskim bazama podataka; upravljanje programom popusta koji omogućava učesnicima da dobiju popuste za usluge dostave putem korišćenja programa za članove i programa varijabilne cijene dostave; usluge pretplate na novine (za treća lica); usluge pretplate na telekomunikacione usluge, za treća lica; usluge pretplate za medije, za treća lica; internetska prodaja muzike na malo u digitalnom obliku ili pohranjene na medijima; kompjuterizovano internetsko naručivanje usluga za treća lica osnovnih roba ili roba široke potrošnje; usluge programa lojalnosti kupaca koji obezbjeđuju nagrade u vidu jeftinijih usluga otpreme; usluge baza podataka kako bi treća lica mogla da jednostavno pregledaju i biraju usluge sa internetske stranice; distribucija reklama za treća lica putem interneta; promovisanje roba i usluga trećih lica nuđenjem nižih cijena ograničenom broju kupaca putem interneta; prikupljanje jednog broja pružaoca usluga da bi treća lica mogla da jednostavno pregledaju i biraju usluge sa internetskih strana; usluge aukcija; aukcija; usluge aukcionarstva; usluge poslovnog posredovanja za prodaju i kupovinu roba i usluga; usluge upoređivanja (cijena -); kompjuterizovano naručivanje usluga preko interneta za osnovne robe i robe široke potrošnje; agencije koje se bave uvozom i izvozom; usluge pružanja informacija, naime, pružanja informacija kupcima o proizvodima iz maloprodaja, uz mogućnost obezbjeđivanja proizvoda koji ih konkretno interesuju; usluge informisanja, savjetovanja i konsultovanja u vezi sa svim naprijed pomenutim.

Klasa 41: Obrazovanje; pružanje obuka; zabava; sportske i kulturne aktivnosti; obezbjeđivanje muzike putem interneta koja se ne može preuzimati; obezbjeđivanje audio sadržaja putem interneta koji se ne može preuzimati, uključujući muziku, radio programe u emotivanju, audio knjige, podcast i vebkast sadržaje; zabava, naime, obezbjeđivanje audio i multimedijalnog sadržaja, igrice, softverskih aplikacija; pružanje informacija, novosti i komentara iz oblasti zabave, popularne kulture, rekreacije i slobodnih aktivnosti, sporta i sportskih događaja, edukativnih usluga, koncerata, kulturnih događaja i pozorišnih predstava uživo; pružanje informacija u vezi sa organizovanjem edukativnih, kulturnih, sportskih i zabavnih izložbi i zajedničkih, sportskih i kulturnih aktivnosti, takmičenja i igara; obezbjeđivanje audio publikacija putem računarskih mreža, koje se ne mogu preuzimati, naime, periodičnih publikacija i izvjestaja na temu obrazovanja, zabave, popularne kulture, rekreacije i slobodnih aktivnosti, sporta i sportskih aktivnosti, tehnologije, koncerata, kulturnih aktivnosti i pozorišnih predstava uživo; pružanje informacija iz oblasti obrazovanja i zabavnih aktivnosti i događaja za djecu; organizovanje časova, radionica i podučavanja korištenjem softverskih aplikacija koje se pokreću glasom; iznajmljivanje biblioteka; obazbjeđivanje elektronskih publikacije putem interneta, koje se ne mogu preuzimati; distribucija video traka; obezbjeđivanje usluga igara virtuelne stvarnosti putem interneta na računarskoj mreži; vođenje fitnes časova; iznajmljivanje igračaka; iznajmljivanje opreme za igranje; dresiranje životinja; umjetnici modeliranja; organizovanje igara na sreću; usluge obrazovanja, podučavanja i obuka na računaru; obezbjeđivanje igrice na računaru; usluge elektronskog izdavaštva; obezbjeđivanje elektronskih knjiga, časopisa, novina, žurnala, periodičnih izdanja i drugih publikacija; obazbjeđivanje onlajn tekstualnih, video, audio i multimedijalnih programa; usluge rezervacije karata i rezervisanja za zabavne, sportske i kulturne događaje; pružanje informacije, savjeta, novosti, kritika i komentara iz oblasti zabavnih, sportskih i kulturnih događaja; organizovanje i vođenje komercijalnih, trgovinskih i poslovnih konferencija; rezervacija sjedišta za zabavne programe; informacije iz obrazovanja; informacije iz oblasti zabave; informacije (o rekreacijama -); iznajmljivanje audio opreme; usluge obuke putem simulatora; usluge savjetovanja i konsultovanja u vezi sa svim naprijed pomenutim.

Klasa 42: Arhitektura; usluge projektovanja, gradnje i arhitektonske usluge; konsultantske usluge u vezi sa arhitekturom, projektovanjem i gradnjom; usluge arhitektonskog planiranja i konsultovanja; arhitektonske usluge za interijer; arhitektonske usluge za projektovanje zgrada, industrijskih objekata i komercijalnih zgrada; konsultovanje u vezi sa električnim i elektronskim aparatima i opremom i audivizuelnim robama; usluge projektovanja; usluge tehničkog projektovanja; tehničko istraživanje; osmišljavanje proizvoda; grafički dizajn; dizajniranje ambalaže; dizajniranje nakita; dizajniranje hardvera; dizajniranje namještaja; konsultacije o projektu; projektovanje kuća; građevinsko projektovanje; dizajn automobila; modni dizajn; projektovanje i izrada računarskog hardvera, sofvera, spoljašnjih jedinica i kompjuterskih i video igrice; usluge konsultovanja o računarskom hardveru i softveru; računarsko programiranje; projektovanje računarskih baza podataka; smještaj elektronskih podataka; usluge računarstva u klauđu; iznajmljivanje računarskog hardvera, softvera i spoljašnjih jedinica; obezbjeđivanje onlajn softvera koji se ne može preuzimati; konsultantske usluge za razvijanje računarskih sistema, baza podataka i aplikacija; konsultacije u vezi sa bezbjednosti računara i podataka; usluge kodiranja podataka; obezbjeđivanje informacija putem interneta o računarskom hardveru ili softveru; održavanje, popravka i ažuriranje računarskog hardvera, softvera, spoljašnjih jedinica i aplikacija; usluge tehničke podrške, dijagnostifikovanje i otklanjanje problema kod računarskog hardvera i softvera i usluge tehničke podrške korisnicima računara; usluge kreiranja, dizajniranja i održavanja internetskih stranica; usluge hostovanje internetskih stranica; obezbjeđivanje pretraživača za potrebe dobijanja podataka putem interneta i drugih elektronskih komunikacionih mreža; kreiranje indeksa onlajn informacija, stranica i drugih resursa dostupnih na internetu i drugim elektronskim komunikacionim mrežama; usluge kartografije i izrade mapa; obezbjeđivanje internetskog portala koji omogućava korisnicima pregled i preuzimanje elektronskih knjiga, publikacija i drugih dokumenata; naučne

i tehnološke usluge; usluge industrijskog dizajna; usluge industrijske analize i istraživanja; usluge pružanja informacija, savjeta i konsultacija u vezi sa svim naprijed pomenutim; kontrola kvaliteta; anketiranje; hemijsko istraživanje; kliničko ispitivanje; meteorološke informacije; testiranje materijala; unutrašnji dizajna; dizajniranje haljina; utvrđivanje autentičnosti umjetničkih djela; grafičko umjetničko dizajniranje; slanje podataka (rasijavanje oblaka) pomoću tehnologije oblaka; analiziranje rukopisa [grafologija]; procjena nematerijalne imovine.

(210) **Ž-2019-347**

(220) 11.09.2019.

(731) Papoutsanis S.A., 71st klm Ethnikis Odou Athinon Lamias, Vathi Avlidos, (in English 71st klm National Road Athens-Lamia, 34100 Halkida), 34100, Halkida, GR

PAPOUTSANIS



(540) **aromatics**

(550) I

(740) AOD "Ćupić", Bulevar Džordža Vašingtona 79, 81000, Podgorica

(511) Klasa 3: Šamponi i balzami za kosu; maske za kosu; pjene za kupanje; ulja za kozmetičke svrhe; ulja za kosu i tijelo; sapuni za ličnu upotrebu; sapuni za lice; sapuni za tijelo; piling sapuni; glicerinski sapuni; tečni sapuni; sredstva za čišćenje za intimnu ličnu higijenu, nemedicinski; kozmetičke kreme i kozmetičke emulzije za lice i tijelo; losioni za lice i tijelo; mirisni sprej za ličnu upotrebu; mirisi; preparati za zaštitu od sunca i preparati za sunčanje (ne za medicinske svrhe); gelovi za njegu stopala, nemedicinski; preparati za uklanjanje šminke; preparati prije brijanja i posle brijanja.

(210) **Ž-2019-348**

(220) 11.09.2019.

(731) Papoutsanis S.A., 71st klm Ethnikis Odou Athinon Lamias, Vathi Avlidos, (in English 71st klm National Road Athens-Lamia, 34100 Halkida), 34100, Halkida, GR

PAPOUTSANIS



(540)

(550) I

(740) AOD "Ćupić", Bulevar Džordža Vašingtona 79, 81000, Podgorica

(511) Klasa 3: Šamponi i balzami za kosu; maske za kosu; pjene za kupanje; ulja za kozmetičke svrhe; ulja za kosu i tijelo; sapuni za ličnu upotrebu; sapuni za lice; sapuni za tijelo; piling sapuni; glicerinski sapuni; tečni sapuni; sredstva za čišćenje za intimnu ličnu higijenu, nemedicinski; kozmetičke kreme i kozmetičke emulzije za lice i tijelo; losioni za lice i tijelo; mirisni sprej za ličnu upotrebu; mirisi; preparati za zaštitu od

sunca i preparati za sunčanje (ne za medicinske svrhe); gelovi za njegu stopala, nemedicinski; preprati za uklanjanje šminke; preparati prije brijanja i posle brijanja.

(210) **Ž-2019-349**

(220) 11.09.2019.

(731) Papoutsanis S.A., 71st klm Ethnikis Odou Athinon Lamias, Vathi Avlidos, (in English 71st klm National Road Athens-Lamia, 34100 Halkida), 34100, Halkida, GR

PAPOUTSANIS

Natura

(540)

(550) I

(740) AOD "Ćupić", Bulevar Džordža Vašingtona 79, 81000, Podgorica

(511) Klasa 3: Šamponi i balzami za kosu; maske za kosu; pjene za kupanje; ulja za kozmetičke svrhe; ulja za kosu i tijelo; sapuni za ličnu upotrebu; sapuni za lice; sapuni za tijelo; piling sapuni; glicerinski sapuni; tečni sapuni; sredstva za čišćenje za intimnu ličnu higijenu, nemedicinski; kozmetičke kreme i kozmetičke emulzije za lice i tijelo; losioni za lice i tijelo; mirisni sprej za ličnu upotrebu; mirisi; preparati za zaštitu od sunca i preparati za sunčanje (ne za medicinske svrhe); gelovi za njegu stopala, nemedicinski; preprati za uklanjanje šminke; preparati prije brijanja i posle brijanja.

(210) **Ž-2019-350**

(220) 11.09.2019.

(731) KANEKA CORPORATION, a corporation organized and existing under the laws of Japan, Manufacturers and Merchants of, 2-3-18, Nakanoshima, Kita-ku, Osaka, JP

ED COIL

(540)

(550) I

(740) AOD MSA IP - Milojević Sekulić Advokati, Karađorđeva 65, 11000, Beograd

(511) Klasa 10: Uređaji za embolizaciju za lečenje vaskularnih anomalija.

(210) **Ž-2019-353**

(220) 13.09.2019.

(731) "12 mjeseci" DOO Bar, Topolica 1, Bar, ME

LA VELA

(540)

(550) I

(740) Dea Tršić, Bulevar Revolucije A-3, Bar

(511) Klasa 35: Oglašavanje i reklamiranje; vođenje komercijalnih poslova; komercijalna administracija; kancelarijski poslovi.

Klasa 43: Usluge obezbjeđivanja hrane i pića; privremeno primanje na stan.

Klasa 44: Medicinske usluge; veterinarske usluge; higijenska njega i njega ljepote za ljude ili za životinje; usluge poljoprivrede, povrtlarstva i šumarstva.

(210) **Ž-2019-354**

(220) 13.09.2019.

(731) "12 mjeseci" DOO Bar, Topolica 1, Bar, ME



(540)

(550) I

(740) Dea Tršić, Bulevar Revolucije A-3, Bar

(511) Klasa 35: Oglašavanje i reklamiranje; vođenje komercijalnih poslova; komercijalna administracija; kancelarijski poslovi.

Klasa 43: Usluge obezbjeđivanja hrane i pića; privremeno primanje na stan.

Klasa 44: Medicinske usluge; veterinarske usluge; higijenska njega i njega ljepote za ljude ili za životinje; usluge poljoprivrede, povrtlarstva i šumarstva.

(210) **Ž-2019-355**

(220) 13.09.2019.

(731) Zagrebacka Pivovara d.o.o., Ilica 224, 10000, Zagreb, HR



(540)

(550) I

(740) Branko Anđelić, Vasa Raičkovića 4a, 81000, Podgorica

(511) Klasa 32: Bezalkoholna pića; izotonična pića; izotonična brzalkoholna pića.

(210) **Ž-2019-356**

(220) 16.09.2019.

(731) The Coca-Cola Company, One Coca-Cola Plaza, 30313, Atlanta, Georgia, US



(540)

(550) I

(740) Miladin Popović, ul. Capital Plaza, ulica šeika Zajeda 13-IV/68, 81000, Podgorica

(511) Klasa 32: Pića, uključujući vode za piće, vode sa ukusom, mineralne i gazirane vode; ostala bezalkoholna pića, uključujući osvježavajuća bezalkoholna pića, energetska pića i pića za sportiste; voćni napici i sokovi uključujući kokosovu vodu; sirupi, koncentрати, praškovi i drugi preparati za pripremu pića, uključujući vode sa ukusom, mineralne i gazirane vode, osvježavajuća bezalkoholna pića, energetska pića, pića za sportiste, voćne napitke i sokove; napici i sokovi od povrća.

(210) **Ž-2019-357**

(220) 17.09.2019.

(731) G M B GENERAL TRADING L.L.C, P.O.Box:97131 - Deira, Dubai, AE



(540)

(550) I

(740) Božidar S. Radulović, Studentska bb, Lamela 3/18, 81000, Podgorica

(511) Klasa 34: Duvan; artikli za pušače; šibice.

(210) **Ž-2019-358**

(220) 18.09.2019.

(731) Bosnalijek, farmaceutska i hemijska industrija, dionicko društvo, Jukićeva 53, 71000, Sarajevo, BA

(540) LYSOBACT P SPRAY

(550) I

(740) Božidar S. Radulović, Studentska bb, Lamela 3/18, 81000, Podgorica

(511) Klasa 5: Farmaceutski proizvodi.

(210) **Ž-2019-359**

(220) 20.09.2019.

(731) L3Harris Technologies, Inc. (Delaware corporation), 1025 West NASA Boulevard, 32919, Melbourne, Florida, US

(540) L3HARRIS

(550) I

(740) Božidar S. Radulović, Studentska bb, Lamela 3/18, 81000, Podgorica

(511) Klasa 9: Računarski hardver; snimač glasova u pilotskoj kabini i podataka o letu; snimači i odašiljači podataka o parametrima leta; poluprovodnici; radio frekvencijski prekidači; detektori radara; testeri leta, naročito, računarski hardver i softver za izvođenje simulacije leta; žičani i bežični telefoni i telefonska

oprema, naročito telefonski predajnici, habovi za telekomunikacijske mreže, konektori, prijemnici i drugi uređaji, proizvodi, oprema i komponente za telefonsku komunikaciju, naročito hardverski interfejs telefonske mreže, hardver za kontrolu sigurnosti telefonije, hardver za kontrolu telefonske multimedije, telefonski prekidači, ruteri i pretplatnički hardverski interfejs, koji se koriste u računarskim i komunikacijskim mrežama i sistemima; računarski softver koji se koristi za kontrolu i upravljanje satelitima u oblasti satelitske komunikacije; računarski softver za rudarenje podataka u oblasti strateških i taktičkih obaveštajnih podataka; računarski softver za telemetriju koji se koristi za prikupljanje i odašiljanje podataka sa terenske daljinske opreme, naročito sa satelita, vazduhoplova, projektila, pokretnih kopnenih sistema, daljinski konfigurisanih fiksnih instalacija i obaveštajne Komunikacije, Komande i Kontrole; računarski softver koji se koristi za prikupljanje i odašiljanje podataka na polju medicinske tehnologije, naročito za rentgenske mašine, mašine sa magnetskim sensorima, mašine sa akustičnim sensorima, mašine za hemijsko praćenje; računarski softver koji se koristi za kontrolu i upravljanje opremom u realnom vremenu, naročito rentgenskim mašinama, mašinama sa magnetskim sensorima, mašinama sa akustičnim sensorima, mašinama za hemijsko praćenje, instrumentima za kontrolu leta, opremom za sigurnost leta, naročito snimačima glasova, telemetrijskim sistema na avionima, sistemima za održavanje na avionima, telemetrijskim skenerima, sistemima za detektovanje upada, sistemima za bodovanje borbe i slika, sistemima za upravljanje vazдушnim saobraćajem, monitorima, videofotoaparatom, radarskim sistema i sistemima za status i nadzor vozila; računarski softver za prepoznavanje i prezentaciju situacija sistema, u kontrolnom sistemu komunikacije i povezivanja podataka; pojačivači kanala i filteri frekvencija za upotrebu u telekomunikacijama; računarski hardver za procesiranje informacije o elektronskom ključu, naročito, procesiranje informacije u vezi sa elektronskim šifrovanjem i drugim sigurnosnim tehnologijama; radio frekvencijski limiteri; harmonijski generatori; satelitski transponderi; kontrolori transpondera; sistemi sigurne komunikacije koji se sastoje od digitalnih procesora, modulatora, antena, odašiljača, prijemnika i hardvera i softvera za šifrovanje, za uređaje za procesiranje sigurnosnih algoritama, koji se koriste za prikupljanje, prenos i analizu informacija iz vazduha, satelita, zemlje i mora; komunikacijski sistemi koji se sastoje od mikrotalasnih komunikacijskih veza visokog protoka podataka i računarskog hardvera; komunikacijski sistemi koji se sastoje od telefonskih komponenata i komponenata mikrotalasnog radija visokog protoka podataka, digitalnih procesora, računarskog hardvera, softvera koji sadrži algoritme koji se koriste u procesiranju sigurnih komunikacija i softvera za sigurno emitovanje i/ili prijem komunikacija i informacija ili podataka; satelitska oprema koja obezbeđuje mogućnosti podsistema, naročito, elektronski moduli i štampana kola za digitalno snimanje elektronskih podataka u čvrstom stanju, procesiranje video signala, procesiranje i translacija komunikacijskih signala; mikrotalasni uređaji, oprema, proizvodi i komponente, naročito, frekvencijski transmittori, frekvencijski konverteri, frekvencijski sintisajzeri, frekvencijski modulatori, frekvencijski filteri, frekvencijski pojačivači snage, pasivne komponente, mehanički prekidači, bežični frekvencijski sistem za nadzor i prateći sklopovi štampanih kola za implementaciju elektronskih komponenti koje obezbeđuju određivanje frekvencije, karakterizaciju frekvencije, status frekvencije i kontrolu frekvencije; oprema za radio navigaciju koja se sastoji od mikrotalasne opreme za odašiljanje i primanje snimaka, naročito, mikroprocesora, elektronskih displeja, uređaja za digitalno skladištenje, radio odašiljača i prijemnika, koja obezbeđuje sledeće mogućnosti: navigaciju, komandovanje i kontrolu vozila, indikacije i upozorenja vozila, snimanje podataka i telemetrije; oprema i uređaji za nadgledanje, naročito, ISR (obaveštavanje, nadzor i izviđanje) podsistemi koji koriste računarski hardver i softver za obezbeđivanje simpliranja elektromagnetnog spektra sa unapred definisanom frekvencijom da bi se izvukla informacija koja se može analizirati, za potrebe vojnog i civilnog vazduhoplovstva; elektronski senzori koji u realnom vremenu obezbeđuju mogućnost prikupljanja elektronskih podataka i informacija, naročito, hvatanje eksternog elektromagnetskog spektra i pretvaranje primljene energije u digitalni prikaz energije, procesiranje elektronskih podataka i informacija, naročito, filtriranje digitalnog prikaza energije i

pretvaranje u vizualni ili audio prikaz informacije, analiza elektronskih podataka i informacija, naročito, poređenje georeferentne informacije, detektovanje bilo kakve promene i prikazivanje promene u cilju vizualne potvrde, pohranjivanje elektronskih podataka i informacija, naročito, prenos podataka i informacija do digitalnog skladišta i širenje elektronskih podataka i informacija, naročito, kreiranje informacija na osnovu elektronskih paketa koji se mogu poslati na bilo kojem odabranom prenosnom mediju do druge, udaljene lokacije; elektronski računarski hardver i softver, koji omogućava prikupljanje, monitoring, analizu, skladištenje i prezentaciju medicinskih slika; računarski mrežni uređaji i oprema, naročito hardver koji omogućava povezivanje analognih ili digitalnih signala sa postojećom PSTN (javna telefonska mreža) ili globalnom informacijskom mrežom i kreiranje mogućnosti da se isti ovi signali prenese u sistem mobilne komunikacije; telefonski računarski hardver koji omogućava kreiranje bežične poslednje milje, naročito, bežične radio veze između centralnog izvora i destinacije, gde telefonija i sistem podataka imaju mogućnost fiksnog položaja ili mobilnog rada; komunikacijski terminali koji se sastoje od računarskog hardvera koji obezbeđuje kreiranje i povezivanje multimedijalnih komunikacijskih signala, uključujući analogne signale, glas, podatke i video, i omogućava da se signali povežu sa drugim komunikacijskim terminalima ili drugim mrežnim čvorovima; radio i televizijski transmisioni sistemi koji sadrže predajnike, monitore, miksera signala, kodere i dekodere audio i video signala i opremu za editovanje, naročito, procesore signala; predajnici i prijemnici za satelitsku komunikaciju; računarski vođeni mrežni sistemi koji se sastoje od računarskog hardvera i softvera za prenos podataka između računara povezanih u mrežu i za upravljanje računarima i prenosom podataka u pomenutoj mreži; računarski informacioni sistemi koji sadrže računare i softver za obradu podataka, obradu teksta i prikaz podataka; avionski sistemi koji sadrže digitalne mape, optičke i žičane magistrale podataka (data bus), memorijske uređaje, instrumente za prikazivanje, pohranjivanje, procesiranje i vađenje podataka o vremenu, taktici, strategiji i sigurnosti, kontrolne uređaje za pilotske kabine i ekrani sa podacima; fazirana antenska rešetka; oprema za globalno pozicioniranje, koja se sastoji od procesora podataka i ekrana; sistemi komunikacije u kontroli leta koji se sastoje od računarskog hardvera i softvera za prikazivanje, transport, prenos, kontrolu, prebacivanje, usmeravanje i primanje informacija o vazдушnom saobraćaju; računari i računarski softver za konvertovanje slika u podatke i za analizu, prikazivanje i štampanje podataka, u oblasti dvo- i tro-dimenzionalne ekstrakcije, manipulacije, prikazivanja i geografske registracije slike; sigurni računarski vođeni sistemi, koji se sastoje od računarskog hardvera i softvera i šifrovanih baza podataka, koji se svi koriste za obezbeđivanje i kontrolisanje sigurnosti i pristupa računarskoj mreži i informacijama koje se nalaze u njoj, naročito, praćenje vazдушnog saobraćaja i prenos šifriranih poruka do pilota, upravljanje bazama podataka, prenos datoteka i za povezivanje računara i baza podataka u mrežu i za upravljanje protoka; sistem upravljanja vazдушnim linijama, koji sadrži računare i softver za upravljanje bazama podataka i za razmenu informacija o avionima i radu aviona; procesori za analizu televizijskih signala, naročito, elektronski displej paneli za prikazivanje signala, terminali za evaluaciju signala, koji se primarno sastoje od hardvera, za analizu prilagođenih signala, sa integrisanim displejom i komponentama za softversku analizu, koje rade na industrijski standardnim računarima, i monitori za evaluaciju kvaliteta analognih i digitalnih signala, serveri za analizu medija za verifikaciju kvaliteta digitalnog medijskog sadržaja, interfejs moduli signala, ručni analizatori signala, optički analizatori signala, tester kola za monitoring emitovanih signala i alati za video monitoring, naročito, alati za video monitoring zasnovan na softveru, naročito, računarski softver za monitoring i logovanje glasnoće medijskog sadržaja; generatori vremenske reference, naročito, generatori signala vremenske reference za generisanje vremenskog i testnog signala sistema za emitovanje; hardver i računarski softver za televizijsku produkciju, post produkciju i emitovanje, naročito, demodulatori, digitalne oznake, naročito, dinamički elektronski displeji i mrežni računarski serveri i računarski softver za upravljanje i kontrolu dinamičkih elektronskih displeja, distribucionih pojačala, audio/video editora, naročito, računarske radne stanice opremljene računarskim softverom za editovanje audio i video programskih

materijala, računarski hardver i računarski softver koji se prodaje kao integralna jedinica za generisanje karaktera i grafike, računarski softver za generisanje vizuelnih efekata, računarski hardver i računarski softver koji se prodaje kao integralna jedinica za generisanje i ubacivanje uživo reklama, modula sa hitnim upozorenjima, naročito, kompjuterizovani elektronski moduli i pripadajući računarski softver za implementaciju emitovanja javnih poruka sa hitnim upozorenjima, optički transporteri signala, elektronski glavni kontrolni prekidači audio i video signala, kompresori audio i video signala i dekompresori audio i video signala, multiplekseri i demultiplekseri, multiekrani, aplikacioni softver za monitoring i kontrolu računarske mreže za emitovanje, elektronski mrežni kontrolni paneli, prijemnici i dekoderi za audio zapis, video zapis i podatke, elektronski usmerivački prekidači za audio i video signale, video serveri, video računarske mreže, NTP (protokol mrežnog vremena) vremenski moduli koji se primarno sastoje od računarskog hardvera i računarskog softvera za obavljanje NTP sinhronizacije vremena, satovi vremenskog signala, moduli za transport signala, audio/video sinhronizatori i upravljači vremena, koji se primarno sastoje od kola sa generisanim visoko preciznim satovima za sinhronizaciju tona sa slikom, legalizatori signala emitovanja, računarski softver za kreiranje i prikazivanje markera sa vremenskim kodom, više-niže frekvencijski konverteri signala, unakrsni konverteri formata signala, svi za upotrebu u industriji medija i zabave; emitterski softver za oglašavanje, prodaju, promet i naplatu, automatizaciju, upravljanje digitalnom imovinom, programiranje i upravljanje pravima, naročito, računarski softver za upravljanje, nadgledanje i automatizaciju kupovine, prodaje, planiranja, istraživanja, upravljanja inventarom, praćenja produkcije i procesa računovodstva za oglašavanje, i za opšti sadržaj za industriju medija i zabave; računarski softver za kontrolisanje i nadzor prekidačkih sistema za televizijske i radio signale; računarski softver za upravljanje, nadgledanje i automatizaciju kreiranja, pomeranja, lociranja, arhiviranja, vađenja i korišćenja digitalne medijske imovine; računarski softver, naročito softver za upravljanje poslovnim procesima i porukama, za upravljanje i kontrolu humanog i automatskog procesa rada i multisistemske komunikacije, za korišćenje u industriji medija i zabave; mrežni centri upravljanja koji se primarno sastoje od mobilnih i prenosnih radio aparata i takođe sadrže kontrolore električnih baznih stanica, kontrolore elektronske komunikacije i kontrolore električne mreže; mobilni i stacionarni dvosmerni radio aparati za komunikaciju; prenosivi dvosmerni radio aparati za komunikaciju; getveji radio mreža koji sadrže računare, računarske prekidače i pripadajući računarski softver za glasovnu komunikaciju i komunikaciju podacima; mreže na bazi internet protokola koje sadrže računarski hardver i računarski softver za interoperabilnu komunikaciju; oprema za telekomunikaciju, naročito, trunkingovani radio komunikacioni sistemi za javni servis i industrijsku primenu, koji se sastoje od prenosnih komunikacijskih radio aparata, kontrolora električne bazne stanice, kontrolora elektronske komunikacije i prekidača kola; kontrolna oprema za dvosmerne mobilne i dvosmerne fiksne radio aparate, naročito, oprema bazne stanice za fiksne i mobilne mreže i komunikacije, bazni tornjevi koji se primarno sastoje od elektronskog hardvera, računarskog softvera, antene i baznih stanica, kontrolne stanice koje se primarno sastoje od radio aparata, radijskog hardvera i pripadajućeg računarskog softvera, desktop kontrolne stanice koje se primarno sastoje od radio aparata, radijskog hardvera i pripadajućeg računarskog softvera, dispečerski i konzolni hardver, naročito, dispečerske konzole i softver za obavljanje hitne i ne hitne komunikacije i obavljanje komandovanja i kontrole javne bezbednosti osoblja i imovine, računarski hardver i softver za upravljanje na licu mesta, za upravljanje komunikacijskim radio aparatima i baznim stanicama, i računarski hardver i softver za mrežno nadgledanje, za nadgledanje komunikacijskih radio aparata i baznih stanica; radijski komunikacijski sistemi koji primarno sadrže mobilne komunikacijske radio aparate i takođe sadrže nepokretne komunikacijske radio aparate, prenosne komunikacijske radio aparate, kontrolore bazne stanice, kontrolore komunikacije, i kontrolore mreže; getveji komunikacijskih radio mreža, koji se primarno sastoji od računara, računarskih prekidača i pripadajućeg računarskog softvera za obezbeđivanje getveja između mreža; svemirski rasporedivi reflektori za satelitsku komunikaciju; računari i računarski softver za konvertovanje oblaka podataka o elevaciji iz udaljenog

uređaja sa senzorom u podatke, i za analizu, prikazivanje i štampanje podataka, u oblasti trodimenzionalne ekstrakcije, manipulacije, prikaza i geografskog registrovanja; računari i računarski softver za upravljanje, katalogizaciju i pozivanje geoprostornih slika, proizvoda izvedenih iz slika i drugih obaveštajnih proizvoda, kroz sinhronizaciju kataloga podataka preko disparatnih skladišnih lokacija; računari i računarski softver za upravljanje, procesiranje, eksploataciju i distribuciju pokretnih slika sa obaveštajnim podacima; računari i računarski softver za upravljanje, procesiranje, eksploataciju i distribuciju prezentacija o planiranju leta pilotima opšteg vazduhoplovstva i kontrolorima leta; mrežni komunikacijski radio aparati; brodski komunikacijski terminali koji se primarno sastoje od antene, postolja, pozicionera, modema, konvertera na više frekvence, konvertera na niže frekvence, pojačivača i korisničkog interfejsa; zemaljski komunikacijski terminali koji se primarno sastoje od antene, postolja, pozicionera, modema, konvertera na više frekvence, konvertera na niže frekvence, pojačivača i korisničkog interfejsa; računarski informacioni sistemi koji se uglavnom sastoje od računara i računarskog softvera za procesiranje podataka, procesiranje teksta i prikazivanje podataka u oblastima popisnog informacijskog sistema, zdravstvenog informacijskog sistema, pametnih sistema distribucije električne energije, sistema izveštavanja o i prognoze vremenskih prilika i sistema za ekološko predviđanje i izveštavanje; avionska oprema, naročito, kompresori i dekompresori video signala, izvori snage, montažni nosači posebno adaptirani za montiranje i povezivanje električnih aparata, procesori vazduhoplovnih signala za mrežnu interoperabilnost i ciljanje, sigurni mrežni prekidači, računarski softver u vidu mrežnih protokola za olakšavanje razmene elektronskih poruka i podataka, radio frekventne (RF) veze podataka za oružje, UHF/VHF bežične veze podataka, elektronika faziranih antenskih rešetki, naročito elektronika generatora signala koja se primarno sastoji od pojačivača snage, a takođe sadrži i pojačivač niskog šuma, pomerač faze, jedinicu vremenskog kašnjenja, prekidače odašiljanja i primanja, jedinicu za deljenje, jedinicu za kombinovanje, konverter na više frekvence, konverter na niže frekvence, kontrolore niza i nizove napajanja i kontrolnu opremu, naročito kontrolne jedinice antene, referentne jedinice određivanja pozicije i pravca, kontrolne jedinice odašiljača/prijemnika, kontrolori pozicije antene i prekidači za selekciju frekvencijskog opsega; komunikacijski sistemi kontrole leta, koji se sastoje od računarskog hardvera i računarskog softvera za prikazivanje, prenos, kontrolu, prebacivanje, usmeravanje i primanje podataka o vremenskim prilikama; dvosmerni radio aparati za komunikaciju putem glasa, podataka, slika i videa, za upotrebu od strane vojnih i drugih vladinih agencija; dvosmerni komunikacijski radio uređaji, naročito, komunikacijski radio aparati za glas i podatke, koji mogu da rade na više frekventnih opsega, da bi se omogućilo službenicima javne bezbednosti i prvim responderima, kao što su agencije za sprovođenje zakona, hitna pomoć, vatrogasci i vojno osoblje da međusobno interoperabilno komuniciraju, iako njihova postojeća komunikacijska infrastruktura možda nije međusobno kompatibilna; trunkigovani radio komunikacijski sistemi za javni servis i industrijsku primenu, naročito, bazne stanice mobilne telefonije i bazne stanice mobilnog radija za dvosmernu mobilnu telefoniju i fiksne komunikacijske radio aparate; zvučnici za mobilne dvosmerne komunikacijske radio aparate; zvučnici za stacionarne dvosmerne komunikacijske radio aparate; punjači baterija za dvosmerne komunikacijske radio aparate; komunikacijske mreže na bazi internet protokola koje primarno sadrže računarski hardver i računarski softver za implementaciju interoperabilnih komunikacija; kriptografski moduli, naročito, elektronski moduli sa ugrađenim firmverom u svrhu šifrovanja podataka; integrisana kola, naročito mašine za šifrovanje; radio frekvencijski bežični komunikacijski adapteri, naročito, mrežne interfejs karte; softver za upravljanje radio frekvencijskim bežičnim mrežnim interfejs kartama; komunikacijski softver za povezivanje radio frekvencijskih bežičnih mrežnih interfejs karti sa lokalnom komunikacijskom mrežom; radijski mrežni getvej koji se primarno sastoji od računara, računarskih prekidača i računarskog softvera, na polju glasovne komunikacije i komunikacije podacima; računarski softver koji se koristi na polju kontrole leta, naročito, za nadzor, održavanje, administriranje, rešavanje problema i konfigurisanje računarskog softvera za nadgledanje performansi sistema kontrole leta, definisanje mapiranja, aplodovanje ažuriranog softvera i

novih verzija, kontrolu pristupa, korisničke definicije, dodeljivanje sklopova, uređivanje hardvera, obnavljanje i izveštavanje o dijagnostici.

Klasa 35: Usluge savetovanja i konsultacija u vezi sa upravljanjem logistikom u oblasti telekomunikacija; usluge poslovne konsultacije i pomoći u radu telekomunikacijskih sistema i mreža za druge; usluge poslovne konsultacije i pomoći u oblasti upravljanja telekomunikacijskim mrežama, naročito rad sa i administracija telekomunikacijskih mreža i komunikacijskih veza za druge.

Klasa 37: Tehničko konsultovanje na polju gradnje fiksnih zemaljskih postrojenja; tehničko konsultovanje i asistencija na polju konstruisanja, popravke i održavanja podmornica i brodova; tehničko konsultovanje koje se odnosi na instalaciju, popravku i održavanje mobilnih i fiksnih postrojenja na zemlji, satelita i odnosnih informacionih sistema, naročito, sigurnosnih informacija, komunikacija, mikrotalasnih proizvoda i telemetrije i instrumentacije; tehničko konsultovanje i asistencija na polju raspoređivanja/upotrebe opreme i sistema računarskog hardvera; usluge nadgradnje informacione tehnologije (IT) i komunikacijske infrastrukture, naročito, ažuriranje računarskog hardvera za IT i komunikacijske sisteme; usluge održavanja telekomunikacijskih sistema, naročito, održavanje radio, televizijske i digitalne komunikacijske opreme za druge.

Klasa 38: Tehničko konsultovanje na polju satelitske komunikacije i komunikacije putem povezanih komunikacijskih informacijskih sistema, naročito, komunikacije putem satelitskog prenosa, mikrotalasnih proizvoda i telemetrije i instrumentacije; usluge konsultovanja i tehničke asistencije na polju sigurne komunikacije i telemetrije.

Klasa 42: Tehničko konsultovanje i asistencija na polju avijacije; informacijsko tehnološko konsultovanje u oblasti podmornica i brodova, mobilnih i fiksnih postrojenja na zemlji, satelita i odnosnih informacionih sistema, naročito u vezi sa sigurnošću podataka, komunikacijama, mikrotalasnim proizvodima i telemetrijom i instrumentacijom; projektovanje računarskih sistema za integraciju softvera, održavanje i korisničke usluge, sisteme podrške za integraciju softvera, održavanje i planiranje usluga podrške i provizioniranja, i provizioniranje kontrole usluge podrške za satelitske kontrolne mreže, odbrambene komunikacijske sisteme u realnom vremenu, i odbrambene sisteme za prikupljanje obaveštajnih podataka u realnom vremenu; projektovanje računarskih sistema za inženjersku podršku za lansiranje satelita, raspoređene komunikacijske sisteme i raspoređene sisteme za prikupljanje obaveštajnih podataka; konsultovanje i tehnička asistencija na polju prilagođavanja računarskog hardvera i softvera; konsultovanje i asistencija u vezi sa uslugama upravljanja računarskim programom, uslugama upravljanja računarom na licu mesta, i raspoređivanjem i upravljanjem bežičnim komunikacijskim mrežama drugih i uslugama upravljanja komunikacijskim vezama; usluge tehničke podrške, naročito, rešavanje problema u smislu dijagnostikovanja i testiranja problema računarskog hardvera i softvera; obezbeđivanje interaktivnog veb-sajta koji omogućava korisnicima ulaz, pristup, nadgledanje i generisanje projektovanih strateških i taktičkih signalnih izveštaja o obaveštajnim podacima; usluge migracije IT i komunikacijske infrastrukture; usluge raspoređivanja IT i komunikacijske infrastrukture; usluge tehničke podrške, naročito migracija centra za podatke, servera i aplikacija za baze podataka; usluge migracije podataka; upravljanje uslugama na bazi sigurne informacione tehnologije (IT) za druge, naročito, upravljanje IT softverskim aplikacijama, upravljanje uslugama za preduzeća, naročito, upravljanje softverskim aplikacijama, upravljanje proverom informacija, naročito, upravljanje restriktivnim mrežama, podacima i pristupom informacijama i upravljanje pregledom i eliminacijom neautorizovanih podataka i programa iz datoteka i mreža i menadžment sajber sigurnosti, naročito, održavanje računarskog softvera koje se odnose na sigurnost računara i sprečavanje računarskih rizika; usluge konsultovanja na polju računarskog hardvera i softvera; tehničko konsultovanje na polju telekomunikacijskih tehnologija; tehničko konsultovanje na polju informacione tehnologije (IT); ažuriranje i održavanje računarskog softvera, usluge integracije informacione tehnologije (IT); usluge tehničke podrške, naročito, nadgledanje mrežnih sistema; daljinsko tehnološko nadgledanje računarske

mreže i usluge održavanja softvera; računarske usluge, naročito daljinsko upravljanje sistema informacione tehnologije (IT) drugih; planiranje, projektovanje i upravljanje sistemima informacione tehnologije (IT); projektovanje računarskog hardvera i softvera; projektovanje računarske mreže za druge; usluge obezbeđivanja informacija za zaštitu poverljivosti, integriteta i dostupnosti informacionih sistema i važnih poslovnih podataka drugih, naročito, projektovanje, raspoređivanje i upravljanje sigurnim komunikacijskim sistemima i informacijskim mrežama, za zaštitu poverljivosti, integriteta i raspoloživosti informacijskih sistema i važnih poslovnih podataka drugih; usluge projektovanja telekomunikacijskih sistema, naročito, projektovanje radio, televizijske i digitalne komunikacijske opreme za druge, i projektovanje i integracija računarskih sistema i mreža za druge, naročito, projektovanje i integracija telefonskih sistema, komunikacijskih sistema i sistema za prikazivanje.

Klasa 45: Konsultovanje i tehnička asistencija na polju usluga informacione sigurnosti i obaveštajne sigurnosti za sigurnu i nesigurnu komunikaciju putem glasa, podataka i videa, korisničku autorizaciju, prepoznavanje i šifrovanje poruka.

(210) **Ž-2019-360**

(220) 20.09.2019.

(731) L3Harris Technologies, Inc. (Delaware corporation), 1025 West NASA Boulevard, 32919, Melbourne, Florida, US

(540)  **L3HARRIS**

(550) I

(740) Božidar S. Radulović, Studentska bb, Lamela 3/18, 81000, Podgorica

(511) Klasa 9: Računarski hardver; snimač glasova u pilotskoj kabini vazduhoplova i podataka o letu; snimači i odašiljači podataka o parametrima leta; poluprovodnici; radio frekvencijski prekidači; detektori radara; testeri leta, naročito, računarski hardver i softver za izvođenje simulacije leta; računarski softver za simulaciju leta; telefonski predajnici; habovi za telekomunikacijske mreže; konektori za telekomunikacijske mreže; prijemnici za telekomunikacijske mreže; hardverski interfejs telefonske mreže; hardver za kontrolu sigurnosti telefonije; hardver za kontrolu telefonske multimedije; telefonski prekidači, ruteri i pretplatnički hardverski interfejs, koji se koriste u računarskim i komunikacijskim mrežama i sistemima; računarski softver koji se koristi za upravljanje i kontrolu u oblasti satelitske komunikacije; računarski softver za rudarenje u oblasti strateških i taktičkih obaveštajnih podataka; računarski softver za telemetriju koji se koristi za prikupljanje i odašiljanje podataka, sa satelita, vazduhoplova, projektila, pokretnih kopnenih sistema, daljinski konfigurisanih fiksnih instalacija; računarski softver koji se koristi za prikupljanje i odašiljanje podataka za medicinske rentgenske mašine, mašine sa magnetskim sensorima, mašine sa akustičnim sensorima, mašine za hemijsko praćenje; računarski softver koji se koristi za kontrolu i upravljanje opremom u realnom vremenu; računarski softver za upravljanje i kontrolu rentgenskih mašina; računarski softver za upravljanje i kontrolu mašina sa magnetskim sensorima; računarski softver za upravljanje i kontrolu mašina za medicinski imidžing (vizuelno snimanje); računarski softver za upravljanje i kontrolu mašina sa akustičnim sensorima; računarski softver za upravljanje i kontrolu mašina za hemijsko praćenje; instrumenti za kontrolu leta; oprema za sigurnost leta, naročito snimači glasova, telemetrijski sistemi za upotrebu na vazduhoplovima; računarski softver koji se koristi za upravljanje i kontrolu vazduhoplovnih sistema za održavanje na vazduhoplovima; računarski softver za upravljanje i kontrolu telemetrijskih skenera; sistemi za detektovanje upada; računarski softver za upravljanje i kontrolu sistema za bodovanje borbe i slika, računarski softver za upravljanje i kontrolu sistema za upravljanje vazdušnim

saobraćajem; računarski softver za upravljanje i kontrolu monitora, foto aparata i video kamera; računarski softver za upravljanje i kontrolu radarskih sistema; računarski softver koji se koristi za sisteme statusa i nadzora vozila; računarski softver za prepoznavanje i prezentaciju situacija sistema, u kontrolnom sistemu komunikacije i povezivanja podataka; telekomunikacioni pojačivači kanala; filteri frekvencija za upotrebu u telekomunikacijama; računarski hardver za procesiranje informacije o elektronskom ključu, naročito, procesiranje informacije u vezi sa elektronskim šifrovanjem i drugim sigurnosnim tehnologijama; radio frekvencijski limiteri; harmonijski generatori; satelitski transponderi; kontrolori transpondera; sistemi sigurne komunikacije koji se sastoje od digitalnih procesora, modulatora, antena, odašiljača, prijemnika i hardvera i softvera za šifrovanje, za uređaje za procesiranje sigurnosnih algoritama, koji se koriste za prikupljanje, prenos i analizu informacija iz vazduha, satelita, zemlje i mora; komunikacijski sistemi koji se sastoje od mikrotalasnih komunikacijskih veza visokog protoka podataka i računarskog hardvera; komunikacijski sistemi koji se sastoje od telefonskih komponenata i komponenata mikrotalasnog radija visokog protoka podataka, digitalnih procesora, računarskog hardvera, softvera koji sadrži algoritme koji se koriste u procesiranju sigurnih komunikacija i softvera za sigurno emitovanje i/ili prijem komunikacija i informacija ili podataka; ugrađena satelitska oprema koja obezbeđuje mogućnosti podsistema, naročito, elektronski moduli i štampana kola za digitalno snimanje elektronskih podataka u čvrstom stanju, procesiranje video signala, procesiranje i translacija komunikacijskih signala; mikrotalasni uređaji, oprema, proizvodi i komponente, naročito, frekvencijski transmitori, frekvencijski konverteri, frekvencijski sintisajzeri, frekvencijski modulatori, frekvencijski filteri, frekvencijski pojačivači snage, pasivne komponente, mehanički prekidači, bežični frekvencijski monitori; oprema za radio navigaciju koja se sastoji od mikrotalasne opreme za odašiljanje i primanje snimaka, naročito, mikroprocesora, elektronskih displeja, uređaja za digitalno skladištenje, radio odašiljača i prijemnika, koja obezbeđuje sledeće mogućnosti: navigaciju, komandovanje i kontrolu vozila, indikacije i upozorenja vozila, snimanje podataka i telemetrije; oprema i uređaji za nadgledanje, naročito, ISR (obaveštavanje, nadzor i izviđanje) podsistemi koji koriste računarski hardver i softver za obezbeđivanje sempliranja elektromagnetnog spektruma sa unapred definisanom frekvencijom da bi se izvukla informacija koja se može analizirati, za potrebe vojnog i civilnog vazduhoplovstva; elektronski senzori koji u realnom vremenu obezbeđuju mogućnost prikupljanja elektronskih podataka i informacija; elektronski računarski hardver i softver, koji omogućava prikupljanje, monitoring, analizu, skladištenje i prezentaciju medicinskih slika; hardver koji omogućava povezivanje analognih ili digitalnih signala sa postojećom PSTN (javna telefonska mreža) ili globalnom informacijskom mrežom i kreiranje mogućnosti da se isti ovi signali ubace u sistem mobilne komunikacije; telefonski računarski hardver koji omogućava kreiranje bežične poslednje milje, naročito, bežične radio veze između centralnog izvora i destinacije, gde telefonija i sistem podataka imaju mogućnost fiksnog položaja ili mobilnog rada; komunikacijski terminali koji se sastoje od računarskog hardvera koji obezbeđuje kreiranje i povezivanje multimedijalnih komunikacijskih signala, uključujući analogne signale, glas, podatke i video, i omogućava da se signali povežu sa drugim komunikacijskim terminalima ili drugim mrežnim čvorovima; radio i televizijski transmisioni sistemi koji sadrže predajnike, monitore, miksera signala, kodere i dekodere audio i video signala i opremu za editovanje, naročito, procesore signala; predajnici i prijemnici za satelitsku komunikaciju; računarski vođeni mrežni sistemi koji se sastoje od računarskog hardvera i softvera za prenos podataka između računara povezanih u mrežu i za upravljanje računarima i prenosom podataka u pomenutoj mreži; računarski informacioni sistemi koji sadrže računare i softver za obradu podataka, obradu teksta i prikaz podataka; avionski sistemi koji sadrže digitalne mape, optičke i žičane magistrale podataka (data bus), memorijske uređaje, instrumente za prikazivanje, pohranjivanje, procesiranje i vađenje podataka o vremenu, taktici, strategiji i sigurnosti, kontrolne uređaje za pilotske kabine i ekrane sa podacima; fazirana antenska rešetka; oprema za globalno pozicioniranje, koja se sastoji od procesora podataka i ekrana; računarski softver i računarski hardver za upotrebu u sistemima komunikacije u kontroli

leta za prikazivanje transporta, prenos glasa, podataka i slika, kontrolu, prebacivanje, usmeravanje i primanje informacija o vazdušnom saobraćaju; računari i računarski softver za konvertovanje slika u podatke i za analizu, prikazivanje i štampanje podataka, u oblasti dvo- i tro-dimenzionalne ekstrakcije, manipulacije, prikazivanja i geografske registracije slike; sigurni računarski vođeni sistemi, koji se sastoje od računarskog hardvera i softvera i šifrovanih baza podataka, koji se svi koriste za obezbeđivanje i kontrolisanje sigurnosti i pristupa računarskoj mreži i informacijama koje se nalaze u njoj, naročito, praćenje vazdušnog saobraćaja i prenos šifrovanih poruka do pilota, upravljanje bazama podataka, prenos datoteka i za povezivanje računara i baza podataka u mrežu i za upravljanje protoka avio saobraćaja; sistem upravljanja vazdušnim linijama, koji sadrži računare i softver za upravljanje bazama podataka i za razmenu informacija o avionima i radu aviona; procesori za analizu televizijskih signala, naročito, elektronski displej paneli za prikazivanje signala, terminali za evaluaciju signala, koji se primarno sastoje od hardvera, za analizu prilagođenih signala, sa integrisanim displejom i komponentama za softversku analizu, koje rade na industrijski standardnim računarima, i monitor za evaluaciju kvaliteta analognih i digitalnih signala, serveri za analizu medija za verifikaciju kvaliteta digitalnog medijskog sadržaja, interfejs moduli signala, ručni analizatori signala, optički analizatori signala, tester kola za monitoring emitovanih signala i alati za video monitoring, naročito, alati za video monitoring zasnovan na softveru, naročito, računarski softver za monitoring i logovanje glasnoće medijskog sadržaja; generatori vremenske reference, naročito, generatori signala vremenske reference za generisanje vremenskog i testnog signala sistema za emitovanje; hardver i računarski softver za televizijsku produkciju, post produkciju i emitovanje, naročito, demodulatori, digitalne oznake, naročito, dinamički elektronski displeji i mrežni računarski serveri i računarski softver za upravljanje i kontrolu dinamičkih elektronskih displeja, distribucionih pojačala, audio/video editora, naročito, računarske radne stanice opremljene računarskim softverom za editovanje audio i video programskih materijala, računarski hardver i računarski softver koji se prodaje kao integralna jedinica za generisanje karaktera i grafike, računarski softver za generisanje vizuelnih efekata, računarski hardver i računarski softver koji se prodaje kao integralna jedinica za generisanje i ubacivanje uživo reklama, modula sa hitnim upozorenjima, naročito, kompjuterizovani elektronski moduli i pripadajući računarski softver za implementaciju emitovanja javnih poruka sa hitnim upozorenjima, optički transporter signala, elektronski glavni kontrolni prekidači audio i video signala, kompresori audio i video signala i dekompresori audio i video signala, multiplekseri i demultiplekseri, multiokrani, aplikacioni softver za monitoring i kontrolu računarske mreže za emitovanje, elektronski mrežni kontrolni paneli, prijemnici i dekoderi za audio zapis, video zapis i podatke, elektronski usmerivački prekidači za audio i video signale, video serveri, NTP (protokol mrežnog vremena) vremenski moduli koji se primarno sastoje od računarskog hardvera i računarskog softvera za obavljanje NTP sinhronizacije vremena, satovi vremenskog signala, moduli za transport signala, audio/video sinhronizatori i upravljači vremena, koji se primarno sastoje od kola sa generisanim visoko preciznim satovima za sinhronizaciju tona sa slikom, računarski softver za kreiranje i prikazivanje markera sa vremenskim kodom, više-niže frekvencijski konverteri signala, unakrsni konverteri formata signala, svi za upotrebu u industriji medija i zabave; emitterski softver za oglašavanje, prodaju, promet i naplatu, automatizaciju, upravljanje digitalnom imovinom, programiranje i upravljanje pravima, naročito, računarski softver za upravljanje, nadgledanje i automatizaciju kupovine, prodaje, planiranja, istraživanja, upravljanja inventarom, praćenja produkcije i procesa računovodstva za oglašavanje, i za opšti sadržaj za industriju medija i zabave; računarski softver za kontrolisanje i nadzor prekidačkog sistema za televizijske i radio signale; računarski softver za upravljanje, nadgledanje i automatizaciju kreiranja, pomeranja, lociranja, arhiviranja, vađenja i korišćenja digitalne medijske imovine; softver za upravljanje poslovnim procesima i za porukama, za upravljanje i kontrolu humanog i automatskog procesa rada i multisistemske komunikacije, za korišćenje u industriji medija i zabave; mrežni centri upravljanja koji se primarno sastoje od mobilnih i prenosnih radio aparata i takođe sadrže kontrolore električnih baznih

stanica, kontrolore elektronske komunikacije i kontrolore električne mreže; mobilni i stacionarni dvosmerni radio aparati za komunikaciju; prenosivi dvosmerni radio aparati za komunikaciju; getveji radio mreža koji sadrže računare, računarske prekidače i pripadajući računarski softver za glasovnu komunikaciju i komunikaciju podacima; mreže na bazi internet protokola koje sadrže računarski hardver i računarski softver za interoperabilnu komunikaciju; oprema za telekomunikaciju, naročito, trunkingovani radio komunikacioni sistemi za javni servis i industrijsku primenu, koji se sastoje od prenosnih komunikacijskih radio aparata, kontrolora električne bazne stanice, kontrolora elektronske komunikacije i prekidača kola; kontrolna oprema za dvosmerne mobilne i dvosmerne fiksne radio aparate, naročito, oprema bazne stanice za fiksne i mobilne mreže i komunikacije, bazni tornjevi koji se primarno sastoje od elektronskog hardvera, računarskog softvera, antene i baznih stanica, kontrolne stanice koje se primarno sastoje od radijskog hardvera i pripadajućeg računarskog softvera, desktop kontrolne stanice koje se primarno sastoje od radio aparata, radijskog hardvera i pripadajućeg računarskog softvera, dispečerski i konzolni hardver, naročito, dispečerske konzole i softver za obavljanje hitne i ne-hitne komunikacije i obavljanje komandovanja i kontrole javne bezbednosti osoblja i imovine, računarski hardver i softver za upravljanje na licu mesta, za upravljanje komunikacijskim radio aparatima i baznim stanicama, i računarski hardver i softver za mrežno nadgledanje, za nadgledanje komunikacijskih radio aparata i baznih stanica; radijski komunikacijski sistemi koji primarno sadrže mobilne komunikacijske radio aparate i takođe sadrže nepokretne komunikacijske radio aparate, prenosne komunikacijske radio aparate, kontrolore bazne stanice, kontrolore komunikacije, i kontrolore mreže; getveji komunikacijskih radio mreža, koji se primarno sastoji od računara, računarskih prekidača i pripadajućeg računarskog softvera za obezbeđivanje getveja između mreža; prostorno rasporedivi reflektori za satelitsku komunikaciju; računari i računarski softver za obradu podataka o geografskoj elevaciji koja se odnosi na elevaciju lokacija na zemlji, kako bi se generisao, prikazao i štampao trodimenzionalni geografski registrovani prikaz takvih lokacija; računari i računarski softver za upravljanje, katalogizaciju i pozivanje geoprostornih slika, proizvoda izvedenih iz slika i drugih obaveštajnih proizvoda, kroz sinhronizaciju kataloga podataka preko disparatnih skladišnih lokacija; računari i računarski softver za upravljanje, procesiranje, eksploataciju i distribuciju pokretnih slika sa obaveštajnim podacima; računari i računarski softver za upravljanje, procesiranje, eksploataciju i distribuciju prezentacija o planiranju leta pilotima opšteg vazduhoplovstva i kontrolorima leta; mrežni komunikacijski radio aparati; brodski komunikacijski terminali koji se primarno sastoje od antene, postolja, pozicionera, modema, konvertera na više frekvence, konvertera na niže frekvence, pojačivača i korisničkog interfejsa; zemaljski komunikacijski terminali koji se primarno sastoje od antene, postolja, pozicionera, modema, konvertera na više frekvence, konvertera na niže frekvence, pojačivača i korisničkog interfejsa; računarski informacioni sistemi koji se uglavnom sastoje od računara i računarskog softvera za procesiranje podataka, procesiranje teksta i prikazivanje podataka u oblastima popisnog informacijskog sistema, zdravstvenog informacijskog sistema, pametnih sistema distribucije električne energije, sistema izveštavanja o i prognoze vremenskih prilika i sistema za ekološko izveštavanje i predviđanje; avionska oprema, naročito, kompresori i dekompresori video signala, izvori snage, montažni nosači posebno adaptirani za montiranje i povezivanje električnih aparata, procesori vazduhoplovnih signala za mrežnu interoperabilnost oružja i ciljanje oružjem, sigurni mrežni prekidači, računarski softver u vidu mrežnih protokola za olakšavanje razmene elektronskih poruka i podataka, radio frekventne (RF) veze podataka za oružje, UHF/VHF bežične veze podataka, elektronika generatora signala koja se primarno sastoji od pojačivača snage, a takođe sadrži i pojačivač niskog šuma, pomerač faze, jedinicu vremenskog kašnjenja, prekidače odašiljanja i primanja, jedinicu za deljenje, jedinicu za kombinovanje, konverter na više frekvence, konverter na niže frekvence, kontrolore niza i nizove napajanja i kontrolnu opremu, kontrolne jedinice antene, referentne jedinice za određivanje pozicije i pravca, kontrolne jedinice odašiljača/prijemnika, kontrolore pozicije antene i selektivni prekidači frekvencijskog opsega; komunikacijski sistemi kontrole leta, koji se sastoje od računarskog hardvera i

računarskog softvera za prikazivanje, prenos, kontrolu, prebacivanje, usmeravanje i primanje podataka o vremenskim prilikama; dvosmerni radio aparati za komunikaciju putem glasa, podataka, slika i videa, za upotrebu od strane vojnih i drugih vladinih agencija; dvosmerni komunikacijski radio uređaji, naročito, komunikacijski radio aparati za glas i podatke, koji mogu da rade na više frekventnih opsega, da bi se omogućilo službenicima javne bezbednosti i prvim responentima, kao što su agencije za sprovođenje zakona, hitna pomoć, vatrogasci i vojno osoblje, da međusobno ineroperabilno komuniciraju, iako njihova postojeća komunikacijska infrastruktura možda nije međusobno kompatibilna; trunkigovani radio komunikacijski sistemi za javni servis i industrijsku primenu, naročito, bazne stanice mobilne telefonije i bazne stanice mobilnog radija za dvosmernu mobilnu telefoniju i fiksne komunikacijske radio aparate; zvučnici za mobilne dvosmerne komunikacijske radio aparate; zvučnici za stacionarne dvosmerne komunikacijske radio aparate; punjači baterija za dvosmerne komunikacijske radio aparate; komunikacijske mreže na bazi internet protokola koje primarno sadrže računarski hardver i računarski softver za implementaciju interoperabilnih komunikacija; kriptografski moduli, naročito, elektronski moduli sa ugrađenim firmverom u svrhu šifrovanja podataka; mašine za šifrovanje; radio frekvencijski bežični komunikacijski adapteri, naročito, mrežne interfejs karte; softver za upravljanje radio frekventnim bežičnim mrežnim interfejs kartama; komunikacijski softver za povezivanje radio frekvencijskih bežičnih mrežnih interfejs karti sa lokalnom komunikacijskom mrežom; radijski mrežni getvej koji se primarno sastoji od računara, računarskih prekidača i računarskog softvera, na polju glasovne komunikacije i komunikacije podacima; računarski softver koji se koristi na polju kontrole leta, naročito, za nadzor, održavanje, administriranje, rešavanje problema i konfigurisanje računarskog softvera za nadgledanje performansi sistema kontrole leta, definisanje mapiranja, aplodovanje ažuriranog softvera i novih verzija, kontrolu pristupa, korisničke definicije, obnavljanje i izveštavanje o dijagnostici.

Klasa 35: Usluge savetovanja i konsultacija u vezi sa poslovnim upravljanjem u oblasti telekomunikacione logistike; usluge poslovne konsultacije i pomoći u radu telekomunikacijskih sistema i mreža za druge; usluge poslovne konsultacije i pomoći u oblasti telekomunikacija, naročito rad sa i administracija telekomunikacijskih mreža i komunikacijskih veza za druge.

Klasa 37: Tehničko konsultovanje na polju gradnje fiksnih zemaljskih postrojenja; tehničko konsultovanje i asistencija na polju konstruisanja, popravke i održavanja podmornica i brodova; tehničko konsultovanje koje se odnosi na instalaciju, popravku i održavanje mobilnih i fiksnih postrojenja na zemlji, satelita i odnosnih računarskih informacionih sistema; tehničko konsultovanje i asistencija na polju raspoređivanja opreme i sistema računarskog hardvera; usluge nadgradnje informacione tehnologije (IT) i komunikacijske infrastrukture, naročito, ažuriranje računarskog hardvera za IT i komunikacijske sisteme; usluge održavanja telekomunikacijskih sistema, naročito, održavanje radio, televizijske i digitalne komunikacijske opreme za druge.

Klasa 38: Tehničko konsultovanje na polju satelitske komunikacije i komunikacije putem povezanih komunikacijskih informacijskih sistema, naročito, komunikacija putem satelitskog prenosa, mikrotalasnih proizvoda i telemetrije i instrumentacije; usluge konsultovanja i tehničke asistencije na polju sigurne komunikacije i telemetrije.

Klasa 42: Tehničko konsultovanje i asistencija na polju avijacije; informacijsko tehnološko konsultovanje u oblasti podmornica i brodova, mobilnih i fiksnih postrojenja na zemlji, satelita i odnosnih informacionih sistema, naročito u vezi sa sigurnošću podataka, komunikacijama, mikrotalasnim proizvodima i telemetrijom i instrumentacijom; projektovanje računarskih sistema za integraciju softvera, održavanje i korisničke usluge, sisteme podrške za integraciju softvera, održavanje i planiranje usluga podrške i provizioniranja, i provizioniranje kontrole usluge podrške za satelitske kontrolne mreže, odbrambene komunikacijske sisteme u realnom vremenu, i odbrambene sisteme za prikupljanje obaveštajnih podataka u realnom vremenu; projektovanje računarskih sistema za inženjersku podršku za lansiranje satelita,

raspoređene komunikacijske sisteme i raspoređene sisteme za prikupljanje obaveštajnih podataka; konsultovanje i tehnička asistencija na polju prilagođavanja računarskog hardvera i softvera; konsultovanje i asistencija u vezi sa uslugama upravljanja računarskim programom, uslugama upravljanja računarom na licu mesta, i raspoređivanjem i upravljanjem bežičnim komunikacijskim mrežama drugih i uslugama upravljanja komunikacijskim vezama; usluge tehničke podrške, naročito, rešavanje problema u smislu dijagnostikovanja i testiranja problema računarskog hardvera i softvera; obezbeđivanje interaktivnog veb-sajta koji omogućava korisnicima ulaz, pristup, nadgledanje i generisanje projektovanih strateških i taktičkih signalnih izveštaja o obaveštajnim podacima; usluge migracije IT i komunikacijske infrastrukture; usluge tehničkog projektovanja i raspoređivanja telekomunikacionih mreža i računarskih mreža za druge; usluge tehničke podrške za migraciju centra za podatke, servera i aplikacija za baze podataka; usluge migracije podataka; upravljanje IT softverskim aplikacijama, upravljanje uslugama za preduzeća, naročito, upravljanje softverskim aplikacijama, upravljanje restriktivnim mrežama i podacima, održavanje računarskog softvera koje se odnosi na sigurnost računara i sprečavanjem računarskog rizika; usluge konsultovanja na polju računarskog hardvera i softvera; tehničko konsultovanje na polju telekomunikacijskih tehnologija; tehničko konsultovanje na polju informacione tehnologije (IT); ažuriranje i održavanje računarskog softvera, usluge integracije informacione tehnologije (IT); usluge tehničke podrške, naročito, nadgledanje računarskih mreža putem daljinskog pristupa; daljinsko tehnološko nadgledanje računarske mreže i usluge održavanja softvera; daljinsko upravljanje sistema informacione tehnologije (IT) drugih; planiranje, projektovanje i upravljanje sistemima informacione tehnologije (IT); projektovanje računarskog hardvera i softvera; projektovanje računarske mreže za druge; usluge obezbeđivanja informacija za projektovanje, raspoređivanje i upravljanje sigurnim komunikacijskim sistemima i informacijskim mrežama, za zaštitu poverljivosti, integriteta i raspoloživosti informacijskih sistema i važnih poslovnih podataka drugih; projektovanje radio, televizijske i digitalne komunikacijske opreme za druge; projektovanje i integracija telefonskih sistema, komunikacijskih sistema i sistema za prikazivanje informacija.

Klasa 45: Konsultovanje i tehnička asistencija na polju usluga informacione sigurnosti i obaveštajne sigurnosti za sigurnu i nesigurnu komunikaciju putem glasa, podataka i videa, korisničku autorizaciju, prepoznavanje i šifrovanje poruka.

(210) **Ž-2019-361**

(220) 20.09.2019.

(731) Colgate-Palmolive Company (a Delaware Corporation), 300 Park Avenue, 10022, New York, New York, US

(540) **COLGATE SMILE FOR GOOD**

(550) I

(740) Jasna Jusić, Dalmatinska 2, 81000, Podgorica

(511) Klasa 3: Nemedicinska pasta za zube i nemedicinska tečnost za ispiranje usta.

Klasa 21: Četkice za zube.

(210) **Ž-2019-362**

(220) 24.09.2019.

(731) Colgate-Palmolive Company (a Delaware Corporation), 300 Park Avenue, 10022, New York, New York, US

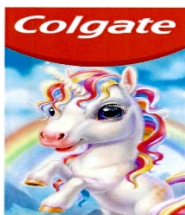

(540)

(550) I

(740) Jasna Jusić, Dalmatinska 2, 81000, Podgorica

(511) Klasa 3: Nemedicinska pasta za zube i nemedicinska tečnost za ispiranje usta.

(210) **Ž-2019-363**

(220) 25.09.2019.

(731) AbbVie Biotechnology Ltd, Clarendon House, 2 Church Street, HM 11, Hamilton, BM

(540) **RINVOQ**

(550) I

(740) Miladin Popović, ul. Capital Plaza, ulica šeiika Zajeda 13-IV/68, 81000, Podgorica

(511) Klasa 5: Farmaceutski preparati.

(210) **Ž-2019-364**

(220) 25.09.2019.

(731) Colgate-Palmolive Company (a Delaware corporation), 300 Park Avenue, 10022, New York, New York, US



(540)

(550) I

(740) Jasna Jusić, Dalmatinska 2, 81000, Podgorica

(511) Klasa 3: Nemedicinska pasta za zube, nemedicinska tečnost za ispiranje usta.

(210) **Ž-2019-365**

(220) 25.09.2019.

(731) Colgate-Palmolive Company (a Delaware corporation), 300 Park Avenue, 10022, New York, New York, US



(540)

(550) I

(740) Jasna Jusić, Dalmatinska 2, 81000, Podgorica

(511) Klasa 3: Nemedicinska pasta za zube, nemedicinska tečnost za ispiranje usta.

(210) **Ž-2019-366**

(220) 25.09.2019.

(731) Colgate-Palmolive Company (a Delaware corporation), 300 Park Avenue, 10022, New York, New York, US



(540)

(550) I

(740) Jasna Jusić, Dalmatinska 2, 81000, Podgorica

(511) Klasa 3: Nemedicinska pasta za zube, nemedicinska tečnost za ispiranje usta.

(210) **Ž-2019-367**

(220) 25.09.2019.

(731) Colgate-Palmolive Company (a Delaware corporation), 300 Park Avenue, 10022, New York, New York, US



(540)

(550) I

(740) Jasna Jusić, Dalmatinska 2, 81000, Podgorica

(511) Klasa 3: Nemedicinska pasta za zube, nemedicinska tečnost za ispiranje usta.

(210) **Ž-2019-368**

(220) 25.09.2019.

(731) Colgate-Palmolive Company (a Delaware corporation), 300 Park Avenue, 10022, New York, New York, US

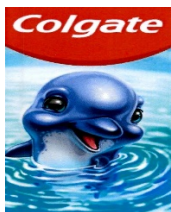

(540)

(550) I

(740) Jasna Jusić, Dalmatinska 2, 81000, Podgorica

(511) Klasa 3: Nemedicinska pasta za zube, nemedicinska tečnost za ispiranje usta.

(210) **Ž-2019-369**

(220) 25.09.2019.

(731) TOYOTA JIDOSHA KABUSHIKI KAISHA (also trading as TOYOTA MOTOR CORPORATION), 1, Toyota-cho, Toyota-shi, 471-8571, Aichi-ken, JP

(540) **HIGHLANDER**

(550) I

(740) Jasna Jusić, Dalmatinska 2, 81000, Podgorica

(511) Klasa 12: Automobili i njihovi strukturalni djelovi.

(210) **Ž-2019-164**

(220) 16.04.2019.

(731) "Icebreaker Limited, Level 2, Lot 3, 130 Ponsonby Road, Grey Lynn, Auckland 1011, NEW ZELAND /NZ

(540) ICEBREAKER

(550) I

(740) Božidar S. Radulović, Studentska bb, Lamela 3/18, 81000, Podgorica, ME

(511) Klasa 25: Odjeća, obuća, pokrivala za glavu.

(210) **Ž-2019-63**

(220) 20.02.2019

(731) Bioverativ Therapeutics Inc., 225 Second Avenue, 02451 WALTHAM, US,

(540) CIBEMTOR

(550) I

(740) Božidar S. Radulović, Studentska bb, Lamela 3/18, 81000, Podgorica, ME

(511) Klasa 5: Farmaceutski proizvodi za liječenje bolesti hladnih aglutinina i hronične imune trombocitopenije

(210) **Ž-2019-373**

(220) 27.09.2019.

(731) Novartis AG, Basel, 4002, CH

(540) RUNAPLAX

(550) I

(740) AOD MSA IP - Milojević Sekulić Advokati, Karađorđeva 65, 11000, Beograd

(511) Klasa 5: Farmaceutski preparati za ljudsku upotrebu.

(210) **Ž-2019-374**

(220) 27.09.2019.

(731) Lidl Stiftung & Co. KG, Stiftsbergstraße 1, 74172, Neckarsulm, DE

(540) FREEWAY UP

(550) I

(740) AOD MSA IP - Milojević Sekulić Advokati, Karađorđeva 65, 11000, Beograd

(511) Klasa 32: Bezalkoholna pića, energetska pića.

(210) **Ž-2019-375**

(220) 30.09.2019.

(731) VIVO MOBILE COMMUNICATION CO., LTD., 283#, BBK Road, Wusha, Chang'an, Dongguan, Guangdong, CN

(540) **NEX**

(550) I

(740) Miladin Popović, Đoka Miraševića 21/III, 81000, Podgorica

(511) Klasa 9: Pametni telefoni; Mobilni telefoni; Futrole za mobilne telefone; Navlake za mobilne telefone; Zaštitne folije prilagođene za ekrane mobilnih telefona; Stalci prilagođeni za mobilne telefone; Slušalice; Setovi za mobilne telefone; Selfi štapovi za upotrebu sa pametnim telefonima; USB kablovi; Ispravljači struje; Baterije, električne; Punjači baterija; Prenosive stanice za punjenje (baterije koje se mogu dopunjavati); Zvučnici; Pametni zvučnici; Bežični setovi za pametne telefone; Bežični punjači; Softver za preuzimanje aplikacija za mobilne telefone; Kompjuteri; Pametne naočare; Pametni satovi; Tablet računari; Noutbuk računari; Televizori; Pametni televizori; Bežične slušalice; Bežični zvučnici;

(210) **Ž-2019-376**

(220) 01.10.2019.

(731) Goran Đukanović, Jelene Savojske 12, 81000, Podgorica, ME



(540)

(550) I

(511) Klasa 14: Medalje i pehari.

Klasa 35: Oglašavanje, reklamiranje, vođenje poslova, poslovno upravljanje, prodaja majica, suvenira, reklamnog materijala, on-line reklamiranje, on-line prodaja, majica, suvenira, reklamiranje materijala.

Klasa 41: Obuka, stručno osposobljavanje, razonoda, sportske i kulturne djelatnosti; organizovanje i vođenje seminara, kongresa; organizovanje sportskih takmičenja, sportskih kampova za usavršavanje u sportu; organizovanje sportskih takmičenja, informacije u vezi rekreacije.

(210) **Ž-2019-377**

(220) 03.10.2019.

(731) JT International S.A., Rue Kazem-Radjavi 8, 1202, Geneva, CH

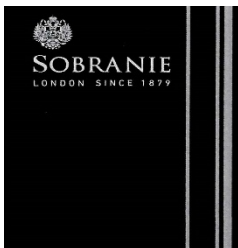

(540)

(550) I

(740) Jasna Jusić, Dalmatinska 2, 81000, Podgorica

(511) Klasa 34: Duvan, koji je prerađen ili neprerađen; duvan za pušenje, duvan za lule, duvan za savijanje, duvan za žvakanje, duvan za sisanje, cigarete, elektronske cigarete, cigare, cigarilosi; burmut; artikli za pušače uključeni u klasu 34; papir za cigarete, fišeci za cigarete i šibice.

(210) **Ž-2019-378**

(220) 24.09.2019.

(731) Turistička organizacija Opštine Budva, Mediteranska 8/6, TQ Plaza, 85310, Budva, ME



(540)

(550) I

(511) Klasa 35: Oglašavanje i reklamiranje; vođenje komercijalnih poslova; komercijalna administracija; kancelarijski poslovi; isporuka reklamnog materijala (letaka, prospekata, uzoraka), reklamnih oglasa, marketing, svi vidovi reklamnog oglašavanja, sajmovi, saopštenja za javnost, informacije (poslovne informacije), isporuka (distribucija) uzoraka, istraživanje javnog mnjenja (anketiranje); izdavanje propagandnog materijala javnosti (odnosi s javnošću) (propaganda), objavljivanje reklamnih tekstova, prelamanje stranica u reklamne svrhe (stavljanje u štampu u reklamne svrhe), radio (reklamiranje putem radija, predstavljanje proizvoda, plakatiranje (oglašavanje).

Klasa 39 Prevoz; ambalažiranje i skladištenje proizvoda; organizovanje putovanja; isporuka (distribucija) proizvoda, isporuka uzoraka, izleti, organizovanje putovanje, paketi (isporuka), prevoz (informacije o prevozu), turističke posjete.

Klasa 41 Obuka; stručno osposobljavanje; razonoda; sportske i kulturne djelatnosti; dekor za priredbe, dopisivanje (obuka putem dopisa), elektronske publikacije, filmovi (proizvodnja filmova), fotografisanje, fotografske reportaže, izdavanje knjiga, javni konkursi, objavljivanje knjiga i časopisa elektronski on line, elektronske publikacije, informacije o razonodi, koncerti (organizovanje i vođenje konferencija).

(210) Ž-2019-379

(220) 04.10.2019.

(731) H Hospitality Collection Holding Limited, P.O. Box 32932, 33, Al Khatem tower, Abu Dhabi Global Market Square, Al Maryah Island, Abu Dhabi, AE

(540) STORY

(550) I

(740) Jasna Jusić, Dalmatinska 2, 81000, Podgorica

(511) Klasa 41: Obrazovanje; obezbjeđivanje obuke; zabava; sportske i kulturne aktivnosti; obezbjeđivanje hotelskih sadržaja za potrebe obuke; pružanje usluga teretane i sadržaja zdravstvenog kluba; organizovanje i sprovođenje konferencija, sastanaka, izložbi, treninga, radionica, poslovnih sajmova, kongresa i predavanja; obezbjeđivanje rekreacionih sadržaja; usluge kampa (odmor) [zabava]; klupske usluge [zabava ili obrazovanje]; vođenje časova fitnesa; ronilačka oprema (iznajmljivanje ronilačke opreme); informacije o zabavi; izložbe (organizovanje) za kulturne ili obrazovne svrhe; iznajmljivanje opreme za igre; usluge zdravstvenog kluba [zdravstveni i fitnes trening]; informacije (rekreacija); iznajmljivanje biblioteka; nastupi uživo (prezentacija); usluge ličnog trenera [fitnes trening].

Klasa 43: Usluge obezbjeđivanja hrane i pića; privremeni smještaj; hotelske usluge; usluge rezervacije, bukiranja i davanja informacija u vezi sa hotelima i privremenim smještajem; usluge potpuno opremljenih apartmana [smještaj]; hotelske usluge obezbjeđivanja objekata za konferencije, sastanke, izložbe, obuke, radionice, poslovne sajmove, kongrese i predavanja; ugostiteljske usluge [smještaj/hrana i piće]; usluge restorana, samouslužnih restorana, restorana sa hranom za ponijeti, kafeterija, kafića, snack-barova; usluge obezbjeđivanja kateringa hrane i pića; dnevne jaslice [jasle].

Klasa 44: Higijenske i kozmetičke usluge; usluge aromaterapije; turska kupatila; usluge kozmetičkog salona; usluge frizerskog salona; usluge masaže; usluge saune; usluge banja; zdravstvene i usluge opuštanja u odmaralištima; usluge pružanja zdravstvenih, fitnes i medicinskih informacija; usluge procjene kondicije; savjeti o ishrani; kozmetičke i usluge njege kože; usluge kozmetičkih tretmana; pružanje usluga i obezbjeđivanje uređaja za tamnjenje kože; pružanje usluga manikira i pedikira; zdravstvena zaštita; manikir; usluge solarijuma; usluge vizažista.

(210) Ž-2019-380

(220) 04.10.2019.

(731) PepsiCo, Inc., 700 Anderson Hill Road, NY 10577, Purchase, US

(540) Papir, Kamen, Makaze

(550) I

(740) Jasna Jusić, Dalmatinska 2, 81000, Podgorica

(511) Klasa 29: Meso; riba; živina; divljač; mesne prerađevine; konzervisano, sušeno i kuvano voće i povrće; želei; džemovi; kompoti; jaja; mlijeko; mliječni proizvodi; jestiva ulja i masti; umaci; sir; jogurt; jestive sjemenke; prerađeni orašasti plodovi; obrađena jestiva sjemena; hranljive pločice na bazi orašastih plodova; mješavine voća i orašastih plodova; čips od krompira; listići od krompira; grickalice na bazi krompira; grickalice na bazi soje; čips od soje; grickalice na bazi voća; čips od voća; juka čips; govedina kao gotova hrana; sušena govedina; ekstrudirana svinjska koža; salate od povrća; namazi od voća i povrća; grickalice i čips na bazi povrća, gotova hrana za grickanje koja se primarno sastoji od krompira i čipsa, orašastih plodova, orašastih proizvoda, sjemenki, voća, povrća ili njihovih kombinacija; grickalice i namazi na bazi mahunarki.

Klasa 30: Kafa, čaj, kakao; zamjena za kafu; šećer; pirinač, tapioka; sago; brašno; proizvodi od žitarica; hleb, kolači; poslastice; sladoledi; med; melasa; kvasac, prašak za pecivo; so; senf; sirće, sosovi (kao dodaci); začini; žitarice; prerađena zrna žitarica; prehrambeni proizvodi za grickanje od brašna cijelog zrna žitarica; prehrambeni proizvodi za grickanje od krompirovog brašna; prehrambeni proizvodi za grickanje od pirinčanog brašna; krekeri; takos čips; tortilja čips; čips na bazi brašna; čips na bazi zrna žitarica; prehrambeni proizvodi za grickanje na bazi zrna žitarica; pločice na bazi žitarica; pločice od žitarica i energetske pločice; prehrambeni proizvodi za grickanje na bazi pirinča; čips od pirinča; listići od pirinča; krekeri od pirinča; ekstrudirani pirinač; kolači od pirinča; prehrambeni proizvodi za grickanje od kukuruza; prerađeni kukuruz; kokice; pečeni kukuruz; grickalice od ekstrudiranog kukuruza; grickalice na bazi kukuruza; ekstrudirane grickalice koje sadrže kukuruz; papadum; perece; granola; pločice na bazi granole; obrađena sjemena žitarica; pločice koje sadrže mješavinu zrna žitarica, orašastih plodova i sušenog voća (poslastice); umaci; sosevi; karamelizovani orasi (poslastice); grickalice na bazi granole; gotova hrana za grickanje koja se primarno sastoji od zrna žitarica, kukuruza, cijelog zrna žitarica ili njihovih kombinacija.

(210) **Ž-2019-381**

(220) 04.10.2019.

(731) H Hospitality Collection Holding Limited, P.O. Box 32932, 33, Al Khatem tower, Abu Dhabi Global Market Square, Al Maryah Island, Abu Dhabi, AE

(540) CUE

(550) I

(740) Jasna Jusić, Dalmatinska 2, 81000, Podgorica

(511) Klasa 41: Obrazovanje; obezbjeđivanje obuke; zabava; sportske i kulturne aktivnosti; obezbjeđivanje hotelskih sadržaja za potrebe obuke; pružanje usluga teretane i sadržaja zdravstvenog kluba; organizovanje i sprovođenje konferencija, sastanaka, izložbi, treninga, radionica, poslovnih sajmova, kongresa i predavanja; obezbjeđivanje rekreacionih sadržaja; usluge kampa (odmor) [zabava]; klupske usluge [zabava ili obrazovanje]; vođenje časova fitnesa; ronilačka oprema (iznajmljivanje ronilačke opreme); informacije o zabavi; izložbe (organizovanje) za kulturne ili obrazovne svrhe; iznajmljivanje opreme za igre; usluge zdravstvenog kluba [zdravstveni i fitnes trening]; informacije (rekreacija); iznajmljivanje biblioteka; nastupi uživo (prezentacija); usluge ličnog trenera [fitnes trening].

Klasa 43: Usluge obezbjeđivanja hrane i pića; privremeni smještaj; hotelske usluge; usluge rezervacije, bukiranja i davanja informacija u vezi sa hotelima i privremenim smještajem; usluge potpuno opremljenih apartmana [smještaj]; hotelske usluge obezbjeđivanja objekata za konferencije, sastanke, izložbe, obuke, radionice, poslovne sajmove, kongrese i predavanja; ugostiteljske usluge [smještaj/hrana i piće]; usluge restorana, samouslužnih restorana, restorana sa hranom za ponijeti, kafeterija, kafića, snack-barova; usluge

obezbjeđivanja kateringa hrane i pića; dnevne jaslice [jasle].

Klasa 44: Higijenske i kozmetičke usluge; usluge aromaterapije; turska kupatila; usluge kozmetičkog salona; usluge frizerskog salona; usluge masaže; usluge saune; usluge banja; zdravstvene i usluge opuštanja u odmaralištima; usluge pružanja zdravstvenih, fitnes i medicinskih informacija; usluge procjene kondicije; savjeti o ishrani; kozmetičke i usluge njege kože; usluge kozmetičkih tretmana; pružanje usluga i obezbjeđivanje uređaja za tamnjenje kože; pružanje usluga manikira i pedikira; zdravstvena zaštita; manikir; usluge solarijuma; usluge vizažista.

(210) Ž-2019-382

(220) 07.10.2019.

(731) Intuit Inc., 2535 Garcia Avenue, CA 94043, Mountain View, US

(540) INTUIT

(550) I

(740) Jasna Jusić, Dalmatinska 2, 81000, Podgorica

(511) Klasa 7: Mašine, mašinski alati, alati na pogon; motori i pogonske mašine, osim za kopnena vozila; mašinske spojnice i transmisioni elementi, osim za kopnena vozila; poljoprivredne sprave, osim alata kojima se upravlja ručno; inkubatori za jaja; automati za prodaju; industrijski roboti; trodimenzionalni (3D) štampači; olovke za 3D štampanje; električni i mehanički upisivači (imprinteri) platnih kartica; električni i mehanički upisivači (imprinteri) kreditnih kartica; generatori električne energije na solarni pogon; prenosni električni generatori; električni i mehanički uređaji za cijeđenje voćnih sokova; električne i mehaničke prese za voće i povrće; električni i mehanički blenderi za hranu; električne i mehaničke mašine za mljevenje hrane; usisivači; usisivači koji mogu sakupljati i suhu prljavštinu i tečnost; bežični usisivači; filteri za prašinu i vreće za usisavače; nastavci za usisivač za širenje parfema i dezinfekcijskih sredstava; mašine za čišćenje tepiha; bežični čistači; mlinovi za so i papar, osim ručnih; mašine za pranje posuđa, uključujući mašine za pranje posuđa koje stoje na radnim površinama; mašine za pranje boca; mašine za pranje odjeće; mašine za čišćenje na paru; centrifuglane mašine za sušenje koje ne griju; mašine za hemijsko čišćenje, uključujući mašine za hemijsko čišćenje koje stoje na radnim površinama; mašine za pravljenje sode i mineralne vode; električne i mehaničke mašine za pripremu hrane; mašine za pranje voća; sredstva za čišćenje i usisavanje bazena; mehanički mlinovi za kafu; električni rezači za pice; mehanički alati za travnjake i dvorište; mehaničke kosilice za travu i korov; čistači za snijeg; električni kuhinjski mikseri; električne makaze; električni noževi; električni otvarači za konzerve; električni vakuumski zaptivači za hranu; električne drobilice za led; električne hranilice za divljač, životinje i kućne ljubimce; električni sistem za otvaranje i zatvaranje vrata; električni motori za kapije; električne jedinice za ultrazvučno čišćenje; mašine za plivanje u kontra struji vodenog toka.

Klasa 9: Aparati i instrumenti, naučni, nautički, geodetski, fotografski, kinematografski i optički, kao i aparati i instrumenti za vaganje, mjerenje, signalizaciju, kontrolu (inspekciju), spasavanje i nastavu; aparati i instrumenti za vođenje, prebacivanje, transformisanje, akumuliranje, podešavanje ili kontrolisanje električne struje; aparati za snimanje, prenos, reprodukciju zvuka ili slika; magnetni nosači podataka, diskovi za snimanje; kompakt diskovi, DVD-i i druga digitalna sredstva za snimanje; mehanizmi za aparate koji se pokreću kovanicama; registar kase, računске mašine, oprema za obradu podataka, računari; aparati za gašenje požara; računarski hardver; računarski softver; računarski aplikativni softver za mobilne uređaje; računarski softver za upotrebu u računovodstvu, knjigovodstvu, obradi transakcija, upravljanju transakcijama, pripremi i planiranju poreza, prijavi poreza, upravljanju porezom, upravljanjem poslovnim procesima i finansijskom planiranju; računarski softver za upotrebu u upravljanju profesionalnom

poreskom praksom; računarski softver za upravljanje bazama podataka, objedinjavanje podataka, izvještavanje i prenos podataka; računarski softver za sigurnosno kopiranje elektroničkih datoteka na mreži; alati i šabloni za razvoj softvera; računarski softver za upotrebu u distribuciji, instaliranju i ažuriranju drugih aplikacija; računarski softver za saradnju i dijeljenje podataka sa drugima; računarski softver za sinhronizaciju podataka između računara i mobilnih uređaja; računarski softver koji se koristi za elektroničku razmjenu računovodstvenih, finansijskih, korisničkih podataka, podataka o kontaktima, podataka o proizvodima i poslovnih podataka; računarski softver za upravljanje zalihama, upravljanje troškovima projekata, procjenama, troškovima poslovanja, praćenje vremena zaposlenih, upravljanje poslovnim operacijama i upravljanje projektima; računarski softver i računarski hardver za upotrebu u transakcijama na prodajnom mjestu, obradi transakcija, upravljanje štampanim računima i maloprodajnim operacijama; računarski softver za kreiranje, prilagođavanje i upravljanje fakturama, evidentiranje plaćanja i izdavanje računa; računarski softver za upotrebu u organizovanju, servisiranju i praćenju podataka o prodaji, naplatama i potraživanjima; računarski softver za praćenje prihoda, troškova, prodaje i profitabilnosti prema lokaciji preduzeća, odsjeka, vrsti poslovanja ili drugom korisničkom polju; računarski softver za računanje i naplatu poreza na promet i kreiranje izvještaja o plaćanju poreza na promet odgovarajućim poreskim agencijama; računarski softver za fakturisanje i plaćanje kreditnim karticama; računarski softver za onlajn bankarstvo; računarski softver za kontrolu pristupa finansijskim informacijama putem postavki elektroničkih dozvola; računarski softver za kreiranje, prilagođavanje, štampanje, izvoz i kupovinu putem e-pošte; računarski softver za praćenje vremena koliko rade zaposleni i podugovorena lica; računarski softver za kreiranje i upravljanje budžetima; računarski softver za kreiranje procjena cijena i prenošenje procjena cijena na račune; računarski softver za automatizaciju kreiranja računa; računarski softver za kreiranje, prilagođavanje, štampanje, izvoz i slanje finansijskih izvještaja e-poštom, poslovnih izvještaja, bilansa stanja, izvještaja o dobitima i gubicima, izvještaja o gotovinskom toku i oporezivih izvještaja o prodaji; računarski softver za kreiranje, štampanje i praćenje čekova i naloga za kupovinu; računarski softver za praćenje prodaje, troškova i plaćanja; računarski softver za analizu finansijskog stanja preduzeća i industrija; računarski softver za upravljanje spiskovima kupaca, podajom putem obrazaca e-poštom i štampano, i praćenjem stanja; računarski softver za unos kontakata i finansijskih podataka iz drugih elektronskih servisa i softvera; računarski softver za transakcije na prodajnom mjestu i upravljanje maloprodajom; računarski softver za upotrebu u administraciji i upravljanju platnim spiskovima, planovima naknada, planovima osiguranja, penzijskim planovima, planovima osiguranja za slučaj nezaposlenosti i unaprijed plaćenim planovima zdravstvene zaštite; računarski softver za upravljanje podacima o zdravstvenoj zaštiti, podacima o receptu, medicinskoj istoriji, medicinskim računima, evidenciji pacijenata i drugim medicinskim podacima; računarski softver za upravljanje medicinskim osiguranjem, medicinskim plaćanjima, troškovima i naplatama; softver za upravljanje odnosima sa klijentima (CRM); softver za planiranje resursa preduzeća (ERP); softver za upravljanje poslovanjem za potrebe upravljanja nekretninama i imovinom, upravljanja uslugama i opravkama automobila, izgradnje i upravljanja zgradama, upravljanja zdravstvenom praksom, upravljanja advokatskim firmama, upravljanja neprofitnim organizacijama i javnim sektorom, upravljanja maloprodajnih objekata i restorana, kao i upravljanja putničkih usluga; računarska periferna oprema; ladice za gotovinu; računarski štampači; računarski štampači i terminali na prodajnom mjestu; čitači i skeneri kreditnih i debitnih kartica; čitači i skeneri bar kodova; POS terminali za kreditne kartice i terminali za obradu transakcija na kreditnoj kartici.

Klasa 11: Rasvjetni uređaji, uređaji za grijanje, kuanje, hlađenje, sušenje, ventilaciju, uređaji za vodosnabdijevanje i sanitarne svrhe; lampe; LED svjetla; učvršćivači za rasvjetu, uključujući učvršćivače za rasvjetne uređaje na solarnu energiju; baterijske džepne lampe; svjetiljke u obliku olovke; stona rasvjeta; baterijske džepne lampe sa laserskim usmjerivačem; svjetla za čitanje i svjetla za knjige; reflektori i svjetla za bicikla; prenosiva pomoćna svjetla; prenosive čeone lampe; lampe za zglobove i čeone lampe za ličnu

upotrebu; abažuri; električne i svijeće bez plamena; grijači; patio grijači; uređaji za grijanje prostora; džepni grijači; grijači stopala; grijači kreveta; stolovi sa vatrom i ognjišta; prijemnici solarne energije; mašine za sušenje odjeće; električni stalak za odjeću za sušenje; aparati za peglanje odjeće na paru; električni grijači pića; peći, uključujući i prenosive; mašine za kafu; aparati za hlađenje pića; aparati za kuvanje riže; uređaji za kuvanje pod pritiskom; električni uređaj za pečenje vafila; električni grilovi za sendviče; električni aparati za kuvanje jaja; mašine za pravljenje hljeba; električni aparati za pravljenje kafe; električne mašine za espresso kafu; grilovi (kućni aparati), električni grilovi, grilovi na gas; grilovi na ugalj; ražnjevi; električni vinski podrumi; termofori; aparati za kade za hidromasažu; prenosivi i ručni tuševi; prenosive kade za stopala; dekorativne vodene fontane; navlake za spa po meri; toalet za kompostiranje; fenovi za kosu; aparati za sušenje ruku; električne mašine za toplo brijanje sa penom; električni šporeti; prenosivi šporeti za kampovanje; električne ringle i pekači; uređaji za spremanje hrane na paru; mikrotalasne pećnice; rerne za pečenje; pećnice za kuvanje; uređaji za vakumiranje; frižideri; prenosivi rashladni uređaji za potrebe potrošača; rashlane vitrine; minibarovi; električni aparati za sušenje suđa, uređaji za kontrolu okoline; kućni aparati za čišćenje vazduha i jonizatori; električni i aparati na pogon za raspršivanje vazduha za domaćinstvo; isušivači vazduha; klima uređaji i ventilatori; električni ventilatori za ličnu upotrebu; aparati za rashlađivanje vazduha; aparati i mašine za filtriranje i prečišćavanje vazduha; električne jedinice za dezodorisanje prostora; fotonaponski uređaji za proizvodnju energije; aparati za rashlađivanje na solarnu energiju; solarni termalni sistemi za grijanje vazduha; filteri za pijaću vodu; aparati za filtriranje i sterilizaciju vode.

Klasa 42: Naučne i tehnološke usluge i istraživanja i dizajn u vezi sa istim; industrijske analize i usluge industrijskog istraživanja; dizajn i razvoj računarskog hardvera i softvera; instaliranje, održavanje, unapređivanje ili iznajmljivanje računarskog softvera; pružanje privremenog korišćenja onlajn softvera koji se ne može preuzimati; elektronsko pohranjivanje podataka; hosting usluge i softver u vidu servisa; softver zasnovan na oblaku i softverske platforme zasnovane na oblaku; pružanje privremenog korišćenja onlajn softvera koji se ne može preuzimati za upotrebu u računovodstvu, knjigovodstvu, procesuiranju transakcija, upravljanju transakcijama, pripremi i planiranju poreza, prijavljivanju poreza, upravljanju poslovnim procesima, i finansijskom planiranju; pružanje privremenog korišćenja onlajn softvera koji se ne može preuzimati za upotrebu u upravljanju profesionalnom poreskom praksom; pružanje privremenog korišćenja onlajn softvera koji se ne može preuzimati za upravljanje bazama podataka, sakupljanje podataka, izvještavanje podataka, i prenos podataka; pružanje privremenog korišćenja onlajn softvera koji se ne može preuzimati za onlajn čuvanje elektronskih datoteka; alati i šabloni za razvoj softvera; pružanje privremenog korišćenja onlajn softvera koji se ne može preuzimati za korišćenje u distribuciji, instaliranju i unapređivanju drugih aplikacija; pružanje privremenog korišćenja onlajn softvera koji se ne može preuzimati za saradnju i dijeljenje podataka sa drugima; pružanje privremenog korišćenja onlajn softvera koji se ne može preuzimati za sinhronizaciju podataka između računara i mobilnih uređaja; pružanje privremenog korišćenja onlajn softvera koji se ne može preuzimati za elektronsku razmjenu računovodstvenih, finansijskih, potrošačkih, podataka o kontaktima, podataka o proizvodu i poslovnih podataka; računarski softver za upravljanje inventarom, upravljanje troškovima projekta, procjenjivanje, troškove poslovanja, praćenje vremena zaposlenih, upravljanje poslovnim operacijama i upravljanje projektima; pružanje privremenog korišćenja onlajn softvera koji se ne može preuzimati za korišćenje u transakcijama na mestu prodaje, obradi transakcija, štampanju računa i upravljanju procesima u maloprodaji; pružanje privremenog korišćenja onlajn softvera koji se ne može preuzimati za kreiranje, prilagođavanje i upravljanje fakturama, bilježenje uplata, i izdavanje potvrda (računa); pružanje privremenog korišćenja onlajn softvera koji se ne može preuzimati za organizovanje, servisiranje i praćenje podataka o prodaji, podataka o naplatama i potraživanjima; pružanje privremenog korišćenja onlajn softvera koji se ne može preuzimati za praćenje primanja, troškova, prodaje, i profitabilnosti prema

poslovnoj lokaciji, odjeljenju, vrsti posla, ili drugim korisničkim oblastima; pružanje privremenog korišćenja onlajn softvera koji se ne može preuzimati za računanje i naplatu poreza na promet i kreiranje izvještaja za plaćanje poreza na promet odgovarajućim poreskim agencijama; pružanje privremenog korišćenja onlajn softvera koji se ne može preuzimati za fakturisanje preko kreditnih kartica i procesuiranje plaćanja kreditnim karticama; pružanje privremenog korišćenja onlajn softvera koji se ne može preuzimati za onlajn bankarstvo; pružanje privremenog korišćenja onlajn softvera koji se ne može preuzimati za kontrolu pristupa finansijskim informacijama putem podešavanja elektronske dozvole; pružanje privremenog korišćenja onlajn softvera koji se ne može preuzimati za kreiranje, prilagođavanje, štampanje, izvoz i e-mail nabavku porudžbina; pružanje privremenog korišćenja onlajn softvera koji se ne može preuzimati za praćenje vremena rada zaposlenih i podugovarača; pružanje privremenog korišćenja onlajn softvera koji se ne može preuzimati za kreiranje i upravljanje budžetima; pružanje privremenog korišćenja onlajn softvera koji se ne može preuzimati za kreiranje procjene troškova i prenos procijenjenih troškova na račune; pružanje privremenog korišćenja onlajn softvera koji se ne može preuzimati za automatsko kreiranje računa; pružanje privremenog korišćenja onlajn softvera koji se ne može preuzimati za kreiranje, prilagođavanje, štampanje, izvoz i e-mail slanje finansijskih izvještaja, poslovnih izvještaja, bilansa, profita i gubitaka, izvještaja o novčanim tokovima, i izvještaja o oporezivom prometu; pružanje privremenog korišćenja onlajn softvera koji se ne može preuzimati za kreiranje, štampanje i praćenje čekova i nabavku porudžbenica; pružanje privremenog korišćenja onlajn softvera koji se ne može preuzimati za praćenje prodaje, troškova i uplata; računarski softver za analiziranje finansijskog statusa preduzeća i industrija; pružanje privremenog korišćenja onlajn softvera koji se ne može preuzimati za upravljanje potrošačkim listama, e-poštu i štampanje prodajnih obrazaca, i praćenje tekućih bilansa; pružanje privremenog korišćenja onlajn softvera koji se ne može preuzimati za unos kontakata i finansijskih podataka sa drugih elektronskih servisa ili softvera; pružanje privremenog korišćenja onlajn softvera koji se ne može preuzimati za transakcije na mjestu prodaje ili upravljanje maloprodajom; pružanje privremenog korišćenja onlajn softvera koji se ne može preuzimati za upotrebu u administraciji ili upravljanju platnim spiskovima, štednim planovima, planovima osiguranja, penzionim planovima, planovima osiguranja za slučaj nezaposlenosti, i pretplatničkim planovima zdravstvenog osiguranja; pružanje privremenog korišćenja onlajn softvera koji se ne može preuzimati za upravljanje informacijama o zdravstvenoj njezi, informacijama o receptima, medicinskoj istoriji, medicinskim računima, bilješkama o pacijentima, i drugim medicinskim bilješkama; pružanje privremenog korišćenja onlajn softvera koji se ne može preuzimati za upravljanje medicinskim osiguranjem, medicinskim uplatama, troškovima i računima; pružanje privremenog korišćenja onlajn softvera koji se ne može preuzimati za upravljanje odnosima sa potrošačima (CRM); pružanje privremenog korišćenja onlajn softvera koji se ne može preuzimati za planiranje resursa u korporacijama (ERP); pružanje privremenog korišćenja onlajn softvera za poslovno upravljanje koji se ne može preuzimati za upotrebu u upravljanju nepokretnostima i imovinom, upravljanju auto-moto uslugama i popravkama; upravljanju konstrukcijama i građevinama, upravljanju praksama zdravstvene njege, upravljanju advokatskim firmama, upravljanju neprofitnim organizacijama i organizacijama javnog sektora, upravljanju maloprodajom i restoranima, i upravljanju putničkim servisima; elektronsko pohranjivanje datoteka i podataka; pohranjivanje elektronskih medija, naime slika, teksta, audio, finansijskih i kontakt podataka; usluge pohranjivanja za arhiviranje baza podataka, slika i drugih elektronskih podataka; usluge hostinga podataka; hosting softverskih programa za upotrebu u upravljanju, organizovanju, i dijeljenju podataka na računarskom serveru i za saradnju zasnovanu na web-u na globalnoj računarskoj mreži i na internoj računarskoj mreži, usluge tehničke podrške; tehničke konsultacije u oblasti računarskog hardvera i softvera; usluge instaliranja računarskog softvera, podešavanja, i konfiguracijske usluge; usluge računarskog softvera i sistemske integracije; konverzija podataka u smislu podataka ili informacija o programima za računare; usluge vraćanja podataka; usluge tehničke podrške, naime,

utvrđivanje i rješavanje problema računarskog softvera, web sajta, onlajn usluga, problema na web i onlajn aplikacijama, problema mobilnih aplikacija, problema na mreži, i problema sa podacima i bazama podataka; sinhronizovanje podataka između računara i mobilnih uređaja.

(210) **Ž-2019-387**

(220) 11.10.2019.

(731) VIA PARADISO DOO, UL.OKTOBARSKE REVOLUCIJE BR 5, PODGORICA, ME



(540)

(550) I

(511) Klasa 25: Odjeća, obuća, pokrivala za glavu.

(210) **Ž-2019-390**

(220) 14.10.2019.

(731) Colgate-Palmolive Company (a Delaware corporation), 300 Park Avenue, 10022, New York, New York, US



(540)

(550) I

(740) Jasna Jusić, Dalmatinska 2, 81000, Podgorica

(511) Klasa 3 Nemedicinska pasta za zube, nemedicinska tečnost za ispiranje usta.

Klasa 21: Četkice za zube.

(210) **Ž-2019-391**

(220) 15.10.2019.

(731) BROADFAR (SHANGHAI) MANAGEMENT CONSULTING CO., LTD., Room 2453, No. 1420 South Zhongshan rd. Huangpu, District, Shanghai, CN

(540) NUSO

(550) I

(740) Božidar Radulović, Studentska bb, Lamela 3/18, 81000, Podgorica

(511) Klasa 34: Duvan za uvijanje; papir za cigarete; upaljači za pušače; duvan za žvakanje; šibice; usitnjen duvan; pepeljare za pušače; duvan; listovi duvana; elektronske cijevi za pušenje; elektronske cigare; elektronske cigarete; arome za duvan, osim esencijalnih ulja; cigare; rezači za cigare; držači za cigare; cigarete; držači za cigarete; filteri za cigarete; kutije za cigarete.

(210) **Ž-2019-392**

(220) 15.10.2019.

(731) "BROG" d.o.o. Laktaši, Ulica Svetosavska broj 52, Glamotocani, Laktaši, BA



(540)

(550) I

(740) Božidar S. Radulović, Studentska bb, Lamela 3/18, 81000, Podgorica

(511) Klasa 25: Odjeća, obuća, pokrivala za glavu.

Klasa 28: Lutke, igračke, igre i predmeti za igru.

Klasa 35: Uvoz i izvoz; promocija prodaje za treće osobe.

(210) **Ž-2019-393**

(220) 15.10.2019.

(731) Aktiebolaget Electrolux, , 105 45, Stockholm, SE

(540) ARTHUR MARTIN

(550) I

(740) AOD "Ćupić", Bulevar Džordža Vašingtona 79, 81000, Podgorica

(511) Klasa 8: Pribor za jelo; kuhinjski noževi; oštrači za noževe.

Klasa 11: Električne posude za kuvanje na pari.

Klasa 21: Posuđe i posude za domaćinstvo ili kuhinju; posuđe; posuđe za pečenje i stolno posuđe osim viljuški, noževa i kašika; posude za kuvanje na pari; pribor za posluživanje.

(210) **Ž-2019-394**

(220) 16.10.2019.

(731) Merck Sharp & Dohme Corp., One Merck Drive, 08889, Whitehouse Station, New Jersey, US

(540) PIFELTRO

(550) I

(740) Jasna Jusić, Dalmatinska 2, 81000, Podgorica
(511) Klasa 5: Farmaceutski preparati.

(210) **Ž-2019-395**
(220) 16.10.2019.
(731) Merck Sharp & Dohme Corp., One Merck Drive, 08889, Whitehouse Station, New Jersey, US
(540) ZUMELPRA
(550) I
(740) Jasna Jusić, Dalmatinska 2, 81000, Podgorica
(511) Klasa 5: Farmaceutski preparati.

(210) **Ž-2019-396**
(220) 16.10.2019.
(731) Merck Sharp & Dohme Corp., One Merck Drive, 08889, Whitehouse Station, New Jersey, US
(540) ZIERVUS
(550) I
(740) Jasna Jusić, Dalmatinska 2, 81000, Podgorica
(511) Klasa 5: Farmaceutski preparati.

(210) **Ž-2019-397**
(220) 16.10.2019.
(731) Merck Sharp & Dohme Corp., One Merck Drive, 08889, Whitehouse Station, New Jersey, US
(540) DELSTRIGO
(550) I
(740) Jasna Jusić, Dalmatinska 2, 81000, Podgorica
(511) Klasa 5: Farmaceutski preparati.

(210) **Ž-2019-398**
(220) 16.10.2019.
(731) Merck Sharp & Dohme Corp., One Merck Drive, 08889, Whitehouse Station, New Jersey, US
(540) ZOTREPLIX
(550) I
(740) Jasna Jusić, Dalmatinska 2, 81000, Podgorica
(511) Klasa 5: Farmaceutski preparati.

(210) **Ž-2019-400**

(220) 17.10.2019.

(731) Celgene Corporation, 86 Morris Avenue, 07901, Summit, New Jersey, US

(540) АСТОТЛЕО

(550) I

(740) Jasna Jusić, Dalmatinska 2, 81000, Podgorica

(511) Klasa 5: Farmaceutski preparati za liječenje raka i autoimunih bolesti, bolesti iz oblasti onkologije, imunologije i zapaljenskih procesa; farmaceutski preparati, naime inhibitori lijeka citokina; farmaceutski preparati koji moduliraju imunološki sistem; farmaceutski preparati, naime preparati za liječenje tumora; farmaceutski i biološki preparati za imunoterapiju, uključujući T-ćelijsku terapiju; ćelije za medicinsku ili kliničku upotrebu; dijagnostički setovi koji se sastoje prevashodno od ćelija za medicinsku ili kliničku upotrebu.

(210) **Ž-2019-401**

(220) 17.10.2019.

(731) Celgene Corporation, 86 Morris Avenue, 07901, Summit, New Jersey, US

(540) ЕНХАРЕКС

(550) I

(740) Jasna Jusić, Dalmatinska 2, 81000, Podgorica

(511) Klasa 5: Farmaceutski preparati za liječenje raka i autoimunih bolesti, bolesti iz oblasti onkologije, imunologije i zapaljenskih procesa; farmaceutski preparati, naime inhibitori lijeka citokina; farmaceutski preparati koji moduliraju imunološki sistem; farmaceutski preparati, naime preparati za liječenje tumora; farmaceutski i biološki preparati za imunoterapiju, uključujući T-ćelijsku terapiju; ćelije za medicinsku ili kliničku upotrebu; dijagnostički setovi koji se sastoje prevashodno od ćelija za medicinsku ili kliničku upotrebu.

(210) **Ž-2019-402**

(220) 17.10.2019.

(731) Celgene Corporation, 86 Morris Avenue, 07901, Summit, New Jersey, US

(540) ЛЕЛОКИ

(550) I

(740) Jasna Jusić, Dalmatinska 2, 81000, Podgorica

(511) Klasa 5: Farmaceutski preparati za liječenje raka i autoimunih bolesti, bolesti iz oblasti onkologije, imunologije i zapaljenskih procesa; farmaceutski preparati, naime inhibitori lijeka citokina; farmaceutski preparati koji moduliraju imunološki sistem; farmaceutski preparati, naime preparati za liječenje tumora; farmaceutski i biološki preparati za imunoterapiju, uključujući T-ćelijsku terapiju; ćelije za medicinsku ili kliničku upotrebu; dijagnostički setovi koji se sastoje prevashodno od ćelija za medicinsku ili kliničku upotrebu.

(210) **Ž-2019-404**

(220) 22.10.2019.

(731) Intercontinental Great Brands LLC, 100 Deforest Avenue, 07936, East Hanover, New Jersey, US



(540)

(550) I

(740) Miladin Popović, Đoka Miraševića 21/III, 81000, Podgorica

(511) Klasa 29: Mliječni proizvodi, posebno mliječni deserti i ohlađeni deserti, uključujući museve, proizvode od pavlake i jogurta.

Klasa 30: Sladoledi, smrznute poslastice; deserti, ohlađeni deserti; mješavine za pečenje; preparati napravljeni od žitarica, žitarice za doručak.

(210) **Ž-2019-406**

(220) 23.10.2019.

(731) GRE Grand River Enterprises Deutschland GmbH, Rietzer Berg 28, 14797 Kloster Lehnin/OT Rietz, 14797 Kloster Lehnin/OT Rietz, DE

(540) MOHAWK

(550) I

(740) Božidar S. Radulović, Studentska bb, Lamela 3/18, 81000, Podgorica

(511) Klasa 5: Proizvod koji se odnosi na kanabis, naime, ulja; ulja dobijena iz kanabisa; kanabis i marihuana proizvodi koji se odnose na kanabis, naime ulja, melemi, koncentrovane paste, tinkture, tablete i kapsule, od kojih svaka sadrži kanabis; ulja, melemi, koncentrovane paste, tinkture, tablete i kapsule koje sadrže smole i ulja dobijena iz kanabisa; nutritivna sredstva za medicinske svrhe; nutritivna sredstva za medicinske svrhe koja sadrže kanabis; nutritivna sredstva za medicinske svrhe koji sadrže derivate kanabisa, naime smole i ulja; topikalne kreme za kožu (kreme koje se primjenjuju na tjelesnim površinama), čvrsti i tečni sapuni, aditivi za kupanje, ljekovito bilje za kupanje, ulja za kupanje, kreme za tijelo, ulja za tijelo, losioni za lice i tijelo, mlijeko za lice i tijelo, losion za lice i preparati za njegu kože od kojih svaki sadrži derivate kanabisa; seksualni lubrikanti za ličnu upotrebu; transdermalni flasteri koji sadrže kanabis; oralni sprejevi koji sadrže kanabis; svaki od gore navedenih proizvoda za ublažavanje boli, za opuštanje, za smanjenje stresa i umora, za poboljšanje raspoloženja, za održavanje opšteg zdravlja i blagostanja, za ublažavanje anksioznosti, za ublažavanje depresije, kao sredstvo za spavanje; svi gore navedeni proizvodi takođe sa konopljom, uljem od sjemena konoplje ili kanabinoidom.

Klasa 34: Neobrađeni duvan, prerađeni duvan i duvanski proizvodi, uključeni u klasu 34, a posebno cigarete, cigare, cigarilose, sitno rezani duvan, duvan za lule, duvan za žvakanje, burmut, cigarete koje sadrže duvanske zamjene, ne za medicinske svrhe; proizvodi za pušače, posebno metalne kutije za duvan, kutije za cigarete, držači za cigarete, pepeijare (sva gore pomenuta roba koja nije od plemenitih metala ili nije presvučena sa njima), papir za cigarete, prazne cigarete (tube), filter za cigarete, lule za pušenje, džepna mašinica za motanje cigareta, upaljači, uključeni u klasu 34; šibice; derivati kanabisa, naime smole i ulja; kanabis i marihuana za rekreativnu upotrebu; proizvodi od konoplje za pušenje; kanabis za pušenje; proizvodi od kanabisa za pušenje; proizvodi za pušače, naime, vreće za upotrebu sa marihuanom i kanabisom; proizvodi za pušače, naime oralni isparivači za pušače; suva marihuana, suvi kanabis; proizvodi za pušače, naime, drobilice za upotrebu sa kanabisom i marihuanom.

(210) **Ž-2019-407**

(220) 25.10.2019.

(731) RIBIZLA DOO, II CRNOGORSKOG BATALJONA BR.A8, PODGORICA, ME

**KOKA**

(540)

(550) I

(740) Vuk Lutovac, Bulevar Ivana Crnojevića 93, 81000, Podgorica

(511) Klasa 14: Nakit.

Klasa 16: Hartija, karton i proizvodi od njih, naime, sveske, kalendari, razglednice, podmetači, kese, koverta, sve vrste ukrasnih predmeta i poklona od papira i kartona; štampane stvari; knjigovezački materijal; fotografije, kancelarijski materijal; lepila za kancelarijske i kućne potrebe; umetnički materijali; kičice; pišaće mašine i kancelarijski rekviziti (izuzev nameštaja); materijali za obuku i nastavu (izuzev aparata); plastični materijal za pakovanje (koji nije uključen u druge klase); štamparska slova; klišeji.

Klasa 25: Odjeća, obuća, pokrivala za glavu.

Klasa 35: Usluge prodaje na malo, naročito vezano za odjevne predmete, obuću, pokrivala za glavu, odjevne detalje, dizajnirane torbe, putne torbe, predmete od kože, naočari za sunce, nakit, satove, igračke i igre, detalje za kosu, kozmetiku, toaletni pribor, mirise, proizvode za ličnu njegu, kancelarijski materijal, poklone i suvenire usluge online prodaje na malo i online naručivanja u vezi sa širokim asortimanom robe široke potrošnje; usluge reklamiranja u vezi sa odjevnim predmetima i ličnim asesoarima za muškarce, žene i djecu.

(210) Ž-2019-408

(220) 25.10.2019.

(731) RIBIZLA DOO, II CRNOGORSKOG BATALJONA BR.A8, PODGORICA, ME

(540) KOKA

(550) I

(740) Vuk Lutovac, Bulevar Ivana Crnojevića 93, 81000, Podgorica

(511) Klasa 14: Nakit.

Klasa 16 Hartija, karton i proizvodi od njih, naime, sveske, kalendari, razglednice, podmetači, kese, koverta, sve vrste ukrasnih predmeta i poklona od papira i kartona; štampane stvari; knjigovezački materijal; fotografije, kancelarijski materijal; lepila za kancelarijske i kućne potrebe; umetnički materijali; kičice; pišaće mašine i kancelarijski rekviziti (izuzev nameštaja); materijali za obuku i nastavu (izuzev aparata); plastični materijal za pakovanje (koji nije uključen u druge klase); štamparska slova; klišeji.

Klasa 25: Odjeća, obuća, pokrivala za glavu.

Klasa 35: Usluge prodaje na malo, naročito vezano za odjevne predmete, obuću, pokrivala za glavu, odjevne detalje, dizajnirane torbe, putne torbe, predmete od kože, naočari za sunce, nakit, satove, igračke i igre, detalje za kosu, kozmetiku, toaletni pribor, mirise, proizvode za ličnu njegu, kancelarijski materijal, poklone i suvenire usluge online prodaje na malo i online naručivanja u vezi sa širokim asortimanom robe široke potrošnje; usluge reklamiranja u vezi sa odjevnim predmetima i ličnim asesoarima za muškarce, žene i djecu.

(210) **Ž-2019-409**

(220) 25.10.2019.

(731) Alibaba Group Holding Limited, Fourth Floor, One Capital Place, P.O. Box 847, George Town, Grand Cayman, KY

(540) EWTP

(550) I

(740) Jasna Jusić, Dalmatinska 2, 81000, Podgorica

(511) Klasa 9: Aparati i instrumenti naučni, istraživački, navigacioni, geodetski, fotografski, kinematografski, audiovizuelni, optički, za vaganje, mjerenje, signalizaciju, otkrivanje, testiranje, ispekciju, spasavanje i nastavu; aparati i instrumenti za provodenje, prekid, transformaciju, akumulaciju, regulisanje ili kontrolu distribucije ili upotrebe električne energije; aparati i instrumenti za snimanje, prenošenje, reprodukovanje ili obradivanje zvuka, slike ili podataka; podaci koji su snimljeni i koji se mogu preuzeti, računarski softver, prazni nosači podataka za digitalno ili analogno snimanje i skladištenje; magnetni nosači podataka, diskovi za snimanje; mehanizmi za aparate koji se pokreću novcem; registar kase, uredaji za računanje, oprema i računari za obradu podataka; periferni računarski uredaji; odijela za ronjenje, maske za ronjenje, čepovi za uši za ronioce, štikaljke za nos za ronioce i plivače, rukavice za ronioce, aparati za disanje za podvodno plivanje; računarski programi; računarski programi u obliku aplikacije za mobilne uredaje i računare; softverske aplikacije za korišćenje sa mobilnim uredajima; softver za obradu elektronskih plaćanja za druge i od drugih; softver za autentifikaciju; kompjuterski softver koji se može naći na internetu; onlajn elektronske publikacije (koje se mogu preuzeti sa interneta ili kompjuterske mreže ili iz kompjuterske baze podataka); softver za razmjenu trenutnih poruka; softver za dijeljenje datoteka; komunikacijski softver za elektronsku razmjenu podataka, audio i video sadržaja, slika i grafika putem računarskih, mobilnih, bežičnih i telekomunikacionih mreža; računarski softver za obradu slika, grafike, audio sadržaja, video sadržaja, i teksta; kompjuterski softver koji se može preuzimati koji olakšava elektronski prenos informacija, podataka, dokumenata, glasa i slika preko Interneta; računarske aplikacije za emitovanje audio materijala, video materijala, videa, muzike i slike; uredaji za emitovanje digitalnog sadržaja; računarski softver koji se može preuzimati koji omogućava korisnicima da učestvuju na onlajn sastancima i časovima, sa pristupom podacima, dokumentima, slikama i softverskim aplikacijama kroz internet pretraživač; računarski softver koji se može preuzeti za pristup, pregled, i upravljanje udaljenim računarima i računarskim mrežama; softver za računarstvo u oblaku koji se može preuzimati; softver koji se nalazi u oblaku, a koji se može preuzimati; računarski softver; računarski softver (uključujući softver koji se može preuzimati sa interneta); digitalna muzika (koja se može preuzimati sa interneta); igre, slike, igrani filmovi, filmovi i muzika koji se mogu preuzeti; računari, programi i softveri za elektronske i video igre (uključujući softvere koji se mogu preuzimati sa interneta); elektronske publikacije koje se mogu preuzimati, u obliku časopisa, članaka, brošura, lifleta, tehničkih specifikacija, informacionih materijala, priručnika u oblastima poslovanja, elektronske trgovine, informacionih tehnologija, računarstva u oblaku, telekomunikacija, interneta, obuka u vezi sa poslovanjem i elektronskom trgovinom, upravljanja poslovanjem, prodajom, marketingom i finansijama; poluprovodnici; poluprovodnička integrisana kola; poluprovodnički memorijski čipovi; poluprovodnički memorijski kontroleri; poluprovodnička memorijska integrisana kola; poluprovodnički procesorski čipovi; poluprovodnički procesori; mikrokontroleri; mikrokontrolerske jedinice; mikrokontroleri sa niskim naponom; čipovi za kola; čipovi za računare; CPU (centralna procesorska jedinica); RISC-V računarski čipovi i centralne procesorske jedinice; računarski čipovi i centralnim procesorskim jedinicama sa arhitekturom skupa instrukcija; računarske periferalne jedinice; noutbuk računari; laptop računari; prenosivi računari; ručni računari; tablet računari; lični digitalni asistenti; lični media plejeri; mobilni telefoni; pametni telefoni; digitalne kamere; baterije, punjaci za baterije; računarske radne stanice; računarski serveri; kompjuterski i telekomunikacioni mrežni hardver; kompjuterski mrežni adapteri,

prekidači, ruteri i habovi (razvodnici); bežični i žični modemi i komunikacione kartice i uredaji; držači za laptop, torbe za računare; aparti za gašenje požara; kompjuterski hardver i firmver; automobilski sistemi za navigaciju; kompakt diskovi; telekomunikacijski aparati; podloge za miševe; slušalice za mobilne telefone; dodaci za mobilne telefone; sistemi za alarme; bezbjednosne kamere; mobilne radio i televizijske jedinice za emitovanje; oprema za televizijsko emitovanje; kamere; video kamere; slušalice; telefonske slušalice koje se nose u uvetu; zvučnici; uredaji i oprema za globalno pozicionirajući sistem [GPS]; displeji od tečnih kristala za telekomunikacionu i elektronsku opremu; set top boks; daljinski upravljači; programi za skladištenje podataka; naočare i naočare za sunce; elektronske table sa natpisom; kodirane ili magnetne bankovne kreditne, debitne, gotovinske, platne, telefonske i identifikacione kartice; automatski bankomati, uredaji za podizanje gotovine; računarske softverske aplikacije, koje se mogu preuzimati; čitači elektronskih knjiga; toner kertridži, prazni, za štampače i fotokopire; uredaji za nadgledanje beba; video uredaji za nadgledanje beba; poklopci za fotografska sočiva; kodirane ključ kartice; 3D naočare; memorijske kartice za mašine za video igre.

Klasa 35: Oglašavanje; vođenje poslova; poslovno upravljanje; kancelarijski poslovi; širenje poslovnih informacija o robama i uslugama drugih putem lokalnih i globalnih računarskih mreža; usluge poslovnog savjetovanja koje se odnose na pružanje veb stranica na globalnoj računarskoj mreži putem kojih treće strane mogu ponuditi i dostaviti robe i usluge, plasirati, determinisati ugled i zadovoljiti potencijalnu saradnju i narudžbe, sklapati ugovore i poslovne transakcije; pružanje usluga online naručivanja putem računara; usluge poslovnog savjetovanja u vezi s radom na elektronskom tržištu za kupce i prodavce roba i/ili usluga na globalnoj računarskoj mreži; poslovna pomoć koja se odnosi na olakšavanje poslovne transakcije putem lokalnih i globalnih računarskih mreža; pružanje prodajnih, poslovnih, reklamnih i promotivnih informacija putem globalne računarske mreže i putem interneta; usluge poslovne administracije za obradu prodaje ostvarene na Internetu; usluge trgovanja na mreži u vezi s elektronskim aukcijama i onlajn pružanje poslovnih procjena u vezi s tim; usluge poslovnog upravljanja u vezi s elektronskom trgovinom; organizacija, rukovođenje i nadgledanje programa lojalnosti i podsticajnih programa; proizvodnja televizijskih i radio reklama; računovodstvo; usluge prodaje putem licitacije; sajmovi; ispitivanje javnog mnjenja; obrada podataka; pružanje poslovnih informacija; usluge reklamnih agencija; upravljanje bazama podataka; sakupljanje informacija u kompjuterske baze podataka; usluge poslovnog savjetovanja; usluge upravljanja poslovnim projektima; usluge istraživanja tržišta; usluge međunarodnih agencija za uvoz i izvoz; iznajmljivanje reklamnog prostora na komunikacijskim medijima; obezbjeđivanje direktorijuma Internet stranica trećih strana za olakšavanje poslovnih transakcija; komercijalna administracija za licenciranje roba i usluga drugih; kompjuterska obrada podataka; usluge informisanja o prodaji, poslovanju i promocijama; javljanje na telefon (za druge); upravljanje osobljem; predstavljanje robe na komunikacijskim medijima za maloprodajne svrhe; usluge agencija za kupovinu i prodaju; izbor i nabavka robe za fizička i pravna lica; usluge naručivanja (za druge); sekretarske usluge; organizacija izložbi za komercijalne ili reklamne svrhe; organizacija modnih revija u komercijalne svrhe; organizacija modnih revija u promotivne svrhe; usluge poslovne pomoći u vezi sa sakupljanjem i iznajmljivanjem listi adresa; poslovno istraživanje; usluge poslovnih preporuka i raspoređivanja osoblja; agencije za uvoz-izvoz (usluge agencija za uvoz-izvoz); agencije za novinske pretplate; iznajmljivanje kancelarijske opreme; upravljanje odnosima sa mušterijama; usluge poslovnog upravljanja i administracije u vezi sa programima sponzorstava; računovodstvene usluge; dobrotvorne usluge, naime organizacija i vodenje volonterskih programa i projekata društvenog servisa; iznajmljivanje štandova za prodaju; pružanje informacija o komercijalnim i poslovnim kontaktima; optimizacija pretraživača; optimizacija saobraćaja sa veb stranice; usluge komercijalnog posredovanja; poslovno upravljanje za nezavisne pružaoce usluga; pregovaranje i zaključivanje trgovinskih transakcija za treća lica; ažuriranje i održavanje podataka u kompjuterskim bazama podataka; usluge maloprodaje i veleprodaje, sve u vezi sa hemikalijama koje se

koriste u industriji, nauci i fotografiji, kao i u poljoprivredi, vrtlarstvu i šumarstvu, neobrađenim vještačkim smolama, neobrađenom plastikom, kompostu, stajskim gnojivima, dubrivima; usluge maloprodaje i veleprodaje, sve u vezi sa bojama, firnazima, lakovima, konzervansima protiv rde i protiv propadanja drveta, pigmentima, farbama, mastilima za štampanje, obilježavanje i graviranje, sirovih prirodnih smola, metala u foliji i u prahu za upotrebu u slikarstvu, dekorisanju, štamparstvu i umjetnosti; usluge maloprodaje i veleprodaje, sve u vezi sa nemedicinskom kozmetikom i toaletnim priborom, nemedicinskim zubnim sredstvima, parfimerijom, eteričnim uljima, preparatima za parfimiranje soba, preparatima za bijeljenje i drugim supstancama koje se upotrebljavaju za rublje, preparati za čišćenje, poliranje, ribanje i abrazivni preparati; usluge maloprodaje i veleprodaje, sve u vezi sa farmaceutskim, medicinskim i veterinarskim preparatima, sanitarnim preparatima za medicinske svrhe, dijetalnom hranom i supstancama prilagodenim za medicinsku ili veterinarsku upotrebu, hranom za bebe, dodacima ishrani za ljude i životinje, zavojima, materijalima za zavijanje, kompletima za prvu pomoć, materijalom za plombiranje zuba, zubnim voskom, dezinfekcionim sredstvima, preparatima za uništavanje štetočina, fungicidima, herbicidima; usluge maloprodaje i veleprodaje, sve u vezi sa običnim metalima i njihovim legurama, rudama, metalnim materijalima za izgradnju i konstrukciju, prenosivim metalnim građevinskim konstrukcijama, neelektričnim kablovima i žicama od običnih metala, sitnim metalnim predmetima, metalnim kontejnerima za skladištenje ili transport, sefovima; usluge maloprodaje i veleprodaje, sve u vezi sa mašinskim alatima, električnim alatima, motorima i pogonskim mašinama (osim za kopnena vozila), mašinskim spojnicama i transmisionim elementima (osim za kopnena vozila); usluge maloprodaje i veleprodaje, sve u vezi sa poljoprivrednim alatima (osim ručnog alata), inkubatorima za jaja, automatskim uređajima za prodaju, električnim aparatima za kuhinju, mašinama za brisanje, čišćenje, pranje i pranje veša; usluge maloprodaje i veleprodaje, sve u vezi s ručnim alatom i spravama (kojima se ručno upravlja), priborom za jelo, hladnim oružjem (osim vatrenog oružja), žiletima, električnim brijadžima; usluge maloprodaje i veleprodaje, sve u vezi sa naučnim, nautičkim, geodetskim, fotografskim, kinematografskim, optičkim, za vaganje, za mjerenje, signalnim, kontrolnim (nadзорnim), aparatima i instrumentima za spašavanje života i nastavnim uređajima, aparatima i instrumentima za vodenje, skretanje, transformisanje, akumuliranje, regulisanje ili kontrolom električne energije; usluge maloprodaje i veleprodaje, sve u vezi sa uređajima za snimanje, prenos ili reprodukciju zvuka ili slike, magnetnim nosačima podataka, diskovima za snimanje, mehanizmima za aparate koji se pokreću kovanicama, kasama, računskim mašinama; usluge maloprodaje i veleprodaje, sve u vezi s opremom i računarima za obradu podataka, računarskim softverom, softverskim aplikacijama za mobilne uređaje i računare, softverskim aplikacijama za upotrebu sa mobilnim uređajima, softverom za obradu elektronskih plaćanja, softverom za autentifikaciju, elektronskim publikacijama (koje se mogu preuzimati); usluge maloprodaje i veleprodaje, sve u vezi sa softverom za instant poruke, softverom za dijeljenje datoteka, softverom za elektronsku razmjenu i dijeljenje podataka, audio zapisa, video zapisa, slika i grafike putem računarskih, mobilnih, bežičnih i telekomunikacionih mreža, računarski softver za obradu slika, grafike, audio zapisa, video zapisa i teksta; maloprodajne i veleprodajne usluge, sve u vezi sa računarskim softverom koji se može preuzeti, a koji omogućava korisnicima da učestvuju u sastancima i predavanjima na mreži, računarskim softverom za pristup, gledanje i kontrolu udaljenih računara i računarskih mreža, softverom za računarsko korišćenje u oblaku, računarskom perifernom opremom; usluge maloprodaje i veleprodaje, sve u vezi sa poluprovodnicima, poluprovodničkim integrisanim kolima, poluprovodničkim memorijskim čipovima, poluprovodničkim memorijskim kontrolerima, poluprovodničkim memorijskim integrisanim kolima, poluprovodničkim procesorskim čipovima, poluprovodničkim procesorima, mikrokontrolerima, jedinicama mikrokontrolera, mikrokontrolerima male snage, čipovima kota, računarskim čipovima; usluge maloprodaje i veleprodaje, sve u vezi sa CPU-om (centralnom procesorskom jedinicom), RISC-V računarskim čipovima i centralnim procesorskim jedinicama, računarskim čipovima i centralnim procesorskim jedinicama sa arhitekturom skupa instrukcija; usluge maloprodaje i

veleprodaje, sve u vezi sa ličnim digitalnim asistentima, ličnim medijskim plejerima, mobilnim telefonima, pametnim telefonima, digitalnim fotoaparatom, baterijama, punjačima baterija, računarskim serverima, računarskim i telekomunikacionim mrežnim hardverom, računarskim mrežnim adapterima, svičevima (skretnicama), ruterima i habovima (razvodnicima), bežičnim i žičanim modemima i komunikacijskim karticama i uredajima, držačima za laptop; usluge maloprodaje i veleprodaje, sve u vezi sa računarskim torbama, aparatima za gašenje požara, kompakt diskovima, digitalnom muzikom (koja se može preuzimati), telekomunikacionim aparatima, podlogama za miš, dodacima za mobilne telefone, igricama koje se mogu preuzimati, slikama, igranim filmovima, filmovima i muzikom, alarmnim sistemima, sigurnosnim kamerama; usluge maloprodaje i veleprodaje, sve u vezi sa mobilnim radio i televizijskim emitterskim jedinicama, televizijskom opremom za emitovanje, uredajima i opremom za sistem globalnog pozicioniranja (GPS), programima za čuvanje podataka, naočarima i sunčanim naočarima, elektronskim tablama sa natpisima; usluge maloprodaje i veleprodaje, sve u vezi s kodiranim ili magnetnim bankarskim kreditnim, debitnim, gotovinskim i identifikacionim karticama, automatskim šalter-mašinama, držačima gotovine (u smislu fioke za gotovinu u bankomatima), uredajima za čitanje elektronskih knjiga, praznim kertridžima za štampače i fotokopir uredaje, monitorima za bebe, okvirima i poklopcima za objektivne, kodiranim ključ karticama, 3D naočarima, memorijskim karticama za mašine za video igre, magnetima, zaštitnom odjećom, zaštitnim kacigama, zaštitnim rukavicama, zaštitnom obućom; usluge maloprodaje i veleprodaje, sve u vezi sa hirurškim, medicinskim, stomatološkim i veterinarskim aparatima i instrumentima, vještačkim udovima, očima i zubima, ortopedskim proizvodima, materijalima za šivenje, terapijskim i pomoćnim uredajima prilagođenim osobama sa invaliditetom, aparatima za masažu, aparatima, uredajima i proizvodima za dojenčad, uredajima i proizvodima za seksualnu aktivnost; usluge maloprodaje i veleprodaje, sve u vezi sa terapijskim aparatima na topli vazduh, električnim pokrivačima za medicinske svrhe, aparatima za testiranje u medicinske svrhe, aparatima za testiranje krvi, slušnim aparatima za gluve, zaštitnim uredajem za sluh, električnim pokrivačima za medicinske svrhe, dijagnostičkim aparatima za medicinsku upotrebu, vještačkim udovima, očima i zubima, potpornim zavojima, dječijim flašicama, cuclama za flašice za hranjenje beba, strugalicama za jezik; usluge maloprodaje i veleprodaje, sve u vezi sa uredajima i instalacijama za osvjetljenje, grijanje, hlađenje, proizvodnju pare, kuvanje, sušenje, ventilaciju, vodosnabdijevanje i sanitarne svrhe; usluge maloprodaje i veleprodaje, sve u vezi sa vozilima, aparatima za kretanje kopnom, vazduhom ili vodom, biciklima, djelovima i priborom za vozila, djelovima i priborom za bicikla, bezbjednosnim sjedištima za djecu u vozilima, sigurnosnim pojasevima za sjedišta, gumama, zakrpama za gume, navlakama za gume; usluge maloprodaje i veleprodaje, sve u vezi sa vatrenim oružjem, municijom i projektilima, eksplozivima, vatrometom; usluge maloprodaje i veleprodaje, sve u vezi sa plemenitim metalima i njihovim legurama, nakitom, dragim i poludragim kamenjem, horološkim i hronometrijskim instrumentima; usluge maloprodaje i veleprodaje, sve u vezi sa muzičkim instrumentima, muzičkim stalcima i štandovima za muzičke instrumente, dirigent palicama; usluge maloprodaje i veleprodaje, sve u vezi s papirom i kartonom, štampanim stvarima, materijalom za uvezivanje knjiga, fotografijama, kancelarijskim priborom i potrepštinama (izuzev namještaja), ljepilima za kancelarijsku ili kućnu upotrebu, materijalima za crtanje i materijalima za umjetnike, četkama za farbanje; usluge maloprodaje i veleprodaje, sve u vezi sa instruktivnim i nastavnim materijalima, plastičnim listovima, folijama i vrećama za ambalažu i pakovanje, štampačima, blokovima za štampanje, karticama u obliku debitnih kartica, kreditnih kartica, kartica za naplatu, telefonskih kartica i identifikacionih kartica osim kodiranih i magnetnih kartica, priručnicima za korisnike, maramicama od papira, modelima i figuricama od papira, držačima za stranice, papirnim salvetama, papirnim maramicama, ukrasima za zabave od papira; usluge maloprodaje i veleprodaje, sve u vezi sa kožom i imitacijama kože, životinjskom kožom i istegnutom životinjskom kožom, prtljagom i torbama, novčanicima i tašnama, kišobranima i suncobranima, štapovima za hodanje, bičevima, saračkim i sedlarskim stvarima, okovratnicima, povodcima i odjećom za životinje; usluge maloprodaje i veleprodaje,

sve u vezi sa namještajem, ogledalima, ramovima za slike, posudama za skladištenje i transport (ne od metala); usluge maloprodaje i veleprodaje, sve u vezi sa priborom i posudama za domaćinstvo ili kuhinju, posudem i priborom za sto (osim viljušaka, noževa i kašika), češljevima i sunderima, četkicama (osim četkica za farbanje), materijalima za izradu četkica, proizvodima za čišćenje, posudem od stakla, porculana i grnačarijom, električnim četkicama za zube; usluge maloprodaje i veleprodaje, sve u vezi sa užadima i konopcima, mrežama, šatorima i ciradama, tendama od tekstilnih ili sintetičkih materijala, jedrima, vrećama za transport i skladištenje materijala u gomilama, postavama, jastucima i materijalima za punjenje (osim papira, kartona, guma ili plastika), sirovi vlaknasti tekstilni materijali i njihove zamjene; usluge maloprodaje i veleprodaje, sve u vezi s predivom i nitima, za tekstilnu upotrebu; usluge maloprodaje i veleprodaje, sve u vezi s tekstilom i zamjenama za tekstil, posteljinom za domaćinstvo, zavjesama od tekstila ili plastike; usluge maloprodaje i veleprodaje, sve u vezi s odjećom, obućom, pokrivalima za glavu; usluge maloprodaje i veleprodaje, sve u vezi s čipkom, pletenicama i vezom, i galanterijskim vrpcama i mašnjama, dugmadima, kopčama, iglama i iglicama, vještačkim cvijećem, ukrasima za kosu, vještačkom kosom; usluge maloprodaje i veleprodaje, sve u vezi sa tepisima, prostirkama, podmetačima i krparama, linoleumom i drugim materijalima za oblaganje postojećih podova, zidova, ne od tekstila; usluge maloprodaje i veleprodaje, sve u vezi sa igrama, igračkama i stvarima za igranje, aparatima za video igre, gimnastičkim i sportskim proizvodima, ukrasima za novogodišnje jelke, svećanim ukrasima i vještačkim novogodišnjim jelkama; usluge maloprodaje i veleprodaje, sve u vezi sa aparatima za elektronske igre i zabavne aparate, osim onih prilagođenih za upotrebu sa spoljnim ekranom ili monitorom, kućnim aparatima za video igre i ručnim aparatima za video igre (nijedna nije za upotrebu sa televizijskim prijemnicima), božićnim čarapama, uredajima koji se drže u ruci za igranje elektronskih igara, kapama za zabave od papira, kapama za zabave od plastike, priborom za zabavu od papira; usluge maloprodaje i veleprodaje, sve u vezi sa mesom, ribom, živinom, divljači, vještačkim mesom, konzervisanim, smrznutim, sušenim i kuvanim voćem i povrćem, voćnim umacima, tofuom (bean curd), tofuom, supama, bujonima, želeima, džemovima, kompotom, jajima, pavlakom, mlijekom i mliječnim proizvodima, sojinim mlijekom, zamjenama za mlijeko, proizvodima napravljenim od mliječnih zamjena, jestivim uljima i mastima, očišćenim orašastim plodovima, sušenim orašastim plodovima, grickalicama, pripremljenim jelima, unaprijed spakovanom brzom hranom; usluge maloprodaje i veleprodaje, sve u vezi sa kafom, čajem, kakaom i vještačkom kafom, rižom, tjesteninama i rezancima, tapiokom i sagom, brašnom i preparatima od žitarica, hlebom, pecivima i konditorskim proizvodima, čokoladom, sladoledom, šerbetom, jestivim ledom, šećerom, medom, melasom, kvascem, prašakom za pecivo, solju, začинима, dodacima jelima, konzerviranim biljem, sirćetom, sosovima, začinama, ledom [smrznuta voda]; usluge maloprodaje i veleprodaje, sve u vezi sa zamjenama za kafu, napicima na bazi kafe, čajevcem i proizvodima čaja, napicima na bazi čaja, kakao prahom i proizvodima od kakaa, pićima na bazi čokolade, pekarskim proizvodima, picama, kremama, kolačićima u obliku mjeseca, štanglama koji sadrže mješavinu žitarica, orašastim plodovima i sušenim voćem [konditorski proizvodi], kolačićima, krekerima, kineskim tortama i tortama zapadnog stila, kineskim knedlama, pahuljicama badema; usluge maloprodaje i veleprodaje, sve u vezi sa sirovim i neobrađenim poljoprivrednim, akvakulturnim, hortikulturnim i šumarskim proizvodima, sirovim i neobrađenim žitaricama i sjemenkama, svježim voćem i povrćem, svježim travama, prirodnim biljem i cvijećem, lukovicama, sadnicama i sjemenom za sadnju, živim životinjama, hranom i pićem za životinje, slalom; usluge maloprodaje i veleprodaje, sve u vezi sa pivom, preparatima za pravljenje piva, mineralnim i gaziranim vodama i ostalim bezalkoholnim pićima i napicima, voćnim napicima i voćnim sokovima, sirupima i drugim bezalkoholnim preparatima za pravljenje pića, sokovima od povrća i napicima od povrća; usluge maloprodaje i veleprodaje, sve u vezi sa alkoholnim pićima (osim piva), alkoholnim preparatima za pravljenje napitaka, alkoholnim ekstraktima, alkoholnim esencijama; usluge maloprodaje i veleprodaje, sve u vezi sa duvanskim proizvodima i zamjenom za duvan, cigaretama i cigarama, elektronskim cigaretama i

oralnim isparivačima za pušače, artiklima za pušače, šibicama; sve gore pomenute maloprodajne i veleprodajne usluge koje se takode pružaju putem interneta, preko robnih kuća ili supermarketa, a takode omogućavaju kupcima da povoljno pregledaju i kupe ovu robu na opštoj prodajnoj veb stranici i u veleprodajnim outletima, putem opšteg prodajnog kataloga naručivanjem putem pošte ili telekomunikacija, kao i u maloprodajnim outletima; konsultantske, informativne i savjetodavne usluge koje se odnose na gore navedene usluge.

Klasa 36: Osiguranje; finansijski poslovi; novčani poslovi; poslovi vezani za nepokretnosti; kliring i uskladiavanje finansijskih transakcija putem globalne računarske mreže; usluge prenosa sredstava; prenos sredstava elektronskim putem za druge; prenos uplata za druge putem interneta; elektronske bankarske usluge; usluge onlajn plaćanja; pružanje usluga elektronskog transfera sredstava; brokerske usluge u vezi sa valutama; finansijske transakcije preko blokčejna; onlajn bankarske usluge i finansijske usluge; pružanje finansijskih informacija putem interneta; onlajn bankarstvo; bankarske usluge pružene onlajn sa računarskih baza podataka ili interneta; usluge finansijskog kliringa; kreditna verifikacija putem globalne računarske informacione mreže; elektronske usluge upravljanja rizikom kredita; usluge elektronskog plaćanja za kupovinu i elektronskog plaćanja računa; informativne usluge u vezi sa finansijama i osiguranjem, pružene onlajn sa računarske baze podataka ili interneta; usluge kreditnih kartica, obrada i prenos računa i uplata, i pružanje osiguranja za finansijske transakcije; finansijske usluge u oblasti usluga obrade računa i uplata; usluge depozita i usluge izdavanja putničkih vaučera; ulaganje kapitala; finansijske evaluacije [osiguranje, bankarstvo, nepokretnosti]; finansijske i usluge upravljanja aktivom; osiguranje i finansijske usluge; finansijske usluge pružene putem telekomunikacionih sredstava; finansijske konsalting i savjetodavne usluge; usluge posredovanja u prometu sa hartijama od vrijednosti, usluge notiranja cijena na berzi; posredovanje u vezi sa akcijama i obveznicama, finansijske analize; usluge debitnih kartica, usluge platnih kartica i usluge čekovne garancije; bankarske, usluge štednih računa i investicione usluge; zaduživanje finansijskih računa i kreditne usluge; izdavanje pretplatničkih kartica, platnih kartica i debitnih kartica; usluge telefonskih kreditnih kartica; organizovanje finansija za gradevinske projekte; organizovanje i upravljanje lizingom i zakupom; iznajmljivanje i lizing nepokretnosti; procjena nepokretnosti; valuacija nepokretnosti; finansijske usluge u vezi sa nepokretnostima, investiranje u nepokretnosti; brokerske usluge u vezi sa nepokretnostima; usluge agencija za nepokretnosti; usluge stambenih agencija; usluge aktuara; upravljanje nepokretnostima i konsalting usluge; ubiranje najamnine; iznajmljivanje kancelarija (nepokretnosti); iznajmljivanje apartmana i stanova; agencija za prikupljanje naknada za gas i električnu energiju; procjena antikviteta; procjena umjetničkih djela; procjena nakita; procjena polovnih vozila; snabdijevanje poreskim informacijama (finansijske usluge); prikupljanje priloga za dobrotvorne fondove; organizovanje dobrotvornog prikupljanja; dobrotvorno prikupljanje; iznajmljivanje mašina za brojenje papirnog novca i kovanica; iznajmljivanje bankomata ili automatizovanih mašina za izdavanje gotovine; izdavanje vaučera; usluge izdavanja gotovine; pružanje pretplatničkih kartica i žetona; usluge mijenjanja novca; usluge prenosa novca; usluge prenosa stranih valuta; usluge promjene strane valute; trgovanje valutama; poslovanje sa valutama; dobrotvorno prikupljanje sredstava; pužanje usluga dobrotvornog prikupljanja sredstava u vezi sa kompenzacijom ugljenika; brokerske usluge u vezi sa kompenzacijom ugljenika; sponzorisane programe kompenzacije ugljenika; finansiranje i ulaganje u projekte smanjenja emisije; ulaganje u programe i projekte kompenzacije ugljenika; ulaganje u fondove za smanjenje emisija; pružanje zajmova; pružanje privremenih zajmova; uključujući sve navedene usluge pružene elektronskim putem; konsultantske, informativne i savjetodavne usluge u vezi sa naprijed navedenim uslugama.

Klasa 38: Telekomunikacije; telekomunikacione usluge, naime usluge prenosa i prijema podataka putem telekomunikacionih mreža; pružanje usluga multimedijalnih telekonferencija, videokonferencija i sastanaka na web-u koji dozvoljavaju učesnicima da simultano i asinhrono pregledaju, dijele, ureduju i diskutuju dokumenta, podatke i slike putem veb pregledača; omogućavanje pristupa onlajn izvještajima u vezi sa

performansama, efikasnošću i statusom Internet aplikacija, telekonferencija, video konferencija i sastanaka za korisnike; omogućavanje korisnicima da bezbjedno pristupaju privatnim kompjuterskim mrežama na daljinu putem Interneta; pružanje onlajn usluga saradnje koje omogućavaju korisnicima da pristupaju aplikacijama, platformama, zajednički dijeljenim dokumentima, podacima, listama zadataka i forumima za diskusiju; pružanje pristupa računarskim bazama podataka na globalnoj računarskoj mreži za pretraživanje i vraćanje informacija, podataka, veb stranica i resursa koji su dostupni na računarskim mrežama; pružanje pristupa za korisnike kompjuterskim bazama podataka koje sadrže elektronske publikacije, biltene, baze podataka i informacije kojima se može pristupiti preko računara; upravljanje pričaonicama (usluge pričaonica); pristup za više korisnika globalnim kompjuterskim informacionim mrežama za transfer i prenos širokog opsega informacija; pružanje pristupa veb stranicama na globalnoj računarskoj mreži putem koje treća lica mogu da nude robe i usluge, prave i popunjavaju porudžbine, sklapaju ugovore i vrše poslovne transakcije; pružanje pristupa interaktivnoj veb stranici na globalnoj računarskoj mreži za treća lica da postavljaju informacije, odgovaraju na zahtjeve i prave i popunjavaju porudžbine za proizvode, servise i poslovne prilike; elektronske komunikacijske usluge za uspostavljanje virtualnih pričaonica putem tekstualnih poruka; pružanje elektronskih biltena za postavljanje i prenos poruka između računarskih korisnika u vezi sa proizvodima, uslugama i poslovnim prednostima i prilikama; pružanje elektronskih biltena za postavljanje, promociju, prodaju i preprodaju robe putem globalne računarske mreže; pružanje usluga elektronske pošte i prosljeđivanja elektronske pošte; audio i video komunikacija putem računara i računarskih mreža i putem globalne komunikacione mreže; pružanje računarskog pristupa i iznajmljivanje vremena za pristup interaktivnim biltenima i bazama podataka; pružanje pristupa elektronskim biltenima za postavljanje i prenos poruka između računarskih korisnika u vezi sa proizvodima, uslugama i poslovnim prilikama; pružanje pristupa elektronskom kalendaru, adresaru i elektronskoj bilježnici putem lokalne i globalne računarske mreže; pružanje usluga direktne konekcije između korisničkih računara za razmjenu podataka; pružanje telekomunikacionih pristupa i veza sa internetom i računarskim bazama podataka; usluge emitovanja preko interneta; pružanje onlajn baza podataka koje sadrže informacije o internet platformi za podnošenje žalbi u vezi sa emitovanjem programa; pružanje telekomunikacionog pristupa i veze sa računarskom bazom podataka i sa internetom; elektronske komunikacione usluge; interaktivne telekomunikacione usluge; telekomunikacije u vezi sa informacijama (Internet stranice), kompjuterskim programima i podacima; pružanje telekomunikacionih veza sa internetom ili bazama podataka; pružanje telekomunikacionog pristupa objektima i strukturama na internetu; komunikacija putem računarskih terminala; komunikacija putem mreža sa optičkim vlaknima; računarski potpomognut prenos poruka, informacija, podataka, dokumenata i slika; usluge komunikacije podacima elektronskim putem; elektronska razmjena glasa, podataka, audio, video sadržaja, teksta i grafike kojima se može pristupiti putem računara i telekomunikacionih mreža; usluge trenutnog slanja poruka; komunikacione usluge putem mobilnih telefona; sakupljanje, prenos i dostavljanje podataka elektronskim putem; sakupljanje, prenos i dostavljanje elektronskih poruka, informacija u vidu nepomičnih i/ili pokretnih slika kao što su karakteri, poruke, muzika i slike, telegrami, informacije i podaci putem mehaničkih, elektronskih, telefonskih, teleks, kablovskih, računarskih i satelitskih sredstava; prenos, emitovanje i prijem audio, video, nepomičnih i pokretnih slika i podataka u kompresovanom ili nekompresovanom obliku u realnom ili odloženom vremenu; usluge elektronskih poruka, konferencija i prenosa naloga; usluge video konferencija; komunikacija putem elektronskih biltena koji omogućava korisnicima da obavljaju interaktivne razgovore u realnom vremenu između računarskog terminala i elektronskog biltena koji sadrži informacije sa nepomičnim i pokretnim slikama i glasovne informacije kao što su karakteri; pružanje elektronskih biltena i oglasnih tabli za prenos poruka; pružanje usluga onlajn foruma za diskusije; komunikacione usluge, naime, usluge tekstualnih i numeričkih digitalnih poruka; prenos informacija komunikacijom podataka radi pomoći pri donošenju odluka; prenos informacija kroz sisteme za video komunikaciju; usluge veb konferencija; pružanje pristupa i

prostora za video i/ili telefonske konferencije na daljinu; savjetodavne usluge u oblasti zaštite podataka i usluge prenosa informacija; pružanje veza za elektronske podatke; prenos putem faksimila; slanje poruka; pejdžing usluge; iznajmljivanje modema; iznajmljivanje telekomunikacione opreme; usluge elektronskog slanja, primanja i prosljeđivanja poruka; usluge televizijskog emitovanja; emitovanje i prenos radio i televizijskih programa; emitovanje muzike; prenos muzičkih, filmskih, interaktivnih programa, videa, elektronskih računarskih igara; prenos informacija u vezi sa onlajn kupovinom i opštim uslugama maloprodaje; usluge prenosa videa po zahtjevu; usluge novinskih agencija; konsultacije, informacije i savjetodavne usluge u vezi sa gore navedenim uslugama.

Klasa 39: Transport; pakovanje i skladištenje robe; aranžmani putovanja; fizičko skladištenje elektronski pohranjenih podataka ili dokumenata; skladištenje elektronski pohranjenih podataka ili dokumenata; informacije o prevozu; transportno posredovanje; transportna logistika; prevoz robe i putnika; pakovanje; posredovanje u vezi sa brodovima (posredovanje u vezi sa pomorskim transportom); auto prevoz; avio prevoz; prevoz blindiranim automobilima; iznajmljivanje vozila; dostavljanje poruka; transport cjevovodom; dostavljanje robe po porudžbini; kurirske usluge [dostava pošiljki ili robe]; transportne usluge u vezi upravljanja transportom; usluge iznajmljivanja automobila; usluge parkiranja vozila; putovanja jahtom i/ili brodovima; usluge putničkih agencija; usluge putničkih rezervacija i putničkih informacija; usluge agencije u vezi sa putničkim kartama; organizovanje putovanja i informacije za njih, sve pruženo onlajn sa kompjuterske baze podataka ili interneta; pružanje informacija koje se odnose na putovanja i turizam putem interneta ili putem telekomunikacijskih mreža; pružanje uputstava za vožnju za potrebe putovanja; organizovanje krstarenja; organizovanje prevoza za turistička putovanja; rezervacija sjedišta za putovanje; pratnja putnika; usluge prevoza za turistička razgledanja; organizovanje usluga prevoza putika za druge putem onlajn aplikacije; putničke rezervacije; pružanje informacija o putevima i saobraćaju, usluge vozača; utovar i istovar tereta; posredovanje u prevozu robe; selidbene usluge; posredovanje u iznajmljivanju, lizingu; prodaji; kupovini i/ili čarteru brodova i/ili čamaca; spasavanje i podizanje potopljenih brodova i/ili čamaca; pilotiranje; distribucija gasa i snabdijevanje; distribucija električne struje i snabdijevanje; distribucija toplote i snabdijevanje; snabdijevanje vodom; distribucija vode i snabdijevanje; usluge objekata za sidrenje; iznajmljivanje skladišta; pružanje područja za letenje; obezbjeđivanje pristupa putevima na kojima se plaća putarina; iznajmljivanje i/ili lizing invalidskih kolica; usluge parkiranja automobila; upravljanje parking prostorom; iznajmljivanje i/ili lizing aviona; iznajmljivanje i/ili lizing kontejnera; iznajmljivanje i/ili lizing bicikala; iznajmljivanje i/ili lizing automobila; iznajmljivanje i/ili lizing brodova i/ili čamaca; iznajmljivanje i/ili lizing vozila na ljudski pogon; iznajmljivanje i/ili lizing mehaničkih parking sistema; iznajmljivanje i/ili lizing paleta; iznajmljivanje i/ili lizing mašina za pakovanje i umotavanje; iznajmljivanje i/ili lizing komora za hladenje; skupljanje otpada i smeća iz domaćinstva; skupljanje industrijskog otpada i smeća; iznajmljivanje navigacionih sistema; iznajmljivanje vazduhoplova; dopunjavanje bankomata gotovinom; usluge vozača; prikupljanje recikliranih proizvoda [transport]; isporuka robe; dostava novina; isporuka energije; isporuka cvijeća; frankiranje pošte; brodski prevoz robe; iznajmljivanje garaža; pakovanje poklona; iznajmljivanje konja; lansiranje satelita za druge; skladištenje prtljaga; iznajmljivanje putničkih autobusa; isporuka pošiljki; iznajmljivanje parking mjesta; iznajmljivanje prostorija za hladenje; iznajmljivanje zamrzivača; iznajmljivanje trkačkih automobila; iznajmljivanje kontejnera za skladištenje; iznajmljivanje traktora; iznajmljivanje prtljažnika za krov na vozilima; iznajmljivanje invalidskih kolica; dopunjavanje automata za prodaju; spasilačke operacije [u transportu]; usluge spašavanja [transport]; taksi prevoz; tegljenje; informacije o saobraćaju; rezervacija prevoza; pakovanje; konsultantske, informativne i savjetodavne usluge u vezi sa naprijed navedenim uslugama.

Klasa 41: Obrazovanje; pružanje obuke; zabava; sportske i kulturne aktivnosti; izdavanje tekstova, knjiga i časopisa (osim reklamnih tekstova); izdavanje dijagrama, slika i fotografija; izdavanje novina, magazina i periodičnih publikacija; usluge obrazovanja, vežbe i pružanja obuka u vezi sa telekomunikacijama,

računarima, računarskim programima, računarstvom u oblaku, dizajnom veb sajtova, elektronskom trgovinom, poslovnim upravljanjem, finansijskim upravljanjem i oglašavanjem; pružanje obrazovanja, rekreacije, instrukcija, podučavanja i obuke interaktivno i neinteraktivno; dizajn obrazovnih kurseva, ispita i kvalifikacija; zabava pružena putem elektronskih i digitalnih interaktivnih medija; usluge elektronskih igara pružene putem interneta; pružanje informacija u vezi sa obrazovanjem, obukom, zabavom, rekreacijom, sportskim, društvenim i kulturnim aktivnostima; pružanje onlajn elektronskih publikacija (koje se ne mogu preuzimati); priređivanje, organizovanje, hosting i vodenje pjevačkih takmičenja; priređivanje, organizovanje, hosting i vodenje koncerta; priređivanje, organizovanje, hosting i vodenje događaja i takmičenja za obrazovne i zabavne potrebe; priređivanje, organizovanje, hosting i vodenje zabavnih igara i potraga; usluge agencija u vezi sa kartama za zabavne događaje; informacije u vezi sa zabavom ili obrazovanjem, koje se pružaju onlajn sa računarske baze podataka ili interneta; pružanje digitalne muzike (koja se ne može preuzimati) sa interneta; pružanje digitalne muzike (koja se ne može preuzimati) sa MP3 (Moving Picture Experts Group1 audio layer 3) Internet veb-sajtova; pružanje video igara, računarskih igara, zvuka ili slika, ili filmova putem telekomunikacionih ili računarskih mreža; pružanje onlajn računarskih igara i takmičenja; pružanje onlajn videa, koji se ne mogu preuzimati; pružanje onlajn elektronskih publikacija koje se strimuju sa interneta ili računarske meže ili računarske baze podataka; zabavne i obrazovne usluge u vezi sa planiranjem, proizvodnjom i distribucijom zvuka, slika, digitalne muzike, filmova, uživo ili snimljenih audio, vizuelnih ili audiovizuelnih materijala za emitovanje na zemaljskim kanalima, satelitskim kanalima, internetu, bežičnim ili sistemima žične veze i drugim vidovima komunikacija; usluge muzičke zabave; iznajmljivanje audio snimaka; pripremanje zabavnih, obrazovnih, dokumentarnih programa i vijesti za emitovanje; usluge reporterskog izveštavanja; informacije u vezi sa sportskim i kulturnim događajima, aktuelnim događajima i najvažnijim vijestima pružene putem televizijskog satelitskog prenosa, interneta ili drugih elektronskih načina; televizijska, radio i filmska produkcija; pripremanje i produkcija televizijskih programa; pružanje informacija, podataka, grafike, zvuka, muzike, videa, animacije i tekstova za zabavne potrebe; usluge igara; pružanje klupske rekreacije, sportskih i gimnastičkih objekata; nastupi muzičkih sastava; klupska zabava, diskoteke, modne revije i usluge noćnih klubova; klupske usluge u vezi sa zabavom, obrazovanjem i kulturnim aktivnostima; organizovanje, vodenje i pružanje konferencija, konvencija, kongresa, seminara i radionica obuke; organizovanje, vodenje i pružanje konferencija, konvencija, kongresa, seminara i radionica obuke u vezi sa telekomunikacijama, računarima, računarskim programima, računarstvom u oblaku, dizajnom veb sajtova, elektronskom trgovinom, poslovnim upravljanjem, finansijskim upravljanjem i oglašavanjem; organizovanje i vodenje izložbi za kulturne i obrazovne potrebe, modnih revija, obrazovnih programa i kulturnih programa i predstava; umjetničke izložbe i usluge galerija; usluge umjetničkih galerija u vezi sa lizingom umjetničkih djela; usluge obuke u vezi sa zdravljem i bezbjednošću na radu i održavanjem okoline; organizovanje časova u vezi sa cigarama, časova degustacije vina; pružanje obrazovnih informacija u vezi sa istraživanjem materijala i agencija za iste; aranžman, organizovanje, planiranje i upravljanje seminarima; obuka životinja; uputstva u produkciji programa za emitovanje; usluge instrukcija u vezi sa upravljanjem mašinama i opremom, uključujući audiovizuelnu opremu koja se koristi za produkciju programa za emitovanje; pružanje audio i vizuelnih studija; pružanje sportskih objekata; pružanje objekata za filmove, priredbe, predstave, muzičke ili obrazovne treninge; usluge agencija za rezervisanje zabavnih događaja; iznajmljivanje i lizing filmova; iznajmljivanje i lizing muzičkih instrumenata; iznajmljivanje i lizing televizijskih programa; iznajmljivanje i lizing televizijskih setova; usluge biblioteka; arhivske usluge biblioteka; usluge titlovanja; prevodilačke usluge za znakovni jezik; iznajmljivanje prethodno snimljenih video traka; iznajmljivanje i lizing mašina za igru; pozajmljivanje opreme za arkadne igre; pozajmljivanje slika; fotografisanje; prevodenje; usluge tumača; obrazovni i programi obuke u oblasti upravljanja rizikom; obrazovni i programi obuke u vezi sa sertifikacijom; pružanje vijesti; usluge igara na sreću; podučavanje; konsultantske, informativne i savjetodavne usluge u vezi sa

prethodno navedenim uslugama.

Klasa 42: Naučne i tehnološke usluge i istraživanja i projektovanja u vezi sa njima, usluge industrijskih analiza i istraživanja; projektovanje i razvoj računarskog hardvera i softvera; istraživanje i razvoj u vezi sa poluprovodnicima, poluprovodničkim integrisanim kolima, poluprovodničkim memorijskim čipovima, poluprovodničkim memorijskim kontrolerima, poluprovodničkim memorijskim integrisanim kolima, poluprovodničkim procesorskim čipovima, poluprovodničkim procesorima, mikrokontrolerima, jedinicama mikrokontrolera, mikrokontrolerima male snage, čipovima kola, kompjuterskim čipovima, CPU (centralnim procesorskim jedinicama), RISC-V kompjuterskim čipovima i centralnim procesorskim jedinicama, kompjuterskim čipovima i centralnim procesorskim jedinicama sa arhitekturom skupa instrukcija; softver u vidu servisa (SaaS); računarske usluge u vezi sa prenosom informacija, podataka, dokumenata, i slika putem interneta; usluge provajdera aplikacija (ASP), naime, hosting računarskih softverskih aplikacija za druge; usluge provajdera aplikacija (ASP) pružanje softvera u oblasti veb zasnovanih konferencija, audio konferencija, elektronskih poruka, kolaboracije dokumenata, video konferencija, i obrade glasa i poziva; pružanje onlajn softvera koji se ne mogu preuzimati za olakšavanje interoperabilnosti više softverskih aplikacija; usluge tehničke podrške (tehničke konsultacije) u vezi sa računarskim softverom i aplikacije pružene onlajn, putem email-a i telefona; računarske usluge, naime kreiranje onlajn zajednice za registrovane korisnike da učestvuju u raspravi, dobiju povratnu informaciju od svojih vršnjaka, formiraju virtuelne zajednice, učestvuju u društvenim mrežama i razmenjuju dokumenta; savjeti o računarskim tehnologijama pruženi internet korisnicima putem telefonske podrške; računarske usluge u vezi sa kreiranjem indeksa informacija, stranica i izvora na računarskoj mreži; pružanje alata za pretraživanje na internetu; dizajn računara, noutbuk računara, laptop računara, prenosivih računara i ručnih računara; dizajn ličnih digitalnih asistenata i ličnih media plejera; dizajn mobilnih telefona i pametnih telefona; dizajn digitalnih kamera; računarske usluge; računarsko programiranje; računarske integracione usluge; usluge računarske analize; računarsko programiranje u vezi sa odbranom od virusa; usluge računarskog sistemskog softvera; dizajn računarskog softvera; dizajn računarskih sistema; dizajn i razvoj veb stranica; hosting veb stranica za druge; hosting softver računarskih aplikacija za pretraživanje i vraćanje informacija iz baze podataka i računarske mreže; pružanje tehničkih informacija po posebnom zahtjevu krajnjih korisnika putem telefona ili globalne računarske mreže; konsultantske usluge u vezi sa računarskim softverom; računarske usluge u vezi sa prilagodenim pretraživanjem računarske baze podataka i veb sajtova; računarsko i elektronsko kodiranje i dekodiranje signala; konverzija fizičkih podataka i dokumenata u elektronske medijske formate; testiranje proizvoda i usluge procjene; arhitektonske i usluge dizajna; dizajn enterijera zgrada, kancelarija i apartmana; usluge kompjuterskih informacija; usluge mrežnih informacija, naime, pružanje tehničkih informacija u vezi sa računarima i mrežama u oblasti biznisa i elektronske trgovine; pružanje računarskih programa za upravljanje rizikom bezbjednosti; usluge računarskih bezbjednosnih informacija, znanje i usluge testiranja; usluge osiguranja kvaliteta; računarske usluge u vezi sa sertifikacijom poslovnih transakcija i pripremanje izvještaja u vezi sa njima; računarske bezbjednosne usluge u vezi sa kontrolom pristupa računarima, elektronskim mrežama i bazama podataka; obezbjeđivanje prenosa podataka i transakcija putem računarskih mreža; konsultantske usluge u vezi sa područjem bezbjednosti podataka; tehnološke konsultacije u vezi sa bezbjednošću telekomunikacija; bezbjednosne usluge kompjuterizovanih komunikacionih mreža; pružanje informacija u oblasti interneta, svjetske mreže/www i bezbjednosti kompjuterizovanih komunikacionih mreža i bezbjednog prenosa podataka i informacija; konsultantske usluge u oblasti interneta, svjetske mreže/www i bezbjednosti kompjuterizovanih komunikacionih mreža, usluge bezbjednosti informacija; usluge autentifikacije za bezbjednost računara; računarske usluge u vezi sa onlajn autentifikacijom elektronskih potpisa; pohranjivanje rezervnih podataka van glavne lokacije (off-site); pružanje informacija na računarskim tehnologijama i programiranje putem veb sajta; kartografske usluge; računarstvo u oblaku; usluge hosting

provajdera oblaka; pružanje privremene upotrebe softvera u oblaku koji se ne može preuzimati i softvera za računarstvo u oblaku; elektronsko skladištenje podataka; pružanje virtuelnih računarskih sistema i virtuelne računarske sredine putem računarstva u oblaku; iznajmljivanje softvera za zabavu; pružanje onlajn kompjuterskih softvera i kompjuterskih aplikacija koje se ne mogu preuzimati za striming audio materijala, video materijala, videa, muzike i slika; konsultantske, informativne i savjetodavne usluge u vezi sa naprijed navedenim uslugama.

(210) **Ž-2019-413**

(220) 29.10.2019.

(731) The Coca-Cola Company, One Coca-Cola Plaza, 30313, Atlanta, Georgia, US



(540)

(550) I

(740) Miladin Popović, Đoka Miraševića 21/III, 81000, Podgorica

(511) Klasa 9 Softver uključujući softver za medije, prijavljivanje i objavljivanje, softver za komunikaciju i umrežavanje; medijski sadržaj; snimljeni sadržaj; baze podataka; elektronske publikacije; mediji, zvuk, slike i podaci snimljeni i koji se mogu preuzimati.

Klasa 32 Pića, uključujući vode za piće, vode sa ukusom, mineralne i gazirane vode; ostala bezalkoholna pića, uključujući osvježavajuća bezalkoholna pića, energetska pića i pića za sportiste; voćni napici i sokovi uključujući kokosovu vodu; sirupi, koncentрати, praškovi i drugi preparati za pripremu pića, uključujući vode sa ukusom, mineralne i gazirane vode, osvježavajuća bezalkoholna pića, energetska pića, pića za sportiste, voćne napitke i sokove; napici i sokovi od povrća.

Klasa 41: Usluge razonode; usluge razonode koje se pružaju on-line putem računarskih baza podataka i / ili putem interneta; elektronske publikacije koje se mogu preuzimati; elektronske knjige; elektronske baze podataka; usluge razonode; usluge razonode u obliku pružanja elektronskih, računarskih i video igara putem interneta i drugih uređaja za daljinsku komunikaciju; usluge razonode u obliku pružanja virtualnih igara i usluga razonode putem interneta i drugih uređaja za daljinsku komunikaciju; internet igre (koje se ne mogu preuzimati); usluge pružanja elektronskih igara, slagalica i takmičenja putem interneta i drugih uređaja za daljinsku komunikaciju; produkcija audio, video i audio / video zapisa; produkcija filmova, animiranih filmova, crtanih filmova, radio programa i televizijskih programa; usluge razonode uživo; organizovanje i sprovođenje igara, takmičenja i zabavnih događaja; pružanje informacija u vezi sa razonodom i zabavom.

(210) **Ž-2019-414**

(220) 29.10.2019.

(731) The Coca-Cola Company, One Coca-Cola Plaza, 30313, Atlanta, Georgia, US

STUDI 

(540)

(550) I

(740) Miladin Popović, Đoka Miraševića 21/III, 81000, Podgorica

(511) Klasa 9: Softver uključujući softver za medije, prijavljivanje i objavljivanje, softver za komunikaciju i umrežavanje; medijski sadržaj; snimljeni sadržaj; baze podataka; elektronske publikacije; mediji, zvuk, slike i podaci snimljeni i koji se mogu preuzimati.

Klasa 32: Pića, uključujući vode za piće, vode sa ukusom, mineralne i gazirane vode; ostala bezalkoholna pića, uključujući osvježavajuća bezalkoholna pića, energetska pića i pića za sportiste; voćni napici i sokovi uključujući kokosovu vodu; sirupi, koncentрати, praškovi i drugi preparati za pripremu pića, uključujući vode sa ukusom, mineralne i gazirane vode, osvježavajuća bezalkoholna pića, energetska pića, pića za sportiste, voćne napitke i sokove; napici i sokovi od povrća.

Klasa 41: Usluge razonode; usluge razonode koje se pružaju on-line putem računarskih baza podataka i / ili putem interneta; elektronske publikacije koje se mogu preuzimati; elektronske knjige; elektronske baze podataka; usluge razonode; usluge razonode u obliku pružanja elektronskih, računarskih i video igara putem interneta i drugih uređaja za daljinsku komunikaciju; usluge razonode u obliku pružanja virtualnih igara i usluga razonode putem interneta i drugih uređaja za daljinsku komunikaciju; internet igre (koje se ne mogu preuzimati); usluge pružanja elektronskih igara, slagalica i takmičenja putem interneta i drugih uređaja za daljinsku komunikaciju; produkcija audio, video i audio / video zapisa; produkcija filmova, animiranih filmova, crtanih filmova, radio programa i televizijskih programa; usluge razonode uživo; organizovanje i sprovođenje igara, takmičenja i zabavnih događaja; pružanje informacija u vezi sa razonodom i zabavom.

(210) **Ž-2019-415**

(220) 30.10.2019.

(731) International Foodstuffs Co LLC, P.O. Box No. 4115, Sharjah, AE

(540) AMBER

(550) I

(740) Miladin Popović, Đoka Miraševića 21/III, 81000, Podgorica

(511) Klasa 29: Jestiva ulja, masti, topljeno maslo, margarin, maslac, proizvodi za supu, mlijeko i mliječni proizvodi, mlijeko s ukusom, mliječni šejkovi, meso, riba, živina i divljač, mesni ekstrakti, konzervisano, sušeno i kuvano voće i povrće, prelive svih vrsta i opisa uključujući ne-mliječne prelive, slatka pavlaka, želei, džemovi, kompoti, jaja, grickalice na bazi krompira i bez krompira, čips od krompira i listići od krompira, sve vrste konzervisanog i osušenog sočiva, pasulja, graška i mahunarki (ne za poljoprivredne namjene), pečurke, konzervisani kikiriki.

Klasa 30: Čokolade, slatkiši, bombone, biskviti (svi tipovi), kolači, tjestenine, makaroni, rezanci, instant rezanci, špageti, rezanci za supu, kvasac, prašak za pecivo i ostali pekarski sastojci, prelive za salate, majonez, sirće, kečap i sosovi (začini), polu- gotovi proizvodi od tijesta, smrznuto tijesto, smrznute parate, sladoledi, ne- mliječni smrznuti deserti, smrznuti voćni deserti, ledeni deserti, kafa, čaj, kakao, šećer, pirinač, tapioka, sago, zamjena za kafu, hleb, pecivo, melasa, so, senf, brašno od žitarica, začini, prehrambena pića (proizvodi na bazi zrnavlja i bilja), umaci, biljni čaj, med.

(210) **Ž-2019-417**

(220) 31.10.2019.

(731) ETI GIDA SANAYI VE TICARET ANONIM SIRKETI, Organize Sanayi Bolgesi 11., Cadde Eskisehir, TR

(540)



(550) I

(740) Miladin Popović, Đoka Miraševića 21/III, 81000, Podgorica

(511) Klasa 30: Kafa, kakao, napici na bazi kafe ili kakaa, napici na bazi čokolade, makaroni, mesne pite, vermičeli, poslastičarski i pekarski proizvodi, hljebovi, deserti, med, pčelinji vosak, propolis, arome za hranu, kvasac, prašak za pecivo, prirodni preparati za poboljšanje oblika i boje proizvoda od brašna i njihovo konzerviranje, bilo koje vrste brašna, griz, škrob, šećer, šećer u kocke, šećer u prahu, čaj, ledeni čajevi, konditorski proizvodi, čokolade, keksi, peciva, krekeri, vafli, kolači, tartovi, žvakaće gume, sladoledi, jestivi led, so, žitarice i njihovi proizvodi.

(210) **Ž-2019-422**

(220) 31.10.2019.

(731) AL ATHEED GENERAL TRADING L.L.C, P.O.BOX 27142, DEIRA, AL-RASS, DUBAI, AE



(540)

(550) I

(740) Božidar S. Radulović, Studentska bb, Lamela 3/18, 81000, Podgorica

(511) Klasa 29: Meso, riba, živina i divljač; ekstrakti od mesa; konzervisano, sušeno i kuvano voće i povrće; žele, džemovi, kompoti; jaja, mlijeko i mliječni proizvodi; jestiva ulja i masti.

Klasa 30 Kafa, čaj, kakao i vještačka kafa; pirinač, tapioka i sago; brašno i proizvodi od žitarica; hleb, peciva i konditorski proizvodi; ledene poslastice; med, melasa; kvas, prašak za pecivo; so; senf; sirće, sos (začini); začini; led.

Klasa 32: Piva; mineralne i gazirane vode i druga bezalkoholna pića; voćni napici i voćni sokovi; sirupi i drugi preparati za pravljenje pića.

(210) **Ž-2019-424**

(220) 04.11.2019.

(731) Boris Rašković, ul.Jovana Tomaševića br.9, Podgorica, ME

(540) MAČAK

(550) I

(740) AOD "Ćupić", Bulevar Džordža Vašingtona 79, 81000, Podgorica

(511) Klasa 29: Meso, riba, živina i divljač; mesni ekstrakti; konzervirano, sušeno i kuvano voće i povrće; želei, džemovi, kompoti; jaja, mlijeko i mliječni proizvodi; jestiva ulja i masti.

Klasa 31: Poljoprivredni, povrtlarski, šumski proizvodi i bobice, koji nisu obuhvaćeni drugim klasama; žive životinje; svježe voće i povrće; sjeme, prirodne biljke i cvijeće; hrana za životinje; slad.

Klasa 33: Alkoholna pića (osim piva).

(210) **Ž-2019-426**

(220) 05.11.2019.

(731) Domaća trgovina doo Podgorica, Ul.Josipa Broza Tita br.23a, 81000, Podgorica, ME

(540) OPUŠTENO

(550) I

(740) Goran Živković, ul. Petra Zvicera br.11, Podgorica

(511) Klasa 3: Bademovo ulje; bademov sapun; štirak za sjaj veša; štirak za pranje veša; štirak za veš; sapun*; sapun za izbeljivanje tekstila; plavilo za veš; etarsko ulje anisa; kozmetički preparati za kupanje sapun za brijanje; vatirani štapići za kozmetičke svrhe; pamučni štapići za kozmetičku upotrebu; kozmetičke maske; bergamot ulje; soli za izbeljivanje soda za izbeljivanje belila za veš; mirišljivo drvo; preparati za ispiranje usta, koji nisu medicinski; lak za nokte; preparati za šminkanje; losioni za kosu*; kreme za cipele; boje za kosu; preparati za kovrdžanje kose; preparati za čišćenje, poliranje; preparati za poliranje; vosak za cipele; sredstva za poliranje nameštaja i podova; preparati za sjaj [poliri]; obućarski vosak; vosak za parket; vosak za poliranje; etarska ulja limuna; kolonjska voda; boje za toaletnu upotrebu; preparati za zaštitu kože [poliranje]; preparati za očuvanje kože [poliranje]; kozmetički setovi; kozmetika; pamučna vuna za kozmetičku upotrebu; kreda za čišćenje; preparati za uklanjanje mrlja; kozmetičke olovke; kreme za poliranje; kozmetičke kreme; soda za pranje, čišćenje; paste za brijanje; kreme za kožne proizvode; vosak za kožne proizvode; deterdženti, koji nisu za upotrebu u proizvodnim procesima i za medicinsku upotrebu; rastvori za čišćenje; proizvodi za odmašćivanje, koji nisu za upotrebu u procesu proizvodnje; preparati za uklanjanje šminke sredstva za čišćenje zuba [paste, gelovi, tečnosti]*; preparati za uklanjanje kamenca za upotrebu u domaćinstvu; dijamantin, boraks [arbaziv] antistatički preparati za kućnu upotrebu; preparati za uklanjanje laka; preparati za uklanjanje boje odstranjivači laka; mirišljave vode; toaletne vode; preparati za depilaciju; vosak za depilaciju; preparati za natapanje u perionicama; etarske esencije; etarska ulja; etarska ulja; ekstrakti cveća [parfemi]; šminka; preparati za čišćenje; baze za cvetne parfeme; fumigacijska sredstva [parfemi]; arome za kolače [etarska ulja]; ulja za kozmetičku upotrebu; jasmínovo ulje; ulje od lavande; ulja za čišćenje; ulja za parfeme i mirise; ružino ulje; toaletna ulja; losioni za kozmetičku upotrebu; mleko za čišćenje za toaletnu upotrebu; preparati za pranje; toaletni proizvodi [sredstva za ličnu higijenu]*; preparati za štirkanje; mirisna menta [etarsko ulje]; menta za parfimerijske proizvode kozmetika za obrve; šamponi*; parfemi; preparati za negu noktiju; parfimerija; kozmetički preparati za negu kože; sapun protiv znojenja nogu; kamen za poliranje; pomade za kozmetičku upotrebu; puder za šminkanje; preparati za brijanje; dezodorantni sapun; kesice sa mirisom za rublje; safrol; komadi toaletnog sapuna; komadi sapuna; olovke za izvlačenje obrva; talk puder, za toaletnu upotrebu; kozmetičke boje; krpe za poliranje; stakleno platno [abrazivno platno]; preparati protiv znojenja; sapun protiv znojenja; tripoli kamen za poliranje; abrazivi; bademovo mleko za kozmetičku upotrebu; preparati za uklanjanje rđe; preparati za sunčanje [kozmetički]; aromatična ulja [etarska ulja]; arome za pića [etarska ulja]; hemikalije za osvežavanje boja za upotrebu u domaćinstvu [pranje veša]; soli za kupanje koje nisu za medicinsku upotrebu; kozmetički preparati; preparati za uklanjanje boja; dezodoransi za ljude ili životinje; dekorativne nalepnice za kozmetičku upotrebu; astringentna sredstva; preparati za beljenje [skidanje boje] za kozmetičku upotrebu; oplemenjivači rublja za upotrebu u perionicama; preparati za otčepljivanje odvodnih cevi; šamponi za kućne ljubimce [nemedicinski preparati za negu]; maramice natopljene sa kozmetičkim losionima; sredstva za lepljenje za kozmetičku upotrebu; losioni posle brijanja; lakovi za kosu; maskare; potpuri [mirisi]; sprejevi za osvežavanje daha; preparati za hemijsko čišćenje; odstranjivači voska sa poda [sredstva za odstranjivanje]; neklizajući vosak za podove; neklizajuće tečnosti za podove; vazduh konzerviran pod pritiskom, za čišćenje i uklanjanje prašine; gelovi za izbeljivanje zuba; krpe namočene deterdžentom za čišćenje; preparati za sjaj; lišća biljaka; mirisni štapići; sredstva za sušenje sudova u mašinama za sudove; preparati za parfimisanje

vazduha; trake za osvežavanje daha; dezodoransi za kućne ljubimce; preparati za tuširanje za ličnu higijenu i dezodorisanje [toaletni proizvodi]; preparati od aloe vere za kozmetičke namene; sjajevi za usne; balzami, osim za medicinske svrhe; šamponi za suvo pranje*; preparati za sunčanje; etarsko ulje limuna kana [kozmetička boja]; sredstva za čišćenje obuće; preparati za kupanje, ne za medicinske svrhe; balzami za kosu; proizvodi za ispravljanje kose; maramice natopljene preparatima za skidanje šminke; preparati kolagena za kozmetičke svrhe; trake za izbeljivanje zuba; arome za hranu [etarska ulja]; fitokozmetički preparati; sredstva za čišćenje za intimnu ličnu higijenu, nemedicinska; biljni ekstrakti za kozmetičke namene; sredstva za odstranjivanje laka za nokte; sredstva za uklanjanje laka za nokte; vosak za podove; šamponi za životinje [nemedicinski preparati za negu]; sredstva za ispiranje očiju, ne za medicinske namene; sredstva za vaginalno ispiranje za ličnu higijenu ili dezodorisanje; hemijski preparati za čišćenje za upotrebu u domaćinstvu; raspršivači od trske za osvežavanje vazduha; preparati za beljenje [uklanjanje boja] za upotrebu u domaćinstvu; kozmetika za decu; preparati za osvežavanje daha za ličnu higijenu; maramice za bebe natopljene preparatima za čišćenje; basma [kozmetička boja]; gel jastučići za oči za kozmetičke namene.

Klasa 16: Nosači lepljivih traka [kancelarijski pribor]; papir; posteri; oglasni panoi od papira ili kartona; spajalice [kancelarijski pribor]; klipse za olovke heftalice [kancelarijski rekvizit]; beležnice, notesi; albumi; slike; štampani materijal [viskoka štampa]; trake za cigare, za uvijanje cigareta; mašine za oštrenje olovaka, elektronske ili neelektronske podupirači za knjige; vodene boje [slikarske]; vodene boje, slikarske; akvarel boje; fascikle za spise [kancelarijski pribor]; tablice za pisanje; pisaljke za tablice; srebrni papir; olovke; novine; periodične publikacije; atlas; uložne mape sa prstenovima; registratori sa prstenovima; gumirane trake [kancelarijski materijal]; podmetači za pivske čaše; ulaznice; kliše; blokovi za crtanje blokovi [kancelarijski materijal]; kalemi za trake sa mastilom; manžetne za držanje pribora za pisanje; pamfleti; špenadle kao kancelarijski materijal; čiode kao kancelarijski materijal; ovlaživači vrhova prstiju [kancelarijski pribor]; jastučići za mastilo; vosak za pečačenje; sveske; obrasci za precrtavanje; paus papir; štamparska slova; karbon papir; papir za mašine za snimanje; beležnice; ugaoni lenjiri za crtanje; karte; materijal za obuku [izuzev aparata]; listovi papira [kancelarijski] karton; tube od kartona; katalozi; metalni vrh za indeksne karte; spojeni ramovi [štamparski]; omoti za papir; košuljice za spise; brojevi [štamparski]; indijsko mastilo; fascikle [kancelarijski materijal]; bušilice za papir [zumba]; higijenski papir; toalet papir; knjige; šestari za crtanje; štamparski brojevi i slova; slova, štamparska; kompozeri za slaganje; posude za pisma; konusne papirne kese; korektivna tečnost [kancelarijski rekvizit]; korektivno mastilo [heliografsko]; grafitne mine za olovke; kreda za pisanje; držači olovaka; olovke sa grafitnom minom [tehničke olovke]; papirne kutije za krem; table za crtanje; materijali za crtanje; instrumenti za crtanje; kutije za olovke; proizvodi za brisanje; materijali za pisanje; štيتnici za brisanje; gumice za brisanje; elektrokardiografski papir; probadači [kancelarijski materijal]; mastilo; mastiljave trake; fotografije [štampane]; brisači za naliv pera; pečati; knjigovodstvene knjige; indeks registri; formulari [štampani]; kancelarijski materijal, izuzev nameštaja; štampani rokovnici; ovlaživači za lepljenje koverti [kancelarijski rekviziti]; dopisnice, razglednice; štampane stvari; pribor za ručno lepljenje nalepnica; štampane publikacije priručnici; papir za pisanje; pritiskači za papir; igle za kopiranje za crtačke svrhe; olovke za crtanje; stolnjaci od papira; knjižice; svetleći papir; pelir papir za kopije [kancelarijski materijal]; maramice od papira; indigo papir za umnožavače; prekrivači stolova od papira; spajalice; kancelarijski materijal i kancelarijski pribor, osim nameštaja; pergament; pastelne bojice [krede u boji]; postolja za fotografije; nalivpera; omoti za saksije od papira; aparati i mašine za umnožavanje dokumenata; papirne trake i kartice za beleženje kompjuterskih programa; prospekti; naliv pera i hemijske olovke [kancelarijski pribor]; vrećice [koverte, kese] od papira ili plastike, za pakovanje; školska oprema [sveske i pribor za pisanje]; markeri za knjige čestitke, razglednice; lepak za papir ili upotrebu u domaćinstvu; lepljive trake za papir ili upotrebu u domaćinstvu; lepljive vrpce za papir ili upotrebu u domaćinstvu; kalendari; slikarske četkice; samolepljive trake za papir ili upotrebu u

domaćinstvu; gumice [elastične trake] za kancelarije; portikle od papira; table od drvene pulpe[kancelarijske]; papir od pulpe, drvene mase papirne ili kartonske kutije; postolja za pera i olovke; ambalaža za flaše od papira ili kartona; podmetači za čaše od papira; plastična, mehurasta ambalaža za pakovanje ili umotavanje; lepak za kancelarijsku ili kućnu upotrebu; lepkovi za kancelarijsku ili upotrebu u domaćinstvu; noževi za papir [za otvaranje pisama]; vreće za đubre [od papira ili plastike]; zarezaci za olovke, elektronski i neelektronski; papirne maramice za uklanjanje šminke; stone salvete od papira; podmetači od papira; ugaonici za crtanje; T-lenjiri za crtanje; držači za olovke; neseseri sa priborom za pisanje; omotači za flaše od kartona ili papira; plakati od papira ili kartona; ubrusi od papira; ubrusi za lice od papira; etikete od papira ili kartona; viskozni papir za umotavanje, ukrasni papir; sredstva za lepljenje za papire ili upotrebu u domaćinstvu; vreće za mikrotalasno kuvanje; papirni filteri za kafu; plastična tanka rastegljiva folija za obavljanje paleta; natpisi od papira ili kartona; nalepnice [kancelarijski pribor]; papir za kopiranje; muzičke čestitke, razglednice bilteni; plastifikatori dokumenata za kancelarijsku upotrebu; brisači za table za pisanje; pločice sa hvataljkom za listove papira; papirne mašne, koje nisu pozamanterija i ukrasi za kosu; upijajuće folije od papira ili plastike za pakovanje hrane; folije od papira ili plastike za održavanje vlage za pakovanje hrane; korektorske trake [kancelarijski pribor]; posudice za boje; markeri [pisači pribor]; letci, flajeri; držači spisa, dokumenata [kancelarijski pribor]; držači stranica knjiga; papirni i kartonski materijali za pakovanje [punjenje, oblaganje]; ispuna od papira ili kartona; vaučeri; plastične kese za odlaganje životinjskog izmeta; vaši [japanski papir]; nadstolnjaci od papira; štampane muzičke partiture; transparenti [baneri] od papira; navlake za kartice sa imenom; jo jo držači kartica sa imenom [kancelarijski pribor]; kopče za navlake za kartice sa imenom [kancelarijski pribor]; portikle sa rukavima, papirne sekači papira [kancelarijski pribor]; šabloni za ukrašavanje hrane i napitaka; bedževi sa imenom [kancelarijski pribor]; trake za bar kodove šljokice za kancelarijsku upotrebu; maramice od papira za čišćenje.

Klasa 29: Kulinarske namene ekstrakti algi za ishranu želatin*; jestive masti; incuni, neživi; kikiriki puter; puter; kakao puter za ishranu; kokosov puter; puter krem; belance od jaja; kobasice krvavice; goveđa supa; goveđa supa, bujon; preparati za pravljenje bujona; kavijar; voće, konzervisano; suhomesnati proizvodi; čips od krompira; listići od krompira; kiseli kupus; kokos, osušeni; ulje repice za ishranu; repino ulje za ishranu; koncentracije za goveđu supu; koncentracije za bujon; džemovi; zaleđeno voće; supe; suvo grožđe; krastavčići; konzervisano povrće; kuvano povrće; sušeno povrće; ulja za ishranu; pavlaka [mlečni proizvod]; sir; smrznuto voće; kristalizovano voće; kroketi; ljuskari, koji nisu živi; urme; mleko; rak, koji nije živ; riblji fileti; sirište, sirilo; voće, kuvano; voćni žele; voćna pulpa; meso; riba, koja nije živa; žele za ishranu; žele od mesa; divljač, koja nije živa; đumbirov džem; konzervisana soja, za ishranu; masne supstance za proizvodnju jestive masti; smeše koje sadrže mast za kriške hleba; haringe, nežive; jastozi, koji nisu živi; kukuruzno ulje za ishranu; ulje palminih koštica za ishranu; susamovo ulje za ishranu; ostrige, koje nisu žive; riblji želatin za ishranu; šunka; žumance od jaja; jogurt; preparati za supu od povrća; sokovi od povrća za kuvanje; mesni ekstrakti; kefir [piće od mleka]; kumis [piće od mleka]; napici od mleka, u kojima mleko preovlađuje; surutka; proizvodi od mleka; bodljikavi jastog, koji nije živ; slanina; konzervisano sočivo; margarin; mermelada; životinjska moždina, srž, za ishranu; školjke, ljuskari, koji nisu živi; školjke, koje nisu žive; palmino ulje za ishranu; prerađen orah; jaja; jaja u prahu; jetrena pašteta; luk, konzervisan; masline, konzervisane; maslinovo ulje za ishranu; koštano ulje za ishranu; pektin za kulinarske namene; kiseli krastavac; grašak, konzervirani; kobasice; usoljeno meso; sastojci za pripremanje supe; paradajz pire; salate od povrća; svinjska mast; salate od voća; sardine, nežive; losos, neživ; bubrežni loj za ishranu; tunjevina, neživa; sok od paradajza za kuvanje; suncokretovo ulje za ishranu; škembići; konzervisana gomoljika, tartuf živina, koja nije živa; kora od voća; alginati za kulinarske namene; mleveni badem; kikiriki, pripremljen; konzervisane pečurke; kokosova mast; kokosovo ulje za ishranu; konzervisan pasulj; jetra; namirnice na bazi ribe; voćni čips; školjke kapice, koja nisu žive; voće konzervisano u alkoholu; polen pripremljen kao hrana; škampi, račići, koji nisu živi; konzervisana riba; konzervisano meso; morski račići, koji nisu živi; jaja puževa

za jelo; tofu; mućena pavlaka, šlag; svinjetina; jestiva ptičja gnezda; riba u konzervi; riblje brašno za ljudsku ishranu; voće u konzervi; meso u konzervi; uštipci, krofne od krompira; usoljena riba; morski krastavac, koji nije živ; čaure svilene bube za ljudsku ishranu; povrće u konzervi; panirane kobasice; pahuljice od krompira; pire od jabuka; kompot od brusnice; tahini [namaz od susama]; humus [namaz od leblebija]; morske (nori) alge, konzervisane; grickalice na bazi voća; kiselo mleko; kimči [jelo od fermentisanog povrća]; sojino mleko; milk šejk; ajvar [konzervisana paprika]; suncokretove semenke, pripremljene; riblji musevi; bezalkoholni punč od žumanaca; musevi od povrća; riblja ikra, pripremljena semenke, pripremljene*; aloe vera za ljudsku ishranu; konzervisan beli luk; proteinsko mleko; ulje od semena lana za ishranu; niskokalorični čips od krompira; niskokalorični hrskavi krompir; lecitin za kulinarske namene; mlečni fermenti za kulinarske namene; kompoti; kondenzovano mleko; smetana [kisela pavlaka]; raženka [fermentisano pečeno mleko]; fermentisano mleko; paradajz pire; pasta od povrća; pasta od plavog patlidžana; mleko od kikirikija za kulinarske svrhe; bademovo mleko za kulinarske svrhe; pirinčano mleko; artičoke, konzervirane; aranžmani od obrađenog voća; mleko u prahu*; jakitori [japanski ražnjići od piletine]; bulgogi [koreansko jelo od govedine]; kandirani orasi; začinjeno koštunjavo voće; začinjeni orasi; lešnici, pripremljeni; bobičasto voće, konzervirano; guakamol [pire od avokada]; prstenovi od luka [pohovani luk]; falafel; limunov sok za upotrebu u kulinarstvu; dehidrisano meso; zamrznuto-sušeno meso; liofilizovano meso; ovseno mleko; pavlaka [biljna] na bazi povrća; zamrznuto-sušeno povrće; liofilizovano povrće; dehidrisano povrće; ekstra devičansko maslinovo ulje za ishranu; galbi [jelo od grilovanog mesa]; eskamol [jestive larve mrava]; jestivi insekti, neživi; kukuruz šećerac, prerađen; namazi na bazi orašastih plodova; knedle na bazi krompira; viršle; viršle u kukuruznom testu na štapiću; sojino ulje za ishranu; zamene za mleko; bademovo mleko; mleko od kikirikija; kokosovo mleko; kokosovo mleko za kulinarsku upotrebu; napici na bazi kokosovog mleka; pirinčano mleko za kulinarsku upotrebu; napici na bazi bademovog mleka; napici na bazi mleka od kikirikija; creva za kobasice, prirodna ili veštačka; usoljen i sušeni bakalar; uštipci od svežeg sira; presovana voćna pasta; juba [tofu listići]; pljeskavice od soje; tofu pljeskavice; tadžin [gotovo jelo od mesa, ribe ili povrća];

Klasa 30: Alge [začin]; testenina; bademovo testo; seme anisa; seme zvezdastog anisa; konditorski proizvodi za ukrašavanje novogodišnje jelke; nemedicinski biljni čajevi; arome za kafu; aromatični dodaci za hranu; dodaci jelima; hleb bez kvasca; soli za konzervisanje namirnica; dvopek; biskviti, suvi kolačići keks; sladni biskviti; slatkiši od peperminta; slatkiši [bombone]; vafel proizvodi; slatke zemičke, kolačići kakao; kafa; nepržena kafa; biljni preparati za upotrebu kao zamena za kafu; kolači; cimet [začin]; kapra; karamele [bombone]; kari [začin]; preparati od žitarica; žvakaća guma*; cikorija [zamena za kafu]; čaj; čokolada; marcipan; karanfilić [začin]; začinski dodaci; slatkiši; slatkiši od šećera; kornfleks; kukuruzne pahuljice; kokice; preparati za učvršćivanje mućene pavlake, šlaga; sladoled; palačinke; esencije za ishranu, izuzev etarskih esencija i etarskih ulja; kuhinjska so; dodaci za zgušnjavanje hrane za kuvanje; kurkuma*; prirodni zaslađivači; začini; kolačići od đumbira; piment; brašno*; brašno od boba; kukuruzno brašno; kukuruzno brašno, krupno brašno od slačice; ječmeno brašno; sojino brašno; pšenično brašno; skrob za jelo; fermenti za testo; fondani [slatkiši]; sitni kolači; šećer*; arome za kolače, izuzev etarskih ulja; prašak za kolače; testo za kolače; đumbir [začin]; vezivni agensi za sladoled; led, prirodni ili veštački; led za osvežavanje; glukoza za kulinarsku namenu; gluten pripremljen kao hrana; prekrupa za ljudsku ishranu; sirće; kečap [sos]; kakao; napici sa mlekom; pića od kafe sa mlekom; pića od čokolade sa mlekom; sredstva za podizanje testa; kvasac; materijali za vezivanje kobasica; kolačići od badema [slatka peciva]; makaroni; mleveni kukuruz; kukuruz, mleveni kukuruz, prženi kukuruz; hleb*; maltoza; melasa za ishranu; zlatni sirup [šećerni sirup], melasa; mentol za poslastice; med; oljušteni ječam; senf; orašići rezanci; tanki rezanci; pite; mleveni ječam; sendviči; pastile [bombone]; peciva; peti-ber keks; vekne hleba; začinska paprika; pice; biber; brašno od krompira*; puding; praline; ravioli; slatki koren [slatkiši]; pirinač šafran [začin]; sago; sosovi [dodaci hrani]; celerova so; griz; šerbet [zaleđeni]; sorbei [ledeni]; špageti; tapioka; brašno tapioke*; tart [slatka

pita bez gornje kore]; aroma vanile za kulinarske namene; vanilin [zamena za vanilu]; rezanci za supu; pite od mesa; vekna sa mesom; sredstva za omekšavanje mesa za upotrebu u domaćinstvu; sladoledi; prašak za pravljenje sladoleda; slatkiši od badema; poslastice od kikirikija; arome, koje nisu etarska ulja; arome za pića, izuzev etarskih ulja; mleveni ovas; oljušteni ovas; hrana na bazi ovsa; ovsene pahuljice; ovseno brašno; štapovi od slatkog korenja[poslastica]; pivsko sirće; pića na bazi kafe; pića na bazi kakaoa; pića na bazi čokolade; zamene za kafu; bombone*; čips [proizvod od žitarica]; čau-čau [začin]; kus-kus [griz]; sladni ekstrakti za hranu; slad za ljudsku ishranu; propolis [pčelinji proizvod]*; propolis; reliš [dodatak jelu]; matični mleč*; morska voda za kuvanje; suši; umak od paradajza; majonez; krekeri; engleski krem; voćni žele [slatkiši]; musli; kolači od pirinča; umak, sos od soje; smrzniti jogurt [poslastičarski]; čatni [dodatak jelima]; prolećne rolnice; tako tortilje; ledeni čaj; napici od čaja; prelive za salatu; hlebne mrvice; tabule, libanska salata; alva; kiš; sosovi za meso [umaci]; pasta od soje [dodatak jelima]; miso [dodatak jelima]; grickalice na bazi žitarica; grickalice na bazi pirinča; suva zrna kukuruza bez ljuske; kukuruzni griz; prašak za pecivo; bikarbona soda za kuvanje; soda bikarbona za kuvanje; konzervisane baštenske trave [začini]; gotovi obroci od rezanaca; glazure za kolače; čokoladni musevi; deserti u obliku musa [slatkiši]; voćni prelive [sosovi]; marinade; sendviči sa sirom [čizburgeri]; pesto [sos]; glazure za šunku; seme lana za kulinarsku upotrebu [začin]; laneno seme za kulinarsku upotrebu [začin]; pšenične klice za ljudsku ishranu; visokoproteinske pločice od žitarica; tartar krem za kuvanje; glutenski dodaci za kulinarske namene; sosovi za testenine; pločice od žitarica; palmin šećer; testo, polupreraden proizvod; cvetovi ili lišće kao zamena za čaj; testo za slatka peciva; vareniki [punjene knedle]; peljmeni [knedle punjene mesom]; čokoladni ukrasi za torte; ukrasne bombone za torte; koštunjavo voće sa čokoladnim prelivom; sutlijaš; koštunjavo voće u prahu; beli luk u prahu [začin]; baozi [testo sa nadevom]; pirinčana kaša za kulinarske namene; jiaozi [punjene knedle]; ramen [japansko jelo na bazi rezanaca]; okonomijaki [japanske pikantne palačinke]; smese za okonomijaki [japanske pikantne palačinke]; buritosi; gimbap [koreansko jelo od pirinča]; jestivi papir; jestivi papir od pirinča; namazi na bazi čokolade; čokoladni namazi koji sadrže orašaste plodove; knedle na bazi brašna sirup od agave [prirodni zaslađivač]; staklene glazure; dehidrisana jela čiji je glavni sastojak pirinač; liofilizovana jela čiji je glavni sastojak pirinač; zamrznuta-sušena jela čiji je glavni sastojak pirinač; zamrznuta-sušena jela čiji je glavni sastojak testenina; liofilizovana jela čiji je glavni sastojak testenina; dehidrisana jela čiji je glavni sastojak testenina; napici na bazi kamilice; mlečni karamel krem; bibimbap [mešavina pirinča sa povrćem i junetinom]; onigiri [pirinčane kuglice]; instant pirinač sendvič sa viršlama; kocke leda; prerađeno seme za upotrebu kao začin; susamovo seme [začin]; pikalili; kinoa, prerađena; bulgur; heljda, prerađena brašno od heljde; sos od brusnice [začin]; sos od jabuka [začin]; krutoni; lomper [palačinke na bazi krompira]; zefir [poslastica]; pastila [poslastica]; senbei [pirinčani krekeri]; kimči [palačinke od ukiseljenog povrća]; strugani led sa zaslađenim crvenim pasuljem; mentol bombone za osvežavanje daha; žvakaće gume za osvežavanje daha; udon rezanci soba rezanci.

Klasa 31: Agrumi [južno voće], sveži; alge, neprerađene, za ljudsku ili životinjsku ishranu; morske alge, neprerađene, za ljudsku ili životinjsku ishranu; orašasto voće; životinjska menažerija; žive životinje; hrana za životinje; drveće; Božićne jelke*; stabla drveća; žbunje; ovas [zob]; bobičasto voće, sveže; so za stoku; repa, sveža; mekinje; trupci; kokosov orah, sirov; šećerna trska; rogač, sirov; seme žitarica, neprerađeno; gljive, sveže; uljaste pogače; stočne pogače; kesten, svež; kreč za životinjsku ishranu; koren cikorije; cikorija, sveža; biskviti za pse; limun, svež; ljuska kokosovog oraha; kokos; hrana za ptice; pogača od uljane repice za stoku; krastavci, sveži; hmeljne šišarke; kaša od mekinja za ishranu životinja; kopra; školjke [žive] sveže; povrće bundeve, sveže; venci od prirodnog cveća; jaja za uzgoj, oplođena; pomije; uzgajana stoka; preparati za tovljenje životinja; brašno od pirinča za stočnu ishranu; pasulj, svež; cveće, prirodno; cveće, za dekoraciju, osušeno; polen [sirovina]; seno; hrana za jačanje životinja; hrana za stoku; stočna hrana; pšenica voće, sveže; travnjaci, prirodni; trava, prirodna; smrekine bobice; semenske klice za botaničke svrhe; zrnevlje [žitarice]; seme za životinjsku konzumaciju; seme za sadnju; semenje; zobena krupica za živinu;

baštenska trava, sveža biljke; sadnice; hmelj; orah biljke kole; zelena salata, sveža; sočivo, sveže; kvasac za ishranu životinja; pluta, sirova; laneno brašno [stočna hrana]; kukuruz; kukuruzna stočna pogača; slad za vrenje i destilaciju komina; ostaci voća [komina]; lešnik, svež; brašno za životinje; riblja ikra; jaja svilene bube; lukovice; cvetne lukovice; crni luk, svež; masline, sveže; pomorandže, sveže; ječam; kopriva; sipina kost za ptice; slamene prostirke; slama [stočna hrana]; palme [lišće palminog drveta]; stabla palme; kaša za tovljenje stoke; riba, živa; vinova loza; borova šišarka; biber [biljka]; biljke, sušene, za dekoraciju; praziluk, svež; grašak, svež; krompir, svež; preparati za živinu; nosilje; stajska hrana za životinje; korenje za ishranu životinja; grožđe, sveže; rabarbara, sveža; žbunovi ruža; raž; svilena buba; jestiv susam, neprerađen; tartufi, sveži; talog nakon destilacije; živina, živa; algarovila za životinjsku ishranu; badem [voće]; kikiriki, svež; brašno od kikirikija za životinje; pogače od kikirikija za životinje; nus-proizvodi prerade žitarica za ishranu životinja; ostaci nakon prerade šećerne trske [sirovina]; mamci za pecanje, živi; rakovi, živi; ljuskari, živi; jastozi, živi; dagnje, žive; ostrige, žive; hrana za kućne ljubimce; sirova kora drveta; jastozi obični [živi]; hrana za preživljavanje za životinje; napitci za kućne ljubimce; riblje brašno za životinjsku ishranu; pirinač, neprerađen; morski krastavci [živi]; papir sa peskom [prostirka] za kućne ljubimce; mirisni pesak [prostirka] za kućne ljubimce; aloe vera biljke; spanać, svež; laneno seme za ishranu životinja; seme lana za ishranu životinja; brašno od semena lana za ishranu životinja; laneno brašno za ishranu životinja; pšenične klice za ishranu životinja; artičoke, sveže; haringa, živa; losos, živ; sardine, žive; tuna, živa; beli luk, svež; tikvice, sveže; jestivo seme lana, neprerađeno; jestive semenke lana, neprerađene; aranžmani od svežeg voća; incuni, živi; jestivi insekti, živi; neprerađeni klipovi kukuruza šećerca [oljušteni ili neoljušteni]; kino, neprerađeno; heljda, neprerađeno; koi šarani, živi.

Klasa 32: Bezalkoholni voćni ekstrakti; pivo; ale pivo od đumbira; pivo od đumbira; sladno pivo; pivski slad; bezalkoholni voćni napici; pića od surutke; bezalkoholni pripravci za pravljenje napitaka; koncentracije za pravljenje napitaka; voćni sokovi; sirupi za pića vode [pića]; preparati za pravljenje gazirane vode; litijum voda; mineralna voda [piće]; Seltzer voda; stone vode šira limunade; ekstrakti hmelja za proizvodnju piva; sokovi od povrća [pića]; sirupi za limunade; sladovina šira [nefermentisana]; bademov sirup; soda voda; šerbeti [pića]; sok od paradajza [piće]; bezalkoholna pića; pilule za gaziranje pića; praškovi za gaziranje pića; gazirana voda; sarsaparila [bezalkoholni napitak]; aperitivi, bezalkoholni; kokteli, bezalkoholni; voćni nektar [bezalkoholni]; izotonici; sok od jabuke, bezalkoholni; kvas [bezalkoholni napitak]; bezalkoholni napici na bazi meda; smutis [kašasti napici od voća ili povrća]; bezalkoholna pića od aloe vera; kokteli na bazi piva; napici od soje, osim zamena za mleko; napici za sportiste obogaćeni proteinima; napici na bazi pirinča, koji nisu zamena za mleko; bezalkoholni napici sa ukusom kafe; bezalkoholni napici sa ukusom čaja; osvežavajuća bezalkoholna pića; ječmeno vino [pivo]; energetska pića.

Klasa 33: Liker od peperminti; voćni ekstrakti, alkoholni; biteri [gorka alkoholna pića]; liker od anisa; aniset [liker]; aperitivi; arak; destilovana pića; jabukovača; kokteli; kurakao; digestivi [likeri i žestoka pića]; vino; džin; likeri; medovina; kiršič, višnjevača; žestoka pića; brendi; piket; kruškovača; sake; viski; alkoholna esencije; alkoholni ekstrakti; alkoholna pića, izuzev piva; alkoholna pića koja sadrže voće; alkohol od pirinča; rum; vodka; pomešana alkoholna pića, koja nisu na bazi piva; nira [alkoholno piće na bazi šećerne trske]; baijiu [kinesko piće od destilovanog alkohola].

Klasa 35: Pomoć u poslovnom upravljanju; obaveštenja o poslovima reklamiranje preko plakata; usluge agencija za uvoz i izvoz; usluge agencija za pružanje poslovnih informacija; analize cena i troškova; distribucija reklamnog materijala; računovodstvo; vođenje knjiga [knjigovodstvo]; revizija poslovanja; poslovno upravljanje i organizaciono savetovanje; konsultacije u poslovnom upravljanju; prezentacija robe; pomoć u poslovnom ili industrijskom upravljanju; ažuriranje oglasnih materijala; distribucija uzoraka; stručne usluge o poslovnoj efikasnosti; istraživanje tržišta; poslovne procene; poslovna ispitivanja; iznajmljivanje oglasnih materijala; konsultacije u vezi sa poslovnim organizovanjem; objavljivanje reklamnih tekstova; oglašavanje; reklamiranje; reklamiranje na radiju; poslovna istraživanja; usluge odnosa sa

javnošću; reklamiranje preko televizije; prepisivanje korespondencije [kancelarijske usluge]; uređivanje izloga; usluge reklamnih agencija; savetodavne usluge u poslovnom upravljanju; marketinška istraživanja; kompjutersko upravljanje podacima; profesionalne poslovne konsultacije; organizovanje izložbi za privredne ili reklamne potrebe; poslovne informacije; ispitivanje javnog mnjenja; priprema platnih listi; pronalaženje osoblja; iznajmljivanje oglasnog prostora; obračun poreza; prikupljanje informacija u kompjuterske baze podataka; sistemacija informacija u kompjuterskim bazama podataka; organizovanje sajмова u komercijalne ili reklamne svrhe; onlajn reklamiranje na računarskoj mreži; usluge nabavke za treća lica [kupovina proizvoda i usluga za druge poslovne subjekte]; psihološko testiranje za izbor zaposlenih; usluge poređenja cena; prezentacija proizvoda putem sredstava komunikacije, u svrhu prodaje na malo; pružanje komercijalnih saveta i informacija potrošačima pri izboru roba i usluga; dogovaranje pretplate za usluge telekomunikacija za treća lica; administrativna obrada narudžbenica za kupovinu; komercijalna administracija za licence roba i usluga trećih lica; usluge podugovaranja, outsorsing [pomoć u poslovanju]; fakturisanje; pisanje reklamnih tekstova; prikupljanje statističkih podataka; marketing; usluge maloprodaje farmaceutskih, veterinarskih i higijenskih preparata i medicinskog materijala; iznajmljivanje prodajnih štandova; pružanje komercijalnih i poslovnih kontakt informacija; optimizacija pretraživača za promociju prodaje; optimizacija saobraćaja sa Internet stranice; usluge posredovanja u trgovini; pružanje poslovnih informacija putem Internet stranice; obezbeđivanje onlajn tržišta za kupce i prodavce roba i usluga; dizajniranje reklamnog materijala; angažovanje spoljnih firmi za administrativno upravljanje kompanijama; usluge prijavljivanja poreza; poslovno upravljanje programima za nadoknadu za druge; iznajmljivanje bilborda [panoa za reklamiranje]; usluge zakazivanja sastanaka [kancelarijske usluge]; upravljanje programima lojalnosti potrošača; pisanje tekstova za reklamne namene; registrovanje pisane komunikacije i podataka ažuriranje i održavanje; informacija u registrima; sastavljanje popisa informacija za komercijalne i reklamne svrhe; poslovno upravljanje za nezavisne pružaoce usluga; pregovaranje i zaključivanje poslovnih transakcija za treća lica; usluge poslovnog posredovanja koje se odnose na povezivanje potencijalnih privatnih ulagača sa preduzetnicima kojima su potrebna finansijska sredstva; promocija robe i usluga kroz sponzorisane sporskih događaja; usluge praćenja konkurencije; usluge praćenja tržišta; finansijska revizija; ciljni marketing; oglašavanje na otvorenom; usluge odnosa sa medijima usluge korporativne komunikacije; iznajmljivanje kancelarijske opreme u zajedničkim radnim prostorima; usluge komercijalnog lobiranja.

Klasa 43: Usluge agencija za smeštaj [hotelski, pansioniski]; katering hrane i pića; usluge kafea; usluge kafeterija; usluge kantina; iznajmljivanje privremenog smeštaja; pansioniske usluge; usluge restorana; usluge restorana za samoposluživanje; usluge snek-barova; usluge barova; iznajmljivanje stolova, stolica, stolnjaka i staklenog posuđa; iznajmljivanje prostorija za sastanke; iznajmljivanje aparata za kuvanje; iznajmljivanje automata za vodu za piće; iznajmljivanje aparata za osvetljenje*; pravljenje skulptura od hrane; usluge vašoku restorana; usluge udon i soba restorana; dekorisanje hrane; dekorisanje kolača; informacije i saveti u vezi sa pripremanjem obroka; usluge ličnog šefa kuhinje.

(210) **Ž-2019-427**

(220) 05.11.2019.

(731) Domaća trgovina doo Podgorica, Ul.Josipa Broza Tita br.23a, 81000, Podgorica, ME

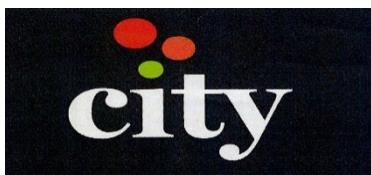

(540)

(550) I

(740) Goran Živković, ul. Petra Zvicera br.11, Podgorica

(511) Klasa 3: Bademovo ulje; bademov sapun; štirak za sjaj veša; štirak za pranje veša; štirak za veš; sapun*; sapun za izbeljivanje tekstila; plavilo za veš; etarsko ulje anisa; kozmetički preparati za kupanje sapun za brijanje; vatirani štapići za kozmetičke svrhe; pamučni štapići za kozmetičku upotrebu; kozmetičke maske; bergamot ulje; soli za izbeljivanje soda za izbeljivanje belila za veš; mirišljivo drvo; preparati za ispiranje usta, koji nisu medicinski; lak za nokte; preparati za šminkanje; losioni za kosu*; kreme za cipele; boje za kosu; preparati za kovrdžanje kose; preparati za čišćenje, poliranje; preparati za poliranje; vosak za cipele; sredstva za poliranje nameštaja i podova; preparati za sjaj [poliri]; obućarski vosak; vosak za parket; vosak za poliranje; etarska ulja limuna; kolonjska voda; boje za toaletnu upotrebu; preparati za zaštitu kože [poliranje]; preparati za očuvanje kože [poliranje]; kozmetički setovi; kozmetika; pamučna vuna za kozmetičku upotrebu; kreda za čišćenje; preparati za uklanjanje mrlja; kozmetičke olovke; kreme za poliranje; kozmetičke kreme; soda za pranje, čišćenje; paste za brijanje; kreme za kožne proizvode; vosak za kožne proizvode; deterdženti, koji nisu za upotrebu u proizvodnim procesima i za medicinsku upotrebu; rastvori za čišćenje; proizvodi za odmašćivanje, koji nisu za upotrebu u procesu proizvodnje; preparati za uklanjanje šminke sredstva za čišćenje zuba [paste, gelovi, tečnosti]*; preparati za uklanjanje kamenca za upotrebu u domaćinstvu; dijamantin, boraks [arbaziv] antistatički preparati za kućnu upotrebu; preparati za uklanjanje laka; preparati za uklanjanje boje odstranjivači laka; mirišljave vode; toaletne vode; preparati za depilaciju; vosak za depilaciju; preparati za natapanje u perionicama; etarske esencije; etarska ulja; etarska ulja; ekstrakti cveća [parfemi]; šminka; preparati za čišćenje; baze za cvetne parfeme; fumigacijska sredstva [parfemi]; arome za kolače [etarska ulja]; ulja za kozmetičku upotrebu; jasmينو ulje; ulje od lavande; ulja za čišćenje; ulja za parfeme i mirise; ružino ulje; toaletna ulja; losioni za kozmetičku upotrebu; mleko za čišćenje za toaletnu upotrebu; preparati za pranje; toaletni proizvodi [sredstva za ličnu higijenu]*; preparati za štirkanje; mirisna menta [etarsko ulje]; menta za parfimerijske proizvode kozmetika za obrve; šamponi*; parfemi; preparati za negu noktiju; parfimerija; kozmetički preparati za negu kože; sapun protiv znojenja nogu; kamen za poliranje; pomade za kozmetičku upotrebu; puder za šminkanje; preparati za brijanje; dezodorantni sapun; kesice sa mirisom za rublje; safrol; komadi toaletnog sapuna; komadi sapuna; olovke za izvlačenje obrva; talk puder, za toaletnu upotrebu; kozmetičke boje; krpe za poliranje; stakleno platno [abrazivno platno]; preparati protiv znojenja; sapun protiv znojenja; tripoli kamen za poliranje; abrazivi; bademovo mleko za kozmetičku upotrebu; preparati za uklanjanje rđe; preparati za sunčanje [kozmetički]; aromatična ulja [etarska ulja]; arome za pića [etarska ulja]; hemikalije za osvežavanje boja za upotrebu u domaćinstvu [pranje veša]; soli za kupanje koje nisu za medicinsku upotrebu; kozmetički preparati; preparati za uklanjanje boja; dezodoransi za ljude ili životinje; dekorativne nalepnice za kozmetičku upotrebu; astringentna sredstva; preparati za beljenje [skidanje boje] za kozmetičku upotrebu; oplemenjivači rublja za upotrebu u perionicama; preparati za otčepljivanje odvodnih cevi; šamponi za kućne ljubimce [nemedicinski preparati za negu]; maramice natopljene sa kozmetičkim losionima; sredstva za lepljenje za kozmetičku upotrebu; losioni posle brijanja; lakovi za kosu; maskare; potpuri [mirisi]; sprejevi za osvežavanje daha; preparati za hemijsko čišćenje; odstranjivači voska sa poda [sredstva za odstranjivanje]; neklizajući vosak za podove; neklizajuće tečnosti za podove; vazduh konzerviran pod pritiskom, za čišćenje i uklanjanje prašine; gelovi za izbeljivanje zuba; krpe namočene deterdžentom za čišćenje; preparati za sjaj; lišća biljaka; mirisni štapići; sredstva za sušenje sudova u mašinama za sudove; preparati za parfimisanje

vazduha; trake za osvežavanje daha; dezodoransi za kućne ljubimce; preparati za tuširanje za ličnu higijenu i dezodorisanje [toaletni proizvodi]; preparati od aloe vere za kozmetičke namene; sjajevi za usne; balzami, osim za medicinske svrhe; šamponi za suvo pranje*; preparati za sunčanje; etarsko ulje limuna kana [kozmetička boja]; sredstva za čišćenje obuće; preparati za kupanje, ne za medicinske svrhe; balzami za kosu; proizvodi za ispravljanje kose; maramice natopljene preparatima za skidanje šminke; preparati kolagena za kozmetičke svrhe; trake za izbeljivanje zuba; arome za hranu [etarska ulja]; fitokozmetički preparati; sredstva za čišćenje za intimnu ličnu higijenu, nemedicinska; biljni ekstrakti za kozmetičke namene; sredstva za odstranjivanje laka za nokte; sredstva za uklanjanje laka za nokte; vosak za podove; šamponi za životinje [nemedicinski preparati za negu]; sredstva za ispiranje očiju, ne za medicinske namene; sredstva za vaginalno ispiranje za ličnu higijenu ili dezodorisanje; hemijski preparati za čišćenje za upotrebu u domaćinstvu; raspršivači od trske za osvežavanje vazduha; preparati za beljenje [uklanjanje boja] za upotrebu u domaćinstvu; kozmetika za decu; preparati za osvežavanje daha za ličnu higijenu; maramice za bebe natopljene preparatima za čišćenje; basma [kozmetička boja]; gel jastučići za oči za kozmetičke namene.

Klasa 16: Nosači lepljivih traka [kancelarijski pribor]; papir; poster; oglasni panoi od papira ili kartona; spajalice [kancelarijski pribor]; klipse za olovke heftalice [kancelarijski rekvizit]; beležnice, notesi; albumi; slike; štampani materijal [viskoka štampa]; trake za cigare, za uvijanje cigareta; mašine za oštrenje olovaka, elektronske ili neelektronske podupirači za knjige; vodene boje [slikarske]; vodene boje, slikarske; akvarel boje; fascikle za spise [kancelarijski pribor]; tablice za pisanje; pisaljke za tablice; srebrni papir; olovke; novine; periodične publikacije; atlas; uložne mape sa prstenovima; registratori sa prstenovima; gumirane trake [kancelarijski materijal]; podmetači za pivske čaše; ulaznice; kliše; blokovi za crtanje blokovi [kancelarijski materijal]; kalemi za trake sa mastilom; manžetne za držanje pribora za pisanje; pamfleti; špenadle kao kancelarijski materijal; čiode kao kancelarijski materijal; ovlaživači vrhova prstiju [kancelarijski pribor]; jastučići za mastilo; vosak za pečačenje; sveske; obrasci za precrtavanje; paus papir; štamparska slova; karbon papir; papir za mašine za snimanje; beležnice; ugaoni lenjiri za crtanje; karte; materijal za obuku [izuzev aparata]; listovi papira [kancelarijski] karton; tube od kartona; katalozi; metalni vrh za indeksne karte; spojeni ramovi [štamparski]; omoti za papir; košuljice za spise; brojevi [štamparski]; indijsko mastilo; fascikle [kancelarijski materijal]; bušilice za papir [zumba]; higijenski papir; toalet papir; knjige; šestari za crtanje; štamparski brojevi i slova; slova, štamparska; kompozeri za slaganje; posude za pisma; konusne papirne kese; korektivna tečnost [kancelarijski rekvizit]; korektivno mastilo [heliografsko]; grafitne mine za olovke; kreda za pisanje; držači olovaka; olovke sa grafitnom minom [tehničke olovke]; papirne kutije za krem; table za crtanje; materijali za crtanje; instrumenti za crtanje; kutije za olovke; proizvodi za brisanje; materijali za pisanje; štitnici za brisanje; gumice za brisanje; elektrokardiografski papir; probadači [kancelarijski materijal]; mastilo; mastiljave trake; fotografije [štampane]; brisači za naliv pera; pečati; knjigovodstvene knjige; indeks registri; formulari [štampani]; kancelarijski materijal, izuzev nameštaja; štampani rokovnici; ovlaživači za lepljenje koverti [kancelarijski rekviziti]; dopisnice, razglednice; štampane stvari; pribor za ručno lepljenje nalepnica; štampane publikacije priručnici; papir za pisanje; pritiskači za papir; igle za kopiranje za crtačke svrhe; olovke za crtanje; stolnjaci od papira; knjižice; svetleći papir; pelir papir za kopije [kancelarijski materijal]; maramice od papira; indigo papir za umnožavače; prekrivači stolova od papira; spajalice; kancelarijski materijal i kancelarijski pribor, osim nameštaja; pergament; pastelne bojice [krede u boji]; postolja za fotografije; nalivpera; omoti za saksije od papira; aparati i mašine za umnožavanje dokumenata; papirne trake i kartice za beleženje kompjuterskih programa; prospekti; naliv pera i hemijske olovke [kancelarijski pribor]; vrećice [koverte, kese] od papira ili plastike, za pakovanje; školska oprema [sveske i pribor za pisanje]; markeri za knjige čestitke, razglednice; lepak za papir ili upotrebu u domaćinstvu; lepljive trake za papir ili upotrebu u domaćinstvu; lepljive vrpce za papir ili upotrebu u domaćinstvu; kalendari; slikarske četkice; samolepljive trake za papir ili upotrebu u

domaćinstvu; gumice [elastične trake] za kancelarije; portikle od papira; table od drvene pulpe[kancelarijske]; papir od pulpe, drvene mase papirne ili kartonske kutije; postolja za pera i olovke; ambalaža za flaše od papira ili kartona; podmetači za čaše od papira; plastična, mehurasta ambalaža za pakovanje ili umotavanje; lepak za kancelarijsku ili kućnu upotrebu; lepkovi za kancelarijsku ili upotrebu u domaćinstvu; noževi za papir [za otvaranje pisama]; vreće za đubre [od papira ili plastike]; zarezaci za olovke, elektronski i neelektronski; papirne maramice za uklanjanje šminke; stone salvete od papira; podmetači od papira; ugaonici za crtanje; T-lenjiri za crtanje; držači za olovke; neseseri sa priborom za pisanje; omotači za flaše od kartona ili papira; plakati od papira ili kartona; ubrusi od papira; ubrusi za lice od papira; etikete od papira ili kartona; viskozni papir za umotavanje, ukrasni papir; sredstva za lepljenje za papire ili upotrebu u domaćinstvu; vreće za mikrotalasno kuvanje; papirni filteri za kafu; plastična tanka rastegljiva folija za obavljanje paleta; natpisi od papira ili kartona; nalepnice [kancelarijski pribor]; papir za kopiranje; muzičke čestitke, razglednice bilteni; plastifikatori dokumenata za kancelarijsku upotrebu; brisači za table za pisanje; pločice sa hvataljkom za listove papira; papirne mašne, koje nisu pozamanterija i ukrasi za kosu; upijajuće folije od papira ili plastike za pakovanje hrane; folije od papira ili plastike za održavanje vlage za pakovanje hrane; korektorske trake [kancelarijski pribor]; posudice za boje; markeri [pisači pribor]; letci, flajeri; držači spisa, dokumenata [kancelarijski pribor]; držači stranica knjiga; papirni i kartonski materijali za pakovanje [punjenje, oblaganje]; ispuna od papira ili kartona; vaučeri; plastične kese za odlaganje životinjskog izmeta; vaši [japanski papir]; nadstolnjaci od papira; štampane muzičke partiture; transparenti [baneri] od papira; navlake za kartice sa imenom; jo jo držači kartica sa imenom [kancelarijski pribor]; kopče za navlake za kartice sa imenom [kancelarijski pribor]; portikle sa rukavima, papirne sekači papira [kancelarijski pribor]; šabloni za ukrašavanje hrane i napitaka; bedževi sa imenom [kancelarijski pribor]; trake za bar kodove šljokice za kancelarijsku upotrebu; maramice od papira za čišćenje.

Klasa 29: Kulinarske namene ekstrakti algi za ishranu želatin*; jestive masti; inćuni, neživi; kikiriki puter; puter; kakao puter za ishranu; kokosov puter; puter krem; belance od jaja; kobasice krvavice; goveđa supa; goveđa supa, bujon; preparati za pravljenje bujona; kavijar; voće, konzervisano; suhomesnati proizvodi; čips od krompira; listići od krompira; kiseli kupus; kokos, osušeni; ulje repice za ishranu; repino ulje za ishranu; koncentracije za goveđu supu; koncentracije za bujon; džemovi; zaleđeno voće; supe; suvo grožđe; krastavčići; konzervisano povrće; kuvano povrće; sušeno povrće; ulja za ishranu; pavlaka [mlečni proizvod]; sir; smrznuto voće; kristalizovano voće; kroketi; ljuskari, koji nisu živi; urme; mleko; rak, koji nije živ; riblji fileti; sirište, sirilo; voće, kuvano; voćni žele; voćna pulpa; meso; riba, koja nije živa; žele za ishranu; žele od mesa; divljač, koja nije živa; đumbirov džem; konzervisana soja, za ishranu; masne supstance za proizvodnju jestive masti; smeše koje sadrže mast za kriške hleba; haringe, nežive; jastozi, koji nisu živi; kukuruzno ulje za ishranu; ulje palminih koštica za ishranu; susamovo ulje za ishranu; ostrige, koje nisu žive; riblji želatin za ishranu; šunka; žumance od jaja; jogurt; preparati za supu od povrća; sokovi od povrća za kuvanje; mesni ekstrakti; kefir [piće od mleka]; kumis [piće od mleka]; napici od mleka, u kojima mleko preovlađuje; surutka; proizvodi od mleka; bodljikavi jastog, koji nije živ; slanina; konzervisano sočivo; margarin; mermelada; životinjska moždina, srž, za ishranu; školjke, ljuskari, koji nisu živi; školjke, koje nisu žive; palmino ulje za ishranu; prerađen orah; jaja; jaja u prahu; jetrena pašteta; luk, konzervisan; masline, konzervisane; maslinovo ulje za ishranu; koštano ulje za ishranu; pektin za kulinarske namene; kiseli krastavac; grašak, konzervirani; kobasice; usoljeno meso; sastojci za pripremanje supe; paradajz pire; salate od povrća; svinjska mast; salate od voća; sardine, nežive; losos, neživ; bubrežni loj za ishranu; tunjevina, neživa; sok od paradajza za kuvanje; suncokretovo ulje za ishranu; škembići; konzervisana gomoljika, tartuf živina, koja nije živa; kora od voća; alginati za kulinarske namene; mleveni badem; kikiriki, pripremljen; konzervisane pečurke; kokosova mast; kokosovo ulje za ishranu; konzervisan pasulj; jetra; namirnice na bazi ribe; voćni čips; školjke kapice, koja nisu žive; voće konzervisano u alkoholu; polen pripremljen kao hrana; škampi, račići, koji nisu živi; konzervisana riba; konzervisano meso; morski račići, koji nisu živi; jaja puževa

za jelo; tofu; mućena pavlaka, šlag; svinjetina; jestiva ptičja gnezda; riba u konzervi; riblje brašno za ljudsku ishranu; voće u konzervi; meso u konzervi; uštipci, krofne od krompira; usoljena riba; morski krastavac, koji nije živ; čaure svilene bube za ljudsku ishranu; povrće u konzervi; panirane kobasice; pahuljice od krompira; pire od jabuka; kompot od brusnice; tahini [namaz od susama]; humus [namaz od leblebija]; morske (nori) alge, konzervisane; grickalice na bazi voća; kiselo mleko; kimči [jelo od fermentisanog povrća]; sojino mleko; milk šejk; ajvar [konzervisana paprika]; suncokretove semenke, pripremljene; riblji musevi; bezalkoholni punč od žumanaca; musevi od povrća; riblja ikra, pripremljena semenke, pripremljene*; aloe vera za ljudsku ishranu; konzervisan beli luk; proteinsko mleko; ulje od semena lana za ishranu; niskokalorični čips od krompira; niskokalorični hrskavi krompir; lecitin za kulinarske namene; mlečni fermenti za kulinarske namene; kompoti; kondenzovano mleko; smetana [kisela pavlaka]; raženka [fermentisano pečeno mleko]; fermentisano mleko; paradajz pire; pasta od povrća; pasta od plavog patlidžana; mleko od kikirikija za kulinarske svrhe; bademovo mleko za kulinarske svrhe; pirinčano mleko; artičoke, konzervirane; aranžmani od obrađenog voća; mleko u prahu*; jakitori [japanski ražnjići od piletine]; bulgogi [koreansko jelo od govedine]; kandirani orasi; začinjeno koštunjavo voće; začinjeni orasi; lešnici, pripremljeni; bobičasto voće, konzervirano; guakamol [pire od avokada]; prstenovi od luka [pohovani luk]; falafel; limunov sok za upotrebu u kulinarstvu; dehidrisano meso; zamrznuto-sušeno meso; liofilizovano meso; ovseno mleko; pavlaka [biljna] na bazi povrća; zamrznuto-sušeno povrće; liofilizovano povrće; dehidrisano povrće; ekstra devičansko maslinovo ulje za ishranu; galbi [jelo od grilovanog mesa]; eskamol [jestive larve mrava]; jestivi insekti, neživi; kukuruz šećerac, prerađen; namazi na bazi orašastih plodova; knedle na bazi krompira; viršle; viršle u kukuruznom testu na štapiću; sojino ulje za ishranu; zamene za mleko; bademovo mleko; mleko od kikirikija; kokosovo mleko; kokosovo mleko za kulinarsku upotrebu; napici na bazi kokosovog mleka; pirinčano mleko za kulinarsku upotrebu; napici na bazi bademovog mleka; napici na bazi mleka od kikirikija; creva za kobasice, prirodna ili veštačka; usoljen i sušeni bakalari; uštipci od svežeg sira; presovana voćna pasta; juba [tofu listići]; pljeskavice od soje; tofu pljeskavice; tadžin [gotovo jelo od mesa, ribe ili povrća];

Klasa 30: Alge [začin]; testenina; bademovo testo; seme anisa; seme zvezdastog anisa; konditorski proizvodi za ukrašavanje novogodišnje jelke; nemedicinski biljni čajevi; arome za kafu; aromatični dodaci za hranu; dodaci jelima; hleb bez kvasca; soli za konzervisanje namirnica; dvopek; biskviti, suvi kolačići keks; sladni biskviti; slatkiši od pepermintina; slatkiši [bombone]; vafel proizvodi; slatke zemičke, kolačići kakao; kafa; nepržena kafa; biljni preparati za upotrebu kao zamena za kafu; kolači; cimet [začin]; kapra; karamele [bombone]; kari [začin]; preparati od žitarica; žvakaća guma*; cikorija [zamena za kafu]; čaj; čokolada; marcipan; karanfilić [začin]; začinski dodaci; slatkiši; slatkiši od šećera; kornfleks; kukuruzne pahuljice; kokice; preparati za učvršćivanje mućene pavlake, šlaga; sladoled; palačinke; esencije za ishranu, izuzev etarskih esencija i etarskih ulja; kuhinjska so; dodaci za zgušnjavanje hrane za kuvanje; kurkuma*; prirodni zaslađivači; začini; kolačići od đumbira; piment; brašno*; brašno od boba; kukuruzno brašno; kukuruzno brašno, krupno brašno od slačice; ječmeno brašno; sojino brašno; pšenično brašno; skrob za jelo; fermenti za testo; fondani [slatkiši]; sitni kolači; šećer*; arome za kolače, izuzev etarskih ulja; prašak za kolače; testo za kolače; đumbir [začin]; vezivni agensi za sladoled; led, prirodni ili veštački; led za osvežavanje; glukoza za kulinarsku namenu; gluten pripremljen kao hrana; prekrupa za ljudsku ishranu; sirće; kečap [sos]; kakao; napici sa mlekom; pića od kafe sa mlekom; pića od čokolade sa mlekom; sredstva za podizanje testa; kvasac; materijali za vezivanje kobasica; kolačići od badema [slatka peciva]; makaroni; mleveni kukuruz; kukuruz, mleveni kukuruz, prženi kukuruz; hleb*; maltoza; melasa za ishranu; zlatni sirup [šećerni sirup], melasa; mentol za poslastice; med; oljušteni ječam; senf; orašići rezanci; tanki rezanci; pite; mleveni ječam; sendviči; pastile [bombone]; peciva; peti-ber keks; vekne hleba; začinska paprika; pice; biber; brašno od krompira*; puding; praline; ravioli; slatki koren [slatkiši]; pirinač šafran [začin]; sago; sosovi [dodaci hrani]; celerova so; griz; šerbet [zaleđeni]; sorbei [ledeni]; špageti; tapioka; brašno tapioke*; tart [slatka

pita bez gornje kore]; aroma vanile za kulinarske namene; vanilin [zamena za vanilu]; rezanci za supu; pite od mesa; vekna sa mesom; sredstva za omekšavanje mesa za upotrebu u domaćinstvu; sladoledi; prašak za pravljenje sladoleda; slatkiši od badema; poslastice od kikirikija; arome, koje nisu etarska ulja; arome za pića, izuzev etarskih ulja; mleveni ovas; oljušteni ovas; hrana na bazi ovsa; ovsene pahuljice; ovseno brašno; štapovi od slatkog korenja[poslastica]; pivsko sirće; pića na bazi kafe; pića na bazi kakaoa; pića na bazi čokolade; zamene za kafu; bombone*; čips [proizvod od žitarica]; čau-čau [začin]; kus-kus [griz]; sladni ekstrakti za hranu; slad za ljudsku ishranu; propolis [pčelinji proizvod]*; propolis; reliš [dodatak jelu]; matični mleč*; morska voda za kuvanje; suši; umak od paradajza; majonez; krekeri; engleski krem; voćni žele [slatkiši]; musli; kolači od pirinča; umak, sos od soje; smrzniti jogurt [poslastičarski]; čatni [dodatak jelima]; prolećne rolnice; tako tortilje; ledeni čaj; napici od čaja; prelive za salatu; hlebne mrvice; tabule, libanska salata; alva; kiš; sosovi za meso [umaci]; pasta od soje [dodatak jelima]; miso [dodatak jelima]; grickalice na bazi žitarica; grickalice na bazi pirinča; suva zrna kukuruza bez ljuske; kukuruzni griz; prašak za pecivo; bikarbona soda za kuvanje; soda bikarbona za kuvanje; konzervisane baštenske trave [začini]; gotovi obroci od rezanaca; glazure za kolače; čokoladni musevi; deserti u obliku musa [slatkiši]; voćni prelive [sosovi]; marinade; sendviči sa sirom [čizburgeri]; pesto [sos]; glazure za šunku; seme lana za kulinarsku upotrebu [začin]; laneno seme za kulinarsku upotrebu [začin]; pšenične klice za ljudsku ishranu; visokoproteinske pločice od žitarica; tartar krem za kuvanje; glutenski dodaci za kulinarske namene; sosovi za testenine; pločice od žitarica; palmin šećer; testo, poluprerađen proizvod; cvetovi ili lišće kao zamena za čaj; testo za slatka peciva; vareniki [punjene knedle]; peljmeni [knedle punjene mesom]; čokoladni ukrasi za torte; ukrasne bombone za torte; koštunjavo voće sa čokoladnim prelivom; sutlijaš; koštunjavo voće u prahu; beli luk u prahu [začin]; baozi [testo sa nadevom]; pirinčana kaša za kulinarske namene; jiaozi [punjene knedle]; ramen [japansko jelo na bazi rezanaca]; okonomijaki [japanske pikantne palačinke]; smese za okonomijaki [japanske pikantne palačinke]; buritosi; gimbap [koreansko jelo od pirinča]; jestivi papir; jestivi papir od pirinča; namazi na bazi čokolade; čokoladni namazi koji sadrže orašaste plodove; knedle na bazi brašna sirup od agave [prirodni zaslađivač]; staklene glazure; dehidrisana jela čiji je glavni sastojak pirinač; liofilizovana jela čiji je glavni sastojak pirinač; zamrznuta-sušena jela čiji je glavni sastojak pirinač; zamrznuta-sušena jela čiji je glavni sastojak testenina; liofilizovana jela čiji je glavni sastojak testenina; dehidrisana jela čiji je glavni sastojak testenina; napici na bazi kamilice; mlečni karamel krem; bibimbap [mešavina pirinča sa povrćem i junetinom]; onigiri [pirinčane kuglice]; instant pirinač sendvič sa viršlama; kocke leda; prerađeno seme za upotrebu kao začin; susamovo seme [začin]; pikalili; kinoa, prerađena; bulgur; heljda, prerađena brašno od heljde; sos od brusnice [začin]; sos od jabuka [začin]; krutoni; lomper [palačinke na bazi krompira]; zefir [poslastica]; pastila [poslastica]; senbei [pirinčani krekeri]; kimči [palačinke od ukiseljenog povrća]; strugani led sa zaslađenim crvenim pasuljem; mentol bombone za osvežavanje daha; žvakaće gume za osvežavanje daha; udon rezanci soba rezanci.

Klasa 31: Agrumi [južno voće], sveži; alge, neprerađene, za ljudsku ili životinjsku ishranu; morske alge, neprerađene, za ljudsku ili životinjsku ishranu; orašasto voće; životinjska menažerija; žive životinje; hrana za životinje; drveće; Božićne jelke*; stabla drveća; žbunje; ovas [zob]; bobičasto voće, sveže; so za stoku; repa, sveža; mekinje; trupci; kokosov orah, sirov; šećerna trska; rogač, sirov; seme žitarica, neprerađeno; gljive, sveže; uljaste pogače; stočne pogače; kesten, svež; kreč za životinjsku ishranu; koren cikorije; cikorija, sveža; biskviti za pse; limun, svež; ljuska kokosovog oraha; kokos; hrana za ptice; pogača od uljane repice za stoku; krastavci, sveži; hmeljne šišarke; kaša od mekinja za ishranu životinja; kopra; školjke [žive] sveže; povrće bundeve, sveže; venci od prirodnog cveća; jaja za uzgoj, oplođena; pomije; uzgajana stoka; preparati za tovljenje životinja; brašno od pirinča za stočnu ishranu; pasulj, svež; cveće, prirodno; cveće, za dekoraciju, osušeno; polen [sirovina]; seno; hrana za jačanje životinja; hrana za stoku; stočna hrana; pšenica voće, sveže; travnjaci, prirodni; trava, prirodna; smrekine bobice; semenske klice za botaničke svrhe; zrnevlje [žitarice]; seme za životinjsku konzumaciju; seme za sadnju; semenje; zobena krupica za živinu;

baštenska trava, sveža biljke; sadnice; hmelj; orah biljke kole; zelena salata, sveža; sočivo, sveže; kvasac za ishranu životinja; pluta, sirova; laneno brašno [stočna hrana]; kukuruz; kukuruzna stočna pogača; slad za vrenje i destilaciju komina; ostaci voća [komina]; lešnik, svež; brašno za životinje; riblja ikra; jaja svilene bube; lukovice; cvetne lukovice; crni luk, svež; masline, sveže; pomorandže, sveže; ječam; kopriva; sipina kost za ptice; slamene prostirke; slama [stočna hrana]; palme [lišće palminog drveta]; stabla palme; kaša za tovljenje stoke; riba, živa; vinova loza; borova šišarka; biber [biljka]; biljke, sušene, za dekoraciju; praziluk, svež; grašak, svež; krompir, svež; preparati za živinu; nosilje; stajska hrana za životinje; korenje za ishranu životinja; grožđe, sveže; rabarbara, sveža; žbunovi ruža; raž; svilena buba; jestiv susam, neprerađen; tartufi, sveži; talog nakon destilacije; živina, živa; algarovila za životinjsku ishranu; badem [voće]; kikiriki, svež; brašno od kikirikija za životinje; pogače od kikirikija za životinje; nus-proizvodi prerade žitarica za ishranu životinja; ostaci nakon prerade šećerne trske [sirovina]; mamci za pecanje, živi; rakovi, živi; ljuskari, živi; jastozi, živi; dagnje, žive; ostrige, žive; hrana za kućne ljubimce; sirova kora drveta; jastozi obični [živi]; hrana za preživljavanje za životinje; napitci za kućne ljubimce; riblje brašno za životinjsku ishranu; pirinač, neprerađen; morski krastavci [živi]; papir sa peskom [prostirka] za kućne ljubimce; mirisni pesak [prostirka] za kućne ljubimce; aloe vera biljke; spanać, svež; laneno seme za ishranu životinja; seme lana za ishranu životinja; brašno od semena lana za ishranu životinja; laneno brašno za ishranu životinja; pšenične klice za ishranu životinja; artičoke, sveže; haringa, živa; losos, živ; sardine, žive; tuna, živa; beli luk, svež; tikvice, sveže; jestivo seme lana, neprerađeno; jestive semenke lana, neprerađene; aranžmani od svežeg voća; incuni, živi; jestivi insekti, živi; neprerađeni klipovi kukuruza šećerca [oljušteni ili neoljušteni]; kinoa, neprerađena; heljda, neprerađena; koi šarani, živi.

Klasa 32: Bezalkoholni voćni ekstrakti; pivo; ale pivo od đumbira; pivo od đumbira; sladno pivo; pivski slad; bezalkoholni voćni napici; pića od surutke; bezalkoholni pripravci za pravljenje napitaka; koncentracije za pravljenje napitaka; voćni sokovi; sirupi za pića vode [pića]; preparati za pravljenje gazirane vode; litijum voda; mineralna voda [piće]; Seltzer voda; stone vode šira limunade; ekstrakti hmelja za proizvodnju piva; sokovi od povrća [pića]; sirupi za limunade; sladovina šira [nefermentisana]; bademov sirup; soda voda; šerbeti [pića]; sok od paradajza [piće]; bezalkoholna pića; pilule za gaziranje pića; praškovi za gaziranje pića; gazirana voda; sarsaparila [bezalkoholni napitak]; aperitivi, bezalkoholni; kokteli, bezalkoholni; voćni nektar [bezalkoholni]; izotonici; sok od jabuke, bezalkoholni; kvas [bezalkoholni napitak]; bezalkoholni napici na bazi meda; smutis [kašasti napici od voća ili povrća]; bezalkoholna pića od aloe vera; kokteli na bazi piva; napici od soje, osim zamena za mleko; napici za sportiste obogaćeni proteinima; napici na bazi pirinča, koji nisu zamena za mleko; bezalkoholni napici sa ukusom kafe; bezalkoholni napici sa ukusom čaja; osvežavajuća bezalkoholna pića; ječmeno vino [pivo]; energetska pića.

Klasa 33: Liker od peperminti; voćni ekstrakti, alkoholni; biteri [gorka alkoholna pića]; liker od anisa; aniset [liker]; aperitivi; arak; destilovana pića; jabukovača; kokteli; kurakao; digestivi [likeri i žestoka pića]; vino; džin; likeri; medovina; kiršič, višnjevača; žestoka pića; brendi; piket; kruškovača; sake; viski; alkoholna esencije; alkoholni ekstrakti; alkoholna pića, izuzev piva; alkoholna pića koja sadrže voće; alkohol od pirinča; rum; vodka; pomešana alkoholna pića, koja nisu na bazi piva; nira [alkoholno piće na bazi šećerne trske]; baijiu [kinesko piće od destilovanog alkohola].

Klasa 35: Pomoć u poslovnom upravljanju; obaveštenja o poslovima reklamiranje preko plakata; usluge agencija za uvoz i izvoz; usluge agencija za pružanje poslovnih informacija; analize cena i troškova; distribucija reklamnog materijala; računovodstvo; vođenje knjiga [knjigovodstvo]; revizija poslovanja; poslovno upravljanje i organizaciono savetovanje; konsultacije u poslovnom upravljanju; prezentacija robe; pomoć u poslovnom ili industrijskom upravljanju; ažuriranje oglasnih materijala; distribucija uzoraka; stručne usluge o poslovnoj efikasnosti; istraživanje tržišta; poslovne procene; poslovna ispitivanja; iznajmljivanje oglasnih materijala; konsultacije u vezi sa poslovnim organizovanjem; objavljivanje reklamnih tekstova; oglašavanje; reklamiranje; reklamiranje na radiju; poslovna istraživanja; usluge odnosa sa

javnošću; reklamiranje preko televizije; prepisivanje korespondencije [kancelarijske usluge]; uređivanje izloga; usluge reklamnih agencija; savetodavne usluge u poslovnom upravljanju; marketinška istraživanja; kompjutersko upravljanje podacima; profesionalne poslovne konsultacije; organizovanje izložbi za privredne ili reklamne potrebe; poslovne informacije; ispitivanje javnog mnjenja; priprema platnih listi; pronalaženje osoblja; iznajmljivanje oglasnog prostora; obračun poreza; prikupljanje informacija u kompjuterske baze podataka; sistemacija informacija u kompjuterskim bazama podataka; organizovanje sajмова u komercijalne ili reklamne svrhe; onlajn reklamiranje na računarskoj mreži; usluge nabavke za treća lica [kupovina proizvoda i usluga za druge poslovne subjekte]; psihološko testiranje za izbor zaposlenih; usluge poređenja cena; prezentacija proizvoda putem sredstava komunikacije, u svrhu prodaje na malo; pružanje komercijalnih saveta i informacija potrošačima pri izboru roba i usluga; dogovaranje pretplate za usluge telekomunikacija za treća lica; administrativna obrada narudžbenica za kupovinu; komercijalna administracija za licence roba i usluga trećih lica; usluge podugovaranja, outsorsing [pomoć u poslovanju]; fakturisanje; pisanje reklamnih tekstova; prikupljanje statističkih podataka; marketing; usluge maloprodaje farmaceutskih, veterinarskih i higijenskih preparata i medicinskog materijala; iznajmljivanje prodajnih štandova; pružanje komercijalnih i poslovnih kontakt informacija; optimizacija pretraživača za promociju prodaje; optimizacija saobraćaja sa Internet stranice; usluge posredovanja u trgovini; pružanje poslovnih informacija putem Internet stranice; obezbeđivanje onlajn tržišta za kupce i prodavce roba i usluga; dizajniranje reklamnog materijala; angažovanje spoljnih firmi za administrativno upravljanje kompanijama; usluge prijavljivanja poreza; poslovno upravljanje programima za nadoknadu za druge; iznajmljivanje bilborda [panoa za reklamiranje]; usluge zakazivanja sastanaka [kancelarijske usluge]; upravljanje programima lojalnosti potrošača; pisanje tekstova za reklamne namene; registrovanje pisane komunikacije i podataka ažuriranje i održavanje; informacija u registrima; sastavljanje popisa informacija za komercijalne i reklamne svrhe; poslovno upravljanje za nezavisne pružaoce usluga; pregovaranje i zaključivanje poslovnih transakcija za treća lica; usluge poslovnog posredovanja koje se odnose na povezivanje potencijalnih privatnih ulagača sa preduzetnicima kojima su potrebna finansijska sredstva; promocija robe i usluga kroz sponzorisanje sporskih događaja; usluge praćenja konkurencije; usluge praćenja tržišta; finansijska revizija; ciljni marketing; oglašavanje na otvorenom; usluge odnosa sa medijima usluge korporativne komunikacije; iznajmljivanje kancelarijske opreme u zajedničkim radnim prostorima; usluge komercijalnog lobiranja.

Klasa 43: Usluge agencija za smeštaj [hotelski, pansioniski]; katering hrane i pića; usluge kafea; usluge kafeterija; usluge kantina; iznajmljivanje privremenog smeštaja; pansionске usluge; usluge restorana; usluge restorana za samoposluživanje; usluge snek-barova; usluge barova; iznajmljivanje stolova, stolica, stolnjaka i staklenog posuđa; iznajmljivanje prostorija za sastanke; iznajmljivanje aparata za kuvanje; iznajmljivanje automata za vodu za piće; iznajmljivanje aparata za osvetljenje*; pravljenje skulptura od hrane; usluge vašoku restorana; usluge udon i soba restorana; dekorisanje hrane; dekorisanje kolača; informacije i saveti u vezi sa pripremanjem obroka; usluge ličnog šefa kuhinje.

(210) **Ž-2019-431**

(220) 06.11.2019.

(731) Nova Pobjeda doo - Podgorica, 19. decembra br.5, Podgorica, ME

(540) **ПОБЈЕДА**
Име говори

(550) I

(511) Klasa 16: Papir, karton i proizvodi od tih materijala koji nisu obuhvaćeni drugim klasama; štamparski proizvodi; proizvodi za uvezivanje knjiga; fotografije; pribor za pisanje; ljepila (ljepljive materije za

papirnate proizvode ili za kućne potrebe); slikarski pribor; kistovi; pisaće mašine i kancelarijski pribor (osim namještaja); oprema za nastavu i obuku (osim aparata); plastični materijali za ambalažu (koji nisu obuhvaćeni drugim klasama); štamparska slova; klišeji; papir, papirnatih proizvodi i kancelarijski pribor; noževi za papir; aparati za umnožavanje; plastične folije, torbe i vrećice od plastičnog materijala, za ambalažu.

Klasa 35: Oglašavanje i reklamiranje; vođenje komercijalnih poslova; komercijalna administracija; kancelarijski poslovi; usluge koje pružaju lica ili organizacije, čija je glavna svrha: 1) pomoć u radu i upravljanju privrednim društvima, ili 2) pomoć u vođenju poslova ili komercijalnih funkcija industrijskog ili trgovačkog preduzeća, kao i usluge reklamnih ustanova koje se bave uglavnom reklamiranjem proizvoda i usluga putem svih vrsta medija; usluge koje se odnose na registraciju, prijepis, sastavljanje, kompilaciju ili sistematizaciju pisanih saopštenja i zapisa kao i obradu ili kompilaciju matematičkih ili statističkih podataka; usluge agencija za oglašavanje kao i usluge distribuiranja prospekata direktno ili poštom ili distribuiranje uzoraka; oglašavanja u vezi s drugim uslugama kao što su usluge u vezi bankarskih zajmova i oglašavanja putem radija; sortiranje za račun drugih osoba, raznih proizvoda (ne uključuje njihov prevoz) radi omogućavanja potrošaču njihovog lakšeg razgledanja i kupovine; ove usluge se mogu pružati u okviru prodavnica na malo, trgovina na veliko, posredstvom prodajnih kataloga, dopisno ili elektronskim putem, na primjer posredstvom weba ili putem telefona.

Klasa 41: Obuka; stručno osposobljavanje; razonoda; sportske i kulturne djelatnosti; usluge osoba ili ustanova koje se bave razvojem mentalnih sposobnosti lica ili životinja, kao i usluge razonode i zaokupljanja pažnje; usluge obučavanja osoba ili uvježbavanja životinja, u svim njihovim vidovima; usluge čiji je osnovni cilj razbibriga, zabava ili rekreacija lica; usluge prikazivanja javnosti umjetničkih i literarnih djela u kulturne i obrazovne svrhe.

(210) **Ž-2019-432**

(220) 06.11.2019.

(731) ALBI COMMERCE sh.p.k., Zona e Re Industriale-Veternik p.n., 10000, Prishtinë, Kosovë, RS

(540) Grata

(550) I

(740) Dalibor Roćen, 13. jul br. 10, 81000, Podgorica

(511) Klasa 29: Mlijeko; piće u kome dominira mlijeko; mlijeko za kafu; zamjena za mlijeko; mlijeko u prahu; kondenzovano mlijeko; jogurt; maslac; sir; krem(pavlaka); džiza; surutka; jestive masti.

(210) **Ž-2019-434**

(220) 07.11.2019.

(731) BMJ INDUSTRIES FZ-LLC, P.O. Box: 31053, Al Jazeera Al Hamra Free Zone, Ras Al Khaimah, AE

(540) TAJ

(550) I

(740) Ana Ivanović, Bulevar Svetog Petra Cetinjskog br.149, 81000, Podgorica

(511) Klasa 34: Duvan; pribor za pušače; šibice.

(210) **Ž-2019-435**

(220) 07.11.2019.

(731) Essity Hygiene and Health Aktiebolag, „ SE-405 03, Göteborg, SE



(540)

(550) I

(740) Jasna Jusić, Dalmatinska 2, 81000, Podgorica

(511) Klasa 3: Proizvodi za njegu kože, naime krema za pranje, pjena za pranje, perinealna krema i pjena za pranje; regeneratorski, krema za čišćenje, sapuni, parfimerija, eterična ulja i gelovi, preparati za hidrataciju, losioni; jednokratne vlažne krpe impregnirane sredstvima za čišćenje ili jedinjenjima za ličnu upotrebu (nemedicinska).

Klasa 5: Apsorbujući sanitarni preparati, sanitarne salvete, tamponi, peškiri, navlake za upotrebu kao zaštita od menstruacije ili inkontinencije; higijenski ulošci; sanitarni peškiri; preparati za vaginalnu higijenu (medicinski); ulošci bez krilaca, vlažne maramice (medicinske); gaćice za sanitarne svrhe; jastučići za dojke; jastučići za dojenje; ulošci za trudnice; pelene od papira ili celuloze.

Klasa 16: Papir i papirna galanterija (ukoliko nisu obuhvaćeni drugim klasama), posebno papir za potrebe čišćenja i sušenja; papirni proizvodi za sanitarne svrhe; papirni ubrusi; krpe za pranje od papirnih proizvoda izrađenih od celuloznog materijala, uključujući pelene, maramice za lice, salvete, maramice, toaletni papir; štampani materijal, novine i časopisi, knjige; fotografije; edukativni materijali i materijali za obuku.

(210) **Ž-2019-436**

(220) 07.11.2019.

(731) Novartis AG, Basel, 4002, CH

(540) EBETREXAT

(550) I

(740) AOD MSA IP - Milojević Sekulić Advokati, Karađorđeva 65, 11000, Beograd

(511) Klasa 5: Farmaceutski preparati za ljudsku upotrebu.

(210) **Ž-2019-437**

(220) 08.11.2019.

(731) SAILUN GROUP CO.,LTD., No.588, Maoshan Road, Huangdao District, Qingdao City, Shandong, CN

(540) **BLACKHAWK**

(550) I

(740) Dalibor Roćen, ulica 13. jul br. 10, 81000, Podgorica

(511) Klasa 12: Točkovi i gazišta za vozila (traktorskog tipa) uključujući tzv. gusenice; gume za točkove za vozila; unutrašnje gume za pneumatike; automobilske gume; bicikli; pribor za krpljenje unutrašnjih guma; gume za bicikle; tvrde punjene gume za točkove za vozila; unutrašnje obloge; armature za pneumatike.

(210) **Ž-2019-440**

(220) 08.11.2019.

(731) Mylan Inc., 1000 Mylan Boulevard Canonsburg, PA 15317, US

(540) VIATRIS

(550) I

(740) Jasna Jusić, Dalmatinska 2, 81000, Podgorica

(511) Klasa 5: Farmaceutski preparati za liječenje kardiovaskularne, gastrointestinalne, neurološke, respiratorne, psihijatrijske, alergijske, dermatološke, plućne, metaboličke, mišićne, erektilne disfunkcije, infektivnih i zapaljenskih stanja, raka, dijabetesa, multipla skleroze; oralni i transdermalni kontraceptivi.

Klasa 10: Ubrizgači za medicinsku tečnost.

(210) **Ž-2019-472**

(220) 02.12.2019.

(731) Cineplexx international GmbH, Siebensterngasse 37, 1070, Bec, AT

(540) CINEPLEXX

(550) I

(740) Nataša Lalović Marić, Bulevar Mihajla Pupina 6, 11070, Beograd

(511) Klasa 35: Poslovno upravljanje vezano za poslovanje bioskopa.

Klasa 41: Razonoda; poslovanje bioskopa; bioskopska film i video produkcija; bioskopske prezentacije.

Klasa 43: Usluge koje se pružaju u kafeima, kafeterijama, restoranima, bar servisima, bifeima.

OBJAVA ŽIGOVA
PUBLICATION OF TRADEMARKS

(111) **14374**

(151) **17.10.2019.**

(210) **2017-519**

(442) 20.10.2018

(220) 29.12.2017

(731) Worldwide Spirits Supply Inc. Palm Chambers, 197 Main Street, VG 1110 Tortola, Road Town VG

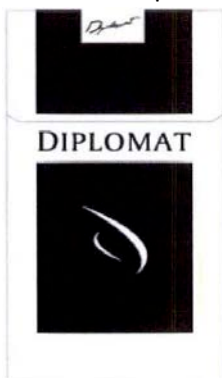

(540)

(550) I, F

(740) Kojić Ivana, Bulevar Sv. Petra Cetinjskog 106, Podgorica ME

(511) **Klasa 34:** Duvan; artikli za pušače; šibice uključujući i cigarete.

(111) **14376**

(151) **17.10.2019.**

(210) **2017-520**

(442) 20.10.2018

(220) 29.12.2017

(731) Worldwide Spirits Supply Inc. Palm Chambers, 197 Main Street, VG 1110 Tortola, Road Town VG (540)
PARK ROYAL

(550) I, V

(740) Kojić Ivana, Bulevar Sv. Petra Cetinjskog 106, Podgorica ME

(511) **Klasa 34:** Duvan; artikli za pušače; šibice uključujući i cigarete i cigare.

(111) **14375**

(151) **17.10.2019.**

(210) **2017-522**

(442) 20.10.2018

(220) 29.12.2017

(731) Gulbahar Tobacco Internation FZE P.O.Box 61401, Jebel Ali Free Zone, Dubai AE

(540) **MOMENTO**

(550) I, F

(740) Kojić Ivana, Bulevar Sv. Petra Cetinjskog 106, Podgorica ME

(511) **Klasa 34:** Duvan; artikli za pušače; šibice uključujući i cigarete i cigare.

(111) **14377**

(151) **17.10.2019.**

(210) **2017-523**

(442) 20.10.2018

(220) 29.12.2017

(731) Gulbahar Tobacco International FZE P.O.Box 61401, Jebel Ali Free Zone, Dubai AE

(540) CAVALLO

(550) I, V

(740) Kojić Ivana, Bulevar Sv. Petra Cetinjskog 106, Podgorica ME

(511) **Klasa 34:** Duvan; artikli za pušače; šibice uključujući i cigarete i cigare.

(111) **14384**

(151) **17.10.2019.**

(210) **2018-13**

(442) 20.10.2018

(220) 18.01.2018

(731) Domaća trgovina doo, Podgorica ul. Josipa Broza Tita br. 12A Podgorica ME



(540) Al Forno Pizzeria

(550) F

(511) **Klasa 35:** Trgovina na malo u nespecializovanim prodavnicama, pretežno hranom, pićem i duvanom, kao i kozmetičkog i higijenskog programa, proizvoda kućne galanterije, malih kućanskih aparata i sezonskih programa.

Klasa 43: Usluge obezbjeđivanja hrane i pića; privremeno primanje na stan.

(111) **14373**

(151) **17.10.2019.**

(210) **2018-21**

(442) 20.10.2018

(220) 23.01.2018

(731) The Goodyear Tire & Rubber Company 200 Innovation Way, 44316 Akron, Ohio US

(540) DURASHIELD TECHNOLOGY

(550) I

(740) Jusić Jasna, Dalmatinska 2, Podgorica ME

(511) **Klasa 12:** Gume.

(111) **14379**

(151) **17.10.2019.**

(210) **2018-24**

(442) 20.10.2018

(220) 31.01.2018

(731) Sun Pharma Global FZE Executive Suite Y-43, P.O.Box 122304, SAIF Zone, Sharjah AE

(540) ILUMETRI

(550) I, V

(740) Radulović Božidar, Studentska bb, Lamela 3/18, Podgorica ME

(511) **Klasa 05:** Farmaceutski preparati za liječenje i prevenciju bolesti i poremećaja autoimunog sistema; Farmaceutski preparati za liječenje i prevenciju inflamatornih oboljenja; Farmaceutski preparati za upotrebu u dermatologiji; Farmaceutski preparati za liječenje kožnih oboljenja i poremećaja; Farmaceutski preparati za liječenje psorijaze; Farmaceutski preparati za liječenje imunoloških bolesti i poremećaja; Farmaceutski preparati za liječenje gastrointestinalnih oboljenja i poremećaja;

(111) **14380**

(151) **17.10.2019.**

(210) **2018-26**

(442) 20.10.2018

(220) 02.02.2018

(731) Nippon Soda Co., Ltd. 2-2-1 Ohtemachi Chiyoda-ku Tokyo JP

(540) CYFLAMID

(550) I, V

(740) Popović Miladin, Đoka Miraševića 21/III, Podgorica ME

(511) **Klasa 05:** Fungicidi; Fungicidi za upotrebu u poljoprivredi, hortikulturi, i baštovanstvu; Insekticidi za upotrebu u poljoprivredi, hortikulturi, i baštovanstvu; Herbicidi za upotrebu u poljoprivredi, hortikulturi, i baštovanstvu; Akaricidi za upotrebu u poljoprivredi, hortikulturi, i baštovanstvu; Insekticidi za suzbijanje ternita; Preparati za uništavanje štetočina.

(111) **14387**

(151) **17.10.2019.**

(210) **2018-27**

(442) 20.10.2018

(220) 05.02.2018

(731) Jumeirah International LLC PO Box 73137 Al-Sufouh Area Dubai AE

(540) ZABEEL HOUSE

(550) I, V

(740) Popović Miladin, Đoka Miraševića 21/III, Podgorica ME

(511) **Klasa 35:** Odnosi sa javnošću, reklamiranje i oglašavanje; publicitet; reklamiranje privremenog smještaja, uključujući opremljene apartmane i apart hotele; poslovno konsultovanje: poslovno upravljanje i savjetovanje; poslovna administracija; upravljanje hotelima, opremljenim apartmanima i restoranima; franšiza, naime, konsultovanje i pomoć u poslovnom upravljanju, organizovanju i promovisanju hotelskih

usluga i ugostiteljskih usluga, hotelske usluge održavanja konferencija, sastanaka, izložbi, treninga, radionica, poslovnih sajmova, kongresa i predavanja; franšiza, naime, konsultovanje i pomoć u poslovnom upravljanju, organizovanju i promovisanju usluga privremenog smještaja, usluge rezervisanja, bukiranja i infonnisanja u vezi sa hotelima i privremenim smještajem, usluge opremljenih apartmana; franšiza, naime, konsultovanje i pomoć u poslovnom upravljanju, organizovanju i promovisanju ugovorenih usluga hrane i pića, uluge restorana, samouslužnih restorana, restorana koji nude hranu za ponijeti, kafića, kafea i snack barova; franšiza, naime konsultovanje i pomoc u poslovnom upravljanju, organizovanju i promovisanju usluga kateringa za obezbjeđivanje hrane i pića, usluga pripreme hrane i pića uključujući usluge obezbjeđivanja hrane i pića, usluge restorana. samouslužnih restorana, restorana koji nude hranu za ponijeti, kafića, kafea, snack barova. usluge pripreme hrane i pića i usluge hotela, opremljenih apartmana i privremenog smještaja; usluge maloprodaje i onlajn maloprodaje u vezi sa naočarima za sunce, pločama i video trakama, nakitom, orološkim i hronometrijskim proizvodima, kancelarijskim materijalom, štampanim publikacijama i štampanim materijalom, jastucima, ruksacima, plišanim igračkama, bilježnicama, pernicama, dnevnicima i ličnim organizatorima. čestitkama, razglednicama; usluge maloprodaje i onlajn maloprodaje u vezi sa ukrasnim papirom i trakama, namještajem, kućnim namještajem i stonim i zidnim dekoracijama, kristalom, staklarijom, porcelanom i posudom od porcelana, posudom od mesinga. ukrasima, priborom za kosu, korpama, novčanicima, torbama za laptop, priborom za šivenje, torbama napravljenim od platna, slame, plastike i PVC, posteljinom i stolnjacima; usluge maloprodaje i onlajn maloprodaje u vezi sa ručnim torbama, rančevima, torbama i putnim torbama, akt-tašnama, koferima, tašnama, držacima za kreditne kartice. novčanicima, torbama za kozmetiku, kišobranima i opremom za putovanje, odjećom, pokrivalima za glavu, obućom, tepistma i ćilimima, fotografijama i ilustracijama, igračkama, igrama, proizvodima za igranje i sport, opremom za fitnes, hranom i poslasticama, bezalkoholnim i alkoholnim pićima; usluge maloprodaje i onlajn maloprodaje u vezi sa duvanom i proizvodima od duvana i priborom za pušače; kancelarijsko i kadrovsko upravljanje; prikupljanje podataka u kompjuterske baze podataka; organizovanje izložbi i sajmova u komercijalne i reklamne svrhe; priređivanje i vođenje sajmova; iznajmljivanje reklamnog prostora; priređivanje, vođenje, upravljanje i obezbjeđivanje programa nagrađivanja lojalnosti, uključujući administriranje obezbjeđivanja benefita i nagrada u vezi sa programima nagrađivanja lojalnosti, programima potrošačkog podsticanja; administriranje programa nagrađivanja lojalnosti; reklamiranje hotelskog smještaja, restorana, hrane, pića, odmarališta, banja, golf terena. sportskih događaja, putnih aranžmana, tura i tematskih parkova kroz administraciju i podsticanje programa nagrađiva nja; obezbjeđivanje gore navedenih usluga putem globalne kompjuterske mreže; savjetodavne, konsultantske informacione usluge u vezi sa gore navedenim uslugama.

Klasa 43: Hotelske usluge; usluge privremenog smještaja; usluge rezervisanja, bukiranja i informisanja u vezi sa hotelima i privremenim smještajem; usluge opremljenih apartmana (smještaj); hotelske usluge obezbjeđivanja prostora za konferencije, sastanke, izložbe, treninge, radionice, poslovne sajmove, kongrese i predavanje; ugostiteljske usluge (smještaj I hrana i piće); snabdijevanje hranom i pićem; usluge restorana, samouslužnih restorana, restorana koji nude hranu za ponijeti, kafića, kafea, snack-barova; katering usluge za obezbjeđivanje hrane i pića; usluge pripremanja hrane i pića; iznajmljivanje privremenog smještaja; savetodavne, konsultantske I informacione usluge u vezi sa navedenim uslugama.

(111) **14372**

(151) **17.10.2019.**

(210) **2018-28**

(442) 20.10.2018

(220) 05.02.2018

(731) JT International S.A. Rue Kazem-Radjavi 8, 1202, Geneva CH

(540) EVOLVE

(550) I

(740) Jusić Jasna, Dalmatinska 2, Podgorica ME

(511) **Klasa 34:** Duvan koji je prerađen ili neprerađen; duvan za pušenje, duvan za lule, duvan za savijanje, duvan za žvakanje, duvan za sisanje, cigarete, elektronske cigarete, cigare, cigarilosi; burmut; artikli za pušače uključeni u klasu 34; papir za cigarete, fišeci za cigarete i šibice.

(111) **14403**

(151) **30.10.2019.**

(210) **2017-365**

(442) 20.01.2019

(220) 9/11/2017

(731) BioHorizons Australia Pty. Ltd., an Australian corporation, 25-33 Allen Street, Waterloo, NSW 2019, Australia, AU;

(540) BIOHORIZONS

(550) I

(740) Jusić Jasna, Dalmatinska 2, Podgorica ME

(511) Klasa 10: Medicinski i stomatološki Uređaji i proizvodi, odnosno zubni implantati, hirurške komponente, naime, zubne bušilice i specijalizovani vijci, komponente za zubne proteze;
Klasa 35: Usluge distribucije u vezi sa stomatološkim i medicinskim proizvodima implantata;
Klasa 42: Biotehnološke konsultantske usluge i istraživačke usluge u oblasti zubnih i medicinskih proizvoda implantata; usluge konsultacija na razvoju proizvoda u oblasti zubnih i medicinskih proizvoda implantata; razvoj zubnih i medicinskih proizvoda implantata;

(111) **14383**

(151) **06.12.2019.**

(210) 2017-470

(442) 20.01.2019

(220) 4/12/2017

(731) Finance plus d.o.o. Podgorica, Džordža Vašingtona 44, 81000 Podgorica, ME;



(540)

(550) I,F

(740) Nikola Pješčić, Bar, Borska 1/9;

(511) Klasa 35: Oglašavanje; vodenje poslova; poslovno upravljanje; kancelarijski poslovi; usluge koje pružaju lica ili organizacije uglavnom radi; pomoci u radu ili upravljanju preduzecima, pomoci u upravljanju poslovnom ili komercijalnom djelatnošću u industrijskim ili komercijalnim privrednim društvima; usluge koje pružaju preduzeća koja se bave oglašavanjem (reklamiranjem), tako što, za Račun drugih lica, komuniciraju sa javnošću (reklama) putem prenosa bilo kakvih informacija o svim vrstama proizvoda proizvodima i uslugama; sakupljanje u korist drugih, citavog niza roba (uključujući i njihov transport) omogućavajući klijentima da zgodno razgledaju i kupuju ovu robu; takve usluge mogu se pružati u prodavnicama na malo, rasprodajama, porudžbinama poštom preko kataloga ili putem elektronskih medija, na primjer preko web site-a ili televizijskih programa za kupovinu; u usluge koje se sastoje od registracije, transkripcije, kompozicije, kompilacije ili sistematizacije pisanih saopštenja i registracija i takode kompilacije matematičkih ili statističkih podataka; usluge reklamnih agencija i usluge kao što je dijeljenje prospekata direktno ili poštom ili distribucija uzoraka; reklamiranje u vezi sa drugim uslugama, kao što su one u vezi sa bankarskim zajmovima ili reklamiranje putem radija.

Klasa 42: Naučne i tehnološke usluge i istraživanje i projektovanje u vezi navedenih usluga; usluge industrijske analize i istraživanja; projektovanje i razvoj kompjuterskog hardvera i softvera; usluge koje pružaju lica, individualno ili kolektivno, u vezi teorijskih i praktičnih aspekata složenog polja aktivnosti; takve usluge obezbjeđuju profesionalci kao što su hemičari, fizičari, inženjeri, kompjuterski stručnjaci i drugi; usluge inženjera koje se preduzimaju radi planiranja, ocjene, istraživanja i izvještavanja u Naučnim i tehnološkim oblastima; usluge Naučnog istraživanja u medicinske svrhe.

Klasa 45: Pravne usluge; usluge obezbjeđenja radi zaštite imovine i lica; individualne i društvene usluge koje pružaju drugi, radi zadovoljavanja potreba pojedinaca; usluge koje pružaju advokati individualnim licima, grupama, organizacijama i preduzecima; usluge istrage i prismothe u vezi sigurnosti lica i entiteta; usluge koje se pružaju pojedincima u vezi društvenih dešavanja, kao što su usluge društvene pratnje, agencije za sklapanje braka, i pogrebne usluge.;

(111) **14381**

(151) **17.10.2019.**

(210) **2017-476**

(442) 20.01.2019

(220) 5/12/2017

(731) Dunhill Tobacco of London Limited, Globe House 4 Temple Place London WC2R 2PG
Ujedinjeno Kraljevstvo, UK;

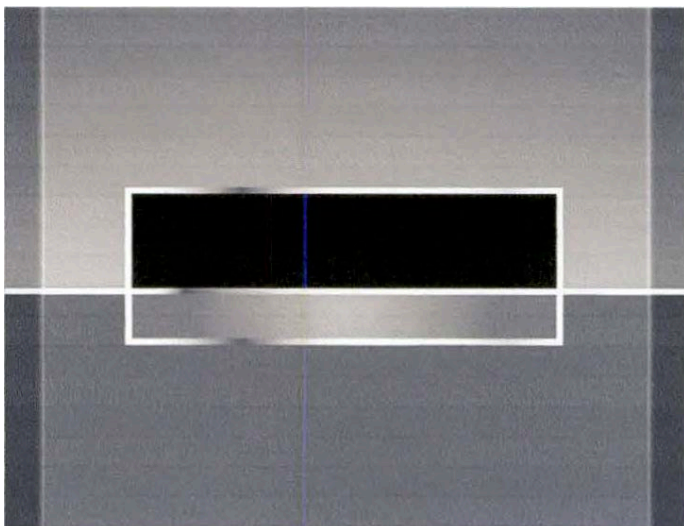

(540)

(550) I,F

(740) Popović Miladin, Đoka Miraševića 21/III, Podgorica ME

(511) Klasa 34: Cigarete; duvan, sirov ili prerađen; proizvodi od duvana; zamjene za duvan (ne u medicinske svrhe); cigare, cigarilosi; upaljaci; šibice; artikli za pušace; cigaret papir, cigaret tube, filteri za cigarete; džepni aparati za zamotavanje cigareta; rucne mešine za ubrizgavanje duvana u papirne tube; elektronske cigarete; tečnosti za elektronske cigarete; duvanski proizvodi namjenjeni za zagrijavanje.;

(111) **14417**

(151) **04.11.2019.**

(210) **2018-7**

(442) 20.01.2019

(220) 1/15/2018

(731) Instagram, LLC, 1601 Willow Road, Menlo Park, California 94025, US, US;



(540)

(550) I,F

(740) AOD "Ćupić", Dalmatinska 10, Podgorica ME

(511) **Klasa 09:** Kompjuterski hardver; kompjuterski softver za društvene mreže i interakciju sa online zajednicom; alati za razvoj kompjuterskog softvera; kompjuterski softver koji se koristi kao aplikacijski programski interfejs (API); aplikacijski programski interfejs (A PI) za kompjuterski softver koj i olakšava online usluge za društvene mreže i omogućuje povlacenje, postavljanje,

skidanje, pristup i upravljanje podacima; kompjuterski softver za kreiranje, upravljanje i interakciju sa online zajednicom; kompjuterski softver za kreiranje, obradu, postavljanje, skidanje, pristup, gledanje, pisanje, pregled, označavanje, postavljanje na blog, strimovanje, povezivanje, dodavanje napomena, ukazivanje na osjecaje, komentarisanje, usadivanje, prenos i dijeljenje iii na drugi način pružanje usluga elektronskih medija iii informacija putem interneta i komunikacionih mreža; kompjuterski softver za izmjenu i omogućavanje prenosa slika, audio, audio-vizuelnog i video sadržaja i podataka; kompjuterski softver za izmjenu fotografija, slika i audio, video, i audio-vizuelnog sadržaja sa fotografskim filterima sa efektima izmjenjene realnosti (AR),naime grafika, animacija, tekstovi, crteži, geotagovi , tagovi metapodataka, hiperlinkovi ; kompjuterski softver za prikupljanje, upravljanje, obradu, organizaciju, izmjenu, prenos, dijeljenje i skladištenje podataka i informacija; kompjuterski softver za slanje i prijem elektronskih poruka, upozorenje, obavještenje i opomene; kompjuterski pretraživački softver; kompjuterski softver za upotrebu pri kreiranju, upravljanju, mjerenju i diseminaciji reklamiranja za druge; reklamni server, naime kompjuterski server za skladištenje reklama i isporucivanje reklama web-siteovima; softver za izmjenjenu realnost; kompjuterski softver za integrisanje elektronskih podataka sa okruženjem realnog svijeta u svrhe zabave, obrazovanja, igara, komunikacije i društvenih mreža; kompjuterski softver koji omogućava razvoj , procjenu, testiranje I održavanje mobilnih softverskih aplikacija za prenosive elektronske komunikacione Uređaje, naime, mobilne telefone, smart telefone, rucne kompjutere I kompjuterske tablete; kompjuterski softver, naime, interpretativan interfejs koji omogućava interakciju između ljudi i mašina; kompjuterski softver koji prepoznaje lokaciju, kompjuterski softver koji se može skinuti i softver mobilne aplikacije za pretragu, određivanje i podjelu lokacija; kompjuterski softver za bežičnu isporuku sadržaja, podataka i informacija; kompjuterski softver koji omogućava pristup, prikazivanje, obradu, povezivanje, dijeljenje i obezbjeđivanje na drugi način elektronskih medija I informacija putem interneta i komunikacionih mreža; kompjuterski softver, naime aplikacija koja obezbjeđuje funkcionalnost društvenih mreža; kompjuterski softver, kompjuterski softver koji se može skinuti i softver mobilne aplikacije za kreiranje, upravljanje i pristup grupama u okviru virtuelnih zajednica; kompjuterski softver koji se može skinuti za pregled i interakciju sa primljenim slikama, audio, audio-vizuelnim i video sadržajem i pripadajucim tekstom i podacima; kompjuterski softver koji se može skinuti za pronalaženje sadržaja i sadržajem objavljiivača, kao i za pretp laćivanje na sadržaj ; softver za kreiranje i upravljanje profilima društvenih medija i korisničkih naloga; interaktivna fotografska i video oprema, naime kiosci za snimanje, postavljanje, uređivanje, štampanje i dijeljenje digitalnih slika i video materijala; softver koji omogućava pojedincima, grupama, kompanijama i brendovima da kreiraju i održavaju online prisustvo u marketinške svrhe, softver za oglašivace kako bi komunicirali i uzajamno djelovali sa online zajednicama; softver za strimovanje multimedijalnog zabavnog sadržaja; kompjuterski softver; kompjuterski softver za slanje i prijem elektronskih poruka, grafika, slika, audio i audio-vizuelnog sadržaja putem kompjutera, interneta i komunikacionih mreža; kompjuterski softver za obradu slika, grafika, audio, video i teksta; softver za slanje poruka.

Klasa 25: Odjeća za muskarce, žene i djecu, naime košulje, majice, jakne, gornji djelovi, duksevi, pokrivala za glavu, šeširi, kape; obuća.

Klasa 35: Usluge marketinga, oglašavanja i promocije, naime pružanje informacija o popustima, kupovcima, rabatima, vaučerima, linkovima za websiteove maloprodaje za druge, i specijalne ponude za robu i usluge drugih; pružanje usluga ispitivanja i informacija o tržištu; promocija robe i usluga drugih putem internet i komunikacionih mreža; usluge poslovanja i reklamiranja, naime medijsko planiranje i kupovina medija za druge; usluge poslovanja reklamiranja, naime usluge reklamiranja za pracenje marketinskih performansi, za upravljanje, distribuciju i prikazivanje reklama, za analizu reklamnih podataka, za izvještavanje reklamnih podataka i za optimizaciju reklamnih performansi; usluge konsultacija iz reklamne i marketinške oblasti, naime prilagodavanje reklama i marketinskog truda za druge; obezbjeđivanje online prostora za povezivanje prodavaca sa kupcima; reklamiranje, marketing i promocija roba i usluga za druge putem obezbjeđivanja foto i video opreme na specijalnim događajima; obezbjeđivanje online prostora za uživo strimovanje videa sa promotivnih događaja; organizovanje i vodenje specijalnih događaja u komercijalne, promotivne i reklamne svrhe; obezbjeđivanje online poslovnih direktorijuma koji prikazuju poslove, proizvode i usluge drugih; nijedna od gore navedenih usluga se ne odnosi na oblast energije, grijanja, hlađenja, vode, nafte, struje, gasa, detekciju dima i vatre, kontrolu osvjetljenja u okruženju, temperature, klimatizacije prostorija i komunalija, kao i na mjerenje, regulaciju, kontrolu, provjeru, snimanje, displej, prikupljanje, obradu, upravljanje, naplaćivanje i prenos podataka i informacija koje se nato odnose.

Klasa 38: Usluge dijeljenja fotografija i videa, naime elektronsko slanje digitalnih foto fajlova, videa i audio-vizuelnog sadržaja među internet korisnicima; telekomunikacija; obezbjeđivanje pristupa kompjuterskim, elektronskim i online bazama podataka; usluge telekomunikacije, naime elektronsko slanje podataka, poruka, grafika, fotografija, slika, audio, video, audio-vizuelnog sadržaja i informacija; obezbjeđivanje online foruma za komunikaciju, naime prenosi na temu od opšteg interesovanja; obezbjeđivanje online komunikacijskih linkova koji povezuju korisnike mobilnih uređaja i interneta sa drugim lokalnim i globalnim online lokacijama; obezbjeđivanje pristupa websiteovima trećih lica ili drugim elektronskim sadržajima trećih lica putem univerzalne prijave; obezbjeđivanje online chat soba, usluge email i instant poruka i elektronskih oglasnih tabli; obezbjeđivanje pristupa kompjuterskim bazama podataka iz oblasti društvenih mreža i društvenog upoznavanja i izlazaka radi zabavljanja; usluge peer-to-peer dijeljenja fotografija i podataka, naime elektronski prenos digitalnih foto fajlova, grafika i audio sadržaja među internet korisnicima; usluge telekomunikacije i peer-to-peer kompjuterske mreže, naime elektronski prenos slika, audio-vizuelnog i video sadržaja, fotografija, videa, podataka, tekstova, poruka, reklama, komunikacionih i informacionih reklamnih medija; striming i striming uživo video, audio-vizuelnog i interaktivnog audio-vizuelnog sadržaja putem interneta; usluge audio, tekst i video emitovanja preko interneta i drugih komunikacionih mreža.

Klasa 41: Usluge zabave, naime obezbjeđivanje online foruma za diseminaciju sadržaja, podataka i informacija u svrhe zabave i društvenog i poslovnog umrežavanja; usluge zabave, naime obezbjeđivanje pristupa interaktivnim elektronskim i online bazama podataka korisnički definisanog sadržaja, sadržajima trećih lica, fotografija, videa, audio, vizuelnog i audio-vizuelnog materijala iz oblasti opšteg interesovanja; usluge dijeljenja fotografija i videa; usluge elektronskog

objavljivanja za druge; online žurnali, naime weblogs (b logovi) koji prikazuju korisnički definisan sadržaj; obezbjeđivanje kompjuterskih, elektronskih i online baza podataka iz oblasti zabave; usluge objavljivanja, naime objavljivanje elektronskih publikacija za druge; izdavanje kioska za pravljenje fotografija i videografija za snimanje, postavljanje, obradu i dijeljenje slika i videa; usluge zabave, naime obezbjeđivanje online prostora za striming zabavnog sadržaja i uživo striming videa zabavnih događaja; organizovanje uživo izložbi i konferencija iz oblasti kulture, zabave i društvenih mreža u neposlovne i nekomercijalne svrhe; obezbjeđivanje zabavnih informacija iz indeksa i baza podataka informacija koje se mogu pretraživati, uključujući tekst, elektronska dokumenta, baze podataka, grafike, fotografske slike i audio-vizuelne informacije putem interneta i komunikacionih mreža; usluge zabave i obrazovanja, naime obezbjeđivanje filmova koj i se ne mogu skidati, televizijskih sou programa, web emitovanja, audiovizuelnih i multimedijalnih radova putem interneta, kao i informacije, pregledi, preporuke koje se tiču filmova, televizije, šou programa, web emitovanja, audio-vizuelnih i multimedijalnih radova.

Klasa 42: Kompjuterske usluge, naime kreiranje virtualnih zajednica za registrovane korisnike radi organizovanja grupa, sastanaka, i događaja, učestvovanja u diskusijama i angažovanja u društvenim, poslovnim mrežama i mrežama zajednice; kompjuterske usluge, naime hostovanje online web prostora za druge radi organizacije i vodenje sastanaka, događaja i interaktivnih diskusija putem interneta i komunikacionih mreža; kompjuterske usluge prilagodene elektronskom licnom i grupnom profilu iiii web stranicama koje oslikavaju korisnički definisanu ili odredenu informaciju, uključujući audio, video, slike, tekstove, sadržaje i podatke; kompjuterske usluge, naime obezbjeđivanje pretraživaca za dobijanje podataka putem internet i komunikacionih mreža; obezbjeđivanje online prostora koji oslikava tehnologiju koja omogućava online korisnicima da kreiraju licne profile koji oslikavaju društvene i poslovne mrežne informacije, kako bi prenijeli i podijelili takvu informaciju između višestrukih online prostora, radi angažovanja na društvenim mrežama i kako bi upravljali svojim naložima na društvenim mrežama; obezbjeđivanje privremenog korišćenja softvera koji se ne može skinuti, kreirajući virtuelnu zajednicu i prenos audio, video, slika, tekstova, sadržaja i podataka; pružaoc aplikacionih usluga (ASP), naime hostovanje kompjuterskih softverskih aplikacija za druge; usluge obezbjeđivanja online mreže, koja omogućava korisnicima prenos licnih podataka i dijeljenje licnih podataka sa i među višestrukim aplikacijama ili web siteovima; usluge softver kao usluga (SAAS) koji oslikava softver za slanje i prijem elektronskih poruka, napomena i upozorenja; obezbjeđivanje privremenog korišćenja online softvera koji se ne može skinuti u svrhe kreiranja, upravljanja, mjerenja, analize, diseminacije i prikaz reklama za druge; provajder online platforme za kupovinu reklame, naime obezbjeđivanje softverskih programa koji se ne mogu skinuti kako bi omogućili kupcima i prodavcima online reklamiranje da kupuju i prodaju reklamni inventar; pružaoc aplikacionih usluga (ASP) koji oslikava softver koji se koristi za kupovinu, prodaju, dizajniranje, upravljanje, nalaženje, vrednovanje, optimizaciju, ciljanje, analizu, dostavu i izvještavanje o online reklamiranju i marketingu; obezbjeđivanje online sajtova koji omogućavaju korisnicima da postave, izmjene i dijele sadržaj izmjenjene realnosti, informacije, iskustva i podatke; obezbjeđivanje privremenog korišćenja kompjuterskog softvera koji se ne može skinuti, a koji omogućava razvoj, procjenu,

testiranje i održavanje mobilne softverske aplikacije za prenosive kompjuterske Uređaje, naime mobilne telefone, smart telefone, rucne kompjutere i kompjuterske tablete; obezbjeđivanje softvera aplikacijskog programskog interfejsa (API) za upotrebu u elektronskom slanju poruka i prenosu audio, video, slika, tekstova, sadržaja i podataka; obezbjeđivanje privremenog korišćenja softvera koji se ne može skinuti za elektronske poruke; usluge mapiranja; obezbjeđivanje privremenog pristupa kompjuterskom softveru koji se ne može skinuti za usluge mapiranja; pružaoc aplikacionih usluga (ASP) koji oslikava softver za usluge mapiranja; obezbjeđivanje privremenog korišćenja kompjuterskog softvera koji se ne može skinuti za dijeljenje i prikazivanje lokacije korisnika, planiranje aktivnosti sa drugim korisnicima i davanje preporuka; pružaoc aplikacionih usluga (ASP) koji oslikava softver koj i omogućava ili obezbjeđuje dijeljenje i prikaz lokacije korisnika, planiranje aktivnosti sa drugim korisnicima i davanje preporuka; obezbjeđivanje privremenog korišćenja kompjuterskog softvera koji se ne može skinuti za mapiranje društva i destinacije; obezbjdivanje privremenog korišćenja kompjuterskog softvera koji prepoznaje lokaciju i koji se ne može skinuti, za pretragu, utvrđivanje i dijeljenje lokacije roba, usluga i događaja od interesa; pružaoc aplikacionih usluga (ASP) koji oslikava softver koji prepoznaje lokaciju za pretragu, utvrđivanje i dijeljenje lokacija roba, usluga i događaja od interesa; platforma kao servis (PAAS) koji sadrži kompjuterske softverske platforme za upotrebu u kupovini i diseminaciji reklama; dizajniranje i razvoj kompjuterskog softvera; obezbjeđivanje web sitea koji omogućava korisnicima sposobnost angažovanja na društvenim mrežama i u upravljanju njihovim sadržajem na društvenim mrežama; obezbjeđivanje privremenog korišćenja softvera koji se ne može skinuti za kreiranje i upravljanje profilima društvenih medija i korisničkih naloga; obezbjeđivanje privremenog korišćenja softvera koji se ne može skinuti za modifikaciju fotografija, slika i audio, video i audio-video sadržaja sa fotografskim filterima i efektima izmjenjene realnosti (AR), naime grafika, animacija, tekstovi, crteži, geo tagova, tagova metapodataka, hiperlinkova; obezbjeđivanje privremenog korišćenja softvera koji se ne može skinuti za gledanje I interakciju sa prilivom elektronskih medija, naime slika, audio-vizuelnog i video sadržaja, video striming uživo, komentarisanje, reklamiranje, vijesti i internet linkovi; obezbjeđivanje privremenog korišćenja kompjuterskog softvera koji se ne može skinuti za pronalaženje sadržaja i sadržaja objavljivača i za pretplatu na sadržaj ; obezbjeđivanje privremenog korišćenja softvera koji se ne može skinuti za organizovanje slika, videa, i audio-vizuelnog sadržaja korišćenjem tagova meta podataka; obezbjeđivanje pretraživaca radi dobijanja podataka putem komunikacionih mreža; kompjuterske usluge, naime kreiranje virtuelne zajednice za registrovane korisnike da dijele, gledaju, pretplacuju se i uzajamno djeluju sa slikama, aud io-vizuelnim i video sadržajima i srodnim podacima i informacijama; pružaoc aplikacionih usluga (ASP) koji oslikava softver za društvene mreže, upravljanje sadržajem društvenih mreža, kreiranje virtuelne zajednice i prenos slika, audio-vizuelnog i video sadržaja, fotografija, videa, podataka, tekstova, poruka, reklama, komunikacije i infonnacije medijskog reklamiranja; pružaoc aplikacionih usluga (ASP) koji oslikava softver aplikacijskog programskog interfejsa (API) koji omogućava online usluge za društvene mreže, razvoj softverskih aplikacija I kupovinu i diseminaciju reklama; platforma kao servis (PAAS) koji sadrži platforme sa računarskim softverom za društvene mreže, upravljanje sadržajem društvenih

mreža, stvaranje virtuelne zajednice I slanje slika, audio-vizuelnog i video sadržaja, fotografija, videa, podataka, tekstova, poruka, reklama, komunikacija i informacija medijskog reklamiranja; izdavanje kompjuterskog softvera koji omogućava korisnicima da postavljaju, uređuju i dijele slike, videa, i audio-vizuelni sadržaj; kompjuterske usluge, naime odabir korisnički definisanog sadržaja i reklame i kreiranje priliva društvenih mreža; obezbjeđivanje privremenog korišćenja softvera koji se ne može skinuti za slikanje i snimanje audio, audio-vizuelnog i video sadržaja; obezbjeđivanje privremenog korišćenja softvera koji se ne može skinuti za postavljanje, skidanje, arhiviranje, omogućavanje prenosa i dijeljenje slika, audio-vizuelnog I video sadržaja i pripadajućeg teksta i podataka; obezbjeđivanje privremenog korišćenja softvera koji se ne može skinuti za strimovanje multimedijalnog zabavnog sadržaja; obezbjeđivanje privremenog korišćenja softvera koji se ne može skinuti za slanje i prijem tekst poruka, video poruka, i grafičke komunikacije; obezbjeđivanje privremenog korišćenja softvera koji se ne može skinuti za kreiranje I održavanje online prisustva za pojedince, grupe, kompanije i brendove; obezbjeđivanje privremenog korišćenja softvera koji se ne može skinuti za kreiranje, upravljanje i diseminaciju reklama, i za mjerenje i analizu reklamnih podataka; obezbjeđivanje privremenog korišćenja softvera koji se ne može skinuti za oglašivace radi komunikacije i interakcije sa online zajednicama; obezbjeđivanje privremenog korišćenja softvera koji se ne može skinuti za upotrebu pri slikanju i prikazivanju fotografija i snimanje I obrada videa; pružaoc aplikacionih usluga (ASP) koji sadrži softver koji omogućava ili potpomažeslikanje i obradu fotografija i snimanja i obradu videa; razvoj kompjuterskog softvera; obezbjeđivanje online softvera koji se ne može skinuti; pružaoc aplikacionih usluga (ASP); obezbjeđivanje online opreme koja omogućava korisnicima da postavljaju, modifikuju i dijele audio, video, fotografske slike, tekstove, grafike i podatke.

Klasa 45: Usluge društvenog upoznavanja na inernetu, mrežama i usluge upoznavanja radi ostvarivanja veze; obezbjeđivanje pristupa kompjuterskim bazama podataka i online bazama podataka koje se mogu pretražiti iz oblasti društvenih mreža, društvenog upoznavanja i upoznavanja radi ostvarivanja veze.;

(111) **14418**

(151) **04.11.2019.**

(210) **2018-8**

(442) 20.01.2019

(220) 1/15/2018

(731) Instagram, LLC, 1601 Willow Road, Menlo Park, California 94025, US, US;

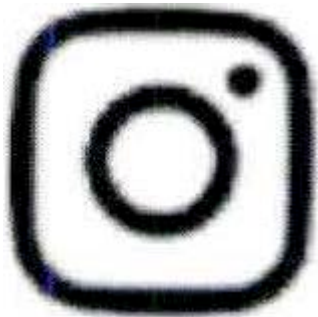

(540)

(550) I,F

(740) AOD "Ćupić", Dalmatinska 10, Podgorica ME

(511) **Klasa 09:** Kompjuterski hardver; kompjuterski softver za društvene mreže i interakciju sa online zajednicom; alati za razvoj kompjuterskog softvera; kompjuterski softver koji se koristi kao aplikacijski programski interfejs (API); aplikacijski programski interfejs (A PI) za kompjuterski softver koji olakšava online usluge za društvene mreže i omogućuje povlacenje, postavljanje, skidanje, pristup i upravljanje podacima; kompjuterski softver za kreiranje, upravljanje i interakciju sa online zajednicom; kompjuterski softver za kreiranje, obradu, postavljanje, skidanje, pristup, gledanje, pisanje, pregled, označavanje, postavljanje na blog, strimovanje, povezivanje, dodavanje napomena, ukazivanje na osjecaje, komentarisanje, usadivanje, prenos i dijeljenje ili na drugi način pružanje usluga elektronskih medija ili informacija putem interneta i komunikacionih mreža; kompjuterski softver za izmjenu i omogućavanje prenosa slika, audio, audio-vizuelnog i video sadržaja i podataka; kompjuterski softver za izmjenu fotografija, slika i audio, video, i audio-vizuelnog sadržaja sa fotografskim filterima sa efektima izmjenjene realnosti (AR),naime grafika, animacija, tekstovi, crteži, geotagovi , tagovi metapodataka, hiperlinkovi ; kompjuterski softver za prikupljanje, upravljanje, obradu, organizaciju, izmjenu, prenos, dijeljenje i skladištenje podataka i informacija; kompjuterski softver za slanje i prijem elektronskih poruka, upozorenje, obavještenje i opomene; kompjuterski pretraživački softver; kompjuterski softver za upotrebu pri kreiranju, upravljanju, mjerenju i diseminaciji reklamiranja za druge; reklamni server, naime kompjuterski server za skladištenje reklama i isporucivanje reklama web-siteovima; softver za izmjenjenu realnost; kompjuterski softver za integrisanje elektronskih podataka sa okruženjem realnog svijeta u svrhe zabave, obrazovanja, igara, komunikacije i društvenih mreža; kompjuterski softver koji omogućava razvoj , procjenu, testiranje i održavanje mobilnih softverskih aplikacija za prenosive elektronske komunikacione Uređaje, naime, mobilne telefone, smart telefone, rucne kompjutere i kompjuterske tablete; kompjuterski softver, naime, interpretativan interfejs koji omogućava interakciju između ljudi i mašina; kompjuterski softver koji prepoznaje lokaciju, kompjuterski softver koji se može skinuti i softver mobilne aplikacije za pretragu, određivanje i podjelu lokacija; kompjuterski softver za bežičnu isporuku sadržaja, podataka i informacija; kompjuterski softver koji omogućava pristup, prikazivanje, obradu, povezivanje, dijeljenje i obezbjeđivanje na drugi način elektronskih medija i informacija putem interneta i komunikacionih mreža; kompjuterski softver, naime aplikacija koja obezbjeđuje funkcionalnost društvenih mreža; kompjuterski softver, kompjuterski softver koji se može skinuti i softver mobilne aplikacije za kreiranje, upravljanje i

pristup grupama u okviru virtuelnih zajednica; kompjuterski softver koji se može skinuti za pregled i interakciju sa primljenim slikama, audio, audio-vizuelnim i video sadržajem i pripadajucim tekstom i podacima; kompjuterski softver koji se može skinuti za pronalaženje sadržaja i sadržajem objavljiivača, kao i za pretp laćivanje na sadržaj ; softver za kreiranje i upravljanje profilima društvenih medija i korisničkih naloga; interaktivna fotografska i video oprema, naime kiosci za snimanje, postavljanje, uredivanje, štampanje i dijeljenje digitalnih slika i video materijala; softver koji omogućava pojedincima, grupama, kompanijama i brendovima da kreiraju i održavaju online prisustvo u marketinške svrhe, softver za oglašivace kako bi komunicirali i uzajamno djelovali sa online zajednicama; softver za strimovanje multimedijalnog zabavnog sadržaja; kompjuterski softver; kompjuterski softver za slanje i prijem elektronskih poruka, grafika, slika, audio i audio-vizuelnog sadržaja putem kompjutera, interneta i komunikacionih mreža; kompjuterski softver za obradu slika, grafika, audio, video i teksta; softver za slanje poruka.

Klasa 25: Odjeća za muskarce, žene i djecu, naime košulje, majice, jakne, gornji djelovi, duksevi, pokrivala za glavu, šeširi, kape; obuća.

Klasa 35: Usluge marketinga, oglašavanja i promocije, naime pružanje informacija o popustima, kupovcima, rabatima, vaucerima, linkovima za websiteove maloprodaje za druge, i specijalne ponude za robu i usluge drugih; pružanje usluga ispitivanja i informacija o tržištu; promocija robe i usluga drugih putem internet i komunikacionih mreža; usluge poslovanja i reklamiranja, naime medijsko planiranje I kupovina medija za druge; usluge poslovanja reklamiranja, naime usluge reklamiranja za pracenje marketinskih performansi, za upravljanje, distribuciju i prikazivanje reklama, za analizu reklamnih podataka, za izvještavanje reklamnih podataka i za optimizaciju reklamnih performansi; usluge konsultacija iz reklamne i marketinške oblasti, naime prilagodavanje reklama i marketinskog truda za druge; obezbjeđivanje online prostora za povezivanje prodavaca sa kupcima; reklamiranje, marketing I promocija roba i usluga za druge putem obezbjeđivanja foto i video opreme na specijalnim događajima; obezbjeđivanje online prostora za uživo strimovanje videa sa promotivnih događaja; organizovanje I vodenje specijalnih događaja u komercijalne, promotivne iii reklamne svrhe; obezbjeđivanje online poslovnih direktorijuma koji prikazuju poslove, proizvode i usluge drugih; nijedna od gore navedenih usluga se ne odnosi na oblast energije, grijanja, hlađenj, a, vode, nafte, struje, gasa, detekciju dima i vatre, kontrolu osvjetljenja u okruženju, temperature, klimatizacije prostorija i komunalija, kao i na mjerenje, regulaciju, kontrolu, provjeru, snimanje, displej, prikupljanje, obradu, upravljanje, nap laćivanje i prenos podataka i informacija koje se nato odnose.

Klasa 38: Usluge dijeljenja fotografija i videa, naime elektronsko slanje digitalnih foto fajlova, videa i audio-vizuelnog sadrlžaja među internet korisnicima; telekomunikacija; obezbjeđivanje pristupa kompjuterskim, elektronskim i online bazama podataka; usluge telekomunikacije, naime elektronsko slanje podataka, poruka, grafika, fotografija, slika, audio, video, audio-vizuelnog sadržaja i informacija; obezbjeđivanje online foruma za komunikaciju, naime prenosi na temu od opšteg interesovanja; obezbjeđivanje online komunikacijskih linkova koji povezuju korisnike mobilnih Uređaja i interneta sa drugim lokalnim i globanim online lokacijama; obezbjeđivanje pristupa websiteovima trećih lica ili drugim elektronskim sadržajima trećih lica putem univerzalne

prijave; obezbjeđivanje online chat soba, usluge email i instant poruka i elektronskih oglasnih tabli; obezbjeđivanje pristupa kompjuterskim bazama podataka iz oblasti društvenih mreža i društvenog upoznavanja i izlazaka radi zabavljanja; usluge peer-to-peer dijeljenja fotografija i podataka, naime elektronski prenos digitalnih foto fajlova, grafika i audio sadržaja među internet korisnicima; usluge telekomunikacije i peer-to-peer kompjuterske mreže, naime elektronski prenos slika, audio-vizuelnog i video sadržaja, fotografija, videa, podataka, tekstova, poruka, reklama, komunikacionih i informacionih reklamnih medija; striming i striming uživo video, audio-vizuelnog i interaktivnog audio-vizuelnog sadržaja putem interneta; usluge audio, tekst i video emitovanja preko interneta i drugih komunikacionih mreža.

Klasa 41: Usluge zabave, naime obezbjeđivanje online foruma za diseminaciju sadržaja, podataka i informacija u svrhe zabave i društvenog i poslovnog umrežavanja; usluge zabave, naime obezbjeđivanje pristupa interaktivnim elektronskim i online bazama podataka korisnički definisanog sadržaja, sadržajima trećih lica, fotografija, videa, audio, vizuelnog i audio-vizuelnog materijala iz oblasti opšteg interesovanja; usluge dijeljenja fotografija i videa; usluge elektronskog objavljivanja za druge; online žurnali, naime weblogs (b logovi) koji prikazuju korisnički definisan sadržaj; obezbjeđivanje kompjuterskih, elektronskih i online baza podataka iz oblasti zabave; usluge objavljivanja, naime objavljivanje elektronskih publikacija za druge; izdavanje kioska za pravljenje fotografija i videografija za snimanje, postavljanje, obradu i dijeljenje slika i videa; usluge zabave, naime obezbjeđivanje online prostora za striming zabavnog sadržaja i uživo striming videa zabavnih događaja; organizovanje uživo izložbi i konferencija iz oblasti kulture, zabave i društvenih mreža u neposlovne i nekomercijalne svrhe; obezbjeđivanje zabavnih informacija iz indeksa i baza podataka informacija koje se mogu pretraživati, uključujući tekst, elektronska dokumenta, baze podataka, grafike, fotografske slike i audio-vizuelne informacije putem interneta i komunikacionih mreža; usluge zabave i obrazovanja, naime obezbjeđivanje filmova koji se ne mogu skidati, televizijskih šou programa, web emitovanja, audiovizuelnih i multimedijalnih radova putem interneta, kao i informacije, pregledi, preporuke koje se tiču filmova, televizije, šou programa, web emitovanja, audio-vizuelnih i multimedijalnih radova.

Klasa 42: Kompjuterske usluge, naime kreiranje virtualnih zajednica za registrovane korisnike radi organizovanja grupa, sastanaka, i događaja, učestvovanja u diskusijama i angažovanja u društvenim, poslovnim mrežama i mrežama zajednice; kompjuterske usluge, naime hostovanje online web prostora za druge radi organizacije i vodenje sastanaka, događaja i interaktivnih diskusija putem interneta i komunikacionih mreža; kompjuterske usluge prilagodene elektronskom licnom i grupnom profilu na web stranicama koje oslikavaju korisnički definisanu ili odredenu informaciju, uključujući audio, video, slike, tekstove, sadržaje i podatke; kompjuterske usluge, naime obezbjeđivanje pretraživaca za dobijanje podataka putem internet i komunikacionih mreža; obezbjeđivanje online prostora koji oslikava tehnologiju koja omogućava online korisnicima da kreiraju licne profile koji oslikavaju društvene i poslovne mrežne informacije, kako bi prenijeli i podijelili takvu informaciju između višestrukih online prostora, radi angažovanja na društvenim mrežama i kako bi upravljali svojim naložima na društvenim mrežama; obezbjeđivanje privremenog korišćenja softvera koji se ne može skinuti, kreirajući virtuelnu zajednicu i prenos

audio, video, slika, tekstova, sadržaja i podataka; pružaoc aplikacionih usluga (ASP), naime hostovanje kompjuterskih softverskih aplikacija za druge; usluge obezbjeđivanja online mreže, koja omogućava korisnicima prenos licnih podataka i dijeljenje licnih podataka sa i među višestrukim aplikacijama ili web siteovima; usluge softver kao usluga (SAAS) koji oslikava softver za slanje i prijem elektronskih poruka, napomena i upozorenja; obezbjeđivanje privremenog korišćenja online softvera koji se ne može skinuti u svrhe kreiranja, upravljanja, mjerenja, analize, diseminacije i prikaz reklama za druge; provajder online platforme za kupovinu reklame, naime obezbjeđivanje softverskih programa koji se ne mogu skinuti kako bi omogućili kupcima i prodavcima online reklamiranje da kupuju i prodaju reklamni inventar; pružaoc aplikacionih usluga (ASP) koji oslikava softver koji se koristi za kupovinu, prodaju, dizajniranje, upravljanje, nalaženje, vrednovanje, optimizaciju, ciljanje, analizu, dostavu i izvještavanje o online reklamiranju i marketingu; obezbjeđivanje online sajtova koji omogućavaju korisnicima da postavje, izmjene i dijele sadržaj izmjenjene realnosti, informacije, iskustva i podatke; obezbjeđivanje privremenog korišćenja kompjuterskog softvera koji se ne može skinuti, a koji omogućava razvoj, procjenu, testiranje i održavanje mobilne softverske aplikacije za prenosive kompjuterske Uređaje, naime mobilne telefone, smart telefone, rucne kompjutere i kompjuterske tablete; obezbjeđivanje softvera aplikacijskog programskog interfejsa (API) za upotrebu u elektronskom slanju poruka i prenosu audio, video, slika, tekstova, sadržaja i podataka; obezbjeđivanje privremenog korišćenja softvera koji se ne može skinuti za elektronske poruke; usluge mapiranja; obezbjeđivanje privremenog pristupa kompjuterskom softveru koji se ne može skinuti za usluge mapiranja; pružaoc aplikacionih usluga (ASP) koji oslikava softver za usluge mapiranja; obezbjeđivanje privremenog korišćenja kompjuterskog softvera koji se ne može skinuti za dijeljenje i prikazivanje lokacije korisnika, planiranje aktivnosti sa drugim korisnicima i davanje preporuka; pružaoc aplikacionih usluga (ASP) koji oslikava softver koj i omogućava ili obezbjeđuje dijeljenje i prikaz lokacije korisnika, planiranje aktivnosti sa drugim korisnicima i davanje preporuka; obezbjeđivanje privremenog korišćenja kompjuterskog softvera koji se ne može skinuti za mapiranje društva i destinacije; obezbjeđivanje privremenog korišćenja kompjuterskog softvera koji prepoznaje lokaciju i koji se ne može skinuti, za pretragu, utvrđivanje i dijeljenje lokacije roba, usluga i događaja od interesa; pružaoc aplikacionih usluga (ASP) koji oslikava softver koji prepoznaje lokaciju za pretragu, utvrđivanje i dijeljenje lokacija roba, usluga i događaja od interesa; platforma kao servis (PAAS) koji sadrži kompjuterske softverske platforme za upotrebu u kupovini i diseminaciji reklama; dizajniranje i razvoj kompjuterskog softvera; obezbjeđivanje web sitea koji omogućava korisnicima sposobnost angažovanja na društvenim mrežama i u upravljanju njihovim sadržajem na društvenim mrežama; obezbjeđivanje privremenog korišćenja softvera koji se ne može skinuti za kreiranje i upravljanje profilima društvenih medija i korisničkih naloga; obezbjeđivanje privremenog korišćenja softvera koji se ne može skinuti za modifikaciju fotografija, slika i audio, video i audio-video sadržaja sa fotografskim filterima i efektima izmjenjene realnosti (AR), naime grafika, animacija, tekstovi, crteži, geo tagova, tagova metapodataka, hiperlinkova; obezbjeđivanje privremenog korišćenja softvera koji se ne može skinuti za gledanje i interakciju sa prilivom elektronskih medija, naime slika, audio-vizuelnog i video sadržaja, video striming uživo,

komentarisanje, reklamiranje, vijesti i internet linkovi; obezbjeđivanje privremenog korišćenja kompjuterskog softvera koji se ne može skinuti za pronalaženje sadržaja i sadržaja objavljivača i za pretplatu na sadržaj ; obezbjeđivanje privremenog korišćenja softvera koji se ne može skinuti za organizovanje slika, videa, i audio-vizuelnog sadržaja korišćenjem tagova meta podataka; obezbjeđivanje pretraživaca radi dobijanja podataka putem komunikacionih mreža; kompjuterske usluge, naime kreiranje virtuelne zajednice za registrovane korisnike da dijele, gledaju, pretplacuju se i uzajamno djeluju sa slikama, aud io-vizuelnim i video sadržajima i srodnim podacima i informacijama; pružaoc aplikacionih usluga (ASP) koji oslikava softver za društvene mreže, upravljanje sadržajem društvenih mreža, kreiranje virtuelne zajednice i prenos slika, audio-vizuelnog i video sadržaja, fotografija, videa, podataka, tekstova, poruka, reklama, komunikacije i infonnacije medijskog reklamiranja; pružaoc aplikacionih usluga (ASP) koji oslikava softver aplikacijskog programskog interfejsa (API) koji omogućava online usluge za društvene mreže, razvoj softverskih aplikacija I kupovinu i diseminaciju reklama; platforma kao servis (PAAS) koji sadrži platforme sa računarskim softverom za društvene mreže, upravljanje sadržajem društvenih mreža, stvaranje virtuelne zajednice I slanje slika, audio-vizuelnog i video sadržaja, fotografija, videa, podataka, tekstova, poruka, reklama, komunikacija i informacija medijskog reklamiranja; izdavanje kompjuterskog softvera koji omogućava korisnicima da postave, ureduju i dijele slike, videa, i audio-vizuelni sadržaj; kompjuterske usluge, naime odabir korisnički definisanog sadržaja i reklame i kreiranje priliva društvenih mreža; obezbjeđivanje privremenog korišćenja softvera koji se ne može skinuti za slikanje i snimanje audio, audio-vizuelnog i video sadržaja; obezbjeđivanje privremenog korišćenja softvera koji se ne može skinuti za postavljanje, skidanje, arhiviranje, omogućavanje prenosa i dijeljenje slika, audio-vizuelnog I video sadržaja i pripadajućeg teksta i podataka; obezbjeđivanje privremenog korišćenja softvera koji se ne može skinuti za strimovanje multimedijalnog zabavnog sadržaja; obezbjeđivanje privremenog korišćenja softvera koji se ne može skinuti za slanje i prijem tekst poruka, video poruka, i grafičke komunikacije; obezbjeđivanje privremenog korišćenja softvera koji se ne može skinuti za kreiranje I održavanje online prisustva za pojedince, grupe, kompanije i brendove; obezbjeđivanje privremenog korišćenja softvera koji se ne može skinuti za kreiranje, upravljanje i diseminaciju reklama, i za mjerenje i analizu reklamnih podataka; obezbjeđivanje privremenog korišćenja softvera koji se ne može skinuti za oglašivace radi komunikacije i interakcije sa online zajednicama; obezbjeđivanje privremenog korišćenja softvera koji se ne može skinuti za upotrebu pri slikanju i prikazivanju fotografija i snimanje I obrada videa; pružaoc aplikacionih usluga (ASP) koji sadrži softver koji omogućava ili potpomažeslikanje i obradu fotografija i snimanja i obradu videa; razvoj kompjuterskog softvera; obezbjeđivanje online softvera koji se ne može skinuti; pružaoc aplikacionih usluga (ASP); obezbjeđivanje online opreme koja omogućava korisnicima da postave, modifikuju i dijele audio, video, fotografske slike, tekstove, grafike i podatke.

Klasa 45: Usluge društvenog upoznavanja na inernetu, mrežama i usluge upoznavanja radi ostvarivanja veze; obezbjeđivanje pristupa kompjuterskim bazama podataka i online bazama podataka koje se mogu pretražiti iz oblasti društvenih mreža, društvenog upoznavanja i upoznavanja radi ostvarivanja veze.;

(111) **14407**

(151) **31.10.2019.**

(210) **2018-82**

(442) 20.01.2019

(220) 3/15/2018

(731) Deciem Beauty Group Inc., 517 Richmond St. E., Toronto, Ontario M5A 1RA, Canada, ;

(540) THE ABNORMAL BEAUTY COMPANY

(550) I

(740) Jusić Jasna, Dalmatinska 2, Podgorica ME

(511) **Klasa 03:** Kozmetički preparati za njegu kože; proizvodi za njegu kože i tijela, naime, preparati za hidrataciju lica, preparati za hidrataciju tijela, proizvodi za zaštitu od starenja lica; proizvodi za zaštitu od starenja tijela, naime, kreme za tijelo protiv starenja, losioni, gelovi, ulja, sredstva za šišćenje, sapun za tijelo, pilinzi, preparati za hidrataciju, regeneratori za kožu, sredstva za omekšavanje kože (emolijensi) i preparati za njegu kože koji uklanjaju bore; topikalni (lokalni) tretmani za vrat, naime, losioni, kreme, gelovi, ulja, sredstva za šišćenje, pilinzi, preparati za hidrataciju, regeneratori za kožu, sredstva za omekšavanje kože (emolijensi) i preparati za njegu kože koji uklanjaju bore na vratu; ne-medicinski tretmani za strije, naime, losioni, kreme, gelovi, ulja, sredstva za šišćenje, pilinzi, preparati za hidrataciju, regeneratori za kožu, sredstva za omekšavanje kože (emolijensi) i preparati za njegu kože za tretiranje strija; ne-medicinski tretmani za celulit, naime, losioni, kreme, gelovi, ulja, sredstva za šišćenje, preparati za hidrataciju, regeneratori za kožu za smanjenje celulita; tretmani za izbjeljivanje i I iii tretmani za posvjetljivanje kože, naime, losioni, kreme, gelovi, ulja, sredstva za šišćenje, preparati za hidrataciju, regeneratori za izbjeljivanje kože i posvjetljivanje kože; proizvodi za njegu kose, naime, sprejevi za kosu, losioni za kosu, regeneratori za kosu i gel za kosu; kozmetika; preparati za šišćenje, preparati za izbjeljivanje i ostale supstance za pranje veša, odnosno izbjeljivač za pranje veša, deterdženti za pranje veša i vosak za veš; preparati za šišćenje, poliranje, ribanje i abrazivni preparati; sapuni, naime, sapuni protiv znojenja, sapuni za tijelo, sapun za kupanje i sapun za ruke; eterična ulja, losioni za kosu; paste za zube, kreme za lice i tijelo, preparati za pranje tijela, šamponi, preparati za hidrataciju tijela, kolonjska veda; toaletna veda; parfemi; dezodoransi za ličnu upotrebu.

Klasa 35: Usluge maloprodaje u oblasti kozmetike, proizvoda za ličnu njegu, kože, proizvoda za njegu lica i tijela i kozmetičkih proizvoda; onlajn maloprodajne usluge u oblasti kozmetike, proizvoda za ličnu njegu kože, proizvoda za njegu lica i tijela i kozmetičkih proizvoda.;

(111) **14404**

(151) **31.10.2019.**

(210) **2018-87**

(442) 20.01.2019

(220) 3/20/2018

(731) Amicus Pharma d.o.o., Moskovska 63-4 81000 Podgorica Crna Gora, ;

(540) FLAZAK

(550) I

(740) Popović Miladin, Đoka Miraševića 21/III, Podgorica ME

(511) **Klasa 05:** Farmaceutski, medicinski i veterinarski preparati; sanitarni preparati za upotrebu u medicini; dijetetska hrana i supstance prilagodene za upotrebu u medicini ili veterinarsku upotrebu, hrana za bebe; dijetetski dodaci (dodaci ishrani) za ljude i životinje; flasteri, materijali za zavijanje; materijali za plombiranje zuba, zubarska smola; dezinfekciona sredstva; preparati za uništavanje životinjskih štetocina; fungicidi, herbicidi.;

(111) **14406**

(151) **31.10.2019.**

(210) **2018-89**

(442) 20.01.2019

(220) 3/20/2018

(731) Goodyear Dunlop Tires UK Limited, 2920 Trident Court, Solihull Parkway Birmingham Business Park, Birmingham, B37 7YN, United Kingdom, ;

(540) TRAILMAX MIXTOUR

(550) I

(740) Jusić Jasna, Dalmatinska 2, Podgorica ME

(511) **Klasa 12:** Gume za motocikle.;

(111) **14432**

(151) **08.11.2019.**

(210) **2018-90**

(442) 20.01.2019

(220) 3/23/2018

(731) Western Digital Technologies, Inc., 5601 Great Oaks Parkway San Jose, California 95119 United States of America, ;

(540) UPTHERE

(550) I

(740) MSA IP Milojević Sekulić, Karađorđeva 65, Beograd SR

(511) **Klasa 09:** Aparati za snimanje, prenos i reprodukovanje zvuka ili slika; audio muzički plejeri; aparati za snimanje medija; Uređaji za audio reprodukciju; jedinice za čuvanje rezervne kopije za računare; prazne fleš memorijske kartice; prazni USB priključci; torbe za prenos računarskog hardvera (opreme); aparati za računarsku analizu, naime, integrisani hardver računara koji sadrži sistem firmvera i softvera za upravljanje centrima podataka velikih razmjera, analizu podataka, skladištenje podataka, i analizu performansi sistema skladištenja; disk drajveri za računare; računarski hardver i softver za skladištenje podataka; računarski hardver koji obuhvata šasiju, kucište, napajanje, kablove; računarski hardver za otpremanje, skladištenje, pronalaženje, preuzimanje, prenos i isporuku digitalnog sadržaja; računarski hardver, naime, jedinice hard

diskova i poluprovodničkih diskova; računarski hardver; računarska memorija; Uređaji računarske memorije; Uređaji za skladištenje računarskih mreža, naime, medijski plejeri, prazni digitalni mediji za skladištenje, prenosivi hard diskovi, jedinice poluprovodničkih diskova, fles memorijske jedinice, hibridne disk jedinice i kompjuterske periferne jedinice za skladištenje i čuvanje rezervnih elektronskih podataka bilo lokalno ili preko telekomunikacione mreže ili preko oblaka; Uređaji za skladištenje računarske mreže, odnosno skladištenje i čuvanje rezervnih elektronskih podataka bilo lokalno ili preko telekomunikacione mreže; futrole za prenos kompjuterskih perifernih jedinica; kompjuterske periferne jedinice; računarski proizvodi koji se koriste za prenos, prosledivanje, prikazivanje i reprodukciju tekstova, podataka, audio i video datoteka, digitalnih slika i multimedijalnog sadržaja sa Uređaja za skladištenje podataka, hard diskova, diskova i računarskih perifernih jedinica na televizore, video monitore, projektore, računare i mobilne Uređaje, naime, računarske tablete, pametne telefone, laptopove; računarski softver koji omogućava pronalaženje podataka; računarski softver; Uređaji za čuvanje podataka na računaru, naime, Uređaji za mrežno pohranjivanje podataka za dijeljenje datoteka i čuvanje rezervnih datoteka u oblaku; Uređaji za čuvanje podataka na računaru, naime, hardver za računarsku memoriju, hard diskovi za računare i poluprovodnički (SSD) Uređaji za računare; Uređaji za čuvanje podataka na računaru, naime, sistemi ili podsistemi za skladištenje i arhiviranje elektronskih podataka; hardver za skladištenje na računaru u obliku sistema ili podsistema za skladištenje i arhiviranje elektronskih podataka; komponente računara; kablovi za prenos podataka za upotrebu u računarstvu; softver za kompresiju podataka; oprema za obradu podataka; Uređaji za skladištenje podataka, naime, jedinice hard diskova, jedinice digitalnih diskova, medijski plejeri, prazni digitalni mediji za skladištenje, prenosive jedinice hard diskova, jedinice poluprovodničkih diskova, fleš memorijske jedinice, jedinice hibridnih diskova i kompjuterske periferne jedinice; Uređaji za skladištenje podataka; programi za skladištenje podataka; dijagnostički aparati, koji nisu za medicinsku upotrebu, naime Uređaji koji se koriste za analizu i optimizaciju računarskih sistema; memorijski diskovi; disk drajveri; priključne stanice za Uređaje za skladištenje podataka, naime, jedinice hard diskova, prenosive jedinice hard diskova, jedinice poluprovodničkih diskova i jedinice hibridnih diskova; računarski softver za daljinski nadzor i analizu koji se može preuzeti; elektronski bilteni za preuzimanje; mobilne aplikacije za preuzimanje; publikacije koje se mogu preuzeti; elektricne integrisane kartice; elektronske komponente za računare; elektronske memorije; futrole za eksterne hard diskove; futrole za eksterne poluprovodničke diskove; citaci memorijskih fles kartica; fles prikljucci; memorijske fleš kartice; fleš memorijski cipovi; fleš memorija; cipovi integrisanih kola; integrisana kola; interfejsi za računare; kucišta internih hard diskova; futrola unutrašnjih poluprovodničkih jedinica; kucišta unutrašnjih poluprovodničkih jedinica; magnetni nosaci podataka, diskovi za snimanje; memorijske kartice; mp3 plejeri; prenosive fleš memorije; elektricni kablovi; jedinice za elektricno napajanje; štampana kola; Naučni aparati i instrumenti; poluprovodničke memorije i memorijski kontrolori; softver za pristup video zapisima i podacima koji se cuvaju na distribuiranim računarskim Uređajima za skladištenje; softver za kompresovanje podataka; softver za analizu i optimizaciju računarskih sistema; softver za šifrovanje podataka; softver za maksimalno skladištenje podataka; softver za upravljanje i administriranje Uređaja za

čuvanje podataka; poluprovodničke jedinice; Uređaji za skladištenje podataka i njihova pronalaženje; strukturalna kucišta za elektronsku i data opremu; poluprovodničke pločice za izradu integrisanih kola; kompjuterske priključne stanice; računarski hardver za sistemsku analizu sa firmverom i softverom za upravljanje centrima podataka velikih razmjera, analizom podataka, skladištenjem podataka, i analizom performansi sistema skladištenja; hardver za računarske mreže; kompjuterske periferne jedinice; računarski softver za pracenje kompjuterskih sistema; Uređaji za čuvanje podataka na računaru, naime, hardver za mrežno pohranjivanje podataka; elektronski Uređaji za skladištenje podataka, naime, jedinice hard diskova, jedinice digitalnih diskova, prazni digitalni mediji za skladištenje, prenosivi hard diskovi, jedinice poluprovodničkih diskova, fles memorijske jedinice, hibridne disk jedinice i kompjuterske periferne jedinice; adapteri fles kartica; jedinice hard diskova; futrole internih hard diskova; montazna postolja prilagodena za računarski hardver; pokretni sistemi za čuvanje rezervnih podataka, naime, kompjuterska oprema koja se sastoji prije svega od jedinica hard diskova i poluprovodničkih diskova, a sekundarno od računarskog softvera; sistem za čuvanje rezervnih podataka zasnovan na pokretnom hard disku; USB prikljucci.

Klasa 38: Elektronski prenos podataka i dokumenata preko računarskih mreža.

Klasa 42: Računarsko programiranje; savjetovanje u oblasti računarskog softvera; analiza računarskih sistema; dizajniranje računarskih sistema; savjetovanje u oblasti dizajna i razvoja računarskog hardvera; dizajn i razvoj računarskog hardvera i softvera; usluge dizajna, razvoja, ažuriranja i održavanja podataka sa hard diskova (HOD), poluprovodničkih diskova (SSD) i računarskih Uređaja za pohranjivanje podataka; elektronsko pohranjivanje podataka; industrijska istraživanja u oblasti analize sistema i optimizacije Uređaja sa postojanom fleš memorijom, centara za čuvanje i obradu podataka, hiperskalabilnih računarskih sistema i sistema računarstva u oblaku (klaudu); pružanje informacija o računarskim tehnologijama; instaliranje računarskog softvera; održavanje ugrađenog softvera (firmvera) i softvera; pracenje računarskih sistema daljinskim pristupom; čuvanje rezervne kopije (bekapovanje) podataka van mreže; pružanje informacija o računarskim tehnologijama i programiranju; usluge tehničke podrške u oblasti računarskog hardvera i softvera; usluge tehničke podrške u oblasti računarskog hardvera, pohranjivanja računarskih podataka, pohranjivanja informacija, umrežavanje računara i interfejsova, kao i disk drajvova, Računarskih disk drajvova i elektonske memorije ; Naučne i tehnoloske usluge, istraživanje i dizajniranje u vezi sa istim; Naučne i tehnološke usluge u vidu analize sistema i optimizacije Uređaja sa postojanom fleš memorijom, centara za čuvanje i obradu podataka, analize hiperskalabilnih računarskih sistema (računarski sistemi koji imaju mogućnost dodavanja novih procesora, hard diskova i/ili memorije postojećem računarskom i/ili distributivnom okruženju, karakteristikni za servere sa velikim brojem računara) i analiza sistema računarstva u oblaku (klaudu) i optimizacija, istraživanje i dizajn svega u vezi sa gorenavedenim; server hosting; usluge tehničke podrške, naime, tehnička administracija serverima za druge i rešavanje problema u vidu dijagnostikovanja problema servera; usluge tehničke podrške, naime, rešavanje problema računarskog softvera; ažuriranje ugrađenog softvera (firmvera) i softvera; računarstvo u oblaku (klaudu); usluge kompjuterskog i elektronskog pohranjivanja podataka; usluge kompjuterske

tehnoloske podrške; usluge elektronskog pohranjivanja podataka za arhiviranje baza podataka, slika i drugih elektronskih podataka; procjene računarskih sistema daljinskim pristupom da bi se obezbjeđio pravilan rad i optimizacija navedenih sistema; usluge platformi preko računarskih softverskih platformi; ponovno uspostavljanje (oporavak) računarskih podataka; usluge tehničkog savjetovanja u oblasti informacione tehnologije; usluge tehničke podrške, naime, usluge migracije data centara, servera i aplikacija baza podataka.;

(111) **14405**

(151) **31.10.2019.**

(210) **2018-95**

(442) 20.01.2019

(220) 3/26/2018

(300) iz Azerbejdžana br. prijave 2017 33791 od 28.09.2017. godine

(731) Nicoventures Holdings Limited, Globe House 1 Water Street London WC2R 3 LA Ujedinjeno Kraljevstvo,

(540) VUSE

(550) I

(740) Popović Miladin, Đoka Miraševića 21/III, Podgorica ME

(511) **Klasa 34:** Elektronske cigarete; kertridži za elektronske cigarete; tečnosti za elektronske cigarete; cigarete koje sadrže zamjene za duvan; zamjene za duvan; cigarete; duvan; duvanski proizvodi; futrole za cigarete; kutije za cigarete. ;

(111) **14484**

(151) **03.12.2019.**

(210) **2018-99**

(442) 20.01.2019

(220) 3/30/2018

(731) HGST Netherlands B.V., Herikerbergweg 238 Luna ArenA Amsterdam 1101 CM Netherlands, ;

(540) G-TECHNOLOGY

(550) I,V

(740) MSA IP Milojević Sekulić, Karađorđeva 65, Beograd SR

(511) **Klasa 09:** Naučni aparati i instrumenti; računarski hardver; računarske periferne jedinice; računarske komponente; hardver za računarske mreže; električni kablovi; računarski softver; programi za pohranjivanje podataka; računarski softver za omogućavanje preuzimanja podataka; računarski softver za kodiranje; računarski softver za kompresiju podataka; aplikacije koje se mogu preuzeti za upotrebu na mobilnim Uređajima; računarski softver za daljinsko upravljanje i analizu koji se može preuzeti; računarski softver za procjene računarskih sistema; kablovi za prenos podataka; priključne stanice; interfejsi za računare; integrisana kola; kartice sa elektronskim integrisanim kolom; torbe za prenošenje računarskih perifernih jedinica; torbe za eksterni hard disk; torbe za eksterne SSD diskove; torbe za interne hard diskove; torbe za interne SSD diskove; kucišta za interne hard diskove; kucišta za interne SSD diskove; aparati za snimanje medija; Uređaji

za skladištenje podataka; računarska memorija; magnetni nosaci podataka, diskovi za snimanje; elektronske memorije; memorijske kartice; USB priključci; fleš memorija; adapteri za fleš kartice; citaci fleš kartica; prazni USB priključci; fleš memorijska kartica; prazne fleš memorijske kartice; prenosivi Uređaji fleš memorije; poluprovodnički memorijski Uređaji; računarski disk drajveri; hard diskovi; SSD diskovi; bačkup drajveri za računare (drajveri za čuvanje rezervnih kopija); publikacije koje se mogu preuzimati; elektronska obavještenja (bilteni) koja se mogu preuzimati.

Klasa 16: Papir; samoljepljivi papir; papir za upotrebu u proizvodnji kesa i pakovanja; kancelarijski materijal; štampane stvari; štampani priručnici; štampani prospekti; katalozi; papirne etikete; natpisi od papira ili kartona; kutije od papira; kartonske kutije; priručnici iz oblasti računarske tehnologije, računarskog hardvera, računarskog softvera, skladištenja podataka i specifikacije računarskih proizvoda; štampani pamfleti, dijagrami, brošure, priručnici, knjige, knjižice, propagandni listici, informativni reklamni materijal, informativni listovi i bilteni, samoljepljive naljepnice i kompleti koji se sastoje isključivo od jednog ili više prethodno navedenih materijala iz oblasti računarske tehnologije, računarskog hardvera, računarskog softvera, skladištenja podataka, i specifikacije računarskih proizvoda; uputstva iz oblasti računarske tehnologije, računarskog hardvera, računarskog softvera, skladištenja podataka, i specifikacije računarskih proizvoda; štampani materijal za obuku iz oblasti računarske tehnologije, računarskog hardvera, računarskog softvera, skladištenja podataka, i specifikacije računarskih proizvoda; papir za umotavanje i pakovanje; plasticna pučketava folija za umotavanje i pakovanje; plasticne ili papirne kese za pakovanje robe, koverta i vrecice; plasticna folija za pakovanje; papirne rolne za pakovanje.

Klasa 42: Naučne i tehnološke usluge; usluge elektronskog pohranjivanja za arhiviranje baza podataka, slika i drugih elektronskih podataka; savjetovanje u oblasti informacione tehnologije; dizajn i razvoj računarskog softvera; dizajn, održavanje, razvoj i ažuriranje računarskog softvera; usluge tehničkog savjetovanja koje se odnose na informacionu tehnologiju; pružanje usluga tehničkog savjetovanja koje se odnose na računarski hardver i softver; utvrđivanje problema računarskog softvera (tehnička podrška); usluge migracije podataka; čuvanje rezervne kopije podataka van mreže; ponovno uspostavljanje računarskih podataka; pružanje informacija koje se odnose na računarsku tehnologiju i programiranje.

(111) **14471**

(151) **25.11.2019.**

(210) **2018-114**

(442) 20.04.2019

(220) 11/04/2018

(731) Privatno zdravstvena ustanova- Ambulanta opšte medicine "" Medigroup Cma Gora""
Podgorica, Ul. Dalmatinska broj 30, Podgorica, ME;



(540)

(550) I,F

(740) Vanja Mugoša, Ul.Slobode 16, Podgorica, ME ;

(511) **Klasa 44:** Medicinske usluge; medicinska pomoć; medicinske klinike (usluge medicinskih klinika).

(111) **14425**

(151) **06.11.2019.**

(210) **2018-131**

(442) 20.04.2019

(220) 24/04/2018

(731) Bosnalijek, farmaceutska i hemijska industrija, dioničko društvo, Jukićeva 53, 71000 Sarajevo, Bosna i Hercegovina, BA;

(540) **BOLEX**

(550) I, V

(740) Radulović Božidar, Studenska bb, Lamela 3/18, Podgorica, ME;

(511) **Klasa 5:** Farmaceutski proizvodi.

(111) **14426**

(151) **06.11.2019.**

(210) **2018-132**

(442) 20.04.2019

(220) 24/04/2018

(731) Bosnalijek, farmaceutska i hemijska industrija, dioničko društvo, Jukićeva 53, 71000 Sarajevo, Bosna i Hercegovina, BA;

(540) **BOSFEN**

(550) I, V

(740) Radulović Božidar, Studenska bb, Lamela 3/18, Podgorica, ME;

(511) **Klasa 5:** Farmaceutski proizvodi.

(111) **14409**

(151) **01.11.2019.**

(210) **2018-134**

(442) 20.04.2019

(220) 25/04/2018

(731) Wyeth LLC, 235 East 42nd Street, 10017 New York, NY, U.S.A., US;

(540) **DUAVIVE**

(550) I, V

(740) Jusić Jasna, Dalmatinska 2, Podgorica, ME;

(511) **Klasa 5:** Farmaceutski preparati za liječenje simptoma menopauze i za spriječavanje i liječenje gubitka kostiju.

(111) **14431**

(151) **08.11.2019.**

(210) **2018-147**

(442) 20.04.2019

(220) 27/04/2018

(731) Artevos GmbH, Robert-Bunsen-Str. 7, 79108 Freiburg, Germany, DE;



(540)

(550) I, F

(740) Lutovac Branislav, Bul. Ivana Crnojevića 93, Podgorica, ME ;

(511) **Klasa 29:** Meso, riba, živina i divljač; mesni ekstrakti; konzervisano, smrznuto, sušeno i kuvano voće i povrće; žele, džemovi, kompoti; jaja, mlijeko i mliječni proizvodi; jestivo ulje i masti;

Klasa 31: Poljoprivredni, hortikulturni i šumarski proizvodi i zrnavlje, koji nisu uključeni u druge klase; žive životinje; svježe voće i povrće; sjemena, prirodne biljke i cvijeće; hrana za životinje; slad;

Klasa 32: Pivo; mineralne i gazirane vode i druga bezalkoholna pića; voćni napici i voćni sokovi; sirupi i drugi preparati za proizvodnju napitaka.

(111) **14430**

(151) **08.04.2019**

(210) **2018-148**

(442) 20.04.2019

(220) 27/04/2018

(731) Artevos GmbH, Robert-Bunsen-Str. 7, 79108 Freiburg, Germany, DE ;

(540) **ARTEVOS**

(550) I, V

(740) Lutovac Branislav, Bul. Ivana Crnojevića 93, Podgorica, ME ;

(511) **Klasa 29:** Meso, riba, živina i divljač; mesni ekstrakti; konzervisano, smrznuto, sušeno i kuvano voće i povrće; žele, džemovi, kompoti; jaja, mlijeko i mliječni proizvodi; jestivo ulje i masti;

Klasa 31: Poljoprivredni, hortikulturni i šumarski proizvodi i zrnavlje, koji nisu uključeni u druge klase; žive životinje; svježe voće i povrće; sjemena, prirodne biljke i cvijeće; hrana za životinje; slad;

Klasa 32: Pivo; mineralne i gazirane vode i druga bezalkoholna pića; voćni napici i voćni sokovi; sirupi i drugi preparati za proizvodnju napitaka.

(111) **14429**

(151) **07.11.2019.**

(210) **2018-149**

(442) 20.04.2019

(220) 27/04/2017

(731) "" INDRIT "" SH.P.K, Vlore Lagjia Rilindja, Rruga Misto Mele, Objekt Nr. 1390, kati 1, Vlore / Shqiperi, AL;



(540)

(550) I, V, F

(740) Raičević Dejan, Vojvode Boža 1., Cetinje, ME ;

(511) **Klasa 11:** Oprema za osvetljenje, grijanje, kuvanje, hlađenje, sušenje, ventilaciju; oprema za sterilizaciju vode i za grijanje vode za sanitarne svrhe.

(111) **14412**

(151) **04.11.2019.**

(210) **2018-150**

(442) 20.04.2019

(220) 27/04/2018

(731) Caesars License Company, LLC (Nevada limited liability company), One Caesars Palace Drive, Las Vegas, NV 89109, US ;

(540) **CAESARS**

(550) I, V

(740) Radulović Božidar, Studenska bb, Lamela 3/18, Podgorica , ME ;

(511) **Klasa 41:** Usluge razonode; usluge kockarnica; usluge u vezi sa igranjem igara; usluge kockanja; obezbjeđivanje objekata za kockanje; usluge u vezi sa igranjem interaktivnih igara; obezbjeđivanje internet veb sajt portala u oblasti kompjuterskih igrica i igranja igara; televizijske usluge razonode; organizovanje i pružanje igara i takmičenja u svrhu razonode; obezbjeđivanje virtualnih okruženja u kojima se korisnici mogu povezati putem društvenih igara čija je svrha rekreacija, razonoda ili zabava; organizovanje razonode za proslave vjenčanja; obezbjeđivanje objekata za zabavu; upravljanje kockarnicama; usluge noćnih klubova; usluge diskoteka; usluge kabarea; usluge pozorišta i razonode koje uključuju muziku, ples, komediju, dramu i magiju; usluge zdravstvenih klubova; usluge klubova za rekreaciju i sportskih klubova; usluge klubova na plaži i bazenu; usluge golf klubova; obezbjeđivanje objekata za golf; organizovanje golf turnira; usluge kantri klubova; obezbjeđivanje sportskih objekata; usluge zabavnih parkova; usluge tematskih parkova; usluge objekata sa arkadnim igrama; usluge centara za razonodu; usluge rezervisanja nastupa iz oblasti muzike, komedije, plesa, drame i magije; obezbjeđivanje objekata za rekreativne aktivnosti; obezbjeđivanje objekata za nastupe iz oblasti muzike, komedije, plesa, drame i magije; organizovanje i sprovođenje atletskih događaja, atletskih takmičenja i sportskih događaja; organizovanje i promovisanje sportskih aktivnosti i takmičenja; usluge produkcije radijskog i televizijskog programa; usluge produkcije videa, filmova, audio kaseta i elektronskih igara i opreme; obezbjeđivanje onlajn publikacija; onlajn objavljivanje elektronskih knjiga i časopisa; sprovođenje konjskih trka; upravljanje sportskim objektima i sportskim događajima;

obezbjedivanje fizičkog vaspitanja i gimnastičkih objekata; usluge produkcije priredbi; usluge agencija za prodaju karata za pozorišta; organizovanje sastanaka i konferencija; obrazovne usluge; obezbjeđivanje instrukcija i treninga u oblasti kockanja, sparta i rasonode; usluge obuke za upravljanje hotelima; usluge kockarnica koje uključuju davanje popusta i besplatnih usluga za česte klijente putem korišćenja identifikacijske kartice; usluge informisanja, konsultantske i savjetodavne usluge koje se odnose na sve naprijed navedeno;

Klasa 43: Usluge hotela, motela i odmarališta; usluge privremenog smještaja; usluge brendiranih rezidencija; usluge uslužnih apartmana; usluge pansiona i kuća za goste; usluge smještaja za odmor, usluge hostela i turističkih domova; usluge kampova za odmor; usluge staračkih domova; usluge rezervacije smještaja u hotelima, motelima i odmaralištima; usluge rezervacije u svrhu iznajmljivanja privremenog smještaja; usluge rezervacije za pansione, kuće za goste, smještaje za odmor, hostele i turističke domove; usluge rezervacije za brendirane rezidencije i uslužne apartmane; usluge agencije za privremene smještaje; usluge kantri kluba (pružanje smještaja, hrane i pića); obezbjeđivanje objekata i pratećih sadržaja za sastanke, konferencije, seminare, specijalne događaje (svadbe, slavlja) i bankete; obezbjeđivanje izložbenih objekata i pratećih sadržaja; usluge restorana; usluge koktel barova; usluge barova; usluge privremenih saba za ručavanje; usluge samouslužnih restorana; usluge kafea; usluge restorana brze hrane; usluge kafića; usluge keteringa; usluge samouslužnih kantina; usluge dnevnog boravka za djecu; usluge pansiona za životinje; iznajmljivanje soba za sastanke; obezbjeđivanje kampova i iznajmljivanje prenosivih građevinskih objekata.

(111) **14413**

(151) **04.11.2019.**

(210) **2018-151**

(442) 20.04.2019

(220) 27/04/2018

(731) Caesars License Company, LLC (Nevada limited liability compyny) , One Caesars Palace Drive, Las Vegas, NV 89109, US ;

(540) CAESARS PALACE

(550) I, V

(740) Radulović Božidar, Studenska bb,Lamela 3/18, Podgorica , ME ;

(511) **Klasa 41:** Usluge rasonode; usluge kockarnica; usluge u vezi sa igranjem igara; usluge kockanja; obezbjeđivanje objekata za kockanje; usluge u vezi sa igranjem interaktivnih igara; obezbjeđivanje internet veb sajt portala u oblasti kompjuterskih igrica i igranja igara; televizijske usluge rasonode; organizovanje i pružanje igara i takmičenja u svrhu rasonode; obezbjeđivanje virtualnih okruženja u kojima se korisnici mogu povezati putem društvenih igara cija je svrha rekreacija, rasonoda ili zabava; organizovanje rasonode za proslave vjenčanja; obezbjeđivanje objekata za zabavu; upravljanje kockarnicama; usluge noćnih klubova; usluge diskoteka; usluge kabarea; usluge pozorišta i rasonode koje uključuju muziku, ples, komediju, dramu i magiju; usluge

zdravstvenih klubova; usluge klubova za rekreaciju i sportskih klubova; usluge klubova na plaži i bazenu; usluge golf klubova; obezbjeđivanje objekata za golf; organizovanje golf turnira; usluge kantri klubova; obezbjeđivanje sportskih objekata; usluge zabavnih parkova; usluge tematskih parkova; usluge objekata sa arkadnim igrama; usluge centara za razonodu; usluge rezervisanja nastupa iz oblasti muzike, komedije, plesa, drame i magije; obezbjeđivanje objekata za rekreativne aktivnosti; obezbjeđivanje objekata za nastupe iz oblasti muzike, komedije, plesa, drame i magije; organizovanje i sprovođenje atletskih događaja, atletskih takmičenja i sportskih događaja; organizovanje i promovisanje sportskih aktivnosti i takmičenja; usluge produkcije radijskog i televizijskog programa; usluge produkcije videa, filmova, audio kasete i elektronskih igara i opreme; obezbjeđivanje onlajn publikacija; onlajn objavljivanje elektronskih knjiga i časopisa; sprovođenje konjskih trka; upravljanje sportskim objektima i sportskim događajima; obezbjeđivanje fizičkog vaspitanja i gimnastičkih objekata; usluge produkcije priredbi; usluge agencija za prodaju karata za pozorišta; organizovanje sastanaka i konferencija; obrazovne usluge; obezbjeđivanje instrukcija i treninga u oblasti kockanja, sparta i razonode; usluge obuke za upravljanje hotelima; usluge kockarnica koje uključuju davanje popusta i besplatnih usluga za česte klijente putem korišćenja identifikacijske kartice; usluge informisanja, konsultantske i savjetodavne usluge koje se odnose na sve naprijed navedeno;

Klasa 43: Usluge hotela, motela i odmarališta; usluge privremenog smještaja; usluge brendiranih rezidencija; usluge uslužnih apartmana; usluge pansiona i kuća za goste; usluge smještaja za odmor, usluge hostela i turističkih domova; usluge kampova za odmor; usluge staračkih domova; usluge rezervacije smještaja u hotelima, motelima i odmaralištima; usluge rezervacije u svrhu iznajmljivanja privremenog smještaja; usluge rezervacije za pansione, kuće za goste, smještaje za odmor, hostele i turističke domove; usluge rezervacije za brendirane rezidencije i uslužne apartmane; usluge agencije za privremene smještaje; usluge kantri kluba (pružanje smještaja, hrane i pića); obezbjeđivanje objekata i pratećih sadržaja za sastanke, konferencije, seminare, specijalne događaje (svadbe, slavlja) i bankete; obezbjeđivanje izložbenih objekata i pratećih sadržaja; usluge restorana; usluge koktel barova; usluge barova; usluge privremenih saba za ručavanje; usluge samouslužnih restorana; usluge kafea; usluge restorana brze hrane; usluge kafića; usluge keteringa; usluge samouslužnih kantina; usluge dnevnog boravka za djecu; usluge pansiona za životinje; iznajmljivanje soba za sastanke; obezbjeđivanje kampova i iznajmljivanje prenosivih građevinskih objekata.

(111) **14414**

(151) **04.11.2019.**

(210) **2018-152**

(442) 20.04.2019

(220) 27/04/2018

(731) Caesars License Company, LLC (Nevada limited liability compyny) , One Caesars Palace Drive, Las Vegas, NV 89109, US ;

(540)  CAESARS

(550) I, V

(740) Radulović Božidar, Studenska bb, Lamela 3/18, Podgorica, ME;

(511) **Klasa 41:** Usluge razonode; usluge kockarnica; usluge u vezi sa igranjem igara; usluge kockanja; obezbjeđivanje objekata za kockanje; usluge u vezi sa igranjem interaktivnih igara; obezbjeđivanje internet veb sajt portala u oblasti kompjuterskih igrica i igranja igara; televizijske usluge razonode; organizovanje i pružanje igara i takmičenja u svrhu razonode; obezbjeđivanje virtualnih okruženja u kojima se korisnici mogu povezati putem društvenih igara čija je svrha rekreacija, razonoda ili zabava; organizovanje razonode za proslave vjenčanja; obezbjeđivanje objekata za zabavu; upravljanje kockarnicama; usluge noćnih klubova; usluge diskoteka; usluge kabarea; usluge pozorišta i razonode koje uključuju muziku, ples, komediju, dramu i magiju; usluge zdravstvenih klubova; usluge klubova za rekreaciju i sportskih klubova; usluge klubova na plaži i bazenu; usluge golf klubova; obezbjeđivanje objekata za golf; organizovanje golf turnira; usluge kantri klubova; obezbjeđivanje sportskih objekata; usluge zabavnih parkova; usluge tematskih parkova; usluge objekata sa arkadnim igrama; usluge centara za razonodu; usluge rezervisanja nastupa iz oblasti muzike, komedije, plesa, drame i magije; obezbjeđivanje objekata za rekreativne aktivnosti; obezbjeđivanje objekata za nastupe iz oblasti muzike, komedije, plesa, drame i magije; organizovanje i sprovođenje atletskih događaja, atletskih takmičenja i sportskih događaja; organizovanje i promovisanje sportskih aktivnosti i takmičenja; usluge produkcije radijskog i televizijskog programa; usluge produkcije videa, filmova, audio kasete i elektronskih igara i opreme; obezbjeđivanje onlajn publikacija; onlajn objavljivanje elektronskih knjiga i časopisa; sprovođenje konjskih trka; upravljanje sportskim objektima i sportskim događajima; obezbjeđivanje fizičkog vaspitanja i gimnastičkih objekata; usluge produkcije priredbi; usluge agencija za prodaju karata za pozorišta; organizovanje sastanaka i konferencija; obrazovne usluge; obezbjeđivanje instrukcija i treninga u oblasti kockanja, sparta i razonode; usluge obuke za upravljanje hotelima; usluge kockarnica koje uključuju davanje popusta i besplatnih usluga za česte klijente putem korišćenja identifikacijske kartice; usluge informisanja, konsultantske i savjetodavne usluge koje se odnose na sve naprijed navedeno;

Klasa 43: Usluge hotela, motela i odmarališta; usluge privremenog smještaja; usluge brendiranih rezidencija; usluge uslužnih apartmana; usluge pansiona i kuća za goste; usluge smještaja za odmor, usluge hostela i turističkih domova; usluge kampova za odmor; usluge staračkih domova; usluge rezervacije smještaja u hotelima, motelima i odmaralištima; usluge rezervacije u svrhu iznajmljivanja privremenog smještaja; usluge rezervacije za pansione, kuće za goste, smještaje za odmor, hostele i turističke domove; usluge rezervacije za brendirane rezidencije i uslužne apartmane; usluge agencije za privremene smještaje; usluge kantri kluba (pružanje smještaja, hrane i pića); obezbjeđivanje objekata i pratećih sadržaja za sastanke, konferencije, seminare, specijalne događaje (svadbe, slavlja) i bankete; obezbjeđivanje izložbenih objekata i pratećih sadržaja; usluge restorana; usluge koktel barova; usluge barova; usluge privremenih saba za ručavanje; usluge samouslužnih restorana; usluge kafea; usluge restorana brze hrane; usluge

kafića; usluge kateringa; usluge samouslužnih kantina; usluge dnevnog boravka za djecu; usluge pansiona za životinje; iznajmljivanje soba za sastanke; obezbjeđivanje kampova i iznajmljivanje prenosivih građevinskih objekata.

(111) **14415**

(151) **04.11.2019.**

(210) **2018-153**

(442) 20.04.2019

(220) 27/04/2018

(731) Caesars License Company, LLC (Nevada limited liability compyny) , One Caesars Palace Drive, Las Vegas, NV 89109, US ;



(540)

(550) I,V

(740) Radulović Božidar, Studenska bb,Lamela 3/18, Podgorica , ME ;

(511) **Klasa 41:** Usluge razonode; usluge kockarnica; usluge u vezi sa igranjem igara; usluge kockanja; obezbjeđivanje objekata za kockanje; usluge u vezi sa igranjem interaktivnih igara; obezbjeđivanje internet veb sajt portala u oblasti kompjuterskih igrica i igranja igara; televizijske usluge razonode; organizovanje i pružanje igara i takmičenja u svrhu razonode; obezbjeđivanje virtualnih okruženja u kojima se korisnici mogu povezati putem društvenih igara cija je svrha rekreacija, razonoda ili zabava; organizovanje razonode za proslave vjenčanja; obezbjeđivanje objekata za zabavu; upravljanje kockarnicama; usluge noćnih klubova; usluge diskoteka; usluge kabarea; usluge pozorišta i razonode koje uključuju muziku, ples, komediju, dramu i magiju; usluge zdravstvenih klubova; usluge klubova za rekreaciju i sportskih klubova; usluge klubova na plaži i bazenu; usluge golf klubova; obezbjeđivanje objekata za golf; organizovanje golf turnira; usluge kantri klubova; obezbjeđivanje sportskih objekata; usluge zabavnih parkova; usluge tematskih parkova; usluge objekata sa arkadnim igrama; usluge centara za razonodu; usluge rezervisanja nastupa iz oblasti muzike, komedije, plesa, drame i magije; obezbjeđivanje objekata za rekreativne aktivnosti; obezbjeđivanje objekata za nastupe iz oblasti muzike, komedije, plesa, drame i magije; organizovanje i sprovođenje atletskih događaja, atletskih takmičenja i sportskih događaja; organizovanje i promovisanje sportskih aktivnosti i takmičenja; usluge produkcije radijskog i televizijskog programa; usluge produkcije videa, filmova, audio kasete i elektronskih igara i opreme; obezbjeđivanje onlajn publikacija; onlajn objavljivanje elektronskih knjiga i časopisa; sprovođenje konjskih trka; upravljanje sportskim objektima i sportskim događajima; obezbjeđivanje fizičkog vaspitanja i gimnastičkih objekata; usluge produkcije priredbi; usluge agencija za prodaju karata za pozorišta; organizovanje sastanaka i konferencija; obrazovne usluge; obezbjeđivanje instrukcija i treninga u oblasti kockanja, sparta i razonode; usluge obuke za upravljanje hotelima; usluge kockarnica koje uključuju davanje popusta i besplatnih usluga za

česte klijente putem korišćenja identifikacijske kartice; usluge informisanja, konsultantske i savjetodavne usluge koje se odnose na sve naprijed navedeno;

Klasa 43: Usluge hotela, motela i odmarališta; usluge privremenog smještaja; usluge brendiranih rezidencija; usluge uslužnih apartmana; usluge pansiona i kuća za goste; usluge smještaja za odmor, usluge hostela i turističkih domova; usluge kampova za odmor; usluge staračkih domova; usluge rezervacije smještaja u hotelima, motelima i odmaralištima; usluge rezervacije u svrhu iznajmljivanja privremenog smještaja; usluge rezervacije za pansione, kuće za goste, smještaje za odmor, hostele i turističke domove; usluge rezervacije za brendirane rezidencije i uslužne apartmane; usluge agencije za privremene smještaje; usluge kantri kluba (pružanje smještaja, hrane i pića); obezbjeđivanje objekata i pratećih sadržaja za sastanke, konferencije, seminare, specijalne događaje (svadbe, slavlja) i bankete; obezbjeđivanje izložbenih objekata i pratećih sadržaja; usluge restorana; usluge koktel barova; usluge barova; usluge privremenih saba za ručavanje; usluge samouslužnih restorana; usluge kafea; usluge restorana brze hrane; usluge kafića; usluge keteringa; usluge samouslužnih kantina; usluge dnevnog boravka za djecu; usluge pansiona za životinje; iznajmljivanje soba za sastanke; obezbjeđivanje kampova i iznajmljivanje prenosivih građevinskih objekata.

(111) **14416**

(151) **04.11.2019.**

(210) **2018-154**

(442) 20.04.2019

(220) 27/04/2018

(731) Caesars License Company, LLC (Nevada limited liability compyny) , One Caesars Palace Drive, Las Vegas, NV 89109, US ;



(540)

(550) I, F

(740) Radulović Božidar, Studenska bb, Lamela 3/18, Podgorica , ME ;

(511) **Klasa 41:** Usluge razonode; usluge kockarnica; usluge u vezi sa igranjem igara; usluge kockanja; obezbjeđivanje objekata za kockanje; usluge u vezi sa igranjem interaktivnih igara; obezbjeđivanje internet veb sajt portala u oblasti kompjuterskih igrica i igranja igara; televizijske usluge razonode; organizovanje i pružanje igara i takmičenja u svrhu razonode; obezbjeđivanje virtualnih okruženja u kojima se korisnici mogu povezati putem društvenih igara cija je svrha rekreacija, razonoda ili zabava; organizovanje razonode za proslave vjenčanja; obezbjeđivanje objekata za zabavu; upravljanje kockarnicama; usluge noćnih klubova; usluge diskoteka; usluge kabarea; usluge pozorišta i razonode koje uključuju muziku, ples, komediju, dramu i magiju; usluge

zdravstvenih klubova; usluge klubova za rekreaciju i sportskih klubova; usluge klubova na plaži i bazenu; usluge golf klubova; obezbjeđivanje objekata za golf; organizovanje golf turnira; usluge kantri klubova; obezbjeđivanje sportskih objekata; usluge zabavnih parkova; usluge tematskih parkova; usluge objekata sa arkadnim igrama; usluge centara za razonodu; usluge rezervisanja nastupa iz oblasti muzike, komedije, plesa, drame i magije; obezbjeđivanje objekata za rekreativne aktivnosti; obezbjeđivanje objekata za nastupe iz oblasti muzike, komedije, plesa, drame i magije; organizovanje i sprovođenje atletskih događaja, atletskih takmičenja i sportskih događaja; organizovanje i promovisanje sportskih aktivnosti i takmičenja; usluge produkcije radijskog i televizijskog programa; usluge produkcije videa, filmova, audio kasete i elektronskih igara i opreme; obezbjeđivanje onlajn publikacija; onlajn objavljivanje elektronskih knjiga i časopisa; sprovođenje konjskih trka; upravljanje sportskim objektima i sportskim događajima; obezbjeđivanje fizičkog vaspitanja i gimnastičkih objekata; usluge produkcije priredbi; usluge agencija za prodaju karata za pozorišta; organizovanje sastanaka i konferencija; obrazovne usluge; obezbjeđivanje instrukcija i treninga u oblasti kockanja, sparta i razonode; usluge obuke za upravljanje hotelima; usluge kockarnica koje uključuju davanje popusta i besplatnih usluga za česte klijente putem korišćenja identifikacijske kartice; usluge informisanja, konsultantske i savjetodavne usluge koje se odnose na sve naprijed navedeno;

Klasa 43: Usluge hotela, motela i odmarališta; usluge privremenog smještaja; usluge brendiranih rezidencija; usluge uslužnih apartmana; usluge pansiona i kuća za goste; usluge smještaja za odmor, usluge hostela i turističkih domova; usluge kampova za odmor; usluge staračkih domova; usluge rezervacije smještaja u hotelima, motelima i odmaralištima; usluge rezervacije u svrhu iznajmljivanja privremenog smještaja; usluge rezervacije za pansione, kuće za goste, smještaje za odmor, hostele i turističke domove; usluge rezervacije za brendirane rezidencije i uslužne apartmane; usluge agencije za privremene smještaje; usluge kantri kluba (pružanje smještaja, hrane i pića); obezbjeđivanje objekata i pratećih sadržaja za sastanke, konferencije, seminare, specijalne događaje (svadbe, slavlja) i bankete; obezbjeđivanje izložbenih objekata i pratećih sadržaja; usluge restorana; usluge koktel barova; usluge barova; usluge privremenih saba za ručavanje; usluge samouslužnih restorana; usluge kafea; usluge restorana brze hrane; usluge kafića; usluge keteringa; usluge samouslužnih kantina; usluge dnevnog boravka za djecu; usluge pansiona za životinje; iznajmljivanje soba za sastanke; obezbjeđivanje kampova i iznajmljivanje prenosivih građevinskih objekata.

(111) **13954**

(151) 18.12.2018.

(210) Ž-2016-248

(442) 20.10.2019.

(220) 14.06.2016.

(732) Goodyear Dunlop Tyres UK Limited, 2920 Trident Court, Solihull Parkway, Birmingham Business Park, B37 7YN, Birmingham, GB

(540)

(550) I

(740) Mladen Đ. Čolović, Dalmatinska 2, 81000, Podgorica, ME

(511) Klasa 12 Gume

(111) **13955**

(151) 18.12.2018.

(210) Ž-2016-243

(442) 20.10.2019.

(220) 10.06.2016.

(732) Goodyear Dunlop Tyres UK Limited, 2920 Trident Court, Solihull Parkway, Birmingham Business Park, B37 7YN, Birmingham, GB

(540)

(550) I

(740) Mladen Đ. Čolović, Dalmatinska 2, 81000, Podgorica, ME

(511) Klasa 12 Pneumatske gume

(111) **13956**

(151) 18.12.2018.

(210) Ž-2016-242

(442) 20.10.2019.

(220) 10.06.2016.

(732) Goodyear Dunlop Tyres UK Limited, 2920 Trident Court, Solihull Parkway, Birmingham Business Park, B37 7YN, Birmingham, GB

(540)

(550) I

(740) Mladen Đ. Čolović, Dalmatinska 2, 81000, Podgorica, ME

(511) Klasa 12 Pneumatske gume

(111) **13957**

(151) 18.12.2018.

(210) Ž-2016-241

(442) 20.10.2019.

(220) 10.06.2016.

(732) Goodyear Dunlop Tyres UK Limited, 2920 Trident Court, Solihull Parkway, Birmingham Business Park, B37 7YN, Birmingham, GB

(540)

(550) I

(740) Mladen Đ. Čolović, Dalmatinska 2, 81000, Podgorica, ME

(511) Klasa 12 Pneumatske gume

(111) **13977**

(151) 18.12.2018.

(210) Ž-2016-249

(442) 20.10.2019.

(220) 14.06.2016.

(732) Goodyear Dunlop Tyres UK Limited, 2920 Trident Court, Solihull Parkway, Birmingham Business Park, B37 7YN, Birmingham, GB

(540)

(550) I

(740) Mladen Đ. Čolović, Dalmatinska 2, 81000, Podgorica, ME

(511) Klasa 12 Gume

(111) **13978**

(151) 18.12.2018.

(210) Ž-2016-250

(442) 20.10.2019.

(220) 14.06.2016.

(732) Goodyear Dunlop Tyres UK Limited, 2920 Trident Court, Solihull Parkway, Birmingham Business Park, B37 7YN, Birmingham, GB

(540)

(550) I

(740) Mladen Đ. Čolović, Dalmatinska 2, 81000, Podgorica, ME

(511) Klasa 12 Gume

(111) **14211**

(151) 25.02.2019.

(210) Ž-2017-311

(442) 20.10.2019.

(220) 09.08.2017.

(732) SKS365 Malta Limited, Business Centre, St. Augustine Road, SWQ 3312, Swieqi, MT

(540)

(550) I

(740) Goran M. Gojačanin, Hilendarska 38, Beograd, RS

(511) Klasa 9 Aparati i instrumenti naučni, pomorski, geodetski, fotografski, konematografski, optički, za vaganje, merenje, signalizaciju, kontrolu (inspekciju), spasavanje i nastavu, aparati i instrumenti za provođenje, prekid, transformaciju, akumulaciju, regulisanje ili kontrolu električne energije; aparati i instrumenti za provođenje, pretvaranje, transformaciju, akumulaciju, regulaciju ili kontrolu električne struje, aparati za emitovanje, snimanje, prenos ili reprodukciju zvuka ili slike, magnetni nosači podataka, diskovi za snimanje, mehanizmi za aparate koji se pokreću novcem, muzički automati koji se pokreću kovanim novcem [džuboks]; registar kase, kalkulatori, oprema za obradu podataka, računari, softer za video igre.

Klasa 28 Igre, igračke i predmeti za igru, gimnastički i sportski artikli, ukrasi i dekoracije za božićne jelke, zabavni aparati na novčiće, aparati za igre, žetoni za igre, karte za igru, aparati za igre na sreću, aparati za igre osim onih koji su prilagođeni za upotrebu sa spoljnjim ekranom za prikaz ili monitorom, čipovi za igre na sreću.

Klasa 36 Osiguranje, poslovi vezani za nepokretnost, finansijski poslovi, novčani (monetarni) poslovi.

Klasa 41 Iznajmljivanje sportskih terena, organizacija i pružanje usluga igara i takmičenja putem interneta, organizovanje lutrije i drugih aktivnosti igara na sreću; pružanje usluga on-lajn zabave u vidu zabavnih igara, usluge igara na sreću, usluge igara pruženih onlajn sa računarske mreže, usluge klađenja.

(111) **14249**

(151) 26.07.2019.

(210) Ž-2018-45

(442) 20.10.2019.

(220) 12.02.2018.

(732) "13. jul Plantaže" a.d. PODGORICA, Put Radomira Ivanovića br. 2, 81000, Podgorica, ME

(540)



(550) I

(740) "13. jul Plantaže" a.d. PODGORICA, PUT RADOMIRA IVANOVIĆA BR.2, PODGORICA

(511) Klasa 33 Alkoholna pića (izuzev piva).

(111) **14260**

(151) 24.05.2019.

(210) Ž-2017-422

(442) 20.10.2019.

(220) 26.10.2017.

(732) SAVENCIA SA, 42 rue Rieussec, 78220, Viroflay, FR

(540)



(550) I

(740) Branislav Lutovac, Bulevar Ivana Crnojevića 93, 81000, Podgorica, ME

(511) Klasa 29 Mlijeko, sir i mliječni proizvodi; jestiva ulja i masti.

(111) **14271**

(151) 19.07.2019.

(210) Ž-2017-498

(442) 20.10.2019.

(220) 13.12.2017.

(732) BASF Agro B.V. Arnhem (NL) Freienbach Branch, Huobstrasse 3, Pfäffikon SZ, CH

(540)

(550) I

(740) Ana Stankovic Mugoša, Trg Nezavisnosti br.13, 81000, Podgorica, ME

(511) Klasa 1 Hemikalije koje se koriste u poljoprivredi, hortikulturi i šumarstvu, naročito preparati za jačanje biljaka, hemijski i / ili biološki preparati za kontrolu stresa kod biljaka;

preparati za regulisanje rasta biljaka, hemijski preparati za tretiranje sjemena; površinski- aktivna sredstva, prirodne ili vještačke hemikalije koje se koriste kao seksualni mamci ili agensi za zbunjivanje insekata.

Klasa 5 Preparati za uništavanje i suzbijanje štetočina, insekticidi, fungicidi, herbicidi, pesticidi.

(111) **14303**

(151) 16.07.2019.

(210) Ž-2016-490

(442) 20.10.2019.

(220) 25.11.2016.

(732) MC Food Specialties Inc., 1-2-2 Yurakucho, Chiyoda-ku, Tokyo, JP

(540)

(550) I

(740) Ana Stankovic Mugoša, Trg Nezavisnosti br.13, 81000, Podgorica, ME

(511) Klasa 30 Hemijski začini za upotrebu u namirnicama; pojačivači ukusa i aromatični dodaci; začini

(111) **14307**

(151) 23.12.2019.

(210) Ž-2017-496

(442) 20.10.2019.

(220) 12.12.2017.

(732) Marbo Product d.o.o., Đorđa Stanojevića 14, 11000, Beograd, RS

(540)

CHIPSY FOOTBALL EMOTIONS

(550) I

(740) Marbo Product d.o.o., Đorđa Stanojevića 14, 11000, Beograd

(511) Klasa 29 Čips od krompira.

(111) **14308**

(151) 16.07.2019.

(210) Ž-2017-485

(442) 20.10.2019.

(220) 12.07.2017.

(732) Cainiao Smart Logistics Holding Limited, Fourth Floor, One Capital Place, P.O.Box 847, 1103, Grand Cayman, KY

(540)



(550) I

(740) Jasna Jusić, Dalmatinska 2, 81000, Podgorica, ME

(511) Klasa 9 Aparati za obradu podataka; štampači za računare; kartice sa integrisanim kolima [pametne kartice]/pametne kartice [kartice sa integrisanim kolima]; elektronske publikacije koje se mogu preuzimati; računarski programi [softveri koji se mogu preuzimati]; aplikacije za računarske softvere koje se mogu preuzimati; indikatori za količinu; aparati za provjeru frankiranja/aparati za provjeru poštanskih markica; mašine za brojanje i sortiranje novca; kamkorderi; elektronske etikete za proizvode; kontrolni satovi [uređaji za evidenciju vremena]; mašine za mjerenje težine; prstenovi za kalibraciju; elektronske table za obavještenja; uređaji za globalno pozicionirajući sistem [GPS]; aparati za mjerenje brzine [fotografski]; instrumenti za geodetsko mjerenje; stereoskopski aparati; identifikacioni konci za električne žice; poluprovodnici; integrisana kola; kalem, električni; vremenski prekidači, automatski; fluorescentni ekrani; aparati za daljinsko upravljanje; električne instalacije za daljinsko upravljanje industrijskim procesima; aparati za gašenje vatre; alarmi; baterije, električne; sigurnosni tokeni [uređaji za kodiranje]; erne kutije [za snimanje podataka]; humanoidni roboti sa vještačkom inteligencijom; setovi za virtuelnu stvarnost; biocipovi; elektronski sistemi kontrole pristupa za blokiranje vrata; stanice za punjenje električnih vozila; navigacioni aparati za vozila [putni računari]; uređaji računarske memorije; računari; računarski programi, snimljeni; identifikacione kartice, magnetne; čitači barkodova; operativni računarski programi, snimljeni; kompjuterske periferne jedinice; računarski softver, snimljeni; spojnice [oprema za obradu podataka]; čitači [oprema za obradu podataka]; softveri za računarske igre; optički nosači podataka; digitalni znaci.

Klasa 16 Papir; štampane stvari; etikete od papira iiii kartona; štampane publikacije; papir za uvijanje/ papir za pakovanje; kancelarijski materijal, izuzev namještaja; materijali za crtanje; kreda za pisanje; arhitektonski modeli; materijali za pisanje; poster; knjige; geografske mape; novine; periodične publikacije; magazini [periodične publikacije]; bilteni; papirni i kartonski materijali za pakovanje [punjenje, oblaganje].

Klasa 35 Oglašavanje/reklamiranje; reklamiranje na računarskoj mreži; konsultacije u poslovnom upravljanju; poslovne informacije; komercijalna administracija za licenciranje robe i usluga trećih lica; usluge posredovanja u trgovini; pregovaranje i zaključivanje poslovnih transakcija za treća lica; pružanje poslovnih informacija putem veb stranice; promocija prodaje za druge; usluge nabavke za treća lica [kupovina proizvoda i usluga za druge poslovne subjekte]; konsultacije u vezi sa izborom osoblja; sistematizacija informacija u kompjuterskim bazama podataka; ažuriranje i održavanje podataka u računarskim bazama podataka; revizija poslovanja; iznajmljivanje automata za prodaju; usluge agencija za zapošljavanje; iznajmljivanje prodajnih standova; usluge maloprodaje iiii veleprodaje farmaceutskih, veterinarskih i higijenskih preparata i medicinskog materijala; pružanje onlajn tržišta za kupce i prodavce roba i usluga; ažuriranje i održavanje informacija u registrima; sastavljanje popisa informacija za komercijalne i reklamne svrhe; pomoć u poslovnom upravljanju;

poslovni upitnici; usluge agencija za pružanje poslovnih informacija; poslovno upravljanje i organizaciono savjetovanje; pomoć u poslovnom ili industrijskom upravljanju; stručne usluge o poslovnoj efikasnosti; marketinške studije; poslovne procjene; poslovna ispitivanja; konsultacije u vezi sa poslovnim organizovanjem; kompjutersko upravljanje podacima; prikupljanje informacija u kompjuterske baze podataka; pretraživanje podataka u računarskim datotekama za druge; optimizacija pretraživača; poslovna istraživanja; savjetodavne usluge za poslovno upravljanje; marketinška istraživanja; profesionalne poslovne konsultacije; ekonomske prognoze; organizovanje sajмова u komercijalne ili reklamne svrhe; usluge poređenja cijena; komercijalne informacije i savjeti za potrošače [kancelarija za savjetovanje potrošača]; usluge podugovaranja, autsorsing [pomoć u poslovanju]; prikupljanje statističkih podataka; pružanje komercijalnih i poslovnih kontakt informacija; poslovno upravljanje programima za nadoknadu za druge; optimizacija saobraćaja sa veb stranice.

Klasa 36 Ugovaranje osiguranja; finansijske usluge; finansiranje zakupa/ finansiranje lizinga; investiranje sredstava; procjena umjetničkih djela; iznajmljivanje nekretnina; upravljanje nekretninama; posredovanje na berzi; usluge mjenjačnica; prikupljanje priloga za dobrotvorne fondove; fiducijarni poslovi/ usluge povjerenistva; pozajmljivanje uz obezbjeđenje.

Klasa 38 Emitovanje televizijskih programa; slanje poruka; komunikacija preko računarskih terminala; usluge elektronskog biltena [telekomunikacione usluge]; obezbjeđivanje telekomunikacionih veza sa globalnom računarskom mrežom; obezbjeđenje korisnickog pristupa globalnoj računarskoj mreži; pružanje foruma [prikaonica]; pružanje pristupa bazama podataka; pružanje onlajn foruma; striming [protok] podataka; pružanje telekomunikacionih kanala za telesoping usluge; prenos digitalnih datoteka.

Klasa 39 Transport; isporuka robe; logistika transporta; špedicija; posredovanje u špediciji; posredovanje u prevozu robe; posredovanje u transportu; pakovanje robe; posredovanje u vezi sa brodovima; usluge lučkih radnika; iznajmljivanje vozila; skladištenje robe; iznajmljivanje skladišta; skladištenje; informacije o skladištenju; fizicko skladištenje elektronski sačuvanih podataka i dokumenata; iznajmljivanje ronilačkih zvona; distribucija energije; upravljanje branama kanala; isporuka pošiljki; kurirske usluge [pošiljke iii roba]; organizovanje turističkih putovanja; iznajmljivanje invalidskih kolica; lansiranje satelita za druge; usluge flasiranja [punjenja boca].

Klasa 41 Usluge nastave/obrazovne usluge/usluge pružanja obuke; organizovanje i vođenje konferencija; pokretne biblioteke/usluge pokretne biblioteke; pružanje onlajn elektronskih publikacija, koje se ne mogu preuzimati; izdavanje knjiga; onlajn izdavanje elektronskih knjiga i časopisa; pružanje onlajn muzike, koja se ne može preuzimati; pružanje onlajn videa, koji se ne mogu preuzimati; usluge razonode; usluge igara pruzenih onlajn sa računarske mreže; usluge zdravstvenih klubova [zdravstveno i fitnes vježbanje]; iznajmljivanje igračkaka; iznajmljivanje opreme za igranje; dresiranje životinja; usluge modela za umjetnike; organizovanje lutrija.

Klasa 42 Tehnička istraživanja; istraživanje i razvoj novih proizvoda za druge; kontrola kvaliteta; geološka ispitivanja terena; usluge iz oblasti hemije; klinička ispitivanja; vremenska prognoza; ispitivanje materijala; industrijski dizajn; arhitektonske usluge; dizajniranje odeće; računarsko programiranje; dizajniranje računarskog softvera; savjetovanje u oblasti dizajna i razvoja računarskog hardvera; ažuriranje računarskog softvera; održavanje računarskog softvera; analize računarskih sistema; savjetovanje u oblasti računarskog softvera; softver kao usluga [SaaS];

savjetovanje u vezi informacionih tehnologija [IT]; pružanje informacija o računarskim tehnologijama i programiranju putem veb stranice; elektronsko pohranjivanje podataka; računarstvo u oblaku; konvertovanje računarskih podataka i programa, osim fizickog konvertovanja; konsultacije o sigurnosti podataka; usluge kodiranja podatka; nadgledanje računarskih sistema radi otkrivanja neovlašćenog pristupa ili povrede podataka.

(111) **14323**

(151) 17.07.2019.

(210) Ž-2018-80

(442) 20.10.2019.

(220) 14.03.2018.

(732) "Domaća Trgovina" d.o.o. Podgorica, Ul. Josipa Broza Tita br. 23a, 81000, Podgorica, ME, ME

(540)



(550) I

(740) "Domaća Trgovina" d.o.o. Podgorica, Ul. Josipa Broza Tita br. 23a, 81000, Podgorica, ME

(511) Klasa 35 Trgovina na malo u nespecializovanim prodavnicama, pretežno hranom, pićem i duvanom, kao i kozmetičkog i higijenskog programa, proizvoda kućne galanterije, malih kućanskih aparata i sezonskih programa.

(111) **14326**

(151) 19.07.2019.

(210) Ž-2018-79

(442) 20.10.2019.

(220) 14.03.2018.

(732) "Domaća Trgovina" d.o.o. Podgorica, Ul. Josipa Broza Tita br. 23a, 81000, Podgorica, ME, ME

(540)

Naše gore list

(550) I

(740) "Domaća Trgovina" d.o.o. Podgorica, Ul. Josipa Broza Tita br. 23a, 81000, Podgorica, ME

(511) Klasa 35 Trgovina na malo u nespecializovanim prodavnicama, pretežno hranom, pićem i duvanom, kao i kozmetičkog i higijenskog programa, proizvoda kućne galanterije, malih kućanskih aparata i sezonskih programa.

(111) **14339**

(151) 29.07.2019.

(210) Ž-2017-471

(442) 20.10.2019.

(220) 12.04.2017.

(732) Nutrien Ltd., 122-1st Avenue South, Suite 500, S7K 7G3, Saskatoon, Saskatchewan, CA

(540)

(550) I

(740) Jasna Jusić, Dalmatinska 2, 81000, Podgorica, ME

(511) Klasa 1 Potaša; đubriva; hemikalije za upotrebu u proizvodnji đubriva, uključujući azot, amonijak, amonijum, kalijum, potaša, fosfat, sumpor, kalijum nitrat, amonijum nitrat, amonijum fosfat, urea, sumporna kisjelina i fosforna kisjelina; hemikalije za upotrebu u proizvodnji pesticida; poljoprivredne hemikalije, odnosno surfaktanti (supstance koje snižavaju površinski napon vode), adjuvansi (farmakoloski i imunoloski agensi koji modifikuju dejstvo drugih agenasa) i sredstva za vlaženje za upotrebu u primjeni herbicida, insekticida, pesticida i hranljivih materija; adjuvansi za upotrebu sa poljoprivrednim hemikalijama; adjuvansi za ulje za prskanje za upotrebu sa poljoprivrednim insekticidima i fungicidima; aktivni hemijski sastojci za upotrebu u proizvodnji đubriva, pesticida, herbicida, fungicida, insekticida i rodenticida; poboljšivači tla za poljoprivredu upotrebu; hranjivi dodaci za poboljšanje biološke aktivnosti vode i zemljišta u svrhu oplodnje, poboljšanja pH tla i pH vode za navodnjavanje, poboljšanja propustljivosti zemljišta i poboljšanja učinka pesticida i đubriva; hemijski preparati za upotrebu u poljoprivredi, odnosno hemijski preparati za tretman sjemena; surfaktant tla koji se koristi za unaprijeđivanje ujednačenog kretanja vode u tlu; zemljišni inokulanti (kalemi) za primjenu na sjemena koja se koriste u poljoprivredi; hemijski aditivi za đubriva; sredstvo za omekšavanje, sredstvo za širenje, sredstvo za prodiranje i surfaktant za upotrebu u vezi sa pesticidima, herbicidima, desikantima (hemijska jedinjenja koje upijaju vodu), defoliantima (hemijska jedinjenja koja uzrokuju prijevremeno opadanje lišća), insekticidima, fungicidima, akaracidima (pesticidi koji ubijaju krpelje, grinje, itd.), regulatorima rasta biljaka i hranjivim materijama koje se nanose na list (foliranje) uređaji za vodu, naime, fosfati za tretiranje pitke vode; sredstva koja sprečavaju pojavljivanje pjene, hemijska jedinjenja koja sprečavaju pojavljivanje pjene za upotrebu u poljoprivredi; aminokiseline za upotrebu sa proizvodima za hranjenje biljaka rastvorljivim u vodi; aminokiseline kao izvor azota za upotrebu sa proizvodima za hranjenje biljaka rastvorljivim u vodi; i aminokiseline kao izvori azota za upotrebu u kombinaciji sa proizvodima za hranjenje biljaka rastvorljivim u vodi formulisani za upotrebu kod dubrenja biljaka preko lista i navodnjavanje kapanjem; hranjivi sastojci za rast biljaka; biljna hrana; dodatak za tretman vode za upotrebu na zelenim površinama golf terena; rastvor ureje visoke čistoće za tretman i kontrolu emisije izduvnih gasova, azotnih oksida i azot-dioksida, odnosno hemijskih aditiva za izduvne gasove.

Klasa 5 Pesticidi; herbicidi; fungicidi; insekticidi; rodenticidi; parazitocidi.

Klasa 44 Prilagođena primjena, odnosno primjena đubriva i drugih poljoprivrednih hemikalija; agronomske konsultantske usluge; agronomske usluge, naime, konsultantske usluge u smislu pružanja informacija o usjevu i upravljanju proizvedenim usjevima i prinosima u vidu poljoprivrednih savjeta i preporuka o usjevu, preporuke za upravljanje štetocinama i preporuke o sjemenima; agronomski menadžment, naime, pružanje informacija koje se odnose na preciznu poljoprivredu i tehnologiju varijabilnih stopa koristeći globalne sisteme pozicioniranja, geografske informacione sisteme i satelitske snimke; usluge kontrole štetočina u poljoprivredi; savjetovanje u poljoprivredi i informacije u oblasti proizvodnje usjeva, planiranje usjeva, izvodljivost usjeva, sjemena za usjeve, uzgoj usjeva, monitoring usjeva, plodnost usjeva, selekciju sjemena i poboljšanje usjeva.

(111) **14343**

(151) 15.11.2019.

(210) Ž-2018-307

(442) 20.10.2019.

(220) 15.08.2018.

(732) Hemofarm A.D. farmaceutsko-hemijska industrija Vršac, Beogradski put bb, 26300, Vršac, RS
(540)

(550) I

(740) AOD MSA IP - Milojević Sekulić Advokati, Karađorđeva 65, 11000, Beograd, RS

(511) Klasa 5 Farmaceutski proizvodi.

(111) **14345**

(151) 02.08.2019.

(210) Ž-2017-119

(442) 20.10.2019.

(220) 24.03.2017.

(732) Idealism Industries FZE, P.O. Box 31291, Al Jazeera Al Hamra, Ras Al Khaimah, AE
(540)



(550) I

(740) Božidar S. Radulović, Studentska bb, Lamela 3/18, 81000, Podgorica, ME

(511) Klasa 4 Drveni ugalj, briketi drvenog uglja .

(111) **14346**

(151) 01.08.2019.

(210) Ž-2018-25

(442) 20.10.2019.

(220) 02.02.2018.

(732) ORE investiranje in upravljanje naložb d.o.o., Poljska pot 2, 1000, Ljubljana, SL

(540)



STORM

(550) I

(740) AOD "Ćupić", Bulevar Džordža Vašingtona 79, 81000, Podgorica, ME

(511) Klasa 1 Ulje za kočnice; tečnost za hidrauličke krugove; sredstva za kaljenje metala; hidrauličke tečnosti; antifriz, destilovana voda, detergentski za upotrebu u proizvodnim procesima.

Klasa 4 Industrijska mast; industrijsko ulje; tekstilno ulje; ulje, uljane repice za upotrebu u industriji; tečnosti (tekućine) za rezanje; ulja za oslobađanje ukalupljenih proizvoda (građevina)

(111) **14348**

(151) 01.08.2019.

(210) Ž-2017-514

(442) 20.10.2019.

(220) 25.12.2017.

(732) Monster Energy Company (a Delaware corporation), 1 Monster Way, 92879, Corona, California, US

(540)

PREDATOR

(550) I

(740) Monster Energy Company (a Delaware corporation), 1 Monster Way, 92879, Corona

(511) Klasa 32 Bezalkoholna pića, uključujući gazirana pića i energetska pića; sirupi, koncentri, praškasti preparati i drugi preparati za proizvodnju pića, uključujući gazirana pića i energetska pića; pivo.

(111) **14349**

(151) 01.08.2019.

(210) Ž-2017-487

(442) 20.10.2019.

(220) 12.07.2017.

(732) Cainiao Smart Logistics Holding Limited, Fourth Floor, One Capital Place, P.O.Box 847, KY1-1103, Grand Cayman, KY

(540)



(550) I

(740) Jasna Jusić, Dalmatinska 2, 81000, Podgorica, ME

(511) Klasa 9 Aparati za obradu podataka; štampači za računare; kartice sa integrisanim kolima [pametne kartice]/pametne kartice [kartice sa integrisanim kolima]; elektronske publikacije koje se mogu preuzimati; računarski programi [softveri koji se mogu preuzimati]; aplikacije za računarske softvere koje se mogu preuzimati; indikatori za količinu; aparati za provjeru frankiranja/aparati za provjeru poštanskih markica; mašine za brojanje i sortiranje novca; kamkorderi; elektronske etikete za proizvode; kontrolni satovi [uređaji za evidenciju vremena]; mašine za mjerenje težine; prstenovi za kalibraciju; elektronske table za obavještenja; uređaji za globalno pozicionirajući sistem [GPS]; aparati za mjerenje brzine [fotografski]; instrumenti za geodetsko mjerenje; stereoskopski aparati; identifikacioni konci za elektricne žice; poluprovodnici; integrisana kola; kalemi, električni; vremenski prekidači, automatski; fluorescentni ekrani; aparati za daljinsko upravljanje; električne instalacije za daljinsko upravljanje industrijskim procesima; aparati za gašenje vatre; alarmi; baterije, električne; sigurnosni tokeni [uređaji za kodiranje]; erne kutije [za snimanje podataka]; humanoidni roboti sa vještačkom inteligencijom; setovi za virtuelnu stvarnost; biocipovi; elektronski sistemi kontrole pristupa za blokiranje vrata; stanice za punjenje elektricnih vozila; navigacioni aparati za vozila [putni racunari]; uređaji računarske memorije; računari; računarski programi, snimljeni; identifikacione kartice, magnetne; čitaci barkodova; operativni računarski programi, snimljeni; kompjuterske periferne jedinice; računarski softver, snimljeni; spojnice [oprema za obradu podataka]; čitači [oprema za obradu podataka]; softveri za računarske igre; optički nosači podataka; digitalni znaci.

Klasa 16 Papir; štampane stvari; etikete od papira iii kartona; štampane publiikacije; papir za uvijanje/ papir za pakovanje; kancelarijski materijal, izuzev namještaja; materijali za crtanje; kreda za pisanje; arhitektonski modeli; materijali za pisanje; poster; knjige; geografske mape; novine; periodične publiikacije; magazini [periodične publikacije]; bilteni; papirni i kartonski materijali za pakovanje [punjenje, oblaganje].

Klasa 35 Oglašavanje/reklamiranje; reklamiranje na računarskoj mreži; konsultacije u poslovnom upravljanju; poslovne informacije; komercijalna administracija za licenciranje robe i usluga trećih

lica; usluge posredovanja u trgovini; pregovaranje i zaključivanje poslovnih transakcija za treća lica; pružanje poslovnih informacija putem veb stranice; promocija prodaje za druge; usluge nabavke za treća lica [kupovina proizvoda i usluga za druge poslovne subjekte]; konsultacije u vezi sa izborom osoblja; sistematizacija informacija u kompjuterskim bazama podataka; ažuriranje i održavanje podataka u računarskim bazama podataka; revizija poslovanja; iznajmljivanje automata za prodaju; usluge agencija za zapošljavanje; iznajmljivanje prodajnih standova; usluge maloprodaje i veleprodaje farmaceutskih, veterinarskih i higijenskih preparata i medicinskog materijala; pružanje onlajn tržišta za kupce i prodavce roba i usluga; ažuriranje i održavanje informacija u registrima; sastavljanje popisa informacija za komercijalne i reklamne svrhe; pomoć u poslovnom upravljanju; poslovni upitnici; usluge agencija za pružanje poslovnih informacija; poslovno upravljanje i organizaciono savjetovanje; pomoć u poslovnom ili industrijskom upravljanju; stručne usluge o poslovnoj efikasnosti; marketinške studije; poslovne procjene; poslovna ispitivanja; konsultacije u vezi sa poslovnim organizovanjem; kompjutersko upravljanje podacima; prikupljanje informacija u kompjuterske baze podataka; pretraživanje podataka u računarskim datotekama za druge; optimizacija pretraživača; poslovna istraživanja; savjetodavne usluge za poslovno upravljanje; marketinška istraživanja; profesionalne poslovne konsultacije; ekonomske prognoze; organizovanje sajmova u komercijalne ili reklamne svrhe; usluge poređenja cijena; komercijalne informacije i savjeti za potrošače [kancelarija za savjetovanje potrošača]; usluge podugovaranja, outsorsing [pomoć u poslovanju]; prikupljanje statističkih podataka; pružanje komercijalnih i poslovnih kontakt informacija; poslovno upravljanje programima za nadoknadu za druge; optimizacija saobraćaja sa veb stranice.

Klasa 36 Ugovaranje osiguranja; finansijske usluge; finansiranje zakupa/ finansiranje lizinga; investiranje sredstava; procjena umjetničkih djela; iznajmljivanje nekretnina; upravljanje nekretninama; posredovanje na berzi; usluge mjenjačnica; prikupljanje priloga za dobrotvorne fondove; fiducijarni poslovi/ usluge povjerenistva; pozajmljivanje uz obezbjeđenje.

Klasa 38 Emitovanje televizijskih programa; slanje poruka; komunikacija preko računarskih terminala; usluge elektronskog biltena [telekomunikacione usluge]; obezbjeđivanje telekomunikacionih veza sa globalnom računarskom mrežom; obezbjeđenje korisnickog pristupa globalnoj računarskoj mreži; pružanje foruma [pričaonica]; pružanje pristupa bazama podataka; pružanje onlajn foruma; striming [protok] podataka; pružanje telekomunikacionih kanala za telesoping usluge; prenos digitalnih datoteka.

Klasa 39 Transport; isporuka robe; logistika transporta; špedicija; posredovanje u špediciji; posredovanje u prevozu robe; posredovanje u transportu; pakovanje robe; posredovanje u vezi sa brodovima; usluge lučkih radnika; iznajmljivanje vozila; skladištenje robe; iznajmljivanje skladišta; skladištenje; informacije o skladištenju; fizicko skladištenje elektronski sačuvanih podataka i dokumenata; iznajmljivanje ronilačkih zvonja; distribucija energije; upravljanje branama kanala; isporuka pošiljki; kurirske usluge [pošiljke i roba]; organizovanje turističkih putovanja; iznajmljivanje invalidskih kolica; lansiranje satelita za druge; usluge flisanja [punjenja boca].

Klasa 41 Usluge nastave/obrazovne usluge/usluge pružanja obuke; organizovanje i vođenje konferencija; pokretne biblioteke/usluge pokretne biblioteke; pružanje onlajn elektronskih publikacija, koje se ne mogu preuzimati; izdavanje knjiga; onlajn izdavanje elektronskih knjiga i časopisa; pružanje onlajn muzike, koja se ne može preuzimati; pružanje onlajn videa, koji se ne

moгу preuzimati; usluge razonode; usluge igara pruzenih onlajn sa računarske mreže; usluge zdravstvenih klubova [zdravstveno i fitnes vježbanje]; iznajmljivanje igračkaka; iznajmljivanje opreme za igranje; dresiranje životinja; usluge modela za umjetnike; organizovanje lutrija.

Klasa 42 Tehnička istraživanja; istraživanje i razvoj novih proizvoda za druge; kontrola kvaliteta; geološka ispitivanja terena; usluge iz oblasti hemije; klinička ispitivanja; vremenska prognoza; ispitivanje materijala; industrijski dizajn; arhitektonske usluge; dizajniranje odeće; računarsko programiranje; dizajniranje računarskog softvera; savjetovanje u oblasti dizajna i razvoja računarskog hardvera; ažuriranje računarskog softvera; održavanje računarskog softvera; analize računarskih sistema; savjetovanje u oblasti računarskog softvera; softver kao usluga [SaaS]; savjetovanje u vezi informacionih tehnologija [IT]; pružanje informacija o računarskim tehnologijama i programiranju putem veb stranice; elektronsko pohranjivanje podataka; računarstvo u oblaku; konvertovanje računarskih podataka i programa, osim fizickog konvertovanja; konsultacije o sigurnosti podataka; usluge kodiranja podatka; nadgledanje računarskih sistema radi otkrivanja neovlašćenog pristupa ili povrede podataka.

(111) **14350**

(151) 08.07.2019.

(210) Ž-2017-408

(442) 20.10.2019.

(220) 17.10.2017.

(732) APPLE INC, 1 Infinite Loop, 95014, Cupertino, California, US

(540)

(550) I

(740) Jasna Jusić, Dalmatinska 2, 81000, Podgorica, ME

(511) Klasa 9 Kompjuteri; kompjuterski hardver; rucni kompjuter; tablet kompjuteri; telekomunikacioni aparati i instrumenti; telefoni; mobilni telefoni; pametni telefoni; komunikacioni uredaji za bezicni prenos glasa, podataka, slika, audio, video i multimedijalnog sadrzaja; mrezni komunikacioni aparati; rucni digitalni elektronski uredaji koji mogu da obezbijede pristup internetu i da salju, primaju i smjestaju telefonske pozive, elektronsku postu i druge digitalne podatke; nosivi kompjuterski hardver; nosivi digitalni elektronski uredaji koji mogu da obezbijede pristup internetu ida salju, primaju i smjestaju telefonske pozive, elektronsku postu i druge digitalne podatke; pametni satovi; pametne naocare; pametni prstenovi; nosivi sistem za pracenje aktivnosti; povezane narukvice [mjerni instrumenti]; elektronski citaci knjiga; kompjuterski softver; kompjuterski softver za podesavanje, konfigurisanje, rad i kontrolu kompjutera, kompjuterskih periferija, mobilnih uredaja, mobilnih telefona, pametnih satova, pametnih naocara, nosivih uredaja, slusalice koje se stavljaju u usi, slusalice koje se stavljaju preko usiju, televizora, dekodera (set top box), audio i video plejera i rekordera, sistema kucnog bioskopa i sistema za zabavu; softver za razvijanje aplikacija; softver za kompjuterske igrice; prethodno

snimljeni audio, video i multimedijalni sadržaj koji se može preuzimati; kompjuterski periferni uređaji; periferni uređaji za kompjutere, mobilne telefone, mobilne elektronske uređaje, nosive elektronske uređaje, pametne telefone, pametne naocare, slusalice koje se stavljaju u uši, slusalice koje se stavljaju preko usiju, televizore, dekodere (set top box), audio i video plejere i rekordere; nosive periferne jedinice za kompjutere, mobilne telefone, mobilne elektronske uređaje, pametne satove, pametne naocare, pametne prstenove, slusalice koje se stavljaju u uši, slusalice koje se stavljaju preko usiju, televizori, dekoderi (set up boxes) i audio i video plejeri i rekorderi; biometrijski aparati za utvrđivanje identiteta i vjerodostojnosti; mjeraci ubrzanja; visinomjeri; aparati za mjerenje rastojanja; aparati za bilježenje rastojanja; pedometri (mjeraci koraka); aparati za mjerenje pritiska; pokazivaci pritiska; monitori, ekrani, naocare za virtuelnu stvarnost i slusalice za kompjutere, pametne telefone, mobilne elektronske uređaje, nosive elektronske uređaje, pametne satove, pametne naocare, televizore, dekodere (smart top boxes) i audio i video plejere i rekordere; ekrani, naocare, upravljači i slusalice za virtuelnu i proširenu realnost (augmented reality); 3D naocare; naocare za vid; suncane naocare; stakla za naocare; optičko staklo; optička roba; optički aparati i instrumenti; fotografski aparati; blicevi za fotografske aparate; tastature, misevi, podloge za misa, stampaci, citaci diska i tvrdi diskovi; aparati za snimanje i reprodukciju zvuka; digitalni audio i video plejeri i rekorderi; audio zvučnici; audio pojačala i prijemnici; audio aparati za motorna vozila; aparati za snimanje i prepoznavanje glasa; slusalice koje se stavljaju u uši; slusalice koje se stavljaju preko usiju; mikrofoni; televizori; televizijski prijemnici i monitori; dekoderi (set top boxes); radio uređaji; radio odasiljači i prijemnici; korisnički interfejsi za kompjutere i elektronske uređaje u motornom vozilu, odnosno elektronski kontrolni paneli, monitori, ekrani na dodir, daljinski upravljači, dopunski uređaji za eksterne priključke, konektori, prekidači i upravljači koji se aktiviraju glasom; globalni sistem za pozicioniranje (GPS uređaji); navigacioni instrumenti; aparat za navigaciju za vozila (unutrasnji kompjuteri); daljinski upravljači za upravljanje kompjuterima, mobilnim telefonima, mobilnim elektronskim uređajima, nosivim elektronskim uređajima, pametnim satovima, pametnim naocarima, slusalicama koje se stavljaju u uši, slusalicama koje se stavljaju preko usiju, audio i video plejerima i rekorderima, televizorima, dekoderima (set top boxes), zvučnicima, pojačalima, sistemima kućnih bioskopa i sistemima za zabavu; nosivi uređaji za upravljanje kompjuterima, mobilnim telefonima, mobilnim elektronskim uređajima, pametnim satovima, pametnim naocarima, slusalicama koje se stavljaju u uši, slusalicama koje se stavljaju preko usiju, audio i video plejerima i rekorderima, televizorima, dekoderima (set top boxes), zvučnicima, pojačalima, sistemima kućnih bioskopa i sistemima za zabavu; aparati za smjestaj podataka; kompjuterski čipovi; baterije; punjači baterija; električni i elektronski konektori, spojnice, zice, kablovi, punjači, dokovi, dopunski uređaji za eksterne priključke i adapteri za kompjutere, mobilne telefone, ručne kompjutere, kompjuterske periferije, mobilne elektronske uređaje, nosive elektronske uređaje, pametne satove, pametne naocare, slusalice koje se stavljaju u uši, slusalice koje se stavljaju preko usiju, audio i video plejere i rekordere, televizore i dekodere (set top boxes); interaktivni ekrani na dodir; interfejsi za kompjutere, kompjuterske ekrane, mobilne telefone, mobilne elektronske uređaje, nosive elektronske uređaje, pametne satove, pametne naocare, televizore, dekodere (set top boxes) i audio i video plejere i rekordere; zaštitni filmovi prilagođeni kompjuterskim ekranima, ekranima mobilnih telefona i ekranima pametnih satova; djelovi i dodatna oprema za kompjutere,

kompjuterske periferije, mobilne telefone, mobilne elektronske uređaje, nosive elektronske uređaje, pametne satove, pametne naocare, slusalice koje se stavljaju u usi, slusalice koje se stavljaju preko usiju, audio i video plejere i rekordere, televizore i dekodere (set top boxes); pokrivaci, kese, futrole, navlake, remeni i uzice za kompjutere, mobilne telefone, mobilne elektronske uređaje, nosive elektronske uređaje, pametne satove, pametne naocare, slusalice koje se stavljaju u usi, slusalice koje se stavljaju preko usiju, dekodere (set top boxes) i audio i video plejere i rekordere; stapovi za autoportret fotografije (selfie); punjaci za elektricne cigarete; elektronske ogrlice za treniranje zivotinja; elektronske agende (programi rada); aparati za provjeru postanskih marki; kase; mehanizmi za aparate koji rade po principu ubacivanja :letona iii metalnih novcica; diktafoni; markeri za obilježavanje ivica; masine ze glasanje; elektronski ocitavaci robe (etikete); masine za selekciju medalja; faksimil masine; aparati i instrumenti za vaganje; instrumenti za mjerenje; elektronske table za obavjestavanje; aparati za mjerenje; podmetaCi (silikonske place); integrisana kola; pojačala; fluorescentni ekrani; daljinski upravljac; opticka vlakna; elektricne instalacije za daljinsko upravljanje industrijskim procesima; svjetlosni zaustavljac; elektrolizeri; uređaji za gasenje pozara; radioloski aparati za industrijsku namjenu; spasilacki aparati i oprema; zvizditi alarmi; animirani filmovi; jajoliki svijecnjaci; zvizdaljke za pse; dekorativni magneti; elektricne ograde, prenosivi retarderi za vozila na daljinsko upravljanje.

Klasa 28 Igracke; igrice; predmeti za igranje; karte za igru; elektronske rucne jedinice za igrice; kompjuterske igrice, video igrice i aparati za kompjuterske i video igrice, osim onih koji se pokrecu ubacivanjem :letona iii metalnih novcica iii onih koji su prilagodeni za koristenje sa televizijskim prijemnicima; aparati (oprema) za bodi bilding; masine i oprema za fitnes i vjezbanje.

Klasa 42 : Kreiranje i razvoj kompjuterskog hardvera, softvera, periferija i kompjuterskih i video igrica; usluge konsaltinga u vezi sa izradom kompjuterskog hardvera i softvera; kompjutersko programiranje; kreiranje kompjuterskih baza podataka; smjestanje elektronskih podataka; usluge racunarstva u oblaku; iznajmljivanje kompjuterskog hardvera, softvera i periferija; obezbjeđivanje putem interneta softvera koji se ne maze preuzimati; usluge konsaltinga za razvijanje kompjuterskih sistema, baza podataka i aplikacija; konsalting o kompjuterskoj bezbjednost i bezbjednosti podataka; usluge sifrovanja podataka; obezbjeđivanje informacija O kompjuterskom hardveru i softveru putem interneta; održavanja, popravka i azuriranje kompjuterskog hardvera, softvera, periferija i aplikacija; usluge tehnicke podrske, utvrđivanje i ispravljanje problema sa kompjuterskim hardverom i softverom i usluge kompjuterskog saltera za pružanje podrske; usluge kreiranje, izrade i održavanja veb sajta; usluge hostinga na veb sajtu; obezbjeđivanje masina za pretragu za dobijanje podataka putem interneta i drugih elektronskih mreza za komunikaciju; kreiranje indeksa informacija dostupnih na internetu, sajtova i drugih resursa dostupnih na internetu i drugim mreza za elektronsku komunikaciju; usluge drustvenog umrezavanja na internetu; obezbjeđivanje veb sajta za drustveno umrezavanje; usluge kartografije i izrade mapa; naucne i tehnoloske usluge; usluge industrijskog dizajna; usluge industrijskih analiza i istrazivanja; usluge pružanja informacija, savjetovanja i konsaltinga u vezi sa gorepomenutim.

(111) 14351

(151) 01.08.2019.

(210) Ž-2017-501

(442) 20.10.2019.

(220) 18.12.2017.

(732) PHARMANOVA doo društvo za proizvodnju farmaceutskih proizvoda Obrenovac, Industrijska 8, 11500, Obrenovac, RS

(540)

(550) I

(740) AOD MSA IP - Milojević Sekulić Advokati, Karađorđeva 65, 11000, Beograd, RS

(511) Klasa 5 Farmaceutski, medicinski i veterinarski preparati

(111) **14352**

(151) 16.10.2019.

(210) Ž-2018-9

(442) 20.10.2019.

(220) 17.01.2018.

(732) JT International S.A., Rue Kazem-Radjavi 8, 1202, Geneva, CH

(540)



(550) I

(740) Jasna Jusić, Dalmatinska 2, 81000, Podgorica, ME

(511) Klasa 34 Duvan koji je prerađen ili neprerađen; duvan za pušenje, duvan za lule, duvan za savijanje, duvan za žvakanje, duvan za sisanje, cigarete, elektronske cigarete, cigare, cigarilosi; burmut; artikli za pušače uključeni u klasu 34; papir za cigarete, fišeci za cigarete i šibice.

(111) **14355**

(151) 17.10.2019.

(210) Ž-2018-16

(442) 20.10.2019.

(220) 19.01.2018.

(732) PHARMANOVA DOO, Industrijska 8, 11500, Obrenovac, RS

(540)

(550) I

(740) AOD MSA IP - Milojević Sekulić Advokati, Karađorđeva 65, 11000, Beograd, RS

(511) Klasa 5 Farmaceutski preparati

(111) **14356**

(151) 17.10.2019.

(210) Ž-2018-17

(442) 20.10.2019.

(220) 19.01.2018.

(732) PHARMANOVA DOO, Industrijska 8, 11500, Obrenovac, RS

(540)

(550) I

(740) AOD MSA IP - Milojević Sekulić Advokati, Karađorđeva 65, 11000, Beograd, RS

(511) Klasa 5 Farmaceutski preparati.

(111) **14363**

(151) 10.09.2019.

(210) Ž-2018-78

(442) 20.10.2019.

(220) 14.03.2018.

(732) PHARMANOVA DOO, Industrijska 8, 11500, Obrenovac, RS

(540)

SOLD3EVIT

(550) I

(740) PHARMANOVA DOO, Industrijska 8, 11500, Obrenovac

(511) Klasa 5 Farmaceutski, medicinski i veterinarski preparati; dijetetska hrana i supstance prilagođene za upotrebu u medicini ili veterinarsku upotrebu; dijetetski dodaci (dodaci ishrani) za ljude ili životinje.

(111) **14364**

(151) 19.09.2019.

(210) Ž-2018-58

(442) 20.10.2019.

(220) 22.02.2018.

(732) Hankook Tire Co., Ltd., 133, Teheran-ro (Yeoksam-dong), Gangnam-gu, 135 723, Seoul, KR
(540)

Technotrac

(550) I

(740) AOD MSA IP - Milojević Sekulić Advokati, Karađorđeva 65, 11000, Beograd, RS

(511) Klasa 36 Upravljanje zgradama (usluge u vezi sa nekretninama); iznajmljivanje ili rentiranje zgrada; izdavanje u zakup zgrada; iznajmljivanje kancelarijskog prostora; rentiranje poslovnog prostora (nepokretnosti); pružanje informacija koje se odnose na iznajmljivanje zgrada; iznajmljivanje industrijskog prostora; ulaganje u nekretnine; usluge upravljanja nekretninama koje se odnose na trgovačke centre; usluge prodaje trgovačkih centara; iznajmljivanje trgovačkih centara; iznajmljivanje poslovnih prostorija; agencije za posredništvo u iznajmljivanju zgrada; usluge upravljanja nekretninama koje se odnose na komercijalne zgrade.

Klasa 42 Usluge istraživanja u vezi sa gumama; tehničko ispitivanje (pregled) automobilskih guma; tehničko ispitivanje (pregled) vozila; pregled (ispitivanje) motornih vozila pre prevoza (za provjeru ispravnosti); tehničko ispitivanje (pregled) motornih vozila (za provjeru ispravnosti); testiranje ispravnosti vozila; tehnički savjeti u vezi sa proizvodnjom guma; usluge analize (pregleda) guma; usluge projektovanja poslovnih prostora za trgovinu gumama; testiranje automobilskih točkova; testiranje automobilskih guma; istraživanje i razvoj proizvoda; ispitivanje kvaliteta proizvoda; analiza razvoja proizvoda; ocjenjivanje razvoja proizvoda; ispitivanje bezbjednosti proizvoda; procjena proizvoda.

(111) **14365**

(151) 19.09.2019.

(210) Ž-2018-57

(442) 20.10.2019.

(220) 22.02.2018.

(732) Hankook Tire Co., Ltd., 133, Teheran-ro (Yeoksam-dong), Gangnam-gu, 135 723, Seoul, KR
(540)

Technodome

(550) I

(740) AOD MSA IP - Milojević Sekulić Advokati, Karadordeva 65, 11000, Beograd

(511) Klasa 36 Upravljanje zgradama (usluge u vezi sa nekretninama); iznajmljivanje ili rentiranje zgrada; izdavanje u zakup zgrada; iznajmljivanje kancelarijskog prostora; rentiranje poslovnog prostora (nepokretnosti); pružanje informacija koje se odnose na iznajmljivanje zgrada; iznajmljivanje industrijskog prostora; ulaganje u nekretnine; usluge upravljanja nekretninama koje se odnose na trgovačke centre; usluge prodaje trgovačkih centara; iznajmljivanje trgovačkih centara; iznajmljivanje poslovnih prostorija; agencije za posredništvo u iznajmljivanju zgrada;

usluge upravljanja nekretninama koje se odnose na komercijalne zgrade.

Klasa 42 Usluge istraživanja u vezi sa gumama; tehničko ispitivanje (pregled) automobilskih guma; tehničko ispitivanje (pregled) vozila; pregled (ispitivanje) motornih vozila pre prevoza (za provjeru ispravnosti); tehničko ispitivanje (pregled) motornih vozila (za provjeru ispravnosti); testiranje ispravnosti vozila; tehnički savjeti u vezi sa proizvodnjom guma; usluge analize (pregleda) guma; usluge projektovanja poslovnih prostora za trgovinu gumama; testiranje automobilskih točkova; testiranje automobilskih guma; istraživanje i razvoj proizvoda; ispitivanje kvaliteta proizvoda; analiza razvoja proizvoda; ocjenjivanje razvoja proizvoda; ispitivanje bezbjednosti proizvoda; procjena proizvoda; laboratorijsko istraživanje u oblasti automobilskih guma; mjerenje težine vozila; razvoj proizvoda za izradu vozila i karoserije; dizajn vozila i djelova i komponenti za vozila; usluge dizajniranja vozila; usluge dizajniranja djelova za vozila; unutrašnji dizajn vozila; testiranje proizvoda u okviru originalnih fermi vozila; razvoj tehnologija za proizvodnju integrisanih kola za bežičnu komunikaciju, elektronsku obradu podataka, potrošačke elektronske uređaje, auto elektroniku; istraživanje automobilske tehnologije; istraživanje i razvoj točkova automobila; istraživanje i razvoj djelova za automobile; pregledi automobila (tehnički); razvoj racunarskih programa za simuliranje eksperimenata u oblasti ispravnosti automobilskih guma; usluge laboratorijskog istraživanja u vezi sa automobilskim gumama; usluge testiranja i istraživanja u vezi sa mašinama, aparatima i instrumentima; mehaničko istraživanje u oblasti moto-sportova; usluge strukturnog inženjeringa u industriji kopnenih vozila; inženjerske usluge u industriji kopnenih vozila; usluge inženjeringa materijala u industriji kopnenih vozila; istraživanje i razvoj automobilskih točkova za druge; pružanje naučnih informacija u vezi sa performansama i radom automobila; dizajniranje modula za automobile; usluge inženjeringa i usluge kontrole kvaliteta i testiranja materijala; ispitivanje sirovina; kontrola kvaliteta sirovina; dizajn i razvoj softvera virtuelne realnosti.

(111) **14369**

(151) 16.10.2019.

(210) Ž-2017-525

(442) 20.10.2019.

(220) 29.12.2017.

(732) BMJ Industries FZCO, Al- Jazeera Al-Hamr, 31053, Ras Al Khaimah, AE

(540)



(550) I

(740) Božidar S. Radulović, Studentska bb, Lamela 3/18, 81000, Podgorica, ME

(511) Klasa 30 Melasa

Klasa 34 Cigarete, cigare, duvan, sirovi i prerađeni duvan, kutije za cigare, kutije (cigarete), duvan

za žvakanje, cigarilos, proizvodi za pušače, upaljači za pušače, filteri (cigarete), šibice i kutije za šibice.

(111) **14370**

(151) 14.10.2019.

(210) Ž-2018-105

(442) 20.10.2019.

(220) 03.04.2018.

(732) Falcon Group d.o.o., Dajbabe b.b., 81000, Podgorica, ME , ME

(540)

The logo for 'māya' features the word in a lowercase, sans-serif font. The letter 'a' is stylized with a small, decorative flourish above it.

(550) I

(511) Klasa 29 meso,riba,živina i divljač -mesni ekstrakti -konzervirano,sušeno i kuvano voće i povrće -želei, džemovi, kompoti -jaja,mlijeko,mliječni proizvodi- jestiva ulja i masti.

Klasa 30 kafa, čaj, kakao, šećer, riža, tapioka- sago, zamjene za kafu -brašno, proizvodi od žitarica, hleb - kolači, poslastice, bombon i,sladoled- med,sirup od melase kvasac, prašak za pecivo - so, senf, sirće, prelive, začini, razni začini, led za hlađenje.

Klasa 35 maloprodaja i veleprodaja gore navedenih roba.

(111) **14371**

(151) 11.10.2019.

(210) Ž-2018-347

(442) 20.10.2019.

(220) 07.09.2018.

(732) W2 Company d.o.o., Zagoric b.b., 81000, Podgorica, ME, ME

(540)

The logo consists of the letters 'DH' in a bold, sans-serif font, enclosed within a square border.

David Hazal

(550) I

(740) W2 Company d.o.o., Zagoric b.b., 81000, Podgorica, ME

(511) Klasa 9 Naočare za sunce i naočare za vid; zaštitne futrole za nošenje posebno prilagođene za lične elektronske uređaje; futrole za naočare.

Klasa 14 Proizvodnja satova (časovničarskih proizvoda) i hronometrijskih instrumenata; plemeniti metali i njihove legure i proizvodi od tih metala ili obloženi tim metalima, koji nisu obuhvaćeni

drugim klasama; pravi i lažni nakit, drago kamenje.

Klasa 35 Maloprodajne usluge i online maloprodajne usluge u vezi sa satovima, nakitom, naočarima za sunce, naočarima za vid, futrolama za naočare.

Klasa 37 Konstruisanje i popravljjanje, uključujući popravljjanje ručnih i zidnih satova.

(111) **14382**

(151) 17.10.2019.

(210) Ž-2011-475

(442) 20.10.2019.

(220) 03.10.2011.

(732) Vuk Jaredić, Zagoric, A-6, IV, 81000, Podgorica, ME, ME

(540)

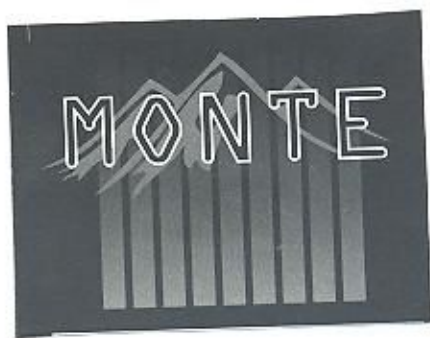

(550) I

(511) Klasa 34 Cigareta.

(111) **14385**

(151) 15.10.2019.

(210) Ž-2018-187

(442) 20.10.2019.

(220) 25.05.2018.

(732) NOVARTIS AG, „, 4002, Basel, CH

(540)

LINEXCOMPLEX

(550) I

(740) NOVARTIS AG, „ 4002, Basel

(511) Klasa 5 Farmaceutski preparati, naime probiotski preparati.

(111) **14386**

(151) 15.10.2019.

(210) Ž-2018-190

(442) 20.10.2019.

(220) 30.05.2018.

(732) Hemofarm A.D. farmaceutsko-hemijska industrija Vršac, Beogradski put bb, 26300, Vršac, RS

(540)

CORPOS

(550) I

(740) Hemofarm A.D. farmaceutsko-hemijska industrija Vršac, Beogradski put bb, 26300, Vršac

(511) Klasa 5 Farmaceutski proizvodi

(111) **14388**

(151) 14.10.2019.

(210) Ž-2018-299

(442) 20.10.2019.

(220) 10.08.2018.

(732) UPSA SAS, 3 rue Joseph Monier, 92500, Rueil-Malmaison, FR

(540)

(550) I

(740) AOD "Ćupić", Bulevar Džordža Vašingtona 79, 81000, Podgorica, ME

(511) Klasa 5 Farmaceutski preparati za ljudsku upotrebu.

(111) **14388**

(151) 14.10.2019.

(210) Ž-2018-290

(442) 20.04.2019.

(220) 07.08.2018.

(732) Zoran Ćetković, ul. Kneza Branimira bb, 31400, Đakovo, HR

(540)



(550) I

(740) Stefan Lučić, Bulevar Džordža Vašingtona 102, The Capital Plaza ap39-2, 81000, Podgorica, ME

(511) Klasa 39 Prevoz; ambalažiranje i skladištenje proizvoda; organizovanje putovanja.

Klasa 41 Obuka; stručno osposobljavnje; razonoda; sportske i kulturne djelatnosti.

Klasa 43 Usluge obezbjeđivanja hrane i pića; privremeno primanje na stan.

(111) **14389**

(151) 18.10.2019.

(210) Ž-2018-351

(442) 20.10.2019.

(220) 10.09.2018.

(732) Ford Motor Company, One American Road, MI 48126, Dearborn, US

(540)

(550) I

(740) Miladin Popović, ul. Capital Plaza, ulica šeika Zajeda 13-IV/68, 81000, Podgorica, ME

(511) Klasa 12 Motorna vozila i njihovi djelovi i dodaci, uključujući teške teretne kamione i njihove djelove i dodatke.

(111) **14390**

(151) 18.10.2019.

(210) Ž-2018-249

(442) 20.10.2019.

(220) 19.07.2018.

(732) Philip Morris Brands Sàrl, Quai Jeanrenaud 3, 2000, Neuchâtel, CH

(540)



(550) I

(740) Milena Pejović, Cetinjski put 11, The Capital Plaza IV floor,, 81000, Podgorica, ME

(511) Klasa 34 duvan, sirov ili prerađen; duvanski proizvodi; cigare, cigarete, cigarilosi, duvan za zavijanje cigareta, duvan za lule, duvan za žvakanje, duvan za šmrkanje, kretek; snus (duvan u prahu); zamjena za duvan (za nemedicinsku upotrebu); elektronske cigarete; duvanski proizvodi za zagrijavanje; elektronski uređaji i njihovi djelovi koji se koriste za zagrijavanje cigareta ili duvana u cilju oslobađanja aerosola koji sadrži nikotin za inhalaciju; tečni nikotinski rastvori za upotrebu u elektronskim cigaretama; artikli za pušače, papir za cigarete, tube za cigarete, filteri za cigarete, kutije za duvan, kutije za cigarete, pepeljare, lule, ručni aparati i spravice za uvijanje cigareta, upaljači, šibice.

(111) **14391**

(151) 18.10.2019.

(210) Ž-2018-252

(442) 20.10.2019.

(220) 19.07.2018.

(732) Philip Morris Brands Sàrl, Quai Jeanrenaud 3, 2000, Neuchâtel, CH

(540)



(550) I

(511) Klasa 34 duvan, sirov ili prerađen; duvanski proizvodi; cigare, cigarete, cigarilosi, duvan za zavijanje cigareta, duvan za lule, duvan za žvakanje, duvan za šmrkanje, kretek; snus (duvan u prahu); zamjena za duvan (za nemedicinsku upotrebu); elektronske cigarete; duvanski proizvodi za zagrijavanje; elektronski uređaji i njihovi djelovi koji se koriste za zagrijavanje cigareta ili duvana u cilju oslobađanja aerosola koji sadrži nikotin za inhalaciju; tečni nikotinski rastvori za upotrebu u elektronskim cigaretama; artikli za pušače, papir za cigarete, tube za cigarete, filteri za cigarete, kutije za duvan, kutije za cigarete, pepeljare, lule, ručni aparati i spravice za uvijanje cigareta, upaljači, šibice.

(111) **14392**

(151) 18.10.2019.

(210) Ž-2017-52

(442) 20.01.2018.

(220) 09.02.2017.

(732) HILTON WORLDWIDE HOLDING LLP (a limited liability partnership organized and existing under the laws of the United Kingdom), Maple Court Central Park, WD24 4QQ, Reeds Crescent, Watford, GB

(540)

(550) I

(740) Branko Anđelić, Svetozara Markovića 12, 81000, Podgorica, ME

(511) Klasa 35 Usluge organizovanja i vođenja poslovnih događaja I priredbi, konferencija, konvencija, izložbi, seminara i sastanaka.

Klasa 36 Usluge posredovanja u poslovima sa nekretninama, usluge menadžmenta u poslovima sa nekretninama.

Klasa 41 Usluge zabave i razonode u vidu prezentovanja plesa uživo, varijetea i muzičkih izvođenja; usluge noćnih klubova; usluge zdravstvenih klubova, naročito davanje uputstava i obezbeđivanje opreme za fizičko vežbanje; usluge organizovanja i vođenja izložbi uživo, događaja I priredbi, konferencija, konvencija, seminara i sastanaka na polju edukacije, kulture, sporta i razonode koji nisu u svrhe biznisa i nisu u komercijalne svrhe; usluge rezervacija za pozorišta i opere.

Klasa 43 Usluge privremenog smeštaja; usluge rezervacija privremenog smeštaja; usluge koje pružaju hoteli, moteli, barovi, kafei, restorani, usluge banketa i cateringa; iznajmljivanje prostora za održavanje događaja /priredbi, konferencija, konvencija, izložbi, seminara i sastanaka.

Klasa 44 Usluge salona lepote, frizerskih salona, berberske .usluge; usluge masaže; banje (banjske usluge) za zdravlje i dobrobit tela i duha; opreme za saune, jakuzi, solarijum i sunčanje; usluge aromaterapije; savetovanje u vezi lepote, friziranja i aromaterapije.

(111) **14393**

(151) 18.10.2019.

(210) Ž-2017-171

(442) 20.04.2018.

(220) 11.05.2017.

(732) MTEL DOO, Ul. Kralja Nikole 27A, Podgorica, ME

(540)

BOX-Tel BOX smart

(550) I

(740) MTEL DOO, Ul. Kralja Nikole 27A, Podgorica

(511) Klasa 35 oglašavanje i reklamiranje; • vodjenje komercijalnih poslova; • komercijalna administracija; • kancelarijski poslovi.

Klasa 38 telekomunikacije.

(111) **14394**

(151) 18.10.2019.

(210) Ž-2017-276

(442) 20.04.2018.

(220) 25.07.2017.

(732) „Okov“ d.o.o., Josipa Broza Tita br. 26, Podgorica, ME

(540)



(550) I

(511) Klasa 2 boje, fimajzi, lakovi, sredstva za zaštitu od rđe i truljenja drveta; materije za bojenje; sredstva za nagrizanje; sirove prirodne smole; metali u obliku listova i praha za slikare, dekoratere, štampare i umetnike.

Klasa 3 sredstva za beljenje i druge spustance za upotrebu u perionicama; preparati za či šćenje, poliranje, ribanje i nagrizanje; sapuni; parfime-rija, eterična ulja, kozmetika, losioni za kosu; paste za zube.

Klasa 4 industrijska ulja i masti; maziva; jedinjenja za skupljanje prašine vlaženjem i vezivanjem; goriva (uključujući motoma tečna goriva) i materije za osvetljavanje; sveće i fitilji za osvetljavanje.

Klasa 5 farmaceutski i veterinarski preparati; sanitarni preparati za medicinsku upotrebu; dijetetske supstance prilagođene za upotrebu u medicini, hrana za bebe; flasteri, materijali za zavijanje; materijali za plombiranje zuba, zubarska smola; dezinfekciona sredstva; preparati za uništavanje štetočina; fungicidi, herbicidi.

Klasa 6 obični metali i njihove legure; metalni građevinski materijali; metalne prenosne građevine; materijali od metala za železničke šine; neelektrične žice i kablovi od običnog metala; bravarski proizvodi; mali metalni gvoždarski proizvodi; cevčice i cevi od metala; sefovi; proizvodi od običnih metala koji nisu uključeni u druge klase; rude.

Klasa 7 mašine i mašinski alati; motori i pogonske mašine (osim za suvozemna vozila); mašinske spojnice i transmisioni elementi (osim za suvozemna vozila); poljoprivredne sprave; inkubatori za jaja.

Klasa 8 ručni alati i sprave (kojima se ručno upravlja); pribor zajelo; hladno oružje; žileti.

Klasa 9 aparati i instrumenti naučni , pomorski, geodetski, fotografski, kinemato-grafski, optički , za vaganje, merenje, signalizaciju, kontrolu (inspekciju), spasavanje i nastavu; aparati i instrumenti za provođenje , prekid, transformaciju, akumulaciju, regulisanje i kontrolu elektriciteta; aparati za snimanje, prenos i reprodukovanje zvuka ili slike; magnetni nosioci podataka, diskovi za snimanje; automatske mašine i mehanizmi za aparate koji se pokreću novcem ili žetonom; registar kase, računске mašine, oprema za obradu podataka i kompjuteri; aparati za gašenje požara.

Klasa 10 hirurški, medicinski, zubarski i veterinarski aparati i instrumenti; veštački udovi, oči i zubi; ortopedski artikli; hirurški materijali za zašivanje.

Klasa 11 aparati za osvetljavanje, grej anje, proizvodnju pare, kuvanje, hlađenje, sušenje, ventilaciju, snabdevanje vodom i za sanitarne svrhe.

Klasa 12 vozila; aparati za kretanje po zemlji, vazduhu ili vodi.

Klasa 13 vatreno oružje; municija i projektili; eksplozivi; sredstva za vatromet.

Klasa 14 dragoceni metali i njihove legure i pro-izvodi od dragocenih metala ili sa prevlakom od njih, koji nisu uključeni u druge klase; nakit, bižuterija, drago kamenje; časovničarski i hronometrijski instrumenti.

Klasa 15 muzički instrumenti.

Klasa 16 hartija, karton i proizvodi od njih, koji nisu uključeni u druge klase; štampane stvari; knjigovezački materijal; fotografije; kancelar-ijski materijal; lepila za kancelarijske i kućne potrebe; umetnički materijali; kičice ; pisaće mašine i kancelarijski rekviziti (izuzev nameštaja); materijali za obuku i nastavu (izuzev aparata); plastični materijal za pakovanje (koji nije uključen u druge klase); štamparska slova; klišeji.

Klasa 17 guma, gutaperka, kaučuk, azbest, liskun i proizvodi napravljeni od ovih materijala koji nisu uključeni u druge klase; polupreradaeni plastični proizvodi; materijali za podbijanje (podloške), zaptivanje i izolovanje; savitljive nemetalne cevi.

Klasa 18 koža i imitacija kože, proizvodi izrađeni od ovih materijala koji nisu uključeni u druge klase; životinjska koža; koferi i putne torbe; kišobrani, suncobrani i štapovi za hodanje; bičevi , saračka i sedlarska roba.

Klasa 19 građevinski materijali (nemetalni); čvrste nemetalne cevi za građevine ; asfalt, crna smola i bitumen, nemetalne prenosne građevine ; spomenici, koji nisu od metala.

Klasa 20 nameštaj, ogledala, okviri za slike; proizvodi (koji nisu obuhvaćeni drugim klasama) od drveta, plute, trske, rogoza, vrbovog pruća, roga, kosti, slonovače, kitove kosti, školjki, ćilibara, sedefa, morske pene i zamene svih ovih materijala, ili od plastike.

Klasa 21 kućne ili kuhinjske sprave i posude (koje nisu od dragocenih metala ili sa prevlakama od njih); češljevi i sunđeri ; četke (izuzev kičica) ; materijali za pravljenje četki ; artikli koji se koriste pri čišćenju; čelična vuna; neprerađeno ili polupreradaeno staklo (osim stakla koje se koristi u građevinarstvu); staklarija, porcelan, fajans, grnčarija i lončarija koja nije uključena u druge klase.

Klasa 22 užad, kanapi, mreže, šatori, nadstre-šnice od cirade, cirade, jedra, vreće (xakovi) i torbe (koje nisu uključene u druge klase); mate-rijali za punjenje madraca (osim od gurne ili plastike); sirove vlaknaste tekstilne materije.

Klasa 23 pređa i konac, za tekstilnu upotrebu.

Klasa 24 tekstil i tekstilni proizvodi koji nisu obuhvaćeni drugim klasama; prekrivači za krevete i stolove.

Klasa 25 odeća, obuća, pokrivala za glavu.

Klasa 26 čipka i vez, trake (pantljike) i gajtani; dugmad, kopče i petlje, špenadle i igle; veštačko cveće.

Klasa 27 tepisi, asure, prostirke i otirači, linoleum i drugi materijali za pokrivanje podova; prekrivači za zidove (netekstilni).

Klasa 28 igre i igračke; gimnastički i sportski artikli koji nisu obuhvaćeni drugim klasama; ukrasi zajelke.

Klasa 29 meso, riba, živina i divljač; mesne prerađevine; konzervisano, sušeno i kuvano voće i povrće; želei, xemovi, kompoti; jaja, mleko i mlečni proizvodi; jestiva ulja i masti.

Klasa 30 kafa, čaj, kakao, šećer, pirinač, tapioka, sago, zamena kafe; brašno i proizvodi od žitarica, hleb, kolači, poslastice, sladoledi; med, melasa, kvasac, prašak za pecivo; so, senf; sirće, sosovi (kao začini); začini; led.

Klasa 31 poljoprivredni, vrtlarski i šumarski proizvodi i zrnevlje koji nisu uključeni u druge klase; žive životinje; sveže voće i povrće; seme, prirodne biljke i cveće; hrana za životinje, slad.

Klasa 32 pivo, mineralne i sodne vode i druga bezalkoholna pića; pića od voća i voćni sokovi; sirupi i drugi preparati za proizvodnju pića.

Klasa 33 alkoholna pića (izuzev piva).

Klasa 34 duvan; artikli za pušače; šibice.

Klasa 35 oglašavanje; vođenje poslova; poslovno upravljanje; kancelarijski poslovi.

Klasa 36 osiguranje; finansijski poslovi; novčani (monetarni) poslovi; poslovi vezani za nepo kret - nosti.

Klasa 37 građevinsko konstruisanje; popravlanje; usluge instaliranja (instalacione usluge).

Klasa 38 telekomunikacije.

Klasa 39 transportne usluge; pakovanje i skladištenje robe; organizovanje putovanja.

Klasa 40 obrađivanje materijala.

Klasa 42 medicinske usluge; veterinarske usluge; higijenska njega i njega ljepote za ljude ili za životinje; usluge poljoprivrede, povrtlarstva i šumarstva.

Klasa 43 usluge obezbeđivanja hrane i pića; privremeni smeštaj

Klasa 44 medicinske usluge; veterinarske usluge; higijenska njega i njega ljepote za ljude ili za životinje; usluge poljoprivrede, povrtlarstva i šumarstva.

Klasa 45 pravne usluge; sigurnosne usluge za zaštitu imovine i lica; lične i društvene usluge koje pružaju drugi, namijenjene za zadovoljenje ljudskih potreba Shodno

(111) **14395**

(151) 18.10.2019.

(210) Ž-2017-312

(442) 20.07.2018.

(220) 09.08.2017.

(732) Snežana Bajat, Stjepa Šarenca 4/11, 85340, Herceg Novi, ME

(540)



(550) I

(511) Klasa 14 Ogrlice (nakit)

Klasa 25 Djonovi.

Klasa 26 Trake rastegljive

(111) **14396**

(151) 18.10.2019.

(210) Ž-2017-416

(442) 20.07.2018.

(220) 19.10.2017.

(732) DOO NAKY S, Trg sunca br.2, Budva, ME

(540)



(550) I

(740) Marina Matković, Bulevar Stanka Dragojevića 28, 81000, Podgorica, ME

(511) Klasa 43 usluge obezbjeđivanja hrane i pića

(111) **14397**

(151) 18.10.2019.

(210) Ž-2017-417

(442) 20.07.2018.

(220) 19.10.2017.

(732) DOO NAKY S, Trg Sunca br.2, 85310, Budva, ME

(540)



(550) I

(740) Marina Matković, Bulevar Stanka Dragojevića 28, 81000, Podgorica, ME

(511) Klasa 43 usluge obezbjeđivanja hrane i pića

(111) **14398**

(151) 18.10.2019.

(210) Ž-2018-357

(442) 20.10.2019.

(220) 14.09.2018.

(732) TWENTIETH CENTURY FOX FILM CORPORATION, 10201 West Pico Boulevard, 90035, Los Angeles, California, US

(540)

(550) I

(740) Jasna Jusić, Dalmatinska 2, 81000, Podgorica, ME

(511) Klasa 9 Igrani filmovi ; kinematografski filmovi ; igrani filmovi na temu naučne fantastike, fantazije, akcije, avanture, komedije, drame, muzike i zabave za djecu; prethodno snimljeni DVD-ji sa sadržajem iz oblasti naučne fantastike, fantazije, akcije, avanture, komedije, drame, muzike i zabave za djecu; prethodno snimljeni CD-ovi sa sadržajem iz oblasti naučne fantastike, fantazije, akcije, avanture, komedije, drame, muzike i zabave za djecu i muzičkim izvođenjima; prethodno snimljeni CD-ovi, CD-ROM-ovi, DVD-ji i fleš memorijske kartice; audio i video zapisi; muzički zapisi koji se mogu preuzimati; fajlovi sa muzikom iz igranog filma koji se mogu preuzimati; prethodno snimljeni CD-ovi koji sadrže muziku iz igranog filma; audio i video zapisi sa sadržajem iz oblasti naučne fantastike, fantazije, akcije, avanture, komedije, drame, muzike i zabave za djecu koji se mogu preuzimati ; filmovi koji se mogu preuzimati; igrani filmovi koji se mogu preuzimati ; igrani filmovi, televizijske emisije i video zapisi sa sadržajem iz oblasti naučne fantastike, fantazije, akcije, avanture, komedije, drame, muzike i zabave za djecu koji se mogu preuzimati; melodije zvona, melodija pozivnog zvona, grafike, pozadine, igrice i muzika koji se mogu preuzimati; melodije zvona, melodije pozivnog zvona, grafike, pozadine, igrice i muzika; melodije zvona, melodije pozivnog zvona, grafike, pozadine, igrice i muzika koji se mogu preuzimati preko globalne kompjuterske mreže i bežičnih uređaja; softver; kompjuterski softver; knjige koje se mogu preuzimati; audio knjige; softver koji se može preuzimati; kompjuterski softver za zaštitu zaslona; kompjuterske igrice; softver za igrice; softver za igrice koji se može preuzimati; softver za video igrice; podmetači za miša; kompjuterski dodaci; dodaci za mobilne telefone; futrole za nošenje mobilnih telefona, drugih mobilnih uređaja i kompjutera; dekorativni magneti; optičarski proizvodi ; naočare; futrole za optičarske proizvode; mobilne aplikacije koje se mogu preuzimati; mobilne aplikacije koje se mogu preuzimati za mobilne komunikacione uređaje za korištenje u distribuciji digitalnih videa, video fajlova, video igrica i multimedijalnog sadržaja; kockarske aplikacije koje se mogu preuzimati ; mobilni aplikativni softver; mobilni aplikativni softver koji se može preuzimati; kompjuterski aplikativni softver za mobilne telefone; kao sto su softver za igranje igrica koji se može preuzimati ; kompjuterski aplikativni softver za igrice na mobilnom telefonu, tabletu ili drugim prenosivim elektronskim uređajima koji se može preuzimati ; softver za video igrice za korišćenje na mobilnim uređajima; elektronski programi za igrice; elektronski programi za igrice koji se može preuzimati; softver za elektronske igrice; kompjuterski programi za igrice;

kompjuterski programi za igrice koji se mogu preuzimati; programi za interaktivne igrice; softver za interaktivne igrice; softver za interaktivne igrice; aplikacije i Apps, naime, kompjuterski aplikativni softver za igrice koji se može preuzimati; softver za video igrice koji se može preuzimati za korišćenje na bežičnim uređajima; softver za kompjuterske igrice koji se može preuzimati sa globalne kompjuterske mreže; softver za kompjuterske igrice za video i kompjuterske igrice; kompjuterski programi za video igrice; softver za kompjutersku zabavu igricama; softver za igrice u virtuelnoj stvarnosti; softver za proširenu stvarnost; softver za proširenu stvarnost za korišćenje na mobilnim uređajima za integrisanje elektronskih podataka sa okruženjima u realnom svijetu u svrhu zabave i igre; naočare za virtuelnu stvarnost; slušalice sa mikrofonom za virtuelnu stvarnost; bubice; slušalice koje se umeću u uši; slušalice koje se nose preko glave; izdavanje knjiga; elektronske publikacije; elektronske publikacije, naime, knjige, crtani romani, časopisi, priručnici i leci sa sadržajem iz oblasti zabave, vijesti, muzike i mjetnosti; futrole za naočare; futrole za mobilne telefone; futrole za mobilne uređaje; torbice za nošenje laptopa; futrole za pametne telefone. Aparati i instrumenti naučni, pomorski, geodetski, fotografski, kinematografski, optički, za vaganje, mjerenje, signalizaciju, kontrolu (inspekciju), spašavanje i nastavu; aparati i instrumenti za provođenje, prekid, transformaciju, akumulaciju, regulisanje ili kontrolu električne energije; aparati za snimanje, prenos i reprodukovanje zvuka ili slike; magnetni nosači podataka, diskovi za snimanje; kompakt diskovi, DVD i drugi digitalni nosači podataka; mehanizmi za aparate koji se pokreću novcem; registar kase, računске mašine, oprema za obradu podataka, računari; aparati za gašenje požara; električni aparati; elektronska oprema; elektronska roba; potrošačka elektronska roba; snimci audio kasete; plejeri za audio kasete; audio kasete; audio diskovi; audio zvučnici; monitori za bebe; biciklističke kacige; zaštitne kacige za sportove; dvogledi; audio trake; vizuelni snimci u svim medijima; kalkulatori; kamkorderi; kamere; CD plejeri; CD-ROM; CD-ROM diskovi (kao dio računara); CD-ROM pisači (kao dio računara); mobilni telefoni; prednje maske za mobilne telefone; aparati mobilnih telefona; ukrasi za mobilne telefone; čipovi koji sadrže muzičke snimke; snimci za kompakt diskove; kompasi za određivanje pravca; kasete i diskovi za računarske igre; računarski hardver; tastature za računare; monitori za računare; miševi za računare; disk drajveri za računare; bežični telefoni; digitalne kamere; digitalni snimci za audio trake; digitalni video rekorderi; digitalni audio i video plejeri; DVD plejeri; DVD mašine; DVD rekorderi; elektronski lični organizeri; lančići za naočare; karaoke mašine; zvučnici; mikrofoni; MP3 plejeri; MP3 rekorderi; mini diskovi; plejeri za mini diskove; snimci za mini diskove; mobilni telefoni; prednje maske za mobilne telefone; aparati mobilnih telefona; ukrasi za mobilne telefone; modemi (kao dio računara); muzički snimci; pejdžeri; lični stereo uređaji; lični digitalni asistenti; štampači; radija; naočare za sunce; futrole za naočare za sunce; telefoni; televizijski setovi; video kamere; snimci za video kasete; plejeri za video kasete; kasete za video igre; diskovi za video igre; video trake; video kasete; video diskovi; videofoni; plejeri video diskova; video zapisi; vokitoki; odmarajući za ruku i zglob za upotrebu sa računarima; podloge za tastature za računar; dodaci za potrošačku elektronsku robu u ovoj klasi; priručnici u digitalnom formatu koji se prodaju sa softverom za računarske igre, računarskim softverom, računarskim softverom u oblasti zabave i igara; unaprijed snimljeni optički diskovi; unapred snimljeni magnetni optički diskovi; plejeri optičkih diskova za audio, video i/ili računarske podatke; plejeri magnetnih optičkih diskova za audio, video i/ili računarske podatke; snimači optičkih diskova za audio, video i/ili računarske

podatke; snimači magnetnih optičkih diskova za audio, video i/ili računarske podatke; električni kablovi; optički kablovi; dodaci za optičarske proizvode u ovoj klasi; lenjiri sa metričkom gradacijom, za kancelarije; lenjiri sa metričkom gradacijom, kao kancelarijski materijal; maske za lice; flotacioni prsluci ; sportske naočare; disaljke; zaštitna odjeća; ronilačke maske; nosni čepovi za plivače i ronioce; zaštitne rukavice; zaštitni čepovi za uši; čamci za spasavanje (splavovi) ; neonski znaci; unaprijed snimljena muzika i audio-video za elektronske medije; električne brave; električne zice; kontaktna sočiva.

Klasa 41 Usluge iz oblasti zabave; usluge iz oblasti zabave u vidu audio,vizuelne i audio vizuelne zabave; usluge iz oblasti zabave u vidu audio, vizuelnog, audio vizuelnog i digitalnog sadržaja; usluge iz oblasti obrazovanja; predstavljanje i distribucija audio i vizuelnih djela u vidu igranih filmova; pružanje sportskih i kulturnih aktivnosti; usluge iz oblasti obrazovanja i zabave, naime, produkcija, distribucija i predstavljanje audio i vizuelnih djela u vidu pokretnih slika, filmova i televizijskih programa; usluge u oblasti zabave u vidu televizijskih serija, serija multimedijalnih programa, radio programa, pokretnih slika, videa, filmova i filmskih klipova; pružanje informacija o onlajn zabavi; obezbjeđivanje onlajn kompjuterske baze podataka sa informacijama iz oblasti zabave i obrazovanja; pružanje onlajn informacija u oblasti zabave i obrazovanja ; pružanje onlajn informacija u oblasti lingvistike; pružanje onlajn informacija u oblasti televizijskih programa, pokretnih slika, filmova, radio programa, multimedijalnih progama i video zabave putem interneta i komunikacionih mreža; obezbjeđivanje vebsajta sa audio, vizuelnim i audio-vizuelnim sadržajem koji se ne može preuzimati; obezbjeđivanje vebsajta sa pokretnim slikama, videima, filmovima i filmskim klipovima koji se ne mogu preuzimati; usluge iz oblasti zabave u vidu videa i slika koji se ne mogu preuzimati; usluge iz oblasti zabave u vidu videa i slika sa televizijskim emisijama, filmovima i serijama multimedijalnog programa sa temom naučne fantastike, fantazije, akcije, avanture, komedije, drame, muzike i zabave za djecu koji se prenose putem interneta i komunikacionih mreža i koji se ne mogu preuzimati; usluge u oblasti zabave u vidu videa i slika koji sadrže igrani film koji se prenosi putem interneta i komunikacionih mreža; usluge iz oblasti zabave i obrazovanje u vidu televizijskih i multimedijalnih programskih serija sa temama od opšteg interesa koje se distribuiraju preko različitih platformi kroz različite forme prenosnih medija; pružanje informacija o zabavi drugima putem globalne kompjuterske mreže; usluge zabavnih parkova i tematskih parkova; usluge iz oblasti zabave u vidu muzičkih, komediografskih i dramskih izvođenja uživo; usluge iz oblasti zabave u vidu izvođenja uživo glumaca, muzičara, akrobata i drugih izvođača; zabava u vidu cirkusa; zabava u vidu izvođenja uzivo; usluge iz oblasti zabave, naime, obezbjeđivanje vebsajta za onlajn kocku; pružanje kazino igara i video igara preko interneta i komunikacionih mreža koji se ne mogu preuzimati; usluge u oblasti zabave, naime, obezbjeđivanje onlajn kompjuterskih igrica; usluge iz oblasti zabave u vidu pružanja usluga interaktivnih igrica za igrice koje se igraju preko kompjutera ili komunikacionih mreža; obezbjeđivanje igrica; usluge onlajn igrica; usluge onlajn kompjuterskih igrica; objavljivanje softvera za interaktivne kompjuterske i video igrice; obezbjeđivanje knjiga koje se ne mogu preuzimati; obezbjeđivanje onlajn elektronskih publikacija koje se ne mogu preuzimati u oblasti kompjuterskih igrica; usluge pružanja elektronskih igrica putem interneta ili druge komunikacione mreže; organizovanje i vođenje internet igrica koje se ne mogu preuzimati; pružanje usluga iz oblasti zabave i informacija iz oblasti zabave preko kompjuterskih, elektronskih i onlajn baza

podataka; obezbjeđivanje onlajn softvera za igrice u virtuelnoj realnosti koje se ne mogu preuzimati; onlajn publikacije; onlajn knjige; onlajn dnevници, naime, blogovi koji sadrže lična mišljenja iz oblasti od opšteg interesa, lingvistike, naučne fantastike i fantazije; onlajn objave elektronskih publikacija; usluge iz oblasti zabave kao sto su obazbjeđivanje vebsajta koji sadrži melodije zvona, grafike, pozadine i igrice; usluge u oblasti mobilnih medija i zabave u vidu pripreme sadržaja; muzeji; usluge iz oblasti muzeja; usluge iz oblasti putujućih muzeja; usluge iz oblasti muzeja u vidu putujućih izložbi iz oblasti nauke, lingvistike, istraživanja, konzervacije, prirode i pravljenja filmova ; obilasci izložbi sa vodičem iz oblasti naučne fantastike i fantazije; usluge iz oblasti obrazovanja, naime, obezbjeđivanje izložbi iz oblasti nauke, lingvistike i očuvanja životne sredine; organizovanje događaja u zajednici i kulturnih događanja; obezbjeđivanje zabavnih izložbi; organizovanje i vođenje izložbi za potrebe kulture, obrazovanja i zabave; usluge iz oblasti obrazovanja, naime, prikazivanje serija filmova ; organizovanje predstava i događaja za potrebe kulture; organizovanje, priprema i vođenje događaja, od kojih se zarada donira u dobrotvorne svrhe; obezbjeđivanje kampova za djecu i odrasle; pružanje informacija, novosti i komentara iz oblasti zabavi ; usluge pružanja informacija iz oblasti rekreacije; kinematografske usluge; organizovanje i vođenje avanturističkih aktivnosti potrage za blagom ; umjetničke izložbe.

(111) **14399**

(151) 24.10.2019.

(210) Ž-2018-189

(442) 20.10.2019.

(220) 29.05.2018.

(732) ALKALOID AD SKOPLJE, BULEVAR ALEKSANDAR MAKEDONSKI 12, 1000, SKOPLJE, MK

(540)



(550) I

(740) Miladin Popović, ul. Capital Plaza, ulica šeika Zajeda 13-IV/68, 81000, Podgorica, ME

(511) Klasa 1 Hemikalije za upotrebu u industriji, nauci i fotografiji, kao i u poljoprivredi, hortikulturi i šumarstvu; neprerađene vjestačke smole, neprerađena plastika; smjese za gašenje i sprječavanje požara; preparati za kaljenje i lemljenje; supstance za stavljenje životinjske kože i krzna; ljepkovi za upotrebu u industriji; gitovi i druge paste za punjenje; kompost, gnojiva, đubriva; biološki preparati za upotrebu u industriji i nauci.

Klasa 2 Boje, lakovi, fimajzi; zaštite protiv rde i protiv propadanja drveta; koloranti, farbe; mastila za štampanje, obiljdavanje i graviranje; sirove prirodne smole; metali u listovima i u prahu za upotrebu u slikarstvu, dekorisanju, štampanju i umjetnosti.

Klasa 3 Nemedicinska kozmetika i toaletni preparati; nemedicinske paste za zube; parfimerija, eterična ulja; preparati za izbjeljivanje i ostale supstance za pranje rublja; preparati za čišćenje,

poliranje, odmašćivanje i struganje.

Klasa 5 Farmaceutski, medicinski i veterinarski preparati; sanitarni preparati za medicinske svrhe; dijetetska hrana i supstance prilagođene medicinskoj ili veterinarskoj upotrebi, hrana za bebe; dijetetski suplementi za ljude i životinje; flasteri, materijali za zavijanje; materijali za plombiranje zuba, vosak za uzimanje zubnog otiska; dezinfekciona sredstva; preparati za uništavanje štetočina; fungicidi, herbicidi.

Klasa 31 Sirovi i neprerađeni poljoprivredni, akvakulturalni, baštenski i šumski proizvodi; sirovo i neprerađeno zmevlje i sjemenje; svježe voće i povrće, svježe bilje; prirodne biljke i cvijeće; lukovice, sadnice i sjemenje za sadnju; žive životinje; prehrambeni proizvodi i pića za životinje; slad.

(111) **14400**

(151) 24.10.2019.

(210) Ž-2018-200

(442) 20.10.2019.

(220) 11.06.2018.

(732) Colgate-Palmolive Company, a Delaware Corporation, 300 Park Avenue, 10022, New York, New York, US

(540)

COLGATE MAX WHITE EXPERT SHINE

(550) I

(740) Colgate-Palmolive Company, a Delaware Corporation, 300 Park Avenue, 10022, New York

(511) Klasa 3 Pasta za zube i tečnost za ispiranje usta.

(111) **14401**

(151) 24.10.2019.

(210) Ž-2018-248

(442) 20.10.2019.

(220) 18.07.2018.

(732) ALKALOID AD SKOPLJE, BULEVAR ALEKSANDAR MAKEDONSKI 12, 1000, SKOPLJE, MK

(540)

Dopezal

(550) I

(740) ALKALOID AD SKOPLJE, BULEVAR ALEKSANDAR MAKEDONSKI 12, 1000, SKOPLJE

(511) Klasa 5 farmaceutski preparati

(111) **14402**

(151) 28.10.2019.

(210) Ž-2017-10

(442) 20.04.2019.

(220) 10.01.2017.

(732) Pet Network International d.o.o., Heinzelova 60, 10000, Zagreb, HR

(540)



(550) I

(740) Milan Kekec, Bulevar Džordža Vašingtona br. 98/V, Podgorica

(511) Klasa 3 Kozmetika za životinje i kozmetički preparati za negu životinja uključujući šampone, regeneratore, šampone za suvo pranje, balzarne, proizvode za raščesljavanje dlake; dezodoransi, parfemi i parfimerijski proizvodi za kućne ljubimce; sredstva za oralnu higijenu i osvežavanje daha za životinje; maramice natopljene kozmetičkim losionima za kućne ljubimce; sredstva za uklanjanje mrlja od kućnih ljubimaca; sredstva za uklanjanje mirisa kućnih ljubimaca; deterdženti.

Klasa 5 Veterinarski proizvodi i preparati, Jekovi i farmaceutski preparati za veterinarsku upotrebu; lekovita hrana za životinje; lekoviti aditivi za hranu za životinje; dijetetska hrana i supstance za veterinarsku upotrebu; dodaci ishrani za životinje uključujući proteinske, vitaminske i mineralne dodatke ishrani; probiotski preparati za životinje za veterinarsku upotrebu; dezinfekcijska i antiseptička sredstva i njihovi preparati; higijenski proizvodi za životinje uključujući pelene, upijajuće prostirke za trening štenadi, gaće i higijenske uloške za kućne ljubimce; preparati za neutralizaciju mirisa; sredstva za uništavanje životinjskih štetočina; biocidi i biocidni preparati; akaricidi i akaricidni preparati; insekticidi i sredstva za odbijanje insekata; antiparazitne ogrlice za životinje; Antiparazitni i repelentni preparati u formi pudera, spreja, šampona, losiona, spot-on preparata ili dodatka ishrani za životinje; sredstva za odbijanje životinja; sredstva za privlačenje životinja; preparati za sprečavanje stvaranja algi u vodi i preparati za uklanjanje algi

Klasa 18 Odeća i obuća za kućne ljubimce; ogrlice, povodci i hamovi za kućne ljubimce, sedlarska oprema; zaštitne kragne za životinje i kućne ljubimce; pokrivači za životinje; brnjice; remenje; čebad za životinje.

Klasa 20 Ležajevi, jastuci, kreveti, korpe, kućice i odmorišta za kućne ljubimce; pseće kućice; drveni kavezi; grebalice za mačke; kutije za smeštanje kućnih ljubimaca; prenosnici za transport kućnih ljubimaca (transporteri); kotilice; vratašca za pse i mačke od nemetalnih materijala; kućice za ptice; gnezda za ptice; stolovi za doterivanje kućnih ljubimaca; narneštaj za unutarnje akvarijurne i terarijurne.

Klasa 21 Četke, češljevi za životinje; kavezi za kućne ljubimce; kućni akvarijurni, vivarijurni i terarijumi; ukrasi za akvarijurne; poklopci za akvarijurne; posude za hranu za životinje; zdelice i pojilice za kućne ljubimce; sprave za raspršivanje i sprave za zalivanje; prenosni dispenser vode za

kućne ljubimce; hranilice i pojilice za ptice; kavezi za ptice; kadice za kupanje ptica; prečke za kaveze; posude i kutije za pesak za mačke i druge kućne ljubimce; lopatice za skupljanje i uklanjanje izmeta kućnih ljubimaca.

Klasa 28 Igračke za kućne ljubimce; prsluci za plivanje za kućne ljubimce.

Klasa 31 Poljoprivredni, vrtlarski i šumarski proizvodi i zrnavlje, koji nisu uključeni u druge klase; žive životinje, naročito kućni ljubimci, akvarijumske ribice i korali; sveže voće i povrće, naročito krompir; seme; prirodne biljke i cveće; alge i morske trave za životinjsku ishranu; zrnavlje za životinjsku ishranu; krmiva za životinje i hrana za kućne ljubimce, naročito hranu za pse, mačke, ptice, glodare, tvorove, kornjače i ribe; keksi i poslastice za kućne ljubimce; jestive žvakalice, probavljive kosti i pločice za žvakanje za kućne ljubimce; potpune i dopunske krmne smeše; dijetetska krmiva; dodaci ishrani za životinje u nemedicinske svrhe; sipine kosti; napici za kućne ljubimce; seno; mleko, mleko u prahu i zamensko mleko za životinje; higijenske podloge, stelje i pesak za WC posude za kućne ljubimce i domaće životinje, i za prebivališta naročito kaveze, kućice, terarijume, staje za kućne ljubimce i domaće životinje, uključujući podloge od slame, sena, drvenih strugotina, kore drveta, kukuruzovine, papira, gline, peska i sintetičkih materijala; peščani papir.

Klasa 35 Usluge veleprodaje i maloprodaje, uključujući i prodaju putem interneta, putem pošte, preko kataloga i drugih sredstava komunikacije: poljoprivrednih, vrtlarskih i šumarskih proizvoda i bobica, živih životinja; svežeg voća i povrća; semena; prirodnih biljaka i cveća, hrane za životinje, dodataka ishrani za životinje, dijetetskih krmiva, slada, poslastica i jestivih žvakalica za kućne ljubimce; proizvoda za kućne ljubimce i domaće životinje, naročito stelje za životinje, kaveza za kućne ljubimce, ležajeva, korpi, jastuka i prekrivača za životinje, ogrlica, povodnika, sedlarskih proizvoda, igračkaka za životinje, posuda i kutija za higijenski pesak za kućne ljubimce (WC posude), prenosnika za transport kućnih ljubimaca (transporteri), grebalice za mačke, higijenskog pribora, pribora za ulepšavanje i preparata za negu životinja, odeće i obuće za životinje, posuda i pojilica za kućne ljubimce, gotovih akvarijuma, terarijuma i opreme za akvaristiku i teraristiku, sredstava za kondicioniranje i tretiranje akvarijumske vode; preparata za uništavanje štetočina; maloprodaja i veleprodaja veterinarskih proizvoda i preparata, veterinarskih instrumenata, farmaceutskih i higijenskih preparata i medicinskih proizvoda; pružanje komercijalnih saveta i informacija potrošačima; usluge upravljanja prodajom proizvoda za životinje i veterinarskih proizvoda; prezentacija robe putem komunikacijskih medija u maloprodajne svrhe; pružanje online usluge grupisanja ponude i pristupa na proizvode i usluge drugih online prodavaca na internetu; usluge marketinga i prezentacije robe na prodajnom mestu; oglašavanje, uključujući online oglašavanje na kompjuterskoj mreži; poslovno upravljanje, poslovna administracija, kancelarijske usluge, prodajne promocije, reklamiranje, prezentacija robe, distribucija uzoraka.

Klasa 41 Usluge dresure životinja; usluge obuke i školovanja pasa; škola za dresiranje životinja; priredbe sa životinjama; izložbe životinja; izlaganje životinja; organizacija priredbi sa životinjama i izložbi životinja, naročito izložbi pasa, mačaka, ptica, malih životinja, akvarijumskih riba i akvaristike, teraristike, konja; trke pasa i njihova organizacija; iznajmljivanje životinja u rekreativne svrhe; obučavanje za dresuru životinja i postupanje sa psima; obučavanje za šišanje i kozmetičko uređenje životinja; izdavanje materijala koji se odnose na životinje putem štampanih ili elektronskih medija; produkcija radio, TV ili internet programa vezanih za životinje.

Klasa 44 Uzgoj životinja, šišanje i uređivanje životinja; usluge higijenske i kozmetičke nege, usluge

kozmetičke nege za životinje; održavanje higijene, pranje i negovanje životinja; zdravstvene usluge za životinje uključujući veterinarske usluge, bolnice za životinje i usluge bolnica za kućne ljubimce, veterinarske savetodavne usluge, briga o životinjama i kućnim ljubimcima, naročito bolesnim i nemoćnim, savetodavne usluge u vezi uzgoja, hranjenja i nege kućnih ljubimaca, farmaceutske usluge naročito pripremanje i izdavanje veterinarskih lekova, informativne usluge u vezi sa veterinarskim farmaceutskim proizvodima.

(111) **14408**

(151) 01.11.2019.

(210) Ž-2018-312

(442) 20.10.2019.

(220) 16.08.2018.

(732) SMYK SPÓLKA AKCYJNA, Domaniewska 48, 02-672, Warsaw, PL

(540)



(550) I

(740) Miladin Popović, ul. Capital Plaza, ulica šeika Zajeda 13-IV/68, 81000, Podgorica, ME

(511) Klasa 28 Mašine za igre, mašine za video igre, baloni za igranje, mjehurići za sapun (igračke), bejzbol rukavice, bazeni (artikli za igru), spinneri (igračke), bingo kartice, bob sanke, bodibordovi, boks rukavice, bočice za hranjenje lutaka, čizme za klizanje sa prikačenim klizaljka, ukrasi za božićna drvca osim predmeta za osvetljavanje i slatkiša, stalci za božićno drveće, božićno drveće od sintetičkog materijala, papirnati šeširi za zabave, daske za surfovanje, skejtbordovi, domine, kućice za lutke, diskovi za sport, zvona za božićno drveće, vježbači (ekspanderi), elektronske mete, aparati za bodibildovanje, aparati za fizičke vježbe, aparati za treniranje tijela, karte za igranje, palice za igre, lopte za igranje, male lopte za igre, lopte za igre, aparati za igre, brojila (diskovi) za igre, igre, automatske i mašine za zabavu koje rade uz pomoć kovanica, društvene igre, prijenosne igre s ekranima od tekućih kristala, salonske igre, zvečke (igračke), zviždaljke, igre koje pozivaju na lov, tegovi za tužbanje, skuteri, ljuljaške, kaleidoskopi, futrole za pištolje (igračke), detonirajuće kape (igračke), kupaći kostimi, bingo kartice, uređaji za vožnju na ravnom terenu, građevinski blokovi (igračke), konfete, konji za ljuljanje, igre za izgradnju, kockice, futrole za kockice, noviteti za zabave, plesovi (plesne zabave), čunjevi, aparati i mašine za kuglanje, kegle, marionete, lutke, boce za hranjenje lutaka, kreveti za lutke, sobe za lutke, odjeća za lutke, leteći diskovi (igračke), zmajevi, zmajevi na namotavanje, najlon za ribolov, loptice za badminton, leteci zmajevi, kreveti za lutke, lukovi za streljaštvo, umeci za streljaštvo, roleri, klizaljke za led, mahjong igre, marionete, maske za igračke, pozorišne maske, plišani medvjedi, setovi maketa modela, makete vozila, mreže za leptire, mjehurici od sapuna (igračke), štitnici za cjevanice (sportski predmeti), štitnici za koljena (sportski predmeti), skije, zaštitna punjenja (dijelovi sportskih odijela), štitnici za lakat (sportski predmeti), ukrasi za božićna drvca osim predmeta za osvetljavanje i slatkiša, pachinko igre, pojasevi za

plivanje, eksplozivne bombone (božićni krekeri), igra nabacivanja alki, table za stoni fudbal, lopte za igre, pinjate, pištolji igračke, table za crtanje, mekane igračke, peraja za plivanje, predmeti na naduvavanje za kupanje i plivanje, vazdušni pištolji (igračke), igre potkovica, makete vozila, vozila igračke, mašine za fizičko vježbanje, tobogan (stvari za igranje), puzzle, vozila na daljinsko upravljanje, rukavice (pribor za igre), rukavice za plivanje, igrice sa alkama, rolšue, pikado, vozila na daljinsko upravljanje (igračke), sanke (sportski predmeti), mreže (sportski predmeti), šahovske table, šahovske igre, aparati za magične predstave, praktične sale (novosti), vještački snijeg za božićno drveće, sniježne kugle, držači za božićne svijeće, elektronske mete, mete, pozorišne maske, odskočne daske (sportski predmeti), igre na tabli, skice, štapovi za pecanje, džakovi za udaranje, koturaljke, igračke, igračke za kućne ljubimce, mobilni telefoni (igračke), punjene igračke, baloni za igranje.

(111) **14410**

(151) 01.11.2019.

(210) Ž-2018-203

(442) 20.10.2019.

(220) 13.06.2018.

(732) Hemofarm A.D. farmaceutsko-hemijska industrija Vršac, Beogradski put bb, 26300, Vršac, RS
(540)



(550) I

(740) AOD MSA IP - Milojević Sekulić Advokati, Karađorđeva 65, 11000, Beograd, RS

(511) Klasa 5 Dijetetski dodaci (dodaci ishrani) za ljude.

(111) **14411**

(151) 01.11.2019.

(210) Ž-2018-204

(442) 20.10.2019.

(220) 13.06.2018.

(732) Hemofarm A.D. farmaceutsko-hemijska industrija Vršac, Beogradski put bb, 26300, Vršac, RS
(540)

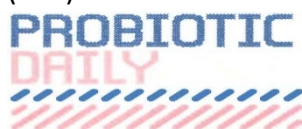

(550) I

(740) AOD MSA IP - Milojević Sekulić Advokati, Karađorđeva 65, 11000, Beograd, RS

(511) Klasa 5 Dijetetski dodaci (dodaci ishrani) za ljude.

(111) **14419**

(151) 05.11.2019.

(210) Ž-2018-260

(442) 20.10.2019.

(220) 24.07.2018.

(732) The Smiley Company SPRL, Avenue Louise 523, 1050, Brussels, BE

(540)

(550) I

(511) Klasa 14 Plemeniti metali i njihove legure; nakit, drago i poludrago kamenje; časovničarski i hronometrijski instrumenti.

Klasa 18 Koža i imitacija kože; životinjske kože i krzna; prtljažne i torbe za nošenje; kišobrani i suncobrani; štapovi za hodanje; bičevi, saračka i sedlarska oprema; ogrlice, povodci i odjeća za životinje.

Klasa 20 Namještaj, ogledala, okviri za slike; kontejneri, ne od metala, za skladištenje ili transport; neobrađena ili polu-obrađena kost, rog , kitova kost ili sedet; školjke; morska pjena (sepiolit); ćilibar.

Klasa 25 Odjeća, obuća, pokrivala za glavu.

Klasa 28 Igre, igračke i predmeti za igranje; aparati za video igre; gimnastički i sportski artikli; ukrasi za jelke.

Klasa 30 Kafa, čaj, kakao i zamjena kate; pirinač; tapioka i sago; brašno i proizvodi od žitarica; hljeb, peciva i konditorski proizvodi; sladoledi; šećer, med, melasa; kvasac, prašak za pecivo; so; senf; sirće, sosovi (kao dodaci); začini; led (zamrznuta voda).

(111) **14420**

(151) 06.11.2019.

(210) Ž-2018-208

(442) 20.10.2019.

(220) 15.06.2018.

(732) Genzyme Corporation (Massachusetts corporation), 50 Binney Street, 02142, Cambridge, MA, US
(540)

(550) I

(740) Božidar S. Radulović, Studentska bb, Lamela 3/18, 81000, Podgorica, ME

(511) Klasa 5 Farmaceutski preparati za tretman hemofilije.

(111) **14421**

(151) 06.11.2019.

(210) Ž-2018-209

(442) 20.10.2019.

(220) 15.06.2018.

(732) Gnenzyme Corporation (Massachusetts corporation), 50 Binney Street, MA 02142, Cambridge, Massachusetts, US
(540)

(550) I

(740) Božidar S. Radulović, Studentska bb, Lamela 3/18, 81000, Podgorica, ME

(511) Klasa 5 Farmaceutski preparati za tretman hemofilije.

(111) **14422**

(151) 06.11.2019.

(210) Ž-2018-210

(442) 20.10.2019.

(220) 15.06.2018.

(732) Genzyme Corporation (Massachusetts corporation), 50 Binney Street, 02142, Cambridge, MA, US
(540)

(550) I

(740) Božidar S. Radulović, Studentska bb, Lamela 3/18, 81000, Podgorica, ME

(511) Klasa 5 Farmaceutski preparati ta tretman hemofilije

(111) **14423**

(151) 06.11.2019.

(210) Ž-2018-211

(442) 20.10.2019.

(220) 15.06.2018.

(732) Genzyme Corporation (Massachusetts corporation), 50 Binney Street, 02142, Cambridge, MA, US

(540)

(550) I

(740) Božidar S. Radulović, Studentska bb, Lamela 3/18, 81000, Podgorica, ME

(511) Klasa 5 Farmaceutski preparati za tretman hemofilije

(111) **14424**

(151) 06.11.2019.

(210) Ž-2018-212

(442) 20.10.2019.

(220) 15.06.2018.

(732) Genzyme Corporation (Massachusetts corporation), 50 Binney Street, 02142, Cambridge, MA, US

(540)

(550) I

(740) Božidar S. Radulović, Studentska bb, Lamela 3/18, 81000, Podgorica, ME

(511) Klasa 1

(111) **14427**

(151) 07.11.2019.

(210) Ž-2018-201

(442) 20.10.2019.

(220) 13.06.2018.

(732) MTEL DOO, Ul. Kralja Nikole 27A, Podgorica, ME

(540)



(550) I

(511) Klasa 35 Oglašavanje i reklamiranje; vođenje komercijalnih poslova; komercijalna administracija; kancelarijski poslovi.

Klasa 38 Telekomunikacije.

(111) **14428**

(151) 07.11.2019.

(210) Ž-2018-202

(442) 20.10.2019.

(220) 13.06.2018.

(732) MTEL DOO, Ul. Kralja Nikole 27A, Podgorica, ME

(540)

(550) I

(511) Klasa 35 Oglašavanje i reklamiranje; vođenje komercijalnih poslova; komercijalna administracija; kancelarijski poslovi.

Klasa 38 Telekomunikacije.

(111) **14433**

(151) 12.11.2019.

(210) Ž-2018-300

(442) 20.10.2019.

(220) 15.08.2018.

(732) Hemofarm A.D. farmaceutsko-hemijska industrija Vršac, Beogradski put bb, 26300, Vršac, RS

(540)

(550) I

(740) AOD MSA IP - Milojević Sekulić Advokati, Karađorđeva 65, 11000, Beograd, RS

(511) Klasa 5 Farmaceutski proizvodi.

(111) **14434**

(151) 12.11.2019.

(210) Ž-2018-162

(442) 20.10.2019.

(220) 04.05.2018.

(732) The Dow Chemical Company, , 48674, Midland, Michigan, US

(540) **V PLUS PERFORM**

(550) I

(740) Božidar S. Radulović, Studentska bb, Lamela 3/18, 81000, Podgorica, ME

(511) Klasa 1 Hemikalije za dalju proizvodnju, naime polioli i izocijanati za upotrebu u proizvodnji izolacionih pjena.

(111) **14435**

(151) 12.11.2019.

(210) Ž-2018-172

(442) 20.10.2019.

(220) 15.05.2018.

(732) Dow AgroSciences LLC, 9330 Zionsville Road, 46268, Indianapolis, Indiana, US

(540) **VIBALLA**

(550) I

(740) Božidar S. Radulović, Studentska bb, Lamela 3/18, 81000, Podgorica, ME

(511) Klasa 5 Pesticidi, preparati za uništavanje štetočina, fungicidi, herbicidi i insekticidi.

(111) **14436**

(151) 12.11.2019.

(210) Ž-2018-285

(442) 20.10.2019.

(220) 01.08.2018.

(732) ALPARGATAS S.A., Avenida Doutor Cardoso de Melo, 1336. 14 andar, Vila Olímpia, 04548-004, São Paulo, SP, BR

(540)

HAVAIANAS

(550) I

(740) Božidar S. Radulović, Studentska bb, Lamela 3/18, 81000, Podgorica, ME

(511) Klasa 25 Odjeća, obuća, pokrivala za glavu;

(111) **14437**

(151) 12.11.2019.

(210) Ž-2018-286

(442) 20.10.2019.

(220) 01.08.2018.

(732) PDMC (HK) LIMITED, RM 1205, 12/F THE METROPOLIS TOWER, 10 METROPOLIS DRIVE, HUNG HOM, HK

(540)



(550) I

(740) Božidar S. Radulović, Studentska bb, Lamela 3/18, 81000, Podgorica, ME

(511) Klasa 34 Duvan, sirovi ili prerađeni ; duvanski proizvodi, uključujući cigare, cigarete, cigarilose, duvan za motanje sopstvenih cigareta, duvan za lule, duvan za žvakanje, burmut, kretek (mješavina duvana i karanfilica, kao i drugih ukusa), snus (mješavina različitih ukusa duvana sa primjesom soli i arome), zamjena duvana (nije za medicinsku upotrebu); artikli za pušače, uključujući papir za cigarete i tube (prazne cigarete), filteri za cigarete, metalne kutije za duvan za žvakanje, kutije za cigarete i pepeljare, lule, džepni aparati za motanje cigareta, upaljači; šibice.

(111) **14438**

(151) 12.11.2019.

(210) Ž-2018-295

(442) 20.10.2019.

(220) 10.08.2018.

(732) David Allen & Co., 407-F Bryant Circle, 93023, Ojai, California, US

(540) DAVID ALLEN COMPANY

(550) I

(740) Božidar S. Radulović, Studentska bb, Lamela 3/18, 81000, Podgorica, ME

(511) Klasa 41 Edukacione i trening usluge; izvođenje obuke i kurseva koji sadrže metode za poboljšanje individualne i organizacione produktivnosti, komunikacije, pisanja, marketinških vještina i vještina upravljanja vremenom, vođenje i organizovanje seminara i radionica za pomoć drugima da razviju sposobnost upravljanja i poslovnih vještina, efikasne radne navike, planiranje i organizacione tehnike, i ličnu produktivnost i rast, i distribuiranje materijala vezanih za kurseve, pružanje onlajn časova, seminara i usluga obuke za pretplaćene članove u oblasti individualne i poslovne produktivnosti, samopoboljšanja i upravljanja vremenom.

(111) **14439**

(151) 12.11.2019.

(210) Ž-2018-296

(442) 20.10.2019.

(220) 10.08.2018.

(732) David Allen & Co., 407-F Bryant Circle, 93023, Ojai, California, US

(540) GETTING THINGS DONE

(550) I

(740) Božidar S. Radulović, Studentska bb, Lamela 3/18, 81000, Podgorica, ME

(511) Klasa 41 Edukacione i trening usluge; izvođenje obuke i kurseva koji sadrže metode za poboljšanje individualne i organizacione produktivnosti, komunikacije, pisanja, marketinških vještina i vještina upravljanja vremenom, vođenje i organizovanje seminara i radionica za pomoć drugima da razviju sposobnost upravljanja i poslovnih vještina, efikasne radne navike, planiranje i organizacione tehnike, i ličnu produktivnost i rast, i distribuiranje materijala vezanih za kurseve, pružanje onlajn časova, seminara i usluga obuke za pretplaćene članove u oblasti individualne i poslovne produktivnosti, samopoboljšanja i upravljanja vremenom.

(111) **14440**

(151) 12.11.2019.

(210) Ž-2018-297

(442) 20.10.2019.

(220) 10.08.2018.

(732) David Allen & Co., 407-F Bryant Circle, 93023, Ojai, California, US

(540)



(550) I

(740) Božidar S. Radulović, Studentska bb, Lamela 3/18, 81000, Podgorica, ME

(511) Klasa 41 Edukacione i trening usluge; izvođenje obuke i kurseva koji sadrže metode za poboljšanje individualne i organizacione produktivnosti, komunikacije, pisanja, marketinških vještina i vještina upravljanja vremenom, vođenje i organizovanje seminara i radionica za pomoć drugima da razviju sposobnost upravljanja i poslovnih vještina, efikasne radne navike, planiranje i organizacione tehnike, i ličnu produktivnost i rast, i distribuiranje materijala vezanih za kurseve, pružanje onlajn časova, seminara i usluga obuke za pretplaćene članove u oblasti individualne i poslovne produktivnosti, samopoboljšanja i upravljanja vremenom.

(111) **14441**

(151) 15.11.2019.

(210) Ž-2018-301

(442) 20.10.2019.

(220) 15.08.2018.

(732) Hemofarm A.D. farmaceutsko-hemijska industrija Vršac, Beogradski put bb, 26300, Vršac, RS

(540) TROMBOMELT

(540)

(550) I

(740) AOD MSA IP - Milojević Sekulić Advokati, Karađorđeva 65, 11000, Beograd, RS

(511) Klasa 5 Farmaceutski proizvodi.

(111) **14442**

(151) 15.11.2019.

(210) Ž-2018-302

(442) 20.10.2019.

(220) 15.08.2018.

(732) Hemofarm A.D. farmaceutsko-hemijska industrija Vršac, Beogradski put bb, 26300, Vršac, RS

(540) **TICAGREX**

(550) I

(740) AOD MSA IP - Milojević Sekulić Advokati, Karađorđeva 65, 11000, Beograd, RS

(511) Klasa 5 Farmaceutski proizvodi

(111) **14443**

(151) 15.11.2019.

(210) Ž-2018-311

(442) 20.10.2019.

(220) 15.08.2018.

(732) Qualcomm Incorporated, 5775 Morehouse Drive, CA 92121, San Diego, California, US

(540) **QUALCOMM**

(550) I

(740) Jasna Jusić, Dalmatinska 2, 81000, Podgorica, ME

(511) Klasa 9 Računarski hardver; računarski softver; centralne procesne jedinice (CPU); integrisana kola; mikroprocesori; mikrokontroleri; poluprovodnici; modemi; senzori; akumulatori; akcelerometri; procesori za aplikacije; računarski hardverski akceleratori; ploče; sklopne ploče; sklopovi za konverziju podataka; uređaji za čuvanje podataka, naime transponderski čipovi i oznake i paketi kartica koji sadrže iste; razvojne ploče, evaluacijske ploče i kompleti referentnih dizajna za poluprovodnike, senzore i softver; kontroleri digitalnog signala; digitalni procesori signala; direktni digitalni sintetizatori; slušalice koje se stavljaju u uši; elektronske kartice za pristup; elektronske identifikacione kartice; elektronske etikete, elektronske naljepnice i elektronske oznake za potrebe identifikacije i sigurnosti; elektronske putne karte; elektronske narukvice; slušalice; elektronski uređaji koji kontrolišu i pretvaraju električnu energiju, naime radiofrekvencijska (RF) pojačala, visoki prekidači i senzori akumulatora; mikroveznice; mikroracunari; mobilni telefoni; uređaji sa omogućenim tehnologijama bliskog polja (NFC); radiofrekvencijski tranzistori; korisnički interfejsi za elektronske uređaje; bežični komunikacioni uređaji za snimanje, organizovanje, prenos, primanje, manipulisanje i pregled glasovnih, tekstualnih, podatkovnih, slikovnih i zvučnih datoteka; računarski hardver, softver i firmver, centralne procesne jedinice (CPU), poluprovodnici, integrisana kola, mikrokontroleri i računarski hardver; računarski softver; centralne procesne jedinice (CPU); integrisana kola; mikroprocesori; mikrokontroleri; poluprovodnici; modemi; senzori; akumulatori; akcelerometri; procesori za aplikacije; računarski hardverski akceleratori; integrisana kola; sklopne ploče; sklopovi za konverziju podataka; uređaji za čuvanje podataka, naime transponderski čipovi i oznake i paketi

kartica koji sadrže iste; razvojne ploče, evaluacijske ploče i kompleti referentnih dizajna za poluprovodnike, senzore i softver; kontroleri digitalnog signala; digitalni procesori signala; direktni digitalni sintetizatori; slušalice koje se stavljaju u uši; elektronske kartice za pristup; elektronske identifikacione kartice; elektronske etikete, elektronske naljepnice i elektronske oznake za potrebe identifikacije i sigurnosti; elektronske putne karte; elektronske narukvice; slušalice; elektronski uređaji koji kontrolišu i pretvaraju električnu energiju, naime radio frekvencijska (RF) pojačala, visoki prekidači i senzori akumulatora; mikrosklopovi; mikroracunari ; mobilni telefoni; uređaji sa omogućenim tehnologijama bliskog polja (NFC); radiofrekvencijski tranzistori; korisnički interfejsi za elektronske uređaje; bežični komunikacioni uređaji za snimanje, organizovanje, prenos, primanje, manipulisanje i pregled glasovnih, tekstualnih, podatkovnih, slikovnih i zvučnih datoteka; kompjuterski hardver, softver i firmver, centralne procesne jedinice (CPU); poluprovodnici, integrisana kola, mikrokontroleri i analize i praćenja, sve za korištenje u razvoju samostalnih softver programa korištenih u uređajima kao sto su prekidači računarskih mreža, moduli za upotrebu u upravljanju motorima, skeneri, upravljači industrijskom automatizacijom ,avio i bežični ručni setovi; razvojni alati bazirani na kompjuterskom hardveru i kompjuterskom softveru, a naročito kompajleri, debageri, integrisana razvojna okruženja, kontrola rada, analiza događaja i trag, sve za upotrebu u razvoju samostalnih softverskih programa koji se koriste u industrijskim, potrošačkim i automobilskim primjenama; računarski hardver i računarski softver za prenos, čuvanje, pretvaranje i prikazivanje podataka s medicinskih uređaja; računarski hardver i softver za stvaranje, programiranje, kontrolu, kodiranje, skeniranje, očitavanje i tumačenje RFID i NFC čipova i oznaka; računarski i softver za punjenje pametnih telefona, tableta i mobilnih elektronskih uređaja; računarski softver za omogućavanje funkcionalnosti sigurnosnih i testnih sistema, uređaja i opreme; računarski softver za omogućavanje funkcionalnosti senzora za upotrebu u automobilskim, potrošačkim , industrijskim i medicinskim primjenama; računarski softver za upravljanje računarskim mrežama; računarski softver praćenje; računarski softver, hardver i čipseti za upotrebu s bežičnim komunikacionim uređajima, potrošačkim elektronskim uređajima, pametnim telefonima, digitalnim kamerama, IP kamerama, dronovima, bespilotnim letilicama (UAVS) i nosivim mobilnim računarima ; periferni računarski uređaji za obradu digitalnih signala, za obradu pozadinskih podataka i informacija o računarskim operativnim sistemima, za praćenje korisničke aktivnosti i lokacije, za omogućavanje aktivacije glasom i dodirrom i za detekciju senzorskih poticaja i pokretanje aplikacija koje odgovaraju određenim senzorskim poticajima kao i računarski softver, hardver i čipseti za upotrebu s tim proizvodima; računarski softver, hardver i čipseti za striming muzike naime kompajleri, povezivači, softver za podršku za pomoć pri razvoju samostalnih programa i softver za pomoć pri razvoju predmetno usmjerenih softverskih aplikacija, kao sto su sistemi baza podataka; računarski softver, naime operativni sistemi, paketi za podršku ploče (BSPS), softver za tehnologiju virtualizacije, hipervizorski softver, ugrađeni softver, softver za programiranje aplikacija interfejsa (API), softverske knjižnice koje se koriste za izradu drugog računarskog softvera; aplikacijski softver za automobilske, potrošačke, zdravstvene, medicinske, aeronautičke, vojne primjene, primjene u celularnoj i mobilnoj komunikaciji, umrežavanju, upravljanju motorima, pametnoj energiji i industriji, protokola, softver za konfigurisanje i optimizacijski softver; softver za filtriranje sadržaja, odnosno, računarski softver za upravljanje sadržajem dostupnim korisniku; upravljački program; softver za planiranje podataka; uređaji i

softver za obradu podataka za omogućavanje, kontrolu, upravljanje i nadzor svih aspekata sistema za bespapirno plaćanje i/ili pristup koji koristi RFID (radiofrekvencijska identifikacija) i/ili NFC (uređaji sa omogućenim tehnologijama bliskog polja) tehnologiju, uključujući omogućavanje korisnicima da napune svoje platne račune na daljinu; softver za detaljno ispitivanje podataka; računarski i softver koji se može preuzimati za razvoj računarskog hardvera i softvera za čipsete za bežične uređaje; softver za bezbjednost preduzeća za upotrebu s pristupnicima i drugim uređajima za umrežavanje radi pružanja mrežne sigurnosti ; firewall softver; integrisani softver za umrežavanje, zaštitu i saradnju ; softver za sigurnost na internetu; softver za utvrđivanje i onemogućavanje nedopuštenog pristupa; softver za ujednačavanje opterećenja; operacijski softver za upravljanje VPN-om (virtualna privatna mreža); integrisana kola, računarski hardver i softver za obradu signala u bežičnim komunikacionim uređajima, potrošačkim elektronskim uređajima, prenosnim medijskim uređajima, mobilnim uređajima za igru, džepnim računarskim uređajima i pametnim telefonima; aparati za snimanje, prenos ili reprodukciju zvuka ili slika; magnetni nosači podataka; diskovi za snimanje; uređaji interfejsa za računarske mreže; elektronski, elektrotehnički i elektromagnetni moduli; oprema za obradu podataka; uređaji za čuvanje podataka; interfejsi za računare; pametne kartice; pametne kartice s integrisanim kolom ; RFID čipovi i oznake; računarski hardver i softver za izradu, programiranje, kontrolu, kodiranje, skeniranje, očitavanje i interpretaciju RFID čipova i oznaka; beskontaktno pametne kartice; pametne kartice s dvostrukim interfejsom; integrisana kola s dvojnim interfejsom koji pružaju vezu između beskontaktnih kartica i kontaktnih kartica; pisari i čitači za bežični prenos do i od transponderskih čipova; elektronski uređaji za ispis i čitanje bežičnog prenosa do i od transponderskih čipova; računarski i program za kontrolu prenosa podataka prema i čitanje podataka sa čipova primopredajnika; mašine za obradu podataka za određivanje tarife koristeći čipove transpondera; kodirane pametne kartice; računarski hardver, softver i periferni uređaji koji se koriste za potrebe kontrole pristupa i autentifikacije; uređaji za praćenje aktivnosti koji se nose; nosive računarske periferne naprave; pametni telefon i; nosivi telekomunikacijski uređaji; višezvezgarni procesori; integrisana kola tačno određene primjene (ASIC); integrisana kola s ugrađenim softverom ; uređaji za obradu signala; DSP (procesor digitalnog signala); vektorski procesori; vektorski procesori signala; komunikacioni procesori; mrežni procesori koji se koriste u mrežnoj i telekomunikacionoj opremi; hardverski ubrzivači za određene primjene; procesori bežičnog baznog pojasa; bazne stanice na čipu, naime bežične bazne stanice na čipu; ntegrisana kola, naime sistemski bazni čipovi i sistemi na čipu (SOC); višezvezgarni mikroupravljači; skupovi poluprovodničkih čipova koji se uglavnom sastoje od poluprovodničkih čipova; moduli integrisanih kola u obliku poluprovodničkih paketa i pakovanja, naime redistribuirana pakovanja čipova (RCP) i sistemi u paketu (SIP); radiofrekvencijski (RF) električni tranzistori; radiofrekvencijski poluprovodnici; senzori, naime inercijski senzori , senzori pritiska, magnetni senzori, dodirni senzori, sve za upotrebu u automobilskim, potrošačkim i industrijskim primjenama; senzori za blizinu ; detektori radara; kapacitivni senzori ; senzori akceleracije; žiroskopski senzori; senzori za računarski interfejs sa softverom , firmverom i elektronskim čipovima s integrisanim kolima; senzorni sistemi koji se sastoje od senzora, računarskog softvera, mikroprocesora, mikrokontrolora i logičkih ili bežičnih protokola za omogućavanje funkcionalnosti senzora za upotrebu u automobilskim , potrošačkim i industrijskim primjenama; elektronski testni instrumenti za razvoj i testiranje sistema na bazi

mikroprocesora; poluprovodničke memorije; poluprovodnički uređaji, mikrokontroleri, integraciona kola, ploče, čipseti, sve za upravljanje radnom frekvencijom, naponom i snagom, optimizacija statičke i dinamičke snage, upravljanje energijom, optimizacija ili smanjenje snage; poluprovodnici, senzori i softver za upotrebu u automobilskim, potrošačkim, aeronautičkim, vojnim primjenama, primjenama u celularnoj i mobilnoj komunikaciji, umrežavanju, upravljanju motorima, pametnoj energiji i industriji; poluprovodnici i softver za upotrebu u zdravstvenim i medicinskim primjenama; poluprovodnici, senzori i softver za upotrebu u primjenama za bežično povezivanje, upravljanje baterijama, pametnu mrežu, pametno mjerenje, jedinicama za kontrolu motora (ECU) i sistemima nadzora pritiska u gumama (TPMS); mikrokontroleri, firmver, senzori i radiofrekvencijski (RF) uređaji i uređaji s analognim sklopovima za upotrebu sa energetski učinkovitim bežičnim punjačima; štampane ploče, naime evaluacijske ploče i kompleti referentnih dizajna koji se sastoje od softvera za poluprovodnike, senzore i softver; poluprovodnici i softver za upotrebu u prenosnim medicinskim uređajima, dijagnostičkim uređajima i uređajima za nadzor pacijenata, terapijskim uređajima i uređajima za medicinsko snimanje; softver za računarske aplikacije, odnosno, računarski softver za upotrebu u aplikacijama za multimediju, videografike, audio zapise i broičano intenzivni proračuni; računarski mrežni softver za prebacivanje; računarski softver za konvergenciju računara; softver za saradnju na računarskoj mreži; softver za kvalitet usluge; softver za mrežni pristup; softver za umrežavanje za upravljanje čipsetima; softver za umrežavanje za obradu sadržaja; računarski softver, naime firmver, aplikacije i razvojni alati, za upotrebu pri obradi mrežnog sadržaja; softver za sprečavanje prekida; softver za dinamičko filtriranje paketa; softver za dinamičko filtriranje aplikacija; sigurnosni softver za preduzeća; softver za bežične radijske upravljače; softver za upravljanje komandnom linijom; softver za prenos glasa IP-om; softver za prenos videozapisa IP-om; softver za umrežavanje i zaštitu za upotrebu s opremom za objedinjeno upravljanje prijetnjama, pristupnicima, integrisanim pristupnim uređajima, ruterima, prekidačima, upravljačima, baznim stanicama, čvorištima i sigurnosnim uređajima; softver uslužnih programa za pojednostavljenje korištenja računara na udaljenim lokacijama i pojednostavljenje mrežne komunikacije između mobilnih korisnika; računarski softver za pružanje sigurnosti za udaljene korisnike i za implementaciju računarskih, softverskih i mrežnih mjera sigurnosti za udaljene korisnike; alat za modeliranje softvera temeljen na komponentama s grafičkim korisničkim interfejsom, automatskim generatorima koda i integrisanom bazom znanja za upotrebu u brzom dizajnu, razvoju, implementaciji, provjeri i optimizaciji ugrađenih aplikacija; softver za upotrebu u razvoju drugih softverskih naslova; elektronske publikacije koje se mogu preuzimati i pretraživati, naime priručnici, uputstva za korisnike, bilješke o aplikacijama i specifikacije proizvoda na temu poluprovodnika, senzora i softvera; uputstva za upotrebu u elektronskom formatu koji se isporučuju sa gore navedenim.

Klasa 38 Pružanje informacija u oblasti telekomunikacija i telekomunikacionih informacija u vezi sa bežičnim komunikacijama i mobilnim tehnologijama; savjetovanje u oblasti telekomunikacionih usluga, naime prenos glasa, podataka i dokumenata putem telekomunikacionih mreža.

Klasa 42 Pružanje informacija u oblasti računara, softvera i računarskih sistema; pružanje informacija u oblasti dizajna i razvoja umrežavanja računarskih podataka; pružanje informacija u oblasti mrežne sigurnosti i računarske sigurnosti; projektovanje integrisanih kola, poluprovodnika, mikroprocesora, računarskog hardvera i softvera, kao i komunikacijskog softvera i mreža za druge;

razvoj, projektovanje i testiranje poluprovodnika, poluprovodničkih uređaja, integrisanih kola, mikrokontrolera, procesora, radiofrekvencijskih (RF) uređaja, senzora i softvera, elektrotehničkih i elektromagnetskih modula i njihovih djelova i građevinskih elemenata, uređaja za čuvanje podataka, interfejsa, pametnih kartica, kontrolera za pametne kartice, kontrolera za RFID čipove i oznake za druge; razvoj računarskog softvera u oblasti mobilnih aplikacija; dizajn i razvoj bežičnih komunikacionih sistema za prenos i prijem glasa, podataka i video sadržaja; projektovanje i razvoj tehnologije za punjenje baterija; projektovanje i razvoj sistema za umrežavanje podataka; projektovanje i razvoj sistema mreže sigurnosti i računarske sigurnosti; projektovanje i razvoj računarskog hardvera i softvera za upravljanje i kontrolu dronova; projektovanje i razvoj računarskog hardvera i softvera za upravljanje i kontrolu robota ; projektovanje i razvoj računarskog hardvera i softvera za upravljanje i kontrolu automobila; računarstvo u oblaku sa softverom za prenos, čuvanje, pretvaranje i prikazivanje podataka s medicinskih uređaja; razvoj tehnologije bežičnog prenosa energije za upotrebu kod punjenja vozila; platforma kao usluga (PAAS) s platformama računarskog softvera za upotrebu pri razvijanju, programiranju, gradnji i izradi prototipa uređaja koji spadaju pod internet stvari (IOT); platforma kao usluga (PAAS) s računarskim softverskim platformama za bežično prikupljanje, prenos, pretvaranje i skladištenje podataka s medicinskih uređaja; pružanje tehničkih informacija u oblasti poluprovodnika, poluprovodničkih uređaja, integrisanih kola, mikrokontrolera, procesora, radiofrekvencijskih (RF) uređaja, senzora i softvera; savjetovanje u oblasti telekomunikacione tehnologije; projektovanje i razvoj sistema bežične komunikacije za potrebe autentičnosti; obezbjeđivanje privremenog korištenja, bez mogućnosti preuzimanja, mrežnih softverskih aplikacija, razvojnih platformi i razvojnih alata koji omogućavaju programerima softvera da razviju , programiraju , izrade i naprave prototipni softver za integrisana kola, čipove i opremu za obradu podataka; usluge računarskog programiranja; istraživanje i projektovanje antena za skeniranje, očitavanje i tumačenje RFID čipova i oznaka; istraživanje i projektovanje NFC uređaja (uređaji sa omogućenim tehnologijama bliskog polja), instrumenata i opreme; savjetodavne usluge u vezi sa svime prethodno navedenim.

(111) **14444**

(151) 15.11.2019.

(210) Ž-2018-317

(442) 20.10.2019.

(220) 21.08.2018.

(732) Mubadala Trade Marks Holding Company - LLC, P. O. Box 45005, Abu Dhabi, AE

(540)

MASDAR



(550) I

(740) Božidar S. Radulović, Studentska bb, Lamela 3/18, 81000, Podgorica, ME

(511) Klasa 11 Aparati za osvetljenje, naime aparati za rasvjetu u obliku panela, aparati za rasvjetu u obliku blinker stroboskopa, aparati za osvjetljavanje za vozila; aparati za grijanje, naime, aparati na topli vazduh za grijanje prostora, električni indukcionni grijači za grijanje metalnih radnih dijelova, grejni aparati za odmrzavanje stakala na vozilima; aparati za proizvodnju pare, naime, aparati za grijanje parom, aparati za razmjenu supstanci i toplote za upotrebu u proizvodnji pare, za upotrebu u kuvanju i za upotrebu u rashladnim sistemima; aparati za kuvanje, naime kuhinjski šporeti, mikrotalasne peći; rashladni aparati, naime, frižideri, kondenzatori frižidera, mašine za hlađenje; aparati za sušenje, naime, aparati za sušenje ruku u toaletima, sušači za odjeću, ručne električne sušilice za kosu (fenovi), industrijski sušači za grijanje i uklanjanje vlage; aparati za ventilaciju, naime, ventilatori za komercijalnu i industrijsku upotrebu, izduvni ventilatori , ventilacioni otvori; aparati za snadbijevanje vodom, naime industrijski aparati za prečišćavanje vode, aparati za prečišćavanje vode sa česme, aparati za filtriranje vode, aparati za filtriranje vode za dejonizaciju vode, prečišćavanje vode i aparat za filtriranje; aparati za sanitarne namjene, naime, toaleti.

Klasa 37 Izgradnja zgrada; popravka zgrada; pružanje instalacionih usluga, naime, elevatora i liftova, građevinskih skela, radnih i građevinskih platformi, električnih sistema, uređaja, prozora, instalacija u zgradama.

Klasa 42 Naučne i tehnološke usluge i usluge istraživanja i projektovanja u oblasti integrisane systemske arhitekture koja omogućava brzi razvoj visoko interaktivnih i prilagodljivih aplikacija za učenje u vezi sa tim; industrijske analize u obliku industrijskih istraživanja u eksploataciji naftnih polja i istraživačkih usluga u oblasti informacionih i telekomunikacionih tehnologija; biološka istraživanja; geološka istraživanja; istraživanja u oblasti zaštite životne sredine; projektovanje i razvoj računarskog hardvera i softvera.

(111) **14445**

(151) 20.11.2019.

(210) Ž-2018-101

(442) 20.10.2019.

(220) 02.04.2018.

(732) Soho Gradnja d.o.o., Bulevar Revolucije 10A, 85000, Bar, ME

(540)



(550) I

(511) Klasa 37 izgradnja - usluge preduzetnika i podizvođača u području izgradnje ili proizvodnje trajnih građevina, usluge izgradnje zgrada, puteva, mostova, brana, dalekovoda kao i usiuge

specijalizovanih preduzeća u području izgradnje, kao sto su moleri, limari, postavljači centrainog grijanja i pokrivači krovova;- dodatne građevinske usluge kao sto je nadziranje građevinskih projekata;

(111) **14446**

(151) 20.11.2019.

(210) Ž-2018-102

(442) 20.10.2019.

(220) 02.04.2018.

(732) Soho Gradnja d.o.o., Bulevar Revolucije 10A, 85000, Bar, ME

(540)



(550) I

(511) Klasa 36 upravljanje nekretninama - usluge administriranja zgradama, to jest usluge iznajmljivanja, procjene nekretnina ili usluge finansiranja; usluge iznajmljivanja nekretnina kao sto su kuće, stanovi, itd. namijenjeni za stalno korišćenje.

Klasa 39 prevoz ,usluge prevoza osoba ili proizvoda s jednog mjesta na drugo (zeljeznicom, putem, vodenim putem, vazduhom ili cjevovodima i dalekovodima) i usluge koje su neophodno vezane za te prevoze, konsultacije u vezi prevoza, usluge iznajmljivanja prevoznih sredstava; usluge obavještavanja o putovanjima ili prevozu robe preko posrednika ili turističkih agencija; usluge organiziranja putovanja koje pružaju turističke agencije, usluge praćenja putnika

Klasa 41 razonoda ,usluge čiji je osnovni cilj razbibriga, zabava ili rekreacija lica; usluge diskoteka.

(111) **14447**

(151) 20.11.2019.

(210) Ž-2018-103

(442) 20.10.2019.

(220) 02.04.2018.

(732) Soho Gradnja d.o.o., Bulevar Revolucije 10A, 85000, Bar, ME

(540)



(550) I

(511) Klasa 41 razonoda ,usluge čiji je osnovni cilj razbibriga, zabava ili rekreacija lica; usluge diskoteka.

Klasa 43 usluge obezbjeđenja hrane i pića, usluge koje pružaju lica ili preduzeća čiji cilj je priprema jela ili pića za potrošnju kao i usluge ishrane i smještaja, koje pružaju hoteli, pansioni ili druga preduzeća koja osiguravaju privremeni smještaj.

(111) **14448**

(151) 20.11.2019.

(210) Ž-2018-104

(442) 20.10.2019.

(220) 02.04.2018.

(732) Soho Gradnja d.o.o., Bulevar Revolucije 10A, 85000, Bar, ME

(540)



SOHO GROUP
MONTENEGRO

(550) I

(511) Klasa 35 vođenje komercijainih poslova, komercijaina administracija, kanceiarijski poslovi - pomoć u radu i upravljanju privrednim društvima, i pomoć u vođenju poslova ili komercijalnih funkcija industrijskog ili trgovačkog preduzeća, konsultacije u vezi vođenja komercijalnih poslova.

Klasa 36 upravljanje nekretninama - usluge administriranja zgradama, to jest usluge iznajmljivanja, procjene nekretnina ili usluge finansiranja; usluge iznajmljivanja nekretnina kao sto su kuće, stanovi, itd. namijenjeni za stalno korišćenje.

Klasa 37 izgradnja - usluge preduzetnika i podizvođača u području izgradnje ili proizvodnje trajnih građevina, usluge izgradnje zgrada, puteva, mostova, brana, dalekovoda kao i usiuge specijalizovanih preduzeća u području izgradnje, kao sto su moleri, limari, postavljači centrainog grijanja i pokrivači krovova;- dodatne građevinske usluge kao sto je nadziranje građevinskih projekata;

Klasa 39 prevoz ,usluge prevoza osoba ili proizvoda s jednog mjesta na drugo (zeljeznicom, putem, vodenim putem, vazduhom ili cjevovodima i dalekovodima) i usluge koje su neophodno vezane za te prevoze, konsultacije u vezi prevoza, usluge iznajmljivanja prevoznih sredstava; usluge obavještavanja o putovanjima ili prevozu robe preko posrednika ili turističkih agencija; usluge organiziranja putovanja koje pružaju turističke agencije, usluge praćenja putnika

Klasa 41 razonoda ,usluge čiji je osnovni cilj razbibriga, zabava ili rekreacija lica; usluge diskoteka.

Klasa 43 usluge obezbjeđenja hrane i pića, usluge koje pružaju lica ili preduzeća čiji cilj je priprema

jela ili pića za potrošnju kao i usluge ishrane i smještaja, koje pružaju hoteli, pansioni ili druga preduzeća koja osiguravaju privremeni smještaj.

(111) **14449**

(151) 20.11.2019.

(210) Ž-2018-229

(442) 20.10.2019.

(220) 03.07.2018.

(732) Kingspan Holdings (IRL) Limited, an Irish company, Dublin Road, Kingscourt, Co. Cavan, IE

JORIS IDE THERMOCONFORT

(540)

(550) I

(740) Jasna Jusić, Dalmatinska 2, 81000, Podgorica, ME

(511) Klasa 17 Izolacija za građevinske svrhe; proizvodi i materijali za toplotnu izolaciju; termoizolacioni materijal; izolacioni omoti za industrijske cijevi; omoti za cijevi za svrhu izolacije; izolacija za podzemne cijevi i cistijerne; izolacija od fiberglasa; izolacione ploče; izolacija cijevi; tkanine za izolaciju; izolacija od fiberglasa za zgrade; staklena vuna za izolaciju; fleksibilna elastomjerna toplotna izolacija; izolacioni materijal za krovove; izolacioni materijali od plastike; metalna folija za izolaciju; proširena polistirenska podna izolacija; polietilenska folija za izolaciju; prethodno formirane izolacione komponente; kamena vuna za izolaciju; tkanine od neorganskih vlakana za izolaciju; proizvodi i materijali za akustičnu izolaciju; izolaciona ploča od mineralne vune; fiber ploča za upotrebu kao izolacija; poliuretanska pjena niske gustine za izolaciju; izolacija u obliku podnih obloga; vlakna impregnirana sintetičkim smolama za izolaciju; poliuretanski film za upotrebu kao građevinska izolacija; proizvodi od gume za svrhu izolacije; proizvodi od sintetičkog kaučuka za svrhu izolacije; izolacione pjene za upotrebu u građevinarstvu; poliuretanska pjena za upotrebu kao građevinska izolacija; tkanine od vune za upotrebu kao izolacija; tkanine od organskih vlakana za upotrebu kao izolacija; pjena za folije za upotrebu kao građevinska izolacija; tkanine od hemijski proizvedenih vlakana za upotrebu kao izolacija; tkanine istkane iz keramičkih vlakana za upotrebu kao izolacija; Materijali otporni na toplotu (izolacija); toplotna izolacija od silikonske pjene; vlakna za izolaciju pri visokim temperaturama; termoizolacioni omoti za ventile; obloženi tekstilni proizvodi za izolaciju; obloženi vatirani proizvodi za svrhu izolacije; polietersko runo za toplotnu izolaciju; pjena za upotrebu kao toplotna izolacija; izolacioni materijali za izolaciju od toplote; laminati koji sadrže poliamidne pjene za termalnu izolaciju; izolacije sa zaptivnim funkcijama za zaštitu od toplote; laka ploča od mineralne vune za termoizolaciju ; termoizolacioni materijal za izgradnju potkrovlja; termoizolacioni materijal koji se koristi za pretvaranje potkrovlja; akustična izolacija za zgrade; akusticne ploče za izolaciju; akustični izolacioni barijerni paneli; izolacioni materijali u vidu pjene za upotrebu u građevinarstvu; materijali za zaptivanje i izolaciju; poliuretanski film koji se koristi za zaptivanje i izolaciju zgrada; izolacioni file; izolacioni premazi; izolacioni listovi; izolacione table; izolacione ploče; izolacioni paneli; izolacioni malter; izolacione tkanine; izolacioni materijali; izolacione supstance; izolacioni fileri ; ploče za izolaciju; izolacioni

materijali za gradnju; termoizolacioni proizvodi; termoizolacioni materijali; akustični izolacioni paneli; Akusticne izolacione ploce; Izolacioni materijali za izolaciju od zvuka.

Klasa 19 Gradevinski materijali (nemetalni)

(111) **14450**

(151) 20.11.2019.

(210) Ž-2018-232

(442) 20.10.2019.

(220) 03.07.2018.

(732) FRUIT SHIPPERS LIMITED, Third Floor, Charlotte House, Charlotte Street P.O.Box, 10051, Nassau, BS

BONITA

(540)

(550) I

(740) Mladen Đ. Čolović, Dalmatinska 2, 81000, Podgorica, ME

(511) Klasa 30 Kafa, kakao i zamjena za kafu; čokolada.

(111) **14451**

(151) 20.11.2019.

(210) Ž-2018-168

(442) 20.10.2019.

(220) 14.05.2018.

(732) Colgate-Palmolive Company, a Delaware Corporation, 300 Park Avenue, 10022, New York, New York, US

(540) **PALMOLIVE CLAY + PURITY**

(550) I

(740) Jasna Jusić, Dalmatinska 2, 81000, Podgorica, ME

(511) Klasa 3 Proizvodi za ličnu higijenu, odnosno, preparati za čišćenje kože i tijela; sapun; tečni sapun za ruke; gelovi i kreme za tuširanje; kupke; preparati za njegu kose; dezodoransi, preparati protiv znojenja i sprejevi za ispod pazuha za ličnu upotrebu; preparati za hidrataciju tijela i kože, losioni i kreme; puder u prahu; preparati za brijanje; preparati za kozmetičko potamnjivanje i preparati za zaštitu kože od uticaja sunca; maramice natopljene rastvorom za čišćenje

(111) **14452**

(151) 20.11.2019.

(210) Ž-2018-177

(442) 20.10.2019.

(220) 18.05.2018.

(732) WEETABIX LIMITED, Weetabix Mills, Burton Latimer, NN15 5JR, Kettering, Northants, GB

(540) **MINIBIX**

(550) I

(740) Miladin Popović, ul. Capital Plaza, ulica šeiika Zajeda 13-IV/68, 81000, Podgorica, ME

(511) Klasa 30 Kafa, čaj, kakao, secer, riza, tapioka, sago, zamjene za kafu; brasno i proizvodi od zitarica, hleb, kolaci, poslastice, bomboni, sladoled; med, sirup od melase; kvasac, prasak za pecivo; so, senf; sirce, prelive, zacini, razni zacini led za hladenje, a narocito: zitarice; preparati od zitarica; zitarice u prahu; preradene zitarice; grickalice od zitarica; preparati od zitarica namenjeni za dorucak; zitarice za dorucak; ljuspice od zitarica za dorucak; musli; grickalice na bazi zitarica, stanglice od zitarica, snek stanglice, prehrambeni proizvodi od zitarica; grickalice napravljene od zitarica; snek stanglice napravljene od zitarica; snek stanglice na bazi zitarica; spremna za jesti hrana na bazi zitarica; stanglice na bazi zitarica ili ovsa sa ,ocem: vocne snek stanglice na bazi zita; snek stanglice na bazi granole. zitarice na bazi granole: granola; kasa; krekeri, hleb, peciva, nemedicinske poslastice; biskviti. keksi, kolaci. kolaciči; vazdusaste grickalice od kukuruza; vazdusaste kukuruzne grickalice sa ukusom sira. pufne od sira; grickalice zasnovane na zrnu zitarica: pšenichni biskviti: grickalice na bazi kukuruza; grickalice na bazi granole; grickalice na bazi rize; grickalice na bazi pšenice: arome za pica; preparati za hranu za ljudsku upotrebu koj i se sastoje od zitarica. suvog voca i orasastih plodova. zitarice prevladuju

(111) **14453**

(151) 20.11.2019.

(210) Ž-2018-294

(442) 20.10.2019.

(220) 10.08.2018.

(732) Bank of America Corporation (A corporation organized and existing under the laws of the State of Delaware), 100 North Tryon Street, 28255, Charlotte, North Carolina, US

(540) BOFA

(550) I

(740) Miladin Popović, ul. Capital Plaza, ulica šeiika Zajeda 13-IV/68, 81000, Podgorica, ME

(511) Klasa 36 Osiguranje; finansijski poslovi; monetarni poslovi; poslovi vezani za nepokretnosti; bankarske usluge; finansijske usluge; finansijska analiza; menadžment i konsalting; usluge kapitalnih investicija; brokerske usluge; transakcija i trgovanje finansijskim instrumentima; pružanje finansijskih informacija; usluge tinansiranja, hartija od vrijednosti i robe; finansijske usluge u vezi sa investicionim uslugama; usluge kreditnih i debitnih kartica; finansijsko istraživanje; i pružanje ovih usluga putem online globalne računarske mreže.

Klasa 42 Naučne i tehnoloske usluge i istraživanje i dizajniranje koje se odnosi na njih; usluge industrijske analize i istraživanja; projektovanje i razvoj računarskog hardvera i softvera; računarsko programiranje; savjetovanje u vezi sa računarskim softverom; analiza računarskih sistema; obezbjeđivanje online računarskog softvera; obezbjeđivanje online računarskog softvera za pristup finansijskim informacijama i uslugama putem online globalne računarske mreže.

(111) **14454**

(151) 20.11.2019.

(210) Ž-2018-236

(442) 20.10.2019.

(220) 04.07.2018.

(732) BRITISH AMERICAN TOBACCO (BRANDS) LIMITED, Globe House 4 Temple Place, WC2R 2PG, London, GB

(540)  CORES

(550) I

(740) Miladin Popović, ul. Capital Plaza, ulica šeika Zajeda 13-IV/68, 81000, Podgorica, ME

(511) Klasa 34 Cigarete; duvan, sirov ili prerađen; proizvodi od duvana; zamjene za duvan (ne u medicinske svrhe); cigare; cigarilosi; upaljači; šibice; artikli za pušače; cigaret papir; cigaret tube; filteri za cigarete; džepni aparati za zamotavanje cigareta; ručne mašine za ubrizgavanje duvana u papirne tube; elektronske cigarete; tečnosti za elektronske cigarete; duvanski proizvodi namijenjeni za zagrijavanje; uređaji i dijelovi za uređaje za zagrijavanje duvana i zamjene za duvan za potrebe inhalacije.

(111) **14455**

(151) 20.11.2019.

(210) Ž-2018-230

(442) 20.10.2019.

(220) 03.07.2018.

(732) FRUIT SHIPPERS LIMITED, Third Floor, Charlotte House, Charlotte Street P.O.Box, 10051, Nassau, BS

(540)



(550) I

(740) Mladen Đ. Čolović, Dalmatinska 2, 81000, Podgorica, ME

(511) Klasa 29 konzervisano, zamrznuto, sušeno i kuvano voće i povrće; želei, džemovi i kompoti.

Klasa 30 kafa, kakao i zamjena za kafu; čokolada.

Klasa 31 svježe voće i povrće.

(111) **14456**

(151) 20.11.2019.

(210) Ž-2018-231

(442) 20.10.2019.

(220) 03.07.2018.

(732) FRUIT SHIPPERS LIMITED, Third Floor, Charlotte House, Charlotte Street P.O.Box, 10051, Nassau, BS

(540)



(550) I

(740) Mladen Đ. Čolović, Dalmatinska 2, 81000, Podgorica, ME

511) Klasa 29 konzervisano, zamrznuto, sušeno i kuvana voće i povrće; želei, džemovi i kompoti.

Klasa 30 kafa, kakao i zamjena za kafu; čokolada.

Klasa 31 svježe voće i povrće.

(111) **14457**

(151) 21.11.2019.

(210) Ž-2018-96

(442) 20.10.2019.

(220) 27.03.2018.

(732) Tricontinental Export Import, Peka Pavlovica 1, 81250, Cetinje, ME

(540) **MILLENNIUM**

(550) I

(740) Miladin Popović, ul. Capital Plaza, ulica šeika Zajeda 13-IV/68, 81000, Podgorica, ME

(511) Klasa 29 Konzervisana tunjevina.

(111) **14458**

(151) 21.11.2019.

(210) Ž-2018-169

(442) 20.10.2019.

(220) 14.05.2018.

(732) Colgate-Palmolive Company, a Delaware Corporation, 300 Park Avenue, 10022, New York, New York, US

(540)



(550) I

(740) Jasna Jusić, Dalmatinska 2, 81000, Podgorica, ME

(511) Klasa 3 Preparati za bijeljenje; preparati za pranje veša; sredstva za čišćenje; preparati za poliranje; preparati za čišćenje; abrazivni preparati; preparati za čišćenje rerne; preparati za čišćenje odvoda; preparati za čišćenje poda; preparati za čišćenje stakla; preparati za čišćenje tepiha; preparati za čišćenje za upotrebu na pločicama; sredstva za čišćenje toaleta; sredstva za čišćenje tapacira; preparati za čišćenje u domaćinstvu.

(111) **14459**

(151) 21.11.2019.

(210) Ž-2018-170

(442) 20.10.2019.

(220) 15.05.2018.

(732) CHAMPION PRODUCTS EUROPE LIMITED, Suite 8, Plaza 212, Blanchardstown Corporate Park 2, 15, Blanchardstown, Dublin, IE

(540)

The logo for Champion, featuring the word "Champion" in a stylized, cursive font with a small "C" in a shield-like shape at the beginning.

(550) I

(740) Jasna Jusić, Dalmatinska 2, 81000, Podgorica, ME

(511) Klasa 18 Koža i imitacije kože, životinjske kože i krzna; ručni prtljag i putne torbe, uključujući, koferi, kovcezi, sportske torbe, ručne putne torbe, školske torbe, ranci koji se vezu vrpcom, ruksaci, torbice koje se nose oko struka, torbe za teretane, ceger torbe; kišobrani i suncobrani; štapovi za hodanje; bičevi, saracka i i sedlarska roba; ogrlice, povodci i odjeća za životinje

(111) **14460**

(151) 21.11.2019.

(210) Ž-2018-171

(442) 20.10.2019.

(220) 15.05.2018.

(732) CHAMPION PRODUCTS EUROPE LIMITED, Suite 8, Plaza 212, Blanchardstown Corporate Park 2, 15, Blanchardstown, Dublin, IE

(540)

The logo for Champion, featuring a stylized "C" with a vertical bar through the center, forming a shield-like shape.

(550) I

(740) Jasna Jusić, Dalmatinska 2, 81000, Podgorica, ME

(511) Klasa 18 Koža i imitacije kože, životinjske kože i krzna; ručni prtljag i putne torbe, uključujući, koferi, kovčezi, sportske torbe, ručne putne torbe, školske torbe, ranci koji se vezu vrpcom, ruksaci, torbice koje se nose oko struka, torbe za teretane, ceger torbe; kišobrani i suncobrani; štapovi za hodanje; bičevi, saracka i i sedlarska roba; ogrlice, povodci i odjeća za životinje.

(111) **14461**

(151) 21.11.2019.

(210) Ž-2018-223

(442) 20.10.2019.

(220) 25.06.2018.

(732) PETIT BATEAU, 15 rue du Lieutenant Pierre Murard, 10 000, Troyes, FR

(540)



(550) I

(740) Jasna Jusić, Dalmatinska 2, 81000, Podgorica, ME

(511) Klasa 25 Odjeća, obuća, pokrivala za glavu za nošenje; konfekcija za muškarce, žene i djecu; trikotaža i čarape; žensko donje rublje, donje rublje, pidžame, bade mantili, kupaći kostimi, džemperi, suknje, haljine, pantalone, jakne, kaputi, krzna (odjeća), odijela, košulje, komplet rublja za novorođenčad, kravate, šalovi, marama, krzno koje se nosi oko vrata, kaiševi (odjeća), rukavice (odjeća), kapice, pokrivala za glavu, kape; sokne, čarape i najlonske čarape; obuća (osim ortopedске obuće), papuče, čizme; kupaći kostimi i muške kupaće gaće; vodootporna odjeća.

Klasa 28 Igre i igračke, igre s kartama, društvene igre na tabli ili stolne igre; setovi za igre dame i setovi za šah; društvene igre na tabli za odrasle i djecu; nagradne igre; igre na sreću, znanje, vještinu i prognoze; karte za igranje; gimnastički i sportski predmeti (osim odjeće, obuće i strunjača); ukrasi za jelke (osim osvjetljenja i slatkiša), igračke maske, lutke, kuće, kreveti, odjeća i bočice za hranjenje lutaka; plišane igračke, plišani medvedići, plišane igračke (igračke) kao prenosni predmeti koji su umirujući za djecu; lopte za igre, baloni za igranje; marionete; čigre; konjići koji se ljuljaju (igračke). Igre i igračke, igre s kartama, društvene igre na tabli ili stolne igre; setovi za igre dame i setovi za šah; društvene igre na tabli za odrasle i djecu; nagradne igre; igre na sreću, znanje, vještinu i prognoze; karte za igranje; gimnastički i sportski predmeti (osim odjeće, obuće i strunjača); ukrasi za jelke (osim osvjetljenja i slatkiša), igračke maske, lutke, kuće, kreveti, odjeća i bočice za hranjenje lutaka; plišane igračke, plišani medvedići, plišane igračke (igračke) kao prenosni predmeti koji su umirujući za djecu; lopte za igre, baloni za igranje; marionete; čigre; konjići koji se ljuljaju (igračke). Igre i igračke, igre s kartama, društvene igre na tabli ili stolne igre; setovi za igre dame i setovi za šah; društvene igre na tabli za odrasle i djecu; nagradne igre; igre na sreću, znanje, vještinu i prognoze; karte za igranje; gimnastički i sportski predmeti (osim odjeće, obuće i strunjača); ukrasi za jelke (osim osvjetljenja i slatkiša), igračke maske, lutke, kuće, kreveti, odjeća i bočice za hranjenje lutaka; plišane igračke, plišani medvedići, plišane igračke (igračke) kao prenosni predmeti koji su umirujući za djecu; lopte za igre, baloni za igranje; marionete; čigre; konjići koji se ljuljaju (igračke).

Klasa 35 Oglašavanje; poslovni menadžment; poslovna administracija; kancelarijski poslovi; distribucija brošura i primjeraka; priprema novinskih pretplata za druge; poslovno savjetovanje, informacije i upiti; računovodstvo; reprodukcija dokumenata; agencije za zapošljavanje; upravljanje

atotekama (kompjuterizovane -) ;organizovanje izložbi u komercijalne ili reklamne svrhe; prezentacija roba na komunikacionim medijima za potrebe maloprodaje i za onlajn prodaju; maloprodaja i onlajn prodaja sljedećih roba: odjeće, obuće, pokrivala za glavu za nošenje;konfekcije za muškarce, žene i djecu; trikotaže i čarapa; ženskog donjeg rublja,donjeg rublja, pidžama, bade mantila, kupaćih kostima, džempera, sukanja, haljina, pantalona, jakni, kaputa, krzna (odjeća), odijela, košulja, komplet rublja za novorođenčad , kravata, salova, marama za vrat, epitrahila, marama, kaiševa (odjeća), rukavica (odjeća) , kapa (pokrivala za glavu), pokrivala za glavu, kapa sa šiltom , sokni, čarapa, najlonskih čarapa; obuće (osim ortopedске obuće), papuča,čizama; kupaćih kostima i muških kupaćih gaća; vodootporne odjeće, igre i igračke,igre s kartama, društvene igre na tabli ili stolne igre; igara na tablama, šah , igara na tabli za odrasle i djecu; nagradne igre; igre na sreću, znanje, vještinu i prognoze;karte za igranje; gimnastički i sportski predmeti (osim odjeće, obuće i strunjača); ukrasi za jelke (osim osvjetljenja i slatkiša) , igračke maske, lutke, kuće, kreveti,odjeća i bočice za hranjenje lutaka; plišane igračke, plišani medvedići, plišane igračke (igračke) kao prenosni predmeti koji su umirujući za djecu; lopte za igre, lutke za ruke; čigre; konjići koji se ljuljaju (igračke), združivanje raznovrsne robe za druge (izuzev transporta iste), naime; odjeće, obuće, pokrivala za glavu za nošenje; konfekcije za muškarce, žene i djecu; trikotaže i čarapa; ženskog donjeg rublja, donjeg rublja, pidžama, bade mantila, kupacih kostima, džempera, sukanja, haljina, pantalonica, pantalona, jakni, kaputa, krzna (odjeća), odijela, košulja, komplet rublja za novorođenčad, kravata, šalova, marama za vrat, epitrahila, marama, kaiševa (odjeća), rukavica (odjeća), kapa (pokrivala za glavu), pokrivala za glavu, kapa sa šiltom ; sokni, čarapa, najlonskih čarapa; obuće (osim ortopedске obuće), papuča, čizama; kupaćih kostima i muških kupaćih gaća; vodootporne odjeće, igre i igračke, igre s kartama, društvene igre na tabli ili stolne igre; igara na tablama, šah, igara na tabli za odrasle i djecu; nagradne igre; igre na sreću, znanje, vještinu i prognoze; karte za igranje; gimnastički i sportski predmeti (osim odjeće, obuće i strunjača);ukrasi za jelke (osim osvjetljenja i slatkiša) , igračke maske, lutke, kuce, kreveti,odjeća i bočice za hranjenje lutaka; plišane igračke, plišani medvedići, plišane igračke (igračke) kao prenosni predmeti koji su umirujuci za djecu; lopte za igre, lutke za ruke; čigre; konjići koji se ljuljaju (igračke), omogućavajući korisnicima da ugodno pregledaju i kupe tu robu.

(111) **14462**

(151) 21.11.2019.

(210) Ž-2018-157

(442) 20.10.2019.

(220) 03.05.2018.

(732) TURKIYE CUMHURİYETİ ZIRAAT BANKASI ANONİM ŞİRKETİ, DOĞANBEY M., ATATÜRK BLV. NO:8, ULUS, ALTINDAG , ANKARA, TR

(540)



(550) I

(740) Miladin Popović, ul. Capital Plaza, ulica šeiika Zajeda 13-IV/68, 81000, Podgorica, ME

(511) Klasa 9 Aparati i instrumenti naučni, pomorski, geodetski, fotografski, kinematografski, optički, za vaganje, mjerenje, signalizaciju, kontrolu (inspekciju), spasavanje i nastavu; aparati i instrumenti za provođenje, prekid, transformaciju, akumulaciju, regulisanje ili kontrolu električne energije; aparati za snimanje, prenos i reprodukovanje zvuka ili slike; magnetni noači podataka, diskovi za snimanje; kompakt diskovi, DVD i drugi digitalni nosači podataka; mehanizmi za aparate koji se pokreću novcem; registar kase, računске mašine, oprema za obradu podataka, računari; računarski softver; aparati za gašenje požara.

Klasa 36 Osiguranje; finansijski poslovi; novčani (monetarni) poslovi; poslovi vezani za nepokretnosti

(111) **14463**

(151) 21.11.2019.

(210) Ž-2018-163

(442) 20.10.2019.

(220) 07.05.2018.

(732) American-Cigarette Company (Overseas) Limited, Route de France 17, 2926, Boncourt, CH
(540)



(550) I

(511) Klasa 34 Cigarete; duvan, sirov ili prerađen; rezani duvan; duvan za lule; proizvodi od duvana; zamjene za duvan (ne u medicinske svrhe); cigare, cigarilosi; upaljači za cigarete; upaljači za cigare; šibice; artikli za pušače; cigaret papir; cigaret tube; filteri za cigarete; džepni aparati za zamotavanje cigareta; ručne mašine za ubrizgavanje duvana u papime tube; elektronske cigarete; tečnosti za elektronske cigarete; duvanski proizvodi namjenjeni za zagrijavanje.

(111) **14464**

(151) 22.11.2019.

(210) Ž-2018-165

(442) 20.10.2019.

(220) 10.05.2018.

(732) Laticrete International, Inc., One Laticrete Park, 06524-3423, North Bethany, CT, US
(540)



(550) I

(740) Miladin Popović, ul. Capital Plaza, ulica šeiKa Zajeda 13-IV/68, 81000, Podgorica, ME

(511) Klasa 1 Hemijski proizvodi koji se upotrebljavaju u industriji, nauci. fotografiji, kao i u poljoprivredi, hortikulturi i šumarstvu; neprerađene vjestacke smole, neprerađene plasticne materije; smese za gasenje pozara i za sprecavanje pozara; preparati za kaljenje i zavarivanje; materije za stavljenje zivotinjske koze i krzna; lepljive supstance koje se upotrebljavaju u industriji; gitovi i druge materije za punjenja; kompost, stajska dubriva, dubriva; bioloski preparati za upotrebu u industriji i nauci; hemijski preparati za industrijsku upotrebu; hemikalije za beton; vezivna sredstva, ukljucujuci vezivna sredstva za beton na bazi vode; sredstvo na bazi vode koje smanjuje isparavanje betona; preparati za formiranje hemijskih veza za industrijsku upotrebu, naime, polimemi lateks aditiv kao vezivno sredstvo za beton, maher, gips, plocice, cigle, kamen, mermer i tecni cementni rastvor za gradevinarstvo; hemijske smese za hidroizolaciju proizvoda koji se koriste u zidarstvu, plocastih i drugih proizvoda koji se koriste u gradevinarstvu i gradevinskim površinama, kao sto su bazeni, unutrasnje gradevinske površine i spoljasnje gradevinske površine; polimerni aditivi u hemijskom obliku za proizvodnju iii preradu maltera, tecnog cementnog rastvora, gipsa, stukature, betona i drugih cementnih mesavina; lateks aditivi u hemijskom obliku za proizvodnju iii preradu maltera, tecnog cementnog rastvora, gipsa, stukature, betona i drugih cementnih mesavina; preparati za hidroizolaciju betona, izuzev boja; hidroizolacione membrane na bazi tecnog polimera (kaučuka) za upotrebu u izgradnji, popravci i oddavanju zgrada; hemijska jedinjenja za stvrdnjavanje betona, ukljucujući jedinjenja za stvrdnjavanje na bazi akrila, vode, smole i voska; vezivna sredstva za beton; supstance za stvrdnjavanje krecnjaka i betona; proizvodi za odriavanje betona; proizvodi za odriavanje cementa; vezivna sredstva za beton; sredstva za stvrdnjavanje betona i krecnjaka, proizvodi za konzervaciju betona, površinski ucvrscivac betona i/ili maltera; agregati i agregatni ucvrscivači; proizvodi za konzervaciju betona; ispune za pukotine i spojeve; hemijska sredstva za izvlacenje betonskih oblika iz kalupa; preparati za odvajanje proizvoda od kalupa. Masine, masinski alati, elektricni alati; motori, osim za suvozemna

Klasa 7 Masine, masinski alati, elektricni alati; motori, osim za suvozemna vozila; masinske spojnice i transmisioni elementi, osim za suvozemna vozila; poljoprivredne sprave, osim rucnih alata koji se pokrecu rucno; poljoprivredne sprave osim onih kojima se rucno upravlja; inkubatori za jaja; automatske mašine za prodaju; elektricni i akumulatorski mikseri za nanosenje kamenog lepka na keramicke plocice, porcelanske i kamene fumire.

Klasa 11 Aparati za osvetljavanje, grejanje, proizvodnju pare, kuvanje, hladenje, susenje, ventilaciju, snabdevanje vodom i za sanitame svrhe; unapred sastavljeni sistemi za tusiranje i proizvodi za tuseve i tus kabine, naime, nise za tusiranje u vidu tus kabina; tus kadice; delovi za kupatila, naime slivnici za tus kabine; ugradne klupe i sedista za tus kabine; sistem podnog grejanja koji se sastoji od elektricnih spiralnih cevi za grejanje poda, podne podloge, termostata za podno grejanje i indikatora greske elektricne :lice, koji se prodaju zajedno kao jedinica; elektricni sistemi podnog grejanja, naime, kablovi, elektricne podloge i senzori koji se prodaju kao jedinica.

Klasa 17 Neprerađena i poluprerada guma, gutaperka, kaučuk, azbest, liskun i zamene svih ovih

materijala; plastika i smole u ekstrudiranom obliku za upotrebu u proizvodnji; materijali za nepropusno zatvaranje, zaptivanje i izolovanje; savitljive nemetalne cevi i creva; zaptivne membrane uključujući i one koji se koriste za izgradnju; zaptivne membrane i zastitini slojevi koji se koriste u građevinarstvu; hidroizolacione membrane koje se koriste u građevinarstvu; lepljiva zaptivka koja se koristi na betonu, malteru, cigli i kamenu za građevinsku upotrebu; tkanine na bazi poliuretana za upotrebu u zaptivanju i izolaciji zgrada; zvučna izolacija za zgrade; membrane za otpornost na atmosferske uticaje i pame barijere; mase za zaptivanje; epoksidna barijera koja se koristi na betonu i malteru za građevinske svrhe.

Klasa 19 Građevinski materijali (nemetalni); nemetalne krute cevi za gradnju; asfalt, katran i bitumen (smola); nemetalne prenosive konstrukcije; spomenici, nemetalni; tečni cementni rastvor na bazi epoksida; lepljivi i vezivni građevinski materijali naime, maher, tečni cementni rastvor, mastiks i cement, za ugradnju pločica, opeke, kamena i drugih površinskih obloga; gips za građevinske potrebe; cementne place za građevinarstvo; cementne i peskovite mesavine za građevinske potrebe; podne podloge. uključujući podloge koje se same nivelisu; podne podloge, naime, plastične podloge i membrane od tkanine kao podupiraci i podloge za ugradnju pločica preko zidnih, plafonskih i podnih podloga; građevinski materijali, naime, višeslojni materijali iii mešavine hidrauličkog cementa i ispunje iii agregata; građevinski materijali, višeslojni materijali iii mesavine hidrauličkog cementa i ispunje, kao što su drvena secka, neaktivna hemikalija, okresan kamen iii mermer koji se koriste uz smesu od tecnog lateksa za pravljenje i oblikovanje podova, zidova, plafona, izolacionih ploča iii za popravku istih; armirani beton i betonski materijali; materijali za podove; materijali za obnavljanje površine betona; tečni cementni rastvori; masa za popunjavanje spojnica na bazi cementa kod koje se može kontrolisati ekspanzija; ispunje za pukotine i spojeve za beton; matter; malteri za krpljenje betona; sistem za krpljenje na bazi cementa; zatvaraci i premazivaci na bazi cementa za betonske površine; betonske obloge koje se same nivelisu; podne obloge, uključujući podloge koje sadrže habajuće agregate; agregati za beton; smese od cementa i agregata.

(111) **14465**

(151) 22.11.2019.

(210) Ž-2018-176

(442) 20.10.2019.

(220) 18.05.2018.

(732) Swarovski Aktiengesellschaft, Dröschstrasse 15, 9495, Triesen, LI

(540)



(550) I

(740) Miladin Popović, ul. Capital Plaza, ulica šeiKa Zajeda 13-IV/68, 81000, Podgorica, ME

(511) Klasa 14 Plemeniti metali i njihove legure i proizvodi od plemenitih metala iii obloženi tim metalima, koji nijesu obuhvaceni drugim klasama; nakit, drago kamenje; tijare, ukrasi za kosu od plemenitih metala (nakit); casovnicarski i hronometrijski instrumenti; pravi nakit i bizuterija; dragulji; ukrasi (nakit); ogrice; nausnice; narukvice; prstenje (nakit); brosevi; krute narukvice; privjesci (nakit); privjesci za ogrlice; lanci od plemenitih metala; privjesci raznih oblika; dugmad za manzette; medaljoni; privjesci za kljuceve od plemenitih metala, privjesci za kljuceve sa sitnim ukrasima; komadi nakita od stakla, prirodnog iii vjestackog dragog kamenja, plastike, obicnog iii plemenitog metala za licnu upotrebu; kutije za nakit; satovi i casovnici i njihovi dijelovi; satovi sa funkcijom za bezicnu komunikaciju; satovi koji sadrze memorijsku funkciju; kutije prilagodene za drzanje satova i casovnika; prirodno iii sinteticko drago kamenje svih vrsta i za svaku namjenu; dragulji, posebno dragulji od stakla i vjestacki dragulji; kristali od brusenog stakla.

Klasa 35 Usluge maloprodaje iii veleprodaje; usluge maloprodaje iii veleprodaje koje se pruzaju putem Intemeta; usluge komercijalne promocije, informisanja i oglasavanja; usluge komercijalne promocije, informisanja i oglasavanja koje se pruzaju putem Intemeta; organizovanje izlozbi u komercijalne iii reklamne svrhe; promocija prodaje; sirenje reklamnog materijala (letaka, prospekata, stampanog materijala, uzoraka); sakupljanje, za dobrobit drugih, raznovrsne robe, iskljucujuci njen prevoz, omogucujuci potrosacima da prikladno pogledaju i kupe tu robu; sakupljanje, za dobrobit drugih, raznovrsne robe, iskljucujuCi njen prevoz, omogucujuci potrosacima da pregledaju te proizvode na veb stranici i kupe tu robu povoljno; sve gore navedene usluge u vezi sa nakitom, ogrlicama, nausnicama, narukvicama, prstenjem kao nakitom, privjescima kao nakitom, privjescima za ogrlice, privjescima za kljuceve [sitni ukrasi iii lanCici za dzepni satove], satovima, casovnicima, ukrasima za nakit, figurinama, dekoracijama za proslove, dekorativnim predmetima prvenstveno izradenim od stakla, lusterima, djelovima za luster, aparatima za rasvjetu, priborom za pisanje, torbama, vrecicama, novcanicama, futrolama za mobilne telefone, naocarima za sunce, naocarima, futrolama za naocare za sunce i naocare, staklarijom, staklenim posudama, kutijama od stakla, casama za pice, stonim posudem, (izuzev nozeva, viljuski i ka5ika), vazama, svijecnjacima, ogledaiima, okvirima za slike, parfimerijom, kozmetikom, nosivim elektronskim uredajima i nosivim uredajima za mjerenje aktivnosti, odjecom, cipelama, robom od tekstila, namjestajem, USB stikovima, USB prikljucima, USB kompatibilnim uredajima za skladistenje podataka, olovkama za upotrebu kod ekrana koji rade na dodir, zvcnicima i sistemima za ozvucenje (posebno prenosnim zvcnicima), torbama, futrolama i navlakama posebno dizajniranim za slusalice, kompjutere, digitalne asistente i mobilne telefone; reklamne i promotivne usluge vezane uz gore navedenu robu.

(111) **14466**

(151) 22.11.2019.

(210) Ž-2018-179

(442) 20.10.2019.

(220) 18.05.2018.

(732) ETI GIDA SANAYI VE TICARET ANONIM ŞİRKETİ, Organize Sanayi Bolgesi 11., Cadde Eskisehir, TR

(540)



(550) I

(740) Miladin Popović, ul. Capital Plaza, ulica šeika Zajeda 13-IV/68, 81000, Podgorica, ME

(511) Klasa 30 Biskviti; čokolade; peciva; krekeri; vafli; kolači; tartovi; deserti, naime, pekarski deserti, deserti na bazi brašna i čokolade, musevi, ledeni deserti; sladoledi; jestivi led.

(111) **14467**

(151) 22.11.2019.

(210) Ž-2018-283

(442) 20.10.2019.

(220) 01.08.2018.

(732) UNILEVER N.V., Weena 455, 3013 AL, Rotterdam, NL

(540)

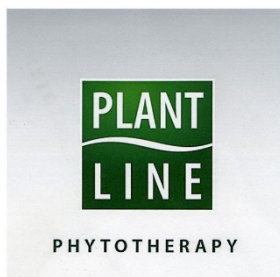

(550) I

(740) Miladin Popović, ul. Capital Plaza, ulica šeika Zajeda 13-IV/68, 81000, Podgorica, ME

(511) Klasa 3 Preparati za bijeljenje i druge supstance za upotrebu za pranje veša; preparati za čišćenje, poliranje, ribanje i odmaščivanje; sapuni; parfimerija, eterična ulja, kozmetika, losioni za kosu; paste za zube.

(111) **14468**

(151) 25.11.2019.

(210) Ž-2018-284

(442) 20.10.2019.

(220) 01.08.2018.

(732) UNILEVER N.V., Weena 455, 3013 AL, Rotterdam, NL

(540)



(550) I

(740) Miladin Popović, ul. Capital Plaza, ulica šeika Zajeda 13-IV/68, 81000, Podgorica, ME

(511) Klasa 3 Preparati za bijeljenje i druge supstance za upotrebu za pranje veša; preparati za čišćenje, poliranje, ribanje i odmaščivanje; sapuni; parfimerija, eterična ulja, kozmetika, losioni za kosu; paste za zube.

(111) **14469**

(151) 26.11.2019.

(210) Ž-2018-94

(442) 20.10.2019.

(220) 26.03.2018.

(732) GOLDEN LEAF (MACAU) TOBACCO'S MANUFACTURING LIMITED, RUA DOS PESCADORES, N°66, BLOCO II, 3°ANDAR-A, MACAU, MO

(540)



(550) I

(740) Dejan Raičević, Vojvode Boža br.1, 81250, Cetinje

(511) Klasa 34 duvan; cigarete; elektronske cigarete; kutije šibica; upaljači za pušače.

(111) **14470**

(151) 27.11.2019.

(210) Ž-2018-392

(442) 20.10.2019.

(220) 23.10.2018.

(732) VELETEX d.o.o., Cijevna b.b., Podgorica, ME

(540)



KALIA

(550) I

(740) VELETEX d.o.o., Cijevna b.b., Podgorica

(511) Klasa 1 Baštovanstvo (hemijski proizvodi za baštovanstvo) osim fungicida, herbicida, insekticida i sredstava protiv parazita; biljke (preparati za regulisanje rasta biljaka); biološki preparati [ne za medicinske ili veterinarske potrebe]; brašno za industrijske potrebe; drveće (kit za ispunjavanje šupljina u drveću) [arborikultura]; gnojenje obradivog zemljišta (hemijski proizvodi za gnojenje obradivog zemljišta); gnojiva za zemlju; hemijski proizvodi za poljoprivredu [osim fungicida, herbicida, insekticida i parazitocida]; hlor; kalemljenje drveća (vosak za kalemljenje drveća); kalemljenje drveća, kit za kalemljenje drveća; poljoprivreda (gnojiva za potrebe poljoprivrede); poljoprivreda (hemijski proizvodi za potrebe poljoprivrede) osim fungicida, herbicida, insekticida i sredstava protiv parazita; vinarstvo (baktericidi za vinarstvo) [hemikalije koje se upotrebljavaju u proizvodnji vina]; vino (proizvodi za bistrenje vina); vinova loza (hemikalije za zaštitu vinove loze od bolesti).

Klasa 5 Biocidi; dezodoransna sredstva osim onih za ličnu upotrebu ili za životinje; dezodoransna sredstva za odjeću i tekstil; enzimi za veterinarske potrebe; enzimski preparati za veterinarske potrebe; fungicidi; gamad (sredstva za uništavanje gamadi); gaza za zavijanje; grinje (sredstva protiv grinja) [akaricidi]; hemijski preparati za veterinarske potrebe; hemijski reagensi za medicinske ili veterinarske potrebe; hrana za odojčad [bebe]; hranjivi dodaci prehrani; insekti (proizvodi za odbijanje insekata); insekti (tamjan za odbijanje insekata), insekticidi; kreme za medicinske potrebe [pomade]; losioni za veterinarsku upotrebu; lijekovi za veterinarske potrebe; masti za veterinarske potrebe; muve (lijepak za muve); muve (proizvodi za uništavanje muva); ogrlice protiv parazita za životinje; otrov za pacove; paraziti (ogrlice protiv parazita) za životinje; paraziti (proizvodi protiv parazita); parazitocidi [sredstva za uništavanje parazita]; pesticidi; sumporne trake za dezinfekciju; tlo (sredstva za sterilizaciju zemljišta); vakcine, veterinarski proizvodi; vinova loza (hemijski proizvodi za liječenje bolesti vinove loze); životinje (proizvodi za pranje životinja).

Klasa 7 Akvarijumi (pumpe za provjetravanje akvarijuma); alat (držači alata) [dijelovi mašina]; alat [djelovi mašina]; boce (mašine za pečačenje boca), boce (mašine za zapušavanje boca); boce (mašine za zatvaranje boca kapicama); boce (uređaji za pranje boca); čišćenje (aparati za čišćenje pod pritiskom); filterski umeci za mašine za filtriranje; filtriranje (mašine za filtriranje); mašine za vađenje korova (mašine za vađenje korova); muzenje (mašine za muzenje); muzenje (sisaljke mašina za muzenje); plugovi; plugovi (rala plugova) [lemeši]; plugovi [kultivatori] za vinogradarstvo; poljoprivredne sprave [ne ručne]; poljoprivredne mašine; prese za grožđe; sijačice [mašine]; travnjaci (kosilice za travnjake) [mašine].

Klasa 31 Agrumi [južno voće]; aloe vera [živa biljka]; biljke; biljke, osušene za ukrašavanje; božićna drvca-novogodišnje jelke; cvijeće, prirodno; cvijeće, prirodno (vijenci od prirodnog cvijeća); cvijeće, sušeno za ukrašavanje; drveće [bilje]; grmlje; grožđe, svježe; hmelj; hrana za životinje; ječam *; kolačići za pse; krastavci, svježi; krompiri; kućni ljubimci (hrana za kućne ljubimce); kućni ljubimci (mirisni pijesak za kućne ljubimce); kućni ljubimci (napici za kućne ljubimce); kućni ljubimci (papir s pijeskom za kućne ljubimce) [stelja]; kukuruz; kukuruzna stočna pogača; limuni, svježi; luk, svježi [povrće]; lukovice cvijeća; lješnik; masline, svježe; naranče; orasi; palme [stabla]; palmino lišće; paprika [biljka]; pasulj u svježem stanju; pogače, uljni kolači [krmivo]; poriluk, svježi; povrće, svježe; pseći kolačići; pšenica; pšenične klice za životinjsku prehranu; ptice (hrana za ptice); raž;

ružini grmovi; salata, zelena [svježa]; sezam; sipina kost za ptice; sjeme;slad za pivare i fabrike alkohola; sočivo, svježe [povrće]; spanać, svježi; stočna hrana (kompleks vegetalnih supstanci za stočnu hrana);stočna hrana (nemedicinski dodaci stočnoj hrani); tikve [bundeve]; travnjaci, prirodni; tresetne podloge; vijenci od prirodnog cvijeća; vinova loza (čokoti vinove laze); voće, svježe; živina (hrana za nošenje jaja); životinje (hrana za životinje).

Klasa 35 Agencije za uvoz-izvoz; fakturisanje; informacije (poslovne informacije); izvodi iz računa (davanje izvoda sa računa); izvoz-uvoz (agencije za izvoz-uvoz); javnost (odnosi s javnošću) [propaganda]; marketing; nabava za treće (usluge nabave za treće) [kupovina proizvoda i usluga za druga preduzeća]odnosi s javnošću [propaganda]; oglašavanje [reklamiranje];podugovaranje (usluge podugovaranja) [komercijalna pomoć]; prodaja (podsticaj prodaje) za treće osobe; proučavanje tržišta [marketing]; računovodstveni poslovi; reklamiranje on-line na info rmatičkoj mreži; reklamiranje putem radija; reklamiranje putem televizije; televizijsko reklamiranje; trgovački poslovi (procjene trgovačkih poslova); tržište (proučavanje tržišta); tržište (traženje tržišta); uvoz-izvoz (agencije za uvoz-izvoz); vođenje knjiga; vođenje poslova (pomoć u vođenju poslova); vođenje poslova (savjetovanje o vođenju poslova); vođenje poslova (usluge savjetovanja u vezi vođenja poslova).

Klasa 44 Bašte (usluge uređivača bašta); bašte (uređenje bašta); baštovani-pejzažisti (usluge baštovana-pejzažista); cvijetni aranžmani (pravljenje cvijetnih aranžmana); drveće (obrezivanje drveća); drveće (sadmna drveća radi smanjenja emisije ugljenika); mgnojivo i ostali hemijski proizvodi namijenjeni za poljoprivredu (vazdušno ili drugačije razbacivanje [posipanje] gnojiva i ostalih hemijskih proizvoda za poljoprivredu); korov (uništavanje korova); obrezivanje drveća; održavanje travnjaka; pejzažna uređenja (konceptija uređenja pejzaža); poljoprivredna oprema (iznajmljivanje opreme za poljoprivredna imanja); povrtlarstvo; rasadničari (usluge rasadničara); razbacivanje, vazdušnog ili drugog gnojiva, i ostalih hemijskih proizvoda u poljoprivredi; štetočine (unistavanje životinjskih štetočina u poljoprivredi); travnjaci (održavanje travnjaka); uništavanje korova; vijenci od cvijeća (izrada vijenaca od cvijeća).

(111) **14472**

(151) 25.11.2019.

(210) Ž-2018-167

(442) 20.10.2019.

(220) 14.05.2018.

(732) Bojan Vujović, Prčanj 168, Kotor, ME

(540)

PLAFORMA

(550) I

(511) Klasa 20 Namještaj.

Klasa 37 Izgradnja, popravke, usluge postavljanja (instaliranja), usluge u području izgradnje ili proizvodnje trajnih građevina, usluge izgradnje zgrada, usluge specijalizovanih u području izgradnje, dodatne građevinske usluge kao što je nadziranje građevinskih projekata, usluge

brodogradnje, popravke, to jest usluge obnavljanja bilo kojeg dotrajalog, oštećenog ili djelimično razrušenog objekta, usluge održavanja kojima je cilj dovođenje objekta u njegovo prvobitno stanje bez promjene bilo kojeg njegovog svojstva.

Klasa 42 Naučne i tehnološke usluge, kao i pripadajuće usluge istraživanja i koncepcije, usluge analiza i istraživanja, usluge inženjera koji se bavi procjenama, ocjenama, istraživanjima i izvještajima u području nauke i tehnologije, usluge koje pružaju baštovani pejzažisti.

(111) **14473**

(151) 25.11.2019.

(210) Ž-2018-292

(442) 20.10.2019.

(220) 08.08.2018.

(732) Salvatore Ferragamo S.p.A., Via dei Tornabuoni, 2, Firenze, IT

(540)



(550) I

(740) Miladin Popović, ul. Capital Plaza, ulica šeika Zajeda 13-IV/68, 81000, Podgorica, ME

(511) Klasa 18 Koža i imitacija kože; životinjske kože i krzna; prtljažne i torbe za nošenje; kišobrani i suncobrani; štapovi za hodanje; bičevi, saračka i sedlarska oprema; ogrlice, povoci i odjeća za životinje.

(111) **14474**

(151) 25.11.2019.

(210) Ž-2018-240

(442) 20.10.2019.

(220) 05.07.2018.

(732) GUANGDONG GALANZ ENTERPRISES Co., Ltd., 25 Rongui Nan Road, Shunde, Foshan, Guangdong, CN

(540)

Galanz

(550) I

(740) Branislav Lutovac, Bulevar Ivana Crnojevića 93, 81000, Podgorica, ME

(511) Klasa 11 mikrotalasne rerne, električni uređaji (aparati) za kuvanje pirinča, elektromagnetne rerne, električne rerne, frižideri, zamrzivači, klima uređaji, aspiratori, sterilizatori posuđa.

(111) **14475**

(151) 25.11.2019.

(210) Ž-2018-293

(442) 20.10.2019.

(220) 09.08.2018.

(732) The Procter & Gamble Company, One Procter & Gamble Plaza, 45202, Cincinnati, Ohio, US

FLEXISTYLE

(540)

(550) I

(740) Branislav Lutovac, Bulevar Ivana Crnojevića 93, 81000, Podgorica, ME

(511) Klasa 5 Ženski higijenski proizvodi kao sto su ulošci, tamponi, dnevni ulošci, gaćice za žensku higijenu, interlabijalni ulošci za žensku higijenu; pelene za inkontinenciju, ulošci i gaćice za inkontinenciju.

(111) **14476**

(151) 25.11.2019.

(210) Ž-2018-282

(442) 20.10.2019.

(220) 27.07.2018.

(732) The Procter & Gamble Company, One Procter & Gamble Plaza, 45202, Cincinnati, Ohio, US

(540)



(550) I

(740) Branislav Lutovac, Bulevar Ivana Crnojevića 93, 81000, Podgorica, ME

(511) Klasa 5 Pelene ili gaćice od papira i/ili celuloze za jednokratnu upotrebu.

(111) **14477**

(151) 25.11.2019.

(210) Ž-2018-156

(442) 20.10.2019.

(220) 03.05.2018.

(732) DC Comics, 2900 West Alameda Avenue, 91505, Burbank, California, US

(540)



(550) I

(740) Miladin Popović, ul. Capital Plaza, ulica šeiika Zajeda 13-IV/68, 81000, Podgorica, ME

(511) Klasa 9: Filmovi u kojima je tematika komedija, drama, akcija, avantura i/ili animacija i

filmovi za emitovanje na televiziji u kojima je tematika komedija, drama, akcija, avantura i/ili animacija; audio video diskovi, i digitalni višenamjenski diskovi (DVD) koji sadrže muziku, komediju, dramu, akciju, avanturu i/ili animaciju; audio video diskovi, i digitalni višenamjenski diskovi (DVD) u kojima je tematika muzika, komedija, drama, akcija, avantura, i/ili animacija; stereo slušalice; baterije; bežični telefoni; CD plejeri ; audio i video plejeri koji se mogu preuzimati za medijski sadržaj sa multimedijalnim i interaktivnim funkcijama, softver za pretraživanje video zapisa i anotacija, softver za zaštitu sadržaja, softver za upravljanje bazom podataka, softver za sinhronizaciju baze podataka; računarski programi za pristupanje, pregledanje i pretraživanje onlajn baza podataka, softver koji omogućava korisnicima reprodukciju i programiranje audio, video, tekstualnog i multimedijalnog sadržaja koji se odnosi na zabavu; kompjuterski aplikacioni softver za strimovanje i čuvanje audiovizuelnog medijskog sadržaja; softver za računarsku igru za upotrebu na mobilnim i celularnim telefonima; programi za video i računarske igre; kertridži za video igrice; softver za računarske i video igre; računarski softver za igranje igrice na mašinama uključujući i slot mašine; računarski softver ili firmver za igre na sreću na bilo kojoj kompjuterizovanoj platformi, uključujući namjenske konzole za igranje, video slot mašine, automatske slot mašine i video terminale za lutriju; CD-ROM-ovi i digitalni višenamjenski diskovi za računarske igrice i računarski programi, naime, softver koji povezuje digitalizovane video i audio medije na globalnu računarsku mrežu informacija; softver za strimovanje audiovizuelnih i multimedijalnih sadržaja preko interneta i globalnih komunikacionih mreža; softver za strimovanje audiovizuelnog i multimedijalnog sadržaja na mobilne digitalne elektronske uređaje; računarski softver za isporuku bežičnih sadržaja; računarski softver za kupovinu, pristupanje, i gledanje stripova, gratickih romana, filmova, TV emisija, video zapisa i multimedijalnog sadržaja; mobilne aplikacije za pristupanje i strimovanje audiovizuelnog i multimedijalnog sadržaja putem interneta i globalnih komunikacionih mreža; softver za video igre; softver za računarske igre; kompjuterske igre koje se mogu preuzimati; programi za interaktivne video igre; kertridži i diskovi za računarske igre; softver za preuzimanje računarske igre za upotrebu na mobilnim telefonima, tabletima i personalnim računarima; programi za elektronske igre; softver za elektronske igre za mobilne telefone, tablete, personalne računare i ručne elektronske uređaje; softver i hardver za igre virtualne realnosti; filmske i televizijske emisije koje se mogu preuzimati i koje sadrže fiktivne i nefiktivne priče o raznim temama koje se pružaju putem usluge video-na-zahtev; magnetski kodirane magnetne kartice, naime, telefonske kartice, kreditne kartice, gotovinske kartice, debitne kartice, poklon kartice i magnetske ključ kartice; podloge za misa; prazni USB fleš drajveri; dodatna oprema za mobilne telefone, laptopove, tablete, digitalne kamere, digitalne muzičke plejere, pametne satove, lične digitalne asistente i elektronske citace knjiga, naime, zaštitni rukavi, poklopci, kucista, maske za prednji deo uređaja, kože, trake i zaštitni pokrivaci ekrana; slusalice; bubice za uši; voldtoki; telefoni; mobilni telefoni; slusalice za mobilne telefone; adapter za mobilne telefone; naočare; pribor za naočare, naime, trake, korde za vrat, i trake za glavu koje sprečavaju naočare da spadnu sa onog koji ih nosi; naočare; naočare za sunce; kutije za naočare i za naočare za sunce; dvogledi; dekorativni magneti; gradirani lenjiri; stakla za uvećavanje; mikrofoni; sportske kacige; biciklističke kacige; tlocioni prsluci; publikacije koje se mogu preuzimati u vidu knjiga koje sadrže likove iz animiranih filmova, akcionih avantura, komedija i/ili drama, stripova, gratickih romana, knjiga za decu, strateskih vodica, casopisa koji sadrže likove iz animiranih filmova,

akcionih avantura, komedija i/ili dramskih filmova, bojanki, dječijih interaktivnih knjiga i časopisa iz oblasti zabave.

Klasa 16: Štampane stvari i proizvodi od papira, naime knjige koje sadrže likove iz animiranih filmova, akcionih avantura, komedija i dramskih filmova, stripovi, gratički romani, knjige za djecu, strateski vodici, časopisi koji sadrže likove iz animiranih filmova, akcionih avantura, komedija i dramskih filmova, bojanke, dječije vdbanke; kancelarijski materijal, papir za pisanje, koverte, sveske, dnevnici, beleznice, čestitke, kolekcionarske karte; litografije; hemijske olovke, olovke, pernice za njih, gumice, krejoni, flomasteri, olovke za bojenje, pribor za slikanje, krede i table; naljepnice i knjige sa nalepnicama; naljepnice koje se lijepe uz pomoć toplote; poster; samoljepljive plasticne folije sa odlepljivim papirom za montiranje slika u dekorativne svrhe; montirane i nemontirane fotografije; pokrivala za knjige, markeri za knjige, kalendari, ukrasni papir za pakovanje; dekoracije od papira za zabave, naime, papirne salvete, papirni podmetaci, krep papir, pozivnice, papirni stolnjaci, papirni ukrasi za stol; štampane aplikacije za vez i tkanine; štampane aplikacije za kostime, pidzame, dukserice i majice

Klasa 18: Atletske torbe, rančevi za bebe, rančevi, torbe za plažu, torbe za knjige, torbe za pelene, velike torbe, torbe sa kaisem preko grudi, aktovke, torbe za teretanu, velike ručne tašne, male torbice za novac, torbice za nošenje oko struka, ruksaci, sportske torbe za nošenje oko struka, torbe za kupovinu, torbe za kupovinu za višekratnu upotrebu; kišobrani; novčanici; modni aksesoari od kože, naime, novčanici, ručne torbice i kaiševi.

Klasa 21: Proizvodi od stakla, keramike i grncarije, naime, činije, tanjiri, šoljice za kafu i šoljice; staklarija za napitke, naime, šolje, krcazi i čaše za piće; setovi sa posudom za šećer i posudom za pavlaku za kafu; šolje za bebe; posude za kolače; figurice od keramike, stakla i porcelana; četkice za zube; ne-elektricne posude za kuvanje kafe koje nisu od plemenitih metala; kutije za ručak; gamele za prenos hrane; korpe za otpadni papir; posude za led; plasticne kofice; police za tuš kabine; modle za kolače; pribor za posluživanje, naime, lopatice za pite, postolja za torte, spatule, strugači za upotrebu u domaćinstvu, i lopatice za kolace; cuture; plasticni podmetaci; termoizolacione kutije za hranu ili piće; noževi za kolace; vadičepi; prazne flaše za vodu; dekanteri; boce i cuture za piće; rukavice za bastovanstvo; gumene rukavice za domaćinstvo; i posude za ručavanje, naime, papirni tanjiri i papirne šoljice; podmetači, ne od papira ili tkanine; krpe za posude.

Klasa 25: Odjeća za muškarce, žene i djecu, naime, košulje, majice, dukserice, trenerke za trčanje, pantalone, gace, šorcevi, majice bez rukava, odjeća za kišu, dječije portikle od tkanine, suknje, bluze, haljine, odjelca za bebe, tregeri, džemperi, jakne, kaputi, kišni mantili, odijela za snijeg, kravate, kucne haljine, šeširi, kape, stitnici za sunce, rukavice, kaiševi, marama, odjeca za spavanje, pidzame, žensko rublje, donji veš, čizme, cipele, patike, sandale, čarape, kratke čizmice, carape-papuce, odjeca za kupanje i kostimi i maske za maskenbal i Noc vještica koji se prodaju u vezi sa istim.

Klasa 35: Usluge onlajn maloprodaje sa zabavnim i edukativnim sadržajem, naime, pretplate na filmove i televizijske emisije; usluge maloprodaje, usluge onlajn maloprodaje, potrošačkih proizvoda i artikala za poklone, suvenira, kolekcionarskih artikala, računarskih igrica, računarske opreme, DVD-jeva, knjiga, stripova, grafickih romana, unapred snimljenih audio knjiga, elektronskih knjiga, naočara za sunce, magneta, nakita privezaka za ključeve, ručnih satova, sitnih

ukrasa, štampanih stvari, publikacija, kartica, postera, umjetnickog pribora, kancelarijskog materijala, naljepnica, kancelarijskog i skolskog pribora, torbi, novčanika, ranceva, odece za kucne ljubimce, pribora i posuda sa kuhinj u i upotrebu u domaćinstvu, posteljina za domaćinstvo, stonog posuda za domaćinstvo, proizvoda za kuću, odece, modnih aksesoara, šesira, obuće, kostima, aksesoara za kostime, ukrasa za jelku, igri, sportske robe, igracaka, figurica, hrana, slatkisa i pica; pružanje informacija, vesti i komentara u vezi sa biznisom zabave; usluge reklamiranja i promocije; usluge digitalnog oglašavanja; prikupljanje informacija u računarske baze podataka; usluge marketinga, oglašavanja i promocije; istraživanje tržišta i pružanje informacija u vezi sa tržištem; usluge oglašavanja, naime, promocija robe i usluga trećih lica putem računarskih i komunikacionih mreža; upravljanje onlajn trgovinom trećih lica; usluge onlajn maloprodaje u odnosu na digitalne medije, naime, usluge onlajn maloprodaje unapred snimljenih digitalnih zvučnih i video zapisa i snimaka podataka koji sadrže muziku, tekst, video zapise, igrice, komediju, dramu, akciju, avanturu ili animaciju; promocija robe i usluga trećih lica putem interneta; upravljanje onlajn računarskim bazama podataka trećih lica i omogućavanje trećim licima pristup onlajn bazama podataka, koje se mogu pretraživati, u oblasti zabave; onlajn reklamne i marketinske usluge; pružanje i iznajmljivanje reklamnog prostora na internetu; pružanje usluga onlajn aukcija; usluge uporectivanja kupovine, naime pružanje komercijalnih informacija i savjeta za potrošače i pružanje usluga poređenja cena; marketinške usluge.

Klasa 38: Telekomunikacije; telekomunikacione usluge; omogućavanje interakcije u realnom vremenu sa drugim korisnicima računara u vezi sa temama od opšteg interesa; omogućavanje pristupa onlajn sobama za "četovanje" (razgovor), elektronskim biltenima i forumima za prenos poruka među korisnicima; striming audiovizuelnog i multimedijalnog sadržaja putem interneta; prenos i isporuka audiovizuelnog i multimedijalnog sadržaja putem interneta; usluge prenosa video zapisa na zahtev; prenos audio i video zapisa na zahtev; striming audio i vizuelnog sadržaja; emitovanje audio i vizuelnog sadržaja; prenos i isporuka audio i vizuelnog sadržaja; usluge emitovanja putem interneta; usluge emitovanja video zapisa putem interneta; usluge emitovanja audio zapisa putem interneta; usluge emitovanja video zapisa putem interneta ili drugih komunikacionih mreža, naime, elektronski prenos video klipova; usluge emitovanja i obezbeđivanje telekomunikacionog pristupa video i audio sadržaju kojem se pristupa putem interneta preko "video na zahtjev" usluge; omogućavanje visekorisnickog pristupa globalnoj računarskoj informacionoj mreži; obezbeđivanje soba za "četovanje" (razgovor); usluge portala; usluge elektronske paste; pružanje korisnicima pristup internetu; pružanje onlajn mrežnog servisa koji korisnicima omogućava kreiranje ličnih profila sa informacijama o društvenim mrežama; omogućavanje pristupa onlajn računarskim bazama podataka i onlajn bazama podataka, koje se mogu pretraživati, iz oblasti zabave; omogućavanje pristupa računarskoj mreži ili vebajtu sa interaktivnim diskusionim grupama uključujući diskusionim grupama koje su , stripovima, grafickim romanima, dječijim knjigama, piscima i čitanju.

Klasa 41: Izdavačke usluge; usluge elektronskog izdavaštva, naime, objavljivanje tekstova i grafickih radova trećih lica onlajn koji sadrže članke, novelizacije, scenarije, stripove, strateske vodice, fotografije i vizuelne materijale; publikacije koje se ne mogu preuzimati u vidu knjiga sa likovima iz animiranih dijela, akcijsko avanturistickih dela, komedija i/ili drama, stripova, decijih knjiga, strateskih vodica, časopisa sa likovima iz animiranih dela, akcijsko avanturistickih dijela,

komedija i/ili drama, bojanki, vježbanki za djecu i časopisa iz oblasti zabave; usluge elektronskih igrica koje se pružaju putem globalne računarske mreže; pružanje onlajn računarskih, elektronskih i video igrica; omogućavanje privremenog koriscenja interaktivnih igrica koje se ne mogu preuzimati; pružanje usluga kazina i obezbjeđenje uslova za igranje igrica; usluge razonode, naime, omogucavanje pristupa kazino igricama; omogucavanje pristupa elektronskim kazino igricama; usluge razonode u vidu multipleks bioskopa i pozorista, filmskih izložbi, distribucije filmova; usluge razonode, naime, omogućavanje pristupa filmovima i televizijskim emisijama koje se ne mogu preuzimati preko „video na zahtjev" usluge; omogućavanje pristupa filmovima i televizijskim emisijama koje se ne mogu preuzimati preko „video na zahtjev" usluge; omogućavanje pristupa veb stranici koja sadrži televizijske emisije, filmove i multimedijalni zabavni sadržaj koji sene maze preuzimati, kao i informacije, recenzije i preporuke u vezi sa televizijskim emisijama, filmovima i multimedijalnim zabavnim sadržajem; usluge razonode u vidu razvoja, kreiranja, proizvodnje, distribucije i postprodukcije filmova, televizijskih emisija, posebnih dogactaja i multimedijalnih zabavnih sadržaja; usluge razonode u vidu pozorišnih, muzičkih i komicnih nastupa uživo; usluge zabavnog parka; prezentacija emisija i/ili filmova uživo ili unapred snimljenih emisija i/ili filmova; informacije o razonodi i/ili rekreaciji; usluge zabavnog kluba; usluge fan kluba.

(111) **14478**

(151) 25.11.2019.

(210) Ž-2018-298

(442) 20.10.2019.

(220) 10.08.2018.

(732) Saucony, Inc., 500 Totten Pond Road, 02451, Waltham, Massachusetts, US

(540) SAUCONY

(550) I

(740) AOD "Ćupić", Bulevar Džordža Vašingtona 79, 81000, Podgorica, ME

(511) Klasa 25 Odjeća, obuća, pokrivala za glavu.

(111) **14479**

(151) 12.12.2019.

(210) Ž-2018-196

(442) 20.10.2019.

(220) 05.06.2018.

(732) IGLA SHPK, Komuna Vaqarr, Godina 2 kat?she, Pran? shkoll?s " V?ll?z?rit Kajtazi", Tirane, AL

(540)

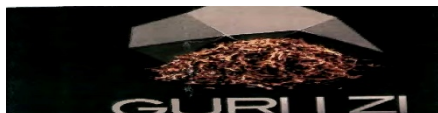

(550) I

(740) AOD "Ćupić", Bulevar Džordža Vašingtona 79, 81000, Podgorica, ME

(511) Klasa 16 Pakovanja i kutije od papira ili kartona; štampani materijal; plastične folije za zamotavanje; etikete ne od tekstila; sva navedena roba je povezana sa cigaretama, filterima za

cigarete, papirom za cigarete i cijevima za izradu cigareta

Klasa 34 Duvan; artikli za pušače; šibice; cigarete: cigare: cigarilosi: upa1jači za pušače; duvan-sirovi, obrađeni ili zgnječeni; proizvodi za duvan; filteri za cigarete: papir za cigarete; pepe1jare za pušače, duvan za zamotaj-sam-svoje cigarete, duvan za lute, duvan za žvakanje, duvan za usmrkavanje: kalup (omot) za cigarete. tabakere, futrole za cigarete, lule, džepni aparat za uvijanje cigareta.

(111) **14480**

(151) 04.12.2019.

(210) Ž-2018-314

(442) 20.10.2019.

(220) 20.08.2018.

(732) ENFORMA doo, Jadranski put bb, Kotor, ME

(540)

E\NFORMA

(550) I

(740) ENFORMA doo, Jadranski put bb, Kotor

(511) Klasa 35 Oglašavanje i reklamiranje; vođenje komercijalnih poslova; komercijalna administracija; kancelarijski poslovi; pomoć u radu i upravljanju privrednim društvima, ili pomoć u vođenju poslova ili komercijalnih funkcija industrijskog ili trgovačkog preduzeća, kao i usluge reklamnih ustanova koje se bave uglavnom reklamiranjem proizvoda i usluga putem svih vrsta medija, usluge koje se odnose na registraciju, prijepis, sastavljanje, kompilaciju ili sistematizaciju pisanih saopštenja i zapisa kao i obradu ili kompilaciju matematičkih ili statističkih podataka, usluge agencija za oglašavanje kao i usluge distribuiranja prospekata direktno ili poštom ili distribuiranje uzoraka, oglašavanja u vezi s drugim uslugama kao sto su usluge u vezi bankarskih zajmova i oglašavanja putem radija; sortiranje za račun drugih osoba, raznih proizvoda (ne uključuje njihov prevoz) radi omogućavanja potrošaču njihovog lakšeg razgledanja i kupovine; ove usluge se mogu pružati u okviru prodavnica na malo, trgovina na veliko, posredstvom prodajnih kataloga, dopisno ili elektronskim putem, na primjer posredstvom weba ili putem telefona.

Klasa 37 Izgradnja; popravke; usluge postavljanja (instaliranja), usluge preduzetnika i podizvođača u području izgradnje ili proizvodnje trajnih građevina, kao i usluge lica ili organizacija koje se bave obnavljanjem i zaštitom objekata ne mijenjajući pritom njihova fizicka ili hemijska svojstva, usluge izgradnje zgrada, puteva, mostova, brana, dalekovoda kao i usluge specijalizovanih preduzeća u području izgradnje, kao sto su moleri, limari, postavljači centralnog grijanja i pokrivači krovova; dodatne građevinske usluge kao sto je nadziranje građevinskih projekata; usluge brodogradnje; usluge iznajmljivanja alata ili građevinskog materijala; popravke, to jest usluge obnavljanja bilo kojeg dotrajalog, oštećenog ili djelimično razrušenog objekta (prenamjena ili obnavljanje zgrada ili nekog drugog objekta čije prvobitno stanje ne zadovoljava); - razne vrste popravaka u području elektrike, pokretnina, mašina, alata itd .; usluge održavanja kojima je cilj dovođenje objekta u njegovo prvobitno stanje bez promjene bilo kojeg njegovog svojstva.

Klasa 42 Naučne i tehnološke usluge kao i pripadajuće usluge istraživanja i koncepcije; usluge industrijskih analiza i istraživanja; koncepcija i razvoj računara i računarskih programa /hardvera i softvera/, usluge koje pružaju lica, individualno ili kolektivno, u vezi s teorijskim ili praktičnim vidovima složenih područja djelatnosti; takve usluge pružaju predstavnici profesija kao sto su hemičari, fizičari, inženjeri, informatičari, itd., usluge inženjera koji se bave procjenama, ocjenama, istraživanjima i izvještajima u području nauke i tehnologije; usluge naučnih istraživanja u medicinske svrhe.

(111) **14481**

(151) 09.12.2019.

(210) Ž-2018-195

(442) 20.10.2019.

(220) 05.06.2018.

(732) NBA Properties, Inc., Olympic Tower, 645 Fifth Avenue, 10022, New York, New York, US

(540)



(550) I

(740) Miladin Popović, ul. Capital Plaza, ulica šeika Zajeda 13-IV/68, 81000, Podgorica, ME

(511) Klasa 25 Odjeća, obuća, pokrivala za glavu; odjeća, naime čarape, obuća, cipele za košarku, patike za košarku, majice, košulje, polo majice, dukserice, donji djelovi trenerki, pantalone, majice na bretele, dzemperi, kratke pantalone, pidzame, sportske majice, ragbi majice, duksevi, kaiševi, kravate, spavaćice, seširi, kape, štitnici na kaketima, trenerke za zagrijavanje, donji djelovi trenerki za zagrijavanje, dresovi za zagrijavanje/majice za vježbanje ubacaja, jakne, vjetrovke, jakne sa kapuljačom, kaputi, portikle za bebe ne od papira, trake za glavu, znojnice, kecelje, donje rublje, bokserice, široke pantalone, stitnici za uši, rukavice, rukavice samo sa palcem, salovi, pletene i strikane majice, trikotazne haljine, haljine, dresovi i uniforme za navijacice, odjeca za plivanje, odijela za kupanje, kupaci kostimi, bikiniji, tankiniji, gacice za plivanje, gacice za kupanje, šorcevi za surfovanje, nepromociva odjeca za vodu, marama za plažu, pokrivala za kupace kostime, ogrtači za kupace kostime, sandale, sandale za plazu, seširi za plazu, stitnici za sunce, kape za plivanje, kape za kupanje, nova pokrivala za glavu sa prikačenim umecima

Klasa 28 Igre i igračke; gimnasticki i sportski predmeti koji nisu obuhvaćeni drugim klasama: ukrasi za božićne jelke: igracke, igre i sportske stvari, naime košarkaske lopte, loptice za golf, lopte za igralište, sportske lopte, gumene lopte i pjenaste lopte, plisane lopte za igru, plastične lopte za igru, mrežice za košarku, table za košarku, minijaturne table za košarku, pumpe i igle za naduvavanje košarkaških lopti; stapovi za golf, torbe za golf, podmetači za golf, oprema za golf, naime, alat za popravku golf terena, kupice na koje se stavlja lopta, marker lopti, torbe za golf opremu, pokrivala za glave golf štapova, rukavice za golf, kutije za golf lopte, posebna zelena staza

za golf: držači za bilijske stapove, kugle za bilijar, trouglovi za bilijar, pikado ormari, elektronske table za košarkaške igrice na tabli, table za košarkaške igrice, košarkaške igrice, akcione igrice, društvene igre za odrasle i djecu, trivia informacione igrice i elektronski video arkadni uređaji, košarkaški setovi koji se sastoje od mrdice i zviždaljke, lutke, dekorativne lutke, lutke za kolekciju, akcione figure za igru, akcione figure karikature, punjene igračke, plisane igračke, puzzle, montažni blokovi za igre, ukrasi za Božićnu jelku i Božićne čarape; vozila za igru u obliku automobila, kamiona, vozova i kombija, svi sa temom košarke, nove pjenaste igračke u obliku prstiju i trofeja, igračke trofeji, karte za igru, igrice sa kartama, igračke koje prave zvuk, igračke za kućne ljubimce: igracke za plažu, naime, lopte za plažu, lopte na naduvavanje. kantice za igru lopatice za igru. igračke za pijesak, bazen sa pijeskom, gumene igracke za vodu; oprema za bazen, naime plivačka oprema za plutanje, oprema za plutanje u bazenu, igračke za splavarenje na vodi, pjenasta oprema za plutanje, gume za plivanje, gume za plivanje u bazenu, pjenaste gume, daske za plivanje, daske za surfovanje, peraja za plivanje, peraja za surfovanje, mišići za plutanje i mišići za pomoć pri plivanju, sve u rekreativne svrhe; odbojkaški setovi za igru koji se sastoje od lopte, mrežice traka koje označavaju teren i zviždaljke i vaterpolo setovi za igru koji se sastoje od lopte, mrežice i zviždaljke; dekorativne igračke od tkanine koje se puštaju da lete na vjetru; minijature reprodukcije stadiona, naime, male plastične modele stadiona; staklene kugle sa snijegom; džojstici za video igre; dzojstici za kompj uterske igre; mašine za video igre za upotrebu sa televizorom i ručni kontroleri za konzole za video igre: pokretna traka za vjdbanje; dječje kašice.

Klasa 41 Obuka; stručno osposobljavanje; razonoda; sportske i kultume djelatnosti.; razonoda i obrazovne usluge u smislu televizijskih događaja i radio programa iz oblasti košarke i prikazivanja uživo košarkaških igara i košarkaških priredbi; usluge produkcije i distribucije radio i televizijskih sou programa sa košarkaskim utakmicama, košarkaskim događajima i programima iz oblasti košarke; usluge vođenja i organizovanja košarkaških klinika i kampova, klinika i kampova za trenere, klinika i kampova za plesne timove i kosarkaške igre; usluge razonode u vidu ličnog pojavljivanja kostimiziranih maskota ili plesnih timova na košarkaškim utakmicama i priredbama, klinikama, kampovima, promocijama, i drugim događajima, specijalnim događajima i žurkama u vezi sa košarkom; usluge kluba obožavalaca; usluge razonode, uključujući one koje pružaju vebsajt predstavljanje multimedijjskih sadržaja koji se ne može preuzimati u vidu najvaznijih televizijskih događaja, interaktivnih najvažnijih televizijskih događaja, video snimaka, video strim snimaka, interaktivnih video izbora najvaznijih događaja, radio programa, najvaznijih radijskih događaja, i audio snimaka u polju košarke; usluge obezbjeđivanja vijesti i infonnacija u vidu statistika i drugih stvari iz oblasti košarke; onlajn igrice koje se ne mogu preuzimati, naime, kompjuterske igrice, video igrice, interaktivne video igrice, akcione igrice, arkadne igrice, društvene igre za odrasle i djecu, igre na tabli, slagalice, i trivia igrice; usluge elektronskog izdavaštva, naime, izdavanje magazina, vodica, biltena, bojanki, i igrica kod kojih se igrači određuju putem intemeta, sve u vezi sa košarkom

(111) 14482

(151) 04.12.2019.

(210) Ž-2018-243

(442) 20.10.2019.

(220) 12.07.2018.

(732) Biocon Limited, 20th Km., Hosur Road, Electronic City P.O., 560100, Bangalore, IN

(540)  InsuWiz

(550) I

(740) Miladin Popović, ul. Capital Plaza, ulica šeika Zajeda 13-IV/68, 81000, Podgorica, ME

(511) Klasa 5 Farmaceutski i medicinski preparati

Klasa 10 Medicinski i terapeutski aparati i instrumenti

(111) **14483**

(151) 09.12.2019.

(210) Ž-2018-250

(442) 20.10.2019.

(220) 19.07.2018.

(732) Philip Morris Brands Sàrl, Quai Jeanrenaud 3, 2000, Neuchâtel, CH

(540)



(550) I

(740) Milena Pejović, Bulevar Džordža Vašingtona, The Capital Plaza 102, Apartman II/39, 81000, Podgorica, ME

(511) Klasa 34 duvan, sirov ili prerađen; duvanski proizvodi; cigare, cigarete, cigarilosi, duvan za zavijanje cigareta, duvan za lule, duvan za žvakanje, duvan za šmrkanje, kretek; snus (duvan u prahu); zamjena za duvan (za nemedicinsku upotrebu); elektronske cigarete; duvanski proizvodi za zagrijavanje; elektronski uređaji i njihovi djelovi koji se koriste za zagrijavanje cigareta ili duvana u cilju oslobađanja aerosola koji sadrži nikotin za inhalaciju; tečni nikotinski rastvori za upotrebu u elektronskim cigaretama; artikli za pušače, papir za cigarete, tube za cigarete, filteri za cigarete, kutije za duvan, kutije za cigarete, pepeljare, lule, ručni aparati i spravice za uvijanje cigareta, upaljači, šibice.

(111) **14485**

(151) 03.12.2019.

(210) Ž-2018-206

(442) 20.10.2019.

(220) 14.06.2018.

(732) SAVENCIA SA, 42 rue Rieussec, 78220, Viroflay, FR

(540)



(550) I

(740) Branislav Lutovac, Bulevar Ivana Crnojevića 93, 81000, Podgorica, ME

(511) Klasa 29 Milijeko, sir i mliječni proizvodi; jestiva ulja i masti.

(111) **14486**

(151) 09.12.2019.

(210) Ž-2018-251

(442) 20.10.2019.

(220) 19.07.2018.

(732) Philip Morris Brands Sàrl, Quai Jeanrenaud 3, 2000, Neuchâtel, CH

(540)



(550) I

(740) Milena Pejović, Bulevar Džordža Vašingtona, The Capital Plaza 102, Apartman II/39, 81000, Podgorica, ME

(511) Klasa 34 duvan, sirov ili prerađen; duvanski proizvodi; cigare, cigarete, cigarilosi, duvan za zavijanje cigareta, duvan za lule, duvan za žvakanje, duvan za šmrkanje, kretek; snus (duvan u prahu); zamjena za duvan (za nemedicinsku upotrebu); elektronske cigarete; duvanski proizvodi za zagrijavanje; elektronski uređaji i njihovi djelovi koji se koriste za zagrijavanje cigareta ili duvana u cilju oslobađanja aerosola koji sadrži nikotin za inhalaciju; tečni nikotinski rastvori za upotrebu u elektronskim cigaretama; artikli za pušače, papir za cigarete, tube za cigarete, filteri za cigarete, kutije za duvan, kutije za cigarete, pepeljare, lule, ručni aparati i spravice za uvijanje cigareta, upaljači, šibice.

(111) **14487**

(151) 09.12.2019.

(210) Ž-2018-253

(442) 20.10.2019.

(220) 19.07.2018.

(732) Philip Morris Brands Sàrl, Quai Jeanrenaud 3, 2000, Neuchâtel, CH

(540)

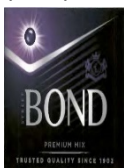

(550) I

(740) Milena Pejović, Bulevar Džordža Vašingtona, The Capital Plaza 102, Apartman II/39, 81000, Podgorica, ME

(511) Klasa 34 duvan, sirov ili prerađen; duvanski proizvodi; cigare, cigarete, cigarilosi, duvan za zavijanje cigareta, duvan za lule, duvan za žvakanje, duvan za šmrkanje, kretek; snus (duvan u prahu); zamjena za duvan (za nemedicinsku upotrebu); elektronske cigarete; duvanski proizvodi za zagrijavanje; elektronski uređaji i njihovi djelovi koji se koriste za zagrijavanje cigareta ili duvana u cilju oslobađanja aerosola koji sadrži nikotin za inhalaciju; tečni nikotinski rastvori za upotrebu u elektronskim cigaretama; artikli za pušače, papir za cigarete, tube za cigarete, filteri za cigarete, kutije za duvan, kutije za cigarete, pepeljare, lule, ručni aparati i spravice za uvijanje cigareta, upaljači, šibice.

(111) **14488**

(151) 09.12.2019.

(210) Ž-2018-254

(442) 20.10.2019.

(220) 19.07.2018.

(732) Philip Morris Brands Sàrl, Quai Jeanrenaud 3, 2000, Neuchâtel, CH

(540)

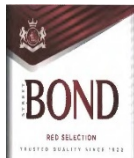

(550) I

(740) Milena Pejović, Bulevar Džordža Vašingtona, The Capital Plaza 102, Apartman II/39, 81000, Podgorica, ME

(511) Klasa 34 duvan, sirov ili prerađen; duvanski proizvodi; cigare, cigarete, cigarilosi, duvan za zavijanje cigareta, duvan za lule, duvan za žvakanje, duvan za šmrkanje, kretek; snus (duvan u prahu); zamjena za duvan (za nemedicinsku upotrebu); elektronske cigarete; duvanski proizvodi za zagrijavanje; elektronski uređaji i njihovi djelovi koji se koriste za zagrijavanje cigareta ili duvana u cilju oslobađanja aerosola koji sadrži nikotin za inhalaciju; tečni nikotinski rastvori za upotrebu u elektronskim cigaretama; artikli za pušače, papir za cigarete, tube za cigarete, filteri za cigarete, kutije za duvan, kutije za cigarete, pepeljare, lule, ručni aparati i spravice za uvijanje cigareta, upaljači, šibice.

(111) **14489**

(151) 12.12.2019.

(210) Ž-2018-197

(442) 20.10.2019.

(220) 05.06.2018.

(732) IGLA SHPK, Komuna Vaqarr, Godina 2 kat?she, Pran? shkoll?s " V?II?z?rit Kajtazi", Tirane, AL

(540)



(550) I

(740) AOD "Ćupić", Bulevar Džordža Vašingtona 79, 81000, Podgorica, ME

(511) Klasa 16 Pakovanja i kutije od papira ili kartona: štampani materijal: plastične folije za zamotavanje: etikete ne od tekstila: sva navedena roba je povezana sa cigaretama, filterima za cigarete, papirom za cigarete i cijevima za izradu cigareta;

Klasa 34 Duvan; artikli za pušače; šibice; cigarete: cigare: cigarilosi: upa1jači za pušače; duvan-sirovi, obrađeni ili zgnječeni; proizvodi za duvan; filteri za cigarete: papir za cigarete; pepe1jare za pušače, duvan za zamotaj-sam-svoje cigarete, duvan za lute, duvan za žvakanje, duvan za usmrkavanje: kalup (omot) za cigarete. tabakere, futrole za cigarete, lule, džepni aparat za uvijanje cigareta.

(111) **14490**

(151) 12.12.2019.

(210) Ž-2018-309

(442) 20.10.2019.

(220) 15.08.2018.

(732) Pharmaceutical chemical cosmetic industry ALKALOID AD Skopje, Bulevar Aleksandar Makedonski 12, 1000, Skopje, MK

(540)



(550) I

(740) Miladin Popović, ul. Capital Plaza, ulica šeika Zajeda 13-IV/68, 81000, Podgorica, ME

(511) Klasa 3 Vlažne maramice za bebe za osjetljivu kožu.

(111) **14491**

(151) 12.12.2019.

(210) Ž-2018-74

(442) 20.10.2019.

(220) 13.03.2018.

(732) Deciem Beauty Group Inc., 517 Richmond St. E, M5A 1R4, Toronto, Ontario, CN

(540) DECIEM

(550) I

(740) Deciem Beauty Group Inc., 517 Richmond St. E, M5A 1R4, Toronto

(511) Klasa 3 Kozmetički preparati za njegu kože; proizvodi za njegu kože i tijela, naime, preparati za hidrataciju lica, preparati za hidrataciju tijela, proizvodi za zaštitu od starenja lica; proizvodi za zaštitu od starenja tijela, naime, kreme za tijelo protiv starenja, losioni, gelovi, ulja, sredstva za čišćenje, sapun za tijelo, pilinzi, preparati za hidrataciju, regeneratori za kožu, sredstva za omekšavanje kože (emolijensi) i preparati za njegu kože koji uklanjaju bore; topikalni (lokalni) tretmani za vrat, naime, losioni, kreme, gelovi, ulja, sredstva za čišćenje, pilinzi, preparati za hidrataciju, regeneratori za kožu, sredstva za omekšavanje kože (emolijensi) i preparati za njegu kože koji uklanjaju bore na vratu; ne-medicinski tretmani za strije, naime, losioni, kreme, gelovi, ulja, sredstva za čišćenje, pilinzi, preparati za hidrataciju, regeneratori za kožu, sredstva za omekšavanje kože (emolijensi) i preparati za njegu kože za tretiranje strija; ne-medicinski tretmani za celulit, naime, losioni, kreme, gelovi, ulja, sredstva za čišćenje, preparati za hidrataciju, regeneratori za kožu za smanjenje celulita; tretmani za izbjeljivanje i i iii tretmani za posvjetljivanje kože, naime, losioni, kreme, gelovi, ulja, sredstva za čišćenje, preparati za hidrataciju, regeneratori za izbjeljivanje kože i posvjetljivanje kože; proizvodi za njegu kose, naime, sprejevi za kosu, losioni za kosu, regeneratori za kosu i gel za kosu; kozmetika; preparati za čišćenje, preparati za izbjeljivanje i ostale supstance za pranje veša, odnosno izbjeljivač za pranje veša, deterdženti za pranje veša i vosak za veš; preparati za čišćenje, poliranje, ribanje i abrazivni preparati; sapuni, naime, sapuni protiv znojenja, sapuni za tijelo, sapun za kupanje i sapun za ruke; eterična ulja, losioni za kosu; paste za zube, kreme za lice i tijelo, preparati za pranje tijela, šamponi, preparati za hidrataciju tijela, kolonjska veda; toaletna veda; parfemi; dezodoransi za ličnu upotrebu.

Klasa 35 Usluge maloprodaje u oblasti kozmetike, proizvoda za ličnu njegu, kože, proizvoda za njegu lica i tijela i kozmetičkih proizvoda; onlajn maloprodajne usluge u oblasti kozmetike, proizvoda za ličnu njegu kože, proizvoda za njegu lica i tijela i kozmetičkih proizvoda.

(111) **14492**

(151) 12.12.2019.

(210) Ž-2018-385

(442) 20.10.2019.

(220) 15.10.2018.

(732) PODRAVKA prehrambena industrija d.d., Ante Starcevića 32, 48000, Koprivnica, HR

Slatki dodir fantazije

(540)

(550) I

(740) Miladin Popović, ul. Capital Plaza, ulica šeića Zajeda 13-IV/68, 81000, Podgorica, ME

(511) Klasa 29 Slatka pavlaka za šlag; šlag; mućena pavlaka.

Klasa 30 Prašak za puding; kakao; kakao u prahu; mešavina za kolače; prašak za kolače; čokoladni mus; sufle; preparati za učvršćivanje kremova; mješavina za pripremu deserta, poslastica i kremova; sredstva za pečenje, naročito prašak za pecivo, soda bikarbena (za pečenje); kvasac; glazure za kuvanje; prehrambeni proizvodi na bazi skroba, skrobno brašno; prašak za pripremu sladoleda; dodaci za pojačavanje arome; aromatični začini, naročito cimet, anis i slatki korijen; gotovi rashlađeni deserti, naročito sladoledi i pudinzi; slatka peciva.

(111) **14493**

(151) 18.12.2019.

(210) Ž-2018-244

(442) 20.10.2019.

(220) 12.07.2018.

(732) Ascensia Diabetes Care Holdings AG, Peter Merian-Strasse 90, 4052, Basel, CH

(540) CONTOUR

(550) I

(740) Ascensia Diabetes Care Holdings AG, Peter Merian-Strasse 90, 4052, Basel

(511) Klasa 9 Računarski softver i hardver koji se koriste za praćenje i upravljanje dijabetesom, posebno isključujući USB jedinice

(111) **14494**

(151) 23.12.2019.

(210) Ž-2018-246

(442) 20.10.2019.

(220) 16.07.2018.

(732) Intervet International B.V., Wim de Körverstraat 35, 5831 AN, Boxmeer, NL

(540) **VITRECTO**

(550) I

(740) Mladen Đ. Čolović, Dalmatinska 2, 81000, Podgorica, ME

(511) Klasa 5 Veterinarski preparati

(111) **14495**

(151) 04.12.2019.

(210) Ž-2018-241

(442) 20.10.2019.

(220) 06.07.2018.

(732) HELLENIC FUELS AND LUBRICANTS INDUSTRIAL AND COMMERCIAL S.A. also trading as "EKO ABEE", 8A Cheimarras street, 15125, Marousi, GR

(540)



(550) I

(740) Jasna Jusić, Dalmatinska 2, 81000, Podgorica, ME

(511) Klasa 1 Hemikalije koje se koriste u industriji, nauci i fotografiji, kao i poljoprivredi, hortikulturi i šumarstvu; neprerađene vještačke smole, neprerađene plastične mase; đubriva; jedinjenja za gašenje požara; preparati za kaljenje i lemljenje; hemijske supstance za očuvanje namirnica; supstance za štavljenje; lijepkovi koji se koriste u industriji; hemijski aditivi za upotrebu u proizvodnji maziva; hemijski aditivi; hemijski aditivi za maziva; deterdžentni aditivi za maziva;

naftni derivati; naftni raspršivači; katalizatori pucanja nafte; hemijski dodaci za naftu; deterdžentni aditivi za benzin (petrolej); hemijski aditivi za ulja za grijanje; hemijski proizvodi dobijeni od nafte; aditivi za navodnjavanje; hemijski preparati za disperziju nafte; aditivi (hemijski-) za naftne derivate; tecnosti za korišćenja u naftnoj industriji; hemijski dodaci tečnostima pri vađenju nafte iz bušotina; hemijski aditivi za dizel goriva; katalizatori za upotrebu u obrađivačkoj naftnoj industriji; hemikalije za primjenu u industriji za preradu nafte; hemikalije za upotrebu u formiranju naftnih bušotina; aditivi za podizanje broja naftnih oktana; polimeri za upotrebu pri bušenju i naftnoj industriji; tecnosti za upotrebu u transportu čestica materijala sa naftnih izvora; hemijski aditivi za beton naftnih bušotina; smjese za zaptivanje za spriječavanje curenja iz naftnih rezervoara (hemikalije).

Klasa 4 Industrijska ulja i masti; maziva; mješavine za upijanje prašine, vlaženje i vezivanje; goriva (uključujući motorni benzin) i osvjetljivači; svijeće i fitilji za rasvjetu; ulja za podmazivanje; ulja za turbine; sintetička ulja; mineralna ulja; lubrikantne masti; maziva za automobile; auto maziva za automobilske motore; mazivna ulja za motore motornih vozila; maziva za motorna vozila; višenamjenska maziva; maziva pri bušenju naftnih bušotina; morska ulja; maziva za upotrebu u industrijskim procesima; sintetička maziva; masti; masti za automobile; masti za podmazivanje vozila; mast za kočnice; petrolej; sirova nafta; ulje za rasvjetu ; vještački petrolej; tečni naftni gas; petrolejski nusproizvodi; naftni koks; naftni etar; industrijska lož ulja; naftni gas; ligroin; petrohemijski naftni aditivi; naftna goriva; goriva dobijena iz sirove nafte; tečni naftni gasovi koji se koriste kod motornih vozila; gasno ulje za grijanje domaćinstava; tečni naftni gasovi koji se koriste za domaće potrebe; tečni naftni gasovi koji se koriste u industrijske svrhe; pojačivači sagorijevanja (naftni derivati); aditivi (ne-hemijski) za naftne derivate; naftni koks koji se upotrebljava kao gorivo; gasno ulje za industrijsko grijanje; jedinjenja na bazi nafte za upijanje prašine; aditivi (ne-hemijski) za goriva; dizel ulje; mazut; sirova nafta; motorna ulja.

Klasa 7 Priručne mašine, automatske (manipulatori); pumpe za točenje goriva na servisnim stanicama; samopodešavajuće pumpe za gorivo; uređaji za podizanje; mehanizmi za podizanje za vozila; mehanizmi za podizanje za prikolice; instalacije za izvlačenje prašine u cilju čišćenja; nastavci za usisivače za raspršivanje parfema i dezinfekcionih sredstava; mašine za usisavanje za industrijsku upotrebu; sutomatski aparati za prodaju; samopodešavajuće pumpe za gorivo; instalacije za uklanjanje prašine u cilju čišćenja; dizalice (mašine); elektromehaničke mašine za hemijsku industriju; kranovi (aparati za podizanje); pokretne dizalice za mostove; priručni aparati za utovar i istovar; mašine za sortiranje za industriju; mašine za preradu ulja; instalacije za pranje vozila; ručni alat za mehaničko pokretanje; mašine za čišćenje i aparati za čišćenje, električni; uređaji za čišćenje koji koriste paru ; aparati za čišćenje pod visokim pritiskom; aparati za konverziju goriva za motore sa unutrašnjim sagorijevanjem; uređaji za uštedu goriva za motore i mašine; mašine za pranje koje se pokreću novcem; pumpe za podmazivanje; katalitički pretvarači; aparati za konverziju goriva za motore sa unutrašnjim sagorijevanjem; mašine za transport; mašine i aparati za čišćenje, električni; pneumatski transporteri; instalacije za pranje za vozila; vazdušni jastuci kao oprema za pokretanje vozila ; pneumatski cijevni vodovi ; mašine za katranisanje; instalacije za pranje za vozila; mašine za pranje koje se pokreću novcem; mašine za ispiranje; mašine za presovanje; kompresori (mašine); električni aparati za zavarivanje; aparati za zavarivanje, električni; mašine za pečačenje za industrijsku upotrebu; trake za prenosnike;

platforme za utovar; izduvne mašine za kompresiju, izbacivanje i prenos gasova; električni generatori na dizel gorivo; mašine za pumpanje za naftne bušotine; oprema za izvlačenje nafte; alati za izvlačenje nafte; pumpe za naftu za motore za suvozemna vozila; oprema za poljoprivredu, zemljane radove, izgradnju, vađenje nafte i gasa i rudarstvo.

Klasa 12 Vozila; aparati za kretanje po zemlji, vazduhu ili vodi; dizel motori za suvozemna vozila.

Klasa 35 Oglašavanje; poslovno upravljanje; poslovna administracija; kancelarijski poslovi; maloprodajne usluge u vezi sa: hemikalijama koje se upotrebljavaju u industriji, nauci i fotografiji, kao i poljoprivredi, hortikulturi i šumarstvu; neobrađene vještačke smole, neobrađena plastika; đubriva; smjese za gašenje požara; preparati za kaljenje i lemljenje; hemijske supstance za čuvanje hrane; supstance za štavljenje; lijkovi koji se koriste u industriji; hemijski aditivi za upotrebu u proizvodnji maziva; hemijski aditivi; hemijski aditivi za maziva; deterdžentski aditivi za maziva; naftni derivati; sredstva za raspršivanje nafte; katalizatori za krekovanje nafte; hemijski naftni aditivi; deterdžentski aditivi za gorivo (benzin); hemijski aditivi za ulja za grijanje; hemijski proizvodi koji su derivati nafte; aditivi za proces ubacivanja vode u naftu; hemijski preparati za rasprskivanje nafte; aditivi (hemijski) za naftne proizvode; tecnosti za upotrebu u naftnoj industriji; hemijski aditivi za tečnost za bušotine nafte; hemijski aditivi za dizel goriva; katalizatori koji se upotrebljavaju u industriji obrade nafte; hemikalije koje se upotrebljavaju u rafinerijama nafte; hemikalije koje se upotrebljavaju u formiranju naftnih bušotina; aditivi za podizanje broja oktana u nafti; polimeri za upotrebu u bušenju i naftnoj industriji; tečnosti za upotrebu u prenosu čestica u naftnim bušotinama; hemijski aditivi za cement za naftne bušotine; zaptivne smješe za zaustavljanje curenja iz naftnih cistijerni (hemikalije); industrijska ulja i masti; maziva; smješe za upijanje, vlaženje i vezanje prašine; goriva (uključujući motorna goriva) i rasvjetna sredstva; svijeće i fitilji za paljenje; motorna ulja; mazivna ulja; ulja za turbine; sintetička ulja; mineralna ulja; mazivne masti; automobilska maziva; automobilska maziva za motore automobila; mazivna ulja za motore motornih vozila; maziva za motorna vozila; višenamjenska maziva; maziva pri bušenju naftnih bušotina; morska ulja; maziva za upotrebu u industrijskim procesima; sintetička maziva; masti; masti za automobile; masti za podmazivanje vozila; mast za kočnice; nafta; sirova nafta; ulja za osvjetljavanje; vještačka nafta; tečni naftni gas; nusprodukti nafte; naftni koks; naftni etar; industrijska goriva; naftni gas; ligroin; petrohemijski naftni aditivi; naftni derivati kao goriva; goriva od sirove nafte; tečni naftni gas za upotrebu u motornim vozilima; naftni gas za grijanje kuće; tečni naftni gas za kućne potrebe; tečni naftni gas za industrijske potrebe; pojačivači sagorijevanja (naftni proizvodi); aditivi (nehemijski) za naftne proizvode; naftni koks za upotrebu kao gorivo; naftni gas za industrijsko grijanje; smješe za upijanje prašine na bazi nafte; aditivi (nehemijski) za goriva; dizel ulje; mazut; sirova nafta; automatske masine za upravljanje (manipulatori); pumpe za točenje goriva na benzinskim stanicama; samoregulirajuće pumpe za goriva; aparati za podizanje; mehanizmi za podizanje vozila; mehanizmi za podizanje za prikolice; instalacije za izbacivanje prašine za potrebe čišćenja; dodaci za usisivače za rasprskivanje parfema i dezinfekcionih sredstava; usisnici za industrijske potrebe; automatske mašine za prodaju; samoregulirajuće pumpe za goriva; instalacije za uklanjanje prašine za potrebe čišćenja; dizalice (mašine); elektromehaničke mašine za hemijsku industriju; kranovi (aparati za dizanje); mostovi sa valjcima; aparati za upravljanje utovarom i istovarom; sortirne mašine za industriju; mašine za rafinisanje nafte; instalacije za pranje vozila; ručni alati, izuzev onih kojima se ručno upravlja; električne

mašine i aparati za čišćenje; uređaji za čišćenje parom; uređaji za čišćenje pod visokim pritiskom; aparati za pretvaranje goriva za motore sa unutrašnjim sagorijevanjem; ekonomizatori za motore i pogonske motore; mašine za pranje veša koje rade na kovanice; mazivne pumpe; katalitički konverteri; aparati za pretvaranje goriva za motore sa unutrašnjim sagorijevanjem; mašine za prenos; električne mašine i aparati za čišćenje; pneumatski prenosnici; instalacije za pranje vozila; uređaji sa vazдушnim jastucima za vozila koja se kreću ; pokretne trake sa pneumatskim cijevima; mašine za nanošenje katrana; instalacije za pranje vozila; mašine za pranje veša koje rade na kovanice; mašine za ispiranje; mašine za sabijanje; kompresori (mašine); električni aparati za varenje; aparati za varenje, električni; mašine za zaptivanje za industrijske potrebe; kaiševi za pokretne trake; platforme za utovarivanje; mašine za duvanje za kompresiju , izduvavanje i prenos gasova; dizelski električni generatori; mašine za pumpanje nafte; naftne bušotine; alati za bušenje nafte; naftne pumpe za kopnena motorna vozila; oprema za vađenje i kopanje nafte i gasa za poljoprivredu, kopanje zemlje, građevinarstvo; vozila; aparati za kretanje kopnom, vazduhom ili vodom; dizel motori za kopnena vozila.

Klasa 37 Protektiranje guma; popravke pumpi; pranje vozila; poliranje; vulkanizacija guma (popravke); bušenje dubokih naftnih ili gasnih bušotina; instalacija, održavanje i popravka mašina; građenje fabrika; instalacija i popravka električnih aparata; instalacija i popravka opreme za grijanje; čišćenje vozila ; nadgledanje (upravljanje) gradnje zgrada; popravka i održavanje gorionika; čišćenje i popravka bojlera; podmazivanje vozila; izvlačenje rude; instalacija, popravka i održavanje mašinerije; iznajmljivanje građevinske opreme; iznajmljivanje mašina za pranje rublja; čišćenje vozila; pranje matornih vozila; pranje vozila; poliranje vozila; održavanje vozila ; održavanje i popravka vozila ; izgradnja i održavanje cjevovoda; servisi za vozila (za sipanje goriva i održavanje); održavanje vozila, servisne stanice (benzinske pumpe), popravka ili održavanje opreme za benzinske pumpe, pružanje informacija u vezi sa popravkom ili održavanjem opreme za benzinske pumpe; pumpanje nafte; regulacija naftnih gorionika; izgradnja naftnih cjevovoda; postavljanje naftnih cjevovoda; pumpanje sirove nafte; vađenje nafte; eksploatacija naftnih polja za potrebe vađenja nafte; bušenje sirove nafte; izgradnja i održavanje cjevovoda; vlažno bušenje vode i nafte; ojačavanje naftnih platformi malterom; bušenje nafte i gasa; izgradnja građevina za proizvodnju sirove nafte; izgradnja građevina za čuvanje sirove nafte; izgradnja građevina za prenos sirove nafte; instalacija omota, cjevovoda i cijevi za bušenje nafte.

Klasa 39 Usluge transporta; usluge pakovanja i skladištenja robe; usluge transporta nafte; usluge skladištenja nafte; usluge skladištenje ulja za sagorijevanje; usluge transporta sirove nafte; usluge distribucije nafte; usluge transporta cjevovodima; usluge informisanja u vezi sa transportom nafte.

Klasa 40 Usluge reciklaže đubreta i otpada; usluge prerade otpada; usluge spaljivanje otpada i đubreta; usluge uništavanje otpada i đubreta; usluge dekontaminacije opasnih materija; usluge abrazije; usluge rafinerije; usluge iznajmljivanja kazana; usluge prerade nafte; usluge informisanja u vezi sa preradom materijala; usluge kazandžija; usluge uništavanja otpada i đubreta; usluge prerade nafte; usluge probijanja naftnih izvora; usluge saniranja posledica od izlivanja nafte; usluge prerade naftnih derivata; usluge prerade sirove nafte; usluge prerade nafte; usluge obrade otpadnih ulja; usluge prerade gasa i nafte; usluge savjetovanja u vezi sa postupanjem u slučaju zagađenja nafte; usluge obrade goriva.

Klasa 42 Naučne i tehnološke usluge, kao i usluge istraživanja i projektovanja u vezi sa njima;

usluge industrijskih analiza i istraživanja; projektovanje i razvoj računarskog hardvera i softvera; usluge istraživanje nafte; usluge ispitivanje naftnih izvora; usluge istraživanja naftnih polja; usluge analize potapanja nafte; usluge ispitivanja slojeva zemlje koji sadrže naftu; usluge analiza za eksploataciju naftnih polja; naftni slojevi (usluge pripremanja ispitivanja -); slojevi koji sadrže naftu (usluge pripremanja ispitivanja); usluge izrade ispitivanja naftnih polja; usluge istraživanja u cilju otkrivanja nafte; usluge istraživanja i pretraživanja nafte i gasa; usluge geofizičkog istraživanja za naftnu industriju; analitičke usluge vezane za istraživanje naftnih polja; usluge analize i ispitivanja vezane za naftnu industriju; usluge analize i ispitivanja u oblasti istraživanja nafte; usluge analize i ispitivanja vezane za istraživanja nafte; usluge sprovođenja studija izvodljivosti koje su vezane za istraživanje naftnih polja; usluge sprovođenja studija izvodljivosti koje su vezane za eksploataciju naftnih polja; usluge geofizičkih istraživanja za industrije nafte, gasa i rudarsku industriju; usluge sprovođenja tumačenja snimaka magnetne rezonance i analiza za naftnu industriju.

(111) **14498**

(151) 23.12.2019.

(210) Ž-2018-310

(442) 20.10.2019.

(220) 15.08.2018.

(732) Ingersoll-Rand Company a New Jersey corporation, 800-D Beaty Street, 28036, Davidson, North Carolina, US

INGERSOLL RAND

(540)

(550) I

(740) Miladin Popović, ul. Capital Plaza, ulica šeika Zajeda 13-IV/68, 81000, Podgorica, ME

(511) Klasa 8 Ručni alati i sprave s ručnim pokretanjem; pribor za jelo; hladno oružje, osim vatrenog oružja; brijajući; ručni alati i pribor, naime, lopate, strugalice, metle, grabulje, ručni alat za kopanje uskih rupa, sječiva za testere, šrafovi, glave svrdla, uređaji za bušenje, svrdla za bušenje, metalni šabloni, alati koji sadrže šipke i nosače za montažu brava, i alati koji utiskivanjem oblikuju udubljenja; kompleti za alat koji čine skaleri i pribor za njih, kompleti alata koji se sastoje od udarnih ključeva, čekića i nakovanja, kompleti alata za zaštitu, popravku i održavanje vazdušnih alata, udarnih ključeva, brusilica, lopata, strugalica, metli, grabulja, ručnog alata za kopanje uskih rupa, sječiva za testere, šrafova, glave svrdla i kompleti alata, uređaji za bušenje, i svrdla za bušenje, kompleti alata za upotrebu sa vazdušnim alatom koji se sastoje od crijeva za vazduh, udarni pištolji, spojnice, konektori, utikači, utičnice, trake za zaptivanje navoja, pištolji sa dvostrukom glavom, mjerači pneumatika, mlaznice i iglice za pištanje, kompleti alata za vazdušne pištolje koji se sastoje od sigurnosnih mlaznica, produžnih mlaznica, gumenih vrhova, zupčastih mlaznica za naduvavanje i iglica za naduvavanje, kompleti alata koji se sastoje od udarnih alata, gedora, i kompleta utičnica, kompleti alata koji se sastoje od setova utičnica, kompleti alata za pripremu površine koji se sastoje od brusnog kamenja, šiljaka, podloga za podmazivanje, brusnih ploča, diskova za površinsko glačanje.

Klasa 42 Naučne i tehnološke usluge i istraživanje i dizajniranje koje se odnosi na njih; industrijske analize i usluge industrijskog istraživanja; projektovanje i razvoj računarskog hardvera i softvera; tehničke usluge, naime, konsultacije i dizajniranje kompresora, bušilica za bušenje kamena, mašina

za obradu pulpe, mašina za izgradnju puteva i mašina za rad sa zemljom i hidrauličnih mašina za sječenje po narudžbini i/ ili po specifikaciji drugih; tehničke konsultacije u oblasti dizajniranja kompresora, bušilica za bušenje kamena, mašina za obradu pulpe, mašina za izgradnju puteva i mašina za rad sa zemljom i hidrauličnih mašina za sječenje; inženjerske konsultantske usluge i tehničke konsultacije u oblasti opreme za rukovanje materijalima; hemijska i metalurška analiza opreme za grijanje i klimatizaciju; analiziranje uslova za druge za grijanje i klimatizaciju pomoću računara; i konsultantske usluge u oblasti uslova za grijanje i klimatizaciju.

(111) **14499**

(151) 23.12.2019.

(210) Ž-2018-383

(442) 20.10.2019.

(220) 11.10.2018.

(732) PETAR RAĐENOVIĆ, Njegoševa, br. 26, Budva, ME

Royal Gardens

(540)

(550) I

(740) PETAR RAĐENOVIĆ, Njegoševa, br. 26, Budva

(511) Klasa 39

Klasa 41

Klasa 43

(111) **14503**

(151) 26.12.2019.

(210) Ž-2018-349

(442) 20.10.2019.

(220) 10.09.2018.

(732) State Power Investment Corporation Limited, Building 3, No. 28, Financial Street, Xicheng District, Beijing, CN

(540)



(550) I

(740) Božidar S. Radulović, Studentska bb, Lamela 3/18, 81000, Podgorica, ME

(511) Klasa 4 Goriva; plinsko gorivo; kerozin; plinsko ulje; ugalj; ugljena prašina [gorivo]; električna energija; struja; mineralna goriva.

Klasa 39 Distribucija električne energije; isporuka energije.

Klasa 42 Konsultacije iz oblasti uštede energije; organizovanje tehničko projektnih studija; pružanje naučnih informacija, savjeta i konsultacija u vezi smanjenja emisije ugljenika; istraživanje i razvoj novih proizvoda za druge; razvoj građevinskih projekata; instaliranje računarskog softvera; održavanje računarskog softvera; usluge spoljnih firmi u oblasti informacionih tehnologija.

OBJAVA UPISA PROMJENA U REGISTAR ŽIGOVA
PUBLICATION OF RECORD OF CHANGES TO THE TRADEMARK REGISTER

1. U Registru prijava na prijavi žiga br. Ž-2019-66 podnosioca odnosno založnog dužnika POSLOVNI SISTEM MERCATOR d.d., Dunajska cesta 107, 1000 LJUBLJANA, SI, upisano je založno pravo u korist založnog povjerioca Glas Trust Corporation Limited, 45 Ludgate Hill, London, Ujedinjeno Kraljevstvo, dana 08.10.2019. godine.

2. U Registru prijava na prijavi žiga br. Ž-2019-67 podnosioca odnosno založnog dužnika POSLOVNI SISTEM MERCATOR d.d., Dunajska cesta 107, 1000 LJUBLJANA, SI, upisano je založno pravo u korist založnog povjerioca Glas Trust Corporation Limited, 45 Ludgate Hill, London, Ujedinjeno Kraljevstvo, dana 08.10.2019. godine.

3. U Registru prijava na prijavi žiga br. Ž-2019-68 podnosioca odnosno založnog dužnika POSLOVNI SISTEM MERCATOR d.d., Dunajska cesta 107, 1000 LJUBLJANA, SI, upisano je založno pravo u korist založnog povjerioca Glas Trust Corporation Limited, 45 Ludgate Hill, London, Ujedinjeno Kraljevstvo, dana 08.10.2019. godine.

OBJAVA ISPRAVKI

CORRECTIONS

1. U Crnogorskom glasniku intelektualne svojine br. 28/2019 dana 20.10.2018. godine objavljene su prijave žiga Ž-2016-249 i Ž-2016-250 kao registarovane, a postupak je bio i dalje u toku, te iste nijesu trebale biti objavljene.

2. U Crnogorskom glasniku intelektualne svojine br. 31/2019 dana 20.07.2019. godine objavljena je prijava žiga za znak OMNIA pod brojem Ž-2018-214, umjesto kojeg treba da stoji kao broj prijave žiga Ž- 2018-213.

3. U Crnogorskom glasniku intelektualne svojine br. 32/2019 dana 20.10.2019. godine objavljena je prijava žiga za znak UPJOHN u klasi 05 Ničanske klasifikacije roba i usluga pod brojem Ž-2018-415, umjesto kojeg treba da stoji kao broj prijave žiga Ž- 2018-416.

4. U Crnogorskom glasniku intelektualne svojine br. 32/2019 dana 20.10.2019. godine objavljena je prijava žiga pod brojem Ž-2018-475, pri čemu je naveden pogrešan naziv podnosioca i punomoćnika.

Umjesto:

(210) 2018-475

(442) 20.10.2019

(220) 30.11.2018

(731) **DON DON proizvodno in trgovsko podjetje d.o.o., Gasilska cesta 2, 1290 Grosuplje, Slovenija, SI ;**

 ATLANTIC PRIMA

(540)

(550) I, F

(740) **AOD ``ĆUPIĆ``, Podgorica, Bulevar Džordža Vašingtona 79, ME ;**

(511) Klasa 29: Konzervisana riba.

Treba da stoji:

(210) 2018-475

(442) 20.10.2019

(220) 30.11.2018

(731) **Društvo sa ograničenom odgovornošću za proizvodnju, promet i usluge" Tricontinental export-import" D.O.O Cetinje, ul. Peke Pavlovića br.1 Cetinje;**

ATLANTIC PRIMA

(540)

(550) I, F

(740) **Marko Zdjelar, Kneginje Zorke 20, 11000 Beograd, Republika Srbija;**

(511) Klasa 29: Konzervisana riba.

5. U Crnogorskom glasniku intelektualne svojine br. 32/2019 dana 20.10.2019. godine objavljena je prijava žiga pod brojem Ž-2019-25, pri čemu je naveden pogrešan broj klase. Naime, umjesto klase 3, treba da stoji klasa 7, dok u spisku roba u klasama 7 i 12 nedostaje veznik „i“ između riječi „vazduhoplovstvu i kosmonautici“.

Umjesto:

(210) 2019-25

(442) 20.10.2019

(220) 29.01.2019

(300) August 3, 2018 of Jamaican Trademark Application No.75590

(731) Caterpillar Inc., a corporation of Delaware, 100 NE Adams Street, Peoria, Illinois 61629, U.S.A., US ;



(540)

(550) I, F

(740) AOD ĆUPIĆ, Podgorica, Bulevar Džordža Vašingtona 79, ME ;

(511) **Klasa 3:** Mašine i njihovi priključci za upotrebu u poljoprivredi, sabijanju, izgradnji, rušenju, pripremi zemljišta, oblikovanju zemljišta, pomjeranju zemlje, šumarstvu, uređenju zemljišta, podizanju tereta, brodarstvu, rukovanju materijalima, rukovanju otpadnim materijalima, rudarstvu, malčiranju, distribuciji, istraživanju i proizvodnji nafte i gasa, popločavanju, polaganju cijevi, proizvodnji struje, izgradnji i popravci puteva, pripremi i remedijaciji terena, upravljanju otpadom, vazduhoplovstvu kosmonautici, kamenolomima,

šljunkarama i cementarama, uređenju vegetacije, transportu, i za potrebe državne uprave i odbrane; alatne mašine i njihovi priključci, motori, pogonske mašine i generatori (koji nijesu za kopnena vozila); mašinske spojnice i transmisioni elementi (koji nijesu za kopnena vozila); i rezervni djelovi, djelovi za zamjenu i refabrikovani djelovi za sve navedene proizvode.

Klasa 12: Vozila, uređaji za kretanje po zemlji, vazduhu ili vodi; vozila i uređaji za kretanje po zemlji, vazduhu ili vodi za upotrebu u poljoprivredi, sabijanju, izgradnji, rušenju, pripremi zemljišta, oblikovanju zemljišta, pomjeranju zemlje, šumarstvu, uređenju zemljišta, podizanju tereta, brodarstvu, rukovanju materijalima, rukovanju otpadnim materijalima, rudarstvu, malčiranju, distribuciji, istraživanju i proizvodnji nafte i gasa, popločavanju, polaganju cijevi, proizvodnji struje, izgradnji i popravci puteva, pripremi i remedijaciji terena, upravljanju otpadom, vazduhoplovstvu kosmonautici, kamenolomima, šljunkarama i cementarama, uređenju vegetacije, transportu, i za potrebe državne uprave i odbrane; i rezervni djelovi, djelovi za zamjenu i refabrikovani djelovi za sve navedene proizvode.

Treba da stoji:

(210) 2019-25

(442) 20.10.2019

(220) 29.01.2019

(300) August 3, 2018 of Jamaican Trademark Application No.75590

(731) Caterpillar Inc., a corporation of Delaware, 100 NE Adams Street, Peoria, Illinois 61629, U.S.A., US ;

(540) 

(550) I, F

(740) AOD ĆUPIĆ, Podgorica, Bulevar Džordža Vašingtona 79, ME ;

(511) **Klasa 7:** Mašine i njihovi priključci za upotrebu u poljoprivredi, sabijanju, izgradnji, rušenju, pripremi zemljišta, oblikovanju zemljišta, pomjeranju zemlje, šumarstvu, uređenju zemljišta, podizanju tereta, brodarstvu, rukovanju materijalima, rukovanju otpadnim materijalima, rudarstvu, malčiranju, distribuciji, istraživanju i proizvodnji nafte i gasa, popločavanju, polaganju cijevi, proizvodnji struje, izgradnji i popravci puteva, pripremi i remedijaciji terena, upravljanju otpadom, vazduhoplovstvu i kosmonautici, kamenolomima, šljunkarama i cementarama, uređenju vegetacije, transportu, i za potrebe državne uprave i odbrane; alatne mašine i njihovi priključci, motori, pogonske mašine i generatori (koji nijesu za

kopnena vozila); mašinske spojnice i transmisioni elementi (koji nijesu za kopnena vozila); i rezervni djelovi, djelovi za zamjenu i refabrikovani djelovi za sve navedene proizvode.

Klasa 12: Vozila, uređaji za kretanje po zemlji , vazduhu ili vodi; vozila i uređaji za kretanje po zemlji, vazduhu ili vodi za upotrebu u poljoprivredi, sabijanju, izgradnji, rušenju, pripremi zemljišta, oblikovanju zemljišta, pomjeranju zemlje, šumarstvu, uređenju zemljišta, podizanju tereta, brodarstvu, rukovanju materijalima, rukovanju otpadnim materijalima, rudarstvu, malčiranju, distribuciji, istraživanju i proizvodnji nafte i gasa, popločavanju, polaganju cijevi, proizvodnji struje, izgradnji i popravci puteva, pripremi i remedijaciji terena, upravljanju otpadom, vazduhoplovstvu i kosmonautici, kamenolomima, šljunkarama i cementarama, uređenju vegetacije, transportu, i za potrebe državne uprave i odbrane; i rezervni djelovi, djelovi za zamjenu i refabrikovani djelovi za sve navedene proizvode.

6. U Crnogorskom glasniku intelektualne svojine br. 32/2019 dana 20.10.2019. godine objavljena je prijava žiga pod brojem Ž-2019-26, pri čemu je naveden pogrešan prioritet kao i broj klase.

Umjesto:

(210) 2019-26

(442) 20.10.2019

(220) 29.01.2019

(300) August 3, 2018 of Jamaican Trademark Application No. **75590**

(731) Caterpillar Inc., a corporation of Delaware, 100 NE Adams Street, Peoria, Illinois 61629, U.S.A., US ;

(540) 

(550) I, F

(740) AOD ĆUPIĆ, Podgorica, Bulevar Džordža Vašingtona 79, ME ;

(511) **Klasa 3:** Mašine i njihovi priključci za upotrebu u poljoprivredi, sabijanju, izgradnji, rušenju, pripremi zemljišta, oblikovanju zemljišta, pomjeranju zemlje, šumarstvu, uređenju zemljišta, podizanju tereta, brodarstvu, rukovanju materijalima, rukovanju otpadnim materijalima, rudarstvu, malčiranju, distribuciji, istraživanju i proizvodnji nafte i gasa, popločavanju, polaganju cijevi, proizvodnji struje, izgradnji i popravci puteva, pripremi i

remedijaciji terena, upravljanju otpadom, vazduhoplovstvu kosmonautici, kamenolomima, šljunkarama i cementarama, uređenju vegetacije, transportu, i za potrebe državne uprave i odbrane; alatne mašine i njihovi priključci, motori, pogonske mašine i generatori (koji nijesu za kopnena vozila); mašinske spojnice i transmisioni elementi (koji nijesu za kopnena vozila); i rezervni djelovi, djelovi za zamjenu i refabrikovani djelovi za sve navedene proizvode.

Klasa 12: Vozila, uređaji za kretanje po zemlji , vazduhu ili vodi; vozila i uređaji za kretanje po zemlji, vazduhu ili vodi za upotrebu u poljoprivredi, sabijanju, izgradnji, rušenju, pripremi zemljišta, oblikovanju zemljišta, pomjeranju zemlje, šumarstvu, uređenju zemljišta, podizanju tereta, brodarstvu, rukovanju materijalima, rukovanju otpadnim materijalima, rudarstvu, malčiranju, distribuciji, istraživanju i proizvodnji nafte i gasa, popločavanju, polaganju cijevi, proizvodnji struje, izgradnji i popravci puteva, pripremi i remedijaciji terena, upravljanju otpadom, vazduhoplovstvu kosmonautici, kamenolomima, šljunkarama i cementarama, uređenju vegetacije, transportu, i za potrebe državne uprave i odbrane; i rezervni djelovi, djelovi za zamjenu i refabrikovani djelovi za sve navedene proizvode.

Treba da stoji:

(210) 2019-26

(442) 20.10.2019

(220) 29.01.2019

(300) August 3, 2018 of Jamaican Trademark Application No. **75592**

(731) Caterpillar Inc., a corporation of Delaware, 100 NE Adams Street, Peoria, Illinois 61629, U.S.A., US ;

(540) The logo consists of the letters 'CAT' in a bold, sans-serif font, with a stylized graphic element to the right that resembles a mountain range or a series of peaks.

(550) I, F

(740) AOD ĆUPIĆ, Podgorica, Bulevar Džordža Vašingtona 79, ME ;

(511) **Klasa 7:** Mašine i njihovi priključci za upotrebu u poljoprivredi, sabijanju, izgradnji, rušenju, pripremi zemljišta, oblikovanju zemljišta, pomjeranju zemlje, šumarstvu, uređenju zemljišta, podizanju tereta, brodarstvu, rukovanju materijalima, rukovanju otpadnim materijalima, rudarstvu, malčiranju, distribuciji, istraživanju i proizvodnji nafte i gasa, popločavanju, polaganju cijevi, proizvodnji struje, izgradnji i popravci puteva, pripremi i remedijaciji terena, upravljanju otpadom, vazduhoplovstvu i kosmonautici, kamenolomima, šljunkarama i cementarama, uređenju vegetacije, transportu, i za potrebe državne uprave i odbrane; alatne mašine i njihovi priključci, motori, pogonske mašine i generatori (koji nijesu za

kopnena vozila); mašinske spojnice i transmisioni elementi (koji nijesu za kopnena vozila); i rezervni djelovi, djelovi za zamjenu i refabrikovani djelovi za sve navedene proizvode.

Klasa 12: Vozila, uređaji za kretanje po zemlji , vazduhu ili vodi; vozila i uređaji za kretanje po zemlji, vazduhu ili vodi za upotrebu u poljoprivredi, sabijanju, izgradnji, rušenju, pripremi zemljišta, oblikovanju zemljišta, pomjeranju zemlje, šumarstvu, uređenju zemljišta, podizanju tereta, brodarstvu, rukovanju materijalima, rukovanju otpadnim materijalima, rudarstvu, malčiranju, distribuciji, istraživanju i proizvodnji nafte i gasa, popločavanju, polaganju cijevi, proizvodnji struje, izgradnji i popravci puteva, pripremi i remedijaciji terena, upravljanju otpadom, vazduhoplovstvu i kosmonautici, kamenolomima, šljunkarama i cementarama, uređenju vegetacije, transportu, i za potrebe državne uprave i odbrane; i rezervni djelovi, djelovi za zamjenu i refabrikovani djelovi za sve navedene proizvode.

7. U Crnogorskom glasniku intelektualne svojine br. 29/2019 dana 20.01.2019. godine objavljena je prijava žiga Ž-2017-483 bez izgleda znaka.

Umjesto :

(210) 2017-483

(442) 20.01.2019

(220) 6/12/2017

(731) Amazon Europe Core S.à.r.l., 5, Rue Plaetis, L-2338 Luxembourg, LU;

(550) I

(740) Jusić Jasna, Dalmatinska 2, Podgorica ME

(511) **Klasa 09:** Kontrolni uređaji za kucnu automatizaciju; bežični komunikacioni uređaji za prenos glasa, podataka iii slika; uređaji za prenos i prijem glasa i podataka; samostalni informacioni Uređaji koji se kontrolisu pomocu glasa; nezavisni glasovno-aktivirani lični (virtualni) asistenti koji integriraju usluge koje se pružaju putem aplikacija; zvučnici koji se kontrolisu pomocu glasa; aparati i instrumenti naučni, pomorski, geodetski, fotografski, kinematografski, optički, za vaganje, mjerenje, signalizaciju , kontrolu (inspekciju), spasavanje i nastavu; aparati za snimanje, prenos iii reprodukciju zvuka iii slika; računске mašine; oprema za obradu podataka; kompjuteri; aparati i instrumenti za provodenje, prekid, transformaciju, akumulaciju, regulisanje iii kontrolu elektricne energije; magnetni nosaci podataka; diskovi za snimanje; kompakt diskovi, DVD i drugi digitalni nosaci podataka; mehanizmi za aparate koji se pokrecu novcem; računarski softver; prenosivi elektronski uređaji za prijem, prenos i citanje teksta, slika i zvuka putem bezicnog internet pristupa; daljinski kontrolni uređaji za uređaje za snimanje; daljinski kontrolni uređaji; bežični kontrolni uređaj za daljinski nadzor i kontrolu

funkcije i statusa drugih električnih, elektronskih, i mehaničkih uređaja i sistema; kompjuterski ekrani osjetljivi na dodir; digitalni audio plejeri; audio rekorderi; digitalni video plejeri; prenosivi uređaji za snimanje, prenos i reprodukciju muzike, slika i videa; elektronski aparati i instrumenti za obuku i nastavu; kamere; digitalne kamere; softver za preusmjeravanje poruka; kompjuterski hardver i softver za obradu, reprodukciju, sinhronizaciju, snimanje, organizovanje, preuzimanje, postavljanje, prenos, striming, prijem, pustanje i gledanje televizijskih emisija, filmova, teksta, slika, digitalnih medija, multimedija, audio, video i fajlova sa podacima; kompjuterski softver za pristup, nadgledanje, praćenje, pretraživanje, čuvanje i dijeljenje informacija u vezi sa temama od opšteg interesa; kompjuterski softver i periferne jedinice za personalizovano, interaktivno televizijsko (TV) programiranje; kompjuterski softver i periferni uređaji za upotrebu kod prikazivanja i manipulisanja vizuelnim medijima, grafičkim slikama, tekstovima, fotografijama, ilustracijama, digitalnim animacijama, video klipovima, filmskim snimcima i audio podacima i za upotrebu kod društvenog umrežavanja; kompjuterski programi za pristup, pregledanje i pretraživanje onlajn baza podataka; kompjuterski hardver i softver za pružanje integrirane telefonske komunikacije za kompjuterizovanim globalnim informacionim mrežama; kompjuterski softver koji se koristi za kontrolu nezavisnih glasovno-aktiviranih licnih (virtualnih) asistenata koji integrisu usluge koje se pružaju putem aplikacija; kompjuterski softver koji se koristi u vezi sa uslugama pretplate na digitalne sadržaje, osiguravanjem platforme za pretragu koje omogućavaju korisnicima da traže i primaju sadržaj digitalnih medija; kompjuterski softver za kreiranje, autorstvo, distribuciju, preuzimanje, prenos, prijem, igranje, formatiranje, editovanje, ekstrakciju, kodiranje, dekodiranje, konvertovanje, prikazivanje, skladištenje i organizaciju teksta, vizuelnih, audio i audio-vizuelnih literarnih radova, podataka, fajlova, dokumenata i elektronskih radova i multimedijalnog sadržaja; kompjuterski softver koji omogućava da se sadržaj, tekst, vizuelni, audio i audio-vizuelni radovi, literarni radovi, podaci, fajlovi, dokumenta i elektronski radovi budu preuzeti na i da im se može pristupiti na kompjuteru ili drugim prenosivim elektronskim uređajima; kompjuterski softver za prenos, dijeljenje, prijem, preuzimanje, striming, prikazivanje i prebacivanje sadržaja, teksta, vizuelnih, audio i audio-vizuelnih radova, literarnih radova, podataka, fajlova, dokumenata i elektronskih radova putem prenosivih elektronskih uređaja i kompjutera i globalnih kompjuterskih i komunikacionih mreža; stereo zvučnici za ličnu upotrebu; mikrofoni; softver za prepoznavanje slova, simbola; softver za prepoznavanje glasa; softver za elektronsku poštu i poruke; kompjuterski softver za formatiranje i konvertovanje sadržaja, teksta, vizuelnih, audio i audio-vizuelnih radova, literarnih radova, podataka, fajlova, dokumenata i elektronskih radova u format kompatibilan sa prenosivim elektronskim uređajima i kompjuterima; kompjuterski softver za upravljanje licnim informacijama i za pristup, pregledanje i pretragu audio i multimedijalnog sadržaja, igrica i softverskih aplikacija; softver za prepoznavanje glasa i glasovne komande, softver za pretvaranje govora u tekst i softverske aplikacije koje se aktiviraju putem glasa; softver koji se može preuzeti sa interneta u vidu mobilnih aplikacija za kompjutere ili druge prenosive elektronske uređaje široke potrošnje; kompjuterski softver iz oblasti prenosa i prikaza teksta, slika i zvuka.

Klasa 35: Oglašavanje; marketinške usluge i usluge oglašavanja, naime, promocija proizvoda i usluga drugih strana; usluge za realizaciju porudžbina, naime, usluge u vezi sa prijemom i obradom porudžbina; pružanje informacija o proizvodima u svrhu asistiranja pri odabiru standardne potrošačke robe, a radi zadovoljenja potreba potrošaca; obezbjeđivanje usluga za optimizaciju pretraživaca; usluge uporedne kupovine, naime, promovisanje roba i usluga drugih strana; elektronsko upravljanje bazama podataka i fajlovima; kreiranje indeksa informacija, sajtova i drugih izvora dostupnih na globalnim kompjuterskim mrežama i drugim elektronskim i komunikacionim mrežama za druge; pružanje informacija o potrošačkim proizvodima u cilju odabira standardne potrošačke robe, a radi zadovoljenja specifikacija i potreba potrošaca; komercijalne informacije i savjeti za potrošace, naime, pružanje mogućnosti internet korisnicima da postavljaju ocjene, napisu recenzije i preporuke za širok spektar potrošačkih proizvoda; usluge onlajn maloprodajnih objekata koje nude širok spektar potrošačke robe drugih strana; usluge maloprodajnih objekata koje nude širok spektar potrošačke robe drugih strana; maloprodajne i onlajn maloprodajne usluge u vezi sa knjigama, elektronikom, hranom, vinom i napicima, kuhinjskim 735 proizvodima, proizvodima za šišćenje, posudem za kuvanje, proizvodima za domaćinstvo, odjećom, proizvodima za ličnu njegu, proizvodima za kućne ljubimce, sportskom opremom, opremom za kampovanje, igračkama, nakitom, cvijecem, obućom i pokrivalima za glavu; vodenje poslova, poslovno upravljanje; kancelarijski poslovi; obezbjeđivanje direktorijuma za telefonske brojeve, poslovne adrese, adrese elektronske pošte, adrese internet stranica, adrese i telefonski brojevi ljudi, mjesta i organizacija. **Klasa 38:** Telekomunikacione usluge; telekomunikacione usluge, naime, elektronski prenos emitovanih fajlova sa audio, vizuelnim i multimedijalnim sadržajem koji se može preuzimati putem kompjutera i drugih komunikacionih mreža; elektronski prenos poruka, glasa, podataka i slika putem globalnih komunikacionih mreža; elektronska komunikacija; elektronski prenos informacija i podataka; dostava poruka putem elektronskog prenosa; obezbjeđivanje pristupa forumima za diskusiju; obezbjeđivanje onlajn oglasnih tabli za prenos poruka među kompjuterskim korisnicima u vezi sa informacijama o potrošačkim proizvodima; audio emitovanje izgovorene riječi; audio emitovanje i prenos obrazovnih i zabavnih digitalnih medija; bezicne širokopojasne komunikacione usluge; obezbjeđivanje pristupa interaktivnoj bazi podataka za prenos poruka između kompjuterskih korisnika i pretplatnika a u vezi sa knjigama, filmovima, igranim filmovima, igrama, igračkama, sportskom opremom, elektronikom, multimedijalnim prezentacijama i drugim proizvodima za domaćinstva i potrošačkim proizvodima; obezbjeđivanje pristupa onlajn direktorijumima, bazama podataka, internet stranicama i blogovima na temu aktuelnih događaja i onlajn referentnim materijalima; obezbjeđivanje onlajn portal i internet stranica obrazovnog i zabavnog sadržaja, naime, filmovi, televizijske emisije, audiovizuelni radovi, muzika, audio radovi, knjige, pozorišni radovi, literarni radovi, sportski događaji, rekreativne aktivnosti, slobodne aktivnosti u vidu hobija, turnira, umjetnosti, plesa, mjuzikala, kulture, sportskih i izložbi aktuelnih događaja, sportskih instrukcija, klubova, radio programa, komedija, drama, takmicenja, vizuelnih umjetničkih djela, igara, igrice, festival, muzeja, parkova, kulturnih događaja, koncerata, elektronskih editorijala, animacija, aktuelnih događaja, modnih revija, multimedijalnih prezentacija i interaktivnih edukativnih

kvizova; prenos podkastova, prenos vebkastova; usluge tekstualnih i numeričkih bežičnih poruka; obezbjeđivanje onlajn mreze koja omogućava korisnicima pristup i dijeljenje sadržaja, teksta, vizuelnih, audio i audiovizuelnih radova, literarnih radova, podataka, fajlova, dokumenata i elektronskih radova; obezbjeđivanje telekomunikacionog vremenskog pristupa korisnicima komunikacionim mrežama putem identifikacije, lociranja, grupisanja, distribuiranja i upravljanja podacima i linkovima kompjuterskih servera trećih strana, kompjuterskih procesora i kompjuterskih korisnika; obezbjeđivanje kompjuterskih direktorijuma za telefonske brojeve, poslovne adrese, adrese elektronske paste, adrese internet stranica, adrese i telefonske brojeve ljudi, mjesta i organizacija; obezbjeđivanje pristupa pomocnim Uređajima iii elektronskim Uređajima u vidu obezbjeđivanja usluga telekomunikacione povezanosti za prenos slika, poruka, audio, vizuelnih i audiovizuelnih i multimedijalnih radova između čitača elektronskih knjiga, mobilnih telefona, pametnih telefona, prenosivih elektronskih Uređaja, prenosivih digitalnih Uređaja, tableta iii kompjutera; emitovanje audio, vizuelnog i audiovizuelnog materijala preko internet iii drugih kompjuterskih iii komunikacionih mreža; obezbjeđivanje onlajn saba za caskanje, internet foruma i onlajn zajednica za prenos fotografija, videa, teksta, podataka, slika i drugih elektronskih radova; obezbjeđivanje informativnih, konsultacionih i savjetodavnih usluga u vezi sa gore navedenim.

Klasa 41: Obezbjeđivanje informacija koje se odnose na zabavu; izdavanje časopisa; pružanje onlajn elektronskih publikacija (koje se ne mogu preuzeti); objavljivanje elektronskih knjiga, novina; objavljivanje materijala na magnetnim ili optičkim medijima; objavljivanje muzike na mreži; pružanje informacija u oblasti zabave na mreži; obezbjeđivanje unaprijed snimljene muzike i podkastova koji se ne mogu preuzeti; pružanje edukativnih i zabavnih informacija, vijesti i komentara u oblasti aktuelnih događaja, 736 zabave, kulturnih događaja, vijesti, sparta, zabave, poslovanja i finansija, politike i javnog upravljanja, zdravlja i fizičke kondicije, vremenskih uslova, nauke i tehnologije, putovanja, umjetnosti i književnosti, nacina života i licnog razvoja, prevoza robe u kopnenim i transportnim vozilima, obrazovanja i razvoja djece, nekretnina, mode i dizajna, recepata, sastojaka i kuvanja, uredjenja kuce, muzike i bioskopa, istorije, medicine, prava i pružanja obrazovnih i zabavnih informacija o pravima kupaca; obezbjeđivanje internet stranice sa informacijama, audio sadržajem i publikacijama koje se odnose na zabavu; obezbjeđivanje vijesti i informacija u oblasti zabave u vezi sa informacijama, takmicenjima, tekstovima, zvukom, publikacijama koje se odnose na zabavu; konsultantske usluge u oblasti zabave i industrije zabave; pružanje informacija o zabavi, filmovima i televizijskim emisijama preko društvenih mreža; distribucija radio zabave i interaktivnog oglašavanja; zabavne informativne usluge, naime, pružanje mogućnosti za razmjenu informacija i razgovor o širokom spektru tema putem događaja uživo i informacija putem elektronske pošte; pružanje informacija, pregleda i personalizovanih preporuka iz oblasti zabave putem globalnih komunikacionih mreža; pružanje informacija i komentara u oblasti zabave ili obrazovanja putem globalne računarske mreže, odnosno informacija u oblasti muzike, knjiga, filmova, igranih filmova, igara, igracaka, sportskih proizvoda, elektronike, multimedijalnih prezentacija i drugih proizvoda za domaćinstvo i potrošačkih proizvoda; usluge za zabavu,

naime, obezbjeđivanje onlajn unaprijed snimljenih audio programa iz oblasti muzike, knjiga, filmova, igranih filmova, igara, igračkaca, sportskih proizvoda, elektronike, multimedijalnih prezentacija i drugih proizvoda za domacinstvo i potrošačkih proizvoda; usluge zabave, naime, pružanje onlajn kritika, ocjena i preporuka muzike, knjiga, filmova, igranih filmova, igara, igračkaca, sportskih proizvoda, elektronike, multimedijalnih prezentacija i drugih proizvoda za domacinstvo i potrošačkih proizvoda; usluge zabave, naime, obezbjeđivanje dijela unaprijed snimljenih audio radova putem interneta; izdavanje knjiga, časopisa, periodičnih časopisa, književnih radova, audio radova i audiovizuelnih radova; obezbjeđivanje unaprijed snimljenih audio, vizuelnih i audio-vizuelnih radova koji se ne mogu preuzimati preko bezicnih mreža; pružanje onlajn kompjuterskih igara i onlajn interaktivnih prica; obezbjeđivanje informacija, vijesti, članaka i komentara u oblasti edukacije i obrazovnih institucija; edukativne usluge u ime nastave u ucionici i onlajn ucenje na daljinu na temu aktuelnih događaja, obrazovanja, istorije, jezika, liberalnih umjetnosti, matematike, biznisa, nauke, hobija, tehnologije, kulture, sparta, umjetnosti, psihologije i filozofije; interaktivne obrazovne usluge u vidu instrukcija na kompjuterima iii pomocu kompjutera a na temu aktuelnih događaja, obrazovanja, istorije, jezika, liberalnih umjetnosti, književnosti, matematike, biznisa, nauke, hobija, tehnologije, kulture, sparta, umjetnosti, psihologije i filozofije; edukativne i zabavne usluge koje se odnose na podcastove, vebkastove i kontinuirane programe sa vijestima i komentarima iz oblasti muzike, audio radova, knjiga, pozorišta, književnih radova, sportskih događaja, rekreativnih aktivnosti, slobodnih aktivnosti, turnira, umjetnosti, plesa, mjuzikala, izlozbi, sportske nastave, klubova, radia, komedije, takmicenja, vizuelnih radova, igara, igrica, festivala, muzeja, parkova, kulturnih događaja, koncerata, izdavaštva, animacija, aktuelnih događaja, mode i multimedijalnih prezentacija koje su dostupne putem interneta ili drugog računara na komunikacionim mrežama; proizvodnja radio programa; radio zabave; usluge studijskog snimanja; pružanje onlajn informacija u vezi sa kompjuterskim igricama i računarskim poboljšanjima za igrice; obezbjeđivanje baze podataka za onlajn zabavu koja se može pretraživati, uključujući onlajn muziku koja se ne može preuzeti i drugi digitalni tekst, audio datoteke sa knjigama, časopisima, vijestima i informacijama; pružanje informacija, konsultantskih i savjetodavnih usluga u vezi sa gore navedenim. **Klasa 42:** Obezbjeđivanje alata za pretraživanje; kompjuterske usluge, naime, daljinski hosting operativnih sistema i kompjuterskih aplikacija; hosting operativnih sistema i kompjuterskih aplikacija preko interneta; kompjutersko programiranje; konsultantske usluge u vezi sa upravljanjem, prezentacijom i kontrolom multimedijalnih aplikacija; dizajn hardvera, softvera i kompjuterskih sistema; usluge uređivanja, ažuriranja, održavanja i podrške za softverske i kompjuterske sisteme; kompjuterske usluge u vezi sa upravljanjem, prezentacijom i kontrolom multimedijalnih aplikacija, istraživanje, upravljanje bazama podataka, upravljanje objektima, usluge podugovaranja; kompjuterske usluge, naime, hosting preko interneta onlajn baza podataka koje sadrže širok spektar informacija od opšteg interesa; kompjuterske usluge, naime, obezbjeđivanje alata za pretraživanje informacija od opšteg interesa; hosting interaktivne baze podataka za prenos poruka među kompjuterskim korisnicima i pretplatnicima; hosting interaktivne baze podataka za prenos poruka među kompjuterskim korisnicima i pretplatnicima, a u vezi sa knjigama,

filmovima, igranim filmovima, televizijskim programima, igrama, igračkama, sportskom opremom, elektronskim uređajima, multimedijalnim prezentacijama i drugom potrošačkom robom i robom za domaćinstvo, ocjenama proizvoda i informacijama o kupovini na interentu; pružanje softvera onlajn internet pregledaca koji se ne može preuzeti; pružanje softvera koji se ne može preuzeti za mobilni komunikacioni uređaj za poboljšanje mobilnog pristupa internetu putem računara, mobilnih računara i mobilnih komunikacionih uređaja; tehnička podrška, naime, rješavanje problema kompjuterskog hardvera i softvera i hardverskih i softverskih problema na mobilnim računarima i mobilnim komunikacionim uređajima; konsultacije i dizajn u vezi sa kompjuterskim hardverom i softverom; dizajn kompjuterskog softvera za druge; konsultacije i dizajn u vezi sa mobilnim računarima i mobilnim komunikacionim uređajima; hosting sadržaja, fotografija, teksta, podataka, slika, internet stranica i drugih elektronskih radova za treća lica; pružanje platformi za pretragu kako bi se korisnicima omogućilo da traže i primaju fotografije, tekst, podatke, slike, elektronske radove, vizuelne radove, audio radove, audio- vizuelne radove, literarne radove i dokumenta; interaktivne hosting usluge koje dozvoljavaju korisnicima da objavljuju i dijele sopstvene fotografije, tekst, podatke i slike onlajn; održavanje i ažuriranje softvera u vezi sa računarima, internetom i sigurnošću lozinke i prevencija rizika za računare, internet i lozinke; instalacija i održavanje kompjuterskog softvera; pružanje internet stranice koja sadrži tehničke informacije u vezi sa kompjuterskim softverom i hardverom; kompjuterske konsultacije; transfer podataka iz dokumenata iz jednog kompjuterskog fermata u drugi; hosting digitalnog sadržaja na globalnim računarskim mrežama, bezicnim mrežama i mrežama elektronske komunikacije; pružanje privremene upotrebe kompjuterskog softvera i onlajn postrojenja, koji se ne mogu preuzeti, kako bi se korisnicima omogućio pristup i preuzimanje kompjuterskog softvera; pružanje privremene upotrebe kompjuterskog softvera koji se ne može preuzeti, a koji generise prilagodene preporuke softverskih aplikacija na osnovu korisničkih preferenci; pracenje kompjuterizovanih podataka i kompjuterskih sistema i mreža za sigurnosne namjene; hosting, prilagodavanje i održavanje onlajn baza podataka za druge; računarstvo u oblaku sa softverom za upotrebu u upravljanju bazama podataka; hosting elektronskih baza podataka u oblaku; pružanje usluga aplikacija (ASP) za softver za upotrebu u upravljanju bazama podataka; platforma u vidu servisa (PAAS) za kompjuterske softverske platforme za upotrebu u upravljanju bazama podataka; softver u vidu servisa (SAAS za upotrebu u upravljanju bazama podataka; softver u vidu servisa (SaaS) za pristup, monitoring, pracenje, pretragu, čuvanje i dijeljenje informacija o temama od opšteg interesa; softver u vidu servisa (SaaS) za upravljanje licnim informacijama i za pristup, pregled i pretragu onlajn baza podataka, audio i multimedijalnog sadržaja, igara, softverskih aplikacija, tržišta softverskih aplikacija, programskih listi i vodica i videa na zahtjev; softver u vidu servisa (SaaS) koji koristi softver za glasovne komande i prepoznavanje glasa, softver za pretvaranje govora u tekst, softverske aplikacije koje se aktiviraju glasom, upravljanje licnim informacijama i softver za pristup, pregled i pretragu onlajn baza podataka, audio i multimedijalnog sadržaja, igara, softverskih aplikacija, trzista softverskih aplikacija, programskih listi i vodica i videa na zahtjev; softver u vidu servisa (SaaS) kojim se omogućava preuzimanje 738 i pistup na računaru ili drugom nosivom potrošačkom elektronskom Uređaju audio i multimedijalnih datoteka;

softver u vidu servisa (SaaS) za mobilne Uređaje kojim se korisniku dozvoljava da pretražuje sadržaj Uređaja radi informacija, kontakata ili aplikacija; softver u vidu servisa (SaaS) za kreiranje indeksa informacija, internet stranica ili drugih informativnih resursa; softver u vidu servisa (SaaS) za glasovne komande i prepoznavanje glasa; softver u vidu servisa (SaaS) za kontrolu pametnih audio zvučnika; softver u vidu servisa (SaaS) za upotrebu u vezi sa uslugama pretplate na digitalne sadržaje; softver u vidu servisa (SaaS) za kreiranje, autorstvo, distribuciju, preuzimanje, prenošenje, primanje, reprodukciju, uređivanje, izvlačenje, kodiranje, dekodiranje, prikazivanje, čuvanje i organizaciju audio i multimedijalnog sadržaja; pružanje platformi za pretragu kako bi se korisnicima omogućilo da traže i primaju digitalni medijski sadržaj i aplikacije; pružanje privremene upotrebe onlajn softvera i aplikacija koji se ne mogu preuzeti za pristup strimingu audio i video datoteka, igrama, društvenim mrežama, tekstualnim i multimedijalnim datotekama; kompjuterske usluge, naime, pružanje servera baza podataka različitih kapaciteta drugima; pružanje internet stranica na kojima se nalazi softver za upravljanje bazama podataka koji se ne može preuzeti; pružanje operativnih sistema i kompjuterskih aplikacija preko interneta; iznajmljivanje kompjuterskih i postrojenja za čuvanje podataka različitih kapaciteta; pružanje, razvijanje i dizajn softvera za upravljanje kompjuterskim aplikacijama, koji se ne može preuzeti, a kojem se može pristupiti preko globalne kompjuterske mreže; dizajn, upravljanje i nadgledanje onlajn foruma za diskusiju; kreiranje internet stranica za onlajn usluge i internet, koje se čuvaju elektronski; skladištenje podataka; razrada i održavanje internet stranica za treća lica; upravljanje internet stranicama za druge; iznajmljivanje veb servera; održavanje internet stranica, usluge kreiranja i hostinga; pružanje usluga aplikacija, naime, pružanje, hosting, upravljanje, razvoj i održavanje aplikacija, softvera, internet stranica i baza podataka u oblasti elektronskog poslovanja, onlajn plaćanja, redosleda naloga, dizajna internet stranica, čuvanja podataka, prilagodavanje kapaciteta računarstva koje se može dijeliti, usluge poruka i izračunavanje rangiranja internet stranica na osnovu protoka korisnika; hosting internet stranica koje korisniku omogućavaju da ocijeni različite stampe, fotografske i grafičke slike i audio sadržaj i koristi prilagođeni sablon kako bi pružio stav, svidanje, nesvidanje, uređivanje, promjene, modifikacije, mišljenja, prijedloge i komentare i učestvovao u društvenom, poslovnom i umrežavanju u zajednici; kompjuterske usluge, naime, kreiranje onlajn zajednice za registrovane korisnike kako bi učestvovali u diskusijama, dobili povratnu informaciju od sebi jednakih, formirali virtuelne zajednice i učestvovali u društvenom umrežavanju; dizajn i razvoj kompjuterskog hardvera i softvera; dizajn i razvoj softvera za kompjuterske igre; pružanje privremene upotrebe onlajn alata za razvoj softvera, koji se ne mogu preuzeti, za dizajn i razvoj elektronskih igara; usluge tehničke podrške, naime, rješavanje problema softvera kompjuterskih igara; pružanje softverskih aplikacija koje se ne mogu preuzeti; pružanje privremene upotrebe onlajn softvera za računarstvo u oblaku, koji se ne može preuzeti, za upotrebu u elektronskom skladištenju podataka; razvoj kompjuterskog softvera u oblasti mobilnih aplikacija; pružanje usluga aplikacija, naime, hosting, upravljanje, razvoj i održavanje aplikacija, softvera i internet stranica u oblasti licne produktivnosti, bezicne komunikacije i mobilne tehnologije; naučne i tehnološke

usluge i istraživanje i dizajn s tim u vezi; industrijske analize i usluge istraživanja; pružanje informacija, konsultacija i savjetodavnih usluga u vezi sa gore navedenim.

Klasa 45: Usluge predstavljanja, društvenih mreža i upoznavanja putem interneta; pružanje kontakata i olakšavanje upoznavanja u svrhu stvaranja i razvijanja produktivnih licnih odnosa za ljude koji imaju zajedničku želju da upoznaju druge ljude sa sličnim interesovanjima; upoznavanje, lični odnos i usluge društvenih mreža koje se obezbjeđuju putem interneta iii druge računarske ili komunikacione mreže; usluge onlajn društvenih mreža, naime, olakšavanje društvenih upoznavanja ili interakcija među 739 pojedincima; usluge onlajn društvene mreže; usluge onlajn društvenog umrežavanja u oblasti zabave; usluge društvenih mreža u oblasti zabave obezbijedene putem veb stranice i komunikacionih mreža; usluge licnog konsijerza; pravne usluge; bezbjednosne usluge za zaštitu imovine i pojedinaca; obezbjeđivanje onlajn računarskih baza podataka i onlajn baza podataka koje se mogu pretraživati u oblasti društvenih mreža; obezbjeđivanje veb stranice za društvene mreže za zabavu; obezbjeđivanje usluga društvenog umrežavanja u svrhu komentaranja, uporedivanja, saradnje, konsultovanja, savjeta, diskusije, istraživanja, razmjene informacija, indeksiranja, informacija o lokaciji i zabave; usluge licne kupovine; obezbjeđivanje baze za pretragu koja sadrži audio, video i audiovizuelne sadržaje dostupne putem interneta, telekomunikacionih mreža i bezicnih telekomunikacionih mreža u oblasti onlajn društvenih mreža.

Treba da stoji.

(210) 2017-483

(442) 20.01.2019

(220) 6/12/2017

(731) Amazon Europe Core S.à.r.l., 5, Rue Plaetis, L-2338 Luxembourg, LU;

(550) I

ECHO

(540)

(740) Jusić Jasna, Dalmatinska 2, Podgorica ME

(511) **Klasa 09:** Kontrolni uređaji za kucnu automatizaciju; bežicni komunikacioni uređaji za prenos glasa, podataka iii slika; uređaji za prenos i prijem glasa i podataka; samostalni informacioni Uređaji koji se kontrolisu pomocu glasa; nezavisni glasovno-aktivirani lični (virtualni) asistenti koji integriraju usluge koje se pružaju putem aplikacija; zvcnici koji se kontrolisu pomocu glasa; aparati i instrumenti naučni, pomorski, geodetski, fotografski,

kinematografski, optički, za vaganje, mjerenje, signalizaciju, kontrolu (inspekciju), spasavanje i nastavu; aparati za snimanje, prenos i reprodukciju zvuka i slika; računске mašine; oprema za obradu podataka; kompjuteri; aparati i instrumenti za provodenje, prekid, transformaciju, akumulaciju, regulisanje i kontrolu električne energije; magnetni nosači podataka; diskovi za snimanje; kompakt diskovi, DVD i drugi digitalni nosači podataka; mehanizmi za aparate koji se pokreću novcem; računarski softver; prenosivi elektronski uređaji za prijem, prenos i čitanje teksta, slika i zvuka putem bezicnog internet pristupa; daljinski kontrolni uređaji za uređaje za snimanje; daljinski kontrolni uređaji; bežični kontrolni uređaj za daljinski nadzor i kontrolu funkcije i statusa drugih električnih, elektronskih, i mehaničkih uređaja i sistema; kompjuterski ekrani osjetljivi na dodir; digitalni audio plejeri; audio rekorderi; digitalni video plejeri; prenosivi uređaji za snimanje, prenos i reprodukciju muzike, slika i videa; elektronski aparati i instrumenti za obuku i nastavu; kamere; digitalne kamere; softver za preusmjeravanje poruka; kompjuterski hardver i softver za obradu, reprodukciju, sinhronizaciju, snimanje, organizovanje, preuzimanje, postavljanje, prenos, striming, prijem, puštanje i gledanje televizijskih emisija, filmova, teksta, slika, digitalnih medija, multimedija, audio, video i fajlova sa podacima; kompjuterski softver za pristup, nadgledanje, praćenje, pretraživanje, čuvanje i dijeljenje informacija u vezi sa temama od opšteg interesa; kompjuterski softver i periferne jedinice za personalizovano, interaktivno televizijsko (TV) programiranje; kompjuterski softver i periferni uređaji za upotrebu kod prikazivanja i manipulisanja vizuelnim medijima, grafičkim slikama, tekstovima, fotografijama, ilustracijama, digitalnim animacijama, video klipovima, filmskim snimcima i audio podacima i za upotrebu kod društvenog umrežavanja; kompjuterski programi za pristup, pregledanje i pretraživanje onlajn baza podataka; kompjuterski hardver i softver za pružanje integrirane telefonske komunikacije za kompjuterizovanim globalnim informacionim mrežama; kompjuterski softver koji se koristi za kontrolu nezavisnih glasovno-aktiviranih licnih (virtualnih) asistenata koji integrisu usluge koje se pružaju putem aplikacija; kompjuterski softver koji se koristi u vezi sa uslugama pretplate na digitalne sadržaje, osiguravanjem platforme za pretragu koje omogućavaju korisnicima da traže i primaju sadržaj digitalnih medija; kompjuterski softver za kreiranje, autorstvo, distribuciju, preuzimanje, prenos, prijem, igranje, formatiranje, editovanje, ekstrakciju, kodiranje, dekodiranje, konvertovanje, prikazivanje, skladištenje i organizaciju teksta, vizuelnih, audio i audio-vizuelnih literarnih radova, podataka, fajlova, dokumenata i elektronskih radova i multimedijalnog sadržaja; kompjuterski softver koji omogućava da se sadržaj, tekst, vizuelni, audio i audio-vizuelni radovi, literarni radovi, podaci, fajlovi, dokumenta i elektronski radovi budu preuzeti na i da im se može pristupiti na kompjuteru i drugim prenosivim elektronskim uređajima; kompjuterski softver za prenos, dijeljenje, prijem, preuzimanje, striming, prikazivanje i prebacivanje sadržaja, teksta, vizuelnih, audio i audio-vizuelnih radova, literarnih radova, podataka, fajlova, dokumenata i elektronskih radova putem prenosivih elektronskih uređaja i kompjutera i globalnih kompjuterskih i komunikacionih mreža; stereo zvučnici za ličnu upotrebu; mikrofoni; softver za prepoznavanje slova, simbola; softver za prepoznavanje glasa; softver za elektronsku poštu i poruke; kompjuterski softver za formatiranje i konvertovanje sadržaja, teksta, vizuelnih, audio i audio-vizuelnih radova, literarnih radova, podataka, fajlova, dokumenata i elektronskih radova u

format kompatibilan sa prenosivim elektronskim uređajima i kompjuterima; kompjuterski softver za upravljanje licnim informacijama i za pristup, pregledanje i pretragu audio i multimedijalnog sadržaja, igrice i softverskih aplikacija; softver za prepoznavanje glasa i glasovne komande, softver za pretvaranje govora u tekst i softverske aplikacije koje se aktiviraju putem glasa; softver koji se može preuzeti sa interneta u vidu mobilnih aplikacija za kompjutere ili druge prenosive elektronske uređaje široke potrošnje; kompjuterski softver iz oblasti prenosa i prikaza teksta, slika i zvuka.

Klasa 35: Oglašavanje; marketinške usluge i usluge oglašavanja, naime, promocija proizvoda i usluga drugih strana; usluge za realizaciju porudžbina, naime, usluge u vezi sa prijemom i obradom porudžbina; pružanje informacija o proizvodima u svrhu asistiranja pri odabiru standardne potrošačke robe, a radi zadovoljenja potreba potrošača; obezbjeđivanje usluga za optimizaciju pretraživaca; usluge uporedne kupovine, naime, promovisanje roba i usluga drugih strana; elektronsko upravljanje bazama podataka i fajlovima; kreiranje indeksa informacija, sajtova i drugih izvora dostupnih na globalnim kompjuterskim mrežama i drugim elektronskim i komunikacionim mrežama za druge; pružanje informacija o potrošačkim proizvodima u cilju odabira standardne potrošačke robe, a radi zadovoljenja specifikacija i potreba potrošača; komercijalne informacije i savjeti za potrošače, naime, pružanje mogućnosti internet korisnicima da postavljaju ocjene, napisu recenzije i preporuke za širok spektar potrošačkih proizvoda; usluge onlajn maloprodajnih objekata koje nude širok spektar potrošačke robe drugih strana; usluge maloprodajnih objekata koje nude širok spektar potrošačke robe drugih strana; maloprodajne i onlajn maloprodajne usluge u vezi sa knjigama, elektronikom, hranom, vinom i napicima, kuhinjskim 735 proizvodima, proizvodima za šišćenje, posudem za kuvanje, proizvodima za domaćinstvo, odjećom, proizvodima za ličnu njegu, proizvodima za kućne ljubimce, sportskom opremom, opremom za kampovanje, igračkama, nakitom, cvijecem, obućom i pokrivalima za glavu; vodenje poslova, poslovno upravljanje; kancelarijski poslovi; obezbjeđivanje direktorijuma za telefonske brojeve, poslovne adrese, adrese elektronske pošte, adrese internet stranica, adrese i telefonski brojevi ljudi, mjesta i organizacija.

Klasa 38: Telekomunikacione usluge; telekomunikacione usluge, naime, elektronski prenos emitovanih fajlova sa audio, vizuelnim i multimedijalnim sadržajem koji se može preuzimati putem kompjutera i drugih komunikacionih mreža; elektronski prenos poruka, glasa, podataka i slika putem globalnih komunikacionih mreža; elektronska komunikacija; elektronski prenos informacija i podataka; dostava poruka putem elektronskog prenosa; obezbjeđivanje pristupa forumima za diskusiju; obezbjeđivanje onlajn oglasnih tabli za prenos poruka među kompjuterskim korisnicima u vezi sa informacijama o potrošačkim proizvodima; audio emitovanje izgovorene riječi; audio emitovanje i prenos obrazovnih i zabavnih digitalnih medija; bezicne širokopojasne komunikacione usluge; obezbjeđivanje pristupa interaktivnoj bazi podataka za prenos poruka između kompjuterskih korisnika i pretplatnika a u vezi sa knjigama, filmovima, igranim filmovima, igrama, igračkama, sportskom opremom, elektronikom, multimedijalnim prezentacijama i drugim proizvodima za domaćinstva i potrošačkim proizvodima; obezbjeđivanje pristupa onlajn direktorijumima, bazama podataka, internet

stranicama i blogovima na temu aktuelnih događaja i onlajn referentnim materijalima; obezbjeđivanje onlajn portal i internet stranica obrazovnog i zabavnog sadržaja, naime, filmovi, televizijske emisije, audiovizuelni radovi, muzika, audio radovi, knjige, pozorišni radovi, literarni radovi, sportski događaji, rekreativne aktivnosti, slobodne aktivnosti u vidu hobija, turnira, umjetnosti, plesa, mjuzikala, kulture, sportskih i izložbi aktuelnih događaja, sportskih instrukcija, klubova, radio programa, komedija, drama, takmicenja, vizuelnih umjetničkih djela, igara, igrice, festival, muzeja, parkova, kulturnih događaja, koncerata, elektronskih editorijala, animacija, aktuelnih događaja, modnih revija, multimedijalnih prezentacija i interaktivnih edukativnih kvizova; prenos podkastova, prenos vebkastova; usluge tekstualnih i numeričkih bežičnih poruka; obezbjeđivanje onlajn mreže koja omogućava korisnicima pristup i dijeljenje sadržaja, teksta, vizuelnih, audio i audiovizuelnih radova, literarnih radova, podataka, fajlova, dokumenata i elektronskih radova; obezbjeđivanje telekomunikacionog vremenskog pristupa korisnicima komunikacionim mrežama putem identifikacije, lociranja, grupisanja, distribuiranja i upravljanja podacima i linkovima kompjuterskih servera trećih strana, kompjuterskih procesora i kompjuterskih korisnika; obezbjeđivanje kompjuterskih direktorijuma za telefonske brojeve, poslovne adrese, adrese elektronske paste, adrese internet stranica, adrese i telefonske brojeve ljudi, mjesta i organizacija; obezbjeđivanje pristupa pomocnim Uređajima iii elektronskim Uređajima u vidu obezbjeđivanja usluga telekomunikacione povezanosti za prenos slika, poruka, audio, vizuelnih i audiovizuelnih i multimedijalnih radova između čitača elektronskih knjiga, mobilnih telefona, pametnih telefona, prenosivih elektronskih Uređaja, prenosivih digitalnih Uređaja, tableta iii kompjutera; emitovanje audio, vizuelnog i audiovizuelnog materijala preko internet iii drugih kompjuterskih iii komunikacionih mreža; obezbjeđivanje onlajn saba za caskanje, internet foruma i onlajn zajednica za prenos fotografija, videa, teksta, podataka, slika i drugih elektronskih radova; obezbjeđivanje informativnih, konsultacionih i savjetodavnih usluga u vezi sa gore navedenim.

Klasa 41: Obezbjedivanje informacija koje se odnose na zabavu; izdavanje časopisa; pružanje onlajn elektronskih publikacija (koje se ne mogu preuzeti); objavljivanje elektronskih knjiga, novina; objavljivanje materijala na magnetnim ili optičkim medijima; objavljivanje muzike na mreži; pružanje informacija u oblasti zabave na mreži; obezbjeđivanje unaprijed snimljene muzike i podkastova koji se ne mogu preuzeti; pružanje edukativnih i zabavnih informacija, vijesti i komentara u oblasti aktuelnih događaja, 736 zabave, kulturnih događaja, vijesti, sparta, zabave, poslovanja i finansija, politike i javnog upravljanja, zdravlja i fizičke kondicije, vremenskih uslova, nauke i tehnologije, putovanja, umjetnosti i knjizevnosti, nacina života i licnog razvoja, prevoza robe u kopnenim i transportnim vozilima, obrazovanja i razvoja djece, nekretnina, mode i dizajna, recepata, sastojaka i kovanja, uredjenja kuce, muzike i bioskopa, istorije, medicine, prava i pružanja obrazovnih i zabavnih informacija o pravima kupaca; obezbjeđivanje internet stranice sa informacijama, audio sadržajem i publikacijama koje se odnose na zabavu; obezbjeđivanje vijesti i informacija u oblasti zabave u vezi sa informacijama, takmicenjima, tekstovima, zvukom, publikacijama koje se odnose na zabavu; konsultantske usluge u oblasti zabave i industrije zabave; pružanje informacija o zabavi, filmovima i

televizijskim emisijama preko društvenih mreža; distribucija radio zabave i interaktivnog oglašavanja; zabavne informativne usluge, naime, pružanje mogućnosti za razmjenu informacija i razgovor o širokom spektru tema putem događaja uživo i informacija putem elektronske pošte; pružanje informacija, pregleda i personalizovanih preporuka iz oblasti zabave putem globalnih komunikacionih mreža; pružanje informacija i komentara u oblasti zabave ili obrazovanja putem globalne računarske mreže, odnosno informacija u oblasti muzike, knjiga, filmova, igranih filmova, igara, igracaka, sportskih proizvoda, elektronike, multimedijalnih prezentacija i drugih proizvoda za domaćinstvo i potrošačkih proizvoda; usluge za zabavu, naime, obezbjeđivanje onlajn unaprijed snimljenih audio programa iz oblasti muzike, knjiga, filmova, igranih filmova, igara, igračaka, sportskih proizvoda, elektronike, multimedijalnih prezentacija i drugih proizvoda za domaćinstvo i potrošačkih proizvoda; usluge zabave, naime, pružanje onlajn kritika, ocjena i preporuka muzike, knjiga, filmova, igranih filmova, igara, igracaka, sportskih proizvoda, elektronike, multimedijalnih prezentacija i drugih proizvoda za domaćinstvo i potrošačkih proizvoda; usluge zabave, naime, obezbjeđivanje dijela unaprijed snimljenih audio radova putem interneta; izdavanje knjiga, časopisa, periodičnih časopisa, književnih radova, audio radova i audiovizuelnih radova; obezbjeđivanje unaprijed snimljenih audio, vizuelnih i audio-vizuelnih radova koji se ne mogu preuzimati preko bezicnih mreža; pružanje onlajn kompjuterskih igara i onlajn interaktivnih prica; obezbjeđivanje informacija, vijesti, članaka i komentara u oblasti edukacije i obrazovnih institucija; edukativne usluge u ime nastave u učionici i onlajn učenje na daljinu na temu aktuelnih događaja, obrazovanja, istorije, jezika, liberalnih umjetnosti, matematike, biznisa, nauke, hobija, tehnologije, kulture, sparta, umjetnosti, psihologije i filozofije; interaktivne obrazovne usluge u vidu instrukcija na kompjuterima ili pomoću kompjutera a na temu aktuelnih događaja, obrazovanja, istorije, jezika, liberalnih umjetnosti, književnosti, matematike, biznisa, nauke, hobija, tehnologije, kulture, sparta, umjetnosti, psihologije i filozofije; edukativne i zabavne usluge koje se odnose na podcastove, vebkastove i kontinuirane programe sa vijestima i komentarima iz oblasti muzike, audio radova, knjiga, pozorišta, književnih radova, sportskih događaja, rekreativnih aktivnosti, slobodnih aktivnosti, turnira, umjetnosti, plesa, mjuzikala, izložbi, sportske nastave, klubova, radia, komedije, takmicjenja, vizuelnih radova, igara, igrice, festivala, muzeja, parkova, kulturnih događaja, koncerata, izdavaštva, animacija, aktuelnih događaja, mode i multimedijalnih prezentacija koje su dostupne putem interneta ili drugog računara na komunikacionim mrežama; proizvodnja radio programa; radio zabave; usluge studijskog snimanja; pružanje onlajn informacija u vezi sa kompjuterskim igricama i računarskim poboljšanjima za igrice; obezbjeđivanje baze podataka za onlajn zabavu koja se može pretraživati, uključujući onlajn muziku koja se ne može preuzeti i drugi digitalni tekst, audio datoteke sa knjigama, časopisima, vijestima i informacijama; pružanje informacija, konsultantskih i savjetodavnih usluga u vezi sa gore navedenim.

Klasa 42: Obezbjeđivanje alata za pretraživanje; kompjuterske usluge, naime, daljinski hosting operativnih sistema i kompjuterskih aplikacija; hosting operativnih sistema i kompjuterskih aplikacija preko interneta; kompjutersko programiranje; konsultantske usluge u vezi sa

upravljanjem, prezentacijom i kontrolom multimedijalnih aplikacija; dizajn hardvera, softvera i kompjuterskih sistema; usluge uređivanja, ažuriranja, održavanja i podrške za softverske i kompjuterske sisteme; kompjuterske usluge u vezi sa upravljanjem, prezentacijom i kontrolom multimedijalnih aplikacija, istraživanje, upravljanje bazama podataka, upravljanje objektima, usluge podugovaranja; kompjuterske usluge, naime, hosting preko interneta onlajn baza podataka koje sadrže širok spektar informacija od opšteg interesa; kompjuterske usluge, naime, obezbjeđivanje alata za pretraživanje informacija od opšteg interesa; hosting interaktivne baze podataka za prenos poruka među kompjuterskim korisnicima i pretplatnicima; hosting interaktivne baze podataka za prenos poruka među kompjuterskim korisnicima i pretplatnicima, a u vezi sa knjigama, filmovima, igranim filmovima, televizijskim programima, igrama, igračkama, sportskom opremom, elektronskim uređajima, multimedijalnim prezentacijama i drugom potrošačkom robom i robom za domaćinstvo, ocjenama proizvoda i informacijama o kupovini na interentu; pružanje softvera onlajn internet pregledaca koji se ne može preuzeti; pružanje softvera koji se ne može preuzeti za mobilni komunikacioni uređaj za poboljšanje mobilnog pristupa internetu putem računara, mobilnih računara i mobilnih komunikacionih uređaja; tehnička podrška, naime, rješavanje problema kompjuterskog hardvera i softvera i hardverskih i softverskih problema na mobilnim računarima i mobilnim komunikacionim uređajima; konsultacije i dizajn u vezi sa kompjuterskim hardverom i softverom; dizajn kompjuterskog softvera za druge; konsultacije i dizajn u vezi sa mobilnim računarima i mobilnim komunikacionim uređajima; hosting sadržaja, fotografija, teksta, podataka, slika, internet stranica i drugih elektronskih radova za treća lica; pružanje platformi za pretragu kako bi se korisnicima omogućilo da traže i primaju fotografije, tekst, podatke, slike, elektronske radove, vizuelne radove, audio radove, audio- vizuelne radove, literarne radove i dokumenta; interaktivne hosting usluge koje dozvoljavaju korisnicima da objavljuju i dijele sopstvene fotografije, tekst, podatke i slike onlajn; održavanje i ažuriranje softvera u vezi sa računarima, internetom i sigurnošću lozinki i prevencija rizika za računare, internet i lozinke; instalacija i održavanje kompjuterskog softvera; pružanje internet stranice koja sadrži tehničke informacije u vezi sa kompjuterskim softverom i hardverom; kompjuterske konsultacije; transfer podataka iz dokumenata iz jednog kompjuterskog fermata u drugi; hosting digitalnog sadržaja na globalnim računarskim mrežama, bezicnim mrežama i mrežama elektronske komunikacije; pružanje privremene upotrebe kompjuterskog softvera i onlajn postrojenja, koji se ne mogu preuzeti, kako bi se korisnicima omogućio pristup i preuzimanje kompjuterskog softvera; pružanje privremene upotrebe kompjuterskog softvera koji se ne može preuzeti, a koji generise prilagodene preporuke softverskih aplikacija na osnovu korisničkih preferenci; pracenje kompjuterizovanih podataka i kompjuterskih sistema i mreža za sigurnosne namjene; hosting, prilagodavanje i održavanje onlajn baza podataka za druge; računarstvo u oblaku sa softverom za upotrebu u upravljanju bazama podataka; hosting elektronskih baza podataka u oblaku; pružanje usluga aplikacija (ASP) za softver za upotrebu u upravljanju bazama podataka; platforma u vidu servisa (PAAS) za kompjuterske softverske platforme za upotrebu u upravljanju bazama podataka; softver u vidu servisa (SAAS za upotrebu u upravljanju bazama podataka; softver u vidu servisa (SaaS) za pristup, monitoring, pracenje, pretragu, čuvanje i

dijeljenje informacija o temama od opšteg interesa; softver u vidu servisa (SaaS) za upravljanje licnim informacijama i za pristup, pregled i pretragu onlajn baza podataka, audio i multimedijalnog sadržaja, igara, softverskih aplikacija, tržišta softverskih aplikacija, programskih listi i vodica i videa na zahtjev; softver u vidu servisa (SaaS) koji koristi softver za glasovne komande i prepoznavanje glasa, softver za pretvaranje govora u tekst, softverske aplikacije koje se aktiviraju glasom, upravljanje licnim informacijama i softver za pristup, pregled i pretragu onlajn baza podataka, audio i multimedijalnog sadržaja, igara, softverskih aplikacija, tržišta softverskih aplikacija, programskih listi i vodica i videa na zahtjev; softver u vidu servisa (SaaS) kojim se omogućava preuzimanje 738 i pristup na računaru ili drugom nosivom potrošačkom elektronskom Uređaju audio i multimedijalnih datoteka; softver u vidu servisa (SaaS) za mobilne Uređaje kojim se korisniku dozvoljava da pretražuje sadržaj Uređaja radi informacija, kontakata i aplikacija; softver u vidu servisa (SaaS) za kreiranje indeksa informacija, internet stranica i drugih informativnih resursa; softver u vidu servisa (SaaS) za glasovne komande i prepoznavanje glasa; softver u vidu servisa (SaaS) za kontrolu pametnih audio zvučnika; softver u vidu servisa (SaaS) za upotrebu u vezi sa uslugama pretplate na digitalne sadržaje; softver u vidu servisa (SaaS) za kreiranje, autorstvo, distribuciju, preuzimanje, prenošenje, primanje, reprodukciju, uređivanje, izvlačenje, kodiranje, dekodiranje, prikazivanje, čuvanje i organizaciju audio i multimedijalnog sadržaja; pružanje platformi za pretragu kako bi se korisnicima omogućilo da traže i primaju digitalni medijski sadržaj i aplikacije; pružanje privremene upotrebe onlajn softvera i aplikacija koji se ne mogu preuzeti za pristup strimingu audio i video datoteka, igrama, društvenim mrežama, tekstualnim i multimedijalnim datotekama; kompjuterske usluge, naime, pružanje servera baza podataka različitih kapaciteta drugima; pružanje internet stranica na kojima se nalazi softver za upravljanje bazama podataka koji se ne može preuzeti; pružanje operativnih sistema i kompjuterskih aplikacija preko interneta; iznajmljivanje kompjuterskih i postrojenja za čuvanje podataka različitih kapaciteta; pružanje, razvijanje i dizajn softvera za upravljanje kompjuterskim aplikacijama, koji se ne može preuzeti, a kojem se može pristupiti preko globalne kompjuterske mreže; dizajn, upravljanje i nadgledanje onlajn foruma za diskusiju; kreiranje internet stranica za onlajn usluge i internet, koje se čuvaju elektronski; skladištenje podataka; razrada i održavanje internet stranica za treća lica; upravljanje internet stranicama za druge; iznajmljivanje veb servera; održavanje internet stranica, usluge kreiranja i hostinga; pružanje usluga aplikacija, naime, pružanje, hosting, upravljanje, razvoj i održavanje aplikacija, softvera, internet stranica i baza podataka u oblasti elektronskog poslovanja, onlajn plaćanja, redosleda naloga, dizajna internet stranica, čuvanja podataka, prilagodavanje kapaciteta računarstva koje se može dijeliti, usluge poruka i izračunavanje rangiranja internet stranica na osnovu protoka korisnika; hosting internet stranica koje korisniku omogućavaju da ocijeni različite stampe, fotografske i grafičke slike i audio sadržaj i koristi prilagođeni sablon kako bi pružio stav, svidanje, nesvidanje, uređivanje, promjene, modifikacije, mišljenje, prijedloge i komentare i učestvovao u društvenom, poslovnom i umrežavanju u zajednici; kompjuterske usluge, naime, kreiranje onlajn zajednice za registrovane korisnike kako bi učestvovali u diskusijama, dobili povratnu informaciju od sebi jednakih, formirali virtuelne zajednice i učestvovali u društvenom umrežavanju; dizajn i razvoj kompjuterskog hardvera i

softvera; dizajn i razvoj softvera za kompjuterske igre; pružanje privremene upotrebe onlajn alata za razvoj softvera, koji se ne mogu preuzeti, za dizajn i razvoj elektronskih igara; usluge tehničke podrške, naime, rješavanje problema softvera kompjuterskih igara; pružanje softverskih aplikacija koje se ne mogu preuzeti; pružanje privremene upotrebe onlajn softvera za računarstvo u oblaku, koji se ne može preuzeti, za upotrebu u elektronskom skladištenju podataka; razvoj kompjuterskog softvera u oblasti mobilnih aplikacija; pružanje usluga aplikacija, naime, hosting, upravljanje, razvoj i održavanje aplikacija, softvera i internet stranica u oblasti licne produktivnosti, bezicne komunikacije i mobilne tehnologije; naučne i tehnološke usluge i istraživanje i dizajn s tim u vezi; industrijske analize i usluge istraživanja; pružanje informacija, konsultacija i savjetodavnih usluga u vezi sa gore navedenim.

Klasa 45: Usluge predstavljanja, društvenih mreža i upoznavanja putem interneta; pružanje kontakata i olakšavanje upoznavanja u svrhu stvaranja i razvijanja produktivnih licnih odnosa za ljude koji imaju zajedničku zelju da upoznaju druge ljude sa slicnim interesovanjima; upoznavanje, lični odnos i usluge društvenih mreža koje se obezbjeđuju putem interneta iii druge računarske ili komunikacione mreže; usluge onlajn društvenih mreža, naime, olakšavanje društvenih upoznavanja ili interakcija među 739 pojedincima; usluge onlajn društvene mreže; usluge onlajn društvenog umrežavanja u oblasti zabave; usluge društvenih mreža u oblasti zabave obezbijedene putem veb stranice i komunikacionih mreža; usluge licnog konsijerza; pravne usluge; bezbjednosne usluge za zaštitu imovine i pojedinaca; obezbjeđivanje onlajn računarskih baza podataka i onlajn baza podataka koje se mogu pretraživati u oblasti društvenih mreža; obezbjeđivanje veb stranice za društvene mreže za zabavu; obezbjeđivanje usluga društvenog umrežavanja u svrhu komentarisanja, uporedivanja, saradnje, konsultovanja, savjeta, diskusije, istraživanja, razmjene informacija, indeksiranja, informacija o lokaciji i zabave; usluge licne kupovine; obezbjeđivanje baze za pretragu koja sadrži audio, video i audiovizuelne sadržaje dostupne putem interneta, telekomunikacionih mreža i bezicnih telekomunikacionih mreža u oblasti onlajn društvenih mreža.

DIZAJN

DESIGNS

MEĐUNARODNI KODOVI ZA IDENTIFIKACIJU BIBLIOGRAFSKIH PODATAKA O DIZAJNU PREMA WIPO CT.80 RECOMMENDATION CONCERNING BIBLIOGRAPHIC DATA RELATING TO INDUSTRIJAL DESIGNS WIPO CT.80

CRNOGORSKI	MDK	ENGLESKI
Registarski broj	11	Number of registration
Datum registracije	15	Date of the registration
Očekivani datum isteka registracije	18	Expected expiration date of the registration
Broj prijave	21	Number of the application
Datum podnošenja prijave	22	Date of filing of the application
Podaci o izložbenom pravu prvenstva	23	Exhibition priority data
Broj prijavljenih dizajna	28	Number of industrial designs included in the application
Podaci o pravu prvenstva na osnovu Pariske konvencije	30	Data relating to priority under the Paris Convention
Klasa i podklasa Lokarnske klasifikacije	51	Class and subclass of the Locarno Classification
Naziv dizajna	54	Title of the industrial design
Prikaz	55	Reproduction of the industrial design (e.g., drawing, photograph) and explanations relating to the reproduction
Ime autora dizajna	72	Name of the creator
Ime i adresa nosioca prava	73	Name and address of the owner
Ime i adresa punomoćnika	74	Name and address of the representative

OBJAVA DIZAJNA
PUBLICATION OF INDUSTRIAL DESIGN

(11)	00143
(15)	11.11.2019.
(18)	28.12.2022.
(21)	D-2017-4
(28)	1
(22)	28.12.2017.
(51)	03-03
(54)	PAMETNI SUNCOBRAN

(55)



1.1



1.2



1.3

(72)	Nenad Novović, Jovana Cvijića 3, Podgorica
(73)	Amplitudo d.o.o., Bulevar Svetog Petra Cetinjskog 56, 81000 Podgorica

15	30.10.2019.
18	12.01.2023.
21	D-2018-1
28	2
22	12.01.2018.
30	Pravo prvenstva od 13.07.2017. godine po osnovu prijave industrijskog dizajna broj 29/610,630 SAD, za prvi predmet zaštite i pravo prvenstva od 14.07.2017. godine po osnovu prijave industrijskog dizajna broj 29/610,688 SAD za drugi predmet zaštite.
51	01-06
54	GRANULE ZA ŽIVOTINJE

Prikaz 55

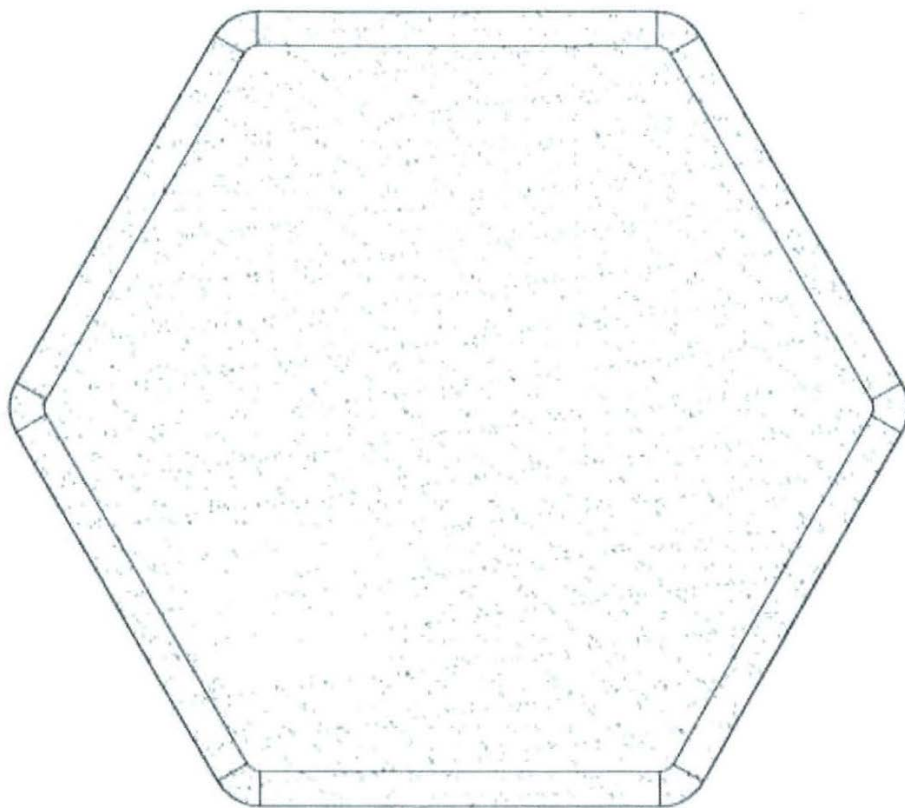

1.1

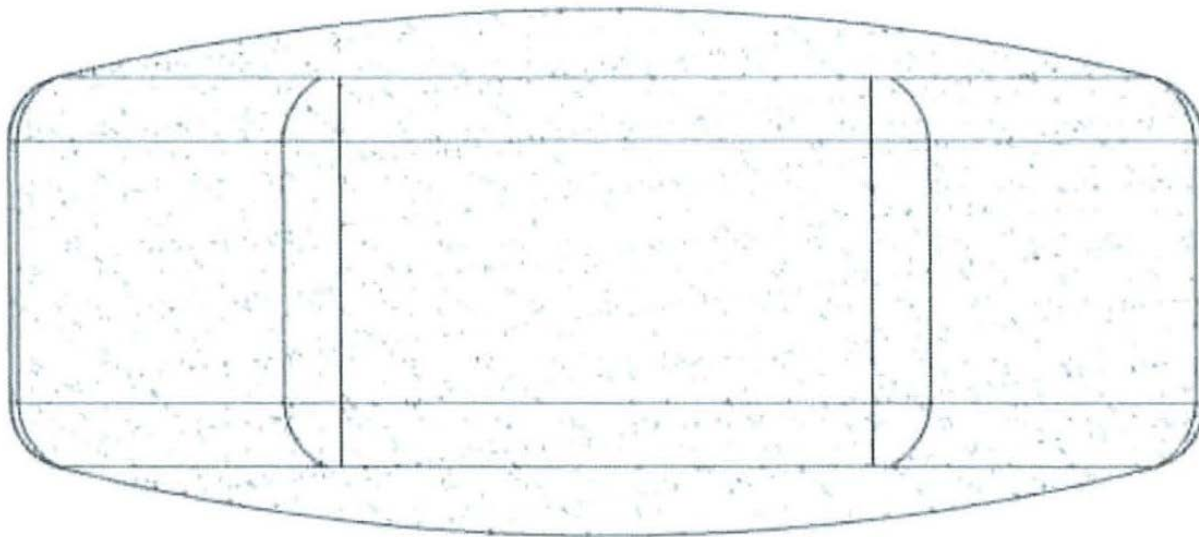

1.2

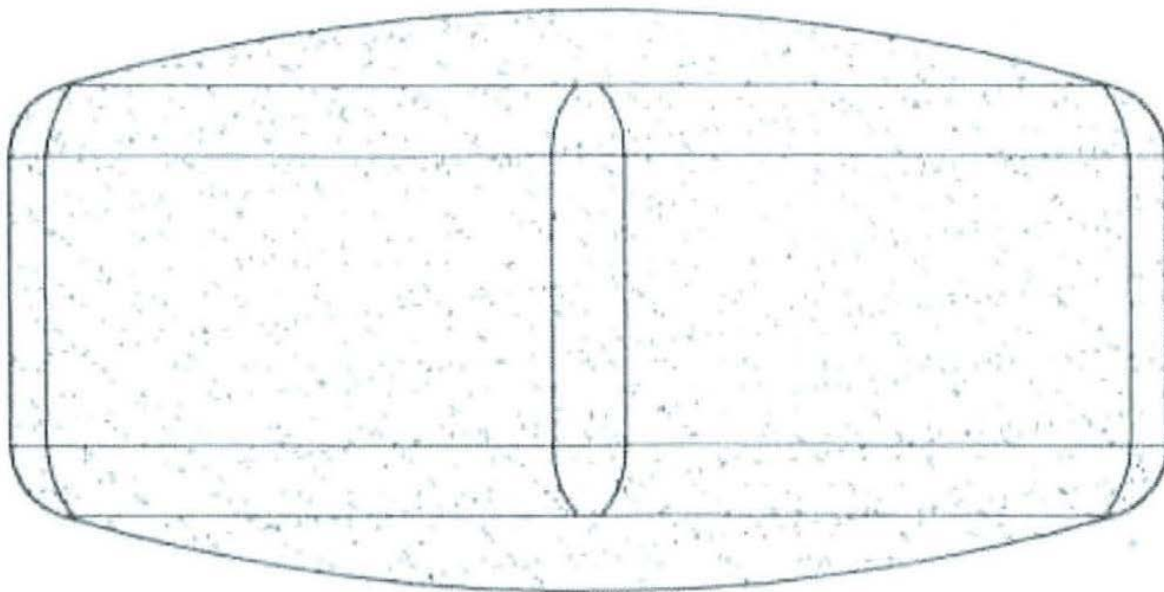

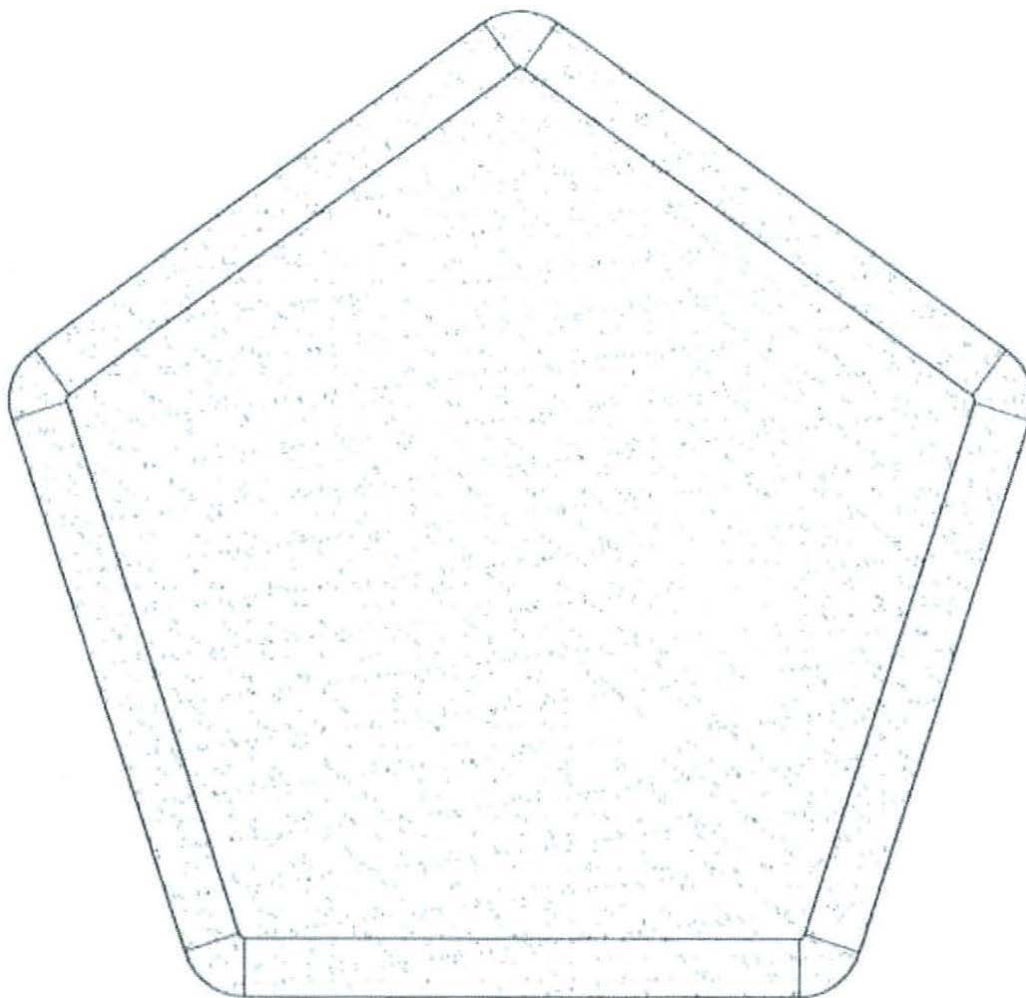

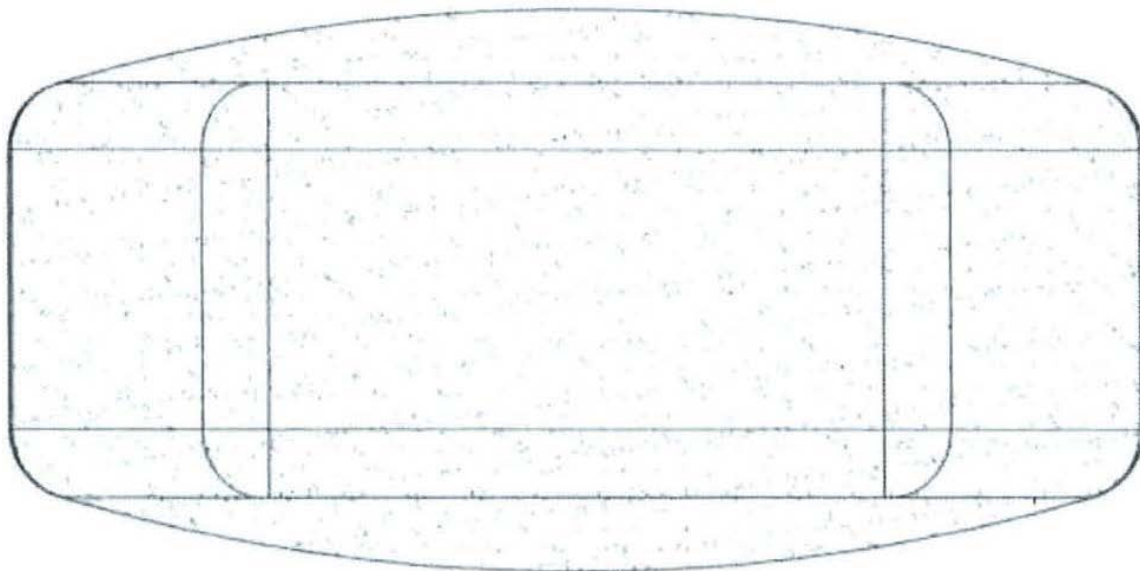

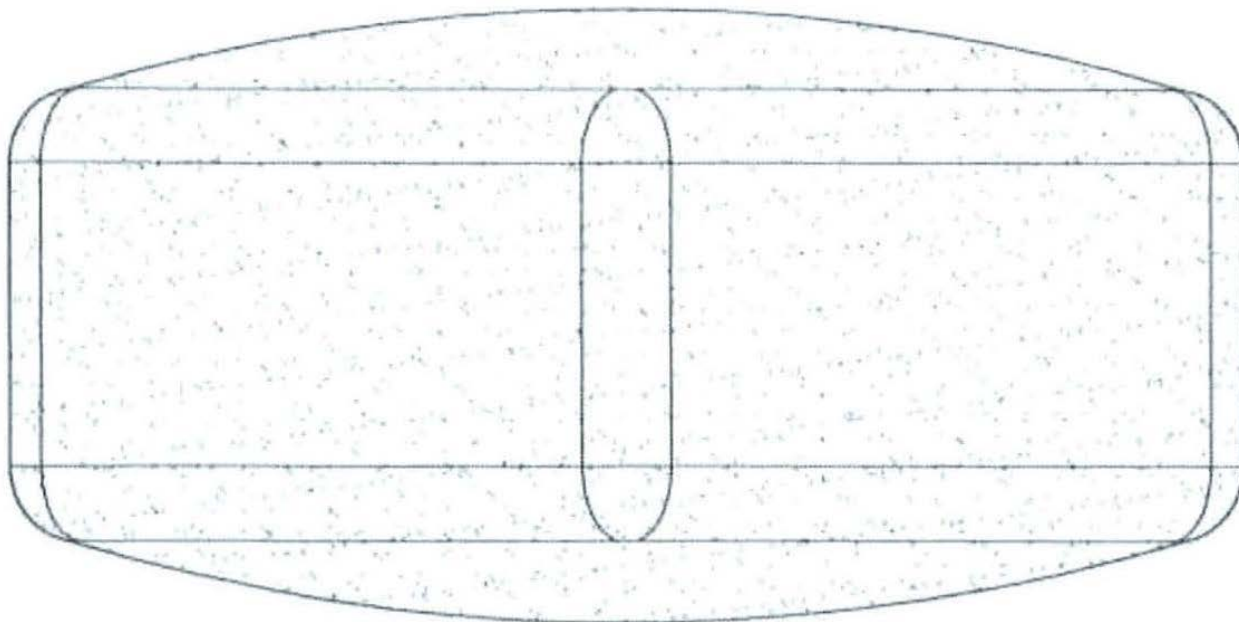

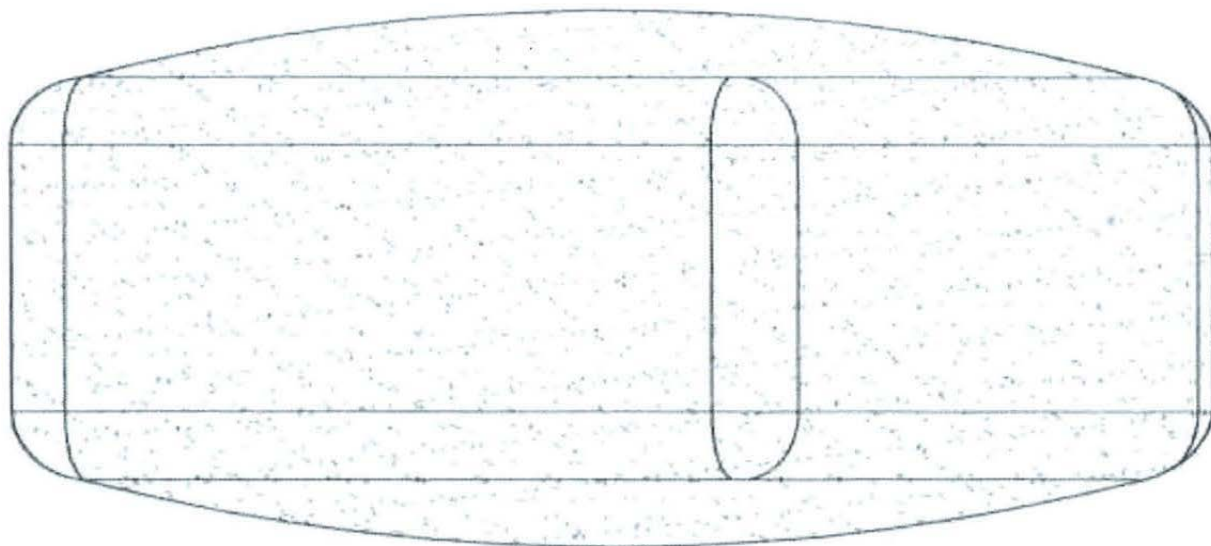

72	de Boer, Sanne Kirsten, 3001 Deming Way, 53562 Middleton, Wisconsin, U.S.A.
73	Spectrum Brands, Inc., 3001 Deming Way, 53562 Middleton, Wisconsin, U.S.A.
74	Jasna Jusić, Dalmatinska broj 2, Podgorica (ME)

11	00144
----	-------

15	11.11.2019.
18	13.03.2023
21	D-2018-2
28	1
22	13.03.2018.
30	
51	25-02
54	TENDA (NADSTREŠNICA)

Prikaz 55

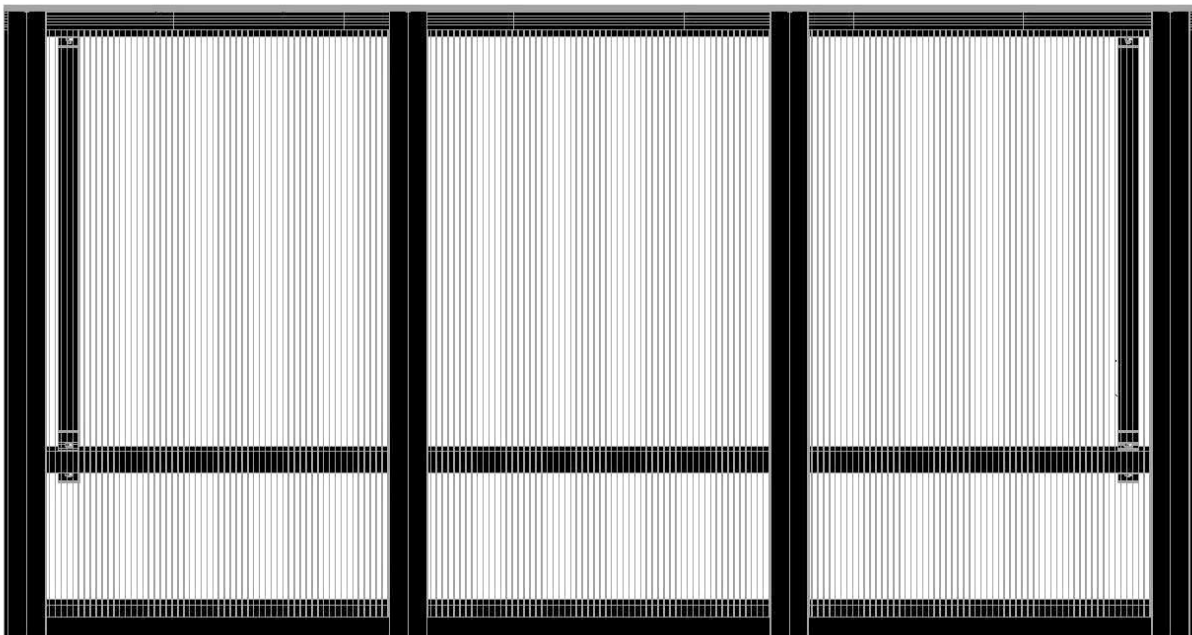

1.1

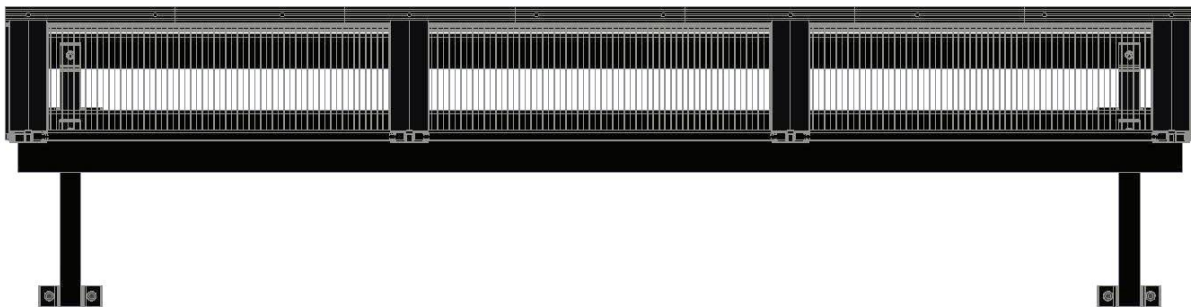

1.2

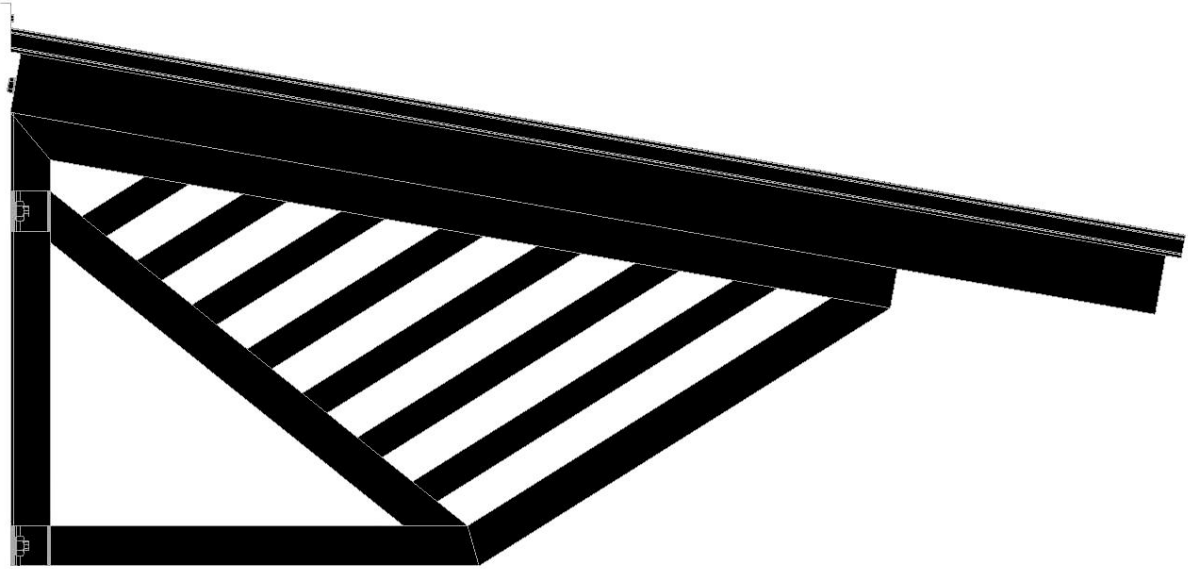

1.3



1.4

72	Dušan Lakovića, Lekići, bb, 81000 Podgorica.
73	Dušan Lakovića, Lekići, bb, 81000 Podgorica

11	00140
----	-------

15	28.10.2019.
18	06.06.2023.
21	D-2018-3
28	1
22	06.06.2018.
30	Pravo prvenstva od 08.12.2017.godine po osnovu prijave industrijskog dizajna broj 2017-027542, Japan.
51	15-01
54	Motor sa unutrašnjim sagorijevanje

Prikaz 55



1.1



1.2

825

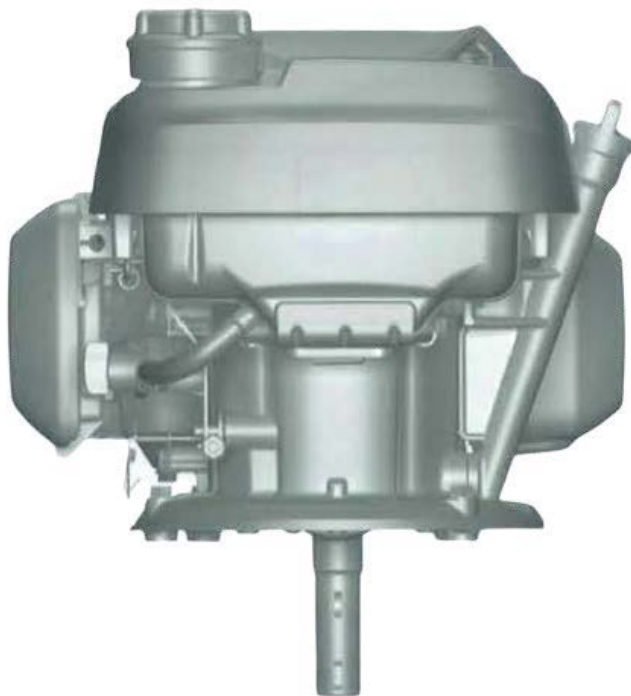

1.3.

826





1.5

828



72	<ol style="list-style-type: none"> 1. Koichi AZUMA, c/o HONDA R&D CO., LTD.,4-1, Chuo 1-chome, Wako-shi, Saitama, 351-0193 Japan; 2. Kazuo MIYAMOTO, c/o HONDA R&D CO., LTD.,4-1, Chuo 1-chome, Wako-shi, Saitama, 351-0193 Japan.
73	HONDA MOTOR Co., Ltd. of 1-1, Minami-Aoyama 2-Chome, Minato-ku, Tokyo, 107-8556 Japan
74	Branislav V. Lutovaca Bulevar Ivana Crnojevića 93, Podgorica; (ME)

11	00141
----	-------

15	28.10.2019.
18	26.06.2023.
21	D-2018-4
28	1
22	26.06.2018.
30	Pravo prvenstva od 28.12.2017. godine po osnovu prijave industrijskog dizajna broj 2017-029562, Japan.
51	12-06
54	VANBRODSKI MOTOR ZA PLOVILO

Prikaz 55



1.1







1.5

834



72	1. NAKAURA, So, c/o HONDA R&D CO., LTD., 4-1, Chuo 1-chome, Wako-shi, Saitama, 351-0193 JP; 2. FUJIWARA, Masato, c/o HONDA R&D CO., LTD.,4-1, Chuo 1-chome, Wako-shi, Saitama, 351-0193 JP.
73	Honda Motor Co., Ltd. 1-1, Minami-Aoyama 2-Chome, Minato-ku, Tokyo, 107-8556 Japan
74	Branislav V. Lutovaca Bulevar Ivana Crnojevića 93, Podgorica; (ME)

OBJAVA UPISA PROMJENA U REGISTAR INDUSTRIJSKOG DIZAJNA
PUBLICATION OF RECORD OF CHANGES TO THE INDUSTRIAL DESIGN

OBNOVA VAŽENJA INDUSTRIJSKOG DIZAJNA

Registarski broj dizajna (11)	Ime i adresa nosioca industrijskog dizajna (73)	Datum do kojeg važi obnova industrijskog dizajna (18)
00023	Sony Computer Entertainment Inc., 2-6-21, Minami-Aoyama, Minato-ku, Tokyo 107-0062, Japan	10.11.2024. godine
00022	Sony Computer Entertainment Inc., 2-6-21, Minami-Aoyama, Minato-ku, Tokyo 107-0062, Japan	10.11.2024. godine
00065	Mars, Incorporated, 6885 Elm Street, McLean, VA 22101-3883, U.S.A	24.12.2024. godine
00067	CASTROL LIMITED, Wakefield House, Pipers Way, Swindon, Wiltshire SN3 1RE, United Kingdom,	26.03.2025. godine
000116	Dušan Laković, Lekići bb, Podgorica	24.12.2024. godine

000117	Dušan Laković, Lekići bb, Podgorica	24.12.2024. godine
--------	--	---------------------------

PROMJENA ADRESE INDUSTRIJSKOG DIZAJNA

Reg. broj dizajna (11)	Promjena	Stari podatak	Novi podatak
00067	Promjena adrese	Wakefield House, Pipers Way, Swindon, Wiltshire SN3 1RE, United Kingdom	Technology Centre, Whitchurch Hill, Pangbourne, Reading RG8 7QR, UK.

CIP - Каталогизација у публикацији
Централна народна библиотека Црне Горе, Цетиње
347.77/78(497.16)
CRNOGORSKI glasnik intelektualne svojine : Službeni glasnik
Ministarstva ekonomije Crne Gore = Official Gazete of the
Ministry of economy of Montenegro / glavni i odgovorni
urednik
Biljana Jakić - 2020, br.33 - 618. - Podgorica
(Bulevar Mihaila Lalića br. 1) : Ministarstvo ekonomije, 2020. -
30 cm
Tromjesečno.
ISSN 1800-8003 = Crnogorski glasnik intelektualne svojine
(Podgorica)
COBISS.CG-ID 15168784