

ISSN 1800-8003

**CRNOGORSKI
GLASNIK
INTELEKTUALNE
SVOJINE**

INTELLECTUAL PROPERTY GAZETTE OF MONTENEGRO

37/2021

Službeni glasnik intelektualne svojine Crne Gore
Official Gazette of the Montenegrin Intellectual Property

MINISTARSTVO EKONOMSKOG RAZVOJA
Bulevar Mihaila Lalića broj 1
Podgorica
Crna Gora

CRNOGORSKI GLASNIK INTELEKTUALNE SVOJINE

Godina XI

Datum objavljivanja 20.01.2021.

Izdavač:

MINISTARSTVO EKONOMSKOG RAZVOJA

Bulevar Mihaila Lalića broj 1

Podgorica

Crna Gora

Za izdavača:

mr Jakov Milatović

Glavni i odgovorni urednik:

Dragana Ranitović

Urednički odbor:

Vesna Nikčević

Lidija Martić

Marko Perišić

Tehnički urednik:

Milica Petrović Njegoš

Crnogorski glasnik intelektualne svojine službeno je glasilo za intelektualnu svojinu Crne Gore. U Glasniku se objavljuju sve relevantnim zakonima i pravilnicima propisane informacije iz postupka dodjele prava industrijskog vlasništva, informacije o dodijeljenim pravima te o kasnijim promjenama u vezi s tim pravima, kao i ostale službene informacije.

The Montenegrin intellectual property gazette is the official gazette of the Intellectual Property of the Montenegro. The Gazette publishes all the information, prescribed by the relevant laws and regulations, relating to the industrial property granting procedure concerning granted rights and subsequent changes made in connection with such right, as well as other official information.

SADRŽAJ / CONTENTS

DVOSLOVNE OZNAKE ZEMALJA, TERITORIJA I MEĐUNARODNIH ORGANIZACIJA / Two letter code countries, territories and international organizations5

PATENTI / PATENTS

MEĐUNARODNI KODOVI ZA IDENTIFIKACIJU BIBLIOGRAFSKIH PODATAKA O PATENTIMA PREMA WIPO STANDARDU ST. 9 / Recommendation concerning bibliographic data on and relating to patents- wipo-st. 97

OBJAVA PROŠIRENIH EVROPSKIH PATENATA / Publication of extended european patents8

OBJAVA UPISA PROMJENA / Publication of record of changes101

OBJAVA ZAHTJEVA ZA PROŠIRENJE EVROPSKIH PRIJAVA PATENATA / Publication of request for the extension of the effects of european patent applications104

INDEKS BROJEVA ZAHTJEVA ZA PROŠIRENJE EVROPSKIH PRIJAVA PATENTA / Index on number of requests for extension on european patent application.....250

INDEKS KLASIFIKACIONIH OZNAKA ZAHTJEVA ZA PROŠIRENJE EVROPSKIH PRIJAVA PATENTA PREMA MEĐUNARODNOJ KLASIFIKACIJI PATENATA / Index on classification marks on requests for extension of european patent application in accordance with the international patent classification298

INDEKS PODNOSILACA ZAHTJEVA ZA PROŠIRENJE EVROPSKIH PRIJAVA PATENTA / Index on number of applications for extension of european patent application360

ŽIGOVÍ / TRADEMARKS

MEĐUNARODNI KODOVI ZA IDENTIFIKACIJU BIBLIOGRAFSKIH PODATAKA O ŽIGOVIMA PREMA WIPO ST 60 / Recommendation concerning bibliographic data relating to trademarks- wipo-st.....430

OBJAVA PRIJAVA ŽIGOVA / Publication of trademark applications432

OBJAVA ŽIGOVA / Publication of trademarks523

INDUSTRIJKI DIZAJN / INDUSTRIAL DESIGN

MEĐUNARODNI KODOVI ZA IDENTIFIKACIJU BIBLIOGRAFSKIH PODATAKA O DIZAJNU PREMA WIPO ST 80 / Recommendation concerning bibliographic data relating to industrial design- wipo-st. 80747

OBJAVA DIZAJNA / Publication of industrial design.....748

**OBJAVE OBNOVE VAŽENJA INDUSTRIJSKOG DIZAJNA / Publication of industrial design
renewal814**

DVOSLOVNE OZNAKE ZEMALJA, TERITORIJA I MEĐUNARODNIH ORGANIZACIJA

Two letter code countries, territories and international organizations

AD Andora	CF Centralna Afrička Republika	GB Velika Britanija
AE Ujedinjeni Arapski Emirati	CG Kongo	GC Patentna kancelarija Savjeta za saradnju država Arapskog Zaliva (GCC)
AF Afganistan	CH Švajcarska	GD Grenada
AG Antigva i Barbuda	CI Obala Bjelokosti	GE Gruzija
AI Angvila	CK Kukova ostrva	GG Guernsey
AL Albanija	CL Čile	GH Gana
AM Armenija	CM Kamerun	GI Gibraltar
AN Holandski Antili	CN Kina	GL Grenland
AO Angola	CO Kolumbija	GM Gambija
AP Afrička regionalna organizacija za industrijsko vlasništvo (ARIPO)	CR Kostarika	GN Gvineja
AR Argentina	CU Kuba	GQ Ekvatorska Gvineja
AT Austrija	CV Kabo Verde	GR Grčka
AU Australija	CY Kipar	GS Južna Džordžija i Ostrva Južni Sendvič
AW Aruba	CZ Češka Republika	GT Gvatemala
AZ Azerbejdžan	DE Njemačka	GW Gvineja-Bisao
BA Bosna i Hercegovina	DJ Džibuti	GY Gvajana
BB Barbados	DK Danska	HK Hongkong – Posebna administrativna regija
BD Bangladeš	DM Dominika	NR Kine
BE Belgija	DO Dominikanska Republika	HN Honduras
BF Burkina Faso	DZ Alžir	HR Hrvatska
BG Bugarska	EA Evroazijska patentna organizacija (EAPO)	HT Haiti
BH Bahrein	EC Ekvador	HU Mađarska
BI Burundi	EE Estonija	IB Međunarodna kancelarija Svjetske organizacije za intelektualno vlasništvo (WIPO)
BJ Benin	EG Egipat	ID Indonezija
BM Bermudi	EH Zapadna Sahara	IE Irska
BN Brunej Darussalam	EM Kancelarija za harmonizaciju Unutrašnjeg tržišta (žigovi i dizajn) (OHIM)	IL Izrael
BO Bolivija	EP Evropska patentna kancelarija (EPO)	IM Ostrvo Man
BR Brazil	ER Eritreja	IN Indija
BS Bahami	ES Španija	IQ Irak
BT Butan	ET Etiopija	IR Iran (Islamska Republika)
BV Ostrvo Buve	FI Finska	IS Island
BW Bocvana	FJ Fidži	IT Italija
BX Kancelarija za intelektualno vlasništvo Beneluksa (BOIP)	FK Foklandska ostrva (Malvini)	JE Džersi
BY Bjelorusija	FO Farska Ostrva	JM Jamajka
BZ Belize	FR Francuska	JO Jordan
CA Kanada	GA Gabon	
CD Demokratska Republika Kongo		

JP Japan
KE Kenija
KG Kirgistan
KH Kambodža
KI Kiribati
KM Komori
KN Sveti Kristofor i Nevis
KP Demokratska Narodna Republika Koreja
KR Republika Koreja
KW Kuvajt
KY Kajmanska Ostrva
KZ Kazahstan
LA Narodna Demokratska Republika Laos
LB Libanon
LC Sveta Lucija
LI Lihtenštajn
LK Šri Lanka
LR Liberija
LS Lesoto
LT Litva
LU Luksemburg
LV Latvija
LY Libijska Arapska Džamahirija
MA Maroko
MC Monako
MD Republika Moldavija
ME Crna Gora
MG Madagaskar
MK Sjeverna Makedonija
ML Mali
MM Mianmar
MN Mongolija
MO Makao
MP Sjeverna Marijanska Ostrva
MR Mauritanija
MS Montserrat
MT Malta
MU Mauricijus
MV Maldivi
MW Malavi
MX Meksiko
MY Malezija
MZ Mozambik
NA Namibija
NE Niger
NG Nigerija
NI Nikaragva
NL Holandija
NO Norveška
NP Nepal
NR Nauru
NZ Novi Zeland
OA Afrička organizacija za intelektualno vlasništvo (OAPI)
OM Oman
PA Panama
PE Peru
PG Papuanska Nova Gvineja
PH Filipini
PK Pakistan
PL Poljska
PT Portugal
PW Palau
PY Paragvaj
QA Katar
QZ Kancelarija Zajednice za biljne sorte (Evropska Unija) (CPVO)
RO Rumunija
RS Srbija
RU Ruska Federacija
RW Ruanda
SA Saudijska Arabija
SB Solomonska Ostrva
SC Sejšeli
SD Sudan
SE Švedska
SG Singapur
SH Sveta Jelena
SI Slovenija
SK Slovačka
SL Sijera Leone
SM San Marino
SN Senegal
SO Somalija
SR Surinam
ST Sveti Toma i Princip
SV Salvador
SY Sirijska Arapska Republika
SZ Svazi
TC Turska i Kajkoska Ostrva
TD Čad
TG Togo
TH Tajland
TJ Tadžikistan
TL Istočni Timor
TM Turkmenistan
TN Tunis
TO Tonga
TR Turska
TT Trinidad i Tobago
TV Tuvalu
TW Tajvan, Kineska Pokrajina
TZ Ujedinjena Republika Tanzanija
UA Ukrajina
UG Uganda
US Sjedinjene Američke Države
UY Urugvaj
UZ Uzbekistan
VA Sveta Stolica (Vatikan)
VC Sveti Vincent i Grenadini
VE Venecuela
VG Britanska Djevičanska Ostrva
VN Vijetnam
VU Vanuatu
WO Svjetska organizacije za intelektualno vlasništvo (WIPO) (Međunarodna kancelarija)
WS Samoa
XN Nordijski institut za patente (NPI)
YE Jemen
ZA Južnoafrička Republika
ZM Zambija
ZW Zimbabve



PATENTI

PATENTS

MEĐUNARODNI KODOVI ZA IDENTIFIKACIJU BIBLIOGRAFSKIH PODATAKA O PATENTIMA PREMA WIPO STANDARDU ST. 9

**Reccommendation concerning bibliographic data on and relating to patents-
wipo-st. 9**

CRNOGORSKI	MDK	ENGLESKI
IDENTIFIKATOR DOKUMENTA	10	IDENTIFICATION OF THE PATENT
BROJ DOKUMENTA	11	NUMBER OF THE PATENT
VRSTA DOKUMENTA	13	KIND-OF-DOCUMENT CODE ACCORDING TO WIPO STANDARD
BROJ PRIJAVE	21	NUMBER(S) ASSIGNED TO THE APPLICATION(S)
DATUM PODNOŠENJA PRIJAVE	22	DATE(S) OF FILING THE APPLICATION(S)
DATUM IZLAGANJA NA MEĐUNARODNOJ IZLOŽBI	23	DATE OF EXHIBITING AT THE INTERNATIONAL EXIBITION
PODACI O PRAVU PRVJENSTVA	30	PRIORITY DATA
DATUM OBJAVLJIVANJA PRIJAVE	43	PUBLICATION DATE OF THE UNEXAMINED APPLICATION
DATUM OBJAVLJIVANJA PATENTA	45	PUBLICATION DATE OF REGISTERED PATENT
MEĐUNARODNA KLASIFIKACIJA PATENATA	51	INTERNATIONAL PATENT CLASSIFICATION CODE
NAZIV PRONALASKA	54	TITLE OF THE INVENTION
APSTRAKT ILI PATENTNI ZAHTJEV	57	ABSTRACT OR CLAIM
BROJ OSNOVNE PRIJAVE (ILI PATENTA) ZA KOJI SE PODNOŠI DOPUNSKA PRIJAVA	61	NUMBER OF THE EARLIER APPLICATION (OR PATENT) TO WHICH THE PRESENT DOCUMENT IS AN ADDITION
BROJ PRVOBITNE PRIJAVE IZ KOJE JE PRIJAVA IZDVOJENA	62	NUMBER OF THE EARLIER APPLICATION FROM WHICH THE PRESENT DOCUMENT HAS BEEN DIVIDED UP
IME PODNOSIOCA PRIJAVE	71	NAME OF THE APPLICANT
IME PRONALAZAČA	72	NAME OF THE INVENTOR
IME NOSIOCA PATENTA	73	NAME OF THE OWNER OF PATENT
IME PUNOMOĆNIKA	74	NAME OF THE REPRESENTATIVE
BROJ I DATUM PODNOŠENJA MEĐUNARODNE PRIJAVE	86	NUMBER AND FILING DATE OF THE INTERNATIONAL APPLICATION
BROJ I DATUM MEĐUNARODNE OBJAVE	87	NUMBER AND DATE OF THE PUBLICATION OF THE INTERNATIONAL APPLICATION

OBJAVA PROŠIRENIH EVROPSKIH PATENATA
Publication of extended european patents

(11) **03717** (13) **B**

(51) **C12G 1/032**^(2006.01)

(21) P-2019-123

(22) 05.02.2016

(30) UB20155643 17.11.2015 IT

(96) 16154548.8/05.02.2016

(97) EP 3170887/24.05.2017/2017/21

EP 3170887/03.04.2019/2019/14

(54) me **POBOLJŠANI FERMENTER**
en **IMPROVED FERMENTER**

(73) Castle Commercial Enterprises Limited

Harcourt Centre Block 3 Harcourt Road, Dublin 2/ IE

(72) MARIN, Francesco

VIA SAN FRANCESCO 1/A, 33097 SPILIMBERGO, PORDENONE/ IT

(57)

1. Fermenter za fermentaciju rastvora, koji sadrži: sud (2) predodređen da sadrži rastvor (3) koji treba fermentisati, i opremljen sa ulaznim otvorom {4,33} i izlaznim otvorom (5, 25); cevovod za recirkulaciju pumpanjem (100) obezbeđen sa prvim spojem (101), koji je postavljen u vezu sa donjom zonom posude (2), i otvorom za dispenzovanje (l 03), postavljenim u gornjoj zoni posude (2) tako da bude sposoban da isporučuje tečnost iznad gornjeg nivoa rastvora (3); naznačen time što cevovod za recirkulaciju pumpanjem (l OO) sadrži drugi spoj (l 02), postavljen u središnji položaj između prvog spoja (l O l) i otvora za dispenzovanje (l 03), pri čemu je taj otvor za dispenzovanje (l 03) tako raspoređen da dozvoli da se gas uvede u cevovod za recirkulaciju pumpanjem (l OO).

Patent sadrži još 20 patentnih zahtjeva

(11) **036700** (13) **B**

(51) **C07D 253/08**^(2006.01)

A61K 31/53^(2006.01)

(21) P-2019-184

(22) 19.11.2015

(30) 201462082539 P 20.11.2014 US

201562184729 P 25.06.2015 US

(96) 15816275.0/19.11.2015

(86) US PCT/US2015/061607/19.11.2015

(87) WO 2016/081736/26.05.2016/2016/21

(97) EP 3221298/27.09.2017/2017/39

EP 3221298/03.04.2019/2019/14

(54) me **DERIVATI 4-OKSO-3,4 - DIHIDRO-1, 2, 3-BENZOTRIAZINA KAO MODULATORI GPR139**
en **4-OXO-3,4-DIHYDRO-1,2,3-BENZOTRIAZINES DERIVATIVES AS MODULATORS OF**
GPR139

(73) Takeda Pharmaceutical Company Limited

1-1 Doshomachi 4-chome Chuo-ku, Osaka-shi, Osaka 541-0045/ JP

(72) HITCHCOCK, Stephen

c/o Takeda California, Inc. 10410 Science Center Drive, San Diego, California 92121/ US

LAM, Betty

c/o Takeda California Inc. 10410 Science Center Drive, San Diego, California 92121/ US

MONENSCHEIN, Holger

c/o Takeda California Inc. 10410 Science Center Drive, San Diego, California 92121/ US

REICHARD, Holly

c/o Takeda California Inc. 10410 Science Center Drive, San Diego, California 92121/ US

(57)

1. Jedinjenje formule 2:

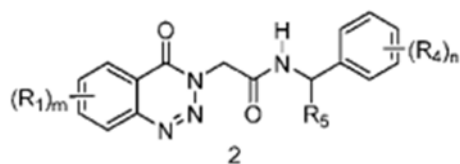

ili njegova farmaceutska prihvatljiva so, gde je

m izabran iz 0, 1 i 2;

n izabran iz 0, 1 i 2;

svaki R1 nezavisno izabran iz grupe koju čine cijano, halo, hidroksi, amino, C1-4 alkil, C1-4 alkoksi, trifluorometil i trifluorometoksi;

svaki R4 nezavisno izabran iz grupe koju čine cijano, halo, hidroksi, amino, C1-4 alkil, C1-4 alkoksi, trifluorometil i fluorometoksi, difluorometoksi i trifluorometoksi; i

R5 je izabran iz grupe koju čine vodonik, trifluorometil i C1-4alkil; s time da:

(a) ukoliko je R5 vodonik, metil, n-propil, i-propil ili i-butil, onda m i n nisu oba 0;

(b) ukoliko je R5 vodonik, m je 0, i n je 1, onda R4 nije hloro, metoksi, 3-trifluorometil, 4-trifluorometil, 4-metil, 4-fluoro, 2-difluorometoksi, 3-difluorometoksi, 2-trifluorometoksi, 4-trifluorometoksi ili 2-(i-butoksi);

(c) ukoliko je R5 metil, m je 0, i n je 1, onda R4 nije hlora, 2-fluoro, 4-fluoro, 2-bromo, 4-etil, 2-metil, 4-(i-propil), 4-(i-butil) ili 3-trifluorometil;

(d) ukoliko je R5 etil, m je 0, i n je 1, onda R4 nije 3- hlora, 4- hlora, 4-bromo, 4-metil, 4-metoksi ili 2-difluorometoksi;

(e) ukoliko je R5 n-propil, m je 0, i n je 1, onda R4 nije 3-trifluorometil;

(f) ukoliko je R5 i-propil, m je 0, i n je 1, onda R4 nije 4-fluoro ili 4-metoksi;

(g) ukoliko je R5 i-butil, m je 0, i n je 1, onda R4 nije 3-trifluorometil;

(h) ukoliko je R5 vodonik, m je 0, i n je 2, onda R4 nije 2,6-difluoro, 2,4-dihloro, 3,5-dimetoksi, 3,4-dimetoksi, 4-metoksi-3-difluorometoksi, 4-fluoro-2-trifluorometil ili 5-bromo-2-difluorometoksi; i

(i) ukoliko je R5 metil, m je 0, i n je 2, onda R4 nije 3,4-dimetil, 3,4-dihloro, 2,4-dihloro, 3-fluoro-4-metoksi, 3-bromo-4-metoksi, 3-metoksi-4-izopropiloksi ili 3-metoksi-4-izobutiloksi.

Patent sadrži još 35 patentnih zahtjeva

(11) **03718** (13) **B**

(51) **A61K 31/42**^(2006.01)

(21) P-2019-188

(22) 09.06.2017

(30) PCT/EP2016/063368 10.06.2016 WO

(96) 17735004.8/09.06.2017

(86) EP PCT/EP2017/064206/09.06.2017

(87) WO 2017/212061/14.12.2017/2017/50

(97) EP 3307267/18.04.2018/2018/16

EP 3307267/10.04.2019/2019/15

(54) me **LEČENJE MULTIPLE SKLEROZE**
en **MULIPLE SCLEROSIS TREATMENT**

(73) Oryzon Genomics, S.A.

Carrera de San Jerónimo 15 2nd floor, 28014 Madrid/ ES

(72) MAES, Tamara

Oryzon Genomics S.A. Sant Ferran 74, 08940 Cornellà De Llobregat/ ES

MASCARÓ CRUSAT, Cristina

Oryzon Genomics S.A. Sant Ferran 74, 08940 Cornellà De Llobregat/ ES

ROTLLANT POZO, David

Oryzon Genomics S.A. Sant Ferran 74, 08940 Cornellà De Llobregat/ ES

(57)

1. Jedinjenje koje je (-) 5-(((trans)-2-(4-(benziloksi)fenil)ciklopropil)amino)metil)-1,3,4- oksadiazol-2-amin ili farmaceutski prihvatljiva so ili solvat tog jedinjenja za primenu u lečenju multiple skleroze.

Patent sadrži još 7 patentnih zahtjeva

(11) **03711 (13) B**

(51) **A61K9/20**^(2006.01)

A61K31/138^(2006.01)

A61K31/4422^(2006.01)

(21) P-2019-217

(22) 30.09.2009

(30) 20080000591 30.09.2008 HU

(96) 09748467.9/30.09.2009

(86) HU PCT/HU2009/000085/30.09.2009

(87) WO 2010/038091 A2/08.04.2010/2010/14

(97) EP 2344141/20.07.2011/2011/29

EP 2344141/01.05.2019/2019/18

(54) me **JEDINJENJA KOJA SADRŽE AMLODIPIN 1 BISOPROLOL**
en **COMPOSITIONS COMPRISING AMLODIPINE AND BISOPROLOL**

(73) Egis Gyógyszergyár Zrt.

Keresztúri út 30-38, Budapest, 1106/ HU

(72) WAGNER, László

XI. utca 36, Budapest, 1172 / HU

ZSIGMOND, Zsolt

Mátyás király u. 67, Maglód, 2234 / HU

MEDEK, Ales

14 Lockland Road, Winchester, MA 01890/ US

LEVENTISZSNÉ HUSZÁR, Magdolna

Virányos út 24/a, Budapest, 1125/ HU

TONKA-NAGY, Péter

Ököl u. 4/b 9, Budapest, 1171/ HU

BÁRCZAY, Erzsébet

Bökényföldi u. 23, Budapest, 1165/ HU

GÓRA, Lászlóné

Gyöngyvirág u. 3, Isaszeg, 2117 / HU

SZELECZKI, Edit

Osztály u. 6-10/D I.2, H-1165 Budapest/ HU

FÜLÖP, Ágnes

Szilágyi Dezső u. 87, H-1174 Budapest/ HU

(57)

1. Stabilno čvrsto farmaceutsko jedinjenje koje sadrži homogenizovanu praškastu smešu baze amlodipina ili farmaceutske njihove prihvatljive soli i bisoprolol fumarat i farmaceutske prihvaćeni ekscipijenti pakovani u pakovanju otpornom na vlagu i koje sadrži manje od 0,5% jedinjenja formule

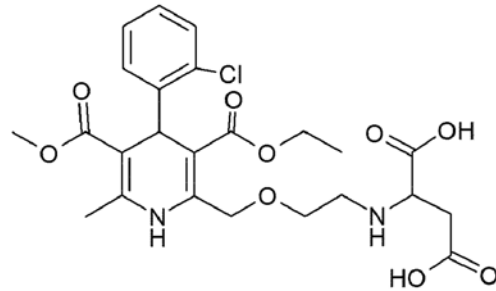

3

na osnovu težine aktivnih sastojaka, pri čemu jedinjenje dalje sadrži organsko ili neorgansko punilo, dezintegrant, lubrikant i opciono vezivno sredstvo.

Patent sadrži još 13 patentnih zahtjeva

(11) **03703 (13) B**

(51) **C07D 487/04**^(2006.01)
A61K 31/407^(2006.01)

C07D 519/00^(2006.01)
A61K 7/00^(2006.01)

(21) P-2019-249

(22) 20.03.2018

(30) 201762473751 ? 20.03.2017 US

(96) 18716455.3/20.03.2018

(86) US PCT/US2018/023405/20.03.2018

(87) PCT/US2018/023405/27.09.2018/2018/39

(97) EP 3 448 859/06.03.2019/2019/10

EP 3 448 859/10.07.2019/2019/28

(54) me **KOMPOZICIJE PIROLOPIROLA KAO AKTIVATORI PIRUVAT KINAZE (PKR)**
en **PYRROLOPYRROLE COMPOSITIONS AS PYRUVATE KINASE (PKR) ACIVATORS**

(73) WATSON, Daniel John

c/o Array BioPharma Inc. 3200 Walnut Street, Boulder, Colorado 80301/ US

(72) ERICSSON, Anna

c/o Forma Therapeutics Inc. 500 Arsenal Street Suite 100, Watertown, Massachusetts 02472/ US
GREEN, Neal

c/o Forma Therapeutics Inc. 500 Arsenal Street Suite 100, Watertown, Massachusetts 02472/ US
GUSTAFSON, Gary

c/o Forma Therapeutics Inc. 500 Arsenal Street Suite 100, Watertown, Massachusetts 02472/ US
HAN, Bingsong

c/o Forma Therapeutics Inc. 500 Arsenal Street Suite 100, Watertown, Massachusetts 02472/ US
LANCIA, David R.

500 Arsenal St., Suite 100, Watertown, MA 02472/ US

MITCHELL, Lorna

c/o Forma Therapeutics Inc. 500 Arsenal Street Suite 100, Watertown, Massachusetts 02472/ US
SHELEKHIN, Tatiana

c/o Forma Therapeutics Inc. 500 Arsenal Street Suite 100, Watertown, Massachusetts 02472/ US
WANG, Zhongguo

c/o Forma Therapeutics Inc. 500 Arsenal Street Suite 100, Watertown, Massachusetts 02472/ US
ZHENG, Xiaozhang

c/o Forma Therapeutics Inc. 500 Arsenal Street Suite 100, Watertown, Massachusetts 02472/ US
SMITH, Chase C.

c/o Forma Therapeutics Inc. 500 Arsenal Street, Suite 100, Watertown, Massachusetts 02472/ US
WANG, Zhongguo

c/o Forma Therapeutics Inc. 500 Arsenal Street, Suite 100, Watertown, Massachusetts 02472/ US

(57)

1. Jedinjenje izabrano iz grupe koja se sastoji od:

Primer struktura

Naziv

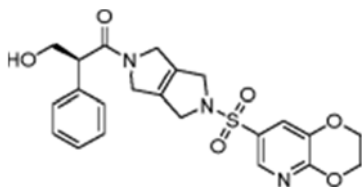

(S)-1-(5-((2,3-dihidro-[1,4]dioksino[2,3-b]piridin-7-il)sulfonil)-3,4,5,6-tetrahidropirol[3,4-c]pirol-2(1H)-il)-3-hidroksi-2-fenilpropan-1-on

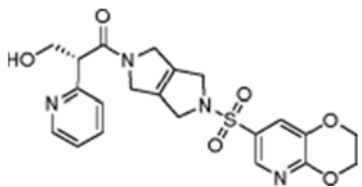

(R)-1-(5-((2,3-dihidro-[1,4]dioksino[2,3-b]piridin-7-il)sulfonil)-3,4,5,6-tetrahidropirol[3,4-c]pirol-2(1H)-il)-3-hidroksi-2-(piridin-2-il)propan-1-on

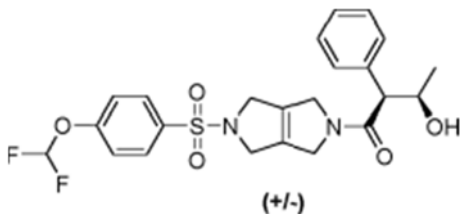

(2S,3R i 2R,3S)-1-(5-((4-(difluorometoksi)fenil)sulfonil)-3,4,5,6-tetrahidropirol[3,4-c]pirol-2(1H)-il)-3-hidroksi-2-fenilbutan-1-on

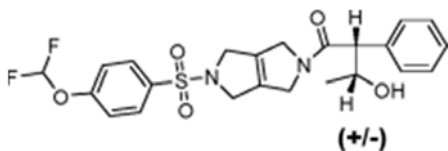

(2R,3R i 2S,3S)-1-(5-((4-(difluorometoksi)fenil)sulfonil)-3,4,5,6-tetrahidropirol[3,4-c]pirol-2(1H)-il)-3-hidroksi-2-fenilbutan-1-on

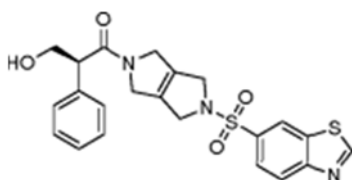

(S)-1-(5-(benzo[d]tiazol-6-ilsulfonil)-3,4,5,6-tetrahidropirol[3,4-c]pirol-2(1H)-il)-3-hidroksi-2-fenilpropan-1-on

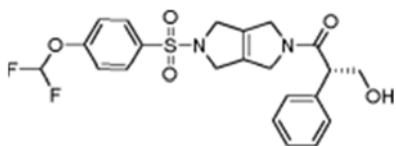

(S)-1-(5-((4-(difluorometoksi)fenil)sulfonil)-3,4,5,6-tetrahidropirol[3,4-c]pirol-2(1H)-il)-3-hidroksi-2-fenilpropan-1-on

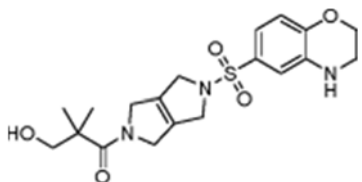

1-(5-((3,4-dihidro-2H-benzo[b][1,4]oksazin-6-il)sulfonil)-3,4,5,6-tetrahidropirol[3,4-c]pirol-2(1H)-il)-3-hidroksi-2,2-dimetilpropan-1-on

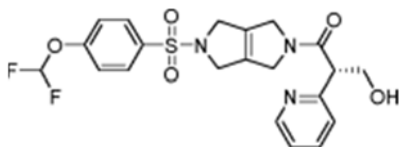

(S)-1-(5-((4-(difluorometoksi)fenil)sulfonyl)-3,4,5,6-tetrahidropiolo[3,4-c]pirol-2(1H)-il)-3-hidroksi-2-(piridin-2-il)propan-1-on

(nastavak)

Primjer strukture

Naziv

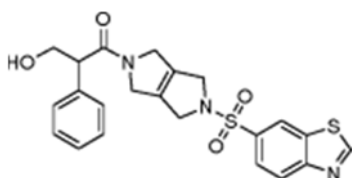

1-(5-(benzo[d]tiazol-6-ilsulfonyl)-3,4,5,6-tetrahidropiolo[3,4-c]pirol-2(1H)-il)-3-hidroksi-2-fenilpropan-1-on

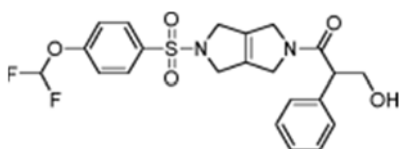

1-(5-((4-(difluorometoksi)fenil)sulfonyl)-3,4,5,6-tetrahidropiolo[3,4-c]pirol-2(1H)-il)-3-hidroksi-2-fenilpropan-1-on

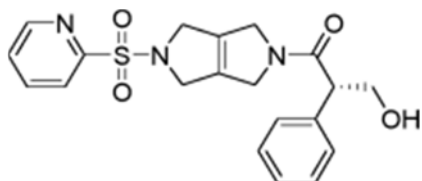

(2S)-3-hidroksi-2-fenil-1-[5-(piridin-2-sulfonyl)-1H,2H,3H,4H,5H,6H-piolo[3,4-c]pirol-2-il]propan-1-on

Ili njegovih farmaceutske prihvatljivih soli.

Patent sadrži još 11 patentnih zahtjeva

(11) **03712 (13) B**

(51) **C07K 16/28**^(2006.01)

A61P 17/06^(2006.01)

(21) P-2019-250

(22) 14.11.2012

(30) 201161560554 P 16.11.2011 US

201261644111 P 08.05.2012 US

201261713713 P 15.10.2012 US

(96) 12788410.4/14.11.2012

(86) US PCT/US2012/064933/14.11.2012

(87) WO 2013/074569/23.05.2013/2013/21

(97) EP 2780373/24.09.2014/2014/39

EP 2780373/21.08.2019/2019/34

(54) me **ANTI IL-36R-ANTITELA**
en **ANTI IL-36R ANTIBODIES**

(73) Boehringer Ingelheim International GmbH

Binger Strasse 173, Ingelheim am Rhein, 55216/ DE

(72) BROWN, Su-Ellen

Boehringer Ingelheim USA Corp. c/o VP IP Legal 900 Ridgebury Road P.O. Box 368, Ridgefield,
Connecticut 06877-0368/ US

CANADA, Keith

Boehringer Ingelheim USA Corp. c/o VP IP Legal 900 Ridgebury Road P.O. Box 368, Ridgefield,
Connecticut 06877-0368/ US

CHLEWICKI, Lukasz

Boehringer Ingelheim USA Corp. c/o VP IP Legal 900 Ridgebury Road P.O. Box 368, Ridgefield,
Connecticut 06877-0368/ US

HOWELL, Michael

Boehringer Ingelheim USA Corp. c/o VP IP Legal 900 Ridgebury Road P.O. Box 368, Ridgefield,
Connecticut 06877-0368/ US

MENNERICH, Detlev

Boehringer Ingelheim GmbH Corporate Patents Binger Strasse 173, 55216 Ingelheim am Rhein/ DE

WOSKA JR., Joseph Robert

Boehringer Ingelheim USA Corp. c/o VP IP Legal 900 Ridgebury Road P.O. Box 368, Ridgefield,
Connecticut 06877-0368/ US

(57)

1. Anti-IL-36R antitijelo ili njegov antigenski vezujući fragment koji sadrži:

a) varijabilni region lakog lanca koji sadrži amino kiselinsku sekvencu SEQ ID NO: 80,

b) varijabilni region teškog lanca koji sadrži amino kiselinsku sekvencu SEQ ID NO: 87, SEQ ID NO: 88
ili SEQ ID NO: 89.

Patent sadrži još 22 patentnih zahtjeva

(11) **03704 (13) B**

(51) **C07D 471/04**^(2006.01)

C07D 473/38^(2006.01)

A61K 31/4162^(2006.01)

C07D 473/34^(2006.01)

C07D 487/04^(2006.01)

A61K 31/52^(2006.01)

(21) P-2019-351

(22) 17.12.2014

(30) 20130197986 18.12.2013 EP

(96) 14823973.4/17.12.2014

(86) EP PCT/EP2014/078288/17.12.2014

(87) WO 2015/091685/25.06.2015/2015/25

(97) EP 3083617/26.10.2016/2016/43

EP 3083617/11.09.2019/2019/37

(54) me **DERIVATI IZOHROMENA KAO INHIBITORI FOSFOINOZITIDNIH 3-KINAZA**
en **ISOCHROMENE DERIVATIVES AS PHOSPHOINOSITIDE 3-KINASES INHIBITORS**

(73) Chiesi Farmaceutici S.p.A.

Via Palermo 26/A, Parma, 43100 / IT

(72) BIAGETTI, Matteo

Via Palermo 26/A, I-43100 Parma / IT

CAPELLI, Anna Maria

Via Palermo 26/A, I-43100 Parma / IT

ACCETTA, Alessandro

Via Palermo 26/A, I-43100 Parma / IT

CARZANIGA, Laura

Via Palermo 26/A, I-43100 Parma / IT

(74) Advokat RADULOVIĆ, Božidar S.

Baku 30/5, Podgorica, 81000 / ME

(57)

1. Jedinjenje formule (I):

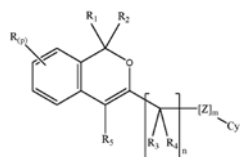

(I)

pri čemu:

svaki R, kada je prisutan, je nezavisno izabran iz grupe koja se sastoji od:

- OR₆;

- SR₆

- S(O)_q-R₈

- NR₁₀R₁₁

- halogena
- (C1-C6) alkila;
- (C1-C6) haloalkila;
- (C3-C7) cikloalkila;
- (C5-C7) cikloalkenila;
- (C2-C6) alkenila;
- (C2-C6) alkinila;
- supstituisanog ili nesupstituisanog arila; i
- supstituisanog ili nesupstituisanog heteroarila;

R1 i R2 su kombinovani da formiraju okso grupu (= O);

R3 i R4, su isti ili različiti, u svakom slučaju su nezavisno izabrani iz grupe koja se sastoji od:

- H;
- (C1-C6) alkila; i
- (C1-C6) haloalkila;

R5 je izabran iz grupe koja se sastoji od:

- (C3-C7) cikloalkila;
- aril (C1-C3) alkila;
- (C5-C7) cikloalkenila;
- supstituisanog ili nesupstituisanog (C3-C6) heterocikloalkila
- supstituisanog ili nesupstituisanog arila; i
- supstituisanog ili nesupstituisanog heteroarila;

R6 je izabran iz grupe koja se sastoji od:

- H;
- (C1-C6) alkila;
- (C1-C6) haloalkila;
- (C1-C6) hidroksialkila;
- (C1-C6) aminoalkila;
- aril(C1-C6)alkila
- (C1-C6) alkanoila
- arilkarbonila; i
- aril (C2-C4) alkanoila

R8 je izabran iz grupe koja se sastoji od:

- (C1-C6) alkila;
- (C1-C6) haloalkila;
- (C1-C6) hidroksialkila;
- (C1-C6) aminoalkila;
- supstituisanog ili nesupstituisanog arila;
- supstituisanog ili nesupstituisanog heteroarila; i
- NR12R13

R10, R11, R12 i R13, isti ili različiti, svaki put su nezavisno izabrani iz grupe koja se sastoji od H, (C1-C6) aminoalkila, (C1-C6) hidroksialkila i (C1-C6) alkila, ili uzeti zajedno sa atomom azota na koji su oni povezani, ili R10 i R11 ili R12 i R13 mogu formirati, 5 do 6-člani heterociklični radikal, pri čemu najmanje jedan dalji atom ugljenika u prstenu u pomenutom heterocikličnom radikalu može biti zamenjen sa N, NH,

S ili O ili može da nosi-okso supstituentnu grupu, i pomenuti heterociklični radikal može biti dalje opciono supstituisan;

Z, kada je prisutan, je atom ili grupa svaki put nezavisno izabrana od NH i NHC (O);

m je 1;

n je 1 ili 2;

p je nula ili ceo broj u rasponu od 1 do 3;

q je 1 ili 2;

Cy je heteroaril izabran iz grupe koja se sastoji od 7H-purin-7-il; 9H-purin-9-il; 9H-purin-6-il; 1H-pirazolo[3,4-d]pirimidin-1-il; 1H-pirazolo[3,4-d]pirimidin-4-il; 2H-pirazolo[3,4-d]pirimidin-2-il; 2-, 4-, 5- ili 6-pirimidinila; i 2-pirazinila, pirolo[2,3-d]pirimidin-7-il, pirazolo[1,5-a]pirimidin-3-il, pirido[3,2-d]pirimidin-4-il, pirido[2,3-d]pirimidin-8-il-5-on, tieno[3,2-d]pirimidin-4-il, tieno[2,3-d]pirimidin-4-il koji su svi opciono supstituisani sa jednom ili više grupa izabranih od halogena, (C1-C6)alkila, (C1-C6)haloalkila, CN, NR10R11, opciono supstituisanog arila i opciono supstituisanog heteroarila izabranog od fenila, 1H-indazol-4-il, 1H-indazol-5-il, 1H-indazol-6-il, 2-, 3-, 4-, 5-, 6-piridinila, pirazol-3-il, pirazol-4-il, pirazol-5-il, pirazin-2-il, pirimidin-5-il, piridazin-4-il i 2-, 4-, 5-tiazolila;

ili, kada

m je nula;

n je 1 ili 2;

p je nula ili ceo broj u rasponu od 1 do 3;

q je 1 ili 2;

potom, Cy je heteroaril izabran iz grupe koja se sastoji od 7H-purin-7-il, 9H-purin-9-il, 1H-pirazolo[3,4-d]pirimidin-1-il, 2H-pirazolo[3,4-d]pirimidin-2-il, pirolo[2,3-d]pirimidin-7-il, i pirido[2,3-d]pirimidin-8-il-5-on, koji su svi opciono supstituisani sa jednom ili više grupa izabranih od halogena, (C1-C6)alkila, (C1-C6)haloalkila, CN, NR10R11, opciono supstituisanog arila i opciono supstituisanog heteroarila izabranog od fenila, 1H-indazol-4-il, 1H-indazol-5-il, 1H-indazol-6-il, 2-, 3-, 4-, 5-, 6-piridinila, pirazol-3-il, pirazol-4-il, pirazol-5-il, pirazin-2-il, pirimidin-5-il, piridazin-4-il i 2-, 4-, 5-tiazolila;

ili farmaceutski prihvatljivih soli od njih.

Patent sadrži još 13 patentnih zahtjeva

(11) **03659** (13) **B**

(51) **C07D 211/90**^(2006.01)

A61K 31/435^(2006.01)

A61P 9/12^(2006.01)

(21) P-2019-352

(22) 24.02.2006

(30) 20050656836P 25.02.2005 US

(96) 06723128.2/24.02.2006

(86) EP PCT/EP2006/001782/24.02.2006

(87) WO 2006/089787/31.08.2006/2006/35

(97) EP 1856051/21.11.2007/2007/41

EP 1856051/13.11.2019/2019/46

(54) me **AMORFNI LERKANIDIPIN HIDROHLORID**

en **AMORPHOUS LERCANIDIPINE HYDROCHLORIDE**

(73) Recordati Ireland Limited

Raheens East, Ringaskiddy, County Cork/ IE

RECORDATI INDUSTRIA CHIMICA E FARMACEUTICA S.p.a.

Via Matteo Civitali, 1, 20148 Milano/ IT

(72) LEONARDI, Amedeo

Via Poliziano 16, I-20154 Milano/ IT

MOTTA, Gianni

Via Ungaretti, 10, I-20030 Barlassina / IT

BERLATI, Fabio

Via Aldo Moro 9, I-20017 Rho / IT

(74) Advokat RADULOVIĆ, Božidar S.

Baku 30/5, Podgorica, 81000 / ME

(57)

1. Amorfni lerkanidipin hidrohlorid čistoće od najmanje 99.5% određene HPLC analizom i koji sadrži manje od 0.5% kristalnog lerkanidipin hidrohlorida.

Patent sadrži još 2 patentnih zahtjeva

(11) **03705** (13) **B**

(51) **A61K 31/506**^(2006.01)

A61K 39/395^(2006.01)

A61K 39/00^(2006.01)

A61K 45/06^(2006.01)

C07K 16/28^(2006.01)

A61P 35/00^(2006.01)

(21) P-2019-354

(22) 10.08.2016

(30) 20150382425 11.08.2015 EP

201662335984P 13.05.2016 US

(96) 16766384.8/10.08.2016

(86) IB PCT/IB2016/054834/10.06.2016

(87) WO 2017/025918/16.02.2017/2017/07

(97) EP 3334431/20.06.2018/2018/25

EP 3334431/25.09.2019/2019/39

(54) me **5-BROMO-2,6-DI-(1H-PIRAZOL-1-IL)PIRIMIDIN-4-AMIN ZA UPOTREBU PRI LIJEČENJU RAKA**

en **5-BROMO-2,6-DI-(1H-PYRAZOL-L-YL)PYRIMIDIN-4-AMINE FOR USE IN THE TREATMENT OF CANCER**

(73) Novartis AG

Lichtstrasse 35, Basel, 4056/ CH

Palobiofarma, S.L.

Avenida Ernest Lluch 32, TCM2-0207, 08302 Mataro, Barcelona, 08302 / ES

(72) BILIC, Sanela

One Health Plaza , East Hanover, New Jersey 07936-1080 / US

CAMACHO GOMEZ, Juan Alberto

Avenida Ernest Luch 32 TCM2-0207 , 08302 Mataro (Barcelona)/ ES

CAMERON, John Scott

220 Massachusetts Avenue, Cambridge, Massachusetts 02139 / US

CASTRO-PALOMINO LARIA, Julio Cesar

Avenida Ernest Luch 32 TCM2-0207 , 08302 Mataro (Barcelona) / ES

HOWARD, JR., Danny Roland

One Health Plaza , East Hanover, New Jersey 07936-1080 / US

(74) Advokat JUSIĆ, Jasna
Dalmatinska 2, Podgorica, 81000 / ME

(57)

1. Kombinovani proizvod koji obuhvata jedinjenje iz formule (I):

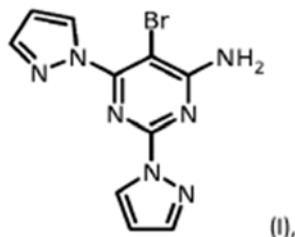

ili njegovu farmaceutski prihvatljivu so ili kokristal, i jedan ili više imunoterapijskih agenasa izabranih iz grupe koja obuhvata anti-CTLA4 antitelo, anti-PD-1 antitelo i anti-PD-L1 antitelo.

Patent sadrži još 16 patentnih zahtjeva

(11) **03706** (13) **B**

(51) **A61K 9/00**^(2006.01)

A61K 31/606^(2006.01)

A61K 47/36^(2006.01)

A61K 9/28^(2006.01)

A61K 47/32^(2006.01)

(21) P-2019-355

(22) 29.04.2013

(30) 20120166110 30.04.2012 EP
201261640217P 30.04.2012 US

(96) 13723033.0/29.04.2013

(86) EP PCT/EP2013/058923/29.04.2013

(87) WO 2013/164316/07.11.2013/2013/45

(97) EP 2844222/11.03.2015/2015/11
EP 2844222/13.11.2019/2019/46

(54) me **FORMULACIJA LIJEKA SA ODLOŽENIM OTPUŠTANJEM**
en **A DELAYED RELEASE DRUG FORMULATION**

(73) TILLOTTS PHARMA AG

Baslerstrasse 15, Rheinfelden, 4310/ CH

(72) BRAVO GONZÁLEZ, Roberto Carlos
Lindenstrasse 6, Binningen, CH-4102 / CH

BUSER, Thomas

Gempenstrasse 19, Nuglar, CH-4412/ CH

GOUTTE, Frédéric Jean-Claude

4 rue du Ried, Schwoben, F-68130/ FR

BASIT, Abdul, Waseh

55 Alicia Gardens, Harrow, Middlesex HA3 8JB/ GB

VARUM, Felipe, José, Oliveria

Efringerstrasse 86, Basel, CH-4057/ CH
FREIRE, Ana, Cristina
92 West Cotton Close, Riverside Wharf, Northampton NN4 8BY/ GB
(74) Advokat RAIČEVIĆ, Dejan
Vojvode Boža 1, Cetinje , 81250 / ME

(57)

1. Formulacija lijeka sa odloženjm oslobadanjem za oralnu primjenu da bi se lijek isporučio kolonu subjekta, pri čemu navedena formulacija sadrži:
jezgro j premaz za jezgro, jezgro koje sadrži lijek i obloga koja sadrži spoljašnji i unutrašnji sloj, pri čemu navedenij spoljnij sloj sadrži prvi poljmerij materijal podložan napadnja kolonskih bakterija j drugij poljmerij materijal koj jma prag pH na pH 6 ili iznad, i navedeni unutrašnji sloj sadrži treći polimernij materijal koj j rastvorljiv u crevnoj tečnosti ili gastrointestinalnim tečnostima, pomenuti treći poljmerij materijal kao poljmer poljkarboksilne kiseljne koj j delimično neutralizovan sa najmanje 10% iz grupe karboksilne kiseline u obliku karboksilatnih aniona, pri čemu se spoljnij sloj nanosi direktno na unutrašnji sloj pomoću premaza formiranog iz prvog navedenog polimernog materijala u vodenom medijumu sa navedenim drugim poljmerij materijalom u organskom medijumu.

Patent sadrži još 21 patentnih zahtjeva

(11) **03707** (13) **B**

(51) **A61K 31/44**^(2006.01)

A61K 31/404^(2006.01)

(21) P-2019-359

(22) 20.08.2015

(30) 201462039786P 20.08.2014 US

(96) 15833863.2/20.08.2015

(86) US PCT/US2015/046120/20.08.2015

(87) WO 2016/029021/25.02.2016/2016/08

(97) EP 3206686/23.08.2017/2017/34

EP 3206686/09.10.2019/2019/41

(54) me **GAMA-DIKETONI ZA TRETMAN I PREVENCIJU STARENJA KOŽE I BORA**
en **GAMMA-DIKETONES FOR TREATMENT AND PREVENTION OF AGING SKIN AND WRINKLES**

(73) Samumed, LLC

9381 Judicial Drive, San Diego, California 92121/ US

(72) HOOD, John

5124 Seagrove Court, San Diego, California 92130 / US

KC, Sunil Kumar

10504 Clasico Court, San Diego, CA 92127/ US

KIBAR, Osman

9381 Judicial Drive , San Diego, California 92121 / US/ US

(74) Advokat RADULOVIĆ, Božidar S.

Baku 30/5, Podgorica, 81000 / ME

(57)

1. Kozmetički postupak za poboljšanje estetskog izgleda kože ispitanika, pri čemu postupak uključuje davanje ispitaniku efikasne količine jedinjenja Formule I ili njegova dermatološki prihvatljive soli:

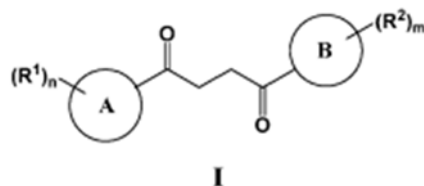

gde:

Prsten A je 7-12-člani heteroaril, pod uslovom da je ugljenikov atom na prstenu vezan za karbonil ugljenika; Prsten B je izabran iz grupe koju čine fenil i 5-6-člani heteroaril, pod uslovom da je atom ugljenika na prstenu vezan za karbonil ugljenika;

R1 je supstituent vezan za prsten A i nezavisno je izabran iz svake pojave iz grupe koja se sastoji od nesupstituisanog -C1-6 alkila, -C1-3 haloalkila, halogenida, -OR3 i CN;

R2 je supstituent vezan za prsten B i nezavisno je izabran iz svake pojave iz grupe koja se sastoji od nesupstituisanog -C1-6 alkila, -CH2OH, -CH2N(R3b)2, -Cl-3 haloalkila, halogenida, -OR3 i CN;

svako R3 je nezavisno odabrano iz grupe koju čine H, nesupstituisani C1-6 alkil i -C1-3 haloalkil;

svako R3b je nezavisno odabrano iz grupe koju čine H i nesupstituisani -C1-3 alkil; svako n je 0 do 10; i svako m je 0 do 5.

Patent sadrži još 14 patentnih zahtjeva.

(11) **03708** (13) **B**

(51) **A61K 38/04**^(2006.01)

C07K 7/06^(2006.01)

A61P 35/00^(2006.01)

C07K 7/00^(2006.01)

C07K 7/08^(2006.01)

(21) P-2019-360

(22) 16.12.2015

(30) 20140023016 23.12.2014 GB
201462096165P 23.12.2014 US
20150001017 21.01.2015 GB

(96) 15813809.9/16.12.2015

(86) EP PCT/EP2015/080018/16.12.2015

(87) WO 2016/102272/30.06.2016/2016/26

(97) EP 3236985/01.11.2017/2017/44
EP 3236985/25.09.2019/2019/39

(54) me **REŽIM DOZIRANJA AGONISTA S1P RECEPTORA**
en **NOVEL PEPTIDES AND COMBINATION OF PEPTIDES FOR USE IN IMMUNOTHERAPY**
AGAINST HEPATOCELLULAR CARCINOMA (HCC) AND OTHER CANCERS

(73) Immatix Biotechnologies GmbH
Paul-Ehrlich-Strasse 15, Tübingen, 72076 / DE

(72) WEINSCHENK, Toni
Im Morgenrain 15, Aichwald, 73773 / DE
MAHR, Andrea

Horemer 17, Tübingen , 72076 / DE
FRITSCHKE, Jens
Lärchenweg 11, Dusslingen, 72144 / DE

MÜLLER, Phillip
Obere Karlsstrasse 14, Kassel , 34117 / DE
WIEBE, Anita

Quellenstrasse 49, Ruebgarten , 72124 / DE
MISSEL, Sarah

Französische Allee 13, Tübingen, 72072 / DE

(74) Advokat POPOVIĆ, Miladin
Đoka Miraševića 21/III , Podgorica , 81000 / ME

(57)

1. Peptid koji sadrži aminokiselinsku sekvencu ID BR. SEKV 53 i njegova farmaceutski prihvatljiva so, naznačeno time što navedeni peptid ima celokupnu dužinu od 10 do 30 aminokiselina, naznačeno time što navedeni peptid ima sposobnost da se vezuje za molekul humanog glavnog kompleksa gena tkivne podudarnosti (MHC) klase I, i naznačeno time što navedeni peptid, kada je vezan za MHC, ima sposobnost da ga prepoznaju CD8 T ćelije.

Patent sadrži još 14 patentnih zahtjeva.

(11) **03681 (13) B**

(51) **C07D 417/04**^(2006.01)

C07D 417/14^(2006.01)

A61P 37/00^(2006.01)

C07D 417/06^(2006.01)

A61K 31/427^(2006.01)

A61P 17/06^(2006.01)

(21) P-2019-367

(22) 30.10.2015

(30) 201462072599 P 30.10.2014 US

(96) 15794729.2/30.10.2015

(86) US PCT/US2015/0582008/30.10.2015

(87) WO 2016/069978/06.05.2016/2016/18

(97) EP 3212642/06.09.2017/2017/36

EP 3212642/30.10.2019/2019/44

(54) me **AMIDNO SUPSTITUISANI TIAZOLI KAO MODULATORI RORGAMAT**
en **AMIDE SUBSTITUTED THIAZOLES AS MODULATORS OF RORGAMMAT**

(73) Janssen Pharmaceutica NV

Turnhoutseweg 30, Beerse, 2340/ BE

(72) VENKATESAN, Hariharan

3210 Merryfield Row, San Diego, California 92121/ US

TANIS, Virginia

3210 Merryfield Row, San Diego, California 92121/ US

URBANSKI, Maud

1400 McKean Road, Springhouse, Pennsylvania 19477/ US

WANG, Aihua

1400 McKean Road, Springhouse, Pennsylvania 19477/ US

KUMMER, David

3210 Merryfield Row, San Diego, California 92121/ US

STEENECK, Christoph

Donnersbergweg 1, 67059 Ludwigshafen/ DE

GEGE, Christian

Donnersbergweg 1, 67059 Ludwigshafen/ DE

KINZEL, Olaf

Donnersbergweg 1, 67059 Ludwigshafen/ DE

KLEYMANN, Gerald

Donnersbergweg 1, 67059 Ludwigshafen/ DE

HOFFMANN, Thomas

Donnersbergweg 1, 67059 Ludwigshafen/ DE

GOLDBERG, Steven

3210 Merryfield Row, San Diego, California 92121/ US

FOURIE, Anne M.

3210 Merryfield Row, San Diego, CA 92121/ US

XUE, Xiaohua

3210 Merryfield Row, San Diego, CA 92121/ US

1. Jedinjenje Formule I:

pri čemu:

je fenil, piridil, pirimidil, pirazinil, ili piridazil;

R1 je Cl, -CN, H, F, OC(1-4)alkil, OCHF₂,

OCF₃, C(1-4)alkil, Br, I, ili ciklopropil; pri čemu pomenuti C(1-4)alkil je opciono supstituisan sa do šest atoma fluora;

R2 je F, Cl, -CN, H, OC(1-4)alkil, OCHF2, OCF3, ciklopropil, ili C(1-4)alkil; pri čemu pomenuti C(1-4)alkil je opciono supstituisan sa do pet atoma fluora, i pomenuti ciklopropil je opciono supstituisan sa OH, CH3, CF3, i do pet atoma fluora; ili R1 i R2 mogu zajedno sa prstenom A za koji su vezani da obrazuju sistem spojenih prstena izabranih iz grupe koja obuhvata naftalenil, tetrahidronaftalenil, izohinolinil, hinolinil, 2,3-dihidro-1H-indenil, hromanil, izohromanil, i naftiridinil; pri čemu pomenuti naftalenil, tetrahidronaftalenil, izohinolinil, hinolinil, 2,3-dihidro-1H-indenil, hromanil, izohromanil, i naftiridinil mogu opciono da budu supstituisani sa do tri supstituenata nezavisno izabranih iz grupe koja obuhvata F, OC(1-3)alkil ili C(1-3)alkil pri čemu pomenuti OC(1-3)alkil i C(1-3)alkil je opciono supstituisan sa do pet atoma fluora (uključujući CHF2, CH2F, CF3, i CH3; pod uslovom da R2 ne mora da bude H ukoliko R1 je H;

R3 je tiadiazolil, oksadiazolil, izoksadiazolil, oksazolil, izoksazolil, triazolil, tetrazolil, 1,2,4-oksadiazol-5(4H)-on-3-il, piridil, tiazolil, pirimidil, piridazil, pirazil, imidazolil, pirrolil, furanil, ili fenil; pri čemu pomenuti tiadiazolil, oksadiazolil, izoksadiazolil, oksazolil, izoksazolil, triazolil, piridil, tiazolil, pirimidil, piridazil, pirazil, imidazolil, pirolil, furanil, ili fenil je opciono supstituisan sa R4, i dalje opciono supstituisan sa jednim supstituentom izabranim iz grupe koja obuhvata F, CH3, CF3, i ciklopropil;

R4 je H, C(1-6)alkilSO2C(1-6)alkil, C(O)NH2, C(1-6)alkil, -CN, C(3-6)cikloalkil, NH2, NH(C(1-6)alkil), N(C(1-6)alkil)2, NHCO(C(1-6)alkil), N(C(1-6)alkil)CO(C(1-6)alkil), NHSO2(C(1-6)alkil),

N(C(1-6)alkil)SO2(C(1-6)alkil), O(C(1-6)alkil), C(O)NH2, CONH(C(1-6)alkil), CON(C(1-6)alkil)2, SO2NH2, SO2NH(C(1-6)alkil), SO2NH(COC(1-6)alkil), ili SO2N(C(1-6)alkil)2; pri čemu pomenuti C(1-6)alkil ili C(3-6)cikloalkil je opciono nezavisno supstituisan sa do šest atoma fluora, CF3, CO2H, OH, -CN, C(O)NH2, NH2, OCH3, OCHF2, OCF3, -(CKS2)m-, ili N(CH3)2;

m je 2, 3, 4, ili 5;

X je H, ili F; gde je svako pojavljivanje X u jednom molekulu nezavisno definisano;

A1 je H, ili C(1-4)alkil; pri čemu pomenuti C(1-4)alkil je opciono supstituisan sa do šest atoma fluora, Cl, -CN, OCH3, OCHF2, ili OCF3;

A2 je C(1-6)alkil, C(0-2)alkil-C(3-6)cikloalkil,

CH2-C6H4-C(O)NH2, -C6H4-F, CH2-CCH, ili CH2-CC-CH3; pri čemu pomenuti C(1-6)alkil, i pomenuti C(0-2)alkil-C(3-6)cikloalkil su opciono supstituisani sa do šest atoma fluora, Cl, -CN, OCH3, OCHF2, ili OCF3;

ili A1 i A2 mogu zajedno sa azotom za koji su vezani da obrazuju prsten izabran iz grupe koja se sastoji iz:

tiomorfolinil, piperidinil, pirolidinil, piperazinil, morfolinil, azetidilil, i aziridinil; pri čemu pomenuti piperidinil, pirolidinil, piperazinil, morfolinil, azetidilil, i aziridinil su opciono supstituisani sa CF3, CH2CH2F, C(1-2)alkil, C(3-6)cikloalkil, -CN, OH, CH2OH, CH2F, F, Cl, OCH3, OCHF2, OCF3, -(CX2)nO(CX2)n-, ili -(CX2)n-, i do tri dodatna supstituenta izabrana iz grupe koja se sastoji iz CH3 i F;

n je nezavisno 0, 1, 2, 3, ili 4;

X je H, ili F; gde svako pojavljivanje X u jednom molekulu je nezavisno definisano;

R5 je SO2NA3A4, CONA3A4, NA3A4, OCH2C(CF3)2OH, C(3-6)cikloalkil, ili C(1-6)alkil; pri čemu pomenuti C(3-6)cikloalkil i pomenuti C(1-6)alkil su opciono supstituisani sa OH, Cl, -CN, H, OCH3, OCHF2, OCF3, ili NA3A4, dalje opciono supstituisane sa -CH2CH2- koji je vezan za isti ugljenikov atom, i do sedam atoma fluora;

A3 je H, ili C(1-4)alkil; pri čemu pomenuti C(1-4)alkil je opciono supstituisan sa OH, Cl, -CN, OCH3, OCHF2, ili OCF3; i do šest atoma fluora;

A4 je H, C(1-6)alkil, C(3-6)cikloalkil, ili C(3-6)heterocikloalkil; pri čemu pomenuti C(1-6)alkil je opciono supstituisan sa ciklopropil, morfolinil, OH, OCH₃, C(O)NH₂, Cl, -CN, OCHF₂, OCF₃ i dodatno supstituisan sa do tri atoma fluora; i gde pomenuti C(3-6)cikloalkil, i C(3-6)heterocikloalkil su opciono supstituisani sa CF₃, CH₃, -CN, C(O)NH₂, i do tri atoma fluora;

ili A3 i A4 mogu zajedno sa azotom za koji su vezani da obrazuju prsten izabran iz grupe koja obuhvata piperidinil, morfolinil, piperazinil, pirrolidinil, aziridinil, i azetidinil gde pomenuti piperidinil, morfolinil, piperazinil, pirolidinil, aziridinil, i azetidinil su opciono supstituisani sa do četiri grupe koje su izabrane iz grupe koja obuhvata CF₃, OH, CH₃, CH₂F, i CHF₂; i dalje opciono supstituisani sa do četiri grupe izabrane iz grupe koja obuhvata CF₃, OH, CH₃, CH₂F, i CHF₂; i dalje opciono supstituisani sa do šest atoma fluora;

i njegove farmaceutski prihvatljive soli.

Patent sadrži još 14 patentnih zahtjeva.

(11) **03698 (13) B**

(51) **A61K 39/00**^(2006.01)

C07K 16/00^(2006.01)

C12P 21/08^(2006.01)

A61P 35/00^(2006.01)

(21) P-2019-5

(22) 24.09.2012

(30) 201161538454 P 23.09.2011 US

201261597409 P 10.02.2012 US

201261692978 P 24.08.2012 US

(96) 12833767.2/24.09.2012

(86) US PCT/US2012/056886/24.09.2012

(87) WO 2013/044215/28.03.2013/2013/13

(97) EP 2758073/30.07.2014/2014/31

EP 2758073/31.10.2018/2018/44

(54) me **VEGF/DLL4 VEZUJUĆI AGENSI I NJIHOVA UPOTREBA**
en **VEGF/DLL4 BINDING AGENTS AND USES THEREOF**

(73) OncoMed Pharmaceuticals, Inc.

800 Chesapeake Drive, Redwood City, CA 94063/ US

(72) GURNEY, Austin L.

946 Diamond Street, San Francisco, CA 94114/ US

SATO, Aaron Ken

1640 Coronado Way, Burlingame, CA 94010/ US

BOND, Christopher John

511 30th Avenue, San Mateo, CA 94403/ US

(57)

1. Bispecifično antitelo sadrži:

a) prvo mesto za vezivanje antigena koje specifično vezuje faktor rasta na humani vaskularni endotel (VEGF),

b) drugo mesto za vezivanje antigena koji specifično vezuje humani ligand nalik delta-4 (DLL4), gde prvo mesto za vezivanje antigena sadrži CDR1 teškog lanca koji sadrži NYWMH (SEK ID Br:17), CDR2 teškog lanca koji sadrži DINPSNGRTSYKEKFKR (SEK ID Br:18) i CDR3 teškog lanca koji sadrži HYDDKYYPLMDY (SEK ID Br:19) ; 13) ili AYYIH (SEK ID Br:79), teški lanac CDR2 koji sadrži YIX1X2YX3X4ATNYNQKFKG (SEK ID Br:80), gde X1 je serin ili alanin, X2 je serin, asparagin ili glicin, X3 je asparagin ili lizin, a je glinin, arginin ili asparaginska kiselina, a CDR3 teškog lanca koji sadrži RDYDYDVGMDY (SEK ID Br:16); gde i prvo i drugo mesto za vezivanje antigena sadrže COR I lakog lanca koji sadrži RASESVDNYGISFMK (SEK ID Br:20), CDR2 lakog lanca koji sadrži AASNQGS (SEK ID Br:21) i CDR3 lakog lanca koji sadrži QQSKEVPWTFGG (SEK ID Br:22).

Patent sadrži još 21 patentnih zahtjeva.

(11) **03699 (13) B**

(51) **C02F 1/00**^(2006.01)

C02F 1/44^(2006.01)

C02F 1/66^(2006.01)

C02F 5/14^(2006.01)

E04H 4/12^(2006.01)

C02F 1/76^(2006.01)

C02F 1/50^(2006.01)

C02F 1/78^(2006.01)

C02F 103/42^(2006.01)

(21) P-2019-63

(22) 12.09.2011

(30) 201161469548 P 30.03.2011 US

201113136458 01.08.2011 US

(96) 16198841.5/12.09.2011

(97) EP 3153474/12.04.2017/2017/15

EP 3153474/26.12.2018/2018/52

(54) me **ODRŽIVI SISTEM ZA TRETMAN VODENIH TELA POGOĐENIH BAKTERIJAMA I MIKROALGAMA UZ NISKE TROŠKOVE**

en **SUSTAINABLE SYSTEM FOR TREATING WATER BODIES AFFECTED BY BACTERIA AND MICROALGAE AT LOW COST**

(73) Crystal Lagoons (Curaçao) B.V.

Kaya W.F.G. (Jombi), Mensing 14/ CW

(72) Fischmann, T. Fernando

Avenida Kennedy, 8830 Vitacura, Santiago/ CL

(57)

1. Veliko veštačko vodeno telo pogođeno bakterijama i mikroalgama i sistem za tretiranje i održavanje uz niske troškove, koji obuhvata: - najmanje jedan bazen (12) koji ima zapreminu od najmanje 15.000 m³ za skladištenje vode koja ima temperaturu do 45 °C, tako da nastaje veliko veštačko telo vode, koje sadrži prijemno sredstvo (2) fiksirano za donju površinu bazena (12) i pri čemu je prijemno sredstvo (2), koje pokriva dno bazena, konstruisano od neporoznog materijala sposobnog da bude čišćen i gde se neporozni materijal bira iz membrane, geo-membrane premazanog betona, plastične obloge ili njihove kombinacije koja omogućava neometajućem pokretnom usisnom sredstvu (3) da se kreće preko cele površine bazena (12) i usisava istaložene čestice;

-najmanje jednu cev za dovođenje (13) koja dovodi vodu iz pritoka u najmanje jedan bazen (12); **Najmanje jedan sredstvo za primjenu hemikalija (6)** - najmanje jedno neometajuće pokretno usisno sredstvo (3), pri čemu su pokretna usisna sredstva konfigurisana da obavljaju temeljito površinsko čišćenje prijemnog sredstva (2) na donjoj površini bazena (12) uz kretanje pomeranjem duž dna navedenog najmanje jednog bazena (12) i usisava vodu koja sadrži nataložene čestice; - najmanje jedno pogonsko sredstvo (4) za pomeranje najmanje jednog neometajućeg pokretnog usisnog sredstva (3) po dnu pomenutog najmanje jednog bazena (12);

- najmanje jednu spojnicu (5) koja povezuje najmanje jedno pogonsko sredstvo (4) sa pomenutim najmanje jednim usisnim sredstvom (3);

- najmanje jedno filtraciono sredstvo (7) za filtriranje pomenute vode koja sadrži istaložene čestice usisane pomoću neometajućeg pokretnog usisnog sredstva (3);-najmanje jedan kolektorski odvod (IO) uklopljen između navedenog najmanje jednog pokretnog usisnog sredstva (3) i navedenog najmanje jednog filtracionog sredstva (7);-najmanje jedan povratni vod (II) od pomenutog najmanje jednog filtracionog sredstva (7) do navedenog najmanje jednog bazena (12); i- najmanje jedno sredstvo za koordinaciju (I) koje sadrži elektronske uređaje naznačeno time što je sredstvo za koordinaciju (I) konfigurisano da prima informaciju (8) u vezi sa parametrima kvaliteta vode, da obrađuje tu informaciju (8) i da blagovremeno aktivira procese neophodne za podešavanje parametara vode u unapred određenim granicama, pri čemu navedeni procesi obuhvataju pravovremeno aktiviranje (9) pokretnih usisnih sredstava (3) kako bi se sprečilo da debljina nataloženih čestica u preseku bude veća od 3 mm, što će istovremeno aktivirati sredstva za filtraciju (7), tako da je sistem konfigurisan da filtrira samo malu frakciju celog volumena vode iz pomenutog veštačkog vodenog tela, te pri čemu takvi procesi dalje obuhvataju pravovremeno aktiviranje sredstava za primenu hemikalija (6) za nanošenje agensa za dezinfekciju na vodu da bi se održao ORP nivo od najmanje 500 mV samo kroz minimalni vremenski period određen prema temperaturi vode, pri čemu je minimalni vremenski period određen prema temperaturi vode i iznosi 1 sat po 7 dana za svaki °C temperature vode; pri čemu je sistem konfigurisan da tretira navedenu vodu tako da je voda pogodna za rekreativnu upotrebu niske gustine primene. , geotekstilne membrane, betona,

Patent sadrži još 6 patentnih zahtjeva.

(11) **03682** (13) **B**

(51) **A61K38/45**^(2006.01)

A61P1/16^(2006.01)

(21) P-2020-1

(22) 06.05.2011

(30) 20100331909P 06.05.2010 US

(96) 11720265.5/06.05.2011

(86) US PCT/US2011/035500/06.05.2011

(87) WO 2011/140429 A1/10.11.2011/2011/45

(97) EP 2566505/13.03.2013/2013/11

EP 2566505/16.10.2019/2019/42

(54) me **ISPORUKA HOLESTERIL ESTRA U STEROIDOGENO TKIVO**
en **DELIVERY OF CHOLESTERYL ESTER TO STEROIDOGENIC TISSUES**

(73) Alphacore Pharma LLC

333 Parkland Plaza, Ann Arbor, MI 48103, / US

(72) AUERBACH, Bruce. J.

2425 Meadowridge Court, Ann Arbor Michigan•48105 , / US

HOMAN, Reynold

2607 Tessmer Road, Ann Arbor Michigan 48103 / US

KRAUSE, Brian

1984 Encore Ct., Ann Arbor Michigan 48103 / US

(57)

1. Lecitin: holesterol aciltransferaza (LCAT) za upotrebu pri tretiranju pacijenta koji ima stanje gde je smanjena funkcija steroidogenog tkiva, gde je stanje akutno stanje koje je izabrano iz grupe koju čine infekcija, sepsa, povreda, opekotine, bolest jetre, transplantacijaorgana ili trovanje teškim metalom.

Patent sadrži još 9 patentnih zahtjeva.

(11) **03701 (13) B**

(51) **C07D 471/04**^(2006.01)

A61K 31/437^(2006.01)

A61P 25/24^(2006.01)

(21) P-2020-10

(22) 07.07.2016

(30) 201562190416 P 09.07.2015 US

(96) 16741469.7/07.07.2016

(86) IB PCT/US2016/041339/07.07.2016

(87) WO 2017/007938/12.01.2017/2017/02

(97) EP 3319963/16.05.2018/2018/20

EP 3319963/08.01.2020/2020/02

(54) me **SUPSTITUISANI 4-AZAINDOLI I NJIHOVA UPOTREBA KAO MODULATORA GLUN2B RECEPTORA**

en **SUBSTITUTED 4-AZAINDOLES AND THEIR USE AS GLUN2B RECEPTOR MODULATORS**

(73) Janssen Pharmaceutica NV

Turnhoutseweg 30, Beerse, 2340/ BE

(72) CHROVIAN, Christa C.

3210 Merryfield Row, San Diego, California 92121/ US

LETAVIC, Michael A.

3210 Merryfield Row, San Diego, California 92121/ US

RECH, Jason C.

3210 Merryfield Row, San Diego, California 92121/ US

SOYODE-JOHNSON, Akinola

3210 Merryfield Row, San Diego, California 92121/ US

WALL, Jessica L.

3210 Merryfield Row, San Diego, California 92121/ US

(57)

1. Jedinjenje koje ima strukturu Formule (I):

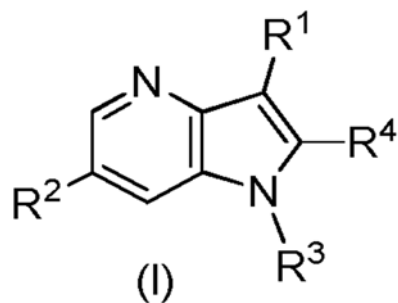

pri čemu:

R¹ je izabran iz grupe koja obuhvata: H, 3H, halo, C1-3alkil, i C1-3haloalkil;

R² je izabrana iz grupe koja obuhvata: fenil koji je opciono supstituisan sa jednim, dva, ili tri člana nezavisno izabranih između: halo, C1-5alkil, i C1-5haloalkil; piridinil opciono supstituisan sa halo, C1-5alkil, C1-

5haloalkil, i -CN; tiazolil opciono supstituisan sa C1-5alkil; benzotiofenil; i tienil opciono supstituisan sa jednim, dva ili više članova nezavisno izabranih između: halo, C1-5alkil, i C1-5haloalkil;

R3 je

(a)

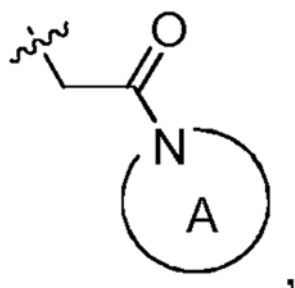

gde prsten A je 4-7 člani heterocikloalkil koji opciono sadrži dodatni heteroatom kiseonika

izabran iz grupe koju obuhvata: azetidiniil opciono supstituisan sa jednim ili dva člana nezavisno izabranih iz grupe koja obuhvata: halo, C1-5alkil, C1-5haloalkil, CH₂OH, C1-5alkoksi, OH, i CN; piroolidinil opciono supstituisan sa jednim ili dva člana nezavisno izabranih iz grupe koja obuhvata: halo, C1-5alkil, C1-5alkoksi, i OH; morfolino opciono supstituisan sa jednim ili dva C1-5alkil člana; piperidinil opciono supstituisan sa jednim ili dva člana nezavisno izabranih iz grupe koja obuhvata: halo, C1-5alkil, C1-5haloalkil, C1-5alkoksi, i OH; 3-azabicyklo[3.1.0]heksan-3-il; 5-azaspiro[2.3]heksan-5-il; i piroolidin-3-on; ili

(b)

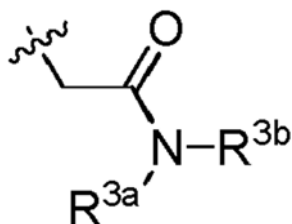

pri čemu R^{3a} je H, ili C1-5alkil; i R^{3b} je izabran iz grupe koja obuhvata: C1-5alkil opciono supstituisan sa OH, halo, ili OCH₃; C1-5haloalkil; benzil; CH₂ciklopropil; ciklopropil opciono supstituisan sa C1-5alkil; i ciklobutil; ili

(c)

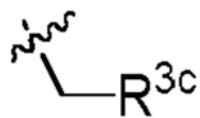

pri čemu R_{3c} je izabran iz grupe koja obuhvata: ciklopropil; ciklobutil; pirimidinil opciono supstituisan sa halo; piridinil; piridazinil; furanil opciono supstituisan sa C1-5haloalkil; oksazolil; izoksazolil opciono supstituisa sa C1-5alkil; oksadiazolil opciono supstituisan sa C1-5alkil; pirazolil opciono supstituisan sa C1-5alkil; triazolil opciono supstituisan sa C1-5alkil; tetrahidrofuranil; tetrahidropiranil; oksetanil; i oksiranil; ili

(d)

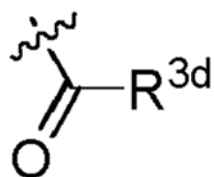

pri čemu R_{3d} je CH₂-ciklopropil ili ciklobutil; ili

(e)

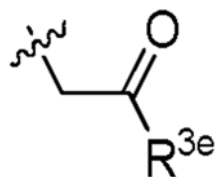

pri čemu R_{3e} je izabran iz gupe koja obuhvata: OH, C1-5alkil, ciklopropil, ciklobutil, i fenil opciono supstituisana sa jednim halo supstituentom; ili

(f) C1-5alkil opciono supstituisan sa OH ili C1-5alkoksi; CH₂S(CH₃); CH₂(S=O)CH₃; CH₂(SO₂)CH₃; ili CH₂CH₂(C=O)CH₃; ili

R₄ je H, 2H ili C1-3alkil; ili njegova farmaceutski prihvatljiva so, solvat, ili N-oksid.

Patent sadrži još 14 patentnih zahtjeva.

(11) **03736** (13) **B**

(51) **A61K31/416**^(2006.01)

A61K31/4196^(2006.01)

A61P31/10^(2006.01)

A61K31/4174^(2006.01)

A61K45/06^(2006.01)

(21) P-2020-100

(22) 08.01.2016

(30) 20150150904 13.01.2015 EP

(96) 16700189.0/08.01.2016

(86) WO WO2016EP50272/08.01.2016

(87) WO 2016113194 A1/21.07.2016/2016/28

(97) EP 3244889/22.11.2017/2017/47

EP 3244889/04.03.2020/2020/10

(54) me **FARMACEUTSKI PRIPRAVAK ZA LIJEČENJE MIKOZE**

en **PHARMACEUTICAL COMPOSITION FOR THE TREATMENT OF MYCOSIS**

(73) Aziende Chimiche Riunite Angelini Francesco A.C.R.A.F. S.p.A.

Viale Amelia, 70, 00181 Roma/ IT

(72) MILANESE, Claudio

Via Abigaille Zanetta 68, 00143 Roma/ IT

CAPEZZONE DE JOANNON, Alessandra

Piazza dei Vespri Siciliani 7, 00161 Roma / IT

TONGIANI, Serena

Via Selva 89, 00045 Genzano Di Roma (Roma)/ IT

DONATI, Luca

Via Tiziano Vecellio, 1, 63017 Porto San Giorgio (AP)/ IT

(57)

1. Farmaceutski pripravak, **naznačen time, da** obuhvaća sinergističku kombinaciju benzidamina i imidazol-antimikotika ili njegove soli, te najmanje jedno farmaceutski prihvatljivo pomoćno sredstvo, te time, da se upotrebljava u liječenju *Candida*-mikoze.

Patent sadrži još 14 patentnih zahtjeva.

(11) **03726** (13) **B**

(51) **C07D 471/04**^(2006.01)

C07D 498/10^(2006.01)

A61P 29/00^(2006.01)

C07D 487/04^(2006.01)

A61K 31/551^(2006.01)

A61P 25/00^(2006.01)

(21) P-2020-101

(22) 05.05.2017

(30) 16382199 06.05.2016 EP

(96) 17721680.1/05.05.2017

(86) EP PCT/EP2017/060780/05.05.2017

(87) WO 2017/191304/09.11.2017/2017/45

(97) EP 3452475/13.03.2019/2019/11

EP 3452475/26.02.2020/2020/09

(54) me **JEDINJENJA TETRAHIDROPIRIMIDODIAZEPINA I TETRAHIDROPIRIDO-DIAZEPINA ZA LEČENJE BOLA I STANJA POVEZANIH SA BOLOM**
en **TETRAHYDROPYRIMIDODIAZEPINE AND TETRAHYDROPYRIDODIAZEPINE COMPOUNDS FOR TREATING PAIN AND PAIN RELATED CONDITIONS**

(73) ESTEVE PHARMACEUTICALS, S.A.

Passeig de la Zona Franca, 109, 4^a Planta, 08038 Barcelona/ ES

(72) CUEVAS-CORDOBÉS, Félix

Pza. Hermano Ramón Quiroga 2 4F, 28340 Valdemoro (Madrid)/ ES

ALMANSA-ROSALES, Carmen

c/ Teodora Lamadrid n° 41 Ent 4^a, 08022 Barcelona/ ES

(57)

1. Jedinjenje opšte formule (I):

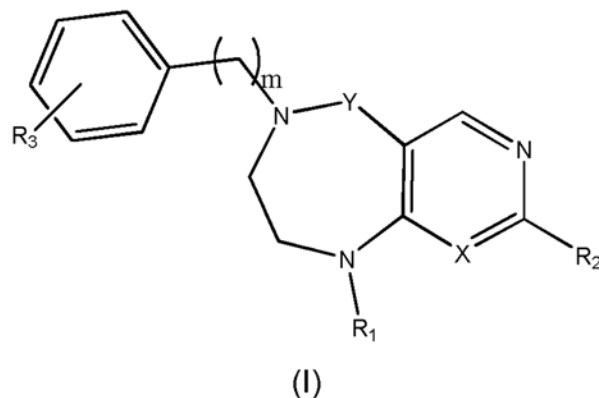

u kome:

X je CR_x ili N;

R_x je atom vodonika; granat ili ngranat C1-6 alkil radikal; ili atom halogena;

Y je CH₂ ili C=O;

m je 0, 1 ili 2;

R₁ je atom vodonika; ili linearni ili granati C1-6 alkil radikal;

R₂ je atom vodonika; granat ili ngranat C1-6 alkil radikal; atom halogena; haloalkil; -SR_{2a}; -NR_{2a}R_{2b}; ili -OR_{2a};

R_{2a} i **R_{2b}** su međusobno nezavisno atom vodonika; granat ili ngranat C1-4 alkil radikal; C3-6 cikloalkil radikal; -(CH₂)_r-aril gde je aril grupa 5 ili 6-člani prsten i r je 0, 1 ili 2; -(CH₂)_s-heteroaril gde je heteroaril

grupa 5 ili 6-člani prsten sa najmanje jednim atomom azota kao heteroatomom izorno supstituisanim sa najmanje jednim atomom halogena i s je 0, 1 ili 2; ili $-(CH_2)_2-O-CH_3$;

R3 je atom vodonika; $-CN$; $-OH$; halogen; granat ili negranat C1-6 alkil radikal; $-(CH_2)_p-O-R_4$ gde je **p** jednako 0, 1 ili 2; $-(CH_2)_q-NR_5R_6$ gde je **q** jednako 0, 1, 2 ili 3; $-C(CH_3)_2-CH_2-NR_5R_6$; $-C(=O)NR_5R_6$; 5 ili 6 -člana heteroaril grupa koja ima najmanje jedan heteroatom izabran od N, O ili S i supstituisana se sa jednim ili dva R7 supstituenta i koja može biti vezana za fenil prsten preko C1-3 alkilen grupe; 5 ili 6 -člani heterocikloalkil radikal koji ima jedan ili dva azota kao heteroatom i koji je nesupstituisan ili izorno supstituisan sa jednim ili dva R8 supstituenta i koji može biti vezan za fenil prsten preko C1-3 alkilen grupe; ili $-C(=O)OR_9$;

R4 je atom vodonika; granat ili negranat C1-6 alkil radikal; terc-butildimetilsilil radikal; metilbensulfonat radikal; $-CHR_4aR_4b$; $-CH_2-CHR_4aR_4b$; ili 5 ili 6-člani heterocikloalkil radikal koji ima najmanje jedan N atom i koji je izorno supstituisan sa jednim ili dva R4c radikala;

R4a je atom vodonika; granat ili negranat C1-6 alkil radikal; 5 ili 6-člana aril grupa izorno supstituisana sa najmanje jednim atomom halogena; ili 5 ili 6-člana heteroaril grupa koja ima najmanje jedan heteroatom izabran od N, O ili S i izorno supstituisan sa najmanje granatim ili negranatim C1-6 alkil radikalom;

R4b je $-(CH_2)_j-NR_4b'R_4b''$ gde je **j** jednako 0, 1, 2 ili 3;

R4b' i **R4b''** su međusobno nezavisno atom vodonika; granat ili negranat C1-6 alkil radikal; C1-6 haloalkil radikal; benzil grupa; fenetil grupa; terc-butiloksikarbonil grupa; ili (trimetilsilil)etiloksikarbonil grupa; ili

R4b' i **R4b''** zajedno sa pemošćujućim azotom formiraju 5 ili 6-člani heterocikloalkil radikal koji izorno sadrži dodatni heteroatom izabran od N, O ili S;

R4c je atom vodonika; granat ili negranat C1-6 alkil radikal; fenil grupa; benzil grupa; ili terc-butiloksikarbonil grupa;

R5 i **R6** međusobno nezavisno predstavljaju atom vodonika; granat ili negranat C1-6 alkil radikal; terc-butiloksikarbonil grupa; benzil grupa; fenetil grupa; ili

R5 i **R6** zajedno sa pemošćujućim azotom formiraju 5 ili 6-člani heterocikloalkil radikal koji može biti mono ili bisupstituisan fenil grupom zauzvrat izorno supstituisanom granatim ili negranatim C1-6 alkil radikalom, atomom halogena, $-OH$ ili $-CN$; ili sa $-NRR'$; **R** i **R'** su međusobno nezavisno atom vodonika ili granat ili negranat C1-6 alkil radikal; ili

R5 i **R6** zajedno sa pemošćujućim azotom formiraju 5 ili 6-člani heterocikloalkil radikal koji može biti spirofuzionisan za drugi 5 ili 6-člani heterocikloalkil radikal koji ima najmanje jedan heteroatom izabran od N, O ili S koji zauzvrat može biti supstituisan sa jednim ili više supstituenata izabranim od granatog ili negranatog C1-6 alkil radikala; atom halogena, $-OH$, $-CN$ ili $=O$;

R7 je atom vodonika; granat ili negranat C1-6 alkil radikal; $-C(=O)H$ grupa; $-(CH_2)_p-NR_7aR_7b$ gde je **p** jednako 0, 1, 2 ili 3; ili $-(CH)R_7cR_7d$;

R7a i **R7b** međusobno nezavisno predstavljaju atom vodonika; granat ili negranat C1-6 alkil radikal; terc-butiloksikarbonil grupu; benzil grupu izorno supstituisanu halogenom; fenetil grupu; $-(CH_2)$ -ciklopropil; hidroksietoksietil grupu; $-OH$; $-C(=O)H$ grupu; piridinimetil grupu; ili

R7a i **R7b** zajedno sa pemošćujućim azotom formiraju 5 ili 6-člani heterocikloalkil radikal koji može dodatno da sadrži drugi N atom koji radikal može biti supstituisan sa $-NR_7a'R_7b'$ gde su R_7a' i R_7b' atom vodonika i granat ili negranat C1-6 alkil radikal; ili fenil grupom zauzvrat izorno supstituisan granatim ili negranatim C1-6 alkil radikalom, atomom halogena, $-OH$ ili $-CN$; ili

R7a i **R7b** zajedno sa pemošćujućim azotom formiraju 5 ili 6-člani heterocikloalkil radikal koji može biti fuzionisan za 5 ili 6 -člani aromatični prsten ili može biti spirofuzionisan za jedan 5 ili 6-člani heterocikloalkil prsten koji ima najmanje jedan heteroatom izabran od N, O ili S koji zauzvrat može biti supstituisan sa jednim ili više supstituenata izabranih od granatog ili negranatog C1-6 alkil radikala, atoma halogena, $-OH$, $-CN$ ili $=O$; ili može biti spirofuzionisan za biciklični sistem prstena formiran pomoću 5 ili 6-članog heterocikloalkil prstena koji ima najmanje jedan heteroatom izabran od N, O ili S fuzionisan sa 5 ili 6-članim aromatičnim prstenom;

R7c i **R7d** međusobno nezavisno predstavljaju atom vodonika; granat ili negranat C1-6 alkil radikal; ili C1-6 alkoksi radikal; i

R8 je atom vodonika; granat ili negranat C1-6 alkil radikal; terc-butiloksikarbonil grupa; fenil grupa; benzil grupa; fenetil grupa; ili -NR^{8a'}R^{8b'} gde su R^{8a'} i R^{8b'} jednaki atom vodonika ili granat ili negranat C1-6 alkil radikal

R9 je atom vodonika; ili linearan ili granat C1-6 alkil radikal; ili njegova farmaceutski prihvatljiva so, stereoizomer ili solvat.

Patent sadrži još 15 patentnih zahtjeva.

(11) **03740** (13) **B**

(51) C07D 403/12 ^(2006.01)	C07D 401/04 ^(2006.01)
C07D 401/06 ^(2006.01)	C07D 401/12 ^(2006.01)
C07D 403/04 ^(2006.01)	C07D 403/10 ^(2006.01)
C07D 413/04 ^(2006.01)	C07D 417/04 ^(2006.01)
C07D 471/04 ^(2006.01)	C07D 487/04 ^(2006.01)
C07D 487/10 ^(2006.01)	C07D 209/18 ^(2006.01)
A61K 31/4045 ^(2006.01)	A61P 29/00 ^(2006.01)
A61P 37/00 ^(2006.01)	

(21) P-2020-102

(22) 17.12.2020

(30) 201462068225 P 24.10.2014 US

(96) 15790407.9/23.10.2015

(86) US PCT/US2015/057055/23.10.2015

(87) WO 2016/065226/28.04.2016/2016/17

(97) EP 3209656/30.08.2017/2017/35

EP 3209656/01.04.2020/2020/14

(54) me **JEDINJENJA INDOL KARBOKSAMIDA KORISNA KAO INHIBITORI KINAZE**
en **INDOLE CARBOXAMIDE COMPOUNDS USEFUL AS KINASE INHIBITORS**

(73) BRISTOL-MYERS SQUIBB COMPANY

Route 206 and Province Line Road, Princeton, NJ 08543/ US

(72) AHMAD, Saleem

Route 206&Province Line Road, Princeton, New Jersey 08543/ US

TINO, Joseph A.

Route 206&Province Line Road, Princeton, New Jersey 08543/ US

MACOR, John E.

55 Commanders Drive, Washington Crossing, PA 18977/ US

TEBBEN, Andrew J.

Route 206&Province Line Road, Princeton, New Jersey 08543/ US

GONG, Hua

Route 206&Province Line Road, Princeton, New Jersey 08543/ US

LIU, Qingjie

Route 206&Province Line Road, Princeton, New Jersey 08543/ US

BATT, Douglas G.

Route 206&Province Line Road, Princeton, New Jersey 08543/ US

NGU, Khehyong

Route 206&Province Line Road, Princeton, New Jersey 08543/ US

WATTERSON, Scott Hunter

Route 206&Province Line Road, Princeton, New Jersey 08543/ US

GUO, Weiwei

32 Pagoda Court, Lawrenceville, NJ 08648/ US

BEAUDOIN BERTRAND, Myra

Route 206&Province Line Road, Princeton, New Jersey 08543/ US

(57)

1. Jedinjenje Fonnule (1):

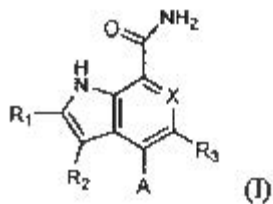

ili njegova so ili solvat, gde:

X je CR₄ ;

A je:

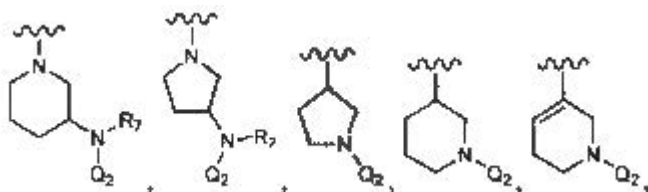

ili

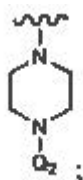

Q₂ je -C(O)CH=CH₂, -C(O)CH=CHCH₂N(CH₃)₂, -C(O)C=CR₇, -C(O)C≡C(fenil), -C(O)C≡C(C1-3 hidroksialkil), -C(O)C≡CSi(CH₃)₃, ili -S(O)₂CH=CH₂;

R₁ je H, -CH₃, -CF₃, ili fenil supstituisan sa nula ili 1 R₁₂;

R₂ je H, -CH₃, ciklopropil, ili fenil supstituisan sa nula ili 1 R₁₂, pod uslovom da najmanje jedan od R₁ i

R₂ je -CH₃;

R₃ je F ili Cl;

R₄ je H ili F;

R₇, pri svakom pojavljivanju, je nezavisno H, C1-4 alkil, ili ciklopropil; i

R₁₂ je F, Cl, -CN, -CF₃, ili C1-3 alkoksi.

Patent sadrži još 9 patentnih zahtjeva.

(11) **03730** (13) **B**

(51) **C07H 1/06**^(2006.01)

C07H 19/10^(2006.01)

(21) P-2020-104

(22) 29.09.2015

(30) 201417644 06.10.2014 GB

(96) 15782005.1/29.09.2015

(86) GB PCT/GB2015/052839/29.09.2015

(87) WO 2016/055769/14.04.2016/2016/15

(97) EP 3204398/16.08.2017/2017/33

EP 3204398/13.05.2020/2020/20

(54) me **POSTUPCI RAZDVAJANJA DIJASTEREOIZOMERA GEMCITABIN-FOSFATA**
en **METHODS OF SEPARATING GEMCITABINE-PHOSPHATE DIASTEREOISOMERS**

(73) NuCana plc

77-78 Cannon Street, London EC4N 6AF/ GB

(72) GRIFFITH, Hugh

c/o Nucana BioMed Limited 10 Lochside Place Edinburgh Park, Edinburgh EH12 9RG/ GB

(57)

1. Postupak obezbeđivanja najmanje jednog dijastereoizomera gemcitabin-[fenil-benzoksi-L-alaninil)]-fosfata dijastereoizomerne čistoće veće od 85%, naznačen time što postupak sadrži korake:

suspendovanje smeše gemcitabin-[fenil-benzoksi-L-alaninil)]-(*R*)-fosfata i gemcitabin-[fenil-benzoksi-L-alaninil)]-(*S*)-fosfata u rastvaraču ili smeši rastvarača kako bi se formirala kaša; i
filtriranje kaše kako bi se obezbedio čvrst gemcitabin-[fenil-benzoksi-L-alaninil)]-fosfat i filtrat koji sadrži gemcitabin-[fenil-benzoksi-L-alaninil)]-fosfat rastvoren u rastvaraču ili smeši rastvarača;

pri čemu je čvrst gemcitabin-[fenil-benzoksi-L-alaninil)]-fosfat gemcitabin-[fenil-benzoksi-L-alaninil)]-(*R*)-fosfat dijastereoizomerne čistoće veće od 85% i/ili filtrat sadrži gemcitabin-[fenil-benzoksi-L-alaninil)]-(*S*)-fosfat dijastereoizomerne čistoće veće od 85%.

Patent sadrži još 14 patentnih zahtjeva.

(11) **03733 (13) B**

(51) **C07D 401/14**^(2006.01)

C07D 413/04^(2006.01)

A61K 31/4439^(2006.01)

C07D 401/04^(2006.01)

A61K 31/4196^(2006.01)

A61P 9/00^(2006.01)

(21) P-2020-106

(22) 18.05.2016

(30) 201562164106 P 20.05.2015 US

(96) 16730076.3/18.05.2016

(86) US PCT/US2016/033088/18.05.2016

(87) WO 2016/187308/24.11.2016/2016/47

(97) EP 3300500/04.04.2018/2018/14

EP 3300500/26.02.2020/2020/09

(54) me **AGONISTI TRIAZOLA APJ RECEPTORA**
en **TRIAZOLE AGONISTS OF THE APJ RECEPTOR**

(73) Amgen Inc.

1 Amgen Center Drive, Thousand Oaks, California 91320-1799/ US

(72) CHEN, Ning

2342 Gillingham Circle, Thousand Oaks, California 91362/ US

CHEN, Xiaoqi

970 Blair Court, Palo Alto, California 94303/ US

CHEN, Yinhong

28873 Bailey Ranch Road, Hayward, California 94542/ US

CHENG, Alan C.

122 Stillings Avenue, San Francisco, California 94131/ US

CONNORS, Richard V.

3060 N. Ridgecrest Unit 202, Mesa, Arizona 85207/ US

DEIGNAN, Jeffrey

860 Head Street, San Francisco, California 94132/ US

DRANSFIELD, Paul John

86 Dickson Avenue, Arlington, Massachusetts 02474/ US

DU, Xiaohui

2735 Wemberly Drive, Belmont, California 94002/ US

FU, Zice

788 Santa Maria Lane, Foster City, California 94404/ US

HEATH, Julie Anne

1973 Lionsgate Way, Chico, California 95928/ US

HORNE, Daniel B.

7 Deer Path, Natick, Massachusetts 01760/ US

HOUZE, Jonathan

89 Antrim Street, Cambridge, Massachusetts 02139/ US

KALLER, Matthew R.

1644 Red Rock Avenue, Ventura, California 93004/ US

KHAKOO, Aarif Yusuf

271 Raymundo Drive, Woodside, California 94062/ US

KOPECKY, David John

12067 Guerin Street, Unit 202, Studio City, California 91604/ US

LAI, Su-Jen

665 Washington Street 1009, Boston, Massachusetts 02111/ US

MA, Zhihua

3 Allen Street, Lexington, Massachusetts 02421/ US

MCGEE, Lawrence R.

39 Big Sur Way, Pacifica, California 94044/ US
MEDINA, Julio C.
2879 Roland Avenue, San Carlos, California 94070/ US
MIHALIC, Jeffrey T.
857 Hayes Street, San Francisco, California 94117/ US
NISHIMURA, Nobuko
24050 Arminta Street, West Hills, California 91304/ US
OLSON, Steven H.
406 Green Hills Drive, Millbrae, California 94030/ US
PATTAROPONG, Vatee
74 South Road, Bedford, Massachusetts 01730/ US
SWAMINATH, Gayathri
121 Butterweed Lane, Brisbane, California 94005/ US
WANG, Xiaodong
11695 Standard Court, Johns Creek, Georgia 30097/ US
YANG, Kevin
8871 Camino Real Avenue, San Gabriel, California 91775/ US
YEH, Wen-Chen
2920 Belmont Woods Way, Belmont, California 94002/ US
DEBENEDETTO, Mikkel V.
299 River Street, Waltham, Massachusetts 02453/ US
FARRELL, Robert P.
1867 Sagra Street, Thousand Oaks, California 91362/ US
HEDLEY, Simon J.
319 Hodencamp Road Apt 79, Thousand Oaks, California 91360/ US
JUDD, Ted C.
17179 Braxton Street, Granada Hills, California 91344/ US
KAYSER, Frank
4150 17th Street 25, San Francisco, California 94114/ US

(57)

1. Jedinjenje sa Formulom I ili Formulom II:

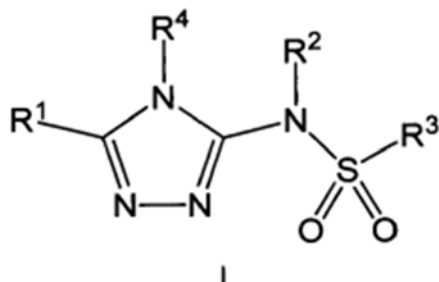

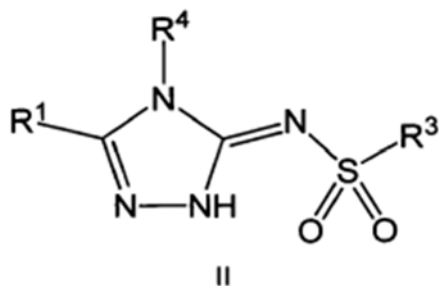

ili neka njegova farmaceutski prihvatljiva so, njegov tautomer, farmaceutski prihvatljiva so tautomera, stereoizomer bilo kog od prethodnih, ili njihova smeša, naznačeno time što:

R1 je nesupstituisan piridil, piridonil, ili piridin N-oksid, ili je piridil, piridonil, ili piridin N-oksid supstituisan sa 1, 2, 3, ili 4 supstituenta R1a;

R1a u svakom se slučaju nezavisno bira između -F, -Cl, -Br, -I, -CN, -C1-C6 alkil, -C1-C6 haloalkil, -C1-C6 perhaloalkil, -OH, -O-(C1-C6 alkil), -O-(C1-C6 haloalkil), -O-(C1-C6 perhaloalkil), -C2-C6 alkenil, -O-(C1-C6 alkil)-OH, -O-(C1-C6 alkil)-O-(C1-C6 alkil), -O-(C1-C6 haloalkil)-OH, -O-(C1-C6 haloalkil)-O-(C1-C6 alkil), -O-(C1-C6 perhaloalkil)-OH, -O-(C1-C6 perhaloalkil)-O-(C1-C6 alkil), -NH₂, -NH(C1-C6 alkil), -N(C1-C6 alkil)₂, -C(=O)-(C1-C6 alkil), -C(=O)OH, -C(=O)-O-(C1-C6 alkil), -C(=O)NH₂, -C(=O)NH(C1-C6 alkil), -C(=O)N(C1-C6 alkil)₂, fenil, -C(=O)-(heterociklil), ili heterociklil grupe, gde je heterociklil grupa -C(=O)-(heterociklil) ili heterociklil grupa je 3 do 7 člani prsten koji sadrži 1, 2, ili 3 heteroatoma izabranih između N, O, ili S;

R2 je izabran između -H, ili C1-C4 alkila ili je odsutan u jedinjenjima Formule II;

R3 je izabran iz grupe koja sadrži nesupstituisani C1-C10 alkil, C1-C10 alkil supstituisan sa 1, 2, ili 3 supstituenta R3a, grupe sa formulom -(CR_{3b}R_{3c})-Q, grupe sa formulom -NH-(CR_{3b}R_{3c})-Q, grupe sa formulom -(CR_{3b}R_{3c})-C(=O)-Q, grupe sa formulom -(CR_{3d}R_{3e})-(CR_{3f}R_{3g})-Q, grupe sa formulom -(CR_{3b}=CR_{3c})-Q, ili grupe sa formulom -(heterociklil)-Q, pri čemu heterociklil iz -(heterociklil)-Q ima 5 do 7 članova prstena od kojih 1, 2, ili 3 su heteroatomi izabrani između N, O, ili S i nesupstituisan je ili supstituisan sa 1, 2, ili 3 supstituenta R3h;

R3a u svakom se slučaju nezavisno bira između -F, -Cl, -CN, -OH, -O-(C1-C6 alkil), -O-(C1-C6 haloalkil), -O-(C1-C6 perhaloalkil), -O-(C1-C6 alkil)-OH, -O-(C1-C6 alkil)-O-(C1-C6 alkil), C2-C6 alkenil, C2-C6 alkinil, -NH₂, -NH(C1-C6 alkil), ili -N(C1-C6 alkil)₂;

R3b i R3c su nezavisno izabrani između -H, -F, -Cl, -CN, -C1-C6 alkil, -C1-C6 haloalkil, -C1-C6 perhaloalkil, -OH, -O-(C1-C6 alkil), -O-(C1-C6 haloalkil), -O-(C1-C6 perhaloalkil), -O-(C1-C6 alkil)-OH, -O-(C1-C6 alkil)-O-(C1-C6 alkil), -NH₂, -NH(C1-C6 alkil), ili -N(C1-C6 alkil)₂;

R3d i R3e su nezavisno izabrani između -H, -F, -Cl, -CN, -C1-C6 alkil, -C1-C6 haloalkil, -C1-C6 perhaloalkil, -OH, -O-(C1-C6 alkil), -O-(C1-C6 haloalkil), -O-(C1-C6 perhaloalkil), -O-(C1-C6 alkil)-OH, -O-(C1-C6 alkil)-O-(C1-C6 alkil), -NH₂, -NH(C1-C6 alkil), ili -N(C1-C6 alkil)₂;

R3f i R3g su nezavisno izabrani između -H, -F, -Cl, -CN, -C1-C6 alkil, -C1-C6 haloalkil, -C1-C6 perhaloalkil, -OH, -O-(C1-C6 alkil), -O-(C1-C6 haloalkil), -O-(C1-C6 perhaloalkil), -O-(C1-C6 alkil)-OH, -O-(C1-C6 alkil)-O-(C1-C6 alkil), -NH₂, -NH(C1-C6 alkil), ili -N(C1-C6 alkil)₂;

R3h u svakom se slučaju nezavisno bira između -F, -Cl, -CN, -C1-C6 alkil, -C1-C6 haloalkil, -C1-C6 perhaloalkil, -OH, -O-(C1-C6 alkil), -O-(C1-C6 haloalkil), -O-(C1-C6 perhaloalkil), -O-(C1-C6 alkil)-OH, -O-(C1-C6 alkil)-O-(C1-C6 alkil), -NH₂, -NH(C1-C6 alkil), -N(C1-C6 alkil)₂, ili okso;

Q je monociklična ili biciklična grupa C3-C10 aril, monociklična ili biciklična heteroarilna grupa sa 5 do 10 članova prstena koji sadrže 1, 2, ili 3 heteroatoma izabranih između N, O, ili S, C3-C8 cikloalkilna grupa, ili 3 do 7-člana heterociklil grupa koja sadrži 1, 2, ili 3 heteroatoma izabranih između N, O, ili S, pri čemu su grupa C6-C10 aril, heteroarilna grupa, cikloalkilna grupa, i heterociklil grupa nesupstituisane ili su supstituisane sa 1, 2, 3, ili 4 supstituenta RQ;

RQ u svakom se slučaju nezavisno bira između -F, -Cl, -Br, -I, -CN, -C1-C6 alkil, -C1-C6 haloalkil, -C1-C6 perhaloalkil, -C2-C6 alkenil, -C2-C6 alkinil, -OH, -O-(C1-C6 alkil), -O-(C1-C6 haloalkil), -O-(C1-C6

perhaloalkil), -NH₂, -NH(C1-C6 alkil), -N(C1-C6 alkil)₂, -C(=O)-(C1-C6 alkil), -C(=O)OH, -C(=O)-O-(C1-C6 alkil), -C(=O)NH₂, -C(=O)NH(C1-C6 alkil), -C(=O)N(C1-C6 alkil)₂, -S(=O)₂-(C1-C6 alkil), fenil, ili heteroarilne grupe, i Q heterociklična grupa može biti supstituisana sa 1 okso RQ supstituentom;

R4 je izabran između monociklične ili biciklične grupe C6-C10 aril, monociklične ili biciklične heteroarilne grupe sa 5 do 10 članova prstena koji sadrže 1, 2, ili 3 heteroatoma nezavisno izabrana između N, O, ili S, ili monociklične ili biciklične heterociklične grupe sa 5 do 10 članova prstena koji sadrže 1, 2, 3, ili 4 heteroatoma nezavisno izabrana između N, O, ili S, pri čemu su grupa C6-C10 aril, heteroarilna grupa ili heterociklična grupa nesupstituisane ili su supstituisane sa 1, 2, ili 3 supstituenta R4a;

R4a u svakom se slučaju nezavisno bira između -F, -Cl, -Br, -I, -CN, -C1-C6 alkil, -C1-C6 haloalkil, -C1-C6 perhaloalkil, -OH, -O-(C1-C6 alkil), -O-(C1-C6 haloalkil), -O-(C1-C6 perhaloalkil), -NH₂, -NH(C1-C6 alkil), -N(C1-C6 alkil)₂, -C(=O)-(C1-C6 alkil), -C(=O)OH, -C(=O)-O-(C1-C6 alkil), -C(=O)NH₂, -C(=O)NH(C1-C6 alkil), ili -C(=O)N(C1-C6 alkil)₂, te heterociklična R4 grupa može dalje biti supstituisana sa 1 okso supstituentom; i

dalje pri čemu:

ako je R4 nesupstituisan ili supstituisan fenilni prsten i R3 je grupa sa formulom -(CR_{3b}=CR_{3c})-Q, onda je bar jedno od sledećeg tačno:

- a) R4 je supstituisan sa najmanje jednom grupom -O-(C1-C6 alkil);
- b) Q nije oksadiazol;
- c) R_{3b} nije -H;
- d) R_{3c} nije -H;
- e) R1 nije grupa 2-piridil; ili
- f) R4 je supstituisan sa dve ili više grupa -O-(C1-C6 alkil).

Patent sadrži još 29 patentnih zahtjeva.

(11) **03734 (13) B**

(51) **A61K 38/13**^(2006.01)

A61K 38/26^(2006.01)

A61P 9/10^(2006.01)

(21) P-2020-107

(22) 04.11.2016

(30) 20150100486 06.11.2015 GR

(96) 16802132.7/04.11.2016

(86) IB PCT/IB2016/001582/04.11.2016

(87) WO 2017/077378/11.05.2017/2017/19

(97) EP 3370756/12.09.2018/2018/37

EP 3370756/08.04.2020/2020/15

(54) me **KOMBINACIJA KANRENOATA I Ei<SENATIDA**
en **COMBINATION OF CANRENOATE AND EXENATIDE**

(73) Genesis Pharma SA

270 Kifissias Avenue, 15232 Athens/ GR

(72) VOGIATZIS, George

270 Kifissias Avenue, 15232 Athens/ GR

(57)

1. Kombinacija koja sadrži modulator insulina, gde je modulator insulina eksenatid ili njegova farmaceutski prihvatljiva so, i antagonist aldosterona, gde je antagonist aldosterona kalijum kanrenoat.

Patent sadrži još 20 patentnih zahtjeva.

(11) **03739 (13) B**

(51) A61K 9/48 ^(2006.01)	A61P 3/02 ^(2006.01)
A61P 3/12 ^(2006.01)	A61P 3/14 ^(2006.01)
A61P 5/18 ^(2006.01)	A61P 7/00 ^(2006.01)
A61P 43/00 ^(2006.01)	A61K 47/14 ^(2017.01)
A61K 31/047 ^(2006.01)	A61P 1/04 ^(2006.01)
A61P 13/12 ^(2006.01)	A61P 19/00 ^(2006.01)
A61P 9/02 ^(2006.01)	A61P 9/08 ^(2006.01)
A61P 1/00 ^(2006.01)	A61P 19/08 ^(2006.01)
A61P 19/02 ^(2006.01)	A61P 19/10 ^(2006.01)

(21) P-2020-108

(22) 05.02.2016

(30) 15382042 06.02.2015 EP

(96) 16702960.2/05.02.2016

(86) EP PCT/EP2016/052458/05.02.2016

(87) WO 2016/124724/11.08.2016/2016/32

(97) EP 3204047/16.08.2017/2017/33

EP 3204047/27.05.2020/2020/22

(54) me **MEKE KAPSULE KALCIFEDIOLA**
en **CALCIFEDIOL SOFT CAPSULES**

(73) FAES FARMA, S.A.

Autonomía, 10, 48940 Leioa - Vizcaya/ ES

(72) SUÑÉ NEGRE, Josep María

Juan XXIII, s/nEdificio A, Escalera A, planta baja, 08028 Barcelona/ ES

ORTEGA AZPITARTE, Ignacio

Faes Farma S.A, Autonomía 10, 48940 Leioa - Vizcaya/ ES

DEL ARENAL BARRIOS, Pepa

Faes Farma S.A, Autonomía 10, 48940 Leioa - Vizcaya/ ES

HERNÁNDEZ HERRERO, Gonzalo

Faes Farma S.A, Autonomía 10, 48940 Leioa - Vizcaya/ ES

(57)

I. Meka kapsula koja uključuje:

a) omotač meke kapsule, pri čemu omotač meke kapsule sadrži:

- 40 do 80 mas.% zelatina,

- 10 do 50 mas.% plastifikatora koji je izabran iz grupe koja se sastoji od glicerola, sorbitola, propilen glikola, polietilen glikola, dibutil sebakata, dietil ftalata, dimetil ftalata, triacetina, tributil citrata, trietil citrata, i njihovih smeša,

količine po masi su izražene u odnosu na ukupnu masu omotača meke kapsule; i

b) farmaceutsku kompoziciju koja sadrži:

- kalcifediol,

- uljanu komponentu izabranu iz grupe koja se sastoji od triglicerida srednjeg lanca, izopropil miristrata, C14-C18 alkil alkohola, C14-C18 alkenil alkohola, lanolin alkohola i njihovih smeša, i

- farmaceutski prihvatljivog organskog rastvarača izabranog iz grupe koja se sastoji od etanola, izopropanola, propilen glikola, polietilen glikola, benzilalkohola i njihovih smeša,

pri pčemu omotač meke kapsule inkapsulira farmaceutsku kompoziciju i gde pomenuta farmaceutska kompozicija je lišena voska.

Patent sadrži još 13 patentnih zahtjeva.

(11) **03731 (13) B**

(51) **A61K 31/31**^(2006.01)

A61P 25/28^(2006.01)

A61K 31/496^(2006.01)

A61K 31/445^(2006.01)

(21) P-2020-109

(22) 03.08.2016

(30) 201641017205 18.05.2016 IN

(96) 16766622.1/03.08.2016

(86) IB PCT/IB2016/054673/03.08.2016

(87) WO 2017/199071/23.11.2017/2017/47

(97) EP 3484467/22.05.2019/2019/21

EP 3484467/29.04.2020/2020/18

(54) me **KOMBINACIJA ČISTIH ANTAGONJSTA 5-HT6 RECEPTORA SA INHIBITORIMA**

ACETILHOLINESTERAZE

en **COMBINATION OF PURE 5-HT6 RECEPTOR ANTAGONISTS WITH**

ACETYLCHOLINESTERASE INHIBITORS

(73) Suven Life Sciences Limited

5th Floor Serene Chambers Road No. 5 Off Avenue 7 Banjara Hills, Hyderabad, Telangana 500034/ IN

(72) NIROGI, Ramakrishna

Serene Chambers Road-5 Avenue 7 Banjara Hills, Hyderabad Telangana 500034/ IN

SHINDE, Anil Karbhari

Serene Chambers Road-5 Avenue 7 Banjara Hills, Hyderabad Telangana 500034/ IN

JAYARAJAN, Pradeep

Serene Chambers Road-5 Avenue 7 Banjara Hills, Hyderabad Telangana 500034/ IN

BHYRAPUNENI, Gopinadh

Serene Chambers Road-5 Avenue 7 Banjara Hills, Hyderabad Telangana 500034/ IN

KAMBHAMPATI, Ramasastru

Serene Chambers Road-5 Avenue 7 Banjara Hills, Hyderabad Telangana 500034/ IN

JASTI, Venkateswarlu

Serene Chambers Road-5 Avenue 7 Banjara Hills, Hyderabad Telangana 500034/ IN

(57)

1.Kombinacija, **naznačena time**, što sadrži isti antagonist 5-HT6 receptora i inhibitor acetilholinesteraze, pri čemu:

čisti antagonist 5-HT6 receptora se bira između

1-((2-bromofenil)sulfonil]-5-metoksi-3-[(4-metil-1-piprazinil)metil]-1H-indola;

1-[(4-fluorofenil)sulfonil]-5-metoksi-3-[(4-metil-1-piperazinil)metil]-1H-indola; i

1-[(4-izopropilfenil)sulfoni]-5-metoksi-3-[(4-metil-1-piperazinil)metil]-1H-indola;

ili farmaceutski prihvatljive soli istog.

Patent sadrži još 16 patentnih zahtjeva.

(11) **03714 (13) B**

(51) **A61K 48/00**^(2006.01)

C12N 9/12^(2006.01)

A61K 39/00^(2006.01)

(21) P-2020-11

(22) 28.10.2014

(30) 13190547 28.10.2013 EP

(96) 14790592.1/28.10.2014

(86) EP PCT/EP2014/073164/28.10.2014

(87) WO 2015/063117/07.05.2015/2015/18

(97) EP 3062824/07.09.2016/2016/36

EP 3062824/27.11.2019/2019/48

(54) me **DNK VAKCINA ZA KODIRANJE TELOMERAZE**

en **A TELOMERASE ENCODING DNA VACCINE**

(73) Invectys

28 rue du Docteur Roux, 75015 Paris/ FR

(72) LANGLADE DEMOYEN, Pierre

92 avenue Charles-de-Gaulle, F-92200 Neuilly-sur-Seine/ FR

WAIN-HOBSON, Simon

3 rue Jean de la Fontaine, F-78180 Montigny-le-Bretonneux/ FR

HUET, Thierry

21-23 rue Lequesne, F-94130 Nogent sur Marne/ FR

LIARD, Christelle

21 avenue Saint-Exupéry, F-92320 Chatillon/ FR

PLIQUET, Elodie

32 rue Marcel Bonnet, 94230 Cachan/ FR

(57)

1. Konstrukt nukleinske kiseline koji obuhvata sekvencu koja kodira protein humane reverzne transkriptaze telomeraze (hTERT), koji je lišen katalitičke aktivnosti telomeraze i signala nukleolarne lokalizacije, pri čemu je hTERT protein fuzionisan na N-terminusu ubikvitinom ili kalretikulinom.

Patent sadrži još 14 patentnih zahtjeva.

(11) **03735** (13) **B**

(51) **C07D 471/18**^(2006.01)

A61K 45/06^(2006.01)

A61K 31/551^(2006.01)

A61K 31/407^(2006.01)

A61K 31/427^(2006.01)

A61K 31/4545^(2006.01)

A61K 31/496^(2006.01)

A61K 31/5025^(2006.01)

A61K 31/546^(2006.01)

A61P 31/04^(2006.01)

A61K 31/431^(2006.01)

(21) P-2020-111

(22) 28.09.2017

(30) 201662401022 P 28.09.2016 US

(96) 17791737.4/28.09.2017

(86) IB PCT/IB2017/055973/28.09.2017

(87) WO 2018/060926/05.04.2018/2018/14

(97) EP 3519419/07.08.2019/2019/32

EP 3519419/27.05.2020/2020/22

(54) me **INHIBITORI BETA-LAKTAMAZE**
en **BETA-LACTAMASE INHIBITORS**

(73) NOVARTIS AG

Lichtstrasse 35, Basel, 4056/ CH

(72) CASAREZ, Anthony

5300 Chiron Way, Emeryville, California 94608/ US

FUREGATI, Markus

Postfach, 4002 Basel/ CH

KOCH, Guido

Postfach, 4002 Basel/ CH

LIN, Xiaodong

5300 Chiron Way, Emeryville, California 94608/ US

OSSOLA, Flavio

Postfach, 4002 Basel/ CH

RECK, Folkert

5300 Chiron Way, Emeryville, California 94608/ US

SIMMONS, Robert Lowell

5300 Chiron Way, Emeryville, California 94608/ US

ZHU, Qingming

5300 Chiron Way, Emeryville, California 94608/ US

(57)

1. Jedinjenje formule (A):

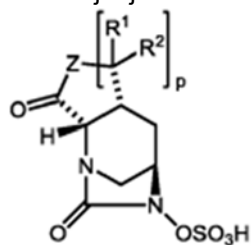

u kojoj p je 1 ili 2;

R1 i R2 su nezavisno odabrani od H i C1-C4 alkila opciono supstituisanog sa do tri grupe odabrane od halo, CN, -OR, okso, i -NRR';

Z je NR3 ili N-OR3;

R3 je nezavisno odabran pri svakom pojavljivanju od H, Cy, i C1-C4 alkila opciono supstituisanog sa do tri grupe odabrane od Cy, halo, CN, -OR, i -NRR';

Cy je C3-C6 cikloalkilni prsten ili 4-6 člani heterociklični prsten koji sadrži jedan ili dva heteroatoma odabrana od N, O i S kao članovi prstena, a Cy je opciono supstituisan sa do tri grupe odabrane od okso, halo, C1-C2 alkila, CN, -OR, i -NRR'; a R i R' su nezavisno odabrani od H i C1-C4 alkila opciono supstituisanog sa jednom ili dve grupe odabrane od halo, -OH, -CN, -O-(C1-C4 alkila), okso, -NH₂, -NH(C1-C4 alkila), i -N(C1-C4 alkila)₂,

ili R i R' uzeti zajedno sa atomom azota za koji su vezani mogu da obrazuju prsten odabran od grupe koju čine piperidin, morfolin, pirolidin, i azetidin, pri čemu je taj prsten opciono supstituisan sa jednom ili dve grupe odabrane od halo, C1-C2 alkila, -OH, -CN, -O-(C1-C4 alkila), okso, -NH₂, -NH(C1-C4 alkila), i -N(C1-C4 alkila)₂;

ili njegova so ili cviterjonski oblik.

Patent sadrži još 19 patentnih zahtjeva.

(11) **03738 (13) B**

(51) **C07D 491/04**^(2006.01)

C07D 401/14^(2006.01)

C07D 513/04^(2006.01)

A61K 31/4985^(2006.01)

A61P 31/04^(2006.01)

C07D 471/04^(2006.01)

C07D 498/04^(2006.01)

C07D 493/04^(2006.01)

A61K 31/436^(2006.01)

(21) P-2020-112

(22) 05.06.2017

(30) 16173550 08.06.2016 EP

(96) 17732775.6/05.06.2017

(86) EP PCT/EP2017/063600/05.06.2017

(87) WO 2017/211759/14.12.2017/2017/50

(97) EP 3468975/17.04.2019/2019/16

EP 3468975/01.04.2020/2020/14

(54) me **NOVI ANTIBAKTERIJSKI SPOJEVI**
en **NEW ANTIBACTERIAL COMPOUNDS**

(73) Aziende Chimiche Riunite Angelini Francesco A.C.R.A.F.S.p.A.

Viale Amelia, 70, Roma, 00181/ IT

(72) OMBRATO, Rosella

Via Abigaille Zanetta 68, 00143 ROMA/ IT

MAGARO', Gabriele

Via IV Novembre 18, 00072 Ariccia (RM)/ IT

GAROFALO, Barbara

Via Latina 49, 00179 ROMA/ IT

FURLOTTI, Guido

Via Ferdinando Palasciano 96, 00151 ROMA/ IT

MANGANO, Giorgina

Via Gran Paradiso 84, 00139 ROMA/ IT

CAPEZZONE DE JOANNON, Alessandra

Piazza dei Vespri Siciliani 7, 00161 ROMA/ IT

(57)

1. Spoj, **naznačen time, da** je predstavljen sljedećom formulom (1):

A-L1-Y-L2-R-B (1)

u kojoj

A je ciklička skupina koja ima sljedeću formulu (II):

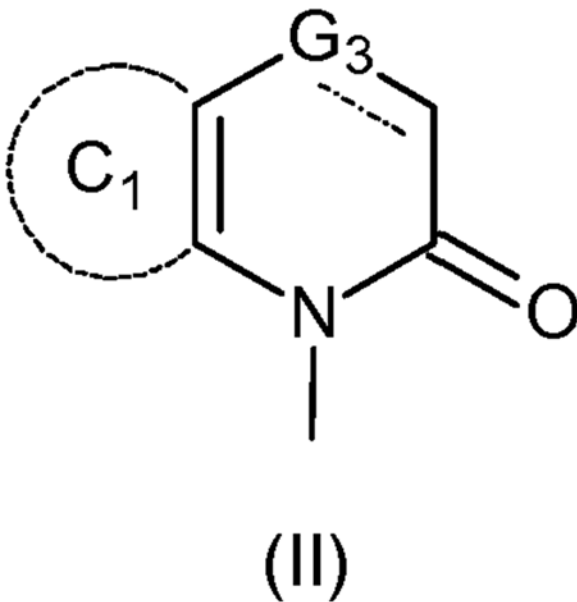

gdje

G3 je CH ili N, kada crtkana linija predstavlja dvostruku vezu, ili je CH₂, NH ili O, kada crtkana linija predstavlja jednostruku vezu;

C1 predstavlja atome koji su potrebni za tvorbu alifatskog ili aromatskog šesteročlanog prstena koji izborno sadrži jedan ili više heteroatoma odabranih od atoma dušika i atoma kisika, dok je navedeni prsten izborno supstituiran s jednim ili više supstituenata koji su odabrani iz skupine koja se sastoji od atoma halogena, (C1-3)alkil-skupine, cijano-skupine, okso-skupine (=O) i (C1-3)alkoksi-skupine;

L1 je d-veza ili (C1-3)alkilenil-skupina izborno supstituirana s hidroksi-skupinom;

Y je prsten odabran iz skupine koja se sastoji od sljedećih prstena: piperidinila, piperazinila, pirolidinila, 1,3-ciklobutila, 1,3-ciklopentila, 1,2-ciklopropila, azetidinila, azabicyklo-oktila, morfolinila i cikloheksila, pri čemu je navedeni prsten izborno supstituiran s jednim ili više supstituenata koji su odabrani iz skupine koja se sastoji od hidroksi-skupine, (C1-3)alkilenil-OH-skupine,

(C1-3)alkilenil-O-(C1-3)alkil-skupine, (C1-3)alkilenil-CONR'R"-skupine i

CONR'R"-skupine, gdje su R' i R" atom vodika ili (C1-3)alkil;

L2 je d-veza, -(C1-3)alkilenil-skupina, NR'''-skupina, NR'''-(C1-3)alkilenil-skupina,

(C1-3)alkilenil-NR'''-skupina, NR'''-(C1-3)alkilenil-NR'''-skupina ili

(C1-3)alkilenil-NR'''-(C1-3)alkilenil-skupina, gdje je navedena skupina izborno supstituirana s hidroksi-skupinom, dok R''' je vodik, (C1-3)alkil, (C1-3)alkilenil-OH,

(C1-3)alkilenil-O-(C1-3)alkil ili (C1-3)alkilenil-CONR'R", pri čemu su R' i R" atom vodika ili (C1-3)alkil;

R je d-veza ili heterociklički, alifatski ili aromatski prsten koji ima pet članova s jednim ili više atoma dušika, koji je izborno supstituiran sa CH₂OH, CH₂CN, CN ili CONR'R", pri čemu R' i R" predstavljaju atom vodika ili (C1-3)alkil; te

B je ciklička skupina koja ima sljedeću formulu (VI):

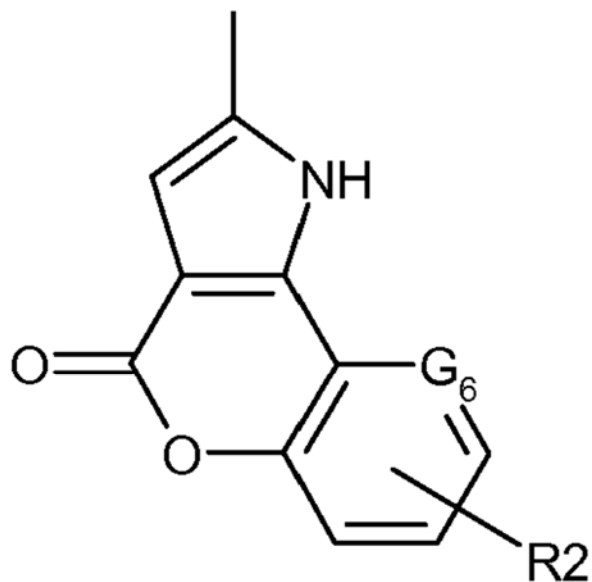

(VI)

u kojoj

G₆ je CH ili N;

R₂ je atom vodika ili atom halogena;

i adicijske soli s farmaceutski prihvatljivim organskim ili anorganskim kiselinama ili lužinama, enantiomeri, N-oksidi i kvaternarne amonijeve soli navedenog spoja formule (1).

Patent sadrži još 14 patentnih zahtjeva.

(11) **03694** (13) **B**

(51) **C07K 16/28**^(2006.01)

C12N 15/13^(2006.01)

A61K 39/395^(2006.01)

A61K 39/00^(2006.01)

(21) P-2020-12

(22) 27.05.2016

(30) 201562168425 P 29.05.2015 US

(96) 16728520.4/27.05.2016

(86) US PCT/US2016/034716/27.05.2016

(87) WO 2016/196314/08.12.2016/2016/49

(97) EP 3303395/11.04.2018/2018/15

EP 3303395/11.12.2019/2019/50

(54) me **ANTI-CD40 ANTITELA I NJIHOVE UPOTREBE**
en **ANTI-CD40 ANTIBODIES AND USES THEREOF**

(73) AbbVie Inc.

1 North Waukegan Road, North Chicago, IL 60064/ US

(72) BENATUIL, Lorenzo

33 Mohawk Drive, Northborough, MA 01532/ US

ARGIRIADI, Maria A.

15 Sadie Hutt Lane, Southborough, MA 01772/ US

MCRAE, Bradford L.

84 Pleasant Street, Northborough, MA 01532/ US

HSIEH, Chung-Ming

22 Olde Field Road, Newton, MA 02459/ US

EGAN, David A.

321 Gadusi Lane, Loudon, TN 37774/ US

HARLAN, John E.

689 Portree Lane, Lake Zurich, IL 60047/ US

JUDGE, Russell A.

5186 Alder Court, Gurnee, IL 60031/ US

WANG, Rui

122 Lowell Ave, Newton, MA 02460/ US

KINGSBURY, Gillian A.

46 Aqueduct Road, Wayland, MA 01778/ US

(57)

1. Anti-CD40 antitelo koga čine teški lanac koji sadrži aminokiselinsku sekvencu kao što je navedeno u SEQ ID NO: 41 i laki lanac koji sadrži aminokiselinsku sekvencu kao što je navedeno u SEQ ID NO: 40.

Patent sadrži još 7 patentnih zahtjeva.

(11) **03721 (13) B**

(51) **C07D 487/04**^(2006.01)

A61P 1/00^(2006.01)

A61P 11/06^(2006.01)

A61P 35/00^(2006.01)

A61K 31/519^(2006.01)

A61P 11/00^(2006.01)

A61P 27/02^(2006.01)

(21) P-2020-129

(22) 09.03.2011

(30) 312588 P 10.03.2010 US

415602 P 19.11.2010 US

(96) 17211097.5/09.03.2011

(97) EP 3354652/01.08.2018/2018/31

EP 3354652/06.05.2020/2020/19

(54) me **PIPERIDIN-4-IL AZETIDIN DERIVATI KAO INHIBITORI JAK1**
en **PIPERIDIN-4-YL AZETIDINE DERIVATIVES AS JAK1 INHIBITORS**

(73) Incyte Holdings Corporation

1801 Augustine Cut-Off, Wilmington, DE 19803/ US

(72) HUANG, Taisheng

522 Chariot Court, Wilmington, DE 19808/ US

XUE, Chu-Biao

307 Wellspring Court, Hockessin, DE 19707/ US

WANG, Anlai

c/o Incyte Corporation 1801 Augustine Cut-Off, Wilmington, Delaware 19803/ US

KONG, Ling

5 Fritze Court, Hockessin, DE 19707/ US

YE, Hai Fen

45 West Park Place, Newark, DE 19711/ US

YAO, Wenqing

748 Meadowbank Road, Kennett Square, PA 19348/ US

RODGERS, James D.

c/o Incyte Corporation 1801 Augustine Cut-Off, Wilmington, Delaware 19803/ US

SHEPARD, Stacey

2200 C Inglewood Road, Wilmington, DE 19803/ US

WANG, Haisheng

207 Hockessin Circle, Hockessin, DE 19707/ US

SHAO, Lixin

20 Presidential Drive Apt C, Wilmington, DE 19807/ US

LI, Hui-Yin

c/o Incyte Corporation 1801 Augustine Cut-Off, Wilmington, Delaware 19803/ US

LI, Qun

10 Crompton Court, Newark, DE 19702/ US

(57)

1. Jedinjenje, koje je {1-{1-[3-fluoro-2-(trifluorometil)izonikotinoil]piperidin-4-ii{-3-[4-{7H-pirolol[2,3-d]pirimidin-4-ii}-1H-pirazo-1-ii]azetid-3-ii}acetonitril, iii njegova farmaceutski prihvatljiva so, za upotrebu u leenju bolesti vezi sa JAK izabrane izmedu:

(a) ulceroznog kolitisa;

(b) hronilne opstruktivne bolesti pluta (COPD); (c) pemfigus vulgarisa;

- (d) astme;
- (e) sistemskog eritemskog lupusa;
- (f) skleroderme;
- (g) ankilozirajućeg spondilitisa;
- (h) akutne limfoblastne leukemije (ALL);
- (i) akutne mijelogenozne leukemije (AML);
- (j) limfoma kolnih T-telija (CTCL); (k) fungoidne mikoze ;
- (l) kancera debelog creva; (m) kolorektalnog kancera;
- (n) post-esencijalne trombocitemije mijelofibroze (Post-ET MF); (o) post policitemije vera mijelofibroze (Post-PV MF);
- (p) akneiformnog osipa; (q) sarkoidoze;
- (r) rinitisa;
- (s) sinuzitisa; (t) blefaritisa;
- (u) konjuktivitisa; (v) uveitisa;
- (w) skleritisa ; (x) iritisa;
- (y) kaheksije;
- (z) sindroma sistemskog inflamatornog odgovora (SIRS);
- (aa) septičkog ka.

Patent sadrži još 14 patentnih zahtjeva.

(11) **03715 (13) B**

(51) C07D 405/14 ^(2006.01)	C07D 401/10 ^(2006.01)
C07D 235/16 ^(2006.01)	C07D 403/10 ^(2006.01)
C07D 405/10 ^(2006.01)	C07D 471/04 ^(2006.01)
C07D 487/04 ^(2006.01)	C07D 491/10 ^(2006.01)
C07D 209/14 ^(2006.01)	C07D 209/18 ^(2006.01)
A61K 31/404 ^(2006.01)	A61K 31/416 ^(2006.01)
A61P 29/00 ^(2006.01)	A61P 37/00 ^(2006.01)

(21) P-2020-13

(22) 08.06.2016

(30) PCT/IB2015/001693 09.06.2015 WO
201562257806 P 20.11.2015 US
201662343905 P 01.06.2016 US

(96) 16731721.3/08.06.2016

(86) US PCT/US2016/036283/08.06.2016

(87) WO 2016/200851/15.12.2016/2016/50

(97) EP 3307734/18.04.2018/2018/16

EP 3307734/27.11.2019/2019/48

(54) me **MODULATORI NUKLEARNIH RECEPTORA (ROR) ZA LEČENJE INFLAMATORNIH I
AUTOIMUNI OBOLJENJA**
en **NUCLEAR RECEPTOR MODULATORS (ROR) FOR THE TREATMENT OF INFLAMMATORY
AND AUTOIMMUNE DISEASES**

(73) AbbVie Inc.

1 North Waukegan Road, North Chicago, IL 60064/ US

(72) ARGIRIADI, Maria A.

15 Sadie Hutt Lane, Southborough, MA 01772/ US

BREINLINGER, Eric C.

54 Hanson Road, Charlton, MA 01507/ US

CUSACK, Kevin P.

115 Jennifer Drive, Holden, MA 01520/ US

HOBSON, Adrian D.

25 Holman Street, Shrewsbury, MA 01545/ US

POTIN, Dominique

23 Chemin de Daix, 21240 Talant/ FR

BARTH, Martine

20 rue Claude deschault, 21380 Asnières les Dijon/ FR

AMAUDRUT, Jérôme

30 boulevard Rembrandt, 21000 Dijon/ FR

POUPARDIN, Olivia

11 promenade du fort, 21490 Varios et Chaignot/ FR

MOUNIER, Laurent

3 Route de Savigny, 21380 Marsannay le Bois/ FR

KORT, Michael E.

507 Green Avenue, Lake Bluff, IL 60044/ US

(57)

Jedinjenje Formuie (1-a):

iii njegova farmaceutska prihvatljiva so, naznaceno time, da:

G i J su nezavisno eH iii N;

W je eiii eRa, L 1 je povezan sa W iii Y; i

A i E su nezavisno e iii N pod usiovomda oba nisu N;

V je eR3 iiiN;

Xje eRa,NR 8

L1 je povezan saW iii Y; I A i E su nezavisno e iii N pod usiovom da oba nisu N; V je eR3 iii N; Xje eRa,NRa iii N; Y je C, CRa ili N; Zje CR3 ili N; i1i

L1 je -CH2-, i1i-C(O); L2 je -C(O)-; R 1 i R2 su nezavisno halogen,-O-(C1-C3) alkil, ciklopropil, i1i (C1-C3) alkil; svaki R3 je nezavisno -H, -CF3, -CN, halogen, -OCHF2, -OCF3, -C(O)N(Rc)2, -NReCORc, -(C1 -C3) alkil, -O-(C1 -C3) alkil, -S-(C1-C3) alkil, (C3-C6) cikloalkil, ili morfolinil; R4 je (CJ-C6) alkil opcionosupstituisan sajednim ili viSe supstituenata nezavisno odabranih od halo, -C02H, ili -C02(C1-C4) alkila; ili R4 je -NH-CH2-tetrahidro-2H- piranil opciono supstituisan sa jednim ili dva

Supstituenta nezavisno odabranih od -OH i -O(C1 -C4) alkila; ili R4 je -N(H)-(C3-C6) cikloalkil opciono supstituisan sajednimili vise supstituenata nezavisno odabranih od F, -OH, -COOH, i -C02(C1-C4) alkila; ili R4 je (C3-C6) cikloalkil opciono supstituisan sa jednim ili vise supstituenata nezavisno odabranih od F, -OH, -COOH, i -C02(C1-C4) alkila; ili R4 je azabiciklo [2.2.1]heptanil ili azabiciklo[3.1.0] heksanil, svaki opciono supstituisan sa -C02H ili -C02 (C1 -C4) alkilom; ili je azaspiro [3.3] heptanil opciono supstituisan sa -CH2C02H, -CH2C02CH3, -

-C02 CH3; ili R4 je 2-oksa-6-azaspiro [3.3] heptanil,2-oksa-7-azaspiro [3.5] nonanil,ili 2-oksa-8- azaspiro [4.5] dekanil, svaki opciono supstituisan sa -CH2C02H; ili R4 je azetidinil opciono supstituisan sajednim ili dva supstituenta nezavisno izabrana od -CH3, -OH, -OCH3,-(C1-C4) alkilen-OH, -CH2OCH3, -(C1-C4) alkilen O(C1-C4) alkila, -C02 (C1-C4) alkila, -C02H, -(C1-C4) alkilen-C02H, -(C1-C4) alkilen- C02-(C1-C4) alkila, -N(CH3)2, ili piroolidinilskih grupa;ili R4 je 1,2-diazepanil ili 1,4-diazepanil,svaki opciono supstituisan sa -(C1 -C4) alkilen- OH; ili R4 je morfolinilopciono supstituisan sa =0; ili vise R je piperazinil, piperidinil, ili piroolidinil, svaki opciono supstituisan sa jednim ili supstituenata nezavisnoizabranih od -halo, -CN, -(C1-C4) alkila, -CH2-ciklopropila,- (C1-C4) alkilen-F, -CF3, -CH2CF3,-COOH, -(C1-C4) alkilen COOH, -CH(OH)C02H,- COCH3, -C02 (C1-C4) alkila, -CH(OH)C02CH3, -(Ct-C4)alkilen-C (=0) 0 (C1-C4)alkila, -(C1-C4) alkilen-OH, -OH, -O(C1-C4) alkila, -(C1-C4) alkilen 0 (C1-C4) alkila,- O(C1-C4) a1ki1en C02H, -O(C1-C4) a1kilen C(=O) 0 (C1-C4) alki1a, -CONHCH3,- (C1-C4) alkila, -NH2, -NH(C1-C4) alkila, -N((C1-C4) alkil)2, ciklobutankarboksilne kiseline, i oksetani1a; svaki R8 je nezavisno H, -C(O)CH3, opciono supstituisani (Cl-C6) alki1, opciono supstituisani (C3-C6) cikloalkil ili -S(0)2-fenil; I Re je nezavisnoH i1i (C1-C3) a1ki1; pod us1ovom da više od dva A, E, W, X i Y nisu N.

Patent sadrži još 20 patentnih zahtjeva.

(11) **03722 (13) B**

(51) **A61K 9/20**^(2006.01)

A61K 31/4045^(2006.01)

(21) P-2020-130

(22) 06.08.2014

(30) 201361863325 P 07.08.2013 US

201361913066 P 06.12.2013 US

(96) 14753182.6/06.08.2014

(86) EP PCT/US2014/049940/06.08.2014

(87) WO 2015/021153/12.02.2015/2015/06

(97) EP 3030227/15.06.2016/2016/24

EP 3030227/08.04.2020/2020//15

(54) me **DOZNI OBLICI SA PRODUŽENIM OSLOBADANJEM ZA JAK1 INHIBITOR**
en **SUSTAINED RELEASE DOSAGE FORMS FOR A JAK1 INHIBITOR**

(73) INCYTE CORPORATION

1801 Augustine Cut-Off, Wilmington, DE 19803/ US

(72) YELESWARAM, Krishnaswamy

136 Harrogate Drive, Landenberg, Pennsylvania 19350/ US

, PARIKH, Bhavnish

120 Portmarnock Drive Avondale, Avondale, Pennsylvania 19311/ US

, MODI, Dilip P.

59 E. Periwinkle Lane, Newark, Delaware 19711/ US

, SHETH, Trupti

23 Winding Road, Newark, Delaware 19702/ US

(57)

1. {1-{1-[3-Fiuoro-2-(trifluorometil)izonikotinoil]piperidin-4-II}-3-[4-(7H-pirololo[2,3-d]pirimidin-4-ii)-1H-pirazol-1-il]azetidin-3-il}acetonitril, iii njegova farmaceutske prihvatljiva so, za upotrebu u postupku lefenja autolmune bolesti, kancera, mijeloproliferativnog poremetaja, inflamatorne bolesti, boiesti resorpcije kostiju, odbacivanja transplanta organa kod pacijenta kome je potrebno, kojiobuhvata oralno davanje pomenutom pacijentu jednom dnevno doze od 200 mg, 300 mg, iii 600 mg na osnovu siobodne baze {1-{1-[3-fluoro-2-(trifluorometil)izonikotinoil]piperidin-4-II}-3-[4-(7H-pirololo[2,3-d]pirimidin-4-ii)-1H-pirazol-1-il]azetidin-3-il} acetonitrila, iii njegove farmaceutske prihvatljive soli, gde doza sadrii jedan iii viSe doznih oblika sa produfenim osiobaclanjem pri temu svaki sadrii {1-{1-[3-fluoro-2-(trifluorometil)izonikotinoil]piperidin-4-ii)-3-[4-(7H-pirololo[2,3-d]pirimidin-4-ii)-1H-pirazol-1-il]azetidin-3-il}acetonitrii, iii njegovu farmaceutske prihvatljivu so.

Patent sadrii još 29 patentnih zahtjeva.

(11) **03683** (13) **B**

(51) **B65D 75/32**^(2006.01)

B65B 9/04^(2006.01)

(21) P-2020-14

(22) 18.08.2016

(30) 15182316 25.08.2015 EP

(96) 16757603.2/18.08.2016

(86) EP PCT/EP2016/069560/18.08.2016

(87) WO 2017/032674/02.03.2017/2017/09

(97) EP 3341303/04.07.2018/2018/27

EP 3341303/20.11.2019/2019/47

(54) me **BLISTER PAKOVANJE**
en **BLISTER PACK**

(73) Bayer Pharma Aktiengesellschaft
Müllerstrasse 178 , Berlin, 13353/ DE

(72) STANGE, Olaf

Oertzenweg 48, 14163 Berlin/ DE

HÖHL, Johannes-Walter

Ahornweg 9a, 51399 Burscheid/ DE

DIEDERICH, Reiner

Schulstrasse 3, 50389 Wesseling/ DE

DRÖDER, Klaus

Mozartstrasse 1, 38304 Wolfenbüttel/ DE

HERRMANN, Christoph

Georg-Westermann-Allee 33, 38104 Braunschweig/ DE

DIETRICH, Franz

Schwabenstrasse 11, 38104 Braunschweig/ DE

BLUMENTHAL, Philipp

Wehrstrasse 2, 38114 Braunschweig/ DE

STÜHM, Kai

Kreuzkampstrasse 31, 38114 Braunschweig/ DE

BOBKA, Paul

Thomasiusstrasse 17, 06110 Halle/ DE

SCHMIDT, Christopher

Ferdinandstrasse 1a, 38300 Wolfenbüttel/ DE

THIEDE, Sebastian

Hamburger Strasse 286, 38114 Braunschweig/ DE

(57)

1. Makroblister koji obuhvata pljosnato telo, na kom su napravljene šupljine za prihvat pojedinačnih porcija leka, pri čemu su šupljine napunjene pojedinačnim porcijama leka i zatvorene folijom, pri čemu makroblister sadrži T porcija leka, naznačen time, što T iznosi najmanje 60 i pljosnato telo ima površinu u opsegu od 200 mm x 200 mm do 1200 mm x 1200 mm.

Patent sadrži još 16 patentnih zahtjeva.

(11) **03695** (13) **B**

(51) **A61K 9/08**^(2006.01)

A61K 47/18^(2006.01)

A61K 31/675^(2006.01)

A61P 1/08^(2006.01)

A61K 9/19^(2006.01)

A61K 47/26^(2006.01)

A61K 31/473^(2006.01)

(21) P-2020-16

(22) 01.06.2017

(30) 201662345942 P 06.06.2016 US

(96) 17729822.1/01.06.2017

(86) EP PCT/EP2017/063268/01.06.2017

(87) WO 2017/211663/14.12.2017/2017/50

(97) EP 3435980/06.02.2019/2019/06

EP 3435980/13.11.2019/2019/46

(54) me **FIZIOLOŠKI BALANSIRANE INJEKTABILNE FORMULACIJE FOSNETUPITANTA**
en **PHYSIOLOGICALLY BALANCED INJECTABLE FORMULATIONS OF FOSNETUPITANT**

(73) HELSINN HEALTHCARE S.A.

Via Pian Scairolo 9, Lugano-Pazzallo, 6912 / CH

(72) VENTURINI, Alessio

Via Majano 1, 21100 Varese/ IT

CANNELLA, Roberta

Via Al Colle 42, 21100 Varese/ IT

(57)

1. Injektabilna formulacija fosnetupitanta, tečnog ili liofilizovanog, koja sadrži:

a) fosnetupitant ili njegovu farmaceutski prihvatljivu so;

b) izborno palonosetron ili njegovu farmaceutski prihvatljivu so;

e) natrijum hidroksid;

d) dinatrijum edetat;

e) izborno hlorovodoničnu kiselinu; i

t) manitol.

Patent sadrži još 19 patentnih zahtjeva.

(11) **03696** (13) **B**

(51) **A61K 39/12**^(2006.01)

(21) P-2020-17

(22) 29.11.2012

(30) 201161564877 P 30.11.2011 US

201261694957 P 30.08.2012 US

(96) 12801680.5/29.11.2012

(86) IB PCT/US2012/067135/29.11.2012

(87) WO 2013/082327/06.06.2013/2013/23

(97) EP 2785373/08.10.2014/2014/41

EP 2785373/20.11.2019/2019/47

(54) me **REKOMBINANTNI HVT VEKTORI KOJI EKSPRIMIRAJU ANTIGENE PATOGENA PTICA I NJIHOVE UPOTREBE**
en **RECOMBINANT HVT VECTORS EXPRESSING ANTIGENS OF AVIAN PATHOGENS AND USES THEREOF**

(73) Boehringer Ingelheim Animal Health USA Inc.

3239 Satellite Boulevard, Bldg. 500, Duluth, GA 30096/ US

(72) BUBLLOT, Michel

3 Rue Favre Garin, F-69630 Chaponost/ FR

MEBATSION, Teshome

2670 Bent Tree Lane, Watkinsville, GA 30677/ US

PRITCHARD, Joyce

3804 Princeton Court, Gainesville, GA 30504/ US

LINZ, Perry

2286 Cotton Gin Row, Jefferson, GA 30549/ US

(57)

1. Kompozicija ili vakcina, naznačena time, što sadrži prvi rekombinantni HVT (herpesvirus ćuraka) vektor koji uključuje heterologni polinukleotid koji kodira i eksprimira F antigen virusa Newcastle bolesti (NDV-F), operabilno vezan za SV40 promotor i SV40 poliA signal, i gde su, pored toga, polinukleotid koji kodira NDV-F polipeptid, operabilno vezani SV40 promotor i SV40 poliA signal insertovani u lokus "intergensko mesto I" (IG I) HVT genoma, i gde, pored toga, polinukleotid koji kodira i eksprimira NDV-F ima sekvencu kako je navedeno u SEQ ID NO: I; I drugi rekombinantni HVT vektor koji uključuje heterologni polinukleotid koji kodira i eksprimira VP2 antigen virusa infektivne bolesti burze (IBDV), pri čemu je drugi rekombinantni HVT vektor vHVT13.

Patent sadrži još 4 patentnih zahtjeva.

(11) **03684 (13) B**

(51) **A61K 9/12**^(2006.01)

A61K 9/16^(2006.01)

A61K 31/167^(2006.01)

A61K 31/58^(2006.01)

A61K 31/137^(2006.01)

A61P 11/00^(2006.01)

A61K 9/00^(2006.01)

A61K 31/40^(2006.01)

A61K 31/56^(2006.01)

A61K 31/46^(2006.01)

A61K 31/573^(2006.01)

A61M 15/00^(2006.01)

(21) P-2020-18

(22) 28.05.2010

(30) 182565 P 29.05.2009 US

258172 P 04.11.2009 US

309365 P 01.03.2010 US

345536 P 17.05.2010 US

(96) 16164845.6/28.05.2010

(97) EP 3106149/21.12.2016/2016/51

EP 3106149/20.11.2019/2019/47

(54) me **KOMPOZICIJE ZA PULMONALNU DOSTAVU DUGO-DELUJUĆIH MUSKARINSKIH ANTAGONISTA I DUGODELUJUĆIH AGONISTA BETA-2 ADRENERGIČNOG RECEPTORA I PRIPADAJUĆI POSTUPCI I SISTEMI**

en **COMPOSITIONS FOR PULMONARY DELIVERY OF LONG-ACTING MUSCARINIC ANTAGONISTS AND LONG-ACTING B2 ADRENERGIC RECEPTOR AGONISTS AND ASSOCIATED METHODS AND SYSTEMS**

(73) Pearl Therapeutics, Inc.

200 Saginaw Drive, Redwood City, CA 94063/ US

(72) VEHRING, , Reinhard

200 Saginaw Drive, Redwood City, CA 94063/ US

HARTMAN, Michael, Steven

3820 Park Blvd. Apt.23, Palo Alto, CA 94306/ US

SMITH, Adrian, Edward

2 Wilmington Acres Court, Emerald Hills, CA 94062/ US

JOSHI, Vidya, B

812 Seal Pointe Drive, Redwood City, CA 94065/ US

DWIVEDI, Sarvajna, Kumar

409 Whisper Lane, Redwood City, CA 94065/ US

(57)

1. Farmaceutska kompozicija koja može da se dostavi uz pomoć doznog inhalera, naznačena time, što obuhvata: medijum za suspenziju koji sadrži farmaceutski prihvatljiv propelant; mnoštvo mikronizovanih aktivnih čestica agensa koje sadrže aktivni agens izabran iz glikopirilata i fonoterola, uključujući bilo koje farmaceutski prihvatljive soli, estere, ili njihove solvate, pri čemu barem 90% (volumenski) čestica aktivnog agensa ima optički dijametar od 7 J.lm ili manje; I mnoštvo čestica, koje mogu da se udišu i koje suspenduju, koje sadrže perforirane fosfolipidne mikrostrukture i imaju volumensku medijanu optičkog dijametra izabranu iz vrednosti između 0.2 J.lm i 50 J.lm, između 0.5 J.lm i 15 J.lm, između 1.5 J.lm i 10 J.lm, i između 2 J.lm i 5 J.lm; pri čemu ukupna masa čestica za suspendovanje prevazilazi ukupnu masu čestica aktivnog agensa, a mnoštvo čestica aktivnog agensa asociira sa mnoštvom čestica za suspendovanje kako bi se formirala ko-suspenzija.

Patent sadrži još 27 patentnih zahtjeva.

(11) **03697 (13) B**

(51) **A61K 39/395**^(2006.01)
C07K 16/22^(2006.01)

A61K 47/12^(2006.01)

(21) P-2020-19

(22) 11.05.2011

(30) 334986 P 14.05.2010 US

(96) 17158990.6/11.05.2011

(97) EP 3195880/26.07.2017/2017/30

EP 3195880/27.11.2019/2019/48

(54) me **VISOKE KONCENTRACIJE FORMULACIJA ANTITELA PROTIV SKLEROSTINA**
en **HIGH CONCENTRATION ANTI-SCLEROSTIN ANTIBODY FORMULATIONS**

(73) AMGEN INC.

One Amgen Center Drive , Thousand Oaks, CA 91320-1799/ US

(72) OSSLUND, Timothy D.

475 Vista Montana, Camarillo, CA 93010/ US

(57)

1.

Sterilna tečna formulacija koja ima apsolutnu viskoznost 10 cP ili manje obuhvata: (a) imunoglobulin protiv sklerostina u koncentraciji od barem 70 mg/ml;(b) kalcijum so u koncentraciji koja se kreće u opsegu od 5 mM do 20 mM i (e) ukupna koncentracija acetata koja se kreće u opsegu 10 mM do 90 mM, pri čemu imunoglobulin obuhvata sekvence amino kiseline SEK ID BR: 86 i SEK ID BR: 84.

Patent sadrži još 16 patentnih zahtjeva.

(11) **03719 (13) B**

(51) **C07D 471/04**^(2006.01)

A61K 31/437^(2006.01)

A61K 31/501^(2006.01)

A61P 35/00^(2006.01)

A61K 31/506^(2006.01)

(21) P-2020-2

(22) 29.01.2018

(30) 201762451971 P 30.01.2017 US

201762523695 P 22.06.2017 US

201762560304 P 19.09.2017 US

201762592485 P 30.11.2017 US

(96) 18705097.6/29.01.2018

(86) EP PCT/EP2018/052040/29.01.2018

(87) WO 2018/138303/02.08.2018/2018/31

(97) EP 3494116/12.06.2019/2019/24

EP 3494116/23.10.2019/2019/43

(54) me **MODULATORI RECEPTORA ESTROGENA**
en **ESTROGEN RECEPTOR MODULATORS**

(73) Astrazeneca AB

, 151 85 Södertälje/ SE

(72) SCOTT, James, Stewart

AstraZeneca Darwin Building Cambridge Science Park Milton Road, Cambridge CB4 0WG/ GB

MOSS, Thomas, Andrew

AstraZeneca Darwin Building Cambridge Science Park Milton Road, Cambridgeshire CB4 0WG/ GB

HUGHES, Samantha, Jayne

AstraZeneca Darwin Building Cambridge Science Park Milton Road, Cambridge Cambridgeshire CB4 0WG/ GB

NISSINK, Johannes, Wilhelmus, Maria

AstraZeneca Darwin Building Cambridge Science Park Milton Road, Cambridge Cambridgeshire CB4 0WG/ GB

BARLAAM, Bernard, Christophe

AstraZeneca Darwin Building Cambridge Science Park Milton Road, Cambridge Cambridgeshire CB4 0WG/ GB

YANG, Bin

AstraZeneca 35 Gatehouse Drive, Waltham MA 02451/ US

(57)

1. (R)-3-((1R,3R)-1-(5-fluoro-2-(2-((3-fluoropropil)amino)etoksi)-3-metilpiridin-4-il)-3-metil-1,3,4,9-tetrahidro-2H-pirido[3,4-b]indol-2-il)-2-metilpropanska kiselina,

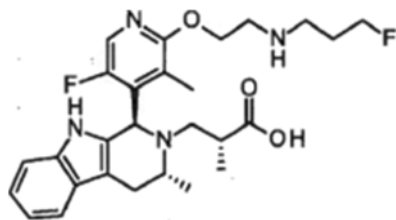

ili njena farmaceutska prihvataljiva so.

Patent sadrži još 5 patentnih zahtjeva

(11) **03685** (13) **B**

(51) **A01N 31/02**^(2006.01)

A01N 25/18^(2006.01)

(21) P-2020-20

(22) 16.09.2015

(96) 15185505.3/16.09.2015

(97) EP 3143874/22.03.2017/2017/12

EP 3143874/20.11.2019/2019/47

(54) me **DOBIJANJE FEROMONA I POSTUPKA ZAŠTITE DRVEĆA OD MONOCHAMUS GALLOPROVINCIALIS**
en **PHEROMONE PREPARATION AND METHOD FOR PROTECTING TREE SPECIES AGAINST MONOCHAMUS GALLOPROVINCIALIS**

(73) Fytofarm, spol. s r.o.

Dúbravská cesta 21, 84508 Bratislava/ SK

(72) VARKONDA, Stefan

Borodáčova 17, Bratislava, 82103 / SK

UJHELYIOVÁ, Liana

Sládkovicova 1128/2, 925 23 Jelka/ SK

WITASEK, Peter

Dietrichsteinerstrasse 14, A-9560 Feldkirchen/ AT

(57)

1. Evaporator za zaštitu vrsta drveta od štetočina *Monochamus galloprovincialis*, u formulaciji odabranoj iz tubusne formulacije, formulacije alufanske vrećice sa evaporatorom, formulacije plastičnih vrećica sa tamponom, naznačen time, što sadrži 2-dodeciloksi-1-etanol.

Patent sadrži još 2 patentnih zahtjeva.

(11) **03716** (13) **B**

(51) **C07D 495/04**^(2006.01)

A61P 35/00^(2006.01)

A61K 31/519^(2006.01)

A61P 37/00^(2006.01)

(21) P-2020-21

(22) 22.06.2016

(30) 1555752 23.06.2015 FR

(96) 16733379.8/22.06.2016

(86) EP PCT/EP2016/064433/22.06.2016

(87) WO 2016/207225/29.12.2016/2016/52

(97) EP 3313851/02.05.2018/2018/18

EP 3313851/06.11.2019/2019/45

(54) me **NOVI DERIVATI HIDROKSIESTERA, POSTUPAK ZA NJIHOVU PRIPRAVU I FARMACEUTSKI PRIPRAVCI KOJI IH SADRŽE**
en **NEW HYDROXYESTER DERIVATIVES, A PROCESS FOR THEIR PREPARATION AND PHARMACEUTICAL COMPOSITIONS CONTAINING THEM**

(73) Les Laboratoires Servier

35, Rue de Verdun, 92284 Suresnes/ FR

Vernalis (R&D) Limited

100 Berkshire Place Wharfedale Road, Winnersh Berkshire RG41 5RD/ GB

(72) SZLÁVIK, Zoltán

Költő utca 2-4 D/2, 1121 Budapest/ HU

KOTSCHY, András

Álmos Vezér u.4, 2045 Törökbálint/ HU

CHANRION, Maïa

14 rue de la Galiote Apt D441, Issy Les Moulineaux, 92130 / FR

DEMARLES, Didier

21 rue du Lièvre, 45430 Checy/ FR

GENESTE, Olivier

Bâtiment A 17 rue Crevel Duval, 92500 Rueil Malmaison/ FR

DAVIDSON, James Edward Paul

2 Granta Terrace Great Shelford, Cambridge Cambridgeshire CB22 5DJ/ GB

MURRAY, James Brooke

21 Parsonage Way, Linton Cambridgeshire CB21 4YL/ GB

SIPOS, Szabolcs

Röppentyü utca 21-23. A épület 3/10, H-1139 Budapest/ HU

PACZAL, Attila

Örjárat u. 95., H-1158 Budapest/ HU

BÁLINT, Balázs

Lehel utca 18, 2151 Fót/ HU

1. Spojevi formule naznaceni time, da:

•A predstavlja skupinu

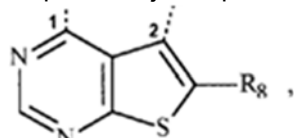

u kojoj je 1 vezan na atom kisika i 2 je vezan na prsten fenila,

• R1 predstavlja ravnu iii razgrananu (C1-Cs)alkilnu skupinu, ravnu iii razgrananu (C2-Cs)alkenilnu skupinu, ravnu iii razgrananu (C2-Cs)alkinilnu skupinu, ravnu iii razgrananu (C1-Cs)alkoksi skupinu,

-S-(C1-Cs)alkilnu skupinu, ravni iii razgranani (C1-Cs)polihaloalkil, hidroksi skupinu, hidroksi(C1-Cs)alkilnu skupinu, cijano skupinu, -NR11R11', -Cys iii atom halogena,

- R2, R3, R4 i R5 neovisno jedan o drugome predstavljaju atom vodika, atom halogena, ravnu iii razgrananu (C1-Cs)alkilnu skupinu, ravnu iii razgrananu (C2-Cs)alkenilnu skupinu, ravnu iii razgrananu (C2-Cs)alkinilnu skupinu, ravni iii razgranani (C1-Cs)polihaloalkil, hidroksi skupinu, hidroksi(C1-Cs)alkilnu skupinu, ravnu iii razgrananu (C1-Cs)alkoksi skupinu, -S-(C1-Cs)alkilnu skupinu, cijano skupinu, nitro skupinu, -alkii(Co-Cs)-NRgRg', -O-alkii(C1-Cs)-NR9R9', -O-alkii(C1-Cs)-R10, -C(O)-QRg, -O-C(O)-Rg, -C(O)-NRgRg', -NRg-C(Q)-Rg', -NRg-C(Q)-QRg', -alkii(C1-Cs)-NRg-C(O)-R9', -S02-NRgRg',

-S02-alkii(C1-Cs) iii supstituenti jednog od para (R2, R3), (R3, R4), (R4, R5), kada se cijepe na dva susjedna atoma ugljika, zajedno s ugljikovim atomom koji ih nosi tvore aromatski iii ne-aromatski prsten sastavljen od 5 do 7 članova prstena, koji mogu sadriavati od 1 do 3 heteroatoma odabrana od kisika, sumpora i dusika, kada je poznato da dobiveni prsten može biti supstituiran sa skupinom odabranom od ravne iii razgranane (C1-Cs)alkilne skupine, -NR11R11', -alkii(Co-Cs)-Cy1 iii okso,

- Rs i R1 neovisno jedan o drugome predstavljaju atom vodika, atom halogena, ravnu iii razgrananu (C1-Cs)alkilnu skupinu, ravnu iii razgrananu (C2-Cs)alkenilnu skupinu, ravnu iii razgrananu (C2-Cs)alkinilnu skupinu, ravni iii razgranani (C1-Cs)polihaloalkil, hidroksi skupinu, ravnu iii razgrananu (C1-Cs)alkoksi skupinu, -S-(C1-Cs)alkilnu skupinu, cijano skupinu, nitro skupinu, -alkii(Co-Cs)-NRgRg',

-O-alkii(C1-Cs)-NR9R9', -O-Cy1, -alkii(Co-Cs)-Cy1, -alkenii(C2-Cs)-Cy1, -alkinii(C2-Cs)-Cy1, -O-alkii(C1-Cs)-R10, -C(O)-QRg, -O-C(O)-Rg, -C(O)-NRgRg', -NRg-C(Q)-Rg', -NRg-C(Q)-ORg', -alkii(C1-Cs)-NRg-C(O)-Rg', -S02-NR9R9', -S02-alkii(C1-Cs) iii supstituente para (Rs, R1), koji kada se vezuju na dva susjedna atoma ugljika, zajedno s ugljikovim atomom koji ih nosi tvore aromatski iii ne-aromatski prsten sastavljen od 5 do 7 članova prstena, koji mogu sadriavati od 1 do 3 heteroatoma odabrana od kisika, sumpora i dusika, kada je poznato da dobiveni prsten može biti supstituiran sa skupinom odabranom od ravne iii razgranane (C1-Cs)alkilne skupine, -NR11R11', -alkii(Co-Cs)-Cy1 iii okso,

- Ra predstavlja ravnu iii razgrananu (C1-Cs)alkilnu skupinu, ravnu iii razgrananu (C2-Cs)alkenilnu skupinu, ravnu iii razgrananu (C2-Cs)alkinilnu skupinu, -Cy3, -alkii(C1-Cs)-Cy3, -alkenii(C2-Cs)-Cy3, -alkinii(C2-Cs)-Cy3, -Cy3-Cy4, -alkinii(C2-Cs)-O-Cy3, -CyJ-alkii(Co-Cs)-O-alkii(Co-Cs)-Cy4, atom halogena, cijano skupinu, -C(O)-R12 iii -C(O)-NR12R12',

- Rs i Rs' neovisno jedan o drugome predstavljaju atom vodika, ravnu iii razgrananu (C1-Cs)alkilnu skupinu, -alkii(Co-Cs)-Cy1 iii supstituente para (Rs, Rs') koji zajedno s dusikom koji ih nosi tvore

aromatski iii ne-aromatski prsten sastavljen od 5 do 7 članova prstena, koji osim dusika može dodatno sadr:Zavati od 1 do 3 heteroatoma odabrana od kisika, sumpora i dusika, kada je poznato da navedeni dusik može biti supstituiran sa skupinom koja predstavlja atom vodika iii ravnu iii razgrananu (C1-Cs)alkilnu skupinu te kada je poznato da jedan iii vise uljиковih atoma od mogućih

supstituenata, može biti deuterirano,

- R10 predstavlja -Cy1, -Cy1-alkii(Co-Cs)-Cy2, -Cy1-alkii(Co-Cs)-O-alkii(Co-Cs)-Cy2,

-Cy1-alkii(Co-Cs)-NRs-alkii(Co-Cs)-Cy2, -Cy1-Cy2-0-alkii(Co-Cs)-Cys, -C(O)-NRsRs', -NRsRs', -ORs,

-NRs-C(O)-Rs', -O-alkii(C1-Cs)-ORs, -S02-Rs, -C(O)-ORs iii -NH-C(O)-NH-R1,

- Rn, Rn', R12 i R12' neovisno jedan o drugome predstavljaju atom vodika iii po izboru supstituiranu ravnu iii razgrananu (C2-Cs)alkilnu skupinu,

- R13 predstavlja atom vodika, hidroksi skupinu iii hidroksi(C1-Cs)alkilnu skupinu,

- Ra predstavlja atom vodika iii ravnu iii razgrananu (C1-Cs)alkilnu skupinu,

- Rb represents a -O-C(O)-0-Rc skupinu, -O-C(O)-NRcRc' skupinu iii -O-P(O)(ORc)2 skupinu,

- R_c i $R_{c'}$ neovisno jedan o drugome predstavljaju atom vodika, ravnu ili razgrananu (C1-Ca)alkilnu skupinu, cikloalkilnu skupinu, (C1-Cs)alkoksi(C1-Cs)alkilnu skupinu ili (C1-Cs)alkoksikarbonil(C1-Cs)alkilnu skupinu ili supstituente para (R_c , $R_{c'}$) koji zajedno s atomom dusika koji ih nosi tvore ne-aromatski prsten sastavljen od 5 do 7 članova prstena, koji osim atoma dusika mogu dodatno sadržavati od 1 do 3 heteroatoma odabrana od kisika i dusika, kada je poznato da navedeni dusik može biti supstituiran skupinom koja predstavlja ravnu ili razgrananu (C1-Cs)alkilnu skupinu,

- Cy_1 , Cy_2 , Cy_3 , Cy_4 , Cys i Cys' neovisno jedan o drugome, predstavljaju cikloalkilnu skupinu, heterocikloalkilnu skupinu, arilnu skupinu ili heteroarilnu skupinu,

- n je cijeli broj jednak 0 ili 1,

kada je poznato da:

- "aril" označava fenil, naftil, bifenil, indanil ili indenilnu skupinu,

- "heteroaril" označava bilo koju mono- ili bi-cikličku skupinu sastavljenu od 5 do 10 članova prstena, koji imaju najmanje jednu aromatsku polovicu te sadrže od 1 do 3 heteroatoma odabrana od kisika, sumpora i dusika,

- "cikloalkil" označava bilo koju mono- ili bi-cikličku ne-aromatsku karbocikličku skupinu koja sadrži od 3 do 10 članova prstena,

- "heterocikloalkil" označava bilo koju mono- ili bi-cikličku ne-aromatsku karbocikličku skupinu koja sadrži od 3 do 10 članova prstena te sadrži od 1 do 3 heteroatoma odabrana od kisika, sumpora i dusika, koji mogu uključivati spojene, premostene ili spiro prstenaste sustave, pri čemu je moguće da tako definirane arilne, heteroarilne, cikloalkilne i heterocikloalkilne skupine i alkinilne, alkenilne, alkinilne, alkoksi skupine, budu supstituirane s 1 do 4 skupine odabrane od po izboru supstituiranog ravnog ili razgrananog (C1-Cs)alkila, po izboru supstituirane ravne ili razgranane (C2-Cs)alkenilne skupine, po izboru supstituirane ravne ili razgranane (C2-Cs)alkinilne skupine, po izboru supstituiranog ravnog ili razgrananog (C1-Cs)alkoksi, po izboru supstituiranog (C1-Cs)alkil-S-, hidroksi, okso (ili N-oksida gdje je prikladno), nitro, cijano, -C(O)-OR', -O-C(O)-R', -C(O)-NR'R", -NR'R", -(C=NR)OR", ravnog ili

razgrananog (C1-Cs)polihaloalkila, trifluorometoksi ili halogena, kada je poznato da R' i R'' neovisno jedan o drugome predstavljaju atom vodika ili po izboru supstituiranu ravnu ili razgrananu (C1-Cs)alkilnu skupinu te kada je poznato da jedan ili više ugljikovih atoma prethodno mogućih supstituenata, može biti deuterirano, njihovi enantiomeri, diastereoizomeri i atropizomeri te adicijske soli istih s farmaceutski prihvatljivom kiselinom ili lučinom.

Patent sadrži još 39 patentnih zahtjeva.

(11) **03686** (13) **B**

(51) **A61K 35/74**^(2006.01)

A61K 39/39^(2006.01)

A61K 39/00^(2006.01)

A61K 39/085^(2006.01)

C07K 14/31^(2006.01)

(21) P-2020-22

(22) 24.03.2015

(30) 14161861 26.03.2014 EP

14192913 12.11.2014 EP

(96) 15711523.9/24.03.2015

(86) EP PCT/EP2015/056175/24.03.2015

(87) WO 2015/144653/01.10.2015/2015/39

(97) EP 3122378/01.02.2017/2017/05

EP 3122378/11.12.2019/2019/50

(54) me **MUTIRANI STAFILOKOKNI ANTIGENI**
en **MUTANT STAPHYLOCOCCAL ANTIGENS**

(73) GLAXOSMITHKLINE BIOLOGICALS S.A.

Rue de l'Instjtut, 89 , Rixensart, 1 330 / BE

(72) BAGNOLI, Fabio

GlaxoSmithKline Via Fiorentina 1, I-53100 Siena/ IT

FIASCHI, Luigi

GlaxoSmithKline Via Fiorentina 1, I-53100 Siena/ IT

SCARSELLI, Maria

GlaxoSmithKline Via Fiorentina 1, I-53100 Siena/ IT

(57)

1. MutiraniSpA antigen koji obuhvata sekvencu aminokiseline koja obuhvata ili se sastoji iz SEQ ID NO: 49, u kojoj XX dipeptidina položajima 7-8, 60-61, 68-69, 126-127, 184-185, i 242-243

SEQ ID NO: 49 su KK, RR, RK ili KR, i XX dipeptidi na položajima 34-35, 95-96, 153-154, 211-212, i 269-270 SEQ ID NO: 49 su AA..

Patent sadrži još 15 patentnih zahtjeva.

(11) **03687** (13) **B**

(51) **C07K 16/28**^(2006.01)

A61P 35/00^(2006.01)

(21) P-2020-23

(22) 21.03.2016

(30) 15160292 23.03.2015 EP

(96) 16713784.3/21.03.2016

(86) EP PCT/EP2016/056104/21.03.2016

(87) WO 2016/150899/29.09.2016/2016/39

(97) EP 3274370/31.01.2018/2018/05

EP 3274370/20.11.2019/2019/47

(54) me **ANTI-CEACAM6 ANTITELA I NJIHOVA PRIMENA**
en **ANTI-CEACAM6 ANTIBODIES AND USES THEREOF**

(73) Bayer Pharma Aktiengesellschaft

Müllerstrasse 178, Berlin, 13353 / DE

(72) WILLUDA, Jörg

Staerkstr. 47a, 16548 Glienicke/Nordbahn/ DE

TRAUTWEIN, Mark

c7O Bayer U.S. LLC 100 Bayer Boulevard, Whippany, NJ 07981-1544/ US

GRITZAN, Uwe

Schirmerstr. 20, 50823 Köln/ DE

FREIBERG, Christoph

Lipkenskothen 10, 42113 Wuppertal/ DE

DITTMER, Frank

Sandstr. 4, 40627 Düsseldorf/ DE

SCHÖNFELD, Dorian

Constantinstr. 82, 50679 Köln/ DE

GLÜCK, Julian Marius

Cranachstr. 22, 40667 Meerbusch/ DE

PINKERT, Jessica

Briller Str. 97, 42105 Wuppertal/ DE

, GUTIERREZ Eva-Maria

Gutenbergstr. 3, 89257 Illertissen/ DE

GOLFIER, Sven

Stölpchenweg 12E, 14109 Berlin/ DE

HOLTON, Simon

Niklasstrasse 14a, 14163 Berlin/ DE

BECKHOVE, Philip

Spitalkellerweg 3, 93059 Regensburg/ DE

GE, Yingzi

Im Finkenschlag 15, 51429 Bergisch Gladbach/ DE

(57)

1. Izolovano anti-CEACAM6 antitelo, ili njegov antigen-vezujući fragment, koje obuhvata:

i. antigen-vezujući region teškog lanca koji obuhvata H-CDR1 koji obuhvata SEQ ID N0:48, H-CDR2 koji obuhvata SEQ ID N0:49, i H-CDR3 koji obuhvata SEQ ID N0:50 i antigen-vezujući region lakog lanca koji obuhvata L-CDR1 koji obuhvata SEQ ID N0:52, L-CDR2 koji obuhvata SEQ ID N0:53, i L-CDR3 koji obuhvata

SEQ ID N0:54, ili

ii. antigen-vezujući region teškog lanca koji obuhvata H-CDRI koji obuhvata SEQ ID NO:106, H-CDR2 koji obuhvata SEQ ID NO:107, i H-CDR3 koji obuhvata SEQ ID NO:108 i antigen-vezujući region lakog lanca koji obuhvata L-CDRI koji obuhvata SEQ ID NO:109, L-CDR2 koji obuhvata SEQ ID NO:110, i L-CDR3 koji obuhvata SEQ ID NO:111, ili

iii. antigen-vezujući region teškog lanca koji obuhvata H-CDRI koji obuhvata SEQ ID N0:4, H-CDR2 koji obuhvata SEQ ID N0:5, i H-CDR3 koji obuhvata SEQ ID N0:6 i antigen-vezujući region lakog lanca koji obuhvata L-CDRI koji obuhvata SEQ ID N0:8, L-CDR2 koji obuhvata SEQ ID N0:9, i L-CDR3 koji obuhvata SEQ ID NO:10, ili

iv. antigen-vezujući region teškog lanca koji obuhvata H-CDRI koji obuhvata SEQ ID N0:34, H-CDR2 koji obuhvata SEQ ID N0:35, i H-CDR3 koji obuhvata SEQ ID N0:36 i antigen-vezujući region lakog lanca koji obuhvata L-CDRI koji obuhvata SEQ ID N0:38, L-CDR2 koji obuhvata SEQ ID N0:39, i L-CDR3 koji obuhvata SEQ ID N0:40, ili

v. antigen-vezujući region teškog lanca koji obuhvata H-CDRI koji obuhvata SEQ ID N0:120, H-CDR2 koji obuhvata SEQ ID NO:121, i H-CDR3 koji obuhvata SEQ ID NO:122 i antigen-vezujući region lakog lanca koji obuhvata L-CDRI koji obuhvata SEQ ID NO:124, L-CDR2 koji obuhvata SEQ ID NO:125, i L-CDR3 koji obuhvata SEQ ID NO:126, ili

vi. antigen-vezujući region teškog lanca koji obuhvata H-CDRI koji obuhvata SEQ ID N0:24, H-CDR2 koji obuhvata SEQ ID N0:25, i H-CDR3 koji obuhvata SEQ ID N0:26 i antigen-vezujući region lakog lanca koji obuhvata L-CDRI koji obuhvata SEQ ID N0:28, L-CDR2 koji obuhvata SEQ ID N0:29, i L-CDR3 koji obuhvata SEQ ID N0:30, ili

vii. antigen-vezujući region teškog lanca koji obuhvata H-CDRI koji obuhvata SEQ ID N0:76, H-CDR2 koji obuhvata SEQ ID N0:77, i H-CDR3 koji obuhvata SEQ ID N0:78 i antigen-vezujući region lakog lanca koji obuhvata L-CDRI koji obuhvata SEQ ID N0:80, L-CDR2 koji obuhvata SEQ ID N0:81, i L-CDR3 koji obuhvata SEQ ID N0:82, ili

viii. antigen-vezujući region teškog lanca koji obuhvata H-CDRI koji obuhvata SEQ ID NO:134, H-CDR2 koji obuhvata SEQ ID NO:135, i H-CDR3 koji obuhvata SEQ ID NO:136 i antigen-vezujući region lakog lanca koji obuhvata L-CDRI koji obuhvata SEQ ID NO:138, L-CDR2 koji obuhvata SEQ ID NO:139, i L-CDR3 koji obuhvata SEQ ID NO:140, ili

iks. antigen-vezujući region teškog lanca koji obuhvata H-CDRI koji obuhvata SEQ

ID N0:148, H-CDR2 koji obuhvata SEQ ID N0:149, i H-CDR3 koji obuhvata SEQ ID NO:150 i antigen-vezujući region lakog lanca koji obuhvata L-CDRI koji obuhvata SEQ ID N0:152, L-CDR2 koji obuhvata SEQ ID N0:153, i L-CDR3 koji obuhvata SEQ ID NO:154, ili

x. antigen-vezujući region teškog lanca koji obuhvata H-CDRI koji obuhvata SEQ ID N0:14, H-CDR2 koji obuhvata SEQ ID N0:15, i H-CDR3 koji obuhvata SEQ ID NO:16 i antigen-vezujući region lakog lanca koji obuhvata L-CDRI koji obuhvata SEQ ID NO:18, L-CDR2 koji obuhvata SEQ ID NO:19, i L-CDR3 koji obuhvata

SEQ ID N0:20, ili

xi. antigen-vezujući region teškog lanca koji obuhvata H-CDRI koji obuhvata SEQ ID N0:62, H-CDR2 koji obuhvata SEQ ID N0:63, i H-CDR3 koji obuhvata SEQ ID N0:64 i antigen-vezujući region lakog lanca koji obuhvata L-CDRI koji obuhvata SEQ ID N0:66, L-CDR2 koji obuhvata SEQ ID N0:67, i L-CDR3 koji obuhvata SEQ ID N0:68, ili

xii. antigen-vezujući region teškog lanca koji obuhvata H-CDR I koji obuhvata SEQ ID N0:92, H-CDR2 koji obuhvata SEQ ID N0:93, i H-CDR3 koji obuhvata SEQ ID N0:94 i antigen-vezujući region lakog lanca koji obuhvata L-CDR1 koji obuhvata

SEQ ID N0:96, L-CDR2 koji obuhvata SEQ ID N0:97, i L-CDR3 koji obuhvata

SEQ ID N0:98..

Patent sadrži još 16 patentnih zahtjeva.

(11) **03688** (13) **B**

(51) **A61K 39/00**^(2006.01)

C07K 16/28^(2006.01)

(21) P-2020-24

(22) 10.08.2015

(30) 201562152708 P 24.04.2015 US

(96) 15754071.7/10.08.2015

(86) US PCT/US2015/044479/10.08.2015

(87) WO 2016/171742/27.10.2016/2016/43

(97) EP 3285803/28.02.2018/2018/09

EP 3285803/18.12.2019/2019/51

(54) me **METODE ZA TRETIRANJE ILI PREVENCIJU MIGRENSKE GLAVOBOLJE**
en **METHODS FOR TREATING OR PREVENTING MIGRAINE HEADACHE**

(73) Amgen Inc.

One Amgen Center Drive, Thousand Oaks, California 91320-1799/ US

(72) SUN, Hong

29412 Oakpath Drive, Agoura Hills, California 91301/ US

DUNAYEVICH, Eduardo

One Amgen Center Drive c/o Patent Operations MS 28-2-C, Thousand Oaks, California 91320-1799/ US

LENZ, Robert A.

908 Ravensbury Street, Westlake Village, California 91361/ US

VARGAS, Gabriel

555 Timberwood Avenue, Thousand Oaks, California 91360/ US

(57)

1. Anti-CGRP receptor antitelo ili njegov fragment koji se vezuje za antigen za upotrebu u (a) metodi za prevenciju ili smanjenje javljanja migrenske glavobolje kod pacijenta koji ima potrebu za time, ili

(b) metodi za profilaktičko tretiranje migrene kod pacijenta gde metoda obuhvata davanje pacijentu anti-CGRP receptor antitelo ili njegov fragment koji se vezuje za antigen pri dozi od oko 35 mg do oko 210 mg mesečno, gde anti-CGRP receptor antitelo ili njegov fragment koji se vezuje za antigen sadrži CDRH1 koji ima sekvencu SEQ ID NO:14, CDRH2 koji ima sekvencu SEQ ID NO:23, CDRH3 koji ima sekvencu SEQ ID NO:34, CDRL1 koji ima sekvencu SEQ ID NO:44, CDRL2 koji ima sekvencu SEQ ID NO:55 i CDRL3 koji ima sekvencu SEQ ID NO:65.

Patent sadrži još 17 patentnih zahtjeva.

(11) **03689** (13) **B**

(51) **A61K 47/60**^(2006.01)

A61K 38/37^(2006.01)

B01D 61/02^(2006.01)

(21) P-2020-25

(22) 21.02.2011

(30) 306513 P 21.02.2010 US

(96) 11745404.1/21.02.2011

(86) US PCT/US2011/025592/21.02.2011

(87) WO 2011/103531/25.08.2011/2011/34

(97) EP 2536399/26.12.2012/2012/52

EP 2536399/20.11.2019/2019/47

(54) me **METODA ZA AKTIVIRANJE I KONJUGOVANJE BIOMOLEKULA**

en **Method for activation and conjugation of biomolecules**

(73) Bayer HealthCare LLC

555 White Plains Road, Tarrytown, NY 10591/ US

(72) VOGEL, Jens H.

7401 Terrace Drive, El Cerrito California 94530/ US

TO, Chi Shung Brian

3083 Silva Way, San Ramon California 94582/ US

BIANCO, Carolina Lucia

Jaegerstr. 33, 71394 Kernen i.R./ DE

(57)

1. Metoda za proizvodnju konjugata faktora koagulacije koja obuhvata korake aktiviranja faktora koagulacije dovođenjem u kontakt sa sredstvom za aktivaciju; uklanjanja sredstva za aktivaciju; i konjugovanja faktora koagulacije reagovanjem faktora koagulacije sa aktiviranim polimerom ; gde su koraci metode obuhvaceni u integrisanom sistemu za filtraciju sa tangencijalnim protokom i, gde je polimer polietilen glikol, i gde je sredstvo za aktivaciju redukciono sredstvo.

Patent sadrži još 4 patentnih zahtjeva.

(11) **03702** (13) **B**

(51) **C07J 9/00**^(2006.01)

C07J 31/00^(2006.01)

C07J 41/00^(2006.01)

A61K 31/575^(2006.01)

A61P 1/16^(2006.01)

(21) P-2020-26

(22) 28.05.2015

(30) FI20140130 29.05.2014 IT

(96) 15731260.4/28.05.2015

(86) EP PCT/EP2015/061802/28.05.2015

(87) WO 2015/181275/03.12.2015/2015/48

(97) EP 3149019/05.04.2017/2017/14

EP 3149019/04.12.2019/2019/49

(54) me **DERIVATI HOLANA ZA PRIMENU U LEČENJU I/ILI PREVENCIJI BOLESTI KOJE SU FXR I TGR5/GPBAR1 POSREDOVANE**
en **CHOLANE DERIVATIVES FOR USE IN THE TREATMENT AND/OR PREVENTION OF FXR AND TGR5/GPBAR1 MEDIATED DISEASES**

(73) Bar Pharmaceuticals S.r.l.

Via Sicilla, 2, Reggio Neii'Emilia, 42124 / IT

(72) ZAMPELLA, Angela

Via Luigia Sanfelice 71, 80127 Napoli/ IT

FIORUCCI, Stefano

Via Assisi, 70, 06100 Perugia/ IT

(57)

1. Jedinjenje odabrano iz grupe, koju čine:

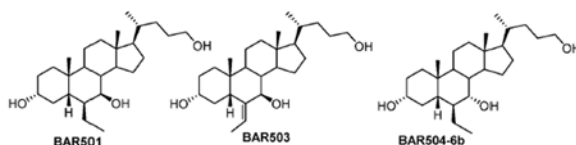

Patent sadrži još 9 patentnih zahtjeva.

(11) **03690** (13) **B**

(51) **C07D 251/18**^(2006.01)

C07D 403/04^(2006.01)

C07D 409/04^(2006.01)

A61K 31/395^(2006.01)

C07D 401/04^(2006.01)

C07D 405/14^(2006.01)

C07D 417/04^(2006.01)

A61P 35/00^(2006.01)

(21) P-2020-27

(22) 10.07.2014

(30) PCT/CN2013/079200 11.07.2013 WO

(96) 14822106.2/10.07.2014

(86) CN PCT/CN2014/081957/10.07.2014

(87) WO 2015/003640/15.01.2015/2015/02

(97) EP 3019483/18.05.2016/2016/20

EP 3019483/20.11.2019/2019/47

(54) me **TERAPEUTSKI AKTIVNA JEDINJENJA I POSTUPCI NJIHOVE UPOTREBE**
en **THERAPEUTICALLY ACTIVE COMPOUNDS AND THEIR METHODS OF USE**

(73) Agios Pharmaceuticals, Inc.

88 Sidney Street, Cambridge, MA 02139/ US

(72) KONTEATIS, Zenon D.

137 Southern Boulevard, Chatham, NJ 07928/ US

POPOVICI-MULLER, Janeta

12 Clarke Farm Road, Windham, NH 03087/ US

TRAVINS, Jeremy M.

59 Flagg Road, Southborough, MA 01772/ US

ZAHLER, Robert

5 East Welling Avenue, Pennington, NJ 08534/ US

CAI, Zhenwei

36 Hills Drive, Belle Mead, NJ 08502/ US

ZHOU, Ding

52 Yishashi Garden 188 Chunjiu Road, Shanghai 201612/ CN

(57)

1. Jedinjenje koje ima fonnulu Ia iii njegova farmaceutske prihvatljiva so iii hidrat, naznaceno time \$to:

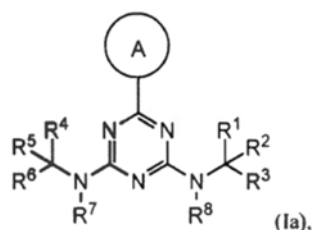

prsten A je izabran od fenila, pirazolila, oksazolila, izoksazolila, piridinila, pirimidinila, pirazinila i tiazolila, pri cemu je prsten A izbomo supstituisan sa do dva supstituenta nezavisno izabrana od halo, -Ct-C4 alkila, -Ct-C4 haloalkila, -C 1-C4 hidroksialkila, -NH-S(0)2-(C 1-C4 alkil), -S(0)2NH(Ct-C4 alkil), -CN, -S(0)2-(Ct-C4 alkil), Ct-C4 alkoksi, -NH(Ct-C4 alkil), -OH, -OCF3, -CN, -NH2, -C(O)NH2, -C(O)NH(Ct-C4 alkil), -C(O)-N(C 1-C4 alkil)2 i ciklopropila izbomo supstituisanog sa OH; ,R , R i R

su svaki nezavisno izabrani od vodonika, C1-C4 alkila, C1-C4 haloalkila, -O-Ct-C4

alkila i CN, pri čemu je svaka navedena alkil grupa od R1, R3, R4, i R6 nezavisno izborno supstituisana sa -OH, -NH2, -CN, -O-Ct-C4 alkil, -NH(Ct-C4 alkil) ili -N(Ct-C4 alkil)2;

R2 i R5 su svaki nezavisno izabrani od: -(C1-C6 alkil), -(C1-C6 alkil)-C(O)-NH2, -(C1-C6 alkil)-C(O)H, -(C2-C6 alkenil ili alkinil), -(Ct-C6 alkilen)-O-(C1-C6 alkil), -(Co-C6 alkilen)-C(O)N(R6)- (Ct-C6 alkil) i -(Co-C6 alkilen)-C(O)-(C1-C6 alkil) gde: svaka alkil ili alkilen grupa prisutna u R2 i R5 je izborno supstituisana sajednim ili više -OH, -O(C1-C4 alkil), -C(O)H ili halo; svaka tenninalna metil grupa prisutna u R2 i R5 je izborno zamenjena sa -CH2OH, CF3, -CH2F, -CH2Cl, C(O)CH3, C(O)CF3, CN ili C(O)H; R7 i R8 su svaki nezavisno izabrani od vodonika i C1-C6 alkila; gde

R1 i R su izborno uzeti zajedno tako da formiraju karbociklil ili heterociklil od kojih je bilo koji izborno supstituisan sa do 3 supstituenta nezavisno izabrana od halo, npr., fluoro, C1-C4 alkila, C1-C4 haloalkila, C1-C4 alkoksi, -CN, =O, -OH, arila, heteroarila, -S(O)C1-C4 alkila, -C(O)C1-C4 alkila, -C(O)arila i -C(O)Cl-C4alkila; ili

R4 i R5 su izborno uzeti zajedno tako da formiraju karbociklil ili heterociklil od kojih je bilo koji izborno supstituisan sa do 3 supstituenta nezavisno izabrana od halo, npr., fluoro, C1-C4 alkila, C1-C4 haloalkila, C1-C4 alkoksi, -CN, =O, -OH, arila, heteroarila, -S(O)C1-C4 alkila, -C(O)C1-C4

(i) kada je A jednak piridil izborno supstituisan kao to je opisano u prethodnom tekstu, tada (A) N(R7)C(R)(R)(R) i N(R)(R)C(R)(R) nisu oba NHCH2CH2OH, ili NH-cikloheksil, i (B) kada je N(R7)C(R4)(R5)(R6) jednak NHC(CH3)3, tada N(R8)C(R1)(R2)(R3) nije NH-CH2CH3;

(ii) kada je A jednak pirazolil, oksazolil, izoksazolil, piridinil, pirimidinil, pirazinil ili tiazolil izborno supstituisan kao to je opisan u prethodnom tekstu, tada N(R7)C(R4)(R5)(R6)(R) nisu oba N(CH2CH3)2, NHCH2CH2-i-propil ili NHCH2CH(CH3)2;

(iii) kada je A jednak 1-pirazolil izborno supstituisan kao to je opisano u prethodnom tekstu, tada ni N(R7)C(R4)(R5)(R6)

ni N(R8)C(R1)(R2)(R3) nisu NH-izopropil, NHCH2CH3, ili N(CH2CH3)2,

(iv) kada je A jednako fenil izborno supstituisan kao to je opisano u prethodnom tekstu, tada

(v) jedinjenje nije: N-2-izopropil-6-fenil-N4-(tetrahidro-2H-piran-4-il)-1,3,5-triazin-2,4-diamin.

Patent sadrži još 27 patentnih zahtjeva.

(11) **03691 (13) B**

(51) **C07D 403/12**^(2006.01)

C07D 401/04^(2006.01)

C07D 403/04^(2006.01)

C07D 405/12^(2006.01)

C07D 239/553^(2006.01)

A61P 9/10^(2006.01)

A61K 31/513^(2006.01)

C07D 401/12^(2006.01)

C07D 405/04^(2006.01)

C07D 239/545^(2006.01)

C07D 413/04^(2006.01)

(21) P-2020-28

(22) 19.06.2014

(30) 201361838088 P 21.06.2013 US

201461939655 P 13.02.2014 US

201461981366 P 18.04.2014 US

(96) 14738986.0/19.06.2014

(86) US PCT/US2014/043192/19.06.2014

(87) WO 2024/205223/24.12.2014/2014/52

(97) EP 3010910/27.04.2016/2016/17

EP 3010910/05.02.2020/2020/06

(54) me **PIRIMIDINDIONSKA JEDINJENJA PROTIV SRČANIH STANJA**
en **PYRIMIDINEDIONE COMPOUNDS AGAINST CARDIAC CONDITIONS**

(73) MyoKardia, Inc.

333 Allerton Avenue, South San Francisco CA 94080/ US

(72) OSLOB, Johan

c/o MyoKardia, Inc. 333 Allerton Avenue, South San Francisco, California 94080/ US

ANDERSON, Robert

c/o MyoKardia, Inc. 333 Allerton Avenue, South San Francisco, California 94080/ US

AUBELE, Danielle

c/o MyoKardia, Inc. 333 Allerton Avenue, South San Francisco, California 94080/ US

EVANCHIK, Marc

c/o MyoKardia, Inc. 333 Allerton Avenue, South San Francisco, California 94080/ US

FOX, Jonathan Charles

c/o MyoKardia, Inc. 333 Allerton Avenue, South San Francisco, California 94080/ US

KANE, Brian

c/o MyoKardia, Inc. 333 Allerton Avenue, South San Francisco, California 94080/ US

LU, Puping

c/o MyoKardia, Inc. 333 Allerton Avenue, South San Francisco, California 94080/ US

MCDOWELL, Robert

c/o MyoKardia, Inc. 333 Allerton Avenue, South San Francisco, California 94080/ US

RODRIGUEZ, Hector

c/o MyoKardia, Inc. 333 Allerton Avenue, South San Francisco, California 94080/ US

SONG, Yonghong

c/o MyoKardia, Inc. 333 Allerton Avenue, South San Francisco, California 94080/ US

SRAN, Arvinder

c/o MyoKardia, Inc. 333 Allerton Avenue, South San Francisco, California 94080/ US

(57)

1. Jedinjenje koje ima formulu:

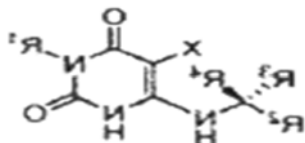

ili njegova farmaceutski prihvatljiva so, naznačeni time, što se R¹ bira iz grupe koju čine (a) C₃-C₄ alkil, C₃-C_s cikloalkil, i 4- do 6-člani heterocikloalkil, od kojih je svaki opciono supstituisan sa 1-2 R⁸ ili (b) fenil i 5- do 6-člani heteroaril, od kojih je svaki opciono supstituisan sa 1-3 R_a; R₂ je fenil, koji je opciono supstituisan sa 1-5 R_b; R₃ R⁴ je H; X je član koji se bira iz grupe koju čine H i F;

svaki R_a se nezavisno bira iz grupe koju čine halo, CN, C₁-C₄ alkil, C₁-C₄ alkoksi, -COR₈, -C₀₂R₈, -S₀₂R₈₁, -S₀₂NR₈₁R₈₂

i -CONR₈₁R₈₂

gde se svaki R_{a1} i R_{a2}

prsten; I svaki R_c se nezavisno bira iz grupe koju čine halo i C₁-C₂ alkoksi, gde je svaki cikloalkil zasićen ili delimično nezasićen prstenasti sistem; svaki heterocikloalkil je zasićen prstenasti sistem koji uključuje od 1 do 4 heteroatoma koji se biraju između N, O, i S; svaki heteroaril je aromatični prstenasti sistem koji uključuje od 1 do 5 heteroatoma koji se biraju između N, O, i S; I svaka alkoksi grupa je opciono supstituisana jednom ili više komponenti koje se biraju između halo, hidroksil, amino, alkilamino, nitro, cijano, i alkoksi.

Patent sadrži još 18 patentnih zahtjeva.

(11) **03692** (13) **B**

(51) **C07K 16/28**^(2006.01)

A61K 39/395^(2006.01)

(21) P-2020-30

(22) 12.10.2012

(30) 201161546800 P 13.10.2011 US

201261655110 P 04.06.2012 US

(96) 12775423.2/12.10.2012

(86) US PCT/US2012/059977/12.10.2012

(87) WO 2013/056068/18.04.2013/2013/16

(97) EP 2766395/20.08.2014/2014/34

EP 2766395/20.11.2019/2019/47

(54) me **POLIPEPTIDI ANTITELA KOJI ANTAGONIZUJU CD40L**
en **ANTIBODY POLYPEPTIDES THAT ANTAGONIZE CD40L**

(73) BRISTOL-MYERS SQUIBB COMPANY

Route 206 and Province Line Road, Princeton, NJ 08543/ US

DOMANTIS LIMITED

980 Great West Road, Brentford, Middlesex TW8 9GS/ GB

(72) NADLER, Steven G.

c/o Bristol-Myers Squibb Company Route 206&Province Line Road, Princeton, New Jersey 08543/ US
TAMURA, James K.

c/o Bristol-Myers Squibb Company Route 206&Province Line Road, Princeton, New Jersey 08543/ US
PRICE, Laura

c/o Bristol-Myers Squibb Company Route 206&Province Line Road, Princeton, New Jersey 08543/ US
REHFUSS, Robert P.

c/o Bristol-Myers Squibb Company Route 206&Province Line Road, Princeton, New Jersey 08543/ US
SUCHARD, Suzanne J.

c/o Bristol-Myers Squibb Company Route 206&Province Line Road, Princeton, New Jersey 08543/ US
SURI, Anish

c/o Bristol-Myers Squibb Company Route 206&Province Line Road, Princeton, New Jersey 08543/ US
BRYSON, James William

c/o Bristol-Myers Squibb Company Route 206&Province Line Road, Princeton, New Jersey 08543/ US
YAMNIUK, Aaron

c/o Bristol-Myers Squibb Company Route 206&Province Line Road, Princeton, New Jersey 08543/ US
GRANT, Steven

c/o Domantis Limited 315 Cambridge Science Park, Cambridge Cambridgeshire CB4 0WG/ GB
IGNATOVIICH, Olga

c/o Domantis Limited 315 Cambridge Science Park, Cambridge Cambridgeshire CB4 0WG/ GB
DREW, Philip

c/o Domantis Limited 315 Cambridge Science Park, Cambridge Cambridgeshire CB4 0WG/ GB

(57)

1. Izolovani polipeptid antitela koji je fuzioni polipeptid koji sadrži prvi varijabilni domen i Fc domen, pri čemu prvi varijabilni domen specifično vezuje humani CD40L, pri čemu CD40L sadrži aminokiselinsku sekvencu sa SEQ ID NO: I, pri čemu prvi varijabilni domen sadrži BMS2h-572- 633 koji ima aminokiselinsku sekvencu sa SEQ ID NO: 274, i gde Fc domen je IgG I Fc domen izabran od CT-Dugog domena koji se sastoji od amino kiselina 139 do 370 od SEQ ID NO: 1362, CT-kratkog domena koji se sastoji od amino kiselina 138 do 362 od SEQ ID NO: 1363, N297Q Dugog Fc domena koji se sastoji od amino kiselina 139 do 370 od SEQ ID NO: 1364, ili N297Q Kratkog Fc domene koji se sastoji od amino kiselina 138 do 362 od SEQ ID NO: 1365.

Patent sadrži još 14 patentnih zahtjeva.

(11) **03732** (13) **B**

(51) **C12N 15/85**^(2006.01)

C12N 9/64^(2006.01)

C07K 16/28^(2006.01)

A01K 67/027^(2006.01)

C07K 16/46^(2006.01)

C07K 16/40^(2006.01)

(21) P-2020-41

(22) 24.02.2012

(30) 201161446895 P 25.02.2011 US

201161497650 P 16.06.2011 US

201261595200 P 06.02.2012 US

(96) 14154967.5/24.02.2012

(97) EP 2738259/04.06.2014/2014/23

EP 2738259/27.11.2019/2019/48

(54) me **Miševi s ADAM6**

en **ADAM6 mice**

(73) REGENERON PHARMACEUTICALS, INC.

777 Old Saw Mill River Road, Tarrytown NY 10591/ US

(72) Macdonald, Lynn

16 Gedney Way, White Plains, NY 10605/ US

Stevens, Sean

355 Berry Street, No. 413, San Francisco, CA 94158/ US

Murphy, Andrew J.

10 Newton Court, Croton-on-Hudson, NY 10520/ US

(57)

1. Miš koji eksprimira antitijela, pri čemu svaki teški lanac u ekspimiranim antitijelima sadržava humano varijabilnopodručje i mišje konstantno područje, **naznačen time, da** miš takođe reksprimira:

(i) mišji protein ADAM6a ili njegov ortolog ili homologkoji je funkcionalan u muškom mišu; i

(ii) mišji protein ADAM6b ili njegov ortolog ili homologkoji je funkcionalan u muškom mišu,

pri čemu su proteini ADAM6a i ADAM6b ili njihoviortolozi ili homolozi ekspimirani iz integrirane sekvence nukleinske kiselinekoja je prisutna u lokusu teškog lanca endogenog mišjeg imunoglobulina kojisadržava barem jedan humani VH, barem jedan humani DH i barem jedan humani JHsegment, pri čemu mišu nedostaje funkcionalni endogeni gen Adam6

Patent sadrži još 7 patentnih zahtjeva.

(11) **03737 (13) B**

(51) C07D 231/18 ^(2006.01)	C07D 307/64 ^(2006.01)
C07D 311/60 ^(2006.01)	C07D 407/12 ^(2006.01)
C07D 405/12 ^(2006.01)	C07D 403/12 ^(2006.01)
C07D 213/71 ^(2006.01)	C07D 217/22 ^(2006.01)
C07D 249/12 ^(2006.01)	C07D 271/12 ^(2006.01)
C07D 333/34 ^(2006.01)	C07D 277/36 ^(2006.01)
C07D 333/62 ^(2006.01)	C07D 249/04 ^(2006.01)
C07D 417/12 ^(2006.01)	C07D 307/82 ^(2006.01)
C07C 311/54 ^(2006.01)	C07C 311/56 ^(2006.01)
C07D 307/18 ^(2006.01)	C07D 309/08 ^(2006.01)

(21) P-2020-49

(22) 16.02.2016

(30) 20150900507 16.02.2015 AU

(96) 16751821.6/16.02.2016

(86) AU PCT/AU2016/050103/16.02.2016

(87) WO 2016/131098/25.08.2016/2016/34

(97) EP 3259253/27.12.2017/2017/52

EP 3259253/15.01.2020/2020/03

(54) me **SULFONILUREE I SRODNA JEDINJENJA I NJIHOVA UPOTREBA**
en **SULFONYLUREAS AND RELATED COMPOUNDS AND USE OF SAME**

(73) The University of Queensland

, St Lucia, Queensland 4072/ AU

The Provost, Fellows, Foundation Scholars, and the other members of Board, of the College of the Holy & Undiv. Trinity of Queen Elizabeth near Dublin

College Green, Dublin 2/ IE

(72) O'NEILL, Luke

52-160 Pearse Street, Dublin 2/ IE

COLL, Rebecca

18 Forbes Street, West End, Queensland 4101/ AU

COOPER, Matthew

29 Camborne Place, Chapel Hill, Queensland 4049/ AU

ROBERTSON, Avril

44 Maryland Street, Kenmore, Queensland 4069/ AU

SCHRODER, Kate

7 Love Street, Fairfield, Queensland 4103/ AU

(57)

1. Jedinjenje formule (II), ili njegova farmaceutske prihvatljiva so ili solvat:

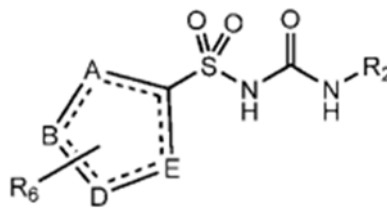

Formula (II)

naznačeno time, što se A, B, D i E nezavisno biraju između C, N, O, S i Se, ali je najmanje jedan od njih C i najmanje jedan od njih je N;

svaka isprekidana linija može predstavljati vezu;

pri svakom pojavljivanju, R6 se nezavisno bira iz grupe koju čine vodonik, halid, cijano, C1-C6 alkil, C1-C6 alkilamino, C1-C6 alkilhidroksi, C3-C6 cikloalkil, alkilfenil, fenil, benzil, C1-C6 estar, C2-C6 alkenil, C1-C6 trifluoroalkil i C1-C6 alkoksi, od kojih svaki može opciono biti supstituisan, kako je pogodno, pri čemu se svaki opcioni supstituent nezavisno bira iz grupe koju čine C1-10 alkil; C3-6 cikloalkil; hidroksialkil; C1-10 alkoksi; C2-10 alkenil; C2-10 alkinil; C6-C12 aril; ariloksi; heteroaril; heterociklil; halo; hidroksil; halogenisani alkil; amino; alkilamino; arilamino; acil; amido; CN; NO₂; N₃; CH₂OH; CONH₂; CONR₂₄R₂₅; CO₂R₂₄; CH₂OR₂₄; NHCOR₂₄; NHCO₂R₂₄; C1-3 alkiltio; sulfat; sulfonska kiselina; sulfonatni estri; fosfonska kiselina; fosfat; fosfonat; mono-, di-, ili trifosfatni estri; tritil; monometoksitritil; R₂₄SO; R₂₄SO₂; CF₃S; CF₃SO₂; i trialkilsilil; gde se R₂₄ i R₂₅ svaki nezavisno biraju između H ili C1-10 alkil; i R₂ se bira između 2,6-dialkilfenil, 2,6-dialkil-4-halofenil, 2,6-dicikloalkilfenil, 2,6-dicikloalkil-4-halofenil, i:

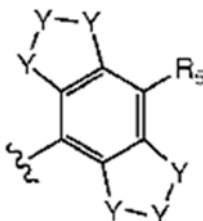

gde se pri svakom pojavljivanju, Y nezavisno bira između C, N, S i O, koji može biti opciono supstituisan, kako je pogodno, pri čemu se svaki opcioni supstituent nezavisno bira iz grupe koju čine C1-10 alkil; C3-6 cikloalkil; hidroksialkil; C1-10 alkoksi; C2-10 alkenil; C2-10 alkinil; C6-C12 aril; ariloksi; heteroaril; heterociklil; halo; hidroksil; halogenisani alkil; amino; alkilamino; arilamino; acil; amido; CN; NO₂; N₃; CH₂OH; CONH₂; CONR₂₄R₂₅; CO₂R₂₄; CH₂OR₂₄; NHCOR₂₄; NHCO₂R₂₄; C1-3 alkiltio; sulfat; sulfonska kiselina; sulfonatni estri; fosfonska kiselina; fosfat; fosfonat; mono-, di-, ili trifosfatni estri; tritil; monometoksitritil; R₂₄SO; R₂₄SO₂; CF₃S; CF₃SO₂; i trialkilsilil; gde se R₂₄ i R₂₅ svaki nezavisno, biraju između H ili C1-10 alkil; i

R₅ se bira iz grupe koju čine vodonik, halo, cijano, amid, sulfonamid, acil, hidroksil, C1-C6 alkil, C1-C6 haloalkil, C3-C5 cikloalkil i C1-C6 alkoksi, grupe svih mogu biti opciono supstituisane, kako je pogodno, sa halo, cijano ili C1-C6 alkoksi.

Patent sadrži još 28 patentnih zahtjeva.

(11) **03621** (13) **B**

(51) **A61K 39/00**^(2006.01)

A61K 39/395^(2006.01)

(21) P-2020-5

(22) 21.11.2014

(30) 13193953 21.11.2013 EP

2834000 21.11.2013 CA

201314086696 21.11.2013 US

201414182776 18.02.2014 US

(96) 14802642.0/21.11.2014

(86) EP PCT/EP2014/075315/21.11.2014

(87) WO 2015/075194/28.05.2015/2015/21

(97) EP 3071220/28.09.2016/2016/39

EP 3071220/25.12.2019/2019/52

(54) me **PREPARATI ZA LEČENJE GD2 POZITIVNOG KANCERA**
en **PREPARATIONS FOR TREATING A GD2 POSITIVE CANCER**

(73) Apeiron Biologics AG

Campus-Vienna-Biocenter 5, 1030 Wien/ AT

(72) LOIBNER, Hans

Heimgasse 23, A-1230 Vienna/ AT

MUTSCHLECHNER, Oliver

Reisenbauerring 8/2/21, A-2351 Wiener Neudorf/ AT

LADENSTEIN, Ruth

Roterdstrasse 7-9/1/2/5, A-1160 Vienna/ AT

KLIER, Isabel

Fuhrmannsgasse 8/21, A-1080 Vienna/ AT

(57)

1. Preparat za lečenje neuroblastoma kod humanog pacijenta koji ima pomenut neuroblastom, pri čemu:

(a) preparat obuhvata monoklonalna antitelo proizvedeno u CHO ćelijama, i koji obuhvata laki lanac SEQ ID N0:3 i teški lanac SEQ ID N0:4 (chl4.18/CHO);

(b) preparat treba da se da pacijentu bez pridruženog davanja IL-2 u okviru istog ciklusa lečenja; (e) chl4.18/CHO antitelo daje se pacijentu kao kontinualna infuzija tokom 24 sata dnevno tokom 10 uzastopnih dana po ciklusu;i

(d) chl4.18/CHO antitelo treba da se da u dnevnoj dozi od 5 do 15 mg/m²/dan i u ukupnoj dozi od 50 do 150 mg/m²/ciklus.

Patent sadrži još 8 patentnih zahtjeva.

(11) **03709** (13) **B**

(51) **C07K 14/62**^(2006.01)
C12N 15/62^(2006.01)

A61K 38/28^(2006.01)

(21) P-2020-51

(22) 28.04.2016

(30) 201562158079 P 07.05.2015 US

(96) 16721605.0/28.04.2016

(86) US PCT/US2016/029807/28.04.2016

(87) WO 2016/178905/10.11.2016/2016/45

(97) EP 3292141/14.03.2018/2018/11

EP 3292141/12.02.2020/2020/07

(54) me **FUZIJSKI PROTEINI**
en **FUSION PROTEINS**

(73) ELI LILLY AND COMPANY

Lilly Corporate Center, Indianapolis, IN 46285/ US

(72) BALDWIN, David Bruce

P.O. Box 6288, Indianapolis, Indiana 46206-6288/ US

BEALS, John Michael

P.O. Box 6288, Indianapolis, Indiana 46206-6288/ US

DAY, Jonathan Wesley

P.O. Box 6288, Indianapolis, Indiana 46206-6288/ US

DICKINSON, Craig Duane

P.O. Box 6288, Indianapolis, Indiana 46206-6288/ US

KORYTKO, Andrew Ihor

P.O. Box 6288, Indianapolis, Indiana 46206-6288/ US

LAZAR, Gregory Alan

P.O. Box 6288, Indianapolis, Indiana 46206-6288/ US

(57)

1. Fuzijski protein, **naznačen time** što sadrži:

a) agonist inzulinskog receptora koji ima opću formulu Z1-Z2-Z3, gdje:

i) Z1 je analog inzulinskog lanca B, koji ima aminokiselinski slijed:

X1X2X3QHLCGSHLVEALX4LVCGERGF5YX6X7X8X9

gdje je X1 F, Q ili A; X2 je V ili G; X3 je N, K, D, G, Q, A ili E; X4 je E, Y, Q, ili H; X5 je H ili F; X6 je G, T, S, H, V ili je odsutan; X7 je G, E, P, K, D, S, H ili je odsutan; X8 je G, E, K, P, Q, D, H ili je odsutan; X9 je G, T, S, E, K, A ili je odsutan, uz uvjet da analog inzulinskog lanca B sadrži najmanje jednu modifikaciju u odnosu na aminokiselinski slijed lanca B molekule ljudskog inzulina na X4, X5, X6, X7, X8 ili X9 (SEQ ID NO:1);

ii) Z2 je prva peptidna spojnicu, koja ima 5 do 10 aminokiselina, gdje su najmanje 5 navedenih aminokiselina ostaci G; i

iii) Z3 je analog inzulinskog lanca A, koji ima aminokiselinski slijed:

GIVEQCCTSX1CSLX2QLENYCX3X4

gdje je X1 T ili I; X2 je D, Y, Q ili E; X3 je G, N, S ili A; i X4 je bilo koja prirodna aminokiselina, ili je odsutan, uz uvjet da ako je X3 N, X4 mora biti aminokiselina koja nije G ili N (SEQ ID NO:2);

b) druga peptidna spojnica ima između 10 i 25 aminokiselina, gdje su najmanje 50% navedenih aminokiselina ostaci G; i

c) Fc područje ljudskog IgG;

gdje je C-terminalni ostatak agonista inzulinskog receptora izravno fuzioniran s N-terminalnim ostatkom druge peptidne spojnice, a C-terminalni ostatak druge peptidne spojnice je izravno fuzioniran s N-terminalnim ostatkom Fc područja ljudskog IgG.

Patent sadrži još 22 patentnih zahtjeva.

(11) **03693** (13) **B**

(51) **C07D 401/14**^(2006.01)

A61K 31/506^(2006.01)

A61P 11/08^(2006.01)

A61P 3/08^(2006.01)

A61P 25/28^(2006.01)

A61K 31/444^(2006.01)

A61P 11/06^(2006.01)

A61P 3/06^(2006.01)

A61P 9/10^(2006.01)

A61P 35/00^(2006.01)

(21) P-2020-9

(22) 19.02.2016

(30) 201530233 25.02.2015 ES

(96) 16705187.9/19.02.2016

(86) EP PCT/EP2016/053509/19.02.2016

(87) WO 2016/135048/01.09.2016/2016/35

(97) EP 3262034/03.01.2018/2018/01

EP 3262034/04.12.2019/2019/49

(54) me **DERIVATIVI 2-AMINOPIRIDINA KAO ANTAGONISTI ADENOZINSKIH A2B RECEPTORA I LIGANDI MELATONIN MT3 RECEPTORA**
en **DERIVATIVES OF 2-AMINOPYRIDINE AS ADENOSINE A2B RECEPTOR ANTAGONISTS AND LIGANDS OF THE MELATONIN MT3 RECEPTORS**

(73) Palobiofarma, S.L.

Tecnocampus Mataró, 3 Avenida Ernest Lluch, 32 Planta 4, oficina 1, 08302 Mataró-Barcelona/ ES

(72) CASTRO- PALOMINO LARIA, Julio Cesar

Palobiofarma S.L. Tecnocampus Mataró 3 Avenida Ernest Lluch, 32 Planta 4, oficina 1, E-08302

Mataró, Barcelona/ ES

CAMACHO GÓMEZ, Juan Alberto

Palobiofarma S.L. Tecnocampus Mataró 3 Avenida Ernest Lluch, 32 Planta 4, oficina 1, E-08302

Mataró, Barcelona/ ES

MENDOZA LIZALDEZ, Adela

Palobiofarma S.L. Tecnocampus Mataró 3 Avenida Ernest Lluch, 32 Planta 4, oficina 1, E-08302

Mataró, Barcelona/ ES

(57)

1. Jedinjenje formule (1):

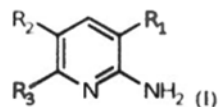

- R₂ predstavlja šestočlani heteroarilni prsten koji sadrži ugljenik, vodonik i jedan ili više atoma azota, opciono supstituisanih jednim ili više supstituenata izabranih iz grupe koja se sastoji od atoma halogena, C1-C4 haloalkila, linearnog ili razgranatog C1-C6 alkila, C3-C12 cikloalkila, linearne

- R₁ predstavlja šestočlani heteroarilni prsten koji sadrži ugljenik, vodonik i jedan ili više atoma azota, opciono supstituisanih jednim ili više supstituenata izabranih iz grupe koja se sastoji od atoma halogena, C1-C4 haloalkila, linearnog ili razgranatog C1-C6 alkila, C3-C12 cikloalkilne, linearne ili razgranate C1-C6 alkoksi i C3-C12 cikloalkoksi grupa;

N-oksid navedenih jedinjenja i njihova farmaceutski prihvatljiva so, pod uslovom da jedinjenje formule (I)

Patent sadrži još 14 patentnih zahtjeva.

(11) **03710** (13) **B**

(51) **C08B 37/18**^(2006.01)
C08L 5/00^(2006.01)

A61K 31/715^(2006.01)

(21) P-2020-91

(22) 31.03.2014

(30) 20130162453 05.04.2013 EP

(96) 14713507.3/31.03.2014

(86) EP PCT/EP2014/056451/31.03.2014

(87) WO 2014/161815/09.10.2014/2014/41

(97) EP 2981557/10.02.2016/2016/06

EP 2981557/05.02.2020/2020/06

(54) me **POJAČIVAČI TOPIVOSTI U VODI NA BAZI GLIKOGENA**
en **GLYCOGEN-BASED WATER SOLUBILITY ENHANCERS**

(73) Aziende Chimiche Riunite Angelini Francesco A.C.R.A.F.S.p.A.

Viale Amelia, 70, Roma, 00181/ IT

(72) RUSSO, Vincenzo

Via Aurelio Saffi 64/A, I-04011 Aprilia/ IT

LIBERATI, Elisa

Via Alberese 9, I-00149 Roma/ IT

TONGIANI, Serena

Via Selva 89, 00045 Genzano Di Roma (Roma)/ IT

(57)

1. Polimer na bazi glikogena, **naznačen time, da** obuhvaća najmanje jednu ponavljajuću jedinicu koja je predstavljena sljedećom formulom (I)

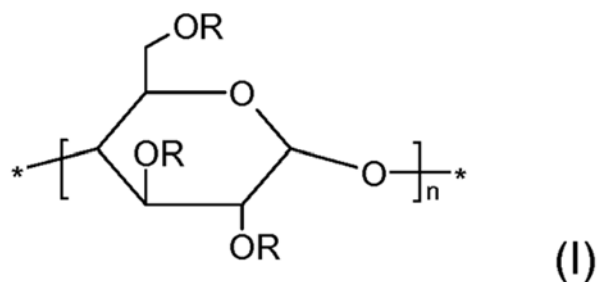

gdje je

svaka skupina R koja može biti ista ili različita, atom vodika, alkilna skupina koja ima od 1 do 9 ugljikovih atoma, alkenilna skupina koja ima od 2 do 12 ugljikovih atoma, arilalkilna skupina koja ima od 7 do 18 ugljikovih atoma ili

arilalkenilna skupina koja ima od 8 do 18 ugljikovih atoma, dok je alkilni ili alkenilni lanac navedenih skupina opcionalno supstituiran s hidroksilnom skupinom i /ili je prekinut s atomom kisika, a arilni ostatak navedenih skupina je opcionalno supstituiran s atomom halogena, uz uvjet da najmanje jedan iz

navedene R skupine bude različit od vodika, i

n je cijeli broj koji je veći od 1 ili je točno 1.

Patent sadrži još 19 patentnih zahtjeva

(11) **03720** (13) **B**

(51) **B24B 39/00**^(2006.01)

(21) P-2020-92

(22) 25.04.2017

(30) 102016005047 26.04.2016 DE

(96) 17723258.4/25.04.2017

(86) EP PCT/EP2017/000523/25.04.2017

(87) WO 2017/186348/02.11.2017/2017/44

(97) EP 3448624/06.03.2019/2019/10

EP 3448624/15.04.2020/2020/16

(54) me **ALAT ZA GLAČANJE**
en **ROLLER BURNISHING TOOL**

(73) Hoffmann GmbH Qualitätswerkzeuge
Haberlandstrasse 55, 81241 München/ DE

(72) HAHN, Karlheinz
Meißener Straße 6, 94315 Straubing/ DE

(57)

1. Alat (10) za glačanje koji ima nosač (12) za valjke isturen u smeru (V) napredovanja, na kome su, po njegovom obimu, sa mogućnošću rotacije oko ose (A) valjka, raspoređeni višestruki valjci (14) za glačanje, za obradu površine obratka, pri čemu svaki valjak (14) za glačanje ima kontaktnu površinu kojom dolazi u kontakt sa obratkom, gde svaki valjak (14) za glačanje ima cilindričan osnovni oblik, gde je svaki valjak (14) za glačanje postavljen u radijalnom pravcu (R), sa mogućnošću uklanjanja, pri čemu nosač (12) za valjke ima prstenasti kavez (22) za valjke, u kome su, sa mogućnošću rotacije, smešteni višestruki valjci (14) za glačanje, gde je u kavez (22) za valjke ubačen unutrašnji cilindar (24) sa prstenastim osnovnim oblikom, pri čemu unutrašnji cilindar (24) ima spoljašnju površinu, pri čemu spoljašnja površina unutrašnjeg cilindra (24) funkcioniše u sadejstvu sa spoljašnjom površinom valjaka (14) za glačanje, **naznačen time što** je unutrašnji cilindar (24) povezan sa pogonskom osovinom (26) alata (10) za glačanje na takav način da prenosi pogonsku silu.

Patent sadrži još 8 patentnih zahtjeva.

(11) **03724 (13) B**

(51) **C07K 16/28**^(2006.01)

A61K 39/395^(2006.01)

A61P 39/00^(2006.01)

C07K 16/30^(2006.01)

A61K 35/00^(2006.01)

(21) P-2020-93

(22) 03.09.2015

(30) 201462046682 P 05.09.2014 US

(96) 15766973.0/03.09.2015

(86) US PCT/US2015/048316/03.09.2015

(87) WO 2016/036937/10.03.2016/2016/10

(97) EP 3189081/12.07.2017/2017/28

EP 3189081/19.02.2020/2020/08

(54) me **AGENSI KOJI VEZUJU CD123 I NJIHOVE UPOTREBE**
en **CD123 BINDING AGENTS AND USES THEREOF**

(73) Janssen Pharmaceutica NV

Turnhoutseweg 30, Beerse, 2340/ BE

(72) GAUDET, Francois

1400 Mckean Road, Spring House Pennsylvania 19477/ US

ATTAR, Ricardo

1400 McKean Road, Spring House Pennsylvania 19477/ US

HARMAN, Benjamin C.

1400 Mckean Road, Spring House Pennsylvania 19477/ US

LI, Yingzhe

1400 Mckean Road, Spring House Pennsylvania 19477/ US

LUO, Jinqun

1400 McKean Road, Spring House Pennsylvania 19477/ US

MCD AID, Ronan

1400 Mckean Road, Spring House Pennsylvania 19477/ US

POMERANTZ, Steven C.

1400 Mckean Road, Spring House Pennsylvania 19477/ US

TAM, Susan H.

1400 Mckean Road, Spring House Pennsylvania 19477/ US

TEPLYAKOV, Alexey

1400 Mckean Road, Spring House Pennsylvania 19477/ US

WHEELER, John

1400 Mckean Road, Spring House Pennsylvania 19477/ US

WU, Sheng-Jiun

1400 Mckean Road, Spring House Pennsylvania 19477/ US

NEMETH, Jennifer F.

1400 McKean Road, Spring House Pennsylvania 19477/ US

(57)

1. Izolovano antitelo, ili njegov fragment koji vezuje antigen, koji obuhvataju teški i laki lanac koji sadrže:

a. CDR1 teškog lanca sa aminokiselinskom sekvencom SEQ ID NO: 012, CDR2 teškog lanca sa aminokiselinskom sekvencom SEQ ID NO: 013, CDR3 teškog lanca sa aminokiselinskom sekvencom SEQ ID NO: 014, CDR1 lakog lanca sa aminokiselinskom sekvencom SEQ ID NO: 015, CDR2 lakog lanca sa

aminokiselinskom sekvencom SEQ ID NO: 016 i CDR3 lakog lanca sa aminokiselinskom sekvencom SEQ ID NO: 017; ili

b. CDR1 teškog lanca sa aminokiselinskom sekvencom SEQ ID NO: 051, CDR2 teškog lanca sa aminokiselinskom sekvencom SEQ ID NO: 052, CDR3 teškog lanca sa aminokiselinskom sekvencom SEQ ID NO: 053, CDR1 lakog lanca sa aminokiselinskom sekvencom SEQ ID NO: 024, CDR2 lakog lanca sa aminokiselinskom sekvencom SEQ ID NO: 025 i CDR3 lakog lanca sa aminokiselinskom sekvencom SEQ ID NO: 054.

Patent sadrži još 15 patentnih zahtjeva.

(11) **03725** (13) **B**

(51) **C07D 487/22**^(2006.01)

A61P 3/00^(2006.01)

A61P 17/00^(2006.01)

A61P 31/00^(2006.01)

A61P 43/00^(2006.01)

A61K 31/41^(2006.01)

A61P 9/00^(2006.01)

A61P 19/00^(2006.01)

A61P 35/00^(2006.01)

(21) P-2020-94

(22) 13.12.2013

(30) 201222544 14.12.2012 GB

201309337 23.05.2013 GB

(96) 13821500.9/13.12.2013

(86) GB PCT/GB2013/053285/13.12.2013

(87) WO 2014/091241/19.06.2014/2014/25

(97) EP 2931728/21.10.2015/2015/43

EP 2931728/19.02.2020/2020/08

(54) me **DERIVAT HLORINA KORISTAN U FOTODINAMIČKOJ TERAPIJI I DIJAGNOSTICI**
en **CHLORIN DERIVATIVE USEFUL IN PHOTODYNAMIC THERAPY AND DIAGNOSIS**

(73) RMW Cho Group Limited

Room 2003, 20/F Tower A, New Trade Plaza, 6 On Ping Street, Hong Kong/ CN

(72) CHO, Honsue

11 Station Street, East Kew, Melbourne, Victoria 3102/ AU

(57)

1. Hlorin e4 natrijum, koji ima strukturu:

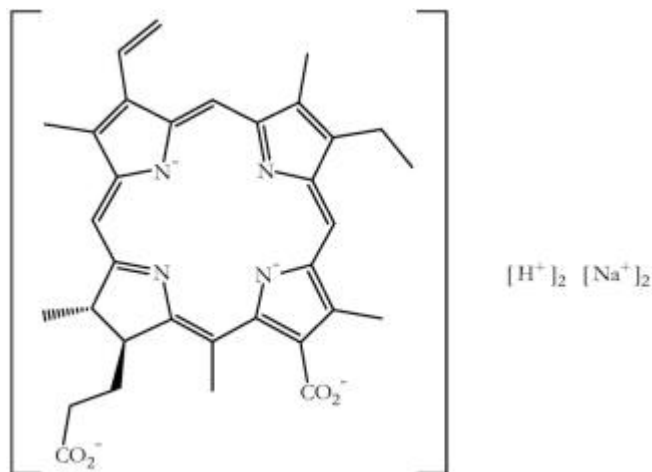

Patent sadrži još 16 patentnih zahtjeva.

(11) **03727 (13) B**

(51) **A23L 27/40**^(2016.01)

A23L 33/165^(2016.01)

A61P 9/12^(2006.01)

(21) P-2020-95

(22) 14.09.2015

(96) 15781394.0/14.09.2015

(86) HR PCT/HR2015/000016/14.09.2015

(87) WO 2017/046620/23.03.2017/2017/12

(97) EP 3349594/25.07.2018/2018/30

EP 3349594/22.04.2020/2020/17

(54) me **ZAMJENA ZA SO I NJENA PRIMENA**

en **SALT SUBSTITUTE COMPOSITION, PREPARATION AND USE THEREOF**

(73) PODRAVKA d.d.

A. Starcevic 32, 48000 Koprivnica/ HR

(72) CEPANEC, Ivica

Zagorska 28 Bunjani, 10314 Kriz/ HR

RANILOVIC, Jasmina

Trg kralja Zvonimira 21, 48000 Koprivnica/ HR

CVETKOVIC, Tanja

Ulica Hrvatske drzavnosti 55, Heresin, 48000 Koprivnica/ HR

VUGRINEC, Sasenka

Trg kralja Tomislava 7, 48000 Koprivnica/ HR

(57)

1. Kompozicija, zamena za so koja se sastoji od:

(i) natrijum hlorida,

(ii) kalijum hlorida,

(iii) kalijum magnezijum citrata <K₄Mg(C₆H₅O₇)₂; 1>

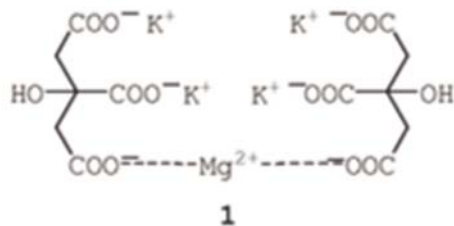

i

(iv) jedan ili više pomoćnih sastojaka hrane,

naznačena time što se navedeni sastojci koriste u sledećim masenim frakcijama:

- (i) natrijum-hlorid, 64-65% tež/tež,
- (ii) kalijum hlorid, 24-25% tež/tež,
- (iii) kalijum magnezijum citrat (1), 8-12% tež/tež i
- (iv) pomoćni prehrambeni sastojci, 0-3% tež/tež.

Patent sadrži još 9 patentnih zahtjeva.

(11) **03728 (13) B**

(51) **A61K 9/20**^(2006.01)

A61P 15/18^(2006.01)

A61K 31/565^(2006.01)

A61P 5/00^(2006.01)

(21) P-2020-96

(22) 17.06.2016

(30) 20150172767 18.06.2015 EP

(96) 16733341.8/17.06.2016

(86) EP PCT/EP2016/064065/17.06.2016

(87) WO 2016/203006/22.12.2016/2016/51

(97) EP 3310333/25.04.2018/2018/17

EP 3310333/29.04.2020/2020/18

(54) me **ORODISPERZIBILNA DOZNA JEDINICA KOJA SADRŽI KOMPONENTU ESTETROLA**
en **ORODISPERSIBLE DOSAGE UNIT CONTAINING AN ESTETROL COMPONENT**

(73) Estetra SPRL

Rue Saint-Georges 5-7, 4000 Liège/ BE

(72) JASPART, Séverine Francine Isabelle

Rue des condruzes, 19, BE-4560 Bois-et-Borsu/ BE

PLATTEEUW, Johannes Jan

Newtonplein 41, 5283 JH Boxtel/ NL

VAN DEN HEUVEL, Denny Johan Marijn

Ganzeneiland 11, 6642 DJ Beuningen/ NL

(57)

1. Orod disperzibilna čvrsta farmaceutska dozna jedinica mase između 30 i 1,000 mg, pri čemu se pomenuta dozna jedinica sastoji od:

- 0.1-25 mas.% čestica estetrola koje sadrže najmanje 90 mas.% komponente estetrola odabrane iz grupe koju čine estetrol, estri estetrola i njihove kombinacije; i
- 75-99.9 mas.% jednog ili više farmaceutski prihvatljivih sastojaka; pri čemu čvrsta dozna jedinica obuhvata najmanje 100 µg komponente estetrola; pri čemu čvrsta dozna jedinica može da bude dobijena postupkom koji obuhvata:
- obezbeđivanje čestica estetrola koje sadrže najmanje 90 mas.% komponente estetrola i koje imaju srednji zapreminski prečnik od 2 µm do 50 µm;
- mešanje čestica estetrola sa jednim ili više ekscipijenasa za granulaciju da bi se proizvela granulaciona mešavina;
- mešanje granulacione mešavine sa granulacionom tečnošću da bi se proizvele granule koje sadrže estetrol, pri čemu pomenuta granulaciona tečnost sadrži najmanje 60 mas.% tečnog rastvarača;
- uklanjanje tečnog rastvarača iz granula koje sadrže estetrol da bi se proizvele suve granule koje sadrže estetrol;
- opciono mešanje suvih granula sa jednim ili više ekscipijenasa za tabletiranje; i
- formiranje suvih granula ili mešavine suvih granula i jednog ili više ekscipijenasa za tabletiranje u čvrstu doznu jedinicu.

Patent sadrži još 27 patentnih zahtjeva.

(11) **03729 (13) B**

(51) **C07D 515/22**^(2006.01)

A61K 31/395^(2006.01)

A61P 35/00^(2006.01)

(21) P-2020-99

(22) 21.04.2017

(30) 201662326156 P 22.04.2016 US

(96) 17720720.6/21.04.2017

(86) EP PCT/EP2017/059511/21.04.2017

(87) WO 2017/182625/26.10.2017/2017/43

(97) EP 3445767/27.02.2019/2019/09

EP 3445767/19.02.2020/2020/08

(54) me **MAKROCILIKLIČKI MCL1 INHIBITORI ZA TRETMAN RAKA**
en **MACROCYCLIC MCL1 INHIBITORS FOR TREATING CANCER**

(73) ASTRAZENECA AB

, Södertälje, 151 85 / SE

(72) HIRD, Alexander

AstraZeneca 35 Gatehouse Drive, MA Waltham 02451/ US

BELMONTE, Matthew Alan

AstraZeneca 35 Gatehouse Drive, MA Waltham 02451/ US

YANG, Wenzhan

AstraZeneca 35 Gatehouse Drive, MA Waltham 02451/ US

SECRIST, John Paul

AstraZeneca 35 Gatehouse Drive, MA Waltham 02451/ US

ROBBINS, Daniel William

AstraZeneca 35 Gatehouse Drive, MA Waltham 02451/ US

KAZMIRSKI, Steven Lee

AstraZeneca 35 Gatehouse Drive, MA Waltham 02451/ US

WU, Dedong

AstraZeneca 35 Gatehouse Drive, MA Waltham 02451/ US

PENG, Bo

AstraZeneca 35 Gatehouse Drive, MA Waltham 02451/ US

JOHANNES, Jeffrey

AstraZeneca 35 Gatehouse Drive, MA Waltham 02451/ US

LAMB, Michelle Laurae

AstraZeneca 35 Gatehouse Drive, MA Waltham 02451/ US

YE, Qing

AstraZeneca 35 Gatehouse Drive, MA Waltham 02451/ US

ZHENG, Xiaolan

AstraZeneca 35 Gatehouse Drive, MA Waltham 02451/ US

(57)

1. Jedinjenje koje je 17-hloro-5,13,14,22-tetrametil-28-oksa-2,9-ditija-5,6,12,13,22-pentaazaheptaciklo[27.7.1.14,7.011,15.016,21.020,24.030,35]oktatriakonta-1(37),4(38),6,11,14,16,18,20,23,29,31,33,35-tridekaen-23-karboksilna kiselina (Formula I)

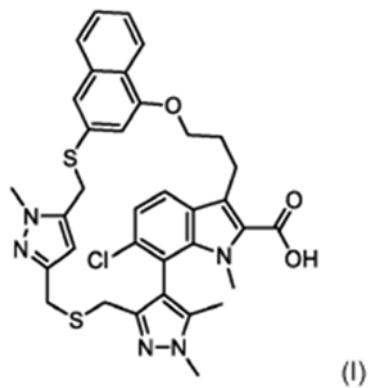

ili njena farmaceutske prihvatljiva so.

Patent sadrži još 23 patentnih zahtjeva.

OBJAVA UPISA PROMJENA
Publication of record of changes

P-2008-633

Datum ugovora

24.01.2017

Opseg prenosa prava

U cijelosti

Nosilac

ALFA WASSERMANN S.P.A., Contrada S. Emidiol-65020 , Alanno (PE), IT

Sticalac

Alfasigma S.p.A., Viale Sarca n.223, Milano, IT

P-2011-74

Datum ugovora

16.06.2020

Opseg prenosa prava

U cijelosti

Nosilac

WILSON, John, Dudley, Harriets Old Hall Drive, NG11 7HQ, Widmerpool, Nottingham , GB
WILSON, Ian, John, Fairfield HouseWidmerpool Lane, NG12 5BA, Widmerpool, Nottingham , GB

Sticalac

WATTBIKE IP LIMITED, Unit 5, Vermont House, South & Wilford Industrial Estate, Ruddington Lane, NG11 7 HQ, GB, Nottingham, WM, GB

P-2015-2

EP2606036

Datum ugovora

15.09.2014

Opseg prenosa prava

U cijelosti

Nosilac

BOEHRINGER INGELHEIM INTERNATIONAL GMBH, Binger Strasse 173 , 55216, Ingelheim am Rhein, DE

Sticalac

Orexo AB, Box 303, 751 05 Uppsala, SE

P-2016-247

EP1749027

Datum ugovora

09.10.2018

Opseg prenosa prava

U cijelosti

Nosilac

GANYMED PHARMACEUTICALS AG, An der Goldgrube 12 , 55131, Mainz , DE

Sticalac

Astellas Pharma Inc., 5-1, Nihonbashi-Honcho 2-Chome, Chuo-ku, Tokyo 103-8411, JP

P-2017-140

EP2380903

Datum ugovora

09.10.2018

Opseg prenosa prava

U cijelosti

Nosilac

GANYMED PHARMACEUTICALS GMBH, An der Goldgrube 12, 55131 , Mainz, DE

Sticalac

Astellas Pharma Inc., 5-1, Nihonbashi-Honcho 2-Chome, Chuo-ku, Tokyo 103-8411, JP

P-2017-187

EP2852408

Datum ugovora

09.10.2018

Opseg prenosa prava

U cijelosti

Nosilac

GANYMED PHARMACEUTICALS GMBH, An der Goldgrube 12, 55131, Mainz, DE
TRON - Translationale Onkologie an der Universitätsmedizin der Johannes Gutenberg-Universität Mainz gemeinnützige GmbH, Freiligrathstrasse 12, 55131, Mainz, DE

Sticalac

Astellas Pharma Inc., 5-1, Nihonbashi-Honcho 2-Chome, Chuo-ku, Tokyo 103-8411, JP

P-2017-195

EP3001809

Datum ugovora

14.02.2020

Opseg prenosa prava

U cijelosti

Nosilac

LIQWD, INC., 1482 East Valley Road, No.701, Santa Barbara, California 93108, US

Sticalac

Olaplex Inc.,c/o Advent International Corporation, 800 Boylston Street, Boston, MA 02199, US

Objava zahtjeva za proširenje evropskih prijava patenata

Publication of request for the extension of the effects of european patent applications

(51) MKP
A61B 17/00 2006 (97) EP 3165185
A61B 17/34 2006

(96) EP 16196867.2 11/2/2016
 (97) EP 3165185, 11/18/2020 202047, en

(31) 201514930952 (32) 03.11.2015 (33) US

(54) MULTI-HEAD REPOSITORY FOR USE WITH A SURGICAL DEVICE
 (72) HESS, Christopher J., 4545 Creek Road, Cincinnati, OH 45242, US
 SHELTON, IV Frederick E., 4545 Creek Road, Cincinnati, OH 45242, US
 BLEDSOE, Ryan A., 4545 Creek Road, Cincinnati, OH 45242, US
 SAVAGE, Jeffrey L., 4545 Creek Road, Cincinnati, OH 45242, US
 GATES, Craig T., 4545 Creek Road, Cincinnati, OH 45242, US
 WITHERS, Douglas E., 4545 Creek Road, Cincinnati, OH 45242, US

(51) MKP
A61B 17/34 2006 (97) EP 3165186

(96) EP 16196868.0 11/2/2016
 (97) EP 3165186, 11/18/2020 202047, en

(31) 201514930963 (32) 03.11.2015 (33) US

(54) SURGICAL END EFFECTOR LOADING DEVICE AND TROCAR INTEGRATION
 (72) HESS, Christopher J., 4545 Creek Road, Cincinnati, OH 45242, US
 SHELTON, IV Frederick E., 4545 Creek Road, Cincinnati, OH 45242, US
 BLEDSOE, Ryan A., 4545 Creek Road, Cincinnati, OH 45242, US
 SAVAGE, Jeffrey L., 4545 Creek Road, Cincinnati, OH 45242, US
 GATES, Craig T., 4545 Creek Road, Cincinnati, OH 45242, US
 WITHERS, Douglas E., 4545 Creek Road, Cincinnati, OH 45242, US

(51) MKP
A01H 1/02 2006 (97) EP 3242549
A01H 1/04 2006
A01H 1/06 2006
A01H 5/04 2006
C07K 14/415 2006
C12N 15/82 2006

(96) EP 16709559.5 1/10/2016
 (97) EP 3242549, 10/7/2020 202041, en

(31) 2014107 (32) 09.01.2015 (33) NL

(54) SEX DETERMINATION GENES AND THEIR USE IN BREEDING
 (71) Limgroup B.V., Veld-Oostenrijk 13, 5961 NV Horst, NL
 (72) VAN DER HULST, Ronaldus Gerardus Maria, c/o Veld-Oostenrijk 13, 5961 NV Horst, NL
 RICCARDI, Paolo, c/o Veld-Oostenrijk 13, 5961 NV Horst, NL
 GROENENDIJK, Johannes Simon, c/o Veld-Oostenrijk 13, 5961 NV Horst, NL
 FALAVIGNA, Agostino, c/o Veld-Oostenrijk 13, 5961 NV Horst, NL

(51) MKP
A61M 5/20 2006 (97) EP 3727516
A61M 5/28 2006
A61M 5/31 2006
A61M 5/315 2006
A61M 5/32 2006

(96) EP 17851873.4 12/19/2017
 (97) EP 3727516, 10/28/2020 202044, en

(54) AUTO-INJECTION DRUG DELIVERY DEVICE
 (72) MARCOZ, Alain, Espinasse Haut, 63160 Montmorin, FR
 PEREIRA, Alexandre, 14 rue Saint-Exupéry, 63170 Perignat-Les-Sarlieve, FR
 POLLARD, Mathieu, 3 allée des Coches d'Eau, 63430 Pont du Château, FR

- (51) MKP
B29B 11/16 2006 (97) EP 3256299
B29B 13/10 2006
B29C 70/54 2006
B29D 99/00 2010
B65H 45/00 2006
- (96) EP 16702818.2 1/4/2016
(97) EP 3256299, 11/4/2020 202045, en
(31) 201514619877 (32) 11.02.2015 (33) US
- (54) WIND TURBINE ROTOR BLADE COMPONENTS AND MACHINE FOR MAKING SAME
(71) Senvion GmbH, Überseering 10, 22297 Hamburg, DE
Upton, Daniel E., 39 Connors Farm Road, Smithfield, Rhode Island 02197, US
(72) UPTON, Daniel E., 39 Connors Farm Road, Smithfield, Rhode Island 02197, US
GRUHN, Joel D., 2 Tanglewood Drive, Barrington, Rhode Island 02806, US

- (51) MKP
A61K 9/00 2006 (97) EP 3247330
A61K 9/10 2006
A61K 31/195 2006
A61K 31/198 2006
A61K 47/38 2006
- (96) EP 16706041.7 1/20/2016
(97) EP 3247330, 11/4/2020 202045, en
(31) 201562105565 P (32) 20.01.2015 (33) US
201562272922 P 30.12.2015 US
- (54) LEVODOPA AND CARBIDOPA INTESTINAL GEL AND METHODS OF USE
(72) CONJEEVARAM, Rajkumar, 914 Safford Avenue, Lake Bluff, Illinois 60044, US
DEAC, Alexandru, 9133 Crawford Avenue, Skokie, Illinois 60076, US
HUANG, Ye, 33873 N. Summerfields Dr, Gurnee, Illinois 60031, US
MACKEY, Sean E., 744 Walton Lane, Grayslake, Illinois 60030, US
MENGES, Randy A., 36621 North Yew Tree Drive, Lake Villa, Illinois 60046, US
ZIMMERMAN, Jayne B., 637 Elder Lane, Deerfield, Illinois 60606, US

- (51) MKP
C01B 3/02 2006 (97) EP 3627050
C09C 1/48 2006
C10B 47/44 2006
C10B 53/07 2006
C10G 1/10 2006
C10L 1/00 2006
F23G 5/027 2006
F23G 5/08 2006
F23G 7/06 2006
F23G 7/12 2006
F23K 1/04 2006
- (96) EP 18398009.3 9/20/2018
(97) EP 3627050, 10/14/2020 202042, en
(54) PYROLYSIS PLANT
(71) Carreira, Germano Araújo, Rua do SEF n.º 23, 2945-651 Fátima, PT
(72) Carreira, Germano Araújo, Rua do SEF n.º 23, 2945-651 Fátima, PT

- (51) MKP
B08B 3/02 2006 (97) EP 3643414
B08B 9/023 2006
- (96) EP 18425080.1 10/25/2018
(97) EP 3643414, 12/9/2020 202050, en
(54) AN ULTRA-HIGH-PRESSURE WATER JETTING (UHPWJ) HYDRO-BLASTING CLEANING SYSTEM FOR SURFACES OF VERY LARGE DIMENSIONS AND/OR OF COMPLEX SHAPES AND/OR OF DIFFICULT ACCESS AND/OR WITH A HIGH ELEVATION
(71) Impresa Donelli SRL, Via Fratelli Cervi 7, 20025 Legnano (MI), IT
AMBPR, 28 Rue De Pommier, 38580 Alleverd, FR
(72) Donelli, Piero, Via Gilardelli 14, 20025 Legnano MI, IT
Donelli, Luca, Via Gilardelli 14, 20025 Legnano MI, IT
Prat, Pascal, 620, Chemin de Veyras, 07200 Lachapelle-Sous-Aubenas, FR

Bony, Olivier, 17, Route de Nodon, 26400 Allex, FR
 Renouard, Stéphane, 28, Rue de Pommier, 38580 Allevard, FR
 Chini, Andrea, Via Pisano, 5, 20014 Nerviano MI, IT

- (51) MKP
A61B 5/0456 2006 (97) EP 3624056
G06T 7/246 2017
 (96) EP 18464002.7 9/13/2018
 (97) EP 3624056, 10/28/2020 202044, en
 (54) PROCESSING IMAGE FRAMES OF A SEQUENCE OF CARDIAC IMAGES
 (71) Siemens Healthcare GmbH, Henkestraße 127, 91052 Erlangen, DE
 (72) Turcea, Alexandru, Cezar Petrescu, 24, Prahova, 105500 Busteni, RO
 Ciusdel, Costin Florian, Strada Valea Azugii, nr. 1, bl. 40, ap. 11, 105100 Azuga, RO
 Itu, Lucian Mihai, Str. Mestecanis Nr.3, bl. A35, Sc.B, Ap. 24, 500294 Brasov, RO
 Gulsun, Mehmet Akif, 101 Claridge Ct no. 11, Princeton, NJ 08540, US
 Passerini, Tiziano, 12 S. Linden Lane, Plainsboro, NJ 08536, US
 Sharma, Puneet, 12 Stanford Pl., Princeton Junction, NJ 08550, US

- (51) MKP
G06F 3/14 2006 (97) EP 3746877
G06F 11/16 2006
G06F 11/32 2006
G09G 5/00 2006
 (96) EP 18703286.7 1/31/2018
 (97) EP 3746877, 12/9/2020 202050, en
 (54) METHOD AND DEVICE FOR DISPLAYING SAFETY UNIT SIGNALS WITH INFORMATION REGARDING RELIABILITY OF DISPLAYED SIGNALS
 (71) Koncar - Inzenjering Za Energetiku I Transport D.D., Fallerovo setaliste 22, 10000 Zagreb, HR
 Koncar - Institut Za Elektrotehniku D.D., Fallerovo setaliste 22, 10000 Zagreb, HR
 (72) BILIC, Mario, Kralja Zvonimira 98, 10000 Zagreb, HR
 MRAOVIC, Davor, Matije Petra Katancica 44, 10430 Samobor, HR

- (51) MKP
F42B 12/10 2006 (97) EP 3714229
F42B 12/16 2006
F42B 12/18 2006
 (96) EP 18705814.4 1/31/2018
 (97) EP 3714229, 9/30/2020 202040, en
 (31) 390317 (32) 08.11.2017 (33) BG
 (54) TANDEM-CUMULATIVE SHOT
 (72) PETKOV, Stancho Petkov, 11 George Nikolov Str., 4330 Sopot, BG

- (51) MKP
G06K 9/00 2006 (97) EP 3598396
G07C 5/08 2006
 (96) EP 18184771.6 7/20/2018
 (97) EP 3598396, 12/9/2020 202050, de
 (54) COMPUTER-SUPPORTED METHOD FOR ANALYZING OF PERSONAL ACCIDENT DATA
 (71) Rothenbühler, Rudolf, Ebmatingerstrasse 14, 8126 Zumikon, CH
 Bono, Caroline, Ebmatingerstrasse 14, 8126 Zumikon, CH
 (72) Rothenbühler, Rudolf, Ebmatingerstrasse 14, 8126 Zumikon, CH
 Bono, Caroline, Ebmatingerstrasse 14, 8126 Zumikon, CH

- (51) MKP
A61B 17/00 2006 (97) EP 3154187
H02P 7/03 2016
 (96) EP 16190167.3 9/22/2016
 (97) EP 3154187, 12/23/2020 202052, en
 (31) 201514862415 (32) 23.09.2015 (33) US
 (54) SURGICAL STAPLER HAVING DOWNSTREAM CURRENT-BASED MOTOR CONTROL
 (72) YATES, David C., 4545 Creek Road, Cincinnati, OH 45242, US
 SHELTON, IV, Frederick E., 4545 Creek Road, Cincinnati, OH 45242, US

(51) MKP
A61B 17/00 2006 (97) EP 3154186
H02P 7/00 2016
H02P 7/06 2006

(96) EP 16190194.7 9/22/2016
(97) EP 3154186, 12/30/2020 202053, en
(31) 201514862421 (32) 23.09.2015 (33) US

(54) SURGICAL STAPLER HAVING MOTOR CONTROL BASED ON A DRIVE SYSTEM COMPONENT
(72) OVERMYER, Mark D., 4545 Creek Road, Cincinnati, OH 45242, US
YATES, David C., 4545 Creek Road, Cincinnati, OH 45242, US
SHELTON, IV, Frederick E., 4545 Creek Road, Cincinnati, OH 45242, US
ADAMS, Shane R., 4545 Creek Road, Cincinnati, OH 45242, US
HARRIS, Jason L., 4545 Creek Road, Cincinnati, OH 45242, US

(51) MKP
A61B 17/00 2006 (97) EP 3154188
G01R 19/00 2006
H02P 7/29 2016

(96) EP 16190223.4 9/22/2016
(97) EP 3154188, 12/30/2020 202053, en
(31) 201514862455 (32) 23.09.2015 (33) US

(54) SURGICAL STAPLER HAVING CURRENT MIRROR-BASED MOTOR CONTROL
(72) YATES, David C., 4545 Creek Road, Cincinnati, OH 45242, US
SHELTON, IV, Frederick E., 4545 Creek Road, Cincinnati, OH 45242, US

(51) MKP
A61B 17/34 2006 (97) EP 3150150

(96) EP 16191211.8 9/28/2016
(97) EP 3150150, 12/30/2020 202053, en
(31) 201514868634 (32) 29.09.2015 (33) US

(54) ADJUSTABLE ACCESS DEVICE FOR USE WITH SURGICAL INSTRUMENTS
(71) Ethicon Endo-Surgery, LLC, 4545 Creek Road, Cincinnati, OH 45242, US
(72) HESS, Christopher J., 4545 Creek Road, Cincinnati, OH 45242, US
SHELTON IV, Frederick E., 4545 Creek Road, Cincinnati, OH 45242, US
SAVAGE, Jeffrey L., 4545 Creek Road, Cincinnati, OH 45242, US
GATES, Craig T., 4545 Creek Road, Cincinnati, OH 45242, US
WITHERS, Douglas E., 4545 Creek Road, Cincinnati, OH 45242, US
HENSEL, Adam D., 4120 Estermarie Drive, Cincinnati, OH 45236, US

(51) MKP
A61K 31/444 2006 (97) EP 3713927
A61P 19/10 2006
C07D 401/14 2006
C07D 405/14 2006
C07D 471/04 2006

(96) EP 17817144.3 11/24/2017
(97) EP 3713927, 9/30/2020 202040, en
(54) PYRIDINONE DERIVATIVES AND THEIR USE AS SELECTIVE ALK-2 INHIBITORS
(72) ARISTA, Luca, Novartis Pharma AG Novartis Institutes for Biomed. Research Klybeck Postfach, 4002 Basel, CH
CHAMOIN, Sylvie, Novartis Pharma AG Novartis Institutes for Biomed. Research Postfach, 4002 Basel, CH
D'ALESSANDRO, Pier Luca, Novartis Pharma AG Novartis Institutes for Biomed. Research Klybeck Postfach, 4002 Basel, CH
LINDVALL, Mika, Novartis Institutes for BioMedical Research Inc. 5300 Chiron Way Bldg. 4, Emeryville, California 94608, US
LIZOS, Dimitrios, Novartis Pharma AG Postfach, 4002 Basel, CH
STIEFL, Nikolaus Johannes, Novartis Pharma AG Novartis Institutes for Biomed. Research Postfach, 4002 Basel, CH
TEIXEIRA-FOUCHARD, Sylvie, Novartis Pharma AG Novartis Institutes for Biomed. Research Postfach, 4002 Basel, CH
ULLRICH, Thomas, Novartis Pharma AG Novartis Institutes for Biomed. Research Postfach, 4002 Basel, CH
WEILER, Sven, Theodor Heuss-Strasse 19, 79539 Lörrach, DE

(51) MKP
F01N 1/16 2006 (97) EP 3660290
F01N 1/18 2006

F01N 13/04 2010
F01N 13/08 2010
F16K 1/00 2006
F16K 11/08 2006

- (96) EP 18208611.6 11/27/2018
 (97) EP 3660290, 1/6/2021 202101, en
 (54) GAS FLOW AND SOUND CONTROL VALVE AND EXHAUST GAS SYSTEM
 (72) Penca, Jure, Zoisova ulica 50b, 1230 Domzale, SI
 Akrapovic, Igor, Rozna dolina, cesta VIII/10a, 1000 Ljubljana, SI
-

(51) MKP
A61K 9/08 2006 (97) EP 3659594
A61K 31/216 2006
A61M 5/178 2006

- (96) EP 18209583.6 11/30/2018
 (97) EP 3659594, 11/11/2020 202046, de
 (54) A STERILE SOLUTION WITH AN APPLICATION INJECTOR COMPRISING A MEDICAL AGENT AND METHOD FOR PRODUCING SAME
 (71) Stegemann, Klaus, Hackmackbogen 82, 21035 Hamburg, DE
 (72) Stegemann, Klaus, Hackmackbogen 82, 21035 Hamburg, DE
-

(51) MKP
C08G 64/02 2006 (97) EP 3660075
C08G 64/08 2006
C08G 64/12 2006
C08G 64/14 2006
C08G 64/42 2006

- (96) EP 18209620.6 11/30/2018
 (97) EP 3660075, 1/6/2021 202101, en
 (54) ENDCAPPED POLYCARBONATES, METHODS OF MANUFACTURE, AND ARTICLES FORMED THEREFROM
 (72) SYBERT, Paul Dean, 1 Lexan Lane, Mt Vernon, IN Indiana 47620, US
 CALVERAS, Jordi, 1 Lexan Lane, Mt Vernon, IN Indiana 47620, US
 MAHOOD, James Alan, 1 Lexan Lane, Mt Vernon, IN Indiana 47620, US
 HOOVER, James Franklin, 1 Lexan Lane, Mt Vernon, IN Indiana 47620, US
-

(51) MKP
A61K 9/70 2006 (97) EP 3666341
A61K 35/747 2015
A61L 15/00 2006
A61P 17/00 2006
A61Q 19/00 2006

- (96) EP 18212580.7 12/14/2018
 (97) EP 3666341, 12/16/2020 202051, en
 (54) TOPICAL FORMULATION IN FORM OF A PATCH, A BANDAGE OR A PLASTER COMPRISING PROBIOTIC BACTERIA, AND USE THEREOF IN A METHOD FOR TREATING OR PREVENTING SKIN DISORDERS
 (71) DWI - Leibniz-Institut für Interaktive Materialien e.V., Forckenbeckstrasse 50, 52074 Aachen, DE
 (72) Heine, Elisabeth, DWI Leibniz-Institut für Interaktive Materialien e.V. Schützenstr. 13, 52385 Nideggen, DE
 Lütticken, Rudolf, Beulardsteiner Feld 25, 52072 Aachen, DE
 Gartzten, Rita, Hüpchensweid 8, 52146 Würselen, DE
 Khalfallah, Ghazi, Ottostr. 26, 52070 Aachen, DE
-

(51) MKP
B62B 3/14 2006 (97) EP 3670292
B62B 3/16 2006
B62B 5/00 2006

- (96) EP 18213828.9 12/19/2018
 (97) EP 3670292, 12/9/2020 202050, de
 (54) SYSTEM FOR TRANSPORTING, HANDLING AND/OR STORAGE OF GOODS
 (71) Koch, Hilko, Kaiserstraße 107, 47800 Krefeld, DE
 (72) Koch, Hilko, Kaiserstraße 107, 47800 Krefeld, DE
-

(51) MKP
G06F 9/54 2006 (97) EP 3620921

- (96) EP 18192838.3 9/5/2018

- (97) EP 3620921, 10/14/2020 202042, en
 (54) COMPUTER-IMPLEMENTED METHOD, DATA PROCESSING APPARATUS, COMPUTER PROGRAM, AND DATA CARRIER SIGNAL
 (71) Forcam GmbH, An der Bleicherei 15, 88214 Ravensburg, DE
 (72) Sinsel, Alexander, Forcam GmbH An der Bleicherei 15, 88214 Ravensburg, DE
-

- (51) MKP
H04R 2006(97) EP 3644620
 (96) EP 18193193.2 9/7/2018
 (97) EP 3644620, 12/9/2020 202050, de
 (54) IN-EAR ANC EARPHONE
 (72) PERKMANN, Michael, Markgraf-Rüdiger-Strasse 7/71, 1150 Wien, AT
 WÖHRER, Daniel, Wohlmuttgasse 13, 3003 Gablitz, AT
-

- (51) MKP
E06B 3/263 2006 (97) EP 3626927
E06B 3/36 2006
 (96) EP 18195554.3 9/19/2018
 (97) EP 3626927, 11/4/2020 202045, de
 (54) COMPOSITE PROFILE FOR WINDOWS AND/OR DOORS
 (71) RP Technik GmbH Profilsysteme, Edisonstrasse 4., 59199 Bönen, DE
 (72) Schmitte, Bernd, Rostockweg 19, 48147 Münster, DE
-

- (51) MKP
A61K 31/165 2006 (97) EP 3755684
A61P 25/14 2006
A61P 25/18 2006
A61P 25/22 2006
A61P 25/24 2006
A61P 25/28 2006
C07C 235/08 2006
C07C 235/40 2006
 (96) EP 18708346.4 2/20/2018
 (97) EP 3755684, 12/30/2020 202053, en
 (54) ALCOHOL DERIVATIVES AS KV7 POTASSIUM CHANNEL OPENERS
 (72) ROTTLÄNDER, Mario, Svanemosen 10, 2670 Greve, DK
 SAMS, Anette, Graven, Thorsmosen 4, 3500 Værløse, DK
 WANG, Xiaofang, Room 601 No. 2 Lane 354 Linghe Road Pudong New District, Shanghai, 200120, CN
 DAS, Debasis, Room 1102 No.31 Lane 2000 DongLu Road Pudong New District, Shanghai, 200120, CN
 HONG, Jian, Room 202 No. 34 Lane 1424 Wulian Road Pudong New District, Shanghai, 200129, CN
 CHEN, Shu, Hui, 3789 Camino Codorniz, Calabasas, CA 91302, US
-

- (51) MKP
G01N 33/68 2006 (97) EP 3631468
 (96) EP 18733465.1 6/1/2018
 (97) EP 3631468, 1/6/2021 202101, en
 (31) 201762514762 P (32) 02.06.2017 (33) US
 201762515526 P 05.06.2017 US
 (54) ARTICLES OF MANUFACTURE AND METHODS RELATED TO TOXICITY ASSOCIATED WITH CELL THERAPY
 (72) YEE, Nathan, 400 Dexter Ave. N. Suite 1200, Seattle, Washington 98109, US
 RAMSBORG, Christopher Glen, 400 Dexter Ave. N. Suite 1200, Seattle, Washington 98109, US
 ALBERTSON, Tina, 400 Dexter Ave. N. Suite 1200, Seattle, Washington 98109, US
 LARSON, Ryan, 400 Dexter Ave. N Suite 1200, Seattle, WA 98109, US
 LI, He, 400 Dexter Ave. N Suite 1200, Seattle, WA 98109, US
-

- (51) MKP
C25B 1/04 2006 (97) EP 3720990
F03D 9/19 2016
 (96) EP 18765766.3 7/25/2018
 (97) EP 3720990, 10/14/2020 202042, en
 (31) 42373417 (32) 05.12.2017 (33) PL
 (54) A METHOD OF HYDROGEN AND OXYGEN PRODUCTION BY ELECTROLYSIS METHOD, IN PARTICULAR ELECTROLYSIS OF WATER

(71) Promet-Past S.C. Elzbieta Jezewska Andrzej Jezewska, Godzikowice 50A, 55-200 Olawa, PL

Jezewski, Andrzej, Ul. Polna 12a, 55-200 Olawa, PL

(72) JEZEWSKI, Andrzej, ul. Polna 12a, 55-200 Olawa, PL

(51) MKP

H02J 3/32 2006 (97) EP 3753084

H02J 9/06 2006

(96) EP 18773624.4 8/27/2018

(97) EP 3753084, 12/23/2020 202052, en

(31) 201815915122 (32) 08.03.2018 (33) US

(54) POWER CONTROL SYSTEM

(72) HAJ-MAHARSI, Mohamed Y., P.O. Box. 19314, Al-Midra Tower Building,, Dhahran, 31311, SA

ALTALHI, Abdulaziz A., P.O. Box. 18068,, Dhahran, 31311, SA

(51) MKP

E06B 3/667 2006 (97) EP 3553267

E06B 3/964 2006

(96) EP 19168554.4 4/10/2019

(97) EP 3553267, 9/30/2020 202040, de

(31) 102018108650 (32) 11.04.2018 (33) DE

(54) FITTING

(72) RAFELD-CECH, Karin, Frohnschwenden 77, D-87499 Wildpoldsried, DE

(51) MKP

A61K 31/131 2006 (97) EP 3586861

A61K 31/132 2006

A61K 31/215 2006

A61K 31/56 2006

A61K 38/00 2006

A61K 38/16 2006

A61K 38/43 2006

(96) EP 19172992.0 6/8/2012

(97) EP 3586861, 11/11/2020 202046, en

(31) 201161494881 P (32) 08.06.2011 (33) US

(54) LIPID NANOPARTICLE COMPOSITIONS AND METHODS FOR MRNA DELIVERY

(72) GUILD, Braydon Charles, 109 Riverdale Road, Concord, MA Massachusetts 01742, US

DEROSA, Frank, 26 Mount Auburn Street, Chelmsford, MA Massachusetts 01824, US

HEARTLEIN, Michael, 167 Reed Farm Road, Boxborough, MA Massachusetts 01719, US

(51) MKP

A61K 9/48 2006 (97) EP 3713552

A61K 31/047 2006

A61P 15/00 2006

(96) EP 18718160.7 4/19/2018

(97) EP 3713552, 9/30/2020 202040, en

(31) 17382791 (32) 23.11.2017 (33) EP

(54) METHOD FOR INCREASING EMBRYO IMPLANTATION RATE IN A FEMALE SUBJECT SUFFERING POLYCYSTIC OVARY SYNDROME

(71) Biosearch S.A., Camino de Purchil 66, 18004 Granada, ES

(72) OLIVARES MARTÍN, Mónica, Avenida de los Almendros 162, E-18198 Huetor Vega - Granada, ES

FONOLLÁ JOYÁ, Juristo, Dr. Muñoz Fernández nº 4 1°C, E-18012 Granada, ES

DÍAZ-ROPERO MEDINA, María Paz, Isla de la Gomera nº 4 escalera 1 2°F, E-18014 Granada, ES

LÓPEZ LARRAMENDI, José Luis, Juan de Urbietta 22 5ºB, E-28007 Madrid, ES

MENDOZA LADRÓN DE GUEVARA, Nicolás, Maestro Montero nº 21, E-18004 Granada, ES

(51) MKP

A61K 31/439 2006 (97) EP 3630111

A61P 31/04 2006

C07D 471/08 2006

(96) EP 18726702.6 5/8/2018

(97) EP 3630111, 12/9/2020 202050, en

(31) 201762502867 P (32) 08.05.2017 (33) US

(54) COMPOUNDS AND METHODS FOR TREATING BACTERIAL INFECTIONS

- (71) Entasis Therapeutics, Inc., 35 Gatehouse Drive, Waltham, MA 02451, US
 (72) COMITA-PREVOIR, Janelle, 11 Prospect Street, Northborough, MA 01532, US
 DURAND-REVILLE, Thomas, Francois, 34 Birch Hill Road, Belmont, MA 02478, US
 GULER, Satenig, 35 Gatehouse Drive, Waltham, MA 02451, US
 ROMERO, Jan, 8 Langley Road, Arlington, MA 02474, US
 SYLVESTER, Mark, 35 Gatehouse Drive, Waltham, MA 02451, US
 TOMMASI, Ruben, 16 Salamander Lane, Stow, MA 01775, US
 VELEZ-VEGA, Camilo, 35 Gatehouse Drive, Waltham, MA 02451, US
 WU, Xiaoyun, 3 Hundreds Road, Westborough, MA 01581, US
 ZHANG, Jing, 11 Run Brook Circle, Sudbury, MA 01776, US

- (51) MKP
G07F 19/00 2006 (97) EP 3756173
 (96) EP 18729761.9 2/23/2018
 (97) EP 3756173, 12/30/2020 202053, en
 (54) METHOD FOR DETECTING THE PRESENCE OF A SMART CARD CLONING DEVICE IN AN AUTOMATIC PAYMENT AND/OR WITHDRAWAL TERMINAL AND RESPECTIVE AUTOMATIC PAYMENT AND/OR WITHDRAWAL TERMINAL
 (71) Madic Italia S.p.A., Via Volta 39, 21010 Cardano al Campo (VA), IT
 (72) BELVISI, Alberto, Via Aldo Moro 12, 21054 Fagnano Olona (Varese), IT

- (51) MKP
A23L 2/42 2006 (97) EP 3727026
A23L 3/015 2006
 (96) EP 18792931.0 10/24/2018
 (97) EP 3727026, 10/28/2020 202044, de
 (31) 102017011752 (32) 19.12.2017 (33) DE
 (54) METHOD FOR THE INACTIVATION OF MICROORGANISMS IN FOODS
 (72) TRIFUNOVIC, Ratka, Schamederstr. 21, 57339 Erndtebrück, DE

- (51) MKP
A61K 31/4045 2006 (97) EP 3713568
A61K 45/06 2006
A61P 25/00 2006
 (96) EP 18796407.7 10/26/2018
 (97) EP 3713568, 9/30/2020 202040, en
 (31) 17382718 (32) 26.10.2017 (33) EP
 (54) COMBINATION PRODUCT FOR THE TREATMENT OF NEUROLOGICAL AND/OR PSYCHIATRIC DISORDERS
 (71) Consejo Superior de Investigaciones Científicas (CSIC), C/ Serrano 117, 28006 Madrid, ES
 Universidad Autónoma de Madrid, Ciudad Universitaria Cantoblanco C/Einstein 3, 28049 Madrid, ES
 Centro De Investigación Biomédica En Red De Enfermedades Neurodegenerativas Cibernet, Centro Alzheimer Fundación Reina Sofia C/ Valderrebollo 5, 28031 Madrid, ES
 BlumenTech S.L., C/Ausias March 24, 1° 2ª, 08010 Barcelona, ES
 Institut Recerca Hospital de la Santa Creu I Sant Pau, C/Sant Antoni Maria Claret 167, 08025 Barcelona, ES
 (72) PEREZ CASTILLO, Ana María, Instituto de Investigaciones Biomédicas "Alberto Sols" Calle Arturo Duperier 4, 28029 Madrid, ES
 RIBA SERRANO, Jordi, BlumenTech S.L. C/Ausias March 24 1° 2ª, 08010 Barcelona, ES
 MORALES GARCÍA, Jose Ángel, CENTRO DE INVESTIGACIÓN BIOMÉDICA EN REDDE ENFERMEDADES NEURODEGENERATIVAS Cibernet Centro Alzheimer Fundación Reina Sofia C/ Valderrebollo 5 E, 28031 Madrid, ES

- (51) MKP
B65B 9/02 2006 (97) EP 3737619
B65D 75/58 2006
 (96) EP 18796503.3 8/13/2018
 (97) EP 3737619, 11/18/2020 202047, en
 (31) 201700149752 (32) 09.01.2018 (33) IT
 (54) APPARATUS AND METHOD FOR PRODUCING A SEALED SINGLE-DOSE BREAK-OPEN PACKAGE
 (71) V-Shapes S.r.l., Via Persicetana 20/B, 40012 Calderara di Reno (BO), IT
 (72) Gustvasson, Erland Jesper, St. Dr. Kristinas vag. 1, Sigtuna 54534 Toreböda, SE

- (51) MKP
A61C 17/20 2006 (97) EP 3740154
A61C 17/22 2006
A61C 17/34 2006

(96)	EP 18799455.3	10/23/2018					
(97)	EP 3740154,	11/25/2020	202048,	en			
(31)	18152472		(32)	19.01.2018	(33)		EP
	18185450			25.07.2018			EP
(54)	TEETH CLEANING DEVICE AND CARRIER STRUCTURE FOR MOUTHPIECE OF A TEETH CLEANING DEVICE						
(72)	KEINER, Michael, Rotkehlchenweg 10, 35619 Braunfels, DE						
	SÖRGEL, Norbert, Münchenerstr. 42, 82031 Grünwald, DE						
(51)	MKP						
	A61K 9/00	2006	(97) EP 3636250				
	A61K 9/08	2006					
	A61K 38/22	2006					
	A61K 38/26	2006					
	A61K 38/28	2006					
	A61K 47/02	2006					
	A61K 47/10	2017					
	A61K 47/26	2006					
(96)	EP 19184732.6	5/17/2011					
(97)	EP 3636250,	11/25/2020	202048,	en			
(31)	10305532		(32)	19.05.2010	(33)		EP
	10305780			13.07.2010			EP
	11305140			10.02.2011			EP
(54)	LONG-ACTING FORMULATIONS OF INSULINS						
(72)	Becker, Reinhard, Gertrud-Bäumer-Strasse 21, 65189 Wiesbaden, DE						
	Hahn, Anne, c/o Sanofi-Aventis Deutschland GmbH Global Intellectual Property Department Industriepark Höchst, Geb. K 703, 65926 Frankfurt am Main, DE						
	Boderke, Peter, Bockenheimer Strasse 3, 65824 Schwalbach, DE						
	Fuerst, Christiane, c/o Sanofi-Aventis Deutschland GmbH Global Intellectual Property Department Industriepark Höchst, Geb. K 703, 65926 Frankfurt am Main, DE						
	Mueller, Werner, c/o Sanofi-Aventis Deutschland GmbH, 65926 Frankfurt am Main, DE						
	Tertsch, Katrin, c/o Sanofi-Aventis Deutschland GmbH, 65926 Frankfurt am Main, DE						
	Werner, Ulrich, c/o Sanofi-Aventis Deutschland GmbH Global Intellectual Property Department Industriepark Höchst, Geb. K 703, 65926 Frankfurt am Main, DE						
	Loos, Petra, c/o Sanofi-Aventis Deutschland GmbH, 65926 Frankfurt am Main, DE						
(51)	MKP						
	A61B 17/04	2006	(97) EP 3593730				
	A61B 17/06	2006					
(96)	EP 19185715.0	7/11/2019					
(97)	EP 3593730,	11/4/2020	202045,	en			
(31)	201816033549		(32)	12.07.2018	(33)		US
(54)	ADJUSTABLE LOOP WITH LOCKING KNOT						
(71)	DePuy Synthes Products, LLC, 325 Paramount Drive, Raynham, MA 02767, US						
(72)	PICCIRILLO, Justin, 325 Paramount Drive, Raynham, MA 02767, US						
(51)	MKP						
	A61K 31/4375	2006	(97) EP 3617205				
	A61K 31/444	2006					
	A61K 31/519	2006					
	A61K 31/5377	2006					
	A61K 31/541	2006					
	A61P 19/00	2006					
	A61P 35/00	2006					
	C07D 471/04	2006					
(96)	EP 19187640.8	2/19/2016					
(97)	EP 3617205,	10/7/2020	202041,	en			
(31)	201562118698 P		(32)	20.02.2015	(33)		US
	201562170936 P			04.06.2015			US
(54)	BICYCLIC HETEROCYCLES AS FGFR INHIBITORS						
(72)	LU, Liang, 605 Sunflower Circle, Hockessin, DE 19707, US						
	SHEN, Bo, 15 Martins Court, Garnet Valley, PA 19060, US						
	SOKOLSKY, Alexander, 1 Academy Circle Apt. 208, Philadelphia, PA 19146, US						
	WANG, Xiaozhao, c/o Incyte Corporation 1801 Augustine Cut-Off, Wilmington, DE 19803, US						
	WU, Liangxing, 108 Sassafrass Court, Wilmington, DE 19808, US						

YAO, Wenqing, 45 Magnolia Way, Cadds Ford, PA 19317, US
 YE, Yingda, 2506 Cedar Tree Drive Apt. 3D, Wilmington, DE 19810, US

- (51) MKP
A61K 31/7088 2006 (97) EP 3646876
A61K 31/7125 2006
A61P 7/00 2006
A61P 7/06 2006
A61P 35/00 2006
A61P 35/02 2006
- (96) EP 19187756.2 11/15/2013
 (97) EP 3646876, 12/16/2020 202051, en
- | | | | | | |
|------|----------------|------|------------|------|----|
| (31) | 201261734941 P | (32) | 07.12.2012 | (33) | US |
| | 201361799069 P | | 15.03.2013 | | US |
| | 201313841711 | | 15.03.2013 | | US |
| | 201361900347 P | | 05.11.2013 | | US |
- (54) USE OF TELOMERASE INHIBITORS FOR THE TREATMENT OF MYELOPROLIFERATIVE DISORDERS AND MYELOPROLIFERATIVE NEOPLASMS
- (71) Geron Corporation, 919 E. Hillsdale Blvd., Foster City, CA 94404, US
 (72) STUART, Monic, J., 2828 Churchill Drive, Hillsborough, CA 94010, US
 KELSEY, Stephen, 1468 Hamilton Avenue, Palo Alto, CA 94301, US

- (51) MKP
A61K 35/74 2015 (97) EP 3626248
A61K 35/745 2015
A61P 1/00 2006
A61P 11/06 2006
A61P 19/02 2006
A61P 25/28 2006
A61P 29/00 2006
A61P 35/00 2006
C12N 1/20 2006
- (96) EP 19187822.2 6/15/2016
 (97) EP 3626248, 11/4/2020 202045, en
- | | | | | | |
|------|-----------|------|------------|------|----|
| (31) | 201510470 | (32) | 15.06.2015 | (33) | GB |
| | 201520510 | | 20.11.2015 | | GB |
| | 201603786 | | 04.03.2016 | | GB |
- (54) COMPOSITIONS COMPRISING BACTERIAL STRAINS
- (72) GRANT, George, Life Sciences Innovation Building Cornhill Road, Aberdeen, Aberdeenshire AB25 2ZS, GB
 PATTERSON, Angela Margaret, Norwich Medical School Faculty of Medicine and Health Sciences University of East Anglia, Norwich, Norfolk NR4 7JT, GB
 MULDER, Imke, Life Sciences Innovation Building Cornhill Road, Aberdeen, Aberdeenshire AB25 2ZS, GB
 MCCLUSKEY, Seanin, c/o 4D PHARMA PLC 3rd Floor 9 Bond Court, Leeds, Yorkshire LS1 2JZ, GB
 RAFTIS, Emma, c/o 4D PHARMA PLC 3rd Floor 9 Bond Court, Leeds, Yorkshire LS1 2JZ, GB

- (51) MKP
A61M 5/142 2006 (97) EP 3583966
A61M 5/145 2006
A61M 5/20 2006
A61M 5/315 2006
A61M 5/32 2006
- (96) EP 19187890.9 10/28/2016
 (97) EP 3583966, 10/21/2020 202043, en
- | | | | | | |
|------|----------|------|------------|------|----|
| (31) | 15191929 | (32) | 28.10.2015 | (33) | EP |
|------|----------|------|------------|------|----|
- (54) SINGLE-USE AUTO-INJECTOR
- (72) KNUDSEN, Hans Stenberg, c/o NNE A/S Bredevej 2, 2830 Virum, DK
 PLAMBECH, Christian, c/o NNE A/S Bredevej 2, 2830 Virum, DK
 ØHLENSCHLÆGER, Rasmus, c/o NNE A/S Bredevej 2, 2830 Virum, DK
 JØRGENSEN, Jørgen, c/o NNE Pharmaplan Nybrovej 80, 2820 Gentofte, DK

- (51) MKP

	A61K 31/7125	2006	(97) EP 3620522				
	A61P 13/12	2006					
	C12N 15/113	2010					
(96)	EP 19188663.9 10/8/2013						
(97)	EP 3620522, 10/21/2020 202043, en						
(31)	201261711514 P		(32)	09.10.2012	(33)	US	
	201361779137 P			13.03.2013		US	
(54)	METHODS FOR TREATMENT OF ALPORT SYNDROME						
(72)	DUFFIELD, Jeremy, 3545 John Hopkins Court Suite 210, San Diego, CA California 92121, US						
	BHAT, Balkrishen, 3545 John Hopkins Court Suite 210, San Diego, CA California 92121, US						
	MACKENNA, Deidre, 3545 John Hopkins Court Suite 210, San Diego, CA California 92121, US						
<hr/>							
(51)	MKP						
	F04D 29/54	2006	(97) EP 3617529				
(96)	EP 19188756.1 7/29/2019						
(97)	EP 3617529, 10/14/2020 202042, de						
(31)	102018214782		(32)	30.08.2018	(33)	DE	
(54)	FAN FRAME OF A MOTOR VEHICLE						
(72)	SCHÄFER, Tilman, Breeweg 31, 26188 Edewecht, DE						
	FINDEISEN, Antje, Wallheckenring 23, 26125 Oldenburg, DE						
<hr/>							
(51)	MKP						
	A61K 31/4738	2006	(97) EP 3640251				
	A61K 31/497	2006					
	A61P 35/00	2006					
	C07D 471/04	2006					
(96)	EP 19189010.2 10/13/2017						
(97)	EP 3640251, 12/2/2020 202049, en						
(31)	201662411799 P		(32)	24.10.2016	(33)	US	
	201662435159 P			16.12.2016		US	
(54)	6,7,8,9-TETRAHYDRO-3H-PYRAZOLO[4,3-F]ISOQUINOLINE DERIVATIVES USEFUL IN THE TREATMENT OF CANCER						
(72)	SCOTT, James Stewart, AstraZeneca, Darwin Building Cambridge Science Park Milton Road, Cambridge Cambridgeshire CB4 0WG, GB						
	BARLAAM, Bernard Christophe, AstraZeneca, Darwin Building Cambridge Science Park Milton Road, Cambridge Cambridgeshire CB4 0WG, GB						
	YANG, Bin, AstraZeneca 35 Gatehouse Drive, Waltham, MA 02451, US						
	MOSS, Thomas Andrew, AstraZeneca, Darwin Building Cambridge Science Park Milton Road, Cambridge Cambridgeshire CB4 0WG, GB						
	HUGHES, Samantha Jayne, AstraZeneca, Darwin Building Cambridge Science Park Milton Road, Cambridge Cambridgeshire CB4 0WG, GB						
	NISSINK, Johannes Wilhelmus Maria, AstraZeneca, Darwin Building Cambridge Science Park Milton Road, Cambridge Canbridgeshire CB4 0WG, GB						
	O'DONOVAN, Daniel Hillebrand, AstraZeneca, Darwin Building Cambridge Science Park Milton Road, Cambridge Cambridgeshire CB4 0WG, GB						
<hr/>							
(51)	MKP						
	A61K 35/74	2015	(97) EP 3636272				
	A61K 35/745	2015					
	A61P 1/00	2006					
	A61P 11/06	2006					
	A61P 19/02	2006					
	A61P 25/28	2006					
	A61P 29/00	2006					
	A61P 35/00	2006					
	C12N 1/20	2006					
(96)	EP 19189140.7 6/15/2016						
(97)	EP 3636272, 11/18/2020 202047, en						
(31)	201510466		(32)	15.06.2015	(33)	GB	
	201520508			20.11.2015		GB	
	201606810			19.04.2016		GB	
(54)	COMPOSITIONS COMPRISING BACTERIAL STRAINS						
(72)	GRANT, George, Life Sciences Innovation Building Cornhill Road, Aberdeen, Aberdeenshire AB25 2ZS, GB						
	PATTERSON, Angela Margaret, Norwich Medical School Faculty of Medicine and Health Sciences University of East Anglia, Norwich, Norfolk NR4 7JT, GB						
	MULDER, Imke, Life Sciences Innovation Building Cornhill Road, Aberdeen, Aberdeenshire AB25 2ZS, GB						
	MCCLUSKEY, Seanin, c/o 4D PHARMA PLC 3rd Floor 9 Bond Court, Leeds, Yorkshire LS1 2JZ, GB						
	RAFTIS, Emma, c/o 4D PHARMA PLC 3rd Floor 9 Bond Court, Leeds, Yorkshire LS1 2JZ, GB						

(51) MKP
A61K 39/395 2006 (97) EP 3632466
A61P 17/06 2006
C07K 16/28 2006
(96) EP 19189613.3 1/12/2011
(97) EP 3632466, 11/18/2020 202047, en
(31) 295387 P (32) 15.01.2010 (33) US
422059 P 10.12.2010 US
(54) ANTI IL-17RA ANTIBODY FORMULATION AND THERAPEUTIC REGIMENS FOR TREATING PSORIASIS
(71) Amgen K-A, Inc., One Amgen Center Drive, Thousand Oaks, CA 91320-1799, US
(72) LIU, Dingjiang, 766 Bellagio Court, Oak Park, CA 91377, US
HUANG, Holly Zhuohong, 1792 Amarelle Street, Thousand Oaks, CA 91320, US
MARTIN, David Andrew, 6515 20th Avenue NE, Seattle, WA 98115, US
RUSSELL, Christopher Boyd, 3570 Crystal Springs Dr. NE, Bainbridge Island, WA 98110, US
SALINGER, David H., 6234 29th Avenue NE, Seattle, WA 98115, US
BAUMGARTNER, Scott Walter, 3020 Hollycrest Avenue, Thousand Oaks, CA 91362, US
ENDRES, Christopher J., 3258 NW Market Street, Seattle, WA 98107, US

(51) MKP
B31B 120/40 2017 (97) EP 3604154
B65D 5/56 2006
B65D 77/20 2006
(96) EP 19189776.8 8/2/2019
(97) EP 3604154, 10/14/2020 202042, de
(31) 102018118940 (32) 03.08.2018 (33) DE
(54) PACKAGING
(72) Engel, Gottfried, Widumstrasse 16, 87452 Altusried, DE

(51) MKP
A61K 39/00 2006 (97) EP 3632931
A61P 27/02 2006
C07K 16/24 2006
(96) EP 19189890.7 11/6/2015
(97) EP 3632931, 11/18/2020 202047, en
(31) 201462077105 P (32) 07.11.2014 (33) US
201462087448 P 04.12.2014 US
201562247705 P 28.10.2015 US
(54) IMPROVED IL-6 ANTIBODIES
(71) Sesen Bio, Inc., 245 First Street, Suite 1800, Cambridge, Massachusetts 02142, US
(72) SCHMIDT, Michael March, 14 Pilgrim Rd., Wellesley, MA 02481-2450, US
TISDALE, Alison, 207 White Street, Belmont, MA 02478, US
FURFINE, Eric Steven, 221 Lincoln Rd, Lincoln, MA 01773, US
ZARBIS-PAPASTOITSIS, Grigorios, 34 Phillips Street, Watertown, MA 02472, US

(51) MKP
A61K 31/519 2006 (97) EP 3626720
A61P 35/00 2006
A61P 35/02 2006
C07D 487/04 2006
C07D 519/00 2006
(96) EP 19190014.1 4/1/2016
(97) EP 3626720, 11/4/2020 202045, en
(31) 201562142717 P (32) 03.04.2015 (33) US
201562183906 P 24.06.2015 US
(54) HETEROCYCLIC COMPOUNDS AS LSD1 INHIBITORS
(72) HE, Chunhong, 40 Magnolia Way, Chadds Ford, PA 19317, US
LI, Zhenwu, c/o Incyte Corporation 1801 Augustine Cut-Off, Wilmington, DE 19803, US
WU, Liangxing, 108 Sassafrass Court, Wilmington, DE 19808, US
YAO, Wenqing, 45 Magnolia Way, Chadds Ford, PA 19317, US
ZHANG, Fenglei, 309 Daniel Drive, Ambler, PA 19002, US

(51) MKP

A61K 31/445 2006 (97) EP 3626714
C07D 211/98 2006
C07D 401/04 2006
C07D 401/14 2006
C07D 405/12 2006
C07D 405/14 2006
C07D 413/06 2006
C07D 417/14 2006
(96) EP 19190056.2 2/12/2015
(97) EP 3626714, 11/4/2020 202045, en
(31) 201461939458 P (32) 13.02.2014 (33) US
201462061258 P 08.10.2014 US
(54) CYCLOPROPYLAMINES AS LSD1 INHIBITORS
(72) ZHANG, Fenglei, 309 Daniel Drive, Ambler, PA Pennsylvania 19002, US
COURTER, Joel R., c/o Incyte Corporation 1801 Augustine Cut-Off, Wilmington, Delaware 19803, US
WU, Liangxing, 108 Sassafrass Court, Wilmington, DE 19808, US
HE, Chunhong, 40 Magnolia Way, Chadds Ford, PA 19317, US
KONKOL, Leah C., 1710 Gilpin Avenue, Wilmington, DE 19806, US
QIAN, Ding-Quan, 10 Donald Preston Drive, Newark, DE 19702, US
SHEN, Bo, 15 Martins Court, Garnet Valley, PA 19060, US
YAO, Wenqing, 45 Magnolia Way, Chadds Ford, PA 19317, US

(51) MKP
C07H 21/00 2006 (97) EP 3636742
C12N 1/08 2006
C12N 15/10 2006
(96) EP 19190270.9 4/24/2015
(97) EP 3636742, 11/18/2020 202047, en
(31) 201461984503 P (32) 25.04.2014 (33) US
(54) METHODS FOR PURIFICATION OF MESSENGER RNA
(72) DEROSA, Frank, Translate Bio, Inc. 29 Hartwell Avenue, Lexington, MA Massachusetts 02421, US
DIAS, Anusha, Translate Bio, Inc. 29 Hartwell Avenue, Lexington, MA Massachusetts 02421, US
KARVE, Shirang, Translate Bio, Inc. 29 Hartwell Avenue, Lexington, MA Massachusetts 02421, US
HEARTLEIN, Michael, Translate Bio, Inc. 29 Hartwell Avenue, Lexington, MA Massachusetts 02421, US

(51) MKP
A61K 31/397 2006 (97) EP 3626713
A61K 31/438 2006
A61K 31/4427 2006
A61K 31/4439 2006
A61K 31/445 2006
A61K 31/4468 2006
A61K 31/454 2006
A61K 31/4545 2006
A61K 31/496 2006
A61K 31/501 2006
A61K 31/506 2006
C07D 205/04 2006
C07D 211/14 2006
C07D 211/16 2006
C07D 211/58 2006
C07D 401/06 2006
C07D 401/12 2006
C07D 471/10 2006
(96) EP 19190494.5 2/12/2015
(97) EP 3626713, 11/4/2020 202045, en
(31) 201461939488 P (32) 13.02.2014 (33) US
201462061283 P 08.10.2014 US
(54) CYCLOPROPYLAMINES AS LSD1 INHIBITORS
(72) WU, Liangxing, 108 Sassafrass Court, Wilmington, DE Delaware 19808, US
HE, Chunhong, 40 Magnolia Way, Chadds Ford, PA Pennsylvania 19317, US
QIAN, Ding-Quan, 10 Donald Preston Drive, Newark, DE Delaware 19702, US
SHEN, Bo, 15 Martins Court, Garnet Valley, PA Pennsylvania 19060, US
WANG, Xiaozhao, c/o Incyte Corporation 1801 Augustine Cut-Off, Wilmington, Delaware 19803, US
YAO, Wenqing, 45 Magnolia Way, Chadds Ford, PA Pennsylvania 19317, US

ZHANG, Fenglei, 309 Daniel Drive, Ambler, PA Pennsylvania 19002, US
 COURTER, Joel R., 13308 Elam Drive, Glen Mills, PA Pennsylvania 19342, US

- (51) MKP
C07D 239/46 2006 (97) EP 3626710
- (96) EP 19191353.2 9/25/2015
 (97) EP 3626710, 10/21/2020 202043, en
- (31) 201462055893 P (32) 26.09.2014 (33) US
- (54) PROCESSES FOR PREPARING (CYCLOPENTYL[D]PYRIMIDIN-4-YL)PIPERAZINE COMPOUNDS
 (72) GOSSELIN, Francis, c/o Genentech, Inc. 1 DNA Way, South San Francisco, CA 94080-4990, US
 HAN, Chong, c/o Genentech, Inc. 1 DNA Way, South San Francisco, CA 94080-4990, US
 IDING, Hans, c/o F. Hoffmann-La Roche AG Grenzacherstrasse 124, 4070 Basel, CH
 REENTS, Reinhard, c/o F. Hoffmann-La Roche AG Grenzacherstrasse 124, 4070 Basel, CH
 SAVAGE, Scott, c/o Genentech, Inc. 1 DNA Way, South San Francisco, CA 94080-4990, US
 WIRZ, Beat, c/o F. Hoffmann-La Roche AG Grenzacherstrasse 124, 4070 Basel, CH

- (51) MKP
B27N 3/00 2006 (97) EP 3672771
B27N 3/02 2006
B27N 3/04 2006
B32B 21/02 2006
B32B 21/04 2006
B32B 21/14 2006
C08L 97/02 2006
- (96) EP 18750231.5 8/13/2018
 (97) EP 3672771, 10/28/2020 202044, de
- (31) 17187501 (32) 23.08.2017 (33) EP
- (54) METHOD FOR PRODUCING LIGNOCELLULOSE MATERIALS IN THE PRESENCE OF CAPROLACTAM AND OLIGOMERS OF CAPROLACTAM
 (72) MUELLER, Christian, Carl-Bosch-Strasse 38, 67056 Ludwigshafen, DE
 LINDNER, Jean-Pierre Berkan, Carl-Bosch-Strasse 38, 67056 Ludwigshafen, DE
 WEINKOETZ, Stephan, Carl-Bosch-Strasse 38, 67056 Ludwigshafen, DE
 KRONIG, Sabrina, Elastogranstraße 60, 49448 Lemförde, DE

- (51) MKP
A61K 39/00 2006 (97) EP 3639851
A61K 39/12 2006
- (96) EP 19164313.9 3/15/2013
 (97) EP 3639851, 12/2/2020 202049, en
- (31) 201261696764 P (32) 04.09.2012 (33) US
 201261734875 P 07.12.2012 US
- (54) METHODS AND COMPOSITIONS FOR ENHANCING VACCINE IMMUNE RESPONSES
 (72) Lauterbach, Henning, Bavarian Nordic GmbH Meisenweg 22a, 85386 Eching, DE
 Hochrein, Hubertus, Bavarian Nordic GmbH Haffstrasse 134, 81825 Munich, DE

- (51) MKP
E05F 11/38 2006 (97) EP 3743579
E05F 11/48 2006
- (96) EP 18752435.0 7/31/2018
 (97) EP 3743579, 12/2/2020 202049, de
- (31) 102018200925 (32) 22.01.2018 (33) DE
- (54) DRIVER FOR A VEHICLE WINDOW REGULATOR, AND VEHICLE WINDOW REGULATOR
 (72) HAMPEL, Klaus, Nelkenweg 52, 96450 Coburg, DE
 SALM, Christian, An den Wachsbleichen 17g, 96052 Bamberg, DE
 TAUBMANN, Udo, Wiesengrund 19, 96476 Bad Rodach - Sülzfeld, DE
 WAGNER, Frank, Gaismannshofstrasse 27a, 90431 Nürnberg, DE

- (51) MKP
A61K 31/165 2006 (97) EP 3723744
A61K 31/18 2006
A61K 31/381 2006
A61K 31/40 2006

A61K 31/422 2006
A61K 31/427 2006
A61K 31/431 2006
A61K 31/4406 2006
A61K 31/445 2006
A61P 25/02 2006
 (96) EP 18825596.2 12/11/2018
 (97) EP 3723744, 10/21/2020 202043, en
 (31) 17206813 (32) 12.12.2017 (33) EP
 (54) C5AR INHIBITORS FOR USE IN THE TREATMENT OF CHEMOTHERAPY-INDUCED IATROGENIC PAIN
 (72) BRANDOLINI, Laura, c/o Dompé farmaceutici S.p.A. Via Campo Di Pile s.n.c., 67100 L'Aquila (AQ), IT
 CUNHA, Thiago, Mattar, Rua do Professor, 536 ap 24 Ribeirao Preto, 14020-280 Sao Paulo, BR
 ALLEGRETTI, Marcello, c/o Dompé farmaceutici S.p.A. Via Campo Di Pile s.n.c., 67100 L'Aquila (AQ), IT
 ARAMINI, Andrea, c/o Dompé Farmaceutici S.p.A. Via Campo Di Pile s.n.c., 67100 L'Aquila (AQ), IT
 BIANCHINI, Gianluca, c/o Dompé Farmaceutici S.p.A. Via Campo Di Pile s.n.c., 67100 L'Aquila (AQ), IT

(51) MKP
C12N 5/073 2010 (97) EP 3728566
C12N 5/0775 2010
 (96) EP 18825797.6 12/21/2018
 (97) EP 3728566, 10/28/2020 202044, en
 (31) PCT/IB2017/058366 (32) 22.12.2017 (33) WO
 (54) MESENCHYMAL STROMAL CELLS AND METHODS FOR OBTAINING MESENCHYMAL STROMAL CELLS FROM UMBILICAL CORD
 (72) ARDIGO', Diego, c/o Chiesi Farmaceutici S.p.A. Via Palermo 26/A, 43122 Parma, IT
 MILAZZO, Giovanni, c/o Chiesi Farmaceutici S.p.A. Via Palermo 26/A, 43122 Parma, IT
 DOMINICI, Massimo, c/o Chiesi Farmaceutici S.p.A. Via Palermo 26/A, 43122 Parma, IT
 MURGIA, Alba, c/o Chiesi Farmaceutici S.p.A. Via Palermo 26/A, 43122 Parma, IT

(51) MKP
A61K 38/17 2006 (97) EP 3716992
A61P 27/02 2006
 (96) EP 18825837.0 11/29/2018
 (97) EP 3716992, 10/7/2020 202041, en
 (31) 201762593033 P (32) 30.11.2017 (33) US
 201862644425 P 17.03.2018 US
 201862748782 P 22.10.2018 US
 (54) USE OF A VEGF ANTAGONIST TO TREAT ANGIOGENIC EYE DISORDERS
 (72) VITTI, Robert L., c/o Regeneron Pharmaceuticals Inc. 777 Old Saw Mill River Road, Tarrytown New York 10591, US
 BERLINER, Alyson J., c/o Regeneron Pharmaceuticals Inc. 777 Old Saw Mill River Road, Tarrytown New York 10591, US
 CHU, Karen, c/o Regeneron Pharmaceuticals Inc. 777 Old Saw Mill River Road, Tarrytown New York 10591, US

(51) MKP
A61P 27/02 2006 (97) EP 3714055
C12N 9/22 2006
C12N 15/113 2010
 (96) EP 18826103.6 11/21/2018
 (97) EP 3714055, 9/30/2020 202040, en
 (31) 201762589111 P (32) 21.11.2017 (33) US
 201862649133 P 28.03.2018 US
 201862693080 P 02.07.2018 US
 201862724319 P 29.08.2018 US
 (54) MATERIALS AND METHODS FOR TREATMENT OF AUTOSOMAL DOMINANT RETINITIS PIGMENTOSA
 (71) Bayer HealthCare LLC, 100 Bayer Boulevard, Whippany, NJ 07981, US
 (72) KANTARDZHIEVA, Albena, 610 Main Street North Building 5th Floor, Cambridge Massachusetts 02139, US
 NOMA, Akiko, 610 Main Street North Building 5th Floor, Cambridge Massachusetts 02139, US
 SCARIA, Abraham, 610 Main Street North Building 5th Floor, Cambridge Massachusetts 02139, US
 TAKEUCHI, Ryo, 610 Main Street North Building 5th Floor, Cambridge Massachusetts 02139, US

(51) MKP
A61K 31/437 2006 (97) EP 3720855
A61K 31/5377 2006
A61P 25/00 2006

A61P 25/24 2006
C07D 471/04 2006
 (96) EP 18826510.2 12/6/2018
 (97) EP 3720855, 10/14/2020 202042, en
 (31) 17206152 (32) 08.12.2017 (33) EP
 (54) IMIDAZOPYRIDINE DERIVATIVES AND THE USE THEREOF AS MEDICAMENT
 (72) GIOVANNINI, Riccardo, Boehringer Ingelheim International GmbH Corporate Patents Binger Strasse 173, 55216 Ingelheim am Rhein, DE
 CECI, Angelo, Boehringer Ingelheim International GmbH Corporate Patents Binger Strasse 173, 55216 Ingelheim am Rhein, DE
 DAHMANN, Georg, Boehringer Ingelheim International GmbH Corporate Patents Binger Strasse 173, 55216 Ingelheim am Rhein, DE
 DORNER-CIOSSEK, Cornelia, Boehringer Ingelheim International GmbH Corporate Patents Binger Strasse 173, 55216 Ingelheim am Rhein, DE
 KUSSMAUL, Lothar, Boehringer Ingelheim International GmbH Corporate Patents Binger Strasse 173, 55216 Ingelheim am Rhein, DE
 PFAU, Roland, Boehringer Ingelheim International GmbH Corporate Patents Binger Strasse 173, 55216 Ingelheim am Rhein, DE
 WIEDENMAYER, Dieter, Boehringer Ingelheim International GmbH Corporate Patents Binger Strasse 173, 55216 Ingelheim am Rhein, DE

(51) MKP
A61P 13/12 2006 (97) EP 3717510
C07K 16/08 2006
 (96) EP 18826811.4 11/28/2018
 (97) EP 3717510, 10/7/2020 202041, en
 (31) 201762593566 P (32) 01.12.2017 (33) US
 201862727168 P 05.09.2018 US
 (54) POLYOMAVIRUS NEUTRALIZING ANTIBODIES
 (72) ABEND, Johanna, c/o Novartis Institutes for BioMedical Research Inc. 5300 Chiron Way, Emeryville, California 94608, US
 CORNACCHIONE, Vanessa, c/o Novartis Pharma AG Postfach, 4002 Basel, CH
 LINDNER, John Michael, c/o Novartis Pharma AG Postfach, Basel 4002, CK
 TRAGGIAI, Elisabetta, c/o Novartis Pharma AG Postfach, 4002 Basel, CH

(51) MKP
A61M 5/20 2006 (97) EP 3723827
A61M 5/315 2006
A61M 5/32 2006
 (96) EP 18826881.7 12/6/2018
 (97) EP 3723827, 10/21/2020 202043, en
 (31) 201762599029 P (32) 15.12.2017 (33) US
 (54) MEDICATION DELIVERY DEVICE WITH SYRINGE SENSING SYSTEM
 (72) LOUGHNANE, Christopher Paul, c/o Eli Lilly and Company P.O. Box 6288, Indianapolis, Indiana 46206-6288, US
 ROHATGI, Gaurav, c/o Eli Lilly and Company P.O. Box 6288, Indianapolis, Indiana 46206-6288, US
 SNYDER, Stephen Louis, c/o Eli Lilly and Company P.O. Box 6288, Indianapolis, Indiana 46206-6288, US

(51) MKP
A61K 38/19 2006 (97) EP 3720469
A61P 7/04 2006
 (96) EP 18826885.8 12/6/2018
 (97) EP 3720469, 10/14/2020 202042, en
 (31) 201762596020 P (32) 07.12.2017 (33) US
 (54) METHOD OF TREATING IDIOPATHIC THROMBOCYTOPENIA PURPURA (ITP) WITH ROMIPLOSTIM
 (72) TARANTINO, Michael, 2 Old Farm Lane, Washington IL 61571, US
 BUSSEL, James, 115 East 67th Street 9B, New York City NY 10065, US
 EISEN, Melissa, 969 Alexandra Court, Oak Park CA 91377, US
 CARPENTER, Nancy, 44 Willow Drive, Carterton Oxfordshire OX18 1JU, GB
 WANG, Xuena, 4516 Red Spruce Lane, Manlius NY 13104, US
 MAC, Susanna, 30608 Rainbow View Drive, Agoura Hills CA 91301, US

(51) MKP
A61K 31/497 2006 (97) EP 3724176
A61P 25/30 2006
C07D 401/12 2006
 (96) EP 18826892.4 12/7/2018
 (97) EP 3724176, 10/21/2020 202043, en
 (31) 201762597236 P (32) 11.12.2017 (33) US
 (54) FUMARATE SALT OF (R)-3-(1-(2,3-DICHLORO-4-(PYRAZIN-2-YL)PHENYL)-2,2,2-TRIFLUOROETHYL)-1-METHYL-1-(1-METHYLPIPERIDIN-4-YL) UREA, METHODS OF PREPARATION, AND USES THEREOF

(72) GARCIA RUBIO, Silvina, 7 Bellflower Ct., 08540 Princeton, New Jersey, US
 PERSEGHINI, Mauro, Via Industria 5, 6710, 6710 Biasca, CH
 GUAINAZZI, Angelo, 52 West 120th St. Apt. 3., 10027 New York, NY, US
 PIETRA, Claudio, Via G. Scalabrini No., 22100 Como, IT
 GIULIANO, Claudio, Via Prudenziara No. 28/A, 22100 Como, IT

(51) MKP
A61K 31/137 2006 (97) EP 3720880
A61K 31/225 2006
A61K 31/277 2006
A61P 25/00 2006
C07K 16/28 2006

(96) EP 18826972.4 12/5/2018

(97) EP 3720880, 10/14/2020 202042, en

(31) 17461640 (32) 05.12.2017 (33) EP

(54) COMBINATION THERAPY OF MULTIPLE SCLEROSIS COMPRISING A CD20 LIGAND

(71) Mabion SA, ul. gen. Mariana Langiewiczza 60, 95-050 Konstanynow Lodzki, PL

(72) WIECZOREK, Maciej, Ogrodowa 2a, 05-092 Lomianki, PL

JAROS, Slawomir, Patriotyczna 17d, 93-452 Łódź, PL

JAROS, Dorota, Patriotyczna 17d, 93-452 Łódź, PL

BALCEREK, Julita, Grota-Roweckiego 14/24, 93-217 Łódź, PL

(51) MKP
A01G 13/06 2006 (97) EP 3723480
A01M 21/04 2006

(96) EP 18827018.5 12/14/2018

(97) EP 3723480, 10/21/2020 202043, en

(31) 201705944 (32) 15.12.2017 (33) BE
 201805704 15.10.2018 BE

(54) A METHOD AND APPARATUS FOR CONTROLLING VEGETATION BY MEANS OF A HEATED GAS

(71) AGROFROST, naamloze vennootschap, Kunstlaan 56, 1000 Brussel, BE

(72) POLLEUNIS, Marc, Guy, Krawatenstraat 85a, 3470 Kortenaeken, BE

(51) MKP
G01N 33/50 2006 (97) EP 3729100
G01N 33/74 2006

(96) EP 18827044.1 12/18/2018

(97) EP 3729100, 10/28/2020 202044, en

(31) 201762607866 P (32) 19.12.2017 (33) US
 201762609059 P 21.12.2017 US

(54) METHOD OF ASSESSING GROWTH HORMONE DEFICIENCY IN HUMANS BY A MACIMORELIN CONTAINING COMPOSITION

(71) Aeterna Zentaris GmbH, Weismüllerstrasse 50, 60314 Frankfurt, DE

(72) AMMER, Nicola, Auf der Kuhr 52, 60435 Frankfurt am Main, DE

MUELLER, Gilbert, Bischofsweg 1 A, 60598 Frankfurt am Main, DE

SACHSE, Richard, Klingenaecker 8, 88441 Mittelbiberach, DE

SINDERMANN, Herbert, Reiherweg 9, 26529 Uppgant-Schott, DE

(51) MKP
A61P 37/06 2006 (97) EP 3720877
C07K 16/00 2006

(96) EP 18829228.8 12/7/2018

(97) EP 3720877, 10/14/2020 202042, en

(31) 201762596562 P (32) 08.12.2017 (33) US

(54) USE OF FCN ANTAGONISTS FOR TREATMENT OF GENERALIZED MYASTHENIA GRAVIS

(71) Argenx BVBA, Industriepark 7, 9052 Zwijnaarde, BE

(72) DE HAARD, Johannes, c/o ARGENX BVBA Industriepark 7, 9052 Zwijnaarde, BE

DREIER, Torsten, c/o ARGENX BVBA Industriepark 7, 9052 Zwijnaarde, BE

ULRICHTS, Peter, c/o ARGENX BVBA Industriepark 7, 9052 Zwijnaarde, BE

GUGLIETTA, Antonio, c/o ARGENX BVBA Industriepark 7, 9052 Zwijnaarde, BE

LEUPIN, Nicolas, c/o ARGENX BVBA Industriepark 7, 9052 Zwijnaarde, BE

(51) MKP

	A61K 31/40	2006	(97) EP 3724182				
	A61P 37/00	2006					
	C07D 207/36	2006					
	C07D 403/12	2006					
(96)	EP 18829230.4 12/7/2018						
(97)	EP 3724182, 10/21/2020 202043, en						
(31)	17380025		(32)	11.12.2017		(33)	EP
(54)	PYRROLE DERIVATIVES AS ACC INHIBITORS						
(72)	BACH TAÑA, Jordi, C/ Laureà Miró, 408-410 Sant Feliu de, 08980 Barcelona, ES						
	ESTEVE TRIAS, Cristina, C/ Laureà Miró 408-410 Sant Feliu de Llobregat, 08980 Barcelona, ES						
	MIR CEPEDA, Marta, C/ Laureà Miró 408-410 Sant Feliu de Llobregat, 08980 Barcelona, ES						
<hr/>							
(51)	MKP						
	A61K 31/437	2006	(97) EP 3728246				
	A61P 9/00	2006					
	A61P 11/00	2006					
	C07D 471/04	2006					
(96)	EP 18829253.6 12/12/2018						
(97)	EP 3728246, 10/28/2020 202044, en						
(31)	17208186		(32)	18.12.2017		(33)	EP
(54)	META TYROSINE DERIVATIVES AS RHO-KINASE INHIBITORS						
(72)	ACCETTA, Alessandro, c/o CHIESI FARMACEUTICI S.p.A. Via Palermo, 26/A, 43122 PARMA, IT						
	RANCATI, Fabio, c/o CHIESI FARMACEUTICI S.p.A. Via Palermo, 26/A, 43122 PARMA, IT						
	EDWARDS, Christine, c/o CHIESI FARMACEUTICI S.p.A. Via Palermo, 26/A, 43122 PARMA, IT						
	BHALAY, Gurdip, c/o CHIESI FARMACEUTICI S.p.A. Via Palermo, 26/A, 43122 PARMA, IT						
	TISSELLI, Patrizia, c/o CHIESI FARMACEUTICI S.p.A. Via Palermo, 26/A, 43122 PARMA, IT						
<hr/>							
(51)	MKP						
	A61K 31/437	2006	(97) EP 3728247				
	A61P 9/00	2006					
	A61P 11/00	2006					
	C07D 471/04	2006					
(96)	EP 18829255.1 12/12/2018						
(97)	EP 3728247, 10/28/2020 202044, en						
(31)	17208187		(32)	18.12.2017		(33)	EP
(54)	OXADIAZOLE DERIVATIVES AS RHO-KINASE INHIBITORS						
(72)	ACCETTA, Alessandro, c/o CHIESI FARMACEUTICI S.p.A. Via Palermo, 26/A, 43122 PARMA, IT						
	RANCATI, Fabio, c/o CHIESI FARMACEUTICI S.p.A. Via Palermo, 26/A, 43122 PARMA, IT						
	EDWARDS, Christine, c/o CHIESI FARMACEUTICI S.p.A. Via Palermo, 26/A, 43122 PARMA, IT						
	SKIDMORE, Elizabeth Anne, c/o CHIESI FARMACEUTICI S.p.A. Via Palermo, 26/A, 43122 PARMA, IT						
<hr/>							
(51)	MKP						
	A61K 31/541	2006	(97) EP 3728248				
	A61P 11/00	2006					
	C07D 471/04	2006					
	C07D 487/04	2006					
	C07D 519/00	2006					
(96)	EP 18829278.3 12/14/2018						
(97)	EP 3728248, 10/28/2020 202044, en						
(31)	17208193		(32)	18.12.2017		(33)	EP
(54)	AZAINDOLE DERIVATIVES AS RHO-KINASE INHIBITORS						
(72)	ACCETTA, Alessandro, c/o CHIESI FARMACEUTICI S.p.A. Via Palermo, 26/A, 43122 Parma, IT						
	RANCATI, Fabio, c/o CHIESI FARMACEUTICI S.p.A. Via Palermo, 26/A, 43122 Parma, IT						
	EDWARDS, Christine, c/o CHIESI FARMACEUTICI S.p.A. Via Palermo, 26/A, 43122 Parma, IT						
	NUZZI, Andrea, c/o CHIESI FARMACEUTICI S.p.A. Via Palermo, 26/A, 43122 Parma, IT						
<hr/>							
(51)	MKP						
	A61M 31/00	2006	(97) EP 3720537				
(96)	EP 18829486.2 12/3/2018						
(97)	EP 3720537, 10/14/2020 202042, en						
(31)	201762594257 P		(32)	04.12.2017		(33)	US
	201862681525 P			06.06.2018			US
(54)	LONG ACTING GASTRIC RESIDENCE SYSTEM						

(72) MENACHEM, Avshalom Ben, 5 Basel Street P.O. Box 3190, 49131 Petach Tikva, IL
 ZALIT, Ilan, 5 Basel Street P.O. Box 3190, 49131 Petach Tikva, IL

(51) MKP
B65D 33/25 2006 (97) EP 3717369

(96) EP 18829547.1 11/28/2018

(97) EP 3717369, 10/7/2020 202041, en

(31) 201715826079 (32) 29.11.2017 (33) US

(54) CHILD RESISTANT SLIDER, ZIPPER CLOSURE SYSTEM USING SLIDER, AND METHODS OF USE

(71) Reynolds Presto Products Inc., 1900 West Field Court, Lake Forest, IL 60045, US

(72) THOMPSON, Gregg, 4993 State Route 64, Canandaigua NY 14424, US

ATHANS, John, 7300 Silver Hill Path, Victor NY 14564, US

(51) MKP
A61K 38/46 2006 (97) EP 3720473

C12N 9/22 2006

C12N 15/10 2006

C12N 15/113 2010

(96) EP 18829588.5 12/5/2018

(97) EP 3720473, 10/14/2020 202042, en

(31) 201762594689 P (32) 05.12.2017 (33) US

201862664023 P 27.04.2018 US

201862671770 P 15.05.2018 US

201862734543 P 21.09.2018 US

201862734431 P 21.09.2018 US

(54) CRISPR-CAS9 MODIFIED CD34+ HUMAN HEMATOPOIETIC STEM AND PROGENITOR CELLS AND USES THEREOF

(72) MORAWA, Ewelina, c/o Crispr Therapeutics AG 610 Main Street, Cambridge MA 02139, US

CHAKRABORTY, Tirtha, c/o Crispr Therapeutics AG 610 Main Street, Cambridge MA 02139, US

LUNDBERG, Ante, Sven, c/o Crispr Therapeutics AG 610 Main Street, Cambridge MA 02139, US

HO, Tony, c/o Crispr Therapeutics AG 610 Main Street, Cambridge MA 02139, US

SANDLER, Laura, c/o Crispr Therapeutics AG 610 Main Street, Cambridge MA 02139, US

EUSTACE, Brenda, c/o Vertex Pharmaceuticals Incorporated 50 Northern Avenue, Boston MA 02210, US

ROSSERT, Jerome, c/o Verlex Pharmaceuticals Incorporated 50 Northern Avenue, Boston MA 02210, US

KAUFFMAN, Robert, c/o Vertex Pharmaceuticals Incorporated 50 Northern Avenue, Boston MA 02210, US

(51) MKP
A61K 31/51 2006 (97) EP 3720859

A61P 25/00 2006

C07D 495/14 2006

(96) EP 18829589.3 12/5/2018

(97) EP 3720859, 10/14/2020 202042, en

(31) 201762594753 P (32) 05.12.2017 (33) US

(54) POSITIVE ALLOSTERIC MODULATORS OF THE MUSCARINIC ACETYLCHOLINE RECEPTOR M4

(72) LINDSLEY, Craig, W., 9281 Wardley Park Lane, Brentwood TN 37027, US

CONN, P., Jeffrey, 2806 Acklen Avenue, Nashville TN 37212, US

ENGERS, Darren, W., 1744 Stillwater Circle, Brentwood TN 37027, US

ENGERS, Julie, L., 1744 Stillwater Circle, Brentwood TN 37027, US

(51) MKP
A61K 31/519 2006 (97) EP 3720860

A61P 25/00 2006

C07D 495/14 2006

(96) EP 18829590.1 12/5/2018

(97) EP 3720860, 10/14/2020 202042, en

(31) 201762594849 P (32) 05.12.2017 (33) US

(54) POSITIVE ALLOSTERIC MODULATORS OF THE MUSCARINIC ACETYLCHOLINE RECEPTOR M4

(72) LINDSLEY, Craig, W., 9281 Wardley Park Lane, Brentwood TN 37027, US

CONN, P., Jeffrey, 2806 Acklen Avenue, Nashville TN 37212, US

ENGERS, Darren, W., 1744 Stillwater Circle, Brentwood TN 37027, US

ENGERS, Julie, L., 1744 Stillwater Circle, Brentwood TN 37027, US

(51) MKP

C07D 231/20 2006 (97) EP 3720849
C07D 401/04 2006
C07D 401/14 2006
C07D 405/04 2006
 (96) EP 18829637.0 12/7/2018
 (97) EP 3720849, 10/14/2020 202042, en
 (31) 201762596452 P (32) 08.12.2017 (33) US
 201862623725 P 30.01.2018 US
 201862649970 P 29.03.2018 US
 (54) PROCESSES FOR MAKING MODULATORS OF CYSTIC FIBROSIS TRANSMEMBRANE CONDUCTANCE REGULATOR
 (72) ANGELL, Paul T., 50 Northern Avenue, Boston, Massachusetts 02210, US
 HARRISON, Cristian, 50 Northern Avenue, Boston, Massachusetts 02210, US
 HUGHES, Robert M., 9435 Sawtooth Way, San Diego, California 92129, US
 LEWANDOWSKI, Berenice, 50 Northern Avenue, Boston, Massachusetts 02210, US
 LITTLER, Benjamin J., 50 Northern Avenue, Boston, Massachusetts 02210, US
 MELILLO, Vito, 50 Northern Avenue, Boston, Massachusetts 02210, US
 NUGENT, William A., 5065 Montview Way, Noblesville, Indiana 46062, US
 SIESEL, David Andrew, 50 Northern Avenue, Boston, Massachusetts 02210, US
 SMITH, David, 50 Northern Avenue, Boston, Massachusetts 02210, US
 STUDLEY, John, 71 Well Lane Curbridge, Witney Oxfordshire OX29 7PB, GB

(51) MKP
C12N 5/0783 2010 (97) EP 3720949
 (96) EP 18829646.1 12/7/2018
 (97) EP 3720949, 10/14/2020 202042, en
 (31) 201762596766 P (32) 08.12.2017 (33) US
 (54) SERUM-FREE MEDIA FORMULATION FOR CULTURING CELLS AND METHODS OF USE THEREOF
 (72) BEAUCHESNE, Pascal, 400 Dexter Ave. N Suite 1200, Seattle Washington 98109, US
 CHAN, Calvin, 400 Dexter Ave. N Suite 1200, Seattler, Washington 98109, US
 AIFUWA, Ivie, 400 Dexter Ave. N Suite 1200, Seattle, Washington 98109, US
 KHUU-DUONG, Kien, 400 Dexter Ave. N Suite 1200, Seattle, Washington 98109, US

(51) MKP
A61K 39/00 2006 (97) EP 3724228
A61K 39/395 2006
A61P 25/16 2006
A61P 25/28 2006
C07K 16/28 2006
 (96) EP 18829766.7 12/13/2018
 (97) EP 3724228, 10/21/2020 202043, en
 (31) 201720970 (32) 15.12.2017 (33) GB
 (54) ANTI-ALPHA SYNUCLEIN ANTIBODIES
 (72) DOWNEY, Patrick, c/o IP Department UCB Biopharma SPRL 60, Allée de la Recherche, 1070 Brussels, BE
 TYSON, Kerry Louise, c/o IPD UCB Celltech 208 Bath Road, Slough, Berkshire SL1 3WE, GB
 KRIEK, Marco, c/o IPD UCB Celltech 208 Bath Road, Slough Berkshire SL1 3WE, GB
 DE LICHTERVELDE, Lorenzo, c/o IP Department UCB Biopharma SPRL 60 Allée de la Recherche, 1070 Brussels, BE
 LIGHTWOOD, Daniel John, c/o IPD UCB Celltech 208 Bath Road, Slough, Berkshire SL1 3WE, GB
 MCMILLAN, David James, c/o IPD UCB Celltech 208 Bath Road, Slough, Berkshire SL1 3WE, GB
 ELLIOTT, Peter Charles, c/o IPD UCB Celltech 208 Bath Road, Slough, Berkshire SL1 3WE, GB
 BAKER, Terence Seward, c/o IPD UCB Celltech 208 Bath Road, Slough, Berkshire SL1 3WE, GB

(51) MKP
C07K 16/18 2006 (97) EP 3724224
 (96) EP 18829767.5 12/13/2018
 (97) EP 3724224, 10/21/2020 202043, en
 (31) 201720975 (32) 15.12.2017 (33) GB
 (54) ANTI-ALPHA-SYNUCLEIN ANTIBODIES
 (72) ADAMS, Ralph, c/o IPD UCB Celltech 208 Bath Road, Slough, Berkshire SL1 3WE, GB
 DOWNEY, Patrick, c/o IP Department UCB Biopharma SPRL 60, Allée de la Recherche, 1070 Brussels, BE
 BAKER, Terence Seward, c/o IPD UCB Celltech 208 Bath Road, Slough, Berkshire SL1 3WE, GB
 TYSON, Kerry Louise, c/o IPD UCB Celltech 208 Bath Road, Slough, Berkshire SL1 3WE, GB
 DE LICHTERVELDE, Lorenzo, c/o IP Department UCB Biopharma SPRL 60, Allée de la Recherche, 1070 Brussels, BE

LIGHTWOOD, Daniel John, c/o IPD UCB Celltech 208 Bath Road, Slough, Berkshire SL1 3WE, GB
 MCMILLAN, David James, c/o IPD UCB Celltech 208 Bath Road, Slough, Berkshire SL1 3WE, GB

- (51) MKP
A61K 39/395 2006 (97) EP 3728313
A61K 45/06 2006
A61P 35/00 2006
C07K 16/28 2006
- (96) EP 18829861.6 12/21/2018
 (97) EP 3728313, 10/28/2020 202044, en
- (31) PCT/IB2017/001595 (32) 21.12.2017 (33) WO
- (54) COMBINATION ANTI CANCER THERAPY WITH AN IAP ANTAGONIST AND AN ANTI PD-1 MOLECULE
 (72) VUAGNIAUX, Grégoire, Rue Orient-Ville 8, 1005 Lausanne, CH
 WIEDEMANN, Norbert, Avenue Fantaisie 6, 1006 Lausanne, CH
 GAVILLET, Bruno, 430 route de Pitegny, 01220 Grilly, FR
 SZYLDERGEMAJN ALTMAN, Sergio Adrian, Chemin des Hirondelles 10, 1162 Saint Prex, CH

- (51) MKP
A61K 38/17 2006 (97) EP 3720478
A61K 39/00 2006
C07K 14/47 2006
C07K 14/725 2006
- (96) EP 18830062.8 12/3/2018
 (97) EP 3720478, 10/14/2020 202042, en
- (31) 201762594244 P (32) 04.12.2017 (33) US
- (54) HLA CLASS I-RESTRICTED T CELL RECEPTORS AGAINST MUTATED RAS
 (71) The United States of America, as represented by the Secretary, Department of Health and Human Services, The Office of Technology Transfer National Institutes of Health 6011 Executive Boulevard Suite 325, MSC 7660, Bethesda, MD 20892-7660, US
 (72) YOSEPH, Rami, 14 Landsend Drive, Gaithersburg, Maryland 20878, US
 LU, Yong-Chen, 1620 East Jefferson Apt 111, Rockville, Maryland 20852, US
 CAFRI, Gal, Haasi 1 Kibbuutz Nir David, Nir David 1080300, IL
 ROSENBERG, Steven A., 10104 Iron Gate Road, Potomac, Maryland 20854, US

- (51) MKP
A61K 35/17 2015 (97) EP 3720874
C07K 14/725 2006
C12N 5/0783 2010
- (96) EP 18830101.4 12/7/2018
 (97) EP 3720874, 10/14/2020 202042, en
- (31) 201762596774 P (32) 08.12.2017 (33) US
 201862614965 P 08.01.2018 US
 201862716971 P 09.08.2018 US
 201862721604 P 22.08.2018 US
 201862740903 P 03.10.2018 US
 201862754564 P 01.11.2018 US
 201862774165 P 30.11.2018 US
 201862774855 P 03.12.2018 US
- (54) PROCESS FOR PRODUCING A COMPOSITION OF ENGINEERED T CELLS
 (72) MUJACIC, Mirna, 400 Dexter Ave. N Suite 1200, Seattle Washington 98109, US
 RAHARDJO, Ayu, 400 Dexter Ave. N Suite 1200, Seattle Washington 98109, US
 BEAUCHESNE, Pascal, 400 Dexter Ave. N Suite 1200, Seattle Washington 98109, US
 CHAN, Calvin, 400 Dexter Ave. N Suite 1200, Seattle, Washington 98109, US
 KHUU-DUONG, Kien, 400 Dexter Ave. N Suite 1200, Seattle, Washington 98109, US
 AIFUWA, Ivie, 400 Dexter Ave. N Suite 1200, Seattle, Washington 98109, US

- (51) MKP
A61K 31/437 2006 (97) EP 3723807
A61K 31/444 2006
A61K 31/497 2006
A61K 31/506 2006
A61K 45/06 2006
A61P 25/00 2006
A61P 25/18 2006

A61P 25/22 2006
A61P 25/24 2006
A61P 25/28 2006
(96) EP 18830163.4 12/12/2018
(97) EP 3723807, 10/21/2020 202043, en
(31) PA201700708 (32) 14.12.2017 (33) DK
(54) COMBINATION TREATMENTS COMPRISING ADMINISTRATION OF 1H-PYRAZOLO[4,3-B]PYRIDINES
(72) KEHLER, Jan, c/o H. Lundbeck A/S Ottiliavej 9, 2500 Valby, DK
JUHL, Karsten, c/o H. Lundbeck A/S Ottiliavej 9, 2500 Valby, DK
MARIGO, Mauro, c/o H. Lundbeck A/S Ottiliavej 9, 2500 Valby, DK
VITAL, Paulo, Jorge, Vieira, c/o H. Lundbeck A/S Ottiliavej 9, 2500 Valby, DK
JESSING, Mikkel, c/o H. Lundbeck A/S Ottiliavej 9, 2500 Valby, DK
LANGGÅRD, Morten, c/o H. Lundbeck A/S Ottiliavej 9, 2500 Valby, DK
RASMUSSEN, Lars, Kyhn, c/o H. Lundbeck A/S Ottiliavej 9, 2500 Valby, DK
CLEMENTSON, Carl, Martin, Sebastian, c/o H. Lundbeck A/S Ottiliavej 9, 2500 Valby, DK

(51) MKP
A61K 31/437 2006 (97) EP 3723808
A61K 31/444 2006
A61K 31/497 2006
A61K 31/506 2006
A61K 45/06 2006
A61P 25/00 2006
A61P 25/18 2006
A61P 25/22 2006
A61P 25/24 2006
A61P 25/28 2006
(96) EP 18830165.9 12/12/2018
(97) EP 3723808, 10/21/2020 202043, en
(31) PA201700711 (32) 14.12.2017 (33) DK
(54) COMBINATION TREATMENTS COMPRISING ADMINISTRATION OF 1H-PYRAZOLO[4,3-B]PYRIDINES
(72) KEHLER, Jan, c/o H. Lundbeck A/S Ottiliavej 9, 2500 Valby, DK
JUHL, Karsten, c/o H. Lundbeck A/S Ottiliavej 9, 2500 Valby, DK
MARIGO, Mauro, c/o H. Lundbeck A/S Ottiliavej 9, 2500 Valby, DK
VITAL, Paulo, Jorge, Vieira, c/o H. Lundbeck A/S Ottiliavej 9, 2500 Valby, DK
JESSING, Mikkel, c/o H. Lundbeck A/S Ottiliavej 9, 2500 Valby, DK
LANGGÅRD, Morten, c/o H. Lundbeck A/S Ottiliavej 9, 2500 Valby, DK
RASMUSSEN, Lars, Kyhn, c/o H. Lundbeck A/S Ottiliavej 9, 2500 Valby, DK
CLEMENTSON, Carl, Martin, Sebastian, c/o H. Lundbeck A/S Ottiliavej 9, 2500 Valby, DK

(51) MKP
A61K 39/395 2006 (97) EP 3723800
A61P 21/00 2006
A61P 37/00 2006
C07K 16/28 2006
(96) EP 18830196.4 12/14/2018
(97) EP 3723800, 10/21/2020 202043, en
(31) 17306783 (32) 15.12.2017 (33) EP
(54) TREATMENT OF MONOGENIC DISEASES WITH AN ANTI-CD45RC ANTIBODY
(71) Centre Hospitalier Universitaire De Nantes, 5 Allée de l'Île Gloriette, 44093 Nantes Cedex 1, FR
Université de Nantes, 1 quai de Tourville, 44000 Nantes, FR
(72) GUILLONNEAU, Carole, 22 rue du Marais, 44118 La Chevrolière, FR
ANEGON, Ignacio, 2A rue du Maine, 44000 Nantes, FR

(51) MKP
A61K 9/16 2006 (97) EP 3727341
A61K 9/20 2006
A61K 9/28 2006
A61K 31/155 2006
A61K 31/702 2006
A61K 45/06 2006
(96) EP 18830227.7 12/18/2018
(97) EP 3727341, 10/28/2020 202044, en
(31) 17208069 (32) 18.12.2017 (33) EP

(54) FIXED DOSE COMBINATION TABLET FORMULATION OF ACARBOSE AND METFORMIN AND PROCESS FOR PRODUCING THE SAME
 (72) ANLAHR, Johanna, Vinckestr. 5, 44139 Dortmund, DE

(51) MKP
A61K 8/99 2017 (97) EP 3720457
A61K 35/74 2015
A61P 17/00 2006
A61Q 19/00 2006
 (96) EP 18830307.7 12/6/2018
 (97) EP 3720457, 10/14/2020 202042, en
 (31) 201700141330 (32) 06.12.2017 (33) IT
 (54) COMPOSITION BASED ON PROBIOTICS AND USES THEREOF
 (71) LAC2BIOME S.R.L., Via Ceresio 7, 20154 Milano, IT
 (72) BIFFI, Andrea, Via Mulino Vecchio 146, 24059 Urgnano (Bergamo), IT

(51) MKP
C12N 5/0783 2010 (97) EP 3717634
 (96) EP 18830327.5 11/26/2018
 (97) EP 3717634, 10/7/2020 202041, en
 (31) 201762591041 P (32) 27.11.2017 (33) US
 102017127984 27.11.2017 DE
 (54) METHODS FOR ACTIVATING, MODIFYING AND EXPANDING GAMMA DELTA T CELLS FOR THE TREATMENT OF CANCER AND RELATED MALIGNANCIES
 (71) Immatics US, Inc., 2130 W. Holcombe Blvd. Suite 900, Houston, TX 77030, US
 (72) DAO, Monique, 1107 Second Venue Apt no. 407, Redwood City, California 94063, US
 MATA, Melinda, 10426 Caribou Court, Missouri City, Texas 77459, US
 NOWICKA, Aleksandra, 2255 Braeswood Park Drive, Houston, Texas 77030, US
 BULLIARD, Yannick, 1522 Alderwood Drive, Sugarland, Texas 77479, US
 WALTER, Steffen, 2901 Wroxtton Road, Houston TX 77005, US
 MISSEL, Sarah, Französische Allee 13, Tübingen 72072, DE
 KUTTRUFF-COQUI, Sabrina, Torstraße 2-6, Filderstadt-Sielmingen, DE
 HILF, Norbert, Im Wengertacker 17, Kirchentellinsfurt, DE

(51) MKP
A61K 39/00 2006 (97) EP 3723797
A61K 39/12 2006
A61P 31/20 2006
 (96) EP 18830429.9 12/14/2018
 (97) EP 3723797, 10/21/2020 202043, en
 (31) 201721069 (32) 15.12.2017 (33) GB
 (54) HEPATITIS B IMMUNISATION REGIMEN AND COMPOSITIONS
 (72) AMMENDOLA, Virginia, ReiThera Srl Via di Castel Romano 100, 00128 Rome, IT
 BAYAT, Babak, GlaxoSmithKline Biologicals SA rue de l'Institut 89, 1330 Rixensart, BE
 LORIN, Clarisse, GlaxoSmithKline Biologicals SA rue de l'Institut 89, 1330 Rixensart, BE
 VASSILEV, Ventsislav Bojidarov, GlaxoSmithKline rue de l'Institut 89, 1330 Rixensart, BE
 VITELLI, Alessandra, ReiThera Srl Via di Castel Romano 100, 00128 Rome, IT

(51) MKP
F25B 19/00 2006 (97) EP 3749903
F25B 25/00 2006
F25D 3/10 2006
H02G 15/34 2006
 (96) EP 18830476.0 12/20/2018
 (97) EP 3749903, 12/16/2020 202051, de
 (31) 102018001040 (32) 08.02.2018 (33) DE
 (54) METHOD AND DEVICE FOR COOLING A SUPERCONDUCTING CURRENT CARRIER
 (72) HERZOG, Friedhelm, Josef-Brocker-Dyk 129, 47803 Krefeld, DE
 KUTZ, Thomas, Tippheideweg 11, 41379 Brüggen-Born, DE

(51) MKP
A01N 43/80 2006 (97) EP 3717461
A61K 31/42 2006

	A61P 33/00	2006					
	C07D 261/08	2006					
(96)	EP 18830523.9 11/29/2018						
(97)	EP 3717461, 10/7/2020 202041, en						
(31)	201711042933		(32)	30.11.2017		(33)	IN
(54)	A NOVEL ISOXAZOLE COMPOUND OR A SALT THEREOF						
(71)	OAT Agrio Co., Ltd., 1-3-1, Kanda Ogawa-Machi Chiyoda-ku, Tokyo 101-0052, JP						
(72)	VENUVENKA, Srinivas, E-423 RIICO Industrial Area Chopanki Bhiwadi Dist. Alwar, Rajasthan 301707, IN						
	SINGH, Rajesh Kumar, E-423 RIICO Industrial Area Chopanki Bhiwadi Dist. Alwar, Rajasthan 301707, IN						
	SHARMA, Ritesh, E-423 RIICO Industrial Area Chopanki Bhiwadi Dist. Alwar, Rajasthan 301707, IN						
	SWAMI, Pitamber, E-423 RIICO Industrial Area Chopanki Bhiwadi Dist. Alwar, Rajasthan 301707, IN						
	SINGH, Braj Bhushan, E-423 RIICO Industrial Area Chopanki Bhiwadi Dist. Alwar, Rajasthan 301707, IN						
	YADAV, Manish Kumar, E-423 RIICO Industrial Area Chopanki Bhiwadi Dist. Alwar, Rajasthan 301707, IN						
	KUMAWAT, Surendra, E-423 RIICO Industrial Area Chopanki Bhiwadi Dist. Alwar, Rajasthan 301707, IN						
	SINGH, Manish K, E-423 RIICO Industrial Area Chopanki Bhiwadi Dist. Alwar, Rajasthan 301707, IN						
<hr/>							
(51)	MKP						
	C07K 14/435	2006	(97)	EP 3720875			
	C07K 14/78	2006					
	C12N 15/82	2006					
(96)	EP 18830562.7 12/5/2018						
(97)	EP 3720875, 10/14/2020 202042, en						
(31)	201762595725 P		(32)	07.12.2017		(33)	US
(54)	ANTIMICROBIAL PEPTIDES AND METHODS OF USING SAME						
(72)	KUHNN, Michael, C/o Zoetis Services Llc 333 Portage Street, Kalamazoo MI 49007, US						
	EWIN, Richard, Andrew, C/o Zoetis Services Llc 333 Portage Street, Kalamazoo MI 49007, US						
	SHEEHAN, Derek, James, C/o Zoetis Services Llc 333 Portage Street, Kalamazoo MI 49007, US						
	BAIMA, Eric, C/o Zoetis Services Llc 333 Portage Street, Kalamazoo MI 49007, US						
	ZOOK, Christopher, A., C/o Zoetis Services Llc 333 Portage Street, Kalamazoo MI 49007, US						
	PHELPS, Hilary, C/o Zoetis Services Llc 333 Portage Street, Kalamazoo MI 49007, US						
<hr/>							
(51)	MKP						
	A61K 31/58	2006	(97)	EP 3720867			
	A61P 25/24	2006					
	C07J 1/00	2006					
	C07J 7/00	2006					
	C07J 13/00	2006					
	C07J 43/00	2006					
(96)	EP 18830574.2 12/7/2018						
(97)	EP 3720867, 10/14/2020 202042, en						
(31)	201762596725 P		(32)	08.12.2017		(33)	US
	201862731539 P			14.09.2018			US
(54)	DEUTERATED 21 -[4-CYANO-PYRAZOL-1 -YL]-19-NOR-PREGAN-3. ALPHA-OL-20-ONE DERIVATIVES FOR TREATING CNS DISORDERS						
(72)	SALITURO, Francesco, G., 25 Baker Drive, Marlborough MA 01752, US						
	ROBICHAUD, Albert, Jean, 1 Franklin St. Unit 4105, Boston MA 02110, US						
<hr/>							
(51)	MKP						
	A61K 38/26	2006	(97)	EP 3727425			
	A61P 3/00	2006					
	C07K 14/605	2006					
(96)	EP 18830614.6 12/14/2018						
(97)	EP 3727425, 10/28/2020 202044, en						
(31)	201762608644 P		(32)	21.12.2017		(33)	US
(54)	INCRETIN ANALOGS AND USES THEREOF						
(72)	ALSINA-FERNANDEZ, Jorge, c/o Eli Lilly and Company P.O. Box 6288, Indianapolis, IN 46206-6288, US						
	COSKUN, Tamer, c/o Eli Lilly and Company P.O. Box 6288, Indianapolis, IN 46206-6288, US						
	GUO, Lili, c/o Eli Lilly and Company P.O. Box 6288, Indianapolis, IN 46206-6288, US						
	QU, Hongchang, c/o Eli Lilly and Company P.O. Box 6288, Indianapolis, IN 46206-6288, US						
<hr/>							
(51)	MKP						
	A61K 38/26	2006	(97)	EP 3727426			
	A61P 3/00	2006					
	C07K 14/605	2006					

(96) EP 18830618.7 12/14/2018
 (97) EP 3727426, 10/28/2020 202044, en
 (31) 201762608613 P (32) 21.12.2017 (33) US
 (54) INCRETIN ANALOGS AND USES THEREOF
 (72) ALSINA-FERNANDEZ, Jorge, c/o Eli Lilly and Company P.O. Box 6288, Indianapolis, Indiana 46206-6288, US
 COSKUN, Tamer, c/o Eli Lilly and Company P.O. Box 6288, Indianapolis, Indiana 46206-6288, US
 GUO, Lili, c/o Eli Lilly and Company P.O. Box 6288, Indianapolis, Indiana 46206-6288, US
 QU, Hongchang, c/o Eli Lilly and Company P.O. Box 6288, Indianapolis, Indiana 46206-6288, US

(51) MKP
C12N 9/22 2006 (97) EP 3724332
C12N 15/10 2006
 (96) EP 18830642.7 12/14/2018
 (97) EP 3724332, 10/21/2020 202043, en
 (31) 17207294 (32) 14.12.2017 (33) EP
 (54) NOVEL RNA-PROGRAMMABLE ENDONUCLEASE SYSTEMS AND THEIR USE IN GENOME EDITING AND OTHER APPLICATIONS
 (71) Bayer HealthCare, LLC, 100 Bayer Boulevard Whippany, New Jersey 07981-0915, US
 (72) COHNEN, Andre, c/o Bayer Aktiengesellschaft Kaiser-Wilhelm-Allee, 51368 Leverkusen, DE
 SCHMIDT, Moritz, c/o Bayer Aktiengesellschaft Kaiser-Wilhelm-Allee, 51368 Leverkusen, DE
 COCO, Wayne, c/o Bayer Aktiengesellschaft Kaiser-Wilhelm-Allee, 51368 Leverkusen, DE
 GUPTA, Ashish, c/o Bayer Aktiengesellschaft Kaiser-Wilhelm-Allee, 51368 Leverkusen, DE
 TEBBE, Jan, c/o Bayer Aktiengesellschaft Kaiser-Wilhelm-Allee, 51368 Leverkusen, DE
 SCHULENBURG, Cindy, c/o Bayer Aktiengesellschaft Kaiser-Wilhelm-Allee, 51368 Leverkusen, DE
 PITZLER, Christian, c/o Bayer Aktiengesellschaft Kaiser-Wilhelm-Allee, 51368 Leverkusen, DE
 GAMALINDA, Michael Biag, c/o Bayer Aktiengesellschaft Kaiser-Wilhelm-Allee, 51368 Leverkusen, DE
 JACH, Sabine, c/o Bayer Aktiengesellschaft Kaiser-Wilhelm-Allee, 51368 Leverkusen, DE
 RICHTER, Florian, c/o Bayer Aktiengesellschaft Kaiser-Wilhelm-Allee, 51368 Leverkusen, DE
 ARUMUGHAN, Anup, c/o Bayer Aktiengesellschaft Kaiser-Wilhelm-Allee, 51368 Leverkusen, DE
 SAALWÄCHTER, Corinna, c/o Bayer Aktiengesellschaft Kaiser-Wilhelm-Allee, 51368 Leverkusen, DE

(51) MKP
A61K 31/437 2006 (97) EP 3728252
A61P 37/00 2006
C07D 471/04 2006
C07D 519/00 2006
 (96) EP 18830648.4 12/17/2018
 (97) EP 3728252, 10/28/2020 202044, en
 (31) 201762599875 P (32) 18.12.2017 (33) US
 (54) 4-AZAINDOLE COMPOUNDS
 (72) DYCKMAN, Alaric J., c/o Bristol-Myers Squibb Company Route 206 and Province Line Road, Princeton, New Jersey 08543, US
 DODD, Dharmal S., c/o Bristol-Myers Squibb Company Route 206 and Province Line Road, Princeton, New Jersey 08543, US
 MUSSARI, Christopher P., c/o Bristol-Myers Squibb Company Route 206 and Province Line Road, Princeton, New Jersey 08543, US
 SHERWOOD, Trevor C., c/o Bristol-Myers Squibb Company Route 206 and Province Line Road, Princeton, New Jersey 08543, US
 WHITELEY, Brian K., 1404 US HWY 22 West, Lebanon, NJ 08833, US
 GILMORE, John L., c/o Bristol-Myers Squibb Company Route 206 and Province Line Road, Princeton, New Jersey 08543, US
 KUMAR, Sreekantha Ratna, c/o Syngene International Limited Biocon Special Economic Zone Biocon Park, Plot No. 2&3 Bommasandra Industrial Area IV Phase Jigani Link Road, Bommasandra, Bangalore 560 099, Karnataka, IN
 PASUNOORI, Laxman, c/o Syngene International Limited Biocon Special Economic Zone Biocon Park, Plot No. 2&3 Bommasandra Industrial Area IV Phase Jigani Link Road, Bommasandra, Bangalore 560 099, Karnataka, IN
 SRINIVAS, Pitani Veera Venkata, c/o Syngene International Limited Biocon Special Economic Zone Biocon Park, Plot No. 2&3 Bommasandra Industrial Area IV Phase Jigani Link Road, Bommasandra, Bangalore 560 099, Karnataka, IN
 DURAISAMY, Srinivasan Kunchithapatham, c/o Syngene International Limited Biocon Special Economic Zone Biocon Park, Plot No. 2&3 Bommasandra Industrial Area IV Phase Jigani Link Road, Bommasandra, Bangalore 560 099, Karnataka, IN
 HEGDE, Subramanya, c/o Syngene International Limited Biocon Special Economic Zone Biocon Park, Plot No. 2&3 Bommasandra Industrial Area IV Phase Jigani Link Road, Bommasandra, Bangalore 560 099, Karnataka, IN
 ANUMULA, Rushith Kumar, c/o Syngene International Limited Biocon Special Economic Zone Biocon Park, Plot No. 2&3 Bommasandra Industrial Area IV Phase Jigani Link Road, Bommasandra, Bangalore 560 099, Karnataka, IN

(51) MKP
A61K 31/496 2006 (97) EP 3724178
A61P 35/00 2006
C07D 401/06 2006
C07D 401/14 2006
C07D 471/04 2006

	C07D 471/10	2006					
	C07D 491/107	2006					
	C07D 491/113	2006					
	C07D 491/20	2006					
	C07D 495/04	2006					
	C07D 495/10	2006					
	C07D 497/10	2006					
(96)	EP 18830663.3 12/17/2018						
(97)	EP 3724178, 10/21/2020 202043, en						
(31)	201762599336 P		(32)	15.12.2017		(33)	US
	1522018			08.02.2018			CH
(54)	1 -(PIPERIDINOCARBONYLMETHYL)-2-OXOPIPERAZINE DERIVATIVES FOR TREATING CANCER						
(71)	Inthera Bioscience AG, Einsiedlerstrasse 34, 8820 Wadenswil, CH						
(72)	LABELLE, Marc, 18 Regency Drive, Bedford, New Hampshire 03110, US						
	KAUR, Matinder, 159 Stan Bailie Dr., Winnipeg, Manitoba R3Y0R9, CA						
	TWIBANIRE, Jean-d'Amour K., 29 Crimson Way, Winnipeg, Manitoba R3X 0N7, CA						
	ULLAH, Farman, 604-1305 Taylor Ave., Winnipeg, Manitoba, CA						
	KESSLER, Ulrich, Staubstrasse 6, 8038 Zurich, CH						
	CATTORI, Valentino, Im Staubeweidli 15, 8820 Wadenswil, CH						
	COOK, Cyril, 150 Pilgrim Avenue, Winnipeg, Manitoba R2M 0L6, CA						
	VAKITI, Ramkrishna Reddy, 303-1281 Grant Avenue, Winnipeg, Manitoba R3M 1Z6, CA						
	JOHNSON, Kevin R.D., 31 Invermere Street, Winnipeg, Manitoba R3Y 1P8, CA						
<hr/>							
(51)	MKP						
	A61K 39/00	2006	(97)	EP 3728315			
	A61K 39/395	2006					
	A61P 3/04	2006					
	A61P 3/10	2006					
	C07K 16/28	2006					
(96)	EP 18830668.2 12/17/2018						
(97)	EP 3728315, 10/28/2020 202044, en						
(31)	201762607137 P		(32)	18.12.2017		(33)	US
	201862635406 P			26.02.2018			US
(54)	BISPECIFIC ANTIGEN BINDING MOLECULES THAT BIND LEPTIN RECEPTOR AND/OR GP130, AND METHODS OF USE THEREOF						
(72)	GROMADA, Jesper, c/o Regeneron Pharmaceuticals, Inc. 777 Old Saw Mill River Road, Tarrytown, New York 10591, US						
	STEVIS, Panayiotis, c/o Regeneron Pharmaceuticals, Inc. 777 Old Saw Mill River Road, Tarrytown, New York 10591, US						
	ALTAREJOS, Judith, c/o Regeneron Pharmaceuticals, Inc. 777 Old Saw Mill River Road, Tarrytown, New York 10591, US						
<hr/>							
(51)	MKP						
	A61K 31/519	2006	(97)	EP 3728254			
	A61P 35/00	2006					
	C07D 453/02	2006					
	C07D 471/04	2006					
	C07D 519/00	2006					
(96)	EP 18830816.7 12/20/2018						
(97)	EP 3728254, 10/28/2020 202044, en						
(31)	17209865		(32)	21.12.2017		(33)	EP
(54)	NOVEL BENZYLAMINO SUBSTITUTED PYRIDOPYRIMIDINONES AND DERIVATIVES AS SOS1 INHIBITORS						
(72)	RAMHARTER, Juergen, Boehringer Ingelheim International GmbH, Corporate Patents, Binger Strasse 173, 55216 INGELHEIM AM RHEIN, DE						
	KOFINK, Christiane, Boehringer Ingelheim International GmbH, Corporate Patents, Binger Strasse 173, 55216 INGELHEIM AM RHEIN, DE						
	STADTMUELLER, Heinz, Boehringer Ingelheim International GmbH, Corporate Patents, Binger Strasse 173, 55216 INGELHEIM AM RHEIN, DE						
	WUNBERG, Tobias, Boehringer Ingelheim International GmbH, Corporate Patents, Binger Strasse 173, 55216 INGELHEIM AM RHEIN, DE						
	HOFMANN, Marco Hans, Boehringer Ingelheim International GmbH, Corporate Patents, Binger Strasse 173, 55216 INGELHEIM AM RHEIN, DE						
	BAUM, Anke, Boehringer Ingelheim International GmbH, Corporate Patents, Binger Strasse 173, 55216 INGELHEIM AM RHEIN, DE						
	GMACHL, Michael, Boehringer Ingelheim International GmbH, Corporate Patents, Binger Strasse 173, 55216 INGELHEIM AM RHEIN, DE						
	RUDOLPH, Dorothea Ingrid, Boehringer Ingelheim International GmbH, Corporate Patents, Binger Strasse 173, 55216 INGELHEIM AM RHEIN, DE						
	SAVARESE, Fabio, Boehringer Ingelheim International GmbH, Corporate Patents, Binger Strasse 173, 55216 INGELHEIM AM RHEIN, DE						
	OSTERMEIER, Markus, Boehringer Ingelheim International GmbH, Corporate Patents, Binger Strasse 173, 55216 INGELHEIM AM RHEIN, DE						
	FRANK, Markus, Boehringer Ingelheim International GmbH, Corporate Patents, Binger Strasse 173, 55216 INGELHEIM AM RHEIN, DE						
	GILLE, Annika, Boehringer Ingelheim International GmbH, Corporate Patents, Binger Strasse 173, 55216 INGELHEIM AM RHEIN, DE						
	GOEPPER, Stefan, Boehringer Ingelheim International GmbH, Corporate Patents, Binger Strasse 173, 55216 INGELHEIM AM RHEIN, DE						
	SANTAGOSTINO, Marco, Boehringer Ingelheim International GmbH, Corporate Patents, Binger Strasse 173, 55216 INGELHEIM AM RHEIN, DE						

DE

WIPPICH, Julian, Boehringer Ingelheim International GmbH, Corporate Patents, Binger Strasse 173, 55216 INGELHEIM AM RHEIN, DE

(51) MKP
A23L 33/00 2016 (97) EP 3723509
A23L 33/105 2016
A61K 36/00 2006
(96) EP 18830955.3 12/12/2018
(97) EP 3723509, 10/21/2020 202043, en
(31) 201700145179 (32) 15.12.2017 (33) IT
(54) DIETARY SUPPLEMENT
(71) Sala, Stefano, Via del Commercio 66/68, 38121 Trento, IT
(72) Sala, Stefano, Via del Commercio 66/68, 38121 Trento, IT

(51) MKP
C07K 14/55 2006 (97) EP 3728302
C12N 15/62 2006
(96) EP 18830974.4 11/30/2018
(97) EP 3728302, 10/28/2020 202044, en
(31) 201762607850 P (32) 19.12.2017 (33) US
201862675070 P 22.05.2018 US
(54) ENGINEERED IL-2 FC FUSION PROTEINS
(72) BERNETT, Matthew, J, c/o Xencor, Inc. 111 West Lemon Avenue, Monrovia, CA 91016, US
DESJARLAIS, John, c/o Xencor, Inc. 111 West Lemon Avenue, Monrovia, CA 91016, US
VARMA, Rajat, c/o Xencor, Inc. 111 West Lemon Avenue, Monrovia, CA 91016, US
RASHID, Rumana, c/o Xencor, Inc. 111 West Lemon Avenue, Monrovia, CA 91016, US
SCHUBBERT, Suzanne, c/o Xencor, Inc. 111 West Lemon Avenue, Monrovia, CA 91016, US

(51) MKP
A61K 39/12 2006 (97) EP 3727441
A61K 39/29 2006
A61N 1/00 2006
A61P 31/14 2006
(96) EP 18830986.8 12/18/2018
(97) EP 3727441, 10/28/2020 202044, en
(31) PCT/US2017/067269 (32) 19.12.2017 (33) WO
201762607430 P 19.12.2017 US
(54) METHODS AND APPARATUS FOR THE DELIVERY OF HEPATITIS B VIRUS (HBV) VACCINES
(71) Ichor Medical Systems, Inc., 6310 Nancy Ridge Drive No.107, San Diego, CA 92121, US
(72) BODEN, Daniel, c/o Janssen Pharmaceutica NV Turnhoutseweg 30, 2340 Beerse, BE
HORTON, Helen, c/o Janssen Pharmaceutica NV Turnhoutseweg 30, 2340 Beerse, BE
NEEFS, Jean-Marc Edmond Fernand Marie, c/o Janssen Pharmaceutica NV Turnhoutseweg 30, 2340 Beerse, BE
ROY, Soumitra, c/o Janssen Vaccines & Prevention B.V. Archimedesweg 4-6, 2333 CN Leiden, NL
HANNAMAN, Andrew, W., 13832 Torrey Del Mar, San Diego, CA 92130, US
BERNARD, Robert, M., 2877 Paradise Rd, Unit 3303, Las Vegas, NV 89109-5275, US
MORSE, Stephen, A., 19710 131st Place NE, Woodinville, WA 98072, US
RUCK, Oliver, 705 Burr Oak Drive, Lewisville, TX 75067, US
HARTMAN, Adam, 3321 Knoll Pines Road, Denton, TX 76208, US
COX, Thomas, David, 1908 Sparrows Point Court, Plano, TX 75023, US
DE POOTER, Dorien, c/o Janssen Pharmaceutica NV Turnhoutseweg 30, 2340 Beerse, BE

(51) MKP
E21B 21/00 2006 (97) EP 3752704
(96) EP 18774124.4 8/27/2018
(97) EP 3752704, 12/23/2020 202052, en
(31) 201815896367 (32) 14.02.2018 (33) US
(54) CURING A LOST CIRCULATION ZONE IN A WELLBORE
(72) AL-SHAMMARI, Saad S., P.O. Box 2460, Dhahran, 31311, SA

(51) MKP
A61K 36/185 2006 (97) EP 3720462
A61K 36/24 2006

A61K 36/28 2006
A61K 36/47 2006
A61K 36/59 2006
A61K 36/708 2006
A61K 36/739 2006
A61K 36/756 2006
A61K 36/82 2006
A61K 36/886 2006
A61P 13/08 2006
A61P 15/00 2006
A61P 35/00 2006

(96) EP 18867405.5 10/18/2018

(97) EP 3720462, 10/14/2020 202042, en

(31) 201762574440 P (32) 19.10.2017 (33) US

(54) INHIBITION OF ANDROGEN RECEPTOR BY EXTRACTS OF MEDICINAL HERBS AND COMPOSITIONS THEREOF

(72) CHENG, Yung-Chi, 961 Baldwin Road, Woodbridge, CT 06525, US

LAM, Wing, 470 Prospect Street Apt. 38, New Haven, CT 06511, US

JIANG, Zaoli, 20 Cedar Rock Road, Woodbridge, CT 06525, US

(51) MKP

A61K 39/00 2006 (97) EP 3720483

A61K 39/09 2006

A61K 39/385 2006

A61P 31/04 2006

(96) EP 18871825.8 12/4/2018

(97) EP 3720483, 10/14/2020 202042, en

(31) 201762595388 P (32) 06.12.2017 (33) US

(54) COMPOSITIONS COMPRISING STREPTOCOCCUS PNEUMONIAE POLYSACCHARIDE-PROTEIN CONJUGATES AND METHODS OF USE THEREOF

(71) Merck Sharp & Dohme Corp., 126 East Lincoln Road, Rahway, New Jersey 07065-0907, US

(72) SMITH, William, J., 770 Sumneytown Pike, West Point, Pennsylvania 19486, US

MCHUGH, Patrick, 770 Sumneytown Pike, West Point, Pennsylvania 19486, US

WINTERS, Michael Albert, 770 Sumneytown Pike, West Point, Pennsylvania 19486, US

SKINNER, Julie, M., 770 Sumneytown Pike, West Point, Pennsylvania 19486, US

HE, Jian, 770 Sumneytown Pike, West Point, Pennsylvania 19486, US

MUSEY, Luwy, 351 North Sumneytown Pike, North Wales, Pennsylvania 19454, US

ABEYGUNAWARDANA, Chitrananda, 351 North Sumneytown Pike, North Wales, Pennsylvania 19454, US

CUI, Yadong Adam, 351 North Sumneytown Pike, North Wales, Pennsylvania 19454, US

KOSINSKI, Michael, J., 770 Sumneytown Pike, West Point, Pennsylvania 19486, US

(51) MKP

A61N 5/00 2006 (97) EP 3727582

A61N 5/06 2006

F21L 4/00 2006

F21L 4/02 2006

F21V 1/00 2006

F21V 3/00 2015

F21V 3/02 2006

F21V 3/04 2018

(96) EP 18879259.2 11/19/2018

(97) EP 3727582, 10/28/2020 202044, en

(31) 201762588241 P (32) 17.11.2017 (33) US

(54) FLESH-ILLUMINATING DEVICE

(71) Project LEAH, LLC, 8328 Dr. MLK Jr. St. N, St. Petersburg, FL 33702, US

Nanev, Aleksandar, 442 40th Ave. N., Saint Petersburg, FL 33703, US

(72) NANEV, Aleksandar, 442 40th Ave. N., Saint Petersburg, FL 33703, US

(51) MKP

H04N 19/124 2014 (97) EP 3716624

H04N 19/30 2014

(96) EP 18880220.1 6/25/2018

(97) EP 3716624, 9/30/2020 202040, en

(31) 201711166195 (32) 21.11.2017 (33) CN

(54) VIDEO ENCODING METHOD, COMPUTER DEVICE AND STORAGE MEDIUM

- (71) Tencent Technology (Shenzhen) Company Limited, 35/F, Tencent Building, Kejizhongyi Road, Midwest District of Hi-tech Park, Nanshan District., Shenzen, Guangdong 518057, CN
 (72) MAO, Xunan, 35/F, Tencent Building, Kejizhongyi Road, Midwest District of Hi-tech Park, Nanshan District., Shenzhen, GUANGDONG 518057, CN

- (51) MKP
A01K 61/60 2017 (97) EP 3713402
 (96) EP 18880447.0 11/21/2018
 (97) EP 3713402, 9/30/2020 202040, en
 (31) 20171878 (32) 21.11.2017 (33) NO
 (54) ROOF COVER FOR FISH FARM
 (71) Unitech Offshore AS, Espehaugen 25, 5258 Blomsterdalen, NO
 (72) HELLESØE, Bernt Henrik, C. Sundts gate 51, 5004 Bergen, NO
 BIRKELAND, Gunnar William, Eikjehammerveien 31, 5538 Haugesund, NO
 WANVIK, Leiv Gunnar, Myrveien 11A, 1397 Nesøya, NO
 LEDERGERBER HINDERLING, Christine, Sperletweg 59, 8052 Zürich, CH
 KABBANI, Issam, Chemin de Pierraz Portay 1, 1009 Pully, CH

- (51) MKP
A61K 9/51 2006 (97) EP 3713601
A61K 31/7115 2006
A61K 39/245 2006
A61P 31/22 2006
C12N 7/00 2006
 (96) EP 18881012.1 11/20/2018
 (97) EP 3713601, 9/30/2020 202040, en
 (31) 201762589170 P (32) 21.11.2017 (33) US
 (54) EPSTEIN-BARR VIRUS VACCINES
 (72) CIARAMELLA, Giuseppe, 1 Hawes Road, Sudbury, MA 01776, US
 JOHN, Shinu, 593 Somerville Avenue 2, Somerville, MA 02143, US
 NARAYANAN, Elisabeth, 6 Sherman Street Unit D, Cambridge, MA 02138, US
 BOLLMAN, Brooke, 176 Naples Road 7, Brookline, MA 02446, US

- (51) MKP
A61K 31/437 2006 (97) EP 3717483
A61P 35/00 2006
C07D 471/04 2006
C07D 519/00 2006
 (96) EP 18881021.2 11/23/2018
 (97) EP 3717483, 10/7/2020 202041, en
 (31) PCT/CN2017/112836 (32) 24.11.2017 (33) WO
 (54) PYRAZOLOPYRIDINONE COMPOUNDS
 (72) GUO, Haibing, Johnson & Johnson (China) Investment Ltd. 2101 No. 1 Building 65 Gui Qing Road Xuhui District, Shanghai 200233, CN
 WAN, Zhao-Kui, Johnson & Johnson (China) Investment Ltd. 2101 No. 1 Building 65 Gui Qing Road Xuhui District, Shanghai 200233, CN
 QIN, Luoheng, Johnson & Johnson (China) Investment Ltd. 2101 No. 1 Building 65 Gui Qing Road Xuhui District, Shanghai 200233, CN
 LIU, Qian, Johnson & Johnson (China) Investment Ltd. 2101 No. 1 Building 65 Gui Qing Road Xuhui District, Shanghai 200233, CN
 CHEUNG, Wing Shun, Johnson & Johnson (China) Investment Ltd. 2101 No. 1 Building 65 Gui Qing Road Xuhui District, Shanghai 200233, CN

- (51) MKP
A01K 61/60 2017 (97) EP 3713403
 (96) EP 18881125.1 11/21/2018
 (97) EP 3713403, 9/30/2020 202040, en
 (31) 20171877 (32) 21.11.2017 (33) NO
 (54) FISH FARM
 (72) HELLESØE, Bernt Henrik, C. Sundts gate 51, 5004 Bergen, NO
 BIRKELAND, Gunnar William, Eikjehammerveien 31, 5538 Haugesund, NO
 WANVIK, Leiv Gunnar, Myrveien 11A, 1397 Nesøya, NO

- (51) MKP
C07D 403/12 2006 (97) EP 3717473
C07D 403/14 2006

C07D 405/14 2006
C07D 413/14 2006
 (96) EP 18881859.5 11/20/2018
 (97) EP 3717473, 10/7/2020 202041, en
 (31) 201762589276 P (32) 21.11.2017 (33) US
 (54) POLYMORPHS AND SOLID FORMS OF A PYRIMIDINYLAMINO-PYRAZOLE COMPOUND, AND METHODS OF PRODUCTION
 (72) REMARCHUK, Travis, 161 Oyster Point Blvd, South San Francisco, California 94080, US
 SUDHAKAR, Anantha, 161 Oyster Point Blvd, South San Francisco, California 94080, US

(51) MKP
A61K 38/28 2006 (97) EP 3713594
C07K 14/62 2006
 (96) EP 18882215.9 11/20/2018
 (97) EP 3713594, 9/30/2020 202040, en
 (31) 201762589091 P (32) 21.11.2017 (33) US
 (54) CHARGE-SWITCHABLE POLYMERIC DEPOT FOR GLUCOSE-TRIGGERED INSULIN DELIVERY WITH ULTRAFAST RESPONSE
 (71) North Carolina State University, Office of Technology Commercialization and New Ventures 1021 Main Campus Drive 2nd Floor, Raleigh, North Carolina 27695-8210, US
 (72) GU, Zhen, c/o Office of Technology Commercialization and New Venture North Carolina State University 1021 Main Campus Drive 2nd Floor, Raleigh, NC 27695-8210, US
 WANG, Jinqiang, c/o Office of Technology Commercialization and New Venture North Carolina State University 1021 Main Campus Drive 2nd Floor, Raleigh, NC 27695-8210, US

(51) MKP
A61K 39/00 2006 (97) EP 3717512
A61K 51/10 2006
C07K 16/18 2006
 (96) EP 18882542.6 11/28/2018
 (97) EP 3717512, 10/7/2020 202041, en
 (31) 201762592294 P (32) 29.11.2017 (33) US
 (54) LYOPHILIZED FORMULATION OF A MONOCLONAL ANTIBODY AGAINST TRANSTHYRETIN
 (72) SOTO, Jay, c/o Prothena Biosciences Inc 331 Oyster Point Boulevard, South San Francisco California 94080, US
 HAWE, Andrea, Feilitzschstraße 32, 80801 München, DE
 TANTIPOLPHAN, Ruedeepporn, Euckenstraße 29, 81369 München, DE
 HEINDL, Stefan, Schubertgasse 82, 2380 Perchtoldsdorf, AT

(51) MKP
A61K 31/4245 2006 (97) EP 3717462
A61P 35/00 2006
C07D 271/113 2006
C07D 413/12 2006
 (96) EP 18882854.5 11/28/2018
 (97) EP 3717462, 10/7/2020 202041, en
 (31) 201762592023 P (32) 29.11.2017 (33) US
 (54) SULFONAMIDE COMPOUNDS AND USE THEREOF
 (72) NAKAMURA, Hiroyuki, c/o Taiho Pharmaceutical Co., Ltd. 3, Okubo, Tsukuba-Shi, Ibaraki 300-2611, JP
 TENG, Jing, SSCI 3065 Kent Avenue, West Lafayette Indiana 47906-1076, US
 GIGNAC, Nathan, SSCI 3065 Kent Avenue, West Lafayette Indiana 47906-1076, US

(51) MKP
A61K 47/68 2017 (97) EP 3717022
 (96) EP 18883067.3 11/29/2018
 (97) EP 3717022, 10/7/2020 202041, en
 (31) 201762592214 P (32) 29.11.2017 (33) US
 (54) COMPOSITIONS AND METHODS FOR THE DEPLETION OF CD5+ CELLS
 (72) BOITANO, Anthony, 27 Evelyn Road, Newton Massachusetts 02468, US
 COOKE, Michael, 135 University Road, No. 1, Brookline Massachusetts 02445, US
 PALCHAUDHURI, Rahul, 46 Springfield Street, Apt. 2, Somerville Massachusetts 02143, US
 MCDONOUGH, Sean, 60 Dahlia Drive, Littleton, MA 01460, US

(51) MKP

A61K 31/585 2006 (97) EP 3716982
A61K 39/395 2006
C07K 16/28 2006
(96) EP 18883152.3 11/29/2018
(97) EP 3716982, 10/7/2020 202041, en
(31) 201762593807 P (32) 01.12.2017 (33) US
201762595045 P 05.12.2017 US
(54) ANTI-CD40 ANTIBODY DRUG CONJUGATES
(72) HOBSON, Adrian D., 25 Holman Street, Shrewsbury Massachusetts 01545, US
OH, Jason Z., 61 Beverly Hill Drive, Shrewsbury Massachusetts 01545, US
MCPHERSON, Michael J., 287 Pillsbury Road, Ashby Massachusetts 01431, US
WAEGELL, Wendy, 7 Rice Corner Road, Brookfield Massachusetts 01506, US
BRYANT, Shaughn H., 30 Marble Street, Worcester Massachusetts 01603, US
HERNANDEZ, Axel, Jr., 14 Laurie Lane, Charlton Massachusetts 01507, US
IHLE, Claire L., 1050 N Emerson Street Apt. 4, Denver Colorado 80218, US
MARVIN, Christopher C., 242 Braxton Way, Grayslake Illinois 60030, US
PERNG, Olivia A., 2836 Stringham Way, Dublin California 94568, US
SANTORA, Ling C., 7 Thoreau Circle, Shrewsbury Massachusetts 01545, US
WANG, Lu, 14 Stratton Way, Northborough Massachusetts 01532, US
WANG, Lu, 12 Nipmuck Drive, Westborough Massachusetts 01581, US

(51) MKP
A61K 31/165 2006 (97) EP 3716964
A61K 31/18 2006
A61K 31/40 2006
C07C 255/00 2006
C07C 307/02 2006
C07C 317/50 2006
(96) EP 18883537.5 11/29/2018
(97) EP 3716964, 10/7/2020 202041, en
(31) 201762592215 P (32) 29.11.2017 (33) US
(54) MYST FAMILY HISTONE ACETYLTRANSFERASE INHIBITORS
(72) HARVEY, Darren Martin, 3 Barker Road, Acton Massachusetts 01720, US
CAMPBELL, John Emmerson, 581 Mount Auburn Street Unit 1, Cambridge Massachusetts 02138, US
DUNCAN, Kenneth William, 105 Briar Lane, Westwood Massachusetts 02090, US

(51) MKP
A61K 38/00 2006 (97) EP 3717519
C07K 16/28 2006
(96) EP 18883544.1 11/29/2018
(97) EP 3717519, 10/7/2020 202041, en
(31) 201762592169 P (32) 29.11.2017 (33) US
(54) COMPOSITIONS AND METHODS FOR THE DEPLETION OF CD2+ CELLS
(72) BOITANO, Anthony, 27 Evelyn Road, Newton Massachusetts 02468, US
COOKE, Michael, 135 University Road, No. 1, Brookline Massachusetts 02445, US
PALCHAUDHURI, Rahul, 46 Springfield Street Apt. 2, Somerville Massachusetts 02143, US
MCDONOUGH, Sean, 60 Dahlia Drive, Littleton, MA 01460, US

(51) MKP
A61K 31/4245 2006 (97) EP 3718545
A61K 45/00 2006
A61P 35/00 2006
A61P 43/00 2006
C07D 249/04 2006
(96) EP 18883950.0 11/28/2018
(97) EP 3718545, 10/7/2020 202041, en
(31) 2017229681 (32) 29.11.2017 (33) JP
(54) ANTITUMOR AGENT
(72) UENO, Hiroyuki, c/o Taiho Pharmaceutical Co., Ltd. 3 Okubo, Tsukuba-shi Ibaraki 300-2611, JP
HOSHINO, Takuya, c/o Taiho Pharmaceutical Co., Ltd. 3 Okubo, Tsukuba-shi Ibaraki 300-2611, JP

(51) MKP

	A01N 43/40	2006	(97) EP 3719004			
	A01N 43/50	2006				
	A01N 43/54	2006				
	A01N 43/56	2006				
	A01N 43/60	2006				
	A01N 43/76	2006				
	A01N 43/78	2006				
	A01N 43/80	2006				
	A01N 43/836	2006				
	A01N 47/02	2006				
	A01P 7/02	2006				
	A01P 7/04	2006				
	A01P 17/00	2006				
	A61K 31/4425	2006				
	A61P 33/00	2006				
	C07D 213/89	2006				
	C07D 401/12	2006				
	C07D 405/12	2006				
	C07D 409/12	2006				
	C07D 413/12	2006				
	C07D 417/12	2006				
(96)	EP 18884058.1 11/27/2018					
(97)	EP 3719004, 10/7/2020 202041, en					
(31)	2017231998		(32)	01.12.2017	(33)	JP
(54)	PYRIDINIUM SALT AND PEST CONTROL AGENT					
(72)	IWASA Takao, c/o Odawara Research Center Nippon Soda Co. Ltd. 345, Takada, Odawara-shi Kanagawa 250-0280, JP TANAKA Katsunori, c/o Odawara Research Center Nippon Soda Co. Ltd. 345, Takada, Odawara-shi Kanagawa 250-0280, JP NABETA Atsuko, c/o Nippon Soda Co. Ltd. 2-1, Ohtemachi 2-chome Chiyoda-ku, Tokyo 100-8165, JP TAGUCHI Riho, c/o Odawara Research Center Nippon Soda Co. Ltd. 345, Takada, Odawara-shi Kanagawa 250-0280, JP SHIBAYAMA Kotaro, c/o Odawara Research Center Nippon Soda Co. Ltd. 345, Takada, Odawara-shi Kanagawa 250-0280, JP SUZUKI Hiroto, c/o Odawara Research Center Nippon Soda Co. Ltd. 345 Takada, Odawara-shi Kanagawa 250-0280, JP SAKAMOTO Rie, c/o Nippon Soda Co. Ltd. 2-1, Ohtemachi 2-chome Chiyoda-ku, Tokyo 100-8165, JP TAKAHASHI Miho, c/o Odawara Research Center Nippon Soda Co. Ltd. 345, Takada, Odawara-shi Kanagawa 250-0280, JP HOYA Tsuyoshi, c/o Odawara Research Center Nippon Soda Co. Ltd. 345, Takada, Odawara-shi Kanagawa 250-0280, JP					
(51)	MKP					
	A61K 38/00	2006	(97) EP 3717505			
	C07K 14/00	2006				
	C12Q 1/68	2018				
(96)	EP 18884285.0 11/30/2018					
(97)	EP 3717505, 10/7/2020 202041, en					
(31)	201762593824 P		(32)	01.12.2017	(33)	US
	201762610014 P			22.12.2017		US
	201862618966 P			18.01.2018		US
	201862641806 P			12.03.2018		US
	201862646198 P			21.03.2018		US
	201862664814 P			30.04.2018		US
	201862664817 P			30.04.2018		US
(54)	ENGINEERED DNA BINDING PROTEINS					
(72)	TAGLIATELA, Stephanie, Encoded Therapeutics, Inc. 341 Oyster Point Boulevard, South San Francisco California 94080, US TANENHAUS, Anne, Encoded Therapeutics, Inc. 341 Oyster Point Boulevard, South San Francisco California 94080, US RAMAMOORTHY, Kartik, Encoded Therapeutics, Inc. 341 Oyster Point Boulevard, South San Francisco California 94080, US YOUNG, Andrew, Encoded Therapeutics, Inc. 341 Oyster Point Boulevard, South San Francisco California 94080, US OBERKOFER, David, Encoded Therapeutics, Inc. 341 Oyster Point Boulevard, South San Francisco California 94080, US					
(51)	MKP					
	A61K 31/42	2006	(97) EP 3720438			
	A61K 31/505	2006				
	A61K 31/506	2006				
	C07D 247/02	2006				
	C07D 261/02	2006				
	C07D 261/06	2006				
(96)	EP 18885399.8 12/7/2018					
(97)	EP 3720438, 10/14/2020 202042, en					
(31)	201762595894 P		(32)	07.12.2017	(33)	US

201862649225 P

28.03.2018

US

- (54) HETEROCYCLE SUBSTITUTED PYRIDINE DERIVATIVE ANTIFUNGAL AGENTS
 (71) Amplyx Pharmaceuticals, Inc., 12730 High Bluff Drive Suite 160, San Diego, California 92130, US
 (72) TRZOSS, Michael, 12730 High Bluff Drive Suite 160, San Diego, California 92130, US
 COVEL, Jonathan, 12730 High Bluff Drive Suite 160, San Diego, California 92130, US
 SHAW, Karen Joy, 12730 High Bluff Drive Suite 160, San Diego, California 92130, US
 WEBB, Peter, 12730 High Bluff Drive Suite 160, San Diego, California 92130, US
-

- (51) MKP
A61K 31/7088 2006 (97) EP 3720448
A61K 31/712 2006
A61K 31/713 2006
A61K 39/395 2006
A61K 47/68 2017
C12N 15/113 2010

(96) EP 18886269.2 12/6/2018

(97) EP 3720448, 10/14/2020 202042, en

(31) 201762595545 P (32) 06.12.2017 (33) US
 201862725883 P 31.08.2018 US

- (54) COMPOSITIONS AND METHODS OF TREATING MUSCLE ATROPHY AND MYOTONIC DYSTROPHY
 (72) GEALL, Andrew John, 10975 North Torrey Pines Road. Suite 150, La Jolla California 92037, US
 DOPPALAPUDI, Venkata Ramana, 10975 North Torrey Pines Road. Suite 150, La Jolla California 92037, US
 CHU, David Sai-Ho, 10975 North Torrey Pines Road Suite 150, La Jolla California 92037, US
 COCHRAN, Michael Caramian, 10975 North Torrey Pines Road. Suite 150, La Jolla California 92037, US
 HOOD, Michael, 10975 North Torrey Pines Road Suite 150, La Jolla California 92037, US
 DARIMONT, Beatrice Diana, 10975 North Torrey Pines Road Suite 150, La Jolla California 92037, US
 BURKE, Rob, 10975 North Torrey Pines Road. Suite 150, La Jolla California 92037, US
 SHI, Yunyu, 10975 North Torrey Pines Road Suite 150, La Jolla California 92037, US
 MARELIUS, Gulin Erdogan, 10975 North Torrey Pines Road Suite 150, La Jolla California 92037, US
 MALECOVA, Barbora, 10975 North Torrey Pines Road Suite 150, La Jolla California 92037, US
-

- (51) MKP
A61K 9/08 2006 (97) EP 3720421
A61K 31/198 2006
A61K 31/375 2006
A61K 31/4415 2006
A61K 31/51 2006
A61K 31/525 2006
A61K 31/714 2006
A61K 33/14 2006
A61K 47/18 2017

(96) EP 18886422.7 12/7/2018

(97) EP 3720421, 10/14/2020 202042, en

(31) 201762595909 P (32) 07.12.2017 (33) US

- (54) COMPOSITIONS AND METHODS FOR THE TREATMENT OF METABOLIC CONDITIONS
 (71) Reven IP Holdco LLC, 600 Corporate Circle, Suite D, Golden, CO 80401, US
 (72) ERVIN, James, 31168 Kingswood Blvd., Novi MI 48377, US
 VAN WYK, Hendrik Johanness Petrus, 4550 Cherry Creek Dr. S 2300, Glendale CO 80246, US
 DENOMME, Brian David, 15658 Dorchester Ct., Northville MI 48168, US
 VAN WYK, Mariette Luise, 4550 Cherry Creek Dr. S 2300, Glandale CO 80246, US
 PACULT, Peter, 1490 Delgany St. 1006, Denver CO 80202, US
 VOLK, Michael A., 2205 W 136 Ave 106218, Broomfield CO 80023, US
-

- (51) MKP
C12N 5/10 2006 (97) EP 3720952
C12N 9/22 2006
C12N 15/09 2006
C12N 15/113 2010
C12N 15/63 2006
C12N 15/64 2006
C12N 15/66 2006
C12N 15/90 2006

(96) EP 18886653.7 12/6/2018

(97) EP 3720952, 10/14/2020 202042, en

(31)	201762595328 P 201762607069 P	(32)	06.12.2017 18.12.2017	(33)	US US
(54)	GENE EDITING USING A MODIFIED CLOSED-ENDED DNA (CEDNA)				
(72)	KOTIN, Robert M., c/o Generation Bio Co. 301 Binney Street, 4th Floor, Cambridge, MA 02142, US KERR, Douglas, c/o Generation Bio Co. 301 Binney Street, 4th Floor, Cambridge, MA 02142, US SAMAYOA, Phillip, c/o Generation Bio Co. 301 Binney Street, 4th Floor, Cambridge, MA 02142, US ALKAN, Ozan, c/o Generation Bio Co. 301 Binney Street, 4th Floor, Cambridge, MA 02142, US SIMMONS, Matthew J., c/o Generation Bio Co. 301 Binney Street, 4th Floor, Cambridge, MA 02142, US				

(51)	MKP A61K 9/00 2006 (97) EP 3720487 A61K 9/14 2006 A61K 39/12 2006 A61K 47/26 2006				
(96)	EP 18887100.8 12/3/2018				
(97)	EP 3720487, 10/14/2020 202042, en				
(31)	201762595842 P	(32)	07.12.2017	(33)	US
(54)	FORMULATIONS OF DENGUE VIRUS VACCINE COMPOSITIONS				
(72)	RYAN, Michael, S., 770 Sumneytown Pike, West Point, Pennsylvania 19486, US MARTIN, Sherrie-Ann, P., 770 Sumneytown Pike, West Point, Pennsylvania 19486, US JONES, Morrisa, 770 Sumneytown Pike, West Point, Pennsylvania 19486, US STANBRO, Justin, 770 Sumneytown Pike, West Point, Pennsylvania 19486, US BHAMBHANI, Akhilesh, 770 Sumneytown Pike, West Point, Pennsylvania 19486, US BLUE, Jeffrey Thomas, 770 Sumneytown Pike, West Point, Pennsylvania 19486, US PIXLEY, Heidi Joanne, 770 Sumneytown Pike, West Point, Pennsylvania 19486, US GREEN-TREXLER, Erin, J., 770 Sumneytown Pike, West Point, Pennsylvania 19486, US ISOPI, Lynne Ann, 770 Sumneytown Pike, West Point, Pennsylvania 19486, US				

(51)	MKP C07K 16/18 2006 (97) EP 3724227 C07K 16/34 2006 C07K 16/44 2006 G01N 33/53 2006 G01N 33/577 2006 G01N 33/72 2006				
(96)	EP 18887392.1 12/14/2018				
(97)	EP 3724227, 10/21/2020 202043, en				
(31)	201762599260 P	(32)	15.12.2017	(33)	US
(54)	SICKLED BETA GLOBIN ANTIBODIES				
(72)	NEGRE, Olivier, 60 Binney Street, Cambridge, Massachusetts 02142, US				

(51)	MKP C10L 5/14 2006 (97) EP 3724300 C10L 5/44 2006				
(96)	EP 18887732.8 12/12/2018				
(97)	EP 3724300, 10/21/2020 202043, en				
(31)	201762597542 P	(32)	12.12.2017	(33)	US
(54)	TORREFIED BIOMASS BRIQUETTES AND RELATED METHODS				
(72)	SATYAVOLU, Jagannadh, 9009 Crowne Springs Circle 100, Louisville, KY 40241, US BU-AAMIRI, Osama, 7701 Sherry Lynn Ct, Louisville, KY 40228, US THILAKARATNE, Chamilar, R., 3102 Renwood Blvd, Apt 301, Louisville, KY 40214, US				

(51)	MKP A61K 38/17 2006 (97) EP 3723788 A61K 39/395 2006 C07K 14/705 2006 C07K 16/28 2006				
(96)	EP 18887913.4 12/14/2018				
(97)	EP 3723788, 10/21/2020 202043, en				
(31)	201762599211 P	(32)	15.12.2017	(33)	US
(54)	CD19 VARIANTS				
(71)	Regents of the University of Minnesota, 600 McNamara Alumni Center, 200 Oak Street SE, Minneapolis, Minnesota 55455-2020, US				

(72) LOBB, Roy, 580 Washington Street Apt. 304, Wellesley, Massachusetts 02482, US
 RENNERT, Paul, 205 Underwood St., Holliston, Massachusetts 01746, US
 HACKEL, Benjamin, 7105 Gloucester Avenue, Edina, Minnesota 55435, US
 KLESMITH, Justin, 1800 Centennial Drive, Roseville, Minnesota 55113, US

(51) MKP
C07K 7/00 2006 (97) EP 3724208
C07K 7/06 2006
C12P 21/00 2006

(96) EP 18887999.3 12/14/2018

(97) EP 3724208, 10/21/2020 202043, en

(31)	201762599547 P	(32)	15.12.2017	(33)	US
	201862676688 P		25.05.2018		US

(54) COMPOSITIONS COMPRISING CIRCULAR POLYRIBONUCLEOTIDES AND USES THEREOF

(71) Flagship Pioneering Innovations VI, LLC, 55 Cambridge Parkway, 8th Floor, Cambridge, MA 02142, US
 (72) KAHVEJIAN, Avak, 55 Cambridge Parkway 8th Floor, Suite 800E, Cambridge, Massachusetts 02142, US
 PLUGIS, Nicholas McCartney, 55 Cambridge Parkway 8th Floor, Suite 800E, Cambridge, Massachusetts 02142, US
 DE BOER, Alexandra Sophie, 55 Cambridge Parkway 8th Floor, Suite 800E, Cambridge, Massachusetts 02142, US
 CIFUENTES-ROJAS, Catherine, 55 Cambridge Parkway 8th Floor, Suite 800E, Cambridge, Massachusetts 02142, US
 PAEK, Ki Young, 55 Cambridge Parkway 8th Floor, Suite 800E, Cambridge, Massachusetts 02142, US
 MELFI, Michael Donato, 55 Cambridge Parkway 8th Floor, Suite 800E, Cambridge, Massachusetts 02142, US
 WEISTEIN, Erica Gabrielle, 55 Cambridge Parkway 8th floor, Suite 800E, Cambridge, Massachusetts 02142, US
 TROUSIL, Sebastian, 55 Cambridge Parkway 8th Floor, Suite 800E, Cambridge, Massachusetts 02142, US
 STEWART, Morag Helen, 55 Cambridge Parkway 8th Floor, Suite 800E, Cambridge, Massachusetts 02142, US

(51) MKP
G03G 21/18 2006 (97) EP 3726298

(96) EP 18888533.9 12/12/2018

(97) EP 3726298, 10/21/2020 202043, en

(31)	2017238454	(32)	13.12.2017	(33)	JP
	2018068246		30.03.2018		JP
	2018080112		18.04.2018		JP

(54) CARTRIDGE AND IMAGE FORMING DEVICE {}

(71) CANON KABUSHIKI KAISHA, 30-2 SHIMOMARUKO 3-CHOME, OHTA-KU Tokyo 146-8501, JP
 (72) MATSUMARU, Naoki, c/o CANON KABUSHIKI KAISHA 30-2, Shimomaruko 3- chome Ohta-ku, Tokyo 146-8501, JP
 MURAKAMI, Ryuta, c/o CANON KABUSHIKI KAISHA 30-2, Shimomaruko 3- chome Ohta-ku, Tokyo 146-8501, JP
 HORIKAWA, Tadashi, c/o CANON KABUSHIKI KAISHA 30-2, Shimomaruko 3- chome Ohta-ku, Tokyo 146-8501, JP
 FUJIWARA, Akihiro, c/o CANON KABUSHIKI KAISHA 30-2, Shimomaruko 3- chome Ohta-ku, Tokyo 146-8501, JP
 HIRAYAMA, Akinobu, c/o CANON KABUSHIKI KAISHA 30-2, Shimomaruko 3- chome Ohta-ku, Tokyo 146-8501, JP
 MAKIGUCHI, Daisuke, c/o CANON KABUSHIKI KAISHA 30-2, Shimomaruko 3- chome Ohta-ku, Tokyo 146-8501, JP
 NOSHO, Hiroaki, c/o CANON KABUSHIKI KAISHA 30-2, Shimomaruko 3- chome Ohta-ku, Tokyo 146-8501, JP
 KANNO, Takuro, c/o CANON KABUSHIKI KAISHA 30-2, Shimomaruko 3- chome Ohta-ku, Tokyo 146-8501, JP
 OZAKI, Goshi, c/o CANON KABUSHIKI KAISHA 30-2, Shimomaruko 3- chome Ohta-ku, Tokyo 146-8501, JP
 KAWAI, Tachio, c/o CANON KABUSHIKI KAISHA 30-2, Shimomaruko 3- chome Ohta-ku, Tokyo 146-8501, JP
 ABE, Daisuke, c/o CANON KABUSHIKI KAISHA 30-2, Shimomaruko 3- chome Ohta-ku, Tokyo 146-8501, JP

(51) MKP
A61K 31/437 2006 (97) EP 3723757
C07D 409/14 2006
C07D 513/16 2006

(96) EP 18888578.4 12/14/2018

(97) EP 3723757, 10/21/2020 202043, en

(31)	201762598673 P	(32)	14.12.2017	(33)	US
------	----------------	------	------------	------	----

(54) SMALL MOLECULE DEGRADERS THAT RECRUIT DCAFT15

(72) GRAY, Nathanael, S., 26 Greenview Avenue, Boston, MA 02130, US
 FISCHER, Eric, 69 Pond Brook Road, Chestnut Hill, MA 02467, US
 YOON, Hojong, 11 Peabody terrace, 1801, Cambridge, MA 02138, US
 CAI, Quan, 220 Handan Rd. Yichuanxue Buiding Room 513, Yangpu, Shanghai, 200433, CN
 ZHANG, Tinghu, 118 Franklin Street, Apt. 2, Brookline, MA 02445, US
 FAUST, Tyler, 30 Harvard Ave. Apt. 2, Brookline, MA 02446, US
 DONOVAN, Katherine, 27 Park Drive, Apt. 3, Boston, MA 02215, US

(51) MKP

A61K 38/16 2006 (97) EP 3723787
C07K 14/435 2006
C12N 15/62 2006
 (96) EP 18888801.0 12/14/2018
 (97) EP 3723787, 10/21/2020 202043, en
 (31) 201762598923 P (32) 14.12.2017 (33) US
 (54) DARIC INTERLEUKIN RECEPTORS
 (72) LEUNG, Wai-Hang, 3439A 22nd Avenue West, Seattle, Washington 98199, US

(51) MKP
C07K 14/705 2006 (97) EP 3724220
C12N 5/00 2006
 (96) EP 18888892.9 12/14/2018
 (97) EP 3724220, 10/21/2020 202043, en
 (31) 201762598902 P (32) 14.12.2017 (33) US
 201862730926 P 13.09.2018 US
 (54) NKG2D DARIC RECEPTORS
 (72) LEUNG, Wai-Hang, 3439A 22nd Avenue West, Seattle, Washington 98199, US
 JARJOUR, Jordan, 11014 37th Ave SW, Seattle, Washington 98146, US

(51) MKP
A61K 38/04 2006 (97) EP 3724211
A61K 38/12 2006
C07K 7/06 2006
C07K 7/50 2006
C07K 7/64 2006
C07K 14/47 2006
 (96) EP 18889718.5 12/14/2018
 (97) EP 3724211, 10/21/2020 202043, en
 (31) 201762599637 P (32) 15.12.2017 (33) US
 201862655094 P 09.04.2018 US
 201862744565 P 11.10.2018 US
 (54) DOSING REGIMENS AND RELATED COMPOSITIONS AND METHODS
 (72) GROSSI, Federico, 53 Eliot Memorial Rd., Newton, Massachusetts 02458, US
 DESCHATELETS, Pascal, 9506 Delphinium Street, Prospect, Kentucky 40059, US
 FRANCOIS, Cedric, 1726 Riverside Drive, Prospect, Kentucky 40059, US
 JOHNSON, Patrick, c/o Apellis Pharmaceuticals, Inc. 6400 Westwind Way, Suite A, Crestwood, Kentucky 40014, US
 VEGA, Carolina, c/o Apellis Pharmaceuticals, Inc. 6400 Westwind Way, Suite A, Crestwood, Kentucky 40014, US

(51) MKP
A61K 9/16 2006 (97) EP 3727353
A61K 9/72 2006
A61P 11/16 2006
C07K 14/785 2006
 (96) EP 18890080.7 12/19/2018
 (97) EP 3727353, 10/28/2020 202044, en
 (31) 201762609277 P (32) 21.12.2017 (33) US
 (54) SURFACTANT FORMULATIONS FOR INHALATION
 (72) LIPP, Michael M., 45A Flanagan Drive, Framingham, MA 01710, US
 CHAN, Holly, 367 Middle St., Braintree, MA 02148, US

(51) MKP
C07D 231/56 2006 (97) EP 3728202
C07D 471/04 2006
 (96) EP 18890087.2 12/20/2018
 (97) EP 3728202, 10/28/2020 202044, en
 (31) 201762609844 P (32) 22.12.2017 (33) US
 (54) DIARYL SUBSTITUTED 5,5-FUSED RING COMPOUNDS AS C5AR INHIBITORS
 (72) FAN, Pingchen, 2157 Kalenda Commons, Fremont, California 94539, US
 LANGE, Christopher W., 6818 Cutting Boulevard, El Cerrito, California 94530, US
 LUI, Rebecca M., 3901 Lick Mill Boulevard, 346, Santa Clara, California 95054, US
 MALATHONG, Viengkham, 1221 Judson Street, Belmont, California 94002, US
 MALI, Venkat Reddy, 20200 Lucille Avenue, Apt. 4, Cupertino, California 95014, US

PUNNA, Sreenivas, 938 Fontana Terrace, Sunnyvale, California 94085, US
 SINGH, Rajinder, 1832 Hillman Avenue, Belmont, California 94002, US
 ZENG, Yibin, 917 Aruba Lane, Foster City, California 94404, US
 ZHANG, Penglie, 1036 Jamaica Street, Foster City, California 94404, US

- (51) MKP
A01G 9/24 2006 (97) EP 3729160
G02B 19/00 2006
- (96) EP 18890376.9 12/13/2018
 (97) EP 3729160, 10/28/2020 202044, en
- (31) 201762607738 P (32) 19.12.2017 (33) US
- (54) METHODS AND DEVICES FOR STIMULATING GROWTH OF GRAPE VINES, GRAPE VINE REPLANTS OR AGRICULTURAL CROPS
 (71) Opti-Harvest, Inc., 1999 Avenue of the Stars, Suite 2520, Los Angeles, CA 90067, US
 (72) SHAHAK, Yosepha, 1999 Avenue of the Stars, Suite 2520, Los Angeles, California 90067, US
 BOOTH, Nicholas, 1999 Avenue of the Stars, Suite 2520, Los Angeles, California 90067, US
 PEACOCK, William L., 1999 Avenue of the Stars, Suite 2520, Los Angeles, California 90067, US
 RAVID, Nadav, 1999 Avenue of the Stars, Suite 2520, Los Angeles, California 90067, US
 DESTLER, Jonathan, 1999 Avenue of the Stars, Suite 2520, Los Angeles, California 90067, US
 FARKAS, Daniel, 1999 Avenue of the Stars, Suite 2520, Los Angeles, California 90067, US

- (51) MKP
C07D 231/56 2006 (97) EP 3728203
C07D 471/04 2006
- (96) EP 18890906.3 12/20/2018
 (97) EP 3728203, 10/28/2020 202044, en
- (31) 201762609834 P (32) 22.12.2017 (33) US
- (54) DIARYL SUBSTITUTED 6,5-FUSED RING COMPOUNDS AS C5aR INHIBITORS
 (72) FAN, Pingchen, 2157 Kalenda Commons, Fremont, California 94539, US
 LANGE, Christopher W., 6818 Cutting Boulevard, El Cerrito, California 94530, US
 MALATHONG, Viengkham, 1221 Judson Street, Belmont, California 94002, US
 MALI, Venkat Reddy, 20200 Lucille Avenue, Apt. 4, Cupertino, California 95014, US
 PUNNA, Sreenivas, 938 Fontana Terrace, Sunnyvale, California 94085, US
 TANAKA, Hiroko, 600 Rainbow Drive, 148, Mountain View, California 94041, US
 ZENG, Yibin, 917 Aruba Lane, Foster City, California 94404, US
 ZHANG, Penglie, 1036 Jamaica Street, Foster City, California 94404, US

- (51) MKP
A61K 31/513 2006 (97) EP 3730935
A61K 31/7072 2006
A61P 35/00 2006
C07H 19/073 2006
G01N 30/26 2006
G01N 30/88 2006
- (96) EP 18890977.4 12/21/2018
 (97) EP 3730935, 10/28/2020 202044, en
- (31) 2017246043 (32) 22.12.2017 (33) JP
 201815952367 13.04.2018 US
 201810427364 07.05.2018 CN
- (54) METHOD FOR DETECTING TRIFLURIDINE- AND/OR TPIRACIL-DERIVED ANALOGS
 (72) TOKIMITSU, Yoshinori, c/o TAIHO PHARMACEUTICAL CO., LTD., 224-2, Hiraishi Ebisuno Kawauchi-cho Tokushima-shi, Tokushima 771-0194, JP

- (51) MKP
A61K 9/00 2006 (97) EP 3727468
A61K 39/395 2006
A61K 48/00 2006
A61P 27/16 2006
C12N 15/113 2010
- (96) EP 18891434.5 12/19/2018
 (97) EP 3727468, 10/28/2020 202044, en
- (31) 201762607665 P (32) 19.12.2017 (33) US
- (54) AAV-MEDIATED DELIVERY OF THERAPEUTIC ANTIBODIES TO THE INNER EAR
 (71) Akouos, Inc., 645 Summer Street, Suite 200, Boston, MA 02210, US

(72) SIMONS, Emmanuel J., 7 Stetson Street, Brookline, Massachusetts 02446, US
 NG, Robert, 47 Lincoln Road, Unit 1, Newton, Massachusetts 02458, US
 MCKENNA, Michael, 6 Reservoir Drive, Southborough, Massachusetts 01772, US

(51) MKP
A61K 31/155 2006 (97) EP 3727363
A61K 31/4164 2006
A61K 31/496 2006
 (96) EP 18891458.4 12/19/2018
 (97) EP 3727363, 10/28/2020 202044, en
 (31) 201762610095 P (32) 22.12.2017 (33) US
 (54) TRANSDERMAL NON-AQUEOUS NANOEMULGELS FOR SYSTEMIC DELIVERY OF AROMATASE INHIBITOR
 (71) Qatar University, P.O. Box 2713, Doha, QA
 (72) SALLAM, Assayed AlArabi Nauman, P.O. Box 960761, Amman 11196, JO
 YOUNES, Husam M., P.O. Box 2713, Doha, QA

(51) MKP
A61K 31/282 2006 (97) EP 3727368
A61K 31/436 2006
A61K 31/513 2006
A61K 31/519 2006
A61K 39/395 2006
A61P 35/00 2006
 (96) EP 18891945.0 12/18/2018
 (97) EP 3727368, 10/28/2020 202044, en
 (31) 201762607798 P (32) 19.12.2017 (33) US
 (54) METHODS OF TREATING COLON CANCER USING NANOPARTICLE MTOR INHIBITOR COMBINATION THERAPY
 (71) Abraxis BioScience, LLC, 86 Morris Avenue, Summit, New Jersey 07901, US
 (72) DESAI, Neil P., 1343 Luna Vista Drive, Pacific Palisades, California 90272, US

(51) MKP
A47F 9/04 2006 (97) EP 3729375
G06Q 30/06 2012
G06T 7/41 2017
G07G 1/12 2006
 (96) EP 18891998.9 12/20/2018
 (97) EP 3729375, 10/28/2020 202044, en
 (31) 2017905146 (32) 21.12.2017 (33) AU
 (54) A RETAIL CHECKOUT TERMINAL FRESH PRODUCE IDENTIFICATION SYSTEM
 (71) TILITER PTY LTD, Suite 3, 30 Cowper St, Parramatta, NSW 2150, AU
 (72) HERZ, Marcel, Suite 3, 30 Cowper St, Parramatta, New South Wales 2150, AU
 SAMPSON, Christopher, Suite 3, 30 Cowper St, Parramatta, New South Wales 2150, AU

(51) MKP
A61K 31/47 2006 (97) EP 3728260
A61K 31/519 2006
A61P 35/02 2006
C07D 471/10 2006
C07D 487/10 2006
C07D 495/04 2006
 (96) EP 18892193.6 12/19/2018
 (97) EP 3728260, 10/28/2020 202044, en
 (31) PCT/CN2017/117536 (32) 20.12.2017 (33) WO
 PCT/CN2018/091521 15.06.2018 WO
 (54) EXO-AZA SPIRO INHIBITORS OF MENIN-MLL INTERACTION
 (72) DAI, Xuedong, Johnson & Johnson (China) Investment Ltd. 2101, No.1 Building, 65 Gui Qing Road Xuhui District, Shanghai 200233, CN
 QUEROLLE, Olivier Alexis Georges, Janssen-Cilag 1 Rue Camille Desmoulins, TSA 91003, 92787 Issy-les Moulineaux Cedex 9, FR
 KROSKY, Daniel Jason, Janssen Research And Development, LLC 920 Route 202, Raritan, New Jersey 08869, US
 CAI, Wei, Johnson & Johnson (China) Investment Ltd. 2101, No.1 Building, 65 Gui Qing Road Xuhui District, Shanghai 200233, CN
 FU, Liqiang, Johnson & Johnson (China) Investment Ltd. 2101, No.1 Building, 65 Gui Qing Road Xuhui District, Shanghai 200233, CN
 KONG, Linglong, Johnson & Johnson (China) Investment Ltd. 2101, No.1 Building, 65 Gui Qing Road Xuhui District, Shanghai 200233, CN
 LIU, Yingtao, Johnson & Johnson (China) Investment Ltd. 2101, No.1 Building, 65 Gui Qing Road Xuhui District, Shanghai 200233, CN
 WAN, Zhao-Kui, Johnson & Johnson (China) Investment Ltd. 2101, No.1 Building, 65 Gui Qing Road Xuhui District, Shanghai 200233, CN

MORSCHHÄUSER GEB. HERKERT, Barbara, Janssen Pharmaceutica NV Turnhoutseweg 30, 2340 Beerse, BE
 PANDE, Vineet, Janssen Pharmaceutica NV Turnhoutseweg 30, 2340 Beerse, BE
 EDWARDS, James Patrick, Janssen Research & Development, LLC 920 US Route 202, PO Box 300, Raritan, New Jersey 08869, US
 PATRICK, Aaron Nathaniel, Janssen Research & Development, LLC 920 US Route 202, PO Box 300, Raritan, New Jersey 08869, US
 ANGIBAUD, Patrick René, Janssen-Cilag 1 Rue Camille Desmoulins, TSA 91003, 92787 Issy-les Moulineaux Cedex 9, FR
 PONCELET, Virginie Sophie, Janssen-Cilag 1 Rue Camille Desmoulins, TSA 91003, 92787 Issy-les Moulineaux Cedex 9, FR

- (51) MKP
A61K 39/12 2006 (97) EP 3730620
A61K 39/145 2006
A61K 39/295 2006
A61P 31/14 2006
A61P 31/16 2006
C07K 14/08 2006
C07K 14/11 2006
C07K 19/00 2006
C12N 15/40 2006
C12N 15/44 2006
C12N 15/62 2006
 (96) EP 18892222.3 12/21/2018
 (97) EP 3730620, 10/28/2020 202044, en
 (31) 2017245606 (32) 21.12.2017 (33) JP
 (54) CROSS-IMMUNIZING ANTIGEN VACCINE AND METHOD FOR PREPARATION THEREOF
 (71) Green Biomed, Inc., 1-6, Sengen 2-chome, Tsukuba-shi, Ibaraki 305-0047, JP
 KIRIN HOLDINGS KABUSHIKI KAISHA, Nakano Central Park South 10-2, Nakano 4-chome, Nakano-ku, Tokyo 164-0001, JP
 (72) SEKIKAWA, Kenji, c/o Green BioMed, Inc., 1-6, Sengen 2-chome, Tsukuba-shi, Ibaraki 305-0047, JP

- (51) MKP
C07K 16/46 2006 (97) EP 3732205
 (96) EP 18892274.4 12/21/2018
 (97) EP 3732205, 11/4/2020 202045, en
 (31) 201762609847 P (32) 22.12.2017 (33) US
 (54) MULTIVALENT CHIMERIC ANTIGEN RECEPTOR
 (72) POGSON, Mark, 3122 Southeast 16th Street, North Bend, Washington 98045, US

- (51) MKP
A61K 31/427 2006 (97) EP 3727377
A61K 31/4439 2006
 (96) EP 18892459.1 12/19/2018
 (97) EP 3727377, 10/28/2020 202044, en
 (31) 201762608398 P (32) 20.12.2017 (33) US
 (54) PROCESS FOR THE PREPARATION OF PYRIMIDINYL-4-AMINOPYRAZOLE COMPOUNDS
 (72) REMARCHUK, Travis, 161 Oyster Point Blvd South, San Francisco, California 94080, US
 SUDHAKAR, Anantha, 161 Oyster Point Blvd South, San Francisco, California 94080, US

- (51) MKP
A61K 35/17 2015 (97) EP 3730612
A61P 35/00 2006
C07K 14/52 2006
C07K 14/54 2006
C07K 14/705 2006
C07K 19/00 2006
C12N 5/0783 2010
C12N 15/09 2006
 (96) EP 18892953.3 12/19/2018
 (97) EP 3730612, 10/28/2020 202044, en
 (31) 2017247109 (32) 24.12.2017 (33) JP
 (54) IMMUNOCOMPETENT CELL THAT EXPRESSES A CELL SURFACE MOLECULE SPECIFICALLY RECOGNIZING HUMAN MESOTHELIN, IL-7 AND CCL19
 (72) TAMADA, Koji, c/o Yamaguchi University School of Medicine, 1-1, Minamikogushi 1-chome, Ube-shi, Yamaguchi 755-8505, JP
 SAKODA, Yukimi, c/o Yamaguchi University School of Medicine, 1-1, Minamikogushi 1-chome, Ube-shi, Yamaguchi 755-8505, JP
 ADACHI, Keishi, c/o Yamaguchi University School of Medicine, 1-1, Minamikogushi 1-chome, Ube-shi, Yamaguchi 755-8505, JP

(51) MKP
A61K 38/00 2006 (97) EP 3727418
C07K 14/435 2006
C07K 19/00 2006
(96) EP 18893009.3 12/19/2018
(97) EP 3727418, 10/28/2020 202044, en
(31) 201762609275 P (32) 21.12.2017 (33) US
(54) SURFACTANT FORMULATIONS FOR INHALATION
(72) LIPP, Michael, M., 45A Flanagan Drive, Framingham, MA 01710, US
CHAN, Holly, 367 Middle St., Braintree, MA 02148, US

(51) MKP
C07H 21/04 2006 (97) EP 3732187
C07K 14/34 2006
C12N 1/20 2006
C12N 1/21 2006
(96) EP 18895919.1 12/28/2018
(97) EP 3732187, 11/4/2020 202045, en
(31) 201762612062 P (32) 29.12.2017 (33) US
(54) UNNATURAL BASE PAIR COMPOSITIONS AND METHODS OF USE
(72) ROMESBERG, Floyd E., 10550 North Torrey Pines Road, La Jolla, California 92037, US
LEDBETTER, Michael P., 10550 North Torrey Pines Road, La Jolla, California 92037, US
KARADEEMA, Rebekah J., 10550 North Torrey Pines Road, La Jolla, California 92037, US

(51) MKP
C07D 239/47 2006 (97) EP 3732166
C07D 401/10 2006
C07D 401/12 2006
(96) EP 18897512.2 12/26/2018
(97) EP 3732166, 11/4/2020 202045, en
(31) 201762610302 P (32) 26.12.2017 (33) US
(54) PROCESS FOR THE PREPARATION OF AN AMINO-PYRIMIDINE AND INTERMEDIATES THEREOF
(72) PETERSON, Matthew, c/o Cytokinetics, Incorporated 280 East Grand Avenue, South San Francisco, California 94080, US
LU, Kevin, c/o Cytokinetics, Incorporated 280 East Grand Avenue, South San Francisco, California 94080, US
MORGAN, Bradley, c/o Cytokinetics, Incorporated 280 East Grand Avenue, South San Francisco, California 94080, US
MORGANS, David, c/o Cytokinetics, Incorporated 280 East Grand Avenue, South San Francisco, California 94080, US
FUKUYAMA, Tohru, 13-10 Meijjohommachi, Anjo-shi, Aichi 446--0062, JP

(51) MKP
A61K 31/438 2006 (97) EP 3636637
A61P 1/16 2006
C07D 221/20 2006
C07D 401/06 2006
C07D 401/10 2006
C07D 405/06 2006
C07D 405/14 2006
C07D 409/14 2006
C07D 413/06 2006
C07D 413/10 2006
C07D 413/14 2006
(96) EP 19202580.7 10/10/2019
(97) EP 3636637, 11/25/2020 202048, en
(31) 201862744071 P (32) 10.10.2018 (33) US
108136774 09.10.2019 TW
(54) INHIBITING FATTY ACID SYNTHASE (FASN)
(72) Martin, Matthew W., 500 Arsenal Street, Suite 100, Watertown, MA 02472, US
Zablocki, Mary-Margaret, 500 Arsenal Street, Suite 100, Watertown, MA 02472, US
Mente, Scot, 500 Arsenal Street, Suite 100, Watertown, MA 02472, US
Dinsmore, Christopher, 500 Arsenal Street, Suite 100, Watertown, MA 02472, US
Wang, Zhongguo, 500 Arsenal Street, Suite 100, Watertown, MA 02472, US
Zheng, Xiaozhang, 500 Arsenal Street, Suite 100, Watertown, MA 02472, US

(51) MKP
A61P 35/00 2006 (97) EP 3628688
C07K 16/28 2006

(96) EP 19202632.6 3/21/2016
(97) EP 3628688, 11/11/2020 202046, en

(31) 15160292 (32) 23.03.2015 (33) EP

(54) ANTI-CEACAM6 ANTIBODIES AND USES THEREOF
(72) Willuda, Jörg, Staerkstr. 47a, 16548 Glienicke/Nordbahn, DE
Trautwein, Mark, Narzissenweg 4, 42489 Wülfrath, DE
Gritzan, Uwe, Schirmerstraße 20, 50823 Köln, DE
Freiberg, Christoph, Lipkenskothen 10, 42113 Wuppertal, DE
Dittmer, Frank, Sandstr. 4, 40627 Düsseldorf, DE
Schönfeld, Dorian, Constantinstr. 82, 50679 Köln, DE
Glück, Julian Marius, Brenscheidtstr. 5g, 45239 Essen, DE
Pinkert, Jessica, Briller Straße 97, 42105 Wuppertal, DE
Gutierrez, Eva-Maria, Gutenbergstr. 3, 89257 Illertissen, DE
Golfier, Sven, Stölpchenweg 12E, 14109 Berlin, DE
Holton, Simon, Niklasstrasse 14a, 14163 Berlin, DE
Beckhove, Philip, Spitalkellerweg 3, 93059 Regensburg, DE
Ge, Yingzi, Im Finkenschlag 15, 51429 Bergisch Gladbach, DE

(51) MKP
G03G 15/00 2006 (97) EP 3629092

(96) EP 19202685.4 8/26/2016
(97) EP 3629092, 11/11/2020 202046, en

(54) DRUM UNIT, CARTRIDGE, ELECTROPHOTOGRAPHIC IMAGE FORMING APPARATUS AND COUPLING MEMBER
(72) MORI, Tomonori, c/o CANON KABUSHIKI KAISHA 30-2, Shimomaruko 3-chome., Ohta-ku, Tokyo 146-8501, JP
UESUGI, Tetsuo, c/o CANON KABUSHIKI KAISHA 30-2, Shimomaruko 3-chome., Ohta-ku, Tokyo 146-8501, JP

(51) MKP
A01N 25/12 2006 (97) EP 3639666
A01N 37/04 2006
A01N 43/90 2006
A01N 57/12 2006
A01P 7/00 2006

(96) EP 19202718.3 10/11/2019
(97) EP 3639666, 11/25/2020 202048, en

(31) 201830996 (32) 16.10.2018 (33) ES

(54) USE OF LECITHINS AS A BIOCIDES AGAINST ARTHROPODS
(71) Martin Bretones, Germán, Calle Calvario n°19, 04738 Vicar, ES
Ortega Carrasco, Javier Carlos, Calle Mudejar n°2, 04720 Aguadulce, ES
Fernandez Aguilera, Juan Antonio, Calle Sierra de Gador n°9 1°D, 04700 El Ejido, ES
(72) MARTÍN BRETONES, Germán, Calle Calvario n°19, 04738 Vicar, ES
FERNÁNDEZ AGUILERA, Juan Antonio, Calle Sierra de Gador n°9 1°D, 04700 El Ejido, ES

(51) MKP
A61K 39/395 2006 (97) EP 3620175
A61K 47/12 2006
C07K 16/22 2006

(96) EP 19202835.5 5/11/2011
(97) EP 3620175, 10/21/2020 202043, en

(31) 33498610 P (32) 14.05.2010 (33) US

(54) HIGH CONCENTRATION ANTIBODY FORMULATIONS
(71) Amgen Inc., One Amgen Center Drive, Thousand Oaks, CA 91320-1799, US
(72) OSSLUND, Timothy D., 475 Vista Montana, Camarillo, CA California 93010, US

(51) MKP
A61K 39/145 2006 (97) EP 3653701
A61P 31/16 2006
C12N 7/04 2006

(96) EP 19203103.7 3/15/2014

(97) EP 3653701, 12/30/2020 202053, en
 (31) 201361794617 P (32) 15.03.2013 (33) US
 (54) ATTENUATED INFLUENZA VIRUSES AND VACCINES
 (71) The Research Foundation for The State University of New York, 35 State Street,, Albany, New York 12207, US
 (72) MUELLER, Steffen, 7 Gay Drive, Great Neck, NY 11024, US
 WIMMER, Eckard, P.O. Box 11733 17 Childs Lane, East Setauket, NY 11733, US
 FUTCHER, Bruce, 49 Main Street, Setauket, NY 11773, US
 SKIENA, Steven, 6 Storyland Lane, Setauket, NY 11733, US
 YANG, Chen, 79 Morton Blvd., Plainview, NY 11803, US

(51) MKP
A61K 39/00 2006 (97) EP 3656399
A61K 39/395 2006
A61P 3/06 2006
C07K 16/40 2006
 (96) EP 19203125.0 5/3/2013
 (97) EP 3656399, 1/6/2021 202101, en
 (31) 201261642363 P (32) 03.05.2012 (33) US
 (54) STABLE FORMULATIONS CONTAINING ANTI-PCSK9 ANTIBODIES
 (72) CLOGSTON, Christi L., 601 Country View Place, Camarillo, CA 93010, US
 OSSLUND, Timothy David, 475 Vista Montana, Camarillo, CA 93010, US

(51) MKP
G06F 8/60 2018 (97) EP 3640816
G06F 16/28 2019
 (96) EP 19203289.4 10/15/2019
 (97) EP 3640816, 12/2/2020 202049, en
 (31) 201816163204 (32) 17.10.2018 (33) US
 (54) IDENTIFYING APPLICATIONS WITH MACHINE LEARNING
 (71) Servicenow, Inc., 2225 Lawson Lane, Santa Clara, California 95054, US
 (72) BITTERFELD, Robert, c/o ServiceNow, Inc. 2225 Lawson Lane, Santa Clara, CA California 95054, US
 GARTY, Asaf, c/o ServiceNow, Inc. 2225 Lawson Lane, Santa Clara, CA California 95054, US
 ARON, Aviya, c/o ServiceNow, Inc. 2225 Lawson Lane, Santa Clara, CA California 95054, US
 ERBLAT, Boris, c/o ServiceNow, Inc. 2225 Lawson Lane, Santa Clara, CA California 95054, US
 TAL, Hail, c/o ServiceNow, Inc. 2225 Lawson Lane, Santa Clara, CA California 95054, US
 SOLOMON, Bary, c/o ServiceNow, Inc. 2225 Lawson Lane, Santa Clara, CA California 95054, US

(51) MKP
H04L 12/24 2006 (97) EP 3641221
 (96) EP 19203295.1 10/15/2019
 (97) EP 3641221, 12/2/2020 202049, en
 (31) 201816163240 (32) 17.10.2018 (33) US
 (54) IDENTIFYING COMPUTING DEVICES IN A MANAGED NETWORK THAT ARE INVOLVED IN BLOCKCHAIN-BASED MINING
 (72) BADYAN, Daniel, c/o ServiceNow, Inc. 2225 Lawson Lane, Santa Clara, CA California 95054, US
 TAL, Hail, c/o ServiceNow, Inc. 2225 Lawson Lane, Santa Clara, CA California 95054, US
 BITTERFELD, Robert, c/o ServiceNow, Inc. 2225 Lawson Lane, Santa Clara, CA California 95054, US
 GARTY, Asaf, c/o ServiceNow, Inc. 2225 Lawson Lane, Santa Clara, CA California 95054, US
 SOLOMON, Bary, c/o ServiceNow, Inc. 2225 Lawson Lane, Santa Clara, CA California 95054, US

(51) MKP
A61K 9/51 2006 (97) EP 3650047
A61K 39/00 2006
A61K 47/69 2017
A61P 1/00 2006
A61P 11/06 2006
A61P 13/12 2006
A61P 19/06 2006
A61P 25/00 2006
 (96) EP 19204340.4 8/13/2014
 (97) EP 3650047, 12/23/2020 202052, en
 (31) 201361865389 P (32) 13.08.2013 (33) US
 201361869279 P 23.08.2013 US
 201361887112 P 04.10.2013 US

- (54) PEPTIDE CONJUGATED PARTICLES
 (72) SHEA, Lonnie D., 1119 Carl A. Gerstacker Building 2200 Bonisteel Boulevard, Ann Arbor, MI 48109-2099, US
 MILLER, Stephen D., c/o Northwestern University, Evanston, IL 60208, US
 YAP, Jonathon Wood Teck, c/o Northwestern University, Evanston, IL 60208, US
 GETTS, Daniel R., 3303 20th Street N.E., Washington, DC 20018, US
 MCCARTHY, Derrick, c/o Northwestern University, Evanston, IL 60208, US

- (51) MKP
A61K 31/00 2006 (97) EP 3653733
C07K 14/72 2006
C07K 16/28 2006
C12Q 1/6886 2018
 (96) EP 19204705.8 7/26/2013
 (97) EP 3653733, 12/30/2020 202053, en
 (31) 201261676842 P (32) 27.07.2012 (33) US
 201361783763 P 14.03.2013 US
 201361829123 P 30.05.2013 US
 (54) METHODS AND COMPOSITIONS FOR DETERMINING RESISTANCE TO ANDROGEN RECEPTOR THERAPY
 (71) Aragon Pharmaceuticals, Inc., 10990 Wilshire Blvd. Suite 300, Los Angeles, CA 90024, US
 (72) JOSEPH, James David, 10242 Lone Bluff Drive, San Diego, CA 92127, US
 HAGER, Jeffrey H., 13381 Benchley Road, San Diego, CA 92130, US
 SENSINTAFFAR, John, Lee, 12777 Casa Avenida, Poway, CA 92064, US
 LU, Nhin, 3635 Ash Street Unit 4, San Diego, CA 92126, US
 QIAN, Jing, 9456 Compass Point Drive South 8, San Diego, CA 92126, US
 SMITH, Nicholas, D., 1204 Beryl Street, San Diego, CA 92109, US

- (51) MKP
A61K 39/395 2006 (97) EP 3626267
C07K 16/22 2006
 (96) EP 19205429.4 7/3/2013
 (97) EP 3626267, 10/28/2020 202044, en
 (31) 201261668210 P (32) 05.07.2012 (33) US
 201361782072 P 14.03.2013 US
 (54) TREATMENT FOR BONE DISEASES
 (72) ROBINSON, Martyn Kim, Nursery Cottage Harvey Hill Woodburn Green, Buckinghamshire, HP10 0JH, GB

- (51) MKP
A61B 17/32 2006 (97) EP 3626185
A61B 18/14 2006
 (96) EP 19206021.8 12/14/2016
 (97) EP 3626185, 11/4/2020 202045, en
 (31) 201514970778 (32) 16.12.2015 (33) US
 (54) SURGICAL INSTRUMENT WITH FUNCTION SELECTOR
 (72) RIESTENBERG, Paul F., 4545 Creek Road, Cincinnati, OH Ohio 45242, US
 BOYD, Benjamin M., 4545 Creek Road, Cincinnati, OH Ohio 45242, US
 GEE, Jacob S., 4545 Creek Road, Cincinnati, OH Ohio 45242, US
 SCHEIB, Charles J., 4545 Creek Road, Cincinnati, OH Ohio 45242, US
 GALLMEYER, Thomas C., 4545 Creek Road, Cincinnati, OH Ohio 45242, US
 KRAMER, Katelynn, 4545 Creek Road, Cincinnati, OH Ohio 45242, US
 ASHER, Ryan M., 4545 Creek Road, Cincinnati, OH Ohio 45242, US
 MUHLENKAMP, Tylor C., 4545 Creek Road, Cincinnati, OH Ohio 45242, US
 STROBL, Geoffrey S., 4545 Creek Road, Cincinnati, OH Ohio 45242, US
 MONROE, David A., 4545 Creek Road, Cincinnati, OH Ohio 45242, US
 FALLER, Craig N., 4545 Creek Road, Cincinnati, OH Ohio 45242, US

- (51) MKP
A61K 48/00 2006 (97) EP 3628335
 (96) EP 19206348.5 12/6/2013
 (97) EP 3628335, 11/11/2020 202046, en
 (31) 201261734753 P (32) 07.12.2012 (33) US
 (54) LIPIDIC NANOPARTICLES FOR MRNA DELIVERY IN THE LUNGS

(72) DEROSA, Frank, c/o Translate Bio, Inc. 29 Hartwell Avenue, Lexington, MA 02421, US
 HEARTLEIN, Michael, c/o Translate Bio, Inc. 29 Hartwell Avenue, Lexington, MA 02421, US
 GUILD, Braydon, Charles, c/o Translate Bio, Inc. 29 Hartwell Avenue, Lexington, MA 02421, US

(51) MKP
H01M 2/02 2006 (97) EP 3657566
H01M 2/20 2006
H01M 2/30 2006
 (96) EP 19207808.7 11/7/2019
 (97) EP 3657566, 1/6/2021 202101, de
 (31) 102018220184 (32) 23.11.2018 (33) DE
 (54) PLUG DEVICE FOR BATTERY, BATTERY AND MOTOR VEHICLE
 (72) MANAVBASI, Mahmut, Brahmstraße 4, 38226 Salzgitter, DE

(51) MKP
A61K 31/519 2006 (97) EP 3632442
A61K 31/5377 2006
A61P 35/00 2006
 (96) EP 19208523.1 2/28/2014
 (97) EP 3632442, 11/11/2020 202046, en
 (31) 201361771480 P (32) 01.03.2013 (33) US
 (54) USE OF PYRAZOLOPYRIMIDINE DERIVATIVES FOR THE TREATMENT OF PI3K RELATED DISORDERS
 (72) LI, Yun-Long, 1 Pin Oak Drive, Chadds Ford, PA Pennsylvania 19317, US
 YAO, Wenqing, 45 Magnolia Way, Chadds Ford, PA Pennsylvania 19317, US
 COMBS, Andrew P., 329 East Doe Run Road, Kennett Square, PA Pennsylvania 19348, US
 YUE, Eddy W., 9 Altemus Drive, Landenberg, PA Pennsylvania 19350, US
 MEI, Song, 151 Monet Circle, Wilmington, DE Delaware 19808, US
 ZHU, Wenyu, 30 Diemer Drive, Media, PA Pennsylvania 19063, US
 GLENN, Joseph, 103 Deer Horn Drive, Mount Royal, NJ New Jersey 8061, US
 MADUSKUIE, JR., Thomas P., c/o Incyte Corporation 1801 Augustine Cut-Off, Wilmington, DE Delaware 19803, US
 SPARKS, Richard B., 3316 Englewood Road, Wilmington, DE Delaware 19810, US
 DOUTY, Brent, 3420 Strasburg Road East, Fallowfield, PA Pennsylvania 19320, US
 HE, Chunhong, 40 Magnolia Way, Chadds Ford, PA Pennsylvania 19317, US

(51) MKP
A61K 31/513 2006 (97) EP 3656384
A61P 31/18 2006
 (96) EP 19210167.3 10/7/2013
 (97) EP 3656384, 1/6/2021 202101, en
 (31) PCT/CN2012/001358 (32) 08.10.2012 (33) WO
 (54) COMBINATIONS COMPRISING 5-PHOXY-3H-PYRIMIDIN-4-ONE DERIVATIVES AND THEIR USE FOR THE PROPHYLAXIS OR TREATMENT OF INFECTION BY HIV
 (72) Arrington, Kenneth L., 770 Sumneytown Pike, West Point, Pennsylvania 19486, US
 Burgey, Christopher, 770 Sumneytown Pike, Westpoint, Pennsylvania 19486, US
 Gilfillan, Robert, 770 Sumneytown Pike, Westpoint, Pennsylvania 19486, US
 Han, Yongxin, 2F No. 10 Building, Landscape No. 88 Darwin Road Zhangjiang High-tech Park, Pudong New District, Shanghai 201203, CN
 Patel, Mehul, 770 Sumneytown Pike, West Point, Pennsylvania 19486, US
 Li, Chun Sing, 288 Fute Zhong Road, Waigaoqiao Free Trade Zone, Shanghai 200131, CN
 Li, Yaozong, 288 Fute Zhong Road, Waigaoqiao Free Trade Zone, Shanghai 200131, CN
 Luo, Yunfu, 288 Fute Zhong Road, Waigaoqiao Free Trade Zone, Shanghai 200131, CN
 Xu, Jiayi, 126 East Lincoln Avenue, Rahway, New Jersey 07065-0907, US

(51) MKP
F17C 13/04 2006 (97) EP 3660381
 (96) EP 19210220.0 10/28/2015
 (97) EP 3660381, 1/6/2021 202101, de
 (31) 14192891 (32) 12.11.2014 (33) EP
 (54) FITTING FOR LIQUEFIED GAS BOTTLES AND FILLING METHOD
 (72) Tilhof, Eckhard, Churerstrasse 31, 8852 Altendorf, CH

(51) MKP
H02S 20/00 2014 (97) EP 3661050

(96) EP 19210413.1 11/20/2019
 (97) EP 3661050, 1/6/2021 202101, de
 (31) 102018220622 (32) 29.11.2018 (33) DE
 (54) SUBSTRUCTURE FOR SOLAR MODULES IN FRAMES AND MODULE CLAMP FOR MOUNTING SOLAR MODULES IN FRAMES ON A MODULE SUPPORT
 (71) Hephaistos Solar GmbH, Max-Eyth-Strasse 8, 75443 Ötisheim, DE
 (72) Wettach, Alfred W., Max-Eyth-Straße 8, 75443 Ötisheim, DE

(51) MKP
A61K 39/155 2006 (97) EP 3656396
 (96) EP 19211547.5 3/15/2013
 (97) EP 3656396, 1/6/2021 202101, en
 (31) 201261678367 P (32) 01.08.2012 (33) US
 12005594 01.08.2012 EP
 (54) RECOMBINANT MODIFIED VACCINIA VIRUS ANKARA (MVA) RESPIRATORY SYNCYTIAL VIRUS (RSV) VACCINE
 (72) Steigerwald, Robin, Bavarian Nordic GmbH Klenzestrasse 97, 80469 Munich, DE
 Cheminay, Cédric, Bavarian Nordic GmbH Netzerstrasse 39B, 80992 Munich, DE
 Chaplin, Paul, Springdamvej 5, 2820 Gentofte, DK

(51) MKP
A01K 67/027 2006 (97) EP 3636073
A61K 49/00 2006
C07K 14/47 2006
C12N 15/85 2006
 (96) EP 19211905.5 5/4/2015
 (97) EP 3636073, 11/11/2020 202046, en
 (31) 201461988581 P (32) 05.05.2014 (33) US
 201462067836 P 23.10.2014 US
 (54) HUMANIZED C5 AND C3 ANIMALS
 (72) HU, Ying, 777 Old Saw Mill River Road, Tarrytown, NY 10591, US
 LATUSZEK, Adrianna, 777 Old Saw Mill River Road, Tarrytown, NY 10591, US
 CAO, Jingtai, 777 Old Saw Mill River Road, Tarrytown, NY 10591, US
 MUJICA, Alexander, 777 Old Saw Mill River Road, Tarrytown, NY 10591, US
 WIEGAND, Stanley, 777 Old Saw Mill River Road, Tarrytown, NY 10591, US
 MCWHIRTER, John, 777 Old Saw Mill River Road, Tarrytown, NY 10591, US
 MURPHY, Andrew, 777 Old Saw Mill River Road, Tarrytown, NY 10591, US
 MACDONALD, Lynn, 777 Old Saw Mill River Road, Tarrytown, NY 10591, US
 MEAGHER, Karolina, 211 Benjamin Boulevard, Yorktown Heights, NY 10598, US

(51) MKP
A61K 39/395 2006 (97) EP 3653225
C07K 16/28 2006
 (96) EP 19212188.7 8/10/2015
 (97) EP 3653225, 12/23/2020 202052, en
 (31) 201562152708 P (32) 24.04.2015 (33) US
 (54) METHODS FOR TREATING OR PREVENTING MIGRAINE HEADACHE USING ANTIBODIES DIRECTED AT THE CGRP RECEPTOR
 (72) HONG, Sun, One Amgen Cener Drive Mail Stop 28-5-A, Thousands Oaks, CA 91320-1799, US
 DUNAYEVICH, Eduardo, c/o Amgen Inc. Law Dept - Patent Operations One Amgen Center Drive Mail Stop 28-5-A, Thousands Oaks, CA 91320-1799, US
 LENZ, Robert A., c/o Amgen Inc. Law Dept - Patent Operations One Amgen Center Drive Mail Stop 28-5-A, Thousands Oaks, CA 91320-1799, US
 VARGAS, Gabriel, c/o Amgen Inc. Law Dept - Patent Operations One Amgen Center Drive Mail Stop 28-5-A, Thousands Oaks, CA 91320-1799, US

(51) MKP
C07K 16/28 2006 (97) EP 3699195
C07K 16/30 2006
C07K 16/46 2006
 (96) EP 19213494.8 3/30/2015
 (97) EP 3699195, 11/4/2020 202045, en
 (31) 201461972172 P (32) 28.03.2014 (33) US
 201462025931 P 17.07.2014 US
 201462025974 P 17.07.2014 US

(54) BISPECIFIC ANTIBODIES THAT BIND TO CD38 AND CD3
 (72) BERNETT, Matthew, J., 258 W. Atara St., Monrovia, CA 91016, US
 CHU, Seung, Y., 4613 Larwin Avenue, Cypress, California 90630, US
 MOORE, Gregory, 915N Lantana Way, Azusa, CA 91702, US
 DESJARLAIS, John, 1030 North Michigan Avenue, Pasadena, California 91104, US

(51) MKP
C07D 401/14 2006 (97) EP 3660011
 (96) EP 19213615.8 3/6/2014
 (97) EP 3660011, 12/16/2020 202051, en
 (31) 201361773706 P (32) 06.03.2013 (33) US
 201361776260 P 11.03.2013 US
 201361784909 P 14.03.2013 US
 (54) BENZOIMIDAZOL-2-YL PYRIMIDINE MODULATORS OF THE HISTAMINE H4 RECEPTOR
 (72) HICKEY, Magali, B., 440 Pond Street, Westwood, Massachusetts 02090, US
 HORNS, Stefan, J.J. Wepferstr 5, CH-8200 Schaffhausen,, CH
 LOCHNER, Susanne, Welschenkahl 5, 95359 Kasendorf, DE
 CONZA, Matteo, Büttenweg 8, 8240 Thayngen,, CH

(51) MKP
A61K 9/16 2006 (97) EP 3656379
A61K 9/28 2006
A61K 31/225 2006
 (96) EP 19217154.4 12/5/2014
 (97) EP 3656379, 1/6/2021 202101, en
 (31) 13382504 (32) 12.12.2013 (33) EP
 (54) PHARMACEUTICAL COMPOSITIONS COMPRISING DIMETHYL FUMARATE
 (72) PLANELLS JIMENEZ, Maria, Laurea Miro 408-410 Sant Feliu de Llobregat, E-08980 Barcelona, ES
 DUARTE LOPEZ, Begoña, Laurea Miro 408-410 Sant Feliu de Llobregat, E-08980 Barcelona, ES
 GUIRO COLL, Pere, Laurea Miro 408-410 Sant Feliu de Llobregat, E-08980 Barcelona, ES

(51) MKP
A61K 39/35 2006 (97) EP 3660047
A61P 37/08 2006
C07K 16/18 2006
 (96) EP 19218187.3 5/2/2013
 (97) EP 3660047, 1/6/2021 202101, en
 (31) 201261642083 P (32) 03.05.2012 (33) US
 201261718044 P 24.10.2012 US
 201361783312 P 14.03.2013 US
 (54) HUMAN ANTIBODIES TO FEL D1 AND METHODS OF USE THEREOF
 (72) ORENGO, Jamie, 17 Maple Moore Lane, Cortlandt Manor, NY 10567, US
 MURPHY, Andrew J., 10 Newton Court, Croton-on-Hudson, NY 10520, US

(51) MKP
A61K 39/00 2006 (97) EP 3685855
A61K 39/395 2006
A61K 45/06 2006
A61P 35/00 2006
C07K 16/28 2006
 (96) EP 19219850.5 10/7/2013
 (97) EP 3685855, 12/9/2020 202050, en
 (31) 201261710420 P (32) 05.10.2012 (33) US
 (54) HUMAN ANTI-VEGFR-2/KDR ANTIBODIES
 (72) ZHU, Zhenping, 19 Mulholland Drive, Woodcliff Lake, NJ 07677, US
 LU, Dan, 24 Olde Woods Lane, Montvale, NJ 07645, US
 POLONSKAYA, Zhanna, 234 Central Avenue, Mountainside, NJ 07092, US

(51) MKP
A61K 31/192 2006 (97) EP 3713554
A61P 29/00 2006
 (96) EP 18803724.6 11/22/2018

(97) EP 3713554, 9/30/2020 202040, en
 (31) 17203407 (32) 23.11.2017 (33) EP
 (54) DOSAGE REGIMEN OF VIDOFLUDIMUS FOR USE IN THE PREVENTION OR TREATMENT OF CHRONIC INFLAMMATORY AND/OR AUTOIMMUNE DISEASES
 (71) Immunic AG, Lochhamer Schlag 21, 82166 Gräfelfing, DE
 (72) GRÖPPEL, Manfred, Sauerbruchstrasse 54A, 81377 Munich, DE
 VITT, Daniel, Obere Bahnhofstrasse 7A, 82110 Germering, DE
 KOHLHOF, Hella, Stöhrstrasse 11, 81477 Munich, DE
 MÜHLER, Andreas, Krüner Strasse 37, 81373 Munich, DE

(51) MKP
G09F 3/02 2006 (97) EP 3714449
G09F 3/10 2006
 (96) EP 18804133.9 10/25/2018
 (97) EP 3714449, 9/30/2020 202040, en
 (31) 201700132331 (32) 20.11.2017 (33) IT
 (54) LABEL AND MANUFACTURING METHOD
 (71) PILOT ITALIA S.p.A., Vicolo Santa Maria alla Porta, 1, 20123 Milano, IT
 (72) VIMERCATI, Giancarlo, Via Ravizza 13, 20149 Milano, IT

(51) MKP
B21B 21/00 2006 (97) EP 3717143
 (96) EP 18804581.9 11/15/2018
 (97) EP 3717143, 10/7/2020 202041, de
 (31) 102017221126 (32) 27.11.2017 (33) DE
 (54) ROLL STAND
 (71) SMS Group GmbH, Eduard-Schloemann-Str. 4, 40237 Düsseldorf, DE
 (72) BAENSCH, Michael, Äquatorweg 12, 41749 Viersen, DE
 THOME, Verena, Albrecht-Dürer-Straße 14, 47877 Willich, DE

(51) MKP
A63H 33/08 2006 (97) EP 3717088
E04B 2/08 2006
E04H 9/02 2006
 (96) EP 18807133.6 10/30/2018
 (97) EP 3717088, 10/7/2020 202041, en
 (31) 201700137660 (32) 30.11.2017 (33) IT
 (54) KIT FOR CONSTRUCTING DRY-MOUNTED WALLS
 (71) Perusi, Massimo, Via Udine 15, 37135 Verona, IT
 (72) Perusi, Massimo, Via Udine 15, 37135 Verona, IT

(51) MKP
A61K 31/381 2006 (97) EP 3717486
A61P 31/16 2006
C07D 487/04 2006
C07D 495/04 2006
C07D 513/04 2006
C07D 519/00 2006
 (96) EP 18807356.3 11/28/2018
 (97) EP 3717486, 10/7/2020 202041, en
 (31) 17204280 (32) 29.11.2017 (33) EP
 (54) PYRAZOLOPYRIMIDINES HAVING ACTIVITY AGAINST THE RESPIRATORY SYNCYTIAL VIRUS (RSV)
 (72) LANÇOIS, David Francis Alain, c/o Janssen-Cilag 1 rue Camille Desmoulins TSA 91003, 92787 Issy-les-Moulineaux Cedex 9, FR
 GUILLEMONT, Jérôme Émile Georges, c/o Janssen-Cilag 1 rue Camille Desmoulins TSA 91003, 92787 Issy-les-Moulineaux Cedex 9, FR
 RABOISSON, Pierre Jean-Marie Bernard, Avenue Denis Diderot 5, 1300 Wavre, BE
 ROYMANS, Dirk André Emmy, c/o Janssen Pharmaceutica NV Turnhoutseweg 30, 2340 Beerse, BE
 RIGAUX, Peter, c/o Janssen Pharmaceutica NV Turnhoutseweg 30, 2340 Beerse, BE
 MICHAUT, Antoine Benjamin, c/o NovAliX SAS BioParc Boulevard Sébastien Brant BP 30170, 67405 Illkirch Cedex, FR
 MERCEY, Guillaume Jean Maurice, c/o Janssen-Cilag 1 rue Camille Desmoulins TSA 91003, 92787 Issy-les-Moulineaux Cedex 9, FR

(51) MKP

A61K 9/20 2006 (97) EP 3607938
A61K 9/48 2006
A61K 9/50 2006
A61K 31/198 2006
A61K 45/06 2006
A61K 47/58 2017
 (96) EP 19176943.9 4/5/2012
 (97) EP 3607938, 12/2/2020 202049, en
 (31) 11161398 (32) 06.04.2011 (33) EP
 (54) PHARMACEUTICAL COMPOSITION
 (72) Sovic Brkicic, Ljiljana, Kralja Zvonimira 82, 10000 Zagreb, HR
 Dokuzovic, Zdravko, Zelengaj 37a, 10000 Zagreb, HR

(51) MKP
G03G 15/00 2006 (97) EP 3633461
G03G 15/08 2006
G03G 21/16 2006
G03G 21/18 2006
 (96) EP 19178941.1 2/26/2016
 (97) EP 3633461, 11/18/2020 202047, en
 (31) 2015039432 (32) 27.02.2015 (33) JP
 2016023071 09.02.2016 JP
 (54) DRUM UNIT, CARTRIDGE AND COUPLING MEMBER
 (72) UESUGI, Tetsuo, c/o CANON KABUSHIKI KAISHA 30-2, Shimomaruko 3-chome, Ohta-ku., Tokyo, 146-8501, JP
 HAYASHIDA, Makoto, c/o CANON KABUSHIKI KAISHA 30-2, Shimomaruko 3-chome, Ohta-ku., Tokyo, 146-8501, JP
 YAMAGUCHI, Koji, c/o CANON KABUSHIKI KAISHA 30-2, Shimomaruko 3-chome, Ohta-ku., Tokyo, 146-8501, JP
 YANO, Takashi, c/o CANON KABUSHIKI KAISHA 30-2, Shimomaruko 3-chome, Ohta-ku., Tokyo, 146-8501, JP

(51) MKP
C07C 51/16 2006 (97) EP 3587400
C07C 67/30 2006
C07C 67/39 2006
C07D 213/61 2006
C07D 213/89 2006
 (96) EP 19183016.5 10/17/2014
 (97) EP 3587400, 10/21/2020 202043, en
 (31) 13189784 (32) 22.10.2013 (33) EP
 (54) PROCESS FOR THE PREPARATION OF A PDE4 INHIBITOR
 (72) FALCHI, Alessandro, c/o CHIESI FARMACEUTICI S.p.A. Via Palermo, 26/A, 43100 PARMA, IT
 LUTERO, Emilio, c/o CHIESI FARMACEUTICI S.p.A. Via Palermo, 26/A, 43100 PARMA, IT
 FERRARI, Emanuele, c/o CHIESI FARMACEUTICI S.p.A. Via Palermo, 26/A, 43100 PARMA, IT
 PIVETTI, Fausto, c/o CHIESI FARMACEUTICI S.p.A. Via Palermo, 26/A, 43100 PARMA, IT
 BUSSOLATI, Rocco, c/o CHIESI FARMACEUTICI S.p.A. Via Palermo, 26/A, 43100 PARMA, IT
 MARIANI, Edoardo, c/o CHIESI FARMACEUTICI S.p.A. Via Palermo, 26/A, 43100 PARMA, IT
 VECCHI, Orsola, c/o CHIESI FARMACEUTICI S.p.A. Via Palermo, 26/A, 43100 PARMA, IT
 BAPPERT, Erhard, c/o CHIESI FARMACEUTICI S.p.A. Via Palermo, 26/A, 43100 PARMA, IT
 VENTRICI, Caterina, c/o CHIESI FARMACEUTICI S.p.A. Via Palermo, 26/A, 43100 PARMA, IT

(51) MKP
A61K 31/404 2006 (97) EP 3617192
A61P 31/14 2006
C07D 209/14 2006
C07D 401/08 2006
C07D 401/12 2006
C07D 401/14 2006
C07D 403/08 2006
C07D 403/10 2006
C07D 403/12 2006
C07D 405/12 2006
C07D 409/08 2006
C07D 409/12 2006
C07D 413/08 2006
C07D 413/12 2006
C07D 417/14 2006

	C07D 471/04	2006					
	C07D 487/04	2006					
	C07D 495/04	2006					
	C07D 498/04	2006					
	C07D 513/04	2006					
(96)	EP 19183201.3 9/26/2012						
(97)	EP 3617192, 10/7/2020 202041, en						
(31)	201116559		(32)	26.09.2011		(33)	GB
	201161626410 P			26.09.2011			US
(54)	VIRAL REPLICATION INHIBITORS						
(72)	BARDIOT, Dorothée, c/o Waaistraat 6 box 5105, 3000 Leuven, BE						
	CARLENS, Gunter, c/o Waaistraat 6 box 5105, 3000 Leuven, BE						
	DALLMEIER, Kai, c/o Waaistraat 6 box 5105, 3000 Leuven, BE						
	KAPTEIN, Suzanne, c/o Waaistraat 6 box 5105, 3000 Leuven, BE						
	McNAUGHTON, Michael, c/o Waaistraat 6 box 5105, 3000 Leuven, BE						
	MARCHAND, Arnaud, c/o Waaistraat 6 box 5105, 3000 Leuven, BE						
	NEYTS, Johan, c/o Waaistraat 6 box 5105, 3000 Leuven, BE						
	SMETS, Wim, c/o Waaistraat 6 box 5105, 3000 Leuven, BE						
	KOUKNI, Mohamed, c/o Waaistraat 6 box 5105, 3000 Leuven, BE						
<hr/>							
(51)	MKP						
	A61K 39/395	2006	(97)	EP 3620467			
	A61P 35/00	2006					
	A61P 35/02	2006					
	C07K 16/28	2006					
(96)	EP 19183557.8 3/11/2011						
(97)	EP 3620467, 10/14/2020 202042, en						
(31)	31362810 P		(32)	12.03.2010		(33)	US
	32731410 P			23.04.2010			US
	41264410 P			11.11.2010			US
(54)	CD37-BINDING MOLECULES AND IMMUNOCONJUGATES THEREOF						
(72)	Deckert, Jutta, 16 Eaton Road, Lexington, MA 02420, US						
	Park, Peter, 25 Webster Avenue, 301, Somerville, MA 02143, US						
	Tavares, Daniel, 27 Sylvester Road, Natick, MA 01760, US						
	Rui, Lingyun, 11 Arrowhead Road, Weston, MA 02493, US						
<hr/>							
(51)	MKP						
	C07K 1/22	2006	(97)	EP 3728288			
(96)	EP 18842505.2 12/20/2018						
(97)	EP 3728288, 10/28/2020 202044, en						
(31)	201762609214 P		(32)	21.12.2017		(33)	US
	201862694387 P			05.07.2018			US
(54)	METHODS FOR ENHANCED REMOVAL OF IMPURITIES DURING PROTEIN A CHROMATOGRAPHY						
(72)	BEIGIE, Carl A., c/o Sanofi 55 Corporate Drive Mail Code: 55A-525, Bridgewater, New Jersey 08807, US						
<hr/>							
(51)	MKP						
	C12N 9/22	2006	(97)	EP 3724342			
	C12N 15/113	2010					
	C12N 15/90	2006					
(96)	EP 18842645.6 12/14/2018						
(97)	EP 3724342, 10/21/2020 202043, en						
(31)	201762598682 P		(32)	14.12.2017		(33)	US
	201862670378 P			11.05.2018			US
	201862675306 P			23.05.2018			US
	201862693100 P			02.07.2018			US
(54)	MATERIALS AND METHODS FOR TREATMENT OF AUTOSOMAL DOMINANT CONE-ROD DYSTROPHY						
(72)	TAKEUCHI, Ryo, 610 Main Street North Building, 5th Floor, Cambridge, Massachusetts 02139, US						
	NOMA, Akiko, 610 Main Street North Building, 5th Floor, Cambridge, Massachusetts 02139, US						
	HE, Shuying, 610 Main Street North Building, 5th Floor, Cambridge, Massachusetts 02139, US						
	SCARIA, Abraham, 610 Main Street North Building, 5th Floor, Cambridge, Massachusetts 02139, US						
<hr/>							
(51)	MKP						

A61P 27/02 2006 (97) EP 3728594
C12N 15/113 2010
 (96) EP 18842660.5 12/21/2018
 (97) EP 3728594, 10/28/2020 202044, en
 (31) 201762609333 P (32) 21.12.2017 (33) US
 201862746226 P 16.10.2018 US
 (54) MATERIALS AND METHODS FOR TREATMENT OF USHER SYNDROME TYPE 2A
 (72) KANTARDZHIEVA, Albena, 610 Main Street North Building, 5th Floor, Cambridge, Massachusetts 02139, US
 NOMA, Akiko, 610 Main Street North Building, 5th Floor, Cambridge, Massachusetts 02139, US
 SCARIA, Abraham, 610 Main Street North Building, 5th Floor, Cambridge, Massachusetts 02139, US

(51) MKP
A61P 27/02 2006 (97) EP 3728595
C12N 15/113 2010
 (96) EP 18842661.3 12/21/2018
 (97) EP 3728595, 10/28/2020 202044, en
 (31) 201762609334 P (32) 21.12.2017 (33) US
 (54) MATERIALS AND METHODS FOR TREATMENT OF USHER SYNDROME TYPE 2A AND/OR NON-SYNDROMIC AUTOSOMAL RECESSIVE
 RETINITIS PIGMENTOSA (ARRP)
 (71) Bayer HealthCare LLC, 100 Bayer Boulevard, Whippany, NJ 07981, US
 (72) ALLOCCA, Mariacarmela, 610 Main Street North Building, 5th Floor, Cambridge, Massachusetts 02139, US
 NOMA, Akiko, 610 Main Street North Building, 5th Floor, Cambridge, Massachusetts 02139, US
 SCARIA, Abraham, 610 Main Street North Building, 5th Floor, Cambridge, Massachusetts 02139, US

(51) MKP
A61K 38/17 2006 (97) EP 3733196
A61P 29/00 2006
C07K 14/47 2006
 (96) EP 18845399.7 12/21/2018
 (97) EP 3733196, 11/4/2020 202045, en
 (31) 20170176 (32) 29.12.2017 (33) CU
 (54) PHARMACEUTICAL COMPOSITION COMPRISING AN APL PEPTIDE
 (72) DOMÍNGUEZ HORTA, María del Carmen, Calle 186, No. 3112-A, apto 02, entre 31-A y 31-B, Cubanacán, Playa La Habana 11600, CU
 LOPEZ ABAD, Cruz Matilde, Calle 186, No 3115, piso 9, apto I, entre 31 y 33, Playa La Habana 11600, CU
 GONZÁLEZ LÓPEZ, Luis Javier, Calle 186 No. 3115, piso 8, apto C, entre 31 y 33, Playa La Habana 11600, CU
 BESADA PÉREZ, Vladimir Armando, Ave 33, Edif. C15, apto 3 entre 186 y 188, Playa La Habana 11600, CU

(51) MKP
A61K 39/245 2006 (97) EP 3728291
A61K 39/295 2006
C07K 14/05 2006
 (96) EP 18845444.1 12/14/2018
 (97) EP 3728291, 10/28/2020 202044, en
 (31) 201762608038 P (32) 20.12.2017 (33) US
 (54) EPSTEIN-BARR VIRUS ANTIGEN CONSTRUCTS
 (72) CAPONE, Stefania, Via di Castel Romano 100, 00128 Rome, IT
 FOLGORI, Antonella, Via di Castel Romano 100, 00128 Rome, IT
 LAHM, Armin, Via di Castel Romano 100, 00128 Rome, IT
 WIZEL, Benjamin, 14200 Shady Grove Road, Rockville, Maryland 20850, US

(51) MKP
A61K 31/11 2006 (97) EP 3731933
A61P 31/12 2006
C07C 43/20 2006
C07C 47/57 2006
C07C 69/736 2006
C07C 243/18 2006
C07C 245/12 2006
C07C 251/24 2006
C07C 309/13 2006
C07D 207/14 2006
C07D 211/60 2006

C07D 213/74 2006
C07D 215/38 2006
(96) EP 18845453.2 12/25/2018
(97) EP 3731933, 11/4/2020 202045, en
(31) 2017145952 (32) 26.12.2017 (33) RU
(54) ASYMMETRIC DERIVATIVES OF POLYPHENOLS OF THE DINAPHTHALINE SERIES, PROCESS OF PREPARING AND USE THEREOF
(71) Nearmedic International Limited, Themistokli Dervi, 5 Elenion Building, 2nd floor, 1066 Nicosia, CY
(72) NESTERENKO, Vladimir Georgievich, Kamergersky per., 2-35, Moscow, 125009, RU
SUSLOV, Anatoly Petrovich, ul. Berzarina, 28A-3-118, Moscow, 123060, RU
TSYRULNIKOV, Sergey Alexandrovich, ul. Generala Glagoleva, 30-4-497, Moscow, 123154, RU
NENASHEV, Mikhail Nikolaevich, ul. Mitinskaya, 40-1-197, Moscow, 125430, RU
KISELEVA, Irina Vladislavovna, ul. Molodezhnaya, 8-116 Moscow reg. Odintsovsky r-n, Lesnoy Gorodok dp, 143080, RU
KUZNETSOV, Vitaly Vladimirovich, ul. Klyazminskaya, 4-30, Moscow, 125412, RU

(51) MKP
A61K 39/00 2006 (97) EP 3720480
C12N 5/0783 2010
(96) EP 18847259.1 12/7/2018
(97) EP 3720480, 10/14/2020 202042, en
(31) 201762596775 P (32) 08.12.2017 (33) US
201862643165 P 14.03.2018 US
201862657716 P 13.04.2018 US
201862716967 P 09.08.2018 US
(54) PHENOTYPIC MARKERS FOR CELL THERAPY AND RELATED METHODS
(72) LARSON, Ryan P., 400 Dexter Ave. N Suite 1200, Seattle Washington 98109, US
YOST, Rachel K., 400 Dexter Ave. N Suite 1200, Seattle Washington 98109, US
HAUSE, Ronald James Jr., 400 Dexter Ave. N Suite 1200, Seattle Washington 98109, US
YEE, Nathan K., 400 Dexter Ave. N Suite 1200, Seattle Washington 98109, US
SUTHERLAND, Claire L., 400 Dexter Ave. N Suite 1200, Seattle Washington 98109, US
RAMSBORG, Christopher Glen, 400 Dexter Ave. N Suite 1200, Seattle Washington 98109, US
DEVRIES, Todd, 400 Dexter Ave. N Suite 1200, Seattle Washington 98109, US
DAVE, Kedar Himanshu, 400 Dexter Ave. N Suite 1200, Seattle Washington 98109, US

(51) MKP
C25B 1/08 2006 (97) EP 3732316
C25B 9/18 2006
C25B 9/20 2006
C25B 15/02 2006
(96) EP 18852799.8 12/24/2018
(97) EP 3732316, 11/4/2020 202045, en
(31) MP20171356 U (32) 29.12.2017 (33) RS
(54) MODULAR DEVICE AND PROCEDURE FOR PRODUCING REPRODUCIBLE QUALITY HYDROGEN AND OXYGEN GASES
(71) Mocevic, Vojin, Doza Djerdja 57/2, 21000 Novi Sad, RS
(72) Mocevic, Vojin, Doza Djerdja 57/2, 21000 Novi Sad, RS

(51) MKP
A61K 51/04 2006 (97) EP 3717025
A61K 101/00 2006
A61K 101/02 2006
C07B 59/00 2006
C07D 491/048 2006
(96) EP 18811010.0 11/27/2018
(97) EP 3717025, 10/7/2020 202041, en
(31) 17204896 (32) 01.12.2017 (33) EP
(54) IMAGING AGENTS
(72) MERCIER, Joël, c/o IPD UCB Biopharma SPRL Allée de la Recherche 60, 1070 Brussels, BE
VALADE, Anne, c/o IP Department UCB Biopharma SPRL 60 Allée de la Recherche, 1070 Brussels, BE
VERMEIREN, Celine, c/o IP Department 60 Allée de la Recherche, 1070 Brussels, BE
WOOD, Martyn, c/o IPD UCB Biopharma SPRL Allée de la Recherche 60, Brussels 1070, BE
MAGUIRE, Ralph, c/o IPD UCB Biopharma SPRL Allée de la Recherche 60, 1070 Brussels, BE

(51) MKP

A61K 31/185 2006 (97) EP 3720428
A61P 27/02 2006
 (96) EP 18811023.3 11/29/2018
 (97) EP 3720428, 10/14/2020 202042, en
 (31) 17382832 (32) 04.12.2017 (33) EP
 (54) OPHTHALMIC TOPICAL COMPOSITION COMPRISING DOBESILIC ACID FOR TREATING DISEASES OF THE POSTERIOR SEGMENT OF THE EYE
 (72) CAPDEVILA NORTES, Xavier, C. Gall 30-36, 08950 Esplugues De Llobregat, ES
 SANAGUSTÍN AQUILUÉ, Javier, C. Gall 30-36, 08950 Esplugues De Llobregat, ES
 DELGADO GAÑÁN, Maria Isabel, C. Gall 30-36, 08950 Esplugues De Llobregat, ES

(51) MKP
A61K 31/433 2006 (97) EP 3724198
A61P 25/08 2006
C07D 513/04 2006
 (96) EP 18811038.1 12/4/2018
 (97) EP 3724198, 10/21/2020 202043, en
 (31) 17206684 (32) 12.12.2017 (33) EP
 (54) 2-OXO-1-PYRROLIDINYL IMIDAZOTHIADIAZOLE DERIVATIVES
 (72) PROVINS, Laurent, c/o IPD UCB Biopharma SPRL Allée de la Recherche 60, 1070 Brussels, BE
 CHANTEUX, Hugues, c/o IP Department UCB Biopharma SPRL Allée de la Recherche 60, 1070 Brussels, BE

(51) MKP
A61K 31/4245 2006 (97) EP 3720851
A61P 9/00 2006
A61P 25/00 2006
A61P 31/00 2006
C07D 413/14 2006
 (96) EP 18811280.9 12/5/2018
 (97) EP 3720851, 10/14/2020 202042, en
 (31) 17382835 (32) 05.12.2017 (33) EP
 18382562 26.07.2018 EP
 (54) 1,2,4-OXADIAZOLE DERIVATIVES AS HISTONE DEACETYLASE 6 INHIBITORS
 (72) CARCELLER GONZÁLEZ, Elena, Oryzon Genomics S.A. Sant Ferran 74, 08940 Cornellà de Llobregat, ES
 ORTEGA MUÑOZ, Alberto, Oryzon Genomics S.A. Sant Ferran 74, 08940 Cornellà de Llobregat, ES
 SALAS SOLANA, Jorge, Oryzon Genomics S.A. Sant Ferran 74, 08940 Cornellà de Llobregat, ES

(51) MKP
A61K 9/00 2006 (97) EP 3716944
A61K 9/06 2006
A61K 31/192 2006
A61K 47/40 2006
 (96) EP 18811502.6 11/28/2018
 (97) EP 3716944, 10/7/2020 202041, en
 (31) 17204585 (32) 30.11.2017 (33) EP
 (54) STABLE LIQUID COMPOSITION OF KETOPROFEN, SALTS AND ENANTIOMERS THEREOF
 (72) D'AMICO, Danilo, Via Aldo Moro, 86072 Cerro al Volturno (IS), IT
 MARCHITTO, Leonardo, Via Cesare Peruzzi 34, 62017 Porto Recanati (MC), IT
 RAGNI, Lorella, Via Tommasi 17, 60033 Chiaravalle (AN), IT
 DONATI, Luca, Via Tiziano Vecellio 1, 63017 Porto San Giorgio (AP), IT
 RUSSO, Vincenzo, Via Aurelio Saffi 64/A, 04011 Aprilia (LT), IT

(51) MKP
A61K 31/337 2006 (97) EP 3717007
A61K 39/395 2006
A61P 35/00 2006
A61P 37/04 2006
C07K 16/28 2006
 (96) EP 18811506.7 11/28/2018
 (97) EP 3717007, 10/7/2020 202041, en
 (31) 201762592913 P (32) 30.11.2017 (33) US
 (54) ILDR2 ANTAGONISTS AND COMBINATIONS THEREOF
 (71) Compugen Ltd., 26 Harokmim Street Building D, 5885800 Holon, IL

(72) RÖSE, Lars, Fuchsring 82, 13465 Berlin, DE
 GRITZAN, Uwe, Schirmerstraße 20, 50823 Köln, DE
 HÜTTER, Julia, Ebelingstr. 4, 10249 Berlin, DE
 LIANG, Spencer, 3315 Countryside Dr, San Mateo CA 94403, US
 POW, Andrew, 3 Littles Brook Court Apt. 69, Burlington MA 01803, US
 HUNTER, John, 51 Maxwellton Road, Piedmont CA 94618, US
 LEVY, Ofer, 182 Har Yeela St., 99770 Moshav Mesilat Zion Doar Na Shimson, IL
 VAKNIN, Ilan, 19/2 Reuven St., 7172602 Modiin-Maccabim-Reut, IL

(51) MKP
A61K 31/437 2006 (97) EP 3720440
A61K 31/519 2006
A61P 11/00 2006
A61P 31/14 2006

(96) EP 18811555.4 12/4/2018

(97) EP 3720440, 10/14/2020 202042, en

(31) 17205428 (32) 05.12.2017 (33) EP

(54) TREATMENT OF RSV WITH COMBINATION PRODUCT

(72) YSEBAERT, Nina, c/o Janssen Pharmaceutica NV Turnhoutseweg 30, 2340 Beerse, BE
 GOEYVAERTS, Nele Isa E., c/o Janssen Pharmaceutica NV Turnhoutseweg 30, 2340 Beerse, BE
 ROYMANS, Dirk André Emmy, c/o Janssen Pharmaceutica NV Turnhoutseweg 30, 2340 Beerse, BE
 KOUL, Anil, c/o Janssen Pharmaceutica NV Turnhoutseweg 30, 2340 Beerse, BE

(51) MKP
A61K 31/437 2006 (97) EP 3717471
A61P 9/00 2006
A61P 37/00 2006
C07D 403/04 2006
C07D 471/04 2006

(96) EP 18811769.1 11/26/2018

(97) EP 3717471, 10/7/2020 202041, en

(31) 201720101 (32) 02.12.2017 (33) GB
 201817343 25.10.2018 GB

(54) NOVEL COMPOUNDS AND PHARMACEUTICAL COMPOSITIONS THEREOF FOR THE TREATMENT OF DISEASES

(72) ALVEY, Luke, Jonathan, c/o Galapagos SASU 102 Avenue Gaston Roussel, 93230 Romainville, FR
 ANNOOT, Denis, Maurice, c/o Galapagos SASU 102 Avenue Gaston Roussel, 93230 Romainville, FR
 BONNATERRE, Florence, Marie-Emilie, c/o Galapagos SASU 102 Avenue Gaston Roussel, 93230 Romainville, FR
 BUCHER, Denis, Spitalhalde 40, 4310 Rheinfelden, CH
 DUTHION, Béranger, 102 Avenue Gaston Roussel, 93230 Romainville, FR
 JARY, Hélène, Marie, c/o Galapagos SASU 102 Avenue Gaston Roussel, 93230 Romainville, FR
 PEIXOTO, Christophe, c/o Galapagos SASU 102 Avenue Gaston Roussel, 93230 Romainville, FR
 TEMAL-LAIB, Taoues, 102 Avenue Gaston Roussel, 93230 Romainville, FR
 TIRERA, Amynata, 102 Avenue Gaston Roussel, 93230 Romainville, FR
 DESROY, Nicolas, 102 Avenue Gaston Roussel, Romainville, 93230, FR

(51) MKP
A01G 17/06 2006 (97) EP 3716755

(96) EP 18811933.3 11/20/2018

(97) EP 3716755, 10/7/2020 202041, en

(31) 201700136095 (32) 27.11.2017 (33) IT

(54) A DEVICE FOR TENSIONING PLANT SUPPORT WIRES, SUPPORT SYSTEM OF SAID PLANTS COMPRISING SUCH DEVICE AND THE METHOD OF SUPPORT THEREOF

(72) Bortolussi, Franco, Via Grigoletti 11, 33080 Fiume Veneto (PN), IT
 Bortolussi, Claudio, Via Grigoletti 3, 33080 Fiume Veneto (PN), IT

(51) MKP
A47K 10/32 2006 (97) EP 3727114
A47K 10/38 2006
A47K 10/40 2006
B65H 16/06 2006
B65H 75/24 2006

(96) EP 18812032.3 11/23/2018

(97) EP 3727114, 10/28/2020 202044, de

(31) 510802017 (32) 22.12.2017 (33) AT
 (54) REFILL FOR A DISPENSER
 (72) Hagleitner, Hans Georg, Lindenallee 11, 5700 Zell am See, AT

(51) MKP
A61K 31/185 2006 (97) EP 3724165
A61K 31/44 2006
A61K 31/444 2006
A61K 31/50 2006
A61P 35/00 2006
C07C 237/20 2006
C07C 255/50 2006
C07D 213/75 2006
C07D 237/20 2006
C07D 295/192 2006
C07D 401/04 2006

(96) EP 18812195.8 12/11/2018
 (97) EP 3724165, 10/21/2020 202043, en

(31) 17382845 (32) 12.12.2017 (33) EP
 (54) NEW BENZAMIDE DERIVATIVES AS PPAR-GAMMA MODULATORS
 (72) CASTRO PALOMINO LARIA, Julio, Tecnocampus Mataró 3 Avenida Ernest Lluch 32 Planta 4, oficina 01, 08302 Mataró, Barcelona, ES
 CAMACHO GÓMEZ, Juan, Tecnocampus Mataró 3 Avenida Ernest Lluch 32 Planta 4, oficina 01, 08302 Mataró, Barcelona, ES
 RODRÍGUEZ IGLESIAS, Rodolfo, MEDIBIOFARMA, S.L. Enric Granados, 29, 4º, 08330 Premià de Mar, Barcelona, ES

(51) MKP
A61K 38/26 2006 (97) EP 3713593
A61P 3/10 2006

(96) EP 18812499.4 11/13/2018
 (97) EP 3713593, 9/30/2020 202040, en

(31) 201762589244 P (32) 21.11.2017 (33) US
 (54) METHODS OF USING AND COMPOSITIONS CONTAINING DULAGLUTIDE
 (72) COX, David Andrew, c/o Eli Lilly and Company P.O. Box 6288, Indianapolis, Indiana 46206-6288, US
 MILICEVIC, Zvonko, c/o Eli Lilly and Company P.O. Box 6288, Indianapolis, Indiana 46206-6288, US
 THAM, Lai San, c/o Eli Lilly and Company P.O. Box 6288, Indianapolis, Indiana 46206-6288, US
 WERNER, Andrew Gordon, c/o Eli Lilly and Company P.O. Box 6288, Indianapolis, Indiana 46206-6288, US
 WOODWARD, David Bradley, c/o Eli Lilly and Company P.O. Box 6288, Indianapolis, Indiana 46206-6288, US

(51) MKP
A61K 31/519 2006 (97) EP 3717482
A61K 31/52 2006
A61P 35/00 2006
A61P 37/00 2006
C07D 471/04 2006
C07D 473/30 2006
C07D 495/04 2006

(96) EP 18814526.2 11/28/2018
 (97) EP 3717482, 10/7/2020 202041, en

(31) 1761338 (32) 29.11.2017 (33) FR
 (54) NEW PIPERIDINYL DERIVATIVES AS INHIBITORS OF UBIQUITIN SPECIFIC PROTEASE 7
 (72) KOTSCHY, András, Álmos Vezér utca 4, 2045 Törökbalint, HU
 WÉBER, Csaba, Szentendrei utca 9, 2009 Pilisszentlászló, HU
 VASAS, Attila, Eöri Barna u. 65, 2151 Fót, HU
 KISS, Árpád, Füst Milán utca 6 3/10, 1039 Budapest, HU
 MOLNÁR, Balázs, Fenyves utca 3, 2117 Isaszeg, HU
 STROFEK, Ágnes, Palkovics Károly utca 11, 2500 Esztergom, HU
 KUN, Vilibald, Álmos utca 21, 2461 Tárnok, HU
 MURRAY, James Brooke, 21 Parsonage Way, Linton Cambridgeshire CB21 4YL, GB
 MACIAS, Alba, 12 Beaulands Close, Cambridge Cambridgeshire CB4 1JA, GB
 LEWKOWICZ, Elodie, 4 rue Georges Saché, 75014 Paris, FR
 CHANRION, Maïa, 14 rue de la Galiote Apt D441, 92130 Issy Les Moulineaux, FR
 IVANSCHITZ, Lisa, 6 impasse des Lys, 91300 Massy, FR
 GENESTE, Olivier, Bâtiment A 17 rue Crevel Duval, 92500 Rueil Malmaison, FR

(51)	MKP								
	A61K 9/16	2006	(97) EP 3716952						
	A61K 9/20	2006							
	A61K 9/28	2006							
	A61K 9/48	2006							
	A61K 31/00	2006							
(96)	EP 18815293.8	11/28/2018							
(97)	EP 3716952, 10/7/2020	202041, en							
(31)	201762592242 P		(32)	29.11.2017		(33)		US	
	201721515			21.12.2017				GB	
(54)	DOSAGE FORMS COMPRISING A PLASMA KALLIKREIN INHIBITOR								
(72)	COLLETT, John Herman, Quay Pharmaceuticals Ltd. 28 Parkway Deeside Industrial Park, Deeside Flintshire CH5 2NS, GB								
	COOK, Gary Paul, 66 Griffin Road, Westford Massachusetts 01886, US								
	FARRAR, Jamie Joseph, Quay Pharmaceuticals Ltd. 28 Parkway Deeside Industrial Park, Deeside Flintshire CH5 2NS, GB								
	FRODSHAM, Michael John, Quay Pharmaceuticals Ltd. 28 Parkway Deeside Industrial Park, Deeside Flintshire CH5 2NS, GB								
	ROE, Michael Bryan, Kalvista Pharmaceutical Limited Porton Science Park Bybrook Road, Porton Down Wiltshire SP4 0BF, GB								
	TODD, Richard Simon, Kalvista Pharmaceuticals Limited Porton Science Park Bybrook Road, Porton Down Wiltshire SP4 0BF, GB								
	WARD, Robert Neil, Quay Pharmaceuticals Ltd. 28 Parkway Deeside Industrial Estate, Deeside Flintshire CH5 2NS, GB								
<hr/>									
(51)	MKP								
	A61K 31/473	2006	(97) EP 3713933						
	A61P 25/00	2006							
	C07D 405/12	2006							
	C07D 405/14	2006							
(96)	EP 18815537.8	11/23/2018							
(97)	EP 3713933, 9/30/2020	202040, en							
(31)	PA201700674		(32)	24.11.2017		(33)		DK	
(54)	NEW CATECHOLAMINE PRODRUGS FOR USE IN THE TREATMENT OF PARKINSON'S DISEASE								
(72)	JENSEN, Klaus, Gjervig, c/o H. Lundbeck A/S Ottiliavej 9, 2500 Valby, DK								
	KVÆRNØ, Lisbet, c/o H. Lundbeck A/S Ottiliavej 9, 2500 Valby, DK								
	JUHL, Martin, c/o H. Lundbeck A/S Ottiliavej 9, 2500 Valby, DK								
	MORTEN, Jørgensen, c/o H. Lundbeck A/S Ottiliavej 9, 2500 Valby, DK								
<hr/>									
(51)	MKP								
	A61K 48/00	2006	(97) EP 3714047						
	A61P 3/00	2006							
	C12N 9/02	2006							
	C12N 15/67	2006							
(96)	EP 18815909.9	11/21/2018							
(97)	EP 3714047, 9/30/2020	202040, en							
(31)	201762590128 P		(32)	22.11.2017		(33)		US	
	201862679081 P			01.06.2018				US	
(54)	POLYNUCLEOTIDES ENCODING PHENYLALANINE HYDROXYLASE FOR THE TREATMENT OF PHENYLKETONURIA								
(72)	RAJENDRAN, Raj, ModernaTX, Inc. 200 Technology Square, Cambridge Massachusetts 02139, US								
	FINN, Patrick, ModernaTX, Inc. 200 Technology Square, Cambridge Massachusetts 02139, US								
	MARTINI, Paolo G. V., ModernaTX, Inc. 200 Technology Square, Cambridge Massachusetts 02139, US								
	AN, Ding, ModernaTX, Inc. 200 Technology Square, Cambridge Massachusetts 02139, US								
	DOUSIS, Athanasios, ModernaTX, Inc. 200 Technology Square, Cambridge Massachusetts 02139, US								
	RAVICHANDRAN, Kanchana, ModernaTX, Inc. 200 Technology Square, Cambridge Massachusetts 02139, US								
<hr/>									
(51)	MKP								
	A61K 48/00	2006	(97) EP 3714045						
	A61P 3/00	2006							
	C12N 9/00	2006							
	C12N 15/67	2006							
(96)	EP 18815914.9	11/21/2018							
(97)	EP 3714045, 9/30/2020	202040, en							
(31)	201762590199 P		(32)	22.11.2017		(33)		US	
	201862614787 P			08.01.2018				US	
	201862663024 P			26.04.2018				US	
	201862693552 P			03.07.2018				US	
	201862747356 P			18.10.2018				US	
(54)	POLYNUCLEOTIDES ENCODING PROPIONYL-COA CARBOXYLASE ALPHA AND BETA SUBUNITS FOR THE TREATMENT OF PROPIONIC ACIDEMIA								

(72) JIANG, Lei, ModernaTX, Inc. 200 Technology Square, Cambridge Massachusetts 02139, US
 GUEY, Lin Tung, ModernaTX, Inc. 200 Technology Square, Cambridge Massachusetts 02139, US
 MARTINI, Paolo G. V., ModernaTX, Inc. 200 Technology Square, Cambridge Massachusetts 02139, US
 PRESNYAK, Vladimir, ModernaTX, Inc. 200 Technology Square, Cambridge Massachusetts 02139, US

(51) MKP
A23G 9/42 2006 (97) EP 3716791
A23L 9/20 2016
A23L 33/185 2016
A61K 36/48 2006

(96) EP 18815960.2 11/28/2018

(97) EP 3716791, 10/7/2020 202041, en

(31) 17204213 (32) 28.11.2017 (33) EP

(54) CREAM SUBSTITUTE COMPRISING PULSE PROTEIN
 (72) GAUTIER, Gaele, 35 rue Jean Jaurès, 59370 Mons-en-Baroeul, FR
 BEGUIN, Pauline, Rue du Curoir 17, 7033 Cuesmes, BE
 VERVACKE, Christophe, Rue de la liberté 139, 7540 Rumillies, BE
 PIHEN, Julie, 65b rue de Watrelos, 59115 Leers, FR

(51) MKP
A61K 31/505 2006 (97) EP 3720865
A61P 35/00 2006
C07D 307/94 2006
C07D 317/44 2006
C07D 471/04 2006
C07H 19/14 2006

(96) EP 18816013.9 12/6/2018

(97) EP 3720865, 10/14/2020 202042, en

(31) 201762596441 P (32) 08.12.2017 (33) US
 18163867 26.03.2018 EP

(54) NOVEL SPIROBICYCLIC ANALOGUES
 (72) VERHOEVEN, Jonas, Vrije Universiteit Brussel Pleinlaan 2, 1050 Brussel, BE
 VERNIEST, Guido Alfons F., Janssen Pharmaceutica NV Turnhoutseweg 30, 2340 Beerse, BE
 THURING, Johannes Wilhelmus John F., Janssen Pharmaceutica NV Turnhoutseweg 30, 2340 Beerse, BE
 WU, Tongfei, Karabiniersstraat 28, 3191 Hever, BE
 PANDE, Vineet, Janssen Pharmaceutica NV Turnhoutseweg 30, 2340 Beerse, BE
 MEERPOEL, Lieven, Janssen Pharmaceutica NV Turnhoutseweg 30, 2340 Beerse, BE
 BREHMER, Dirk, Janssen Pharmaceutica NV Turnhoutseweg 30, 2340 Beerse, BE
 SUN, Weimei, Janssen Research & Development LLC 920 US Route 202 P.O. Box 300, Raritan, New Jersey 08869, US
 DENMARK, Scott E., 2010 Trout Valley Dr., Champaign, Illinois 61822, US

(51) MKP
A61K 48/00 2006 (97) EP 3714048
A61P 3/00 2006
C12N 9/10 2006
C12N 15/67 2006

(96) EP 18816408.1 11/21/2018

(97) EP 3714048, 9/30/2020 202040, en

(31) 201762590157 P (32) 22.11.2017 (33) US
 201862765354 P 20.08.2018 US

(54) POLYNUCLEOTIDES ENCODING ORNITHINE TRANSCARBAMYLASE FOR THE TREATMENT OF UREA CYCLE DISORDERS
 (72) ZHUO, Zhijian, ModernaTX, Inc. 200 Technology Square, Cambridge Massachusetts 02139, US
 FRASSETTO, Andrea Lea, ModernaTX, Inc. 200 Technology Square, Cambridge Massachusetts 02139, US
 MARTINI, Paolo G.V., ModernaTX, Inc. 200 Technology Square, Cambridge, Massachusetts 02139, US
 FINN, Patrick, ModernaTX, Inc. 200 Technology Square, Cambridge, Massachusetts 02139, US
 PRESNYAK, Vladimir, ModernaTX, Inc. 200 Technology Square, Cambridge, Massachusetts 02139, US

(51) MKP
C07B 59/00 2006 (97) EP 3717455
C07C 33/18 2006
C07C 69/96 2006
C07D 215/56 2006

(96) EP 18816468.5 11/30/2018

(97) EP 3717455, 10/7/2020 202041, en
 (31) 17382829 (32) 01.12.2017 (33) EP
 (54) PROCESSES FOR MAKING MODULATORS OF CYSTIC FIBROSIS TRANSMEMBRANE CONDUCTANCE REGULATOR
 (72) LEMERCIER LEWANDOWSKI, Berenice, 50 Northern Avenue, Boston, MA 02210, US
 LEWIS, Robert, 99 Hayden Avenue, Lexington, MA 02421, US
 LOOKER, Adam, 50 Northern Avenue, Boston, MA 02210, US
 MORGAN, Adam, 14 Oak Ridge Lane, Ashland, MA 01721, US
 ROEPER, Stefanie, 50 Northern Avenue, Boston, MA 02210, US
 RYAN, Michael, 50 Northern Avenue, Boston, MA 02210, US
 SOLSONA ROCABERT, Juan, Gabriel, Caracas 17-19, 08030 Barcelona, ES
 WILDE, Nathan, 50 Northern Avenue, Boston, MA 02210, US

(51) MKP
A61K 31/4709 2006 (97) EP 3713928
A61K 31/5377 2006
A61P 11/06 2006
A61P 25/28 2006
A61P 29/00 2006
C07D 401/04 2006
C07D 401/14 2006
C07D 405/14 2006
C07D 413/14 2006
C07D 417/14 2006

(96) EP 18818992.2 11/23/2018
 (97) EP 3713928, 9/30/2020 202040, en
 (31) 17203675 (32) 24.11.2017 (33) EP
 (54) NOVEL BRADYKININ B2 RECEPTOR ANTAGONISTS
 (71) Pharvaris Netherlands B.V., Leiden BioScience Park J.H. Oortweg 21, 2333 CH Leiden, NL
 (72) GIBSON, Christoph, Thulestr. 24, 13189 Berlin, DE
 SAUPE, Joern, Pomonaring 52, 14469 Potsdam, DE
 AMBROSI, Horst-Dieter, Volkradstrasse 11, 10319 Berlin, DE
 HAUSTEDT, Lars Ole, Spandauer Str. 1a, 14612 Falkensee, DE

(51) MKP
A61K 39/00 2006 (97) EP 3717514
C07K 16/28 2006

(96) EP 18819293.4 11/28/2018
 (97) EP 3717514, 10/7/2020 202041, en
 (31) 201762592657 P (32) 30.11.2017 (33) US
 (54) ANTI-TRKB MONOCLONAL ANTIBODIES AND METHODS OF USE
 (72) CROLL, Susan D., c/o Regeneron Pharmaceuticals Inc. 777 Old Saw Mill River Road, Tarrytown New York 10591, US
 GAO, Min, c/o Regeneron Pharmaceuticals Inc. 777 Old Saw Mill River Road, Tarrytown New York 10591, US
 HU, Ying, c/o Regeneron Pharmaceuticals Inc. 777 Old Saw Mill River Road, Tarrytown New York 10591, US

(51) MKP
A61K 31/7052 2006 (97) EP 3720864
A61P 35/00 2006
C07H 19/10 2006
C07H 19/20 2006

(96) EP 18819340.3 12/5/2018
 (97) EP 3720864, 10/14/2020 202042, en
 (31) 201720279 (32) 05.12.2017 (33) GB
 (54) SALTS OF DIPHOSPHATE PHOSPHORAMIDATE OF NUCLEOSIDES AS ANTICANCER COMPOUNDS
 (72) GRIFFITH, Hugh, c/o NuCana plc 3 Lochside Way, Edinburgh Central Scotland EH12 9DT, GB
 SERPI, Michaela, c/o School of Pharmacy&Pharmaceutical Sciences Cardiff University Redwood Building King Edward VII Avenue, Cardiff South Glamorgan CF10 3NB, GB
 PERTUSATI, Fabrizio, c/o School of Pharmacy&Pharmaceutical Sciences Cardiff University Redwood Building King Edward VII Avenue, Cardiff South Glamorgan CF10 3NB, GB
 SLUSARCZYK, Magdalena, c/o School of Pharmacy&Pharmaceutical Sciences Cardiff University Redwood Building King Edward VII Avenue, Cardiff South Glamorgan CF10 3NB, GB

(51) MKP

A61K 8/81 2006 (97) EP 3720416
A61Q 11/00 2006
 (96) EP 18819494.8 11/29/2018
 (97) EP 3720416, 10/14/2020 202042, en
 (31) 201715834160 (32) 07.12.2017 (33) US
 (54) ORAL CARE COMPOSITION
 (72) QUEIROZ, Daniel, 199 Grandview Road, Skillman New Jersey 08558, US
 TESTER, Chantel, 199 Grandview Road, Skillman New Jersey 08558, US
 GIANO, Michael C., 199 Grandview Road, Skillman New Jersey 08558, US
 CHEN, Rebecca, 110 Cherry Brook Drive, Princeton New Jersey 08540, US
 GAMBOGI, Robert J., 199 Grandview Road, Skillman New Jersey 08558, US

(51) MKP
A61K 8/81 2006 (97) EP 3720563
A61Q 11/00 2006
 (96) EP 18819495.5 11/29/2018
 (97) EP 3720563, 10/14/2020 202042, en
 (31) 201715834537 (32) 07.12.2017 (33) US
 (54) ORAL CARE COMPOSITIONS
 (72) QUEIROZ, Daniel, 199 Grandview Road, Skillman New Jersey 08558, US
 TESTER, Chantel, 199 Grandview Road, Skillman New Jersey 08558, US
 GIANO, Michael C., 199 Grandview Road, Skillman New Jersey 08558, US
 CHEN, Rebecca, 110 Cherry Brook Drive, Princeton New Jersey 08540, US
 GAMBOGI, Robert J., 199 Grandview Road, Skillman New Jersey 08558, US

(51) MKP
A61K 8/02 2006 (97) EP 3720564
A61K 8/24 2006
A61Q 11/00 2006
G01N 1/30 2006
G01N 21/17 2006
G01N 33/15 2006
 (96) EP 18819497.1 11/29/2018
 (97) EP 3720564, 10/14/2020 202042, en
 (31) 201715835939 (32) 08.12.2017 (33) US
 (54) HIGH-THROUGHPUT METHOD FOR DETECTING TOOTH STAIN PREVENTION AND REMOVAL
 (72) GIANO, Michael C., 199 Grandview Road, Skillman New Jersey 08558, US
 QUEIROZ, Daniel, 199 Grandview Road, Skillman New Jersey 08558, US
 KNOX, Susan, 15 Lindwood Avenue, Ewing New Jersey 08638, US

(51) MKP
A61K 31/4709 2006 (97) EP 3713919
A61P 7/06 2006
C07D 215/36 2006
 (96) EP 18821779.8 11/21/2018
 (97) EP 3713919, 9/30/2020 202040, en
 (31) 201762589822 P (32) 22.11.2017 (33) US
 201862691709 P 29.06.2018 US
 (54) CRYSTALLINE FORMS OF N-(4-(4-(CYCLOPROPYLMETHYL) PIPERAZINE-1-CARBONYL)PHENYL)QUINOLINE-8-SULFONAMIDE
 (72) SIZEMORE, Jacob, P., 8 Vista Drive, Shrewsbury MA 01545, US
 GUO, Liting, Qinshui Langting Blvd. 18 2 HongFan Road Suzhou, Jiangsu 215000, CN
 MIRMEHRABI, Mahmoud, 36 Roxbury Crescent, Halifax Nova Scotia B3M 4T1, CA
 SU, Yeqing, 2225 Monastery Lane Apt 310, Halifax Nova Scotia B3L 4R1, CA

(51) MKP
A61M 5/24 2006 (97) EP 3720526
A61M 5/315 2006
 (96) EP 18821853.1 11/30/2018
 (97) EP 3720526, 10/14/2020 202042, en
 (31) 201762596167 P (32) 08.12.2017 (33) US
 (54) MEDICAL DELIVERY DEVICE WITH AXIALLY EXPANDABLE DRIVE RIBBON

(72) JUDSON, Jared Alden, c/o Eli Lilly And Company P.O. Box 6288, Indianapolis Indiana 46206-6288, US
 MOULTON, Timothy Lee, c/o Eli Lilly And Company P.O. Box 6288, Indianapolis Indiana 46206-6288, US
 PERKINS, Russell Wayne, c/o Eli Lilly And Company P.O. Box 6288, Indianapolis Indiana 46206-6288, US

(51) MKP
A61K 31/573 2006 (97) EP 3716980
A61P 43/00 2006
C07K 16/28 2006
G01N 33/68 2006

(96) EP 18821900.0 11/30/2018

(97) EP 3716980, 10/7/2020 202041, en

(31)	201762593878 P	(32)	01.12.2017	(33)	US
	201762596773 P		08.12.2017		US
	201862633599 P		21.02.2018		US
	201862679763 P		01.06.2018		US
	201862679764 P		01.06.2018		US

(54) METHODS FOR DOSING AND FOR MODULATION OF GENETICALLY ENGINEERED CELLS

(72) ALBERTSON, Tina, 400 Dexter Ave. N Suite 1200, Seattle Washington 98109, US
 HEIPEL, Mark D., 400 Dexter Ave. N Suite 1200, Seattle Washington 98109, US
 LI, He, 400 Dexter Ave. N Suite 1200, Seattle Washington 98109, US
 SUTHERLAND, Claire L., 400 Dexter Ave. N Suite 1200, Seattle Washington 98109, US
 HASSKARL, Jens, Route de Perreux 1, 2017 Boudry, CH
 GARCIA, Jacob, Randolph, 400 Dexter Avenue N, Suite 1200, Seattle, WA 98109, US
 TREDE, Nikolaus, Sébastian, 400 Dexter Avenue N, Suite 1200, Seattle, WA 98109, US
 GILBERT, Mark, J., 400 Dexter Avenue N, Suite 1200, Seattle, WA 98109, US

(51) MKP
A01K 67/027 2006 (97) EP 3720279
C07K 16/00 2006
C07K 16/46 2006
C12N 9/12 2006

(96) EP 18821945.5 12/4/2018

(97) EP 3720279, 10/14/2020 202042, en

(31)	201762594946 P	(32)	05.12.2017	(33)	US
	201762594944 P		05.12.2017		US
	201762609241 P		21.12.2017		US
	201762609251 P		21.12.2017		US

(54) NON-HUMAN ANIMALS HAVING AN ENGINEERED IMMUNOGLOBULIN LAMBDA LIGHT CHAIN AND USES THEREOF

(72) MURPHY, Andrew J., c/o Regeneron Pharmaceuticals, Inc. 777 Old Saw Mill River Road, Tarrytown, New York 10591, US
 MACDONALD, Lynn, c/o Regeneron Pharmaceuticals, Inc. 777 Old Saw Mill River Road, Tarrytown, New York 10591, US
 GUO, Chunguang, c/o Regeneron Pharmaceuticals, Inc. 777 Old Saw Mill River Road, Tarrytown, New York 10591, US
 MCWHIRTER, John, c/o Regeneron Pharmaceuticals, Inc. 777 Old Saw Mill River Road, Tarrytown, New York 10591, US

(51) MKP
A61K 31/437 2006 (97) EP 3713940
A61P 25/00 2006
C07D 471/04 2006

(96) EP 18822142.8 11/21/2018

(97) EP 3713940, 9/30/2020 202040, en

(31)	201741042082	(32)	23.11.2017	(33)	IN
------	--------------	------	------------	------	----

(54) SUBSTITUTED AZACYCLES AS MUSCARINIC M1 RECEPTOR POSITIVE ALLOSTERIC MODULATORS

(72) NIROGI, Ramakrishna, Suven Life Sciences Limited Serene Chambers Road-5 Avenue 7 Banjara Hills, Hyderabad-Telangana 500034, IN
 SHINDE, Anil Karbhari, Suven Life Sciences Limited Serene Chambers Road-5 Avenue 7 Banjara Hills, Hyderabad-Telangana 500034, IN
 MOHAMMED, Abdul Rasheed, Suven Life Sciences Limited Serene Chambers Road-5 Avenue 7 Banjara Hills, Hyderabad-Telangana 500034, IN
 BADANGE, Rajesh Kumar, Suven Life Sciences Limited Serene Chambers Road 5 Avenue 7 Banjara Hills, Hyderabad Telangana 500034, IN
 PALACHARLA, Raghava Choudary, Suven Life Sciences Limited Serene Chambers Road 5 Avenue 7 Banjara Hills, Hyderabad Telangana 500034, IN
 JASTI, Venkateswarlu, Suven Life Sciences Limited Serene Chambers Road-5 Avenue 7 Banjara Hills, Hyderabad-Telangana 500034, IN

(51) MKP

	A61K 31/4525	2006	(97) EP 3720858				
	A61P 9/04	2006					
	C07D 491/10	2006					
(96)	EP 18822236.8 12/6/2018						
(97)	EP 3720858, 10/14/2020 202042, en						
(31)	201762595133 P		(32)	06.12.2017		(33)	US
(54)	MODULATORS OF THE BETA-3 ADRENERGIC RECEPTOR USEFUL FOR THE TREATMENT OR PREVENTION OF HEART FAILURE AND DISORDERS RELATED THERETO						
(72)	TRAN, Thuy-Anh, 4833 Fairport Way, San Diego California 92130, US ULLMAN, Brett, 3046 40th Street, San Diego California 92105, US KRAMER, Bryan Aubrey, 8863 Duncan Road, San Diego California 92126, US DO, Quyen-Quyen Thuy, 10414 Rosedust Glen Drive, San Diego California 92127, US SHIN, Young-Jun, 11051 Ice Skate Place, San Diego California 92126, US						
<hr/>							
(51)	MKP						
	A61K 31/047	2006	(97) EP 3727359				
	A61P 43/00	2006					
(96)	EP 18822360.6 12/20/2018						
(97)	EP 3727359, 10/28/2020 202044, en						
(31)	201700148902		(32)	22.12.2017		(33)	IT
(54)	TREATMENT OF FIBROSIS WITH INOSITOL						
(71)	LO.LI. Pharma International S.r.l., Via Dei Luxardo 33, 00156 Rome, IT						
(72)	UNFER, Vittorio, Via Cesare Massini 43, 00155 Rome, IT						
<hr/>							
(51)	MKP						
	G06Q 40/00	2012	(97) EP 3752972				
(96)	EP 19753645.1 2/11/2019						
(97)	EP 3752972, 12/23/2020 202052, en						
(31)	201862631547 P		(32)	16.02.2018		(33)	US
	201862673373 P			18.05.2018			US
(54)	SYSTEM AND METHOD FOR AUTHENTICATED SHARIA LAW COMPLIANT LOTTERY, SPORTS BETTING AND GAMING						
(71)	Boloro Global Limited, 747 3rd Avenue, 2nd Floor, New York, NY 10017, US						
(72)	Rammal, Karim Anwar, 377 East 33rd Street, 20B, New York, NY 10016, US						
<hr/>							
(51)	MKP						
	A61K 39/395	2006	(97) EP 3752191				
	C07K 14/47	2006					
	C12N 15/864	2006					
(96)	EP 19753655.0 2/14/2019						
(97)	EP 3752191, 12/23/2020 202052, en						
(31)	201862630670 P		(32)	14.02.2018		(33)	US
	201862630676 P			14.02.2018			US
	201862680087 P			04.06.2018			US
	201862680092 P			04.06.2018			US
(54)	NON-VIRAL DNA VECTORS AND USES THEREOF FOR ANTIBODY AND FUSION PROTEIN PRODUCTION						
(72)	ALKAN, Ozan, c/o Generation Bio Co. 301 Binney Street, 4th Floor, Cambridge, Massachusetts 02142, US KERR, Douglas Anthony, c/o Generation Bio Co. 301 Binney Street, 4th Floor, Cambridge, Massachusetts 02142, US KOTIN, Robert Michael, c/o Generation Bio Co. 301 Binney Street, 4th Floor, Cambridge, Massachusetts 02142, US KLATTE, Debra, c/o Generation Bio Co. 301 Binney Street, 4th Floor, Cambridge, Massachusetts 02142, US LIU, Leah, c/o Generation Bio Co. 301 Binney Street, 4th Floor, Cambridge, Massachusetts 02142, US SILVER, Nathaniel, c/o Generation Bio Co. 301 Binney Street, 4th Floor, Cambridge, Massachusetts 02142, US						
<hr/>							
(51)	MKP						
	A61K 39/395	2006	(97) EP 3752193				
	C07K 16/28	2006					
	C07K 16/30	2006					
(96)	EP 19754385.3 2/8/2019						
(97)	EP 3752193, 12/23/2020 202052, en						
(31)	201862630038 P		(32)	13.02.2018		(33)	US
	201862732828 P			18.09.2018			US
	201862740741 P			03.10.2018			US
(54)	METHODS FOR TREATING CANCER WITH ANTI PD-1 ANTIBODIES AND ANTI CTLA4 ANTIBODIES						

(72) LALA, Mallika, 126 East Lincoln Avenue, Rahway, New Jersey 07065-0907, US
 JAIN, Lokesh, 126 East Lincoln Avenue, Rahway, New Jersey 07065-0907, US
 LI, Mengyao, 42 Forest Drive, Apt. B, Springfield, New Jersey 07084, US
 ALTURA, Rachel Allison, 126 East Lincoln Avenue, Rahway, New Jersey 07065-0907, US
 TSE, Archie Ngai-chiu, 2-17 51st Avenue, 1105 Long Island City, New York 11101, US

(51) MKP
B07C 3/00 2006 (97) EP 3752440
B07C 5/00 2006
B65G 15/22 2006
B65G 17/26 2006
B65G 47/08 2006

(96) EP 19754558.5 2/14/2019

(97) EP 3752440, 12/23/2020 202052, en

(31) 20185145 (32) 16.02.2018 (33) FI

(54) GROUPING STATION FOR LOADING PALLETS

(72) VARTIAINEN, Jari, Routiontie 11, 76850 NAARAJÄRVI, FI
 PAKKANEN, Jukka, Rusakontie 21, 40900 SÄYNÄTSALO, FI
 VALO, Joonas, Särkiniementie 38 C 11, 70700 KUOPIO, FI

(51) MKP
A61K 31/519 2006 (97) EP 3753941
A61K 31/55 2006
A61K 45/06 2006
A61P 35/00 2006
A61P 35/02 2006
C07D 487/04 2006
C07D 519/00 2006

(96) EP 19754599.9 2/3/2019

(97) EP 3753941, 12/23/2020 202052, en

(31) 201810144135 (32) 13.02.2018 (33) CN
 201810692211 29.06.2018 CN

(54) PYRIMIDINE-FUSED CYCLIC COMPOUND, PREPARATION METHOD THEREFOR AND APPLICATION THEREOF

(71) Shanghai Blueray Biopharma Co., Ltd., Room 106, Building 2, No. 230 Cailun Road, No.86 Faladi Road, Pilot Free Trade Zone Pudong New Area, Shanghai 201210, CN

(72) ZOU, Bin, Room 106, Building 2, No. 230 Cailun Road, No.86 Faladi Road, Pilot Free Trade Zone, Pudong New Area, Shanghai 201210, CN
 FU, Xianlei, Room 106, Building 2, No. 230 Cailun Road, No.86 Faladi Road, Pilot Free Trade Zone, Pudong New Area, Shanghai 201210, CN
 ZHANG, Rui, Room 106, Building 2, No. 230 Cailun Road, No.86 Faladi Road, Pilot Free Trade Zone, Pudong New Area, Shanghai 201210, CN
 MA, Shichao, Room 106, Building 2, No. 230 Cailun Road, No.86 Faladi Road, Pilot Free Trade Zone, Pudong New Area, Shanghai 201210, CN
 XU, Shuaijie, Room 106, Building 2, No. 230 Cailun Road, No.86 Faladi Road, Pilot Free Trade Zone, Pudong New Area, Shanghai 201210, CN
 FU, Wencheng, Room 106, Building 2, No. 230 Cailun Road, No.86 Faladi Road, Pilot Free Trade Zone, Pudong New Area, Shanghai 201210, CN

LIU, Lanzhen, Room 106, Building 2, No. 230 Cailun Road, No.86 Faladi Road, Pilot Free Trade Zone, Pudong New Area, Shanghai 201210, CN

(51) MKP
A61K 31/538 2006 (97) EP 3752491
C07D 265/36 2006
C07D 413/14 2006

(96) EP 19754726.8 2/15/2019

(97) EP 3752491, 12/23/2020 202052, en

(31) 201862631437 P (32) 15.02.2018 (33) US

(54) HETEROCYCLIC COMPOUNDS AS KINASE INHIBITORS

(71) Nuvation Bio Inc., 1500 Broadway, Ste. 1401, New York, NY 10036, US

(72) PHAM, Son, Minh, 75 Rockwood Court, San Francisco, CA 94127, US
 CHAKRAVARTY, Sarvajit, 616 Hollowdale, Edmond, OK 73003, US
 KANKANALA, Jayakanth, 2008 Brewster St. Apt. 302, St. Paul, MN 55108, US
 PUJALA, Brahmam, M-33, First Floor, Delta-3, Greater Noida 201310, IN
 SHETE, Amit, C-64, Hosiery Complex, Noida Phase-II Extension, Noida 201306, IN
 BHATT, Bhawana, C-64, Hosiery Complex, Noida Phase-II Extension, Noida 201306, IN
 AGARWAL, Anil, Kumar, B-411, Vivek Vihar, Awho Society, Sector 82, Noida 201304, IN
 SONI, Sanjeev, C-2 Hindon Vihar, Sector 49, Noida 201301, IN
 CHEN, Jiyun, 4 Ketelsen Court, Moraga, CA 94556, US

(51) MKP
A61M 1/36 2006 (97) EP 3752216
C09D 11/50 2014
F28D 9/00 2006

(96) EP 19755006.4 2/8/2019
(97) EP 3752216, 12/23/2020 202052, en
(31) 201862630178 P (32) 13.02.2018 (33) US

(54) USING THERMOCHROMIC INK FOR BLOOD SIMULATION IN MEDICAL TRAINING
(72) ALSALEMI, Abdullah, P.O. Box 2713, Doha, QA
AL DISI, Mohammed, P.O. Box 2713, Doha, QA
ALHOMSI, Yahya, P.O. Box 2713, Doha, QA
AHMED, Ibrahim, P.O. Box 2713, Doha, QA
BENSAALI, Faycal, P.O. Box 2713, Doha, QA
AMIRA, Abbes, P.O. Box 2713, Doha, QA
ALINIER, Guillaume, P.O. Box 2713, Doha, QA

(51) MKP
A61K 31/366 2006 (97) EP 3752142
A61K 31/381 2006
A61K 31/4025 2006

(96) EP 19755023.9 2/12/2019
(97) EP 3752142, 12/23/2020 202052, en
(31) 201862630117 P (32) 13.02.2018 (33) US

(54) ANTIBACTERIAL AGENTS: SOLUBLE SALTS AND AQUEOUS FORMULATIONS OF PYRONINS
(72) EBRIGHT, Richard H., 83 Somerset Street, New Brunswick, New Jersey 08901, US
EBRIGHT, Yon W., 83 Somerset Street, New Brunswick, New Jersey 08901, US

(51) MKP
A61K 31/366 2006 (97) EP 3752143
A61K 31/381 2006
A61K 31/4025 2006

(96) EP 19755117.9 2/12/2019
(97) EP 3752143, 12/23/2020 202052, en
(31) 201862630122 P (32) 13.02.2018 (33) US

(54) ANTIBACTERIAL AGENTS: O-ALKYL-DEUTERATED PYRONINS
(71) Rutgers, The State University of New Jersey, 83 Somerset Street, New Brunswick, NJ 08901, US
(72) EBRIGHT, Richard H., 83 Somerset Street, New Brunswick, New Jersey 08901, US
EBRIGHT, Yon W., 83 Somerset Street, New Brunswick, New Jersey 08901, US

(51) MKP
B60R 11/02 2006 (97) EP 3755613
B62D 1/04 2006
B62K 11/14 2006

(96) EP 19755149.2 2/19/2019
(97) EP 3755613, 12/30/2020 202053, en
(31) 201815899321 (32) 19.02.2018 (33) US

(54) ERGONOMIC CONTROL SYSTEM FOR BICYCLES AND ELECTRONIC DEVICES
(71) Markey, Dillon, 4584 Cleland Ave., Los Angeles, California 90065, US
(72) Markey, Dillon, 4584 Cleland Ave., Los Angeles, California 90065, US

(51) MKP
G03G 15/00 2006 (97) EP 3614208

(96) EP 19191397.9 8/13/2019
(97) EP 3614208, 9/30/2020 202040, en
(31) 2018152594 (32) 14.08.2018 (33) JP
2018152595 14.08.2018 JP

(54) OPTICAL SENSOR AND IMAGE FORMING APPARATUS
(72) ISHIDO, Katsuhiko, c/o CANON KABUSHIKI KAISHA; 30-2, Shimomaruko 3-chome, Ohta-ku, Tokyo, 146-8501, JP

(51) MKP
G03G 15/00 2006 (97) EP 3614209

(96) EP 19191398.7 8/13/2019
 (97) EP 3614209, 9/30/2020 202040, en
 (31) 2018152596 (32) 14.08.2018 (33) JP
 (54) IMAGE FORMING APPARATUS
 (72) INO, Koichiro, c/o CANON KABUSHIKI KAISHA; 30-2, Shimomaruko 3-chome, Ohta-ku, Tokyo, 146-8501, JP

(51) MKP
A61K 39/395 2006 (97) EP 3656398
A61P 35/00 2006
C07K 16/28 2006
C07K 16/30 2006
 (96) EP 19191552.9 9/11/2014
 (97) EP 3656398, 1/6/2021 202101, en
 (31) 201361876509 P (32) 11.09.2013 (33) US
 201461971212 P 27.03.2014 US
 201461978401 P 11.04.2014 US
 201462003349 P 27.05.2014 US
 (54) ANTI-B7-H1 ANTIBODIES FOR TREATING TUMORS
 (72) NARWAL, Rajesh, c/o MedImmune LLC One MedImmune Way, Gaithersburg, Maryland 20878, US
 FAIRMAN, David, c/o MedImmune Limited Milstein Building Granta Park, Cambridge, Cambridgeshire CB21 6GH, GB
 ROBBINS, Paul, c/o MedImmune LLC One MedImmune Way, Gaithersburg, Maryland 20878, US
 LIANG, Meina, c/o MedImmune LLC One MedImmune Way, Gaithersburg, Maryland 20878, US
 SCHNEIDER, Amy, c/o MedImmune LLC One MedImmune Way, Gaithersburg, Maryland 20878, US
 CHAVEZ, Carlos, c/o MedImmune LLC One MedImmune Way, Gaithersburg, Maryland 20878, US
 HERL, Carina, c/o MedImmune LLC One MedImmune Way, Gaithersburg, Maryland 20878, US
 PAK, Min, c/o MedImmune LLC One MedImmune Way, Gaithersburg, Maryland 20878, US
 LU, Hong, c/o MedImmune LLC One MedImmune Way, Gaithersburg, Maryland 20878, US
 REBELATTO, Marlon, c/o MedImmune LLC One MedImmune Way, Gaithersburg, Maryland 20878, US
 STEELE, Keith, c/o MedImmune LLC One MedImmune Way, Gaithersburg, Maryland 20878, US
 BOUSTRIN, Anmarie, c/o MedImmune LLC One MedImmune Way, Gaithersburg, Maryland 20878, US
 SHI, Li, c/o MedImmune LLC One MedImmune Way, Gaithersburg, Maryland 20878, US
 HONG, Shengyan, c/o MedImmune LLC One MedImmune Way, Gaithersburg, Maryland 20878, US
 HIGGS, Brandon, c/o MedImmune LLC One MedImmune Way, Gaithersburg, Maryland 20878, US
 ROSKOS, Lorin, c/o MedImmune LLC One MedImmune Way, Gaithersburg, Maryland 20878, US

(51) MKP
A61K 39/395 2006 (97) EP 3623385
A61P 35/02 2006
A61P 37/00 2006
C07K 16/28 2006
 (96) EP 19192268.1 11/15/2012
 (97) EP 3623385, 10/28/2020 202044, en
 (31) 201161560144 P (32) 15.11.2011 (33) US
 201161560149 P 15.11.2011 US
 201161560162 P 15.11.2011 US
 201161560178 P 15.11.2011 US
 201161560183 P 15.11.2011 US
 201261651474 P 24.05.2012 US
 201261651486 P 24.05.2012 US
 (54) BINDING MOLECULES FOR BCMA AND CD3
 (72) KUFER, Peter, c/o Amgen Research (Munich) GmbH Staffelseestrasse 2, 81477 Munich, DE
 RAUM, Tobias, c/o Amgen Research (Munich) GmbH Staffelseestrasse 2, 81477 Munich, DE
 HOFFMANN, Patrick, c/o Amgen Research (Munich) GmbH Staffelseestrasse 2, 81477 Munich, DE
 KISCHEL, Roman, c/o Amgen Research (Munich) GmbH Staffelseestrasse 2, 81477 Munich, DE
 LUTTERBUESE, Ralf, c/o Amgen Research (Munich) GmbH Staffelseestrasse 2, 81477 Munich, DE
 RAU, Doris, c/o Amgen Research (Munich) GmbH Staffelseestrasse 2, 81477 Munich, DE
 ADAM, Paul, c/o Boehringer Ingelheim GmbH, Corporate Patents Binger Strasse 173, 55216 Ingelheim am Rhein, DE
 BORGES, Eric, c/o Boehringer Ingelheim GmbH, Corporate Patents Binger Strasse 173, 55216 Ingelheim am Rhein, DE
 HEBEIS, Barbara, c/o Boehringer Ingelheim GmbH, Corporate Patents Binger Strasse 173, 55216 Ingelheim am Rhein, DE
 HIPPEL, Susanne, c/o Boehringer Ingelheim GmbH, Corporate Patents Binger Strasse 173, 55216 Ingelheim am Rhein, DE

(51) MKP
A61K 39/39 2006 (97) EP 3628373
A61P 27/02 2006

(96)	EP 19192389.5	7/11/2014				
(97)	EP 3628373,	11/11/2020	202046,	en		
(31)	201361845938 P		(32)	12.07.2013	(33)	US
	201361845935 P			12.07.2013		US
	201361845936 P			12.07.2013		US
	201361866502 P			15.08.2013		US
	201361866503 P			15.08.2013		US
	201361866507 P			15.08.2013		US
	201361911854 P			04.12.2013		US
	201361911860 P			04.12.2013		US
	201361911894 P			04.12.2013		US
	201461926848 P			13.01.2014		US
	201461926825 P			13.01.2014		US
	201461926812 P			13.01.2014		US
	201461931116 P			24.01.2014		US
	201461931125 P			24.01.2014		US
	201461931135 P			24.01.2014		US
(54)	METHODS FOR TREATING OR PREVENTING OPHTHALMOLOGICAL CONDITIONS					
(71)	IVERIC bio, Inc., One Penn Plaza, Suite 1924, New York, NY 10119, US					
(72)	PATEL, Samir, One University Square Drive Suite 280, Princeton, NJ New Jersey 08540, US					

(51)	MKP					
	A61K 39/395	2006	(97) EP 3636279			
(96)	EP 19192583.3	3/30/2012				
(97)	EP 3636279,	11/18/2020	202047,	en		
(31)	201161471007 P		(32)	01.04.2011	(33)	US
(54)	METHODS FOR INCREASING EFFICACY OF FOLR1 CANCER THERAPY					
(72)	Carrigan, Christina, 4003 24th St., Apt. 3, San Francisco, CA 94114, US					
	Whiteman, Kathleen R., 512 Shawsheen Avenue, Wilmington, MA 01887, US					
	Payne, Gillian, 21 Oakvale Road, Waban, MA 02468, US					
	Ladd, Sharron, 9970 Joslin Lake Rd., Gregory, MI 48137, US					

(51)	MKP					
	A61K 31/506	2006	(97) EP 3622956			
	A61P 25/00	2006				
(96)	EP 19193122.9	3/12/2014				
(97)	EP 3622956,	10/14/2020	202042,	en		
(31)	201361780378 P		(32)	13.03.2013	(33)	US
(54)	SUBSTITUTED 2-AZABICYCLES AND THEIR USE AS OREXIN RECEPTOR MODULATORS					
(72)	GELIN, Christine F., 5035 Sterling Grove Lane, San Diego, CA 92130, US					
	LEBOLD, Terry P., 11296 Del Diablo Way, San Diego, CA 92129, US					
	SHIREMAN, Brock T., 12625 Birchbrook Court, Poway, CA 92064, US					
	ZIFF, Jeannie M., 3210 Merryfield Row, San Diego, CA 92121, US					

(51)	MKP					
	C07C 233/18	2006	(97) EP 3656758			
	C07D 213/30	2006				
	C07D 319/08	2006				
(96)	EP 19193576.6	2/8/2013				
(97)	EP 3656758,	1/6/2021	202101,	en		
(31)	201261597004 P		(32)	09.02.2012	(33)	US
(54)	INTERMEDIATES FOR THE PREPARATION OF C-TERMINAL HSP90 INHIBITORS					
(72)	BLAGG, Brian S. J., c/o University of Kansas 245 Strong Hall 1450 Jayhawk Boulevard, Lawrence, KS 66045, US					
	KUSUMA, Bhaskar, Reddy, 100 Ronkonkoma Ave. Apt. 12 G, Lake Ronkonkoma, NY 11779, US					
	SUNDSTROM, Teather, 205 N. 10th St., Canton, MO 63435, US					

(51)	MKP					
	A61K 9/00	2006	(97) EP 3636251			
	A61K 31/137	2006				
	A61K 47/02	2006				
	A61K 47/28	2006				
(96)	EP 19193900.8	3/14/2014				
(97)	EP 3636251,	11/25/2020	202048,	en		

(31) 201361791237 P (32) 15.03.2013 (33) US
 (54) PHARMACEUTICAL COMPOSITION OF S-KETAMINE HYDROCHLORIDE
 (72) BASSTANIE, Esther D. G., Nazarethpad 34, 2240 Zandhoven, BE
 BENTZ, Johanna, 36036 Bayonne Drive, Newark, CA California 94560, US
 EMBRECHTS, Roger C.A., Sperwersweg 5, 2360 Oud-Turnhout, BE
 NIEMEIJER, Nico Rudolph, Biesvelden 8, 5685 JB Best, NL

(51) MKP
A61K 31/47 2006 (97) EP 3626717
A61K 31/535 2006
A61P 37/00 2006
C07D 215/48 2006
C07D 401/10 2006
C07D 401/14 2006
C07D 403/14 2006
C07D 413/04 2006
C07D 413/14 2006
C07D 417/14 2006
C07D 451/04 2006
C07D 471/04 2006
C07D 471/10 2006
C07D 487/04 2006
C07D 487/10 2006
C07D 493/10 2006

(96) EP 19194302.6 10/14/2014

(97) EP 3626717, 10/28/2020 202044, en

(31) 201361890718 P (32) 14.10.2013 (33) US

(54) SELECTIVELY SUBSTITUTED QUINOLINE COMPOUNDS
 (72) HAWKINS, Lynn, 20 North Stone Mille Dr Unit 1016, Dedham, MA 02026, US
 CARLSON, Eric, 14 Blair Road, Merrimack, NH 03054, US
 HANSEN, Hans, 151 Tremont St., 25s, Boston, MA 02111, US
 MACKEY, Matthew, 52 Henry Avenue, Melrose, MA 02176, US
 SCHILLER, Shawn, 614 Hilldale Avenue, Haverhill, MA 01832, US
 OGAWA, Chikako, Lichtstrasse 35, 4056 Basel, CH
 DAVIS, Heather, 202 Morgan Drive, Haverhill, MA 01832, US

(51) MKP
A61K 31/7088 2006 (97) EP 3633035
A61P 21/00 2006
C12N 15/11 2006
C12N 15/113 2010

(96) EP 19194313.3 3/14/2014

(97) EP 3633035, 11/11/2020 202046, en

(31) 201361784547 P (32) 14.03.2013 (33) US

(54) EXON SKIPPING COMPOSITIONS FOR TREATING MUSCULAR DYSTROPHY
 (72) BESTWICK, Richard, K., 15052 Fall River Drive, Bend, OR 97707, US
 FRANK, Diane Elizabeth, 6049 34th Avenue NE, Seattle, WA 98115, US
 SCHNELL, Fred Joseph, c/o Sarepta Therapeutics, Inc. 215 First Street, Cambridge, MA 02142, US

(51) MKP
A61K 8/34 2006 (97) EP 3616678
A61K 8/9728 2017
A61Q 19/00 2006

(96) EP 19194440.4 8/29/2019

(97) EP 3616678, 10/14/2020 202042, en

(31) 201816117434 (32) 30.08.2018 (33) US

(54) TOPICAL COMPOSITION CONTAINING GLYCERIN AND YEAST EXTRACT
 (72) LIU-WALSH, Fang, c/o Johnson & Johnson Consumer Inc. 199 Grandview Road, Skillman, NJ New Jersey 08558, US
 RANDHAWA, Manpreet, c/o Johnson & Johnson Consumer Inc. 199 Grandview Road, Skillman, NJ New Jersey 08558, US
 CAPONE, Kimberly A., c/o Johnson & Johnson Consumer Inc. 199 Grandview Road, Skillman, NJ New Jersey 08558, US
 HAUSCHILD, James E., c/o Johnson & Johnson 1000 Route 202 South Bldg. 930 East, Raritan, NJ New Jersey 08869, US
 MAITRA, Prithwiraj, c/o Johnson & Johnson Consumer Inc. 199 Grandview Road, Skillman, NJ New Jersey 08558, US

(51) MKP
A61K 31/4375 2006 (97) EP 3617206
A61P 11/00 2006
C07D 471/04 2006
(96) EP 19194490.9 8/29/2019
(97) EP 3617206, 10/14/2020 202042, en
(31) 201862724423 P (32) 29.08.2018 (33) US
201962859457 P 10.06.2019 US
(54) INTEGRIN INHIBITORS
(72) HARRISON, Bryce, A., 7 Old Wood Road, Framingham, Massachusetts 01704, US
DOWLING, James, E., 6 Partridge Road, Lexington, Massachusetts 02420, US
BURSAVICH, Matthew, G., 172 Damon Road, Needham, Massachusetts 02494, US
TROAST, Dawn, M., 325 Spring Road, Bedford, Massachusetts 01730, US
LIPPA, Blaise, S., 784 Commonwealth Ave, Newton Center, MA 02459-1134, US
ROGERS, Bruce, N., 252 Common Street, Belmont, Massachusetts 02478, US
HAHN, Kristopher, N., 32 Webster Street, Medford, Massachusetts 02155, US
ZHONG, Cheng, 19 Burnham Street, D4, Belmont, Massachusetts 02478, US
QIAO, Qi, 17 Village Way, Apt. 7, Natick, Massachusetts 01760, US
LIN, Fu-Yang, 106 Gerry Road, Chestnut Hill, Massachusetts 02467, US
SOSA, Brian, 126 Pearl Street, Cambridge, Massachusetts 02139, US
GERASYUTO, Aleksey, I., 20 Skyline Drive, Flemington, New Jersey 08822, US
BORTOLATO, Andrea, 40 Martin Street, Metuchen, New Jersey 08840, US
SVENSSON, Mats, A., 160 West 24th Street, Apt. 19C, New York, New York 10011, US
HICKEY, Eugene, 5 Woodbury Drive, Danbury, Connecticut 06811, US
KONZE, Kyle, D., 339 3rd Street, Apt 2C,, Brooklyn, NY 11215, US
DAY, Tyler, 520 West 48th Street, Apt. 7G, New York, New York 10036, US
KIM, Byungchan, 20 Port Imperial 322, West New York, New Jersey 07093, US

(51) MKP
A61K 8/67 2006 (97) EP 3616681
A61K 8/9728 2017
A61Q 19/00 2006
(96) EP 19194766.2 8/30/2019
(97) EP 3616681, 10/14/2020 202042, en
(31) 201862724812 P (32) 30.08.2018 (33) US
(54) TOPICAL COMPOSITIONS COMPRISING PICHIA ANOMALA AND RETINOL
(72) RANDHAWA, Manpreet, 37 Cottage Place Drive, Robbinsville, NJ 08691, US
SOUTHALL, Michael D., Johnson & Johnson Consumer Inc. 199 Grandview Road, Skillman, NJ 08558, US

(51) MKP
A61K 8/60 2006 (97) EP 3616684
A61K 8/9728 2017
A61Q 17/00 2006
A61Q 19/00 2006
(96) EP 19194767.0 8/30/2019
(97) EP 3616684, 10/14/2020 202042, en
(31) 201862724820 P (32) 30.08.2018 (33) US
(54) TOPICAL COMPOSITIONS COMPRISING PICHIA ANOMALA AND N-ACETYL GLUCOSAMINE
(72) RANDHAWA, Manpreet, 37 Cottage Place Drive, Robbinsville, NJ New Jersey 08691, US
DUFORT, Marisa DeVita, Johnson & Johnson Consumer Inc. 307 College Road, East, Princeton, NJ New Jersey 08540, US
KONISH, Peter, Johnson & Johnson Consumer Inc. 307 College Road, East, Princeton, NJ New Jersey 08540, US
MAITRA, Prithwiraj, 27 Rouser Way, Hillsborough, NJ New Jersey 08844, US

(51) MKP
A01N 63/00 2020 (97) EP 3628161
A01N 65/00 2009
A61K 35/742 2015
A61K 35/744 2015
A61K 35/745 2015
A61K 35/747 2015
A61P 1/12 2006
A61P 31/04 2006
(96) EP 19194787.8 11/25/2013
(97) EP 3628161, 11/11/2020 202046, en

(31)	201261729519 P	(32)	23.11.2012	(33)	US
	201261729515 P		23.11.2012		US
	201261729520 P		23.11.2012		US
	201261729526 P		23.11.2012		US
	201261729517 P		23.11.2012		US
	201261729518 P		23.11.2012		US
	201261729527 P		23.11.2012		US
	201261729524 P		23.11.2012		US
	201261729525 P		23.11.2012		US
	201261729522 P		23.11.2012		US
	201261729521 P		23.11.2012		US
(54)	SYNERGISTIC BACTERIAL COMPOSITIONS AND METHODS OF PRODUCTION AND USE THEREOF				
(72)	VON MALTZAHN, Geoffrey, Flagship Pioneering, 55 Cambridge Parway, Cambridge, MA 02142, US				
	HENN, Matthew R., Seres Health Inc. 161 First Street Suite 1A, Cambridge, MA 02142, US				
	D'ONOFRIO, Anthony Mario, Seres Health Inc. 161 First Street Suite 1A, Cambridge, MA 02142, US				
	LITCOFSKY, Kevin Daniel, Seres Health Inc. 161 First Street Suite 1A, Cambridge, MA 02142, US				
	BERRY, David A., Flagship Pioneering, 55 Cambridge Parkway, Cambridge, MA 02142, US				
	COOK, David, 50 Sumner Road, Brookline, MA 02445, US				
	AFEYAN, Noubar, B., Flagship Pioneering, 55 Cambridge Parway, Cambridge, MA 02142, US				
	AUNINS, John, G., Seres Therapeutics, 200 Sidney Street, Cambridge, MA 02139, US				

(51)	MKP				
	C07D 471/04	2006	(97) EP 3656771		
(96)	EP 19195104.5 5/26/2010				
(97)	EP 3656771, 1/6/2021 202101, en				
(31)	18120309 P	(32)	26.05.2009	(33)	US
(54)	PROCESS FOR THE PREPARATION OF A SYNTHETIC INTERMEDIATE FOR APOPTOSIS-INDUCING AGENTS				
(72)	BRUNCKO, Milan, 31231 Prairie Ridge, Green Oaks, IL 60048, US				
	DING, Hong, 9 Mayfair Lane, Lincolnshire, IL 60069, US				
	DOHERTY, George, 1605 Bush Court, Libertyville, IL 60048, US				
	ELMORE, Steven, 239 Ash Lane, Northbrook, IL 60062, US				
	HASVOLD, Lisa, 522 Shakespeare Drive, Grayslake, IL 60030, US				
	HEXAMER, Laura, 439 Gatewood Lane, Grayslake, IL 60030, US				
	KUNZER, Aaron R., 615 W. Burr Oak Drive, Arlington, IL 60004, US				
	SONG, Xiaohong, 34037 Sulkey Drive, Grayslake, IL 60030, US				
	SOUERS, Andrew J., 156 Blueberry Road, Libertyville, IL 60048, US				
	SULLIVAN, Gerald, 1212 Tulip Tree Court, Lake Villa, IL 60046, US				
	TAO, Zhi-Fu, 303 Hobbles Bush Lane, Vernon Hills, IL 60061, US				
	WANG, Gary T., 1904 Darnell Street, Libertyville, IL 60048, US				
	WANG, Le, 338 East Colonial Drive, Vernon Hills, IL 60061, US				
	WANG, Xilu, 1617 Eric Lane, Libertyville, IL 60048, US				
	WENDT, Michael, 1445 Maidstone Drive, Vernon Hills, IL 60061, US				
	MANTEL, Robert, 4203 Carolyn Court, Franklin, WI 53132, US				
	HANSEN, Todd M., 191 Seymour Avenue, Grayslake, IL 60030, US				

(51)	MKP				
	G10K 11/178	2006	(97) EP 3624112		
	H04R 1/10	2006			
(96)	EP 19195322.3 9/4/2019				
(97)	EP 3624112, 10/28/2020 202044, en				
(31)	18193193	(32)	07.09.2018	(33)	EP
	505182019		07.06.2019		AT
	201916535486		08.08.2019		US
(54)	IN-EAR ANC EARPHONE				
(71)	Austrian Audio GmbH, Eitnergasse 15, 1230 Wien, AT				
(72)	Perkmann, Michael, Markgraf-Rüdiger-Strasse 7/71, 1150 Wien, AT				
	Wöhrer, Daniel, Wohlmuthgasse 13, 3003 Gablitz, AT				

(51)	MKP				
	A61K 8/31	2006	(97) EP 3620213		
	A61K 8/37	2006			
	A61K 8/39	2006			
	A61K 8/67	2006			
	A61K 8/86	2006			

	A61P 17/00	2006					
	A61P 17/10	2006					
	A61Q 19/00	2006					
	A61Q 19/06	2006					
	A61Q 19/08	2006					
(96)	EP 19195873.5	9/6/2019					
(97)	EP 3620213, 10/14/2020	202042, en					
(31)	201862728941 P		(32)	10.09.2018		(33)	US
(54)	RETINOL OIL COMPOSITION						
(72)	PARSA, Ramine, Johnson & Johnson Consumer Inc. 199 Grandview Road, Skillman, NJ New Jersey 08558, US						
	BRILLOUET, Anne-Sophie, Johnson & Johnson Consumer Inc. 199 Grandview Road, Skillman, NJ New Jersey 08558, US						
	CHANG, Michael, Johnson & Johnson Consumer Inc. 199 Grandview Road, Skillman, NJ New Jersey 08558, US						
	WALSH, Star Marie, Johnson & Johnson Consumer Inc. 199 Grandview Road, Skillman, NJ New Jersey 08558, US						
<hr/>							
(51)	MKP						
	B61D 7/20	2006	(97) EP 3623245				
	B61D 7/28	2006					
	B61D 7/32	2006					
	E01B 27/02	2006					
(96)	EP 19196569.8	9/10/2019					
(97)	EP 3623245, 10/14/2020	202042, fr					
(31)	1871046		(32)	14.09.2018		(33)	FR
(54)	DEVICE FOR UNLOADING BALLAST, AND RAILWAY VEHICLE FOR BALLASTING EQUIPPED WITH SUCH A DEVICE						
(71)	Rolanfer Materiel ferroviaire, Actypole 6, Rue Thomas Edison, 57970 Yutz, FR						
(72)	DAUSSE, Stéphanie, 6 chemin derrière la croix, 57140 LA MAXE, FR						
<hr/>							
(51)	MKP						
	E05F 11/48	2006	(97) EP 3636867				
	E05F 15/689	2015					
(96)	EP 19196609.2	9/11/2019					
(97)	EP 3636867, 11/25/2020	202048, de					
(31)	102018217247		(32)	09.10.2018		(33)	DE
(54)	DEVICE AND METHOD FOR CONNECTING TWO COMPONENTS, ESPECIALLY A MOTOR VEHICLE WINDOW REGULATOR						
(72)	AMFT, Marcel, Bogenstraße 5, 96175 Pettstadt, DE						
	DOHLES, Hilmar, Rosengasse 15, 96274 Itzgrund, DE						
	HEPPT, Franz, Unterer Pelzhügel 17f, 96450 Coburg, DE						
<hr/>							
(51)	MKP						
	B60P 1/16	2006	(97) EP 3623215				
	B60P 1/64	2006					
(96)	EP 19196762.9	9/11/2019					
(97)	EP 3623215, 10/28/2020	202044, de					
(31)	202018105235 U		(32)	12.09.2018		(33)	DE
(54)	TRANSPORT VEHICLE FOR ROLLING CONTAINERS						
(72)	REUTER, Henry, Bredower Straße 70, 14612 Falkensee, DE						
<hr/>							
(51)	MKP						
	B60P 1/64	2006	(97) EP 3623218				
(96)	EP 19196808.0	9/11/2019					
(97)	EP 3623218, 10/28/2020	202044, de					
(31)	102018122318		(32)	12.09.2018		(33)	DE
(54)	CARRIAGE FOR A TRANSPORT VEHICLE FOR TRANSPORTING ROLLING CONTAINERS						
(71)	Hüffermann Transportsysteme GmbH, Kampehler Strasse 10, 16845 Neustadt/Dosse, DE						
(72)	REUTER, Henry, Fuggerstrasse 19, 14612 Falkensee, DE						
<hr/>							
(51)	MKP						
	A23L 3/00	2006	(97) EP 3650363				
	A23L 3/04	2006					
	B65B 55/02	2006					
	B65B 55/04	2006					
	B65B 55/10	2006					
(96)	EP 19196905.4	10/26/2016					

(97) EP 3650363, 10/28/2020 202044, de
 (31) 102015013914 (32) 27.10.2015 (33) DE
 (54) FOOD PROCESSING SYSTEM WITH SEVERAL CLOSED AREAS, BETWEEN WHICH A CONTAINER CONVEYOR IS ARRANGED
 (72) MOSER, Gerhard, Mühlbach 68, 4801 Traunkirchen, AT
 MOSER, Martin, Mühlbach 68, 4801 Traunkirchen, AT

(51) MKP
A61K 31/4985 2006 (97) EP 3613745
A61P 35/00 2006
C07D 487/04 2006
 (96) EP 19196939.3 7/1/2016
 (97) EP 3613745, 9/30/2020 202040, en
 (31) 201562188468 P (32) 02.07.2015 (33) US
 201562271708 P 28.12.2015 US
 (54) SOLID FORMS AND FORMULATIONS OF (S)-4-(8-AMINO-3-(1-(BUT-2-YNOYL)PYRROLIDIN-2-YL)IMIDAZO[1,5-A]PYRAZIN-1-YL)-N-(PYRIDIN-2-YL)BENZAMIDE
 (72) BLATTER, Fritz, Oerinstrasse 67, CH-4153 Reinach, CH
 INGALLINERA, Tim, 987 Haight Street Apt. 8, San Francisco, CA 94117, US
 BARF, Tjeerd, St. Luciastraat 7, 5371 AS Ravenstein, NL
 ARET, Edwin, Stellingmolenstraat 109, 1333 CJ Almere, NL
 KREJSA, Cecile, 3222 Northwest 65th Street, Seattle, WA 98117, US
 EVARTS, Jerry, 14491 NE 57th Street, Bellevue, WA 98007, US

(51) MKP
C07K 16/24 2006 (97) EP 3653645
G01N 33/53 2006
 (96) EP 19196963.3 7/5/2012
 (97) EP 3653645, 12/30/2020 202053, en
 (31) 201161510268 P (32) 21.07.2011 (33) US
 (54) INTERLEUKIN-31 MONOCLONAL ANTIBODY
 (72) BMMERT, Gary F., 5339 Woodmont Drive, Portage, MI 49002, US
 DUNHAM, Steven A., 3939 Old Colony Road, Kalamazoo, MI 49008, US

(51) MKP
C12N 5/0781 2010 (97) EP 3647412
C12N 5/0783 2010
 (96) EP 19197801.4 4/23/2015
 (97) EP 3647412, 12/16/2020 202051, en
 (31) 201461983415 P (32) 23.04.2014 (33) US
 (54) METHODS FOR ISOLATING, CULTURING, AND GENETICALLY ENGINEERING IMMUNE CELL POPULATIONS FOR ADOPTIVE THERAPY
 (72) RAMSBORG, Chris, 307 Westlake Avenue North Suite 300, Seattle, WA 98109, US
 BONYHADI, Mark, L., 307 Westlake Avenue North Suite 300, Seattle, WA 98109, US
 CHAN, Calvin, 307 Westlake Avenue North Suite 300, Seattle, WA 98109, US
 BEAUCHESNE, Pascal, 307 Westlake Avenue North Suite 300, Seattle, WA 98109, US

(51) MKP
A61K 31/44 2006 (97) EP 3653209
A61K 31/519 2006
A61K 31/527 2006
A61P 35/00 2006
C07D 491/14 2006
 (96) EP 19198057.2 3/14/2014
 (97) EP 3653209, 12/30/2020 202053, en
 (31) 201361798772 P (32) 15.03.2013 (33) US
 201361861374 P 01.08.2013 US
 201361911354 P 03.12.2013 US
 201461949786 P 07.03.2014 US
 (54) TRANSIENT PROTECTION OF NORMAL CELLS DURING CHEMOTHERAPY
 (71) G1 Therapeutics, Inc., 700 Park Offices Drive, Suite 200, Research Triangle Park, NC 27709, US
 (72) STRUM, Jay, Copeland, c/o G1 Therapeutics Inc. 450 West Drive CB 7295, Chapel Hill, NC North Carolina 27599-72995, US
 BISI, John, Emerson, c/o G1 Therapeutics Inc. 450 West Drive CB 7295, Chapel Hill, NC North Carolina 27599-72995, US
 ROBERTS, Patrick, Joseph, c/o G1 Therapeutics Inc. 450 West Drive CB 7295, Chapel Hill, NC North Carolina 27599-72995, US
 TAVARES, Francis, Xavier, c/o G1 Therapeutics Inc. 450 West Drive CB 7295, Chapel Hill, NC North Carolina 27599-72995, US

(51) MKP
F16B 21/02 2006 (97) EP 3627024
F16L 1/024 2006
F16L 3/10 2006
F16L 3/24 2006
H02G 3/30 2006
H02G 3/32 2006

(96) EP 19198352.7 9/19/2019
(97) EP 3627024, 12/30/2020 202053, de

(31) 18195607 (32) 20.09.2018 (33) EP

(54) INSERTABLE TUBE CLAMP WITH FRAME AND CLAMP
(71) Renner AG, Industriestrasse 5c, 8864 Reichenburg, CH
(72) GÖKTAS, Dogan, Industriestrasse 5c, 8864 Reichenburg, CH

(51) MKP
F16B 21/02 2006 (97) EP 3627025
F16L 1/024 2006
F16L 3/10 2006
F16L 3/24 2006
H02G 3/30 2006
H02G 3/32 2006

(96) EP 19198353.5 9/19/2019
(97) EP 3627025, 12/30/2020 202053, de

(31) 18195607 (32) 20.09.2018 (33) EP

(54) INSERTABLE TUBE CLAMP WITH FLOOR PLATE
(72) GÖKTAS, Dogan, Industriestrasse 5c, 8864 Reichenburg, CH

(51) MKP
A61K 47/68 2017 (97) EP 3653228
A61P 35/00 2006
C07K 16/28 2006

(96) EP 19199163.7 10/8/2014
(97) EP 3653228, 12/30/2020 202053, en

(31) 201361888337 P (32) 08.10.2013 (33) US
201361888365 P 08.10.2013 US
201461948363 P 05.03.2014 US
201462004815 P 29.05.2014 US

(54) ANTI-FOLR1 IMMUNOCONJUGATE DOSING REGIMENS
(72) LUTZ, Robert J., 218 Old Connecticut Path, Wayland, MA 01778, US
PONTE, Jose, 83 Cottage Lane, Weymouth, MA 02188, US

(51) MKP
A61K 31/337 2006 (97) EP 3620159
A61K 31/519 2006
A61P 35/00 2006

(96) EP 19199392.2 4/2/2012
(97) EP 3620159, 10/21/2020 202043, en

(31) 201161470668 P (32) 01.04.2011 (33) US

(54) THERAPEUTIC TREATMENT
(72) DAVIES, Barry, Robert, AstraZeneca R&D Alderley Alderley Park, Macclesfield, Cheshire SK10 4TG, GB

(51) MKP
A61K 39/00 2006 (97) EP 3660029
C07H 21/04 2006

(96) EP 19199404.5 12/9/2011
(97) EP 3660029, 1/6/2021 202101, en

(31) 42147010 P (32) 09.12.2010 (33) US
201161502649 P 29.06.2011 US

(54) USE OF CHIMERIC ANTIGEN RECEPTOR-MODIFIED T CELLS TO TREAT CANCER
(72) JUNE, Carl H., 409 Baird Road, Merion Station, PA 19066, US
LEVINE, Bruce L., 1258 Liberty Bell Drive, Cherry Hill, NJ 08003, US

PORTER, David L., 821 Crum Creek Road, Springfield, PA 19064, US
 KALOS, Michael D., 716 Carpenter Lane, Philadelphia, PA 19119, US
 MILONE, Michael C., 314 Surrey Road, Cherry Hill, NJ 08002, US

(51) MKP
A61K 31/225 2006 (97) EP 3650042
A61K 39/05 2006
A61K 39/09 2006
A61P 25/28 2006
A61P 31/00 2006
 (96) EP 19199534.9 3/13/2015
 (97) EP 3650042, 12/16/2020 202051, en
 (31) 201461953259 P (32) 14.03.2014 (33) US
 (54) DIMETHYL FUMARATE AND VACCINATION REGIMENS
 (72) Viglietta, Vissia, 40 Seymour Street, Boston, MA 02131, US

(51) MKP
C07D 487/04 2006 (97) EP 3653628
 (96) EP 19200626.0 7/21/2016
 (97) EP 3653628, 12/23/2020 202052, en
 (31) 201562195023 P (32) 21.07.2015 (33) US
 201662327973 P 26.04.2016 US
 (54) METHODS OF PREPARING CYTOTOXIC BENZODIAZEPINE DERIVATIVES
 (72) GÉRARD, Baudouin, 27 Silk Street, Arlington, MA 02474, US
 SHIZUKA, Manami, 253 Payson Road, Belmont, MA 02478, US
 MILLER, Michael Louis, 4 Maymont Drive, Framingham, MA 01701, US
 SILVA, Richard A, 587 Greendale Avenue, Needham, MA 02492, US

(51) MKP
A01K 29/00 2006 (97) EP 3745850
A01K 31/18 2006
A01K 31/19 2006
A01K 31/22 2006
 (96) EP 18903323.6 11/30/2018
 (97) EP 3745850, 12/9/2020 202050, en
 (31) 2018900295 (32) 31.01.2018 (33) AU
 (54) METHOD AND DEVICE FOR RAISING JUVENILE FARM ANIMALS
 (71) MIMICTEC PTY LTD, Level 1/ 333 Exhibition Street, Melbourne, VIC 3000, AU
 (72) LAST, Sarah, Level 1 / 333 Exhibition Street, Melbourne, VIC 3000, AU

(51) MKP
B61C 17/00 2006 (97) EP 3725635
 (96) EP 18918193.6 9/29/2018
 (97) EP 3725635, 10/21/2020 202043, en
 (31) 201810450847 (32) 11.05.2018 (33) CN
 (54) ACTIVATION CONTROL METHOD AND DEVICE FOR RAIL TRAIN
 (72) LI, Xingguo, No.88 Jinhongdong Road, Chengyang District, Qingdao, Shandong 266111, CN
 LIU, Tai, No.88 Jinhongdong Road, Chengyang District, Qingdao, Shandong 266111, CN
 ZHANG, Huiqing, No.88 Jinhongdong Road, Chengyang District, Qingdao, Shandong 266111, CN

(51) MKP
B65D 23/00 2006 (97) EP 3717371
B65D 43/16 2006
B65D 81/32 2006
B65D 81/38 2006
B65D 85/80 2006
 (96) EP 18924062.5 12/11/2018
 (97) EP 3717371, 10/7/2020 202041, en
 (31) 201816019232 (32) 26.06.2018 (33) US
 (54) DISPENSING CONTAINER WITH INTERIOR ACCESS
 (71) Velmont & Company, Inc., 145 North 5th Street No.856, Montebello, California 90640, US

(72) VELMONT, Rashon, 145 North 5th Street, 856, Montebello, California 90640, US
 VELMONT, Sebastian, 145 North 5th Street, 856, Montebello, California 90640, US

(51) MKP
B61D 17/00 2006 (97) EP 3725638
B61F 1/00 2006
B61F 19/04 2006

(96) EP 18932821.4 9/29/2018

(97) EP 3725638, 10/21/2020 202043, en

(31) 201811039092 (32) 06.09.2018 (33) CN

(54) COLLISION ENERGY ABSORPTION STRUCTURE AND RAIL VEHICLE HAVING SAME

(71) CRRC QINGDAO SIFANG CO., LTD., No. 88 Jinhongdong Road, Chengyang District Qingdao Shandong 266111, CN

(72) YU, Haiyang, No.88 Jinhongdong Road, Chengyang District, Qingdao, Shandong 266111, CN

LIU, Yuwen, No.88 Jinhongdong Road, Chengyang District, Qingdao, Shandong 266111, CN

TIAN, Aiqin, No.88 Jinhongdong Road, Chengyang District, Qingdao, Shandong 266111, CN

TIAN, Honglei, No.88 Jinhongdong Road, Chengyang District, Qingdao, Shandong 266111, CN

YU, Yangyang, No.88 Jinhongdong Road, Chengyang District, Qingdao, Shandong 266111, CN

(51) MKP
A61B 17/00 2006 (97) EP 3756606
A61B 34/30 2016

(96) EP 18938213.8 10/25/2018

(97) EP 3756606, 12/30/2020 202053, en

(54) SURGICAL ROBOT MECHANISM WITH SINGLE-PORT AND MULTI-PORT MINIMALLY INVASIVE OPERATION FUNCTIONS

(71) Tianjin University, No. 135 Yaguan Road Haihe Education Park Jinnan District, Tianjin 300354, CN

(72) WANG, Shuxin, No.135 Yaguan Road, Haihe Education Park, Jinnan District, Tianjin 300354, CN

HU, Zhenxuan, No.135 Yaguan Road, Haihe Education Park, Jinnan District, Tianjin 300354, CN

ZHANG, Guokai, No.135 Yaguan Road, Haihe Education Park, Jinnan District, Tianjin 300354, CN

GAO, Dezhong, No.135 Yaguan Road, Haihe Education Park, Jinnan District, Tianjin 300354, CN

LI, Jianmin, No.135 Yaguan Road, Haihe Education Park, Jinnan District, Tianjin 300354, CN

LI, Jinhua, No.135 Yaguan Road, Haihe Education Park, Jinnan District, Tianjin 300354, CN

(51) MKP
G06F 3/048 2013 (97) EP 3742269

(96) EP 18900885.7 12/26/2018

(97) EP 3742269, 11/25/2020 202048, en

(31) 201810054939 (32) 19.01.2018 (33) CN

(54) VIEWING ANGLE ADJUSTMENT METHOD AND APPARATUS, STORAGE MEDIUM, AND ELECTRONIC APPARATUS

(71) Tencent Technology (Shenzhen) Company Limited, 35/F, Tencent Building Kejizhongyi Road Midwest District of Hi-tech Park Nanshan District, Shenzhen City, Guangdong 518057, CN

(72) HE, Ning, 35/F, Tencent Building Kejizhongyi Road, Midwest District of Hi-tech Park, Nanshan District, Shenzhen city, Guangdong 518057, CN

YANG, Yiqing, 35/F, Tencent Building Kejizhongyi Road, Midwest District of Hi-tech Park, Nanshan District, Shenzhen city, Guangdong 518000, CN

DENG, Yang, 35/F, Tencent Building Kejizhongyi Road, Midwest District of Hi-tech Park, Nanshan District, Shenzhen city, Guangdong 518000, CN

(51) MKP
A61N 2/00 2006 (97) EP 3744392

(96) EP 18902851.7 1/24/2018

(97) EP 3744392, 12/2/2020 202049, en

(54) METHOD FOR CARTILAGE REGENERATION, MAGNETIC PULSE DEVICE, AND COIL APPLIED TO MAGNETIC PULSE DEVICE

(71) Hefei Institutes of Physical Science, Chinese Academy of Sciences, No.350 Shushanhu Road Shushan District, Hefei, Anhui 230031, CN

(72) ZHONG, Kai, No. 350, Shushanhu Road Shushan District, Hefei, Anhui 230031, CN

ZHANG, Xiaoming, No. 350, Shushanhu Road Shushan District, Hefei, Anhui 230031, CN

ZHANG, Jin, No. 350, Shushanhu Road Shushan District, Hefei, Anhui 230031, CN

TONG, Haiyang, No. 350, Shushanhu Road Shushan District, Hefei, Anhui 230031, CN

YANG, Hongyi, No. 350, Shushanhu Road Shushan District, Hefei, Anhui 230031, CN

(51) MKP
B08B 3/02 2006 (97) EP 3623064
B08B 9/08 2006

(96) EP 19460046.6 9/10/2019

(97) EP 3623064, 10/21/2020 202043, en
 (31) 42704918 (32) 13.09.2018 (33) PL
 (54) A DEVICE AND METHOD FOR WASHING STORAGE CONTAINERS
 (71) Elkom Trade Spółka Akcyjna, Al. Stanów Zjednoczonych 51/622A, 04-028 Warszawa, PL
 (72) KOLT, Andrzej, os. Pulanki 31/12, 27-400 Ostrowiec Swietokrzyski, PL
 BISIKIEWICZ, Michał, ul. Sprzetowa 3C, 10-467 Olsztyn, PL

(51) MKP
A61K 31/437 2006 (97) EP 3735411
A61P 25/28 2006
C07D 471/04 2006
 (96) EP 19700206.6 1/4/2019
 (97) EP 3735411, 11/11/2020 202046, en
 (31) 18150422 (32) 05.01.2018 (33) EP
 18175852 04.06.2018 EP
 (54) 1, 3, 4, 5-TETRAHYDRO-2H-PYRIDO[4,3-B]INDOLE DERIVATIVES FOR THE TREATMENT, ALLEVIATION OR PREVENTION OF
 DISORDERS ASSOCIATED WITH TAU AGGREGATES LIKE ALZHEIMER'S DISEASE
 (72) NAMPALLY, Sreenivasachary, Route Neuve 87, 1024 Ecublens, CH
 GABELLIERI, Emanuele, Chemin de Fontanney 39, 1052 le mont sur Lausanne, CH
 MOLETTE, Jérôme, 37 La Ruelle Bretigny, 01280 Preussin Moens, FR

(51) MKP
A61K 9/20 2006 (97) EP 3735227
A61K 31/192 2006
A61K 31/205 2006
 (96) EP 19700330.4 1/3/2019
 (97) EP 3735227, 11/11/2020 202046, en
 (31) 18150490 (32) 05.01.2018 (33) EP
 (54) IMMEDIATE-RELEASE PHARMACEUTICAL COMPOSITIONS CONTAINING KETOPROFEN LYSINE SALT
 (71) Dompé farmaceutici S.p.a., Via Santa Lucia, 6, 20122 Milano, IT
 (72) CANTARINI, Marco, Via Pedemonte, 8, 22100 Como (CO), IT
 GENTILE, Marco Maria, Via Collevernesco, 138, 67100 L'Aquila (AQ), IT
 PROTA, Lucia, Via Madonna del Carmine, 98, 84043 Agropoli (SA), IT

(51) MKP
B44C 1/22 2006 (97) EP 3737780
C23F 1/02 2006
 (96) EP 19700676.0 1/11/2019
 (97) EP 3737780, 11/18/2020 202047, en
 (31) 18151413 (32) 12.01.2018 (33) EP
 (54) PROCESS FOR MAKING ETCHED PATTERNS
 (72) BOLLSTRÖM, Roger, Ackerstrasse 11, 4800 Zofingen, CH
 HUNZIKER, Philipp, 1337 Harbor Cove, Loveland, Ohio 45140, US
 FTOUNI, Jamal, Vordere Hauptgasse 86, 4800 Zofingen, CH
 IWANOWSKA, Monika, Turbinenstrasse 41, 8005 Zürich, CH

(51) MKP
A61K 31/4184 2006 (97) EP 3740478
A61P 29/00 2006
C07D 403/12 2006
C07D 403/14 2006
C07D 405/14 2006
C07D 413/12 2006
C07D 413/14 2006
C07D 487/04 2006
 (96) EP 19700777.6 1/10/2019
 (97) EP 3740478, 11/25/2020 202048, en
 (31) 201800639 (32) 15.01.2018 (33) GB
 201820172 11.12.2018 GB
 (54) FUSED IMIDAZOLE DERIVATIVES AS IL-17 MODULATORS
 (72) BRACE, Gareth Neil, c/o Evotec (UK) Ltd 114 Innovation Drive, Milton Park, Abingdon, Oxfordshire OX14 4RZ, GB
 CHAPPELL, Rose Elizabeth, c/o Evotec (UK) Ltd 114 Innovation Drive, Milton Park, Abingdon, Oxfordshire OX14 4RZ, GB
 FOULKES, Gregory, c/o Evotec (UK) Ltd 114 Innovation Drive, Milton Park, Abingdon, Oxfordshire OX14 4RZ, GB

FROST, James Richard, c/o UCB Celltech, 208 Bath Road, Slough, Berkshire SL1 3WE, GB
 HORSLEY, Helen Tracey, c/o UCB Celltech, 208 Bath Road, Slough, Berkshire SL1 3WE, GB
 JONES, Elizabeth Pearl, c/o Syngenta International Research Centre Jealott's Hill, Bracknell, Berkshire RG42 6EY, GB
 LECOMTE, Fabien Claude, c/o UCB Celltech, 208 Bath Road, Slough, Berkshire SL1 3WE, GB
 REUBERSON, James Thomas, c/o UCB Celltech, 208 Bath Road, Slough, Berkshire SL1 3WE, GB
 SCHULZE, Monika-Sarah Elisabeth Dorothea, c/o UCB Celltech, 208 Bath Road, Slough, Berkshire SL1 3WE, GB
 TAYLOR, Richard David, c/o UCB Celltech, 208 Bath Road, Slough, Berkshire SL1 3WE, GB
 YAU, Wei Tsung, c/o Evotec (UK) Ltd 114 Innovation Drive, Milton Park, Abingdon, Oxfordshire OX14 4RZ, GB
 ZHU, Zhaoning, c/o UCB Celltech, 208 Bath Road, Slough, Berkshire SL1 3WE, GB

- (51) MKP
A61K 31/519 2006 (97) EP 3740489
A61P 31/16 2006
C07D 487/04 2006
- (96) EP 19700804.8 1/15/2019
 (97) EP 3740489, 11/25/2020 202048, en
- (31) 201800734 (32) 17.01.2018 (33) GB
 201817616 29.10.2018 GB
- (54) PI4KIIIBETA INHIBITORS
 (72) BARTON, Nicholas Paul, GlaxoSmithKline, Gunnels Wood Road, Stevenage, Hertfordshire SG1 2NY, GB
 BERTRAND, Sophie Marie, GlaxoSmithKline, Gunnels Wood Road, Stevenage, Hertfordshire SG1 2NY, GB
 DOWN, Kenneth, GlaxoSmithKline, Gunnels Wood Road, Stevenage, Hertfordshire SG1 2NY, GB
 GRAY, Matthew, GlaxoSmithKline, Gunnels Wood Road, Stevenage, Hertfordshire SG1 2NY, GB

- (51) MKP
A61K 9/00 2006 (97) EP 3740191
A61K 31/454 2006
A61K 47/40 2006
A61P 27/14 2006
- (96) EP 19701154.7 1/9/2019
 (97) EP 3740191, 11/25/2020 202048, en
- (31) 18382021 (32) 18.01.2018 (33) EP
- (54) OPHTHALMIC COMPOSITIONS COMPRISING BILASTINE, A BETA-CYCLODEXTRIN AND AT LEAST ONE GELLING AGENT
 (72) HERNÁNDEZ HERRERO, Gonzalo, FAES FARMA, S.A. Autonomía, 10, 48940 Leioa - Vizcaya, ES
 GONZALO GOROSTIZA, Ana, FAES FARMA, S.A. Autonomía, 10, 48940 Leioa - Vizcaya, ES
 MORÁN POLADURA, Pablo, FAES FARMA, S.A. Autonomía, 10, 48940 Leioa - Vizcaya, ES
 ZAZPE ARCE, Arturo, FAES FARMA, S.A. Autonomía, 10, 48940 Leioa - Vizcaya, ES
 FERNÁNDEZ HERNANDO, Nieves, FAES FARMA, S.A. Autonomía, 10, 48940 Leioa - Vizcaya, ES
 GONZÁLEZ GARCÍA, Tania, FAES FARMA, S.A. Autonomía, 10, 48940 Leioa - Vizcaya, ES
 TATO CERDEIRAS, Paloma, FAES FARMA, S.A. Autonomía, 10, 48940 Leioa - Vizcaya, ES
 OTERO ESPINAR, Francisco Javier, UNIVERSIDADE DE SANTIAGO DE COMPOSTELA Department of Pharmacy and Pharmaceutical Technology Faculty of Pharmacy, Campus Vida, s/n, 15782 Santiago de Compostela - A Coruña, ES
 FERNÁNDEZ FERREIRO, Anxo, UNIVERSIDADE DE SANTIAGO DE COMPOSTELA Department of Pharmacy and Faculty of Pharmacy, Campus Vida, s/n, 15782 Santiago de Compostela - A Coruña, ES
 DÍAZ TOMÉ, Victoria, UNIVERSIDAD DE SANTIAGO DE COMPOSTELA Department of Pharmacy and Pharmaceutical Technology Faculty of Pharmacy, Campus Vida, s/n, 15782 Santiago de Compostela - A Coruña, ES

- (51) MKP
A61K 31/437 2006 (97) EP 3746437
A61P 1/16 2006
A61P 19/02 2006
A61P 25/00 2006
C07D 405/04 2006
C07D 471/04 2006
- (96) EP 19701674.4 1/30/2019
 (97) EP 3746437, 12/9/2020 202050, en
- (31) 18154454 (32) 31.01.2018 (33) EP
 18183692 16.07.2018 EP
- (54) PROTEIN KINASE MKK4 INHIBITORS FOR PROMOTING LIVER REGENERATION OR REDUCING OR PREVENTING HEPATOCYTE DEATH
 (71) HepaRegeniX GmbH, Wilhelmstrasse 16, 72074 Tübingen, DE
 (72) PRAEFKE, Bent, Clinicumsgasse 6, 72070 Tübingen, DE
 KLÖVEKORN, Philip, Quellenstraße 5, 72124 Pliezhausen, DE
 SELIG, Roland, Maglrushof 51, 89077 Ulm, DE

ALBRECHT, Wolfgang, Alfred-Mendler-Weg 25/1, 89075 Ulm, DE
LAUFER, Stefan, Otto-Erbe-Weg 86, 72070 Tübingen, DE

- (51) MKP
A61K 35/74 2015 (97) EP 3740218
A61K 39/395 2006
A61P 35/00 2006
- (96) EP 19701725.4 1/18/2019
(97) EP 3740218, 11/25/2020 202048, en
- (31) 201800927 (32) 19.01.2018 (33) GB
201801502 30.01.2018 GB
201805941 10.04.2018 GB
201806572 23.04.2018 GB
201808628 25.05.2018 GB
- (54) COMBINATION THERAPY FOR TREATING OR PREVENTING CANCER
(72) STEVENSON, Alexander, c/o 4D Pharma PLC 9 Bond Court, Leeds, West Yorkshire LS1 2JZ, GB

- (51) MKP
A61K 31/407 2006 (97) EP 3740492
A61P 35/00 2006
A61P 37/00 2006
C07D 487/10 2006
- (96) EP 19701777.5 1/9/2019
(97) EP 3740492, 11/25/2020 202048, en
- (31) 18461506 (32) 16.01.2018 (33) EP
- (54) 1,2,3',5'-TETRAHYDRO-2'H-SPIRO[INDOLE-3,1'-PYRROLO[3,4-C]PYRROLE]-2,3'-DIONE COMPOUNDS AS THERAPEUTIC AGENTS
ACTIVATING TP53
- (72) FEDER, Marcin, ul. Obronców Tobruku 19/118, 01-494 Warszawa, PL
MAZUR, Maria, ul. Generała Sylwestra Kaliskiego 45/161, 01-476 Warszawa, PL
KALINOWSKA, Iwona, ul. Skalskiego 3/27, 03-982 Warszawa, PL
JASZCZEWSKA-ADAMCZAK, Joanna, ul. Gen. Ludomila Rayskiego 3/69, 01-307 Warszawa, PL
LEWANDOWSKI, Wojciech, ul. Basniowa 3, 05-600 Grojec, PL
WITKOWSKI, Jakub, ul. Odkryta 65E/10, 03-140 Warszawa, PL
JELEN, Sabina, ul. Rudnickiego 10A/3, 01-858 Warszawa, PL
WOS-LATOSI, Katarzyna, ul. Koscielna Droga 117, 05-092 Lomianki, PL

- (51) MKP
A61K 9/00 2006 (97) EP 3737386
A61K 31/7105 2006
A61K 39/12 2006
C12N 15/87 2006
- (96) EP 19701783.3 1/10/2019
(97) EP 3737386, 11/18/2020 202047, en
- (31) PCT/EP2018/050672 (32) 11.01.2018 (33) WO
- (54) FORMULATION FOR ADMINISTRATION OF RNA
- (72) SAHIN, Ugur, c/o BioNTech AG An der Goldgrube 12, 55131 Mainz, DE
HAAS, Heinrich, c/o BioNTech AG An der Goldgrube 12, 55131 Mainz, DE
VOGEL, Annette, c/o BioNTech AG An der Goldgrube 12, 55131 Mainz, DE
ERBAR, Stephanie, c/o BioNTech AG An der Goldgrube 12, 55131 Mainz, DE
WALZER, Kerstin, c/o BioNTech AG An der Goldgrube 12, 55131 Mainz, DE
SCHLEGEL, Anne, c/o BioNTech AG An der Goldgrube 12, 55131 Mainz, DE
HÖRNER, Sebastian, c/o BioNTech AG An der Goldgrube 12, 55131 Mainz, DE
MORENO HERRERO, Jorge, c/o BioNTech AG An der Goldgrube 12, 55131 Mainz, DE
KLAMP, Thorsten, c/o BioNTech AG An der Goldgrube 12, 55131 Mainz, DE
KREITER, Sebastian, Niklas-Vogt-Str. 3, 55131 Mainz, DE
DIKEN, Mustafa, Im Hasenstock 2, 55130 Mainz, DE
HELLER, Phillip, c/o BioNTech AG An der Goldgrube 12, 55131 Mainz, DE

- (51) MKP
C07K 16/00 2006 (97) EP 3743440
C07K 16/28 2006
C07K 16/30 2006
- (96) EP 19702060.5 1/24/2019

(97) EP 3743440, 12/2/2020 202049, en
 (31) PA201800041 (32) 24.01.2018 (33) DK
 (54) POLYPEPTIDE VARIANTS AND USES THEREOF
 (71) Genmab B.V., Uppsalalaan 15, 3584 CT Utrecht, NL
 (72) OOSTINDIE, Simone, c/o Genmab B.V. Uppsalalaan 15, 3584 CT Utrecht, NL
 HOLLENSTEIN, Andreas, c/o Genmab B.V. Uppsalalaan 15, 3584 CT Utrecht, NL
 BEURSKENS, Frank, c/o Genmab B.V. Uppsalalaan 15, 3584 CT Utrecht, NL
 STRUMANE, Kristin, c/o Genmab B.V. Uppsalalaan 15, 3584 CT Utrecht, NL
 SCHUURMAN, Janine, c/o Genmab B. V. Uppsalalaan 15, 3584 CT Utrecht, NL
 DE JONG, Rob, c/o Genmab B.V. Uppsalalaan 15, 3584 CT Utrecht, NL

(51) MKP
A61K 31/437 2006 (97) EP 3746450
A61P 3/04 2006
A61P 3/10 2006
C07D 498/04 2006
 (96) EP 19702085.2 1/28/2019
 (97) EP 3746450, 12/9/2020 202050, en
 (31) 18154828 (32) 02.02.2018 (33) EP
 (54) HETEROCYCLYL-SUBSTITUTED OXADIAZOLOPYRIDINE DERIVATIVES FOR USE AS GHRELIN O-ACYL TRANSFERASE (GOAT) INHIBITORS
 (72) TRIESELMANN, Thomas, Boehringer Ingelheim International GmbH, Corporate Patents Binger Strasse 173, 55216 Ingelheim am Rhein, DE
 GODBOUT, Cédricx, Boehringer Ingelheim International GmbH, Corporate Patents Binger Strasse 173, 55216 Ingelheim am Rhein, DE
 VINTONYAK, Viktor, Boehringer Ingelheim International GmbH, Corporate Patents Binger Strasse 173, 55216 Ingelheim am Rhein, DE

(51) MKP
A01N 25/04 2006 (97) EP 3737232
A01N 25/28 2006
A01N 37/20 2006
 (96) EP 19702163.7 1/11/2019
 (97) EP 3737232, 11/18/2020 202047, en
 (31) 201862616728 P (32) 12.01.2018 (33) US
 18156649 14.02.2018 EP
 (54) HERBICIDAL COMPOSITIONS COMPRISING A CAPSULE SUSPENSION FORMULATION OF PETHOXAMID
 (72) NICHOLSON, Paul, 615 Greenway Avenue, Trenton, NJ 08618, US
 CHAHAL, Gurinderbir, 16700 50th Court N, Plymouth, MN 55446, US
 D'AMICO, Frank, J., 50 Walters Road, Robbbinsville, NJ 08691, US
 DE SOUSA, Ubiratan, F., 317 Monterey Place, Newtown, PA 18940, US
 LAURSEN, Peter, C., Kobberupvej 51, 7500 Holstebro, DK
 TEICHER, Harald, B., Drosselvej 3, 7680 Thyboron, DK

(51) MKP
A61K 8/02 2006 (97) EP 3743160
A61K 8/19 2006
A61Q 1/02 2006
A61Q 1/06 2006
A61Q 1/10 2006
C01F 11/18 2006
 (96) EP 19702218.9 1/23/2019
 (97) EP 3743160, 12/2/2020 202049, en
 (31) 18153726 (32) 26.01.2018 (33) EP
 (54) SURFACE-REACTED CALCIUM CARBONATE FOR THE USE AS SKIN APPEARANCE MODIFIER
 (72) BUDDER, Tanja, Grubenring 3, 4805 Brittnau, CH
 HECKER, Anaïs, Neugasse 9, 4665 Oftringen, CH

(51) MKP
A61K 8/02 2006 (97) EP 3743164
A61K 8/19 2006
A61Q 19/00 2006
A61Q 19/08 2006
 (96) EP 19702219.7 1/23/2019
 (97) EP 3743164, 12/2/2020 202049, en
 (31) 18153689 (32) 26.01.2018 (33) EP

- (54) SURFACE-REACTED CALCIUM CARBONATE FOR MODIFYING THE BIOMECHANICAL PROPERTIES OF THE SKIN
 (72) BUDDE, Tanja, Grubenring 3, 4805 Brittnau, CH
 HECKER, Anaïs, Neugasse 9, 4665 Oftringen, CH

- (51) MKP
A61K 31/437 2006 (97) EP 3746451
A61K 31/444 2006
A61K 31/4545 2006
A61K 31/497 2006
A61K 31/501 2006
A61K 31/5377 2006
A61P 3/00 2006
A61P 3/10 2006
C07D 498/04 2006
C07D 519/00 2006
 (96) EP 19702246.0 1/28/2019
 (97) EP 3746451, 12/9/2020 202050, en
 (31) 18154824 (32) 02.02.2018 (33) EP
 (54) BENZYL-, (PYRIDIN-3-YL)METHYL- OR (PYRIDIN-4-YL)METHYL-SUBSTITUTED OXADIAZOLOPYRIDINE DERIVATIVES AS GHRELIN O-ACYL TRANSFERASE (GOAT) INHIBITORS
 (72) TRIESELMANN, Thomas, Boehringer Ingelheim International GmbH Corporate Patents Binger Strasse 173, 55216 Ingelheim am Rhein, DE
 GODBOUT, Cédricx, Boehringer Ingelheim International GmbH Corporate Patents Binger Strasse 173, 55216 Ingelheim am Rhein, DE
 HOENKE, Christoph, Boehringer Ingelheim International GmbH Corporate Patents Binger Strasse 173, 55216 Ingelheim am Rhein, DE
 VINTONYAK, Viktor, Boehringer Ingelheim International GmbH Corporate Patents Binger Strasse 173, 55216 Ingelheim am Rhein, DE

- (51) MKP
A61K 31/519 2006 (97) EP 3746443
A61P 3/00 2006
C07D 487/04 2006
 (96) EP 19702247.8 1/28/2019
 (97) EP 3746443, 12/9/2020 202050, en
 (31) 18154831 (32) 02.02.2018 (33) EP
 (54) TRIAZOLOPYRIMIDINE DERIVATIVES FOR USE AS GHRELIN O-ACYL TRANSFERASE (GOAT) INHIBITORS
 (72) TRIESELMANN, Thomas, Boehringer Ingelheim International GmbH Corporate Patents Binger Strasse 173, 55216 Ingelheim am Rhein, DE
 GODBOUT, Cédricx, Boehringer Ingelheim International GmbH Corporate Patents Binger Strasse 173, 55216 Ingelheim am Rhein, DE
 HOENKE, Christoph, Boehringer Ingelheim International GmbH Corporate Patents Binger Strasse 173, 55216 Ingelheim am Rhein, DE
 VINTONYAK, Viktor, Boehringer Ingelheim International GmbH Corporate Patents Binger Strasse 173, 55216 Ingelheim am Rhein, DE

- (51) MKP
H04N 21/63 2011 (97) EP 3744106
 (96) EP 19702371.6 1/24/2019
 (97) EP 3744106, 12/2/2020 202049, en
 (31) 18153115 (32) 24.01.2018 (33) EP
 (54) A LIVE VIDEO RENDERING AND BROADCASTING SYSTEM
 (71) Sixty AS, C Sundtsgate 37, 5004 Bergen, NO
 (72) MATHISEN, Carl Gunnar Horn, Søreidåsen 17, 5252 Bergen, NO
 ØKSENDAL, Atle, Kringlebotn 260, 5225 Nesttun, NO

- (51) MKP
A23L 33/16 2016 (97) EP 3746045
A61K 9/00 2006
A61K 33/10 2006
 (96) EP 19702373.2 1/25/2019
 (97) EP 3746045, 12/9/2020 202050, en
 (31) 18154469 (32) 31.01.2018 (33) EP
 (54) USE OF FUNCTIONALIZED CALCIUM CARBONATE AS ACTIVE INGREDIENT
 (72) BUDDE, Tanja, Grubenring 3, 4805 Brittnau, CH
 SHARMA, Lalit, Gottfried Keller Strasse 6, 4800 Zofingen, CH

- (51) MKP

A61K 31/519 2006 (97) EP 3746444
A61P 31/14 2006
C07D 487/04 2006
(96) EP 19702581.0 1/30/2019
(97) EP 3746444, 12/9/2020 202050, en
(31) 18154314 (32) 31.01.2018 (33) EP
(54) CYCLOALKYL SUBSTITUTED PYRAZOLOPYRIMIDINES HAVING ACTIVITY AGAINST RSV
(72) LANÇOIS, David Francis Alain, c/o Janssen-Cilag 1 rue Camille Desmoulins, TSA 91003, 92787 Issy-les-Moulineaux Cedex 9, FR
GUILLEMONT, Jérôme Émile Georges, c/o Janssen-Cilag 1 rue Camille Desmoulins, TSA 91003, 92787 Issy-les-Moulineaux Cedex 9, FR
RABOISSON, Pierre Jean-Marie Bernard, Avenue Denis Diderot 5, 1300 Wavre, BE
ROYMANS, Dirk André Emmy, c/o Janssen Pharmaceutica NV Turnhoutseweg 30, 2340 Beerse, BE
RIGAUX, Peter, c/o Janssen Pharmaceutica NV Turnhoutseweg 30, 2340 Beerse, BE
MICHAUT, Antoine Benjamin, c/o NovAliX SAS BioParc, Boulevard Sébastien Brant, BP 30170, 67405 Illkirch Cedex, FR

(51) MKP
B01J 19/00 2006 (97) EP 3749668
C07D 471/04 2006
(96) EP 19702619.8 2/5/2019
(97) EP 3749668, 12/16/2020 202051, en
(31) 18155470 (32) 07.02.2018 (33) EP
(54) CONTINUOUS PROCESS FOR THE PREPARATION OF TRAZODONE
(72) IACOANGELI, Tommaso, Via Baldassarre Orero, 54, 00159 ROMA, IT
MORO, Leonardo Mario, Via Veneto, 17, 04011 APRILIA (LT), IT
CARACCIOLO TORCHIAROLO, Giuliano, Via delle Palme, 7, 04011 APRILIA (LT), IT
CAVARISCHIA, Claudia, Via Livorno, 36, 00162 ROMA, IT
FURLOTTI, Guido, Via Ferdinando Palasciano, 96, 00151 ROMA, IT

(51) MKP
A61K 47/68 2017 (97) EP 3749372
A61P 35/00 2006
C07K 14/54 2006
C07K 16/18 2006
(96) EP 19702649.5 2/8/2019
(97) EP 3749372, 12/16/2020 202051, en
(31) 18156141 (32) 09.02.2018 (33) EP
18179313 22.06.2018 EP
(54) EDB TARGETING IL-12 COMPOSITIONS
(71) Philogen S.p.A., La Lizza 7, 53100 Siena, IT
(72) VILLA, Alessandra, c/o Philochem AG Libernstrasse 3, 8112 Otelfingen, CH
MATASCI, Mattia, c/o Philochem AG Libernstrasse 3, 8112 Otelfingen, CH
ONGARO, Tiziano, c/o Philochem AG Libernstrasse 3, 8112 Otelfingen, CH

(51) MKP
A61K 35/17 2015 (97) EP 3743511
C12N 5/0783 2010
(96) EP 19702676.8 1/23/2019
(97) EP 3743511, 12/2/2020 202049, en
(31) 201801067 (32) 23.01.2018 (33) GB
(54) BIOMARKER PREDICTIVE OF TUMOUR INFILTRATING LYMPHOCYTE THERAPY AND USES THEREOF
(71) INSTIL BIO (UK) LIMITED, 48 Grafton Street, Manchester M13 9XX, GB
(72) PRICE, Nicola Kaye, Immetacyte Limited 3 Heald Court 34 Hawthorn Lane, Wilmslow, Cheshire SK9 5DG, GB
BRIDGEMAN, John Stephen, Immetacyte Limited 3 Heald Court 34 Hawthorn Lane, Wilmslow, Cheshire SK9 5DG, GB

(51) MKP
A61K 31/712 2006 (97) EP 3737387
C12N 15/113 2010
(96) EP 19702763.4 1/11/2019
(97) EP 3737387, 11/18/2020 202047, en
(31) 201862616937 P (32) 12.01.2018 (33) US
(54) ANTISENSE OLIGONUCLEOTIDES TARGETING ALPHA-SYNUCLEIN AND USES THEREOF
(72) OLSON, Richard, E., 5 Research Parkway, Wallingford, CT 06492, US
CACACE, Angela, M., 143 Injun Hollow Road, Haddam Neck, CT 06424, US
MEREDITH, Jere, E., JR., 102 Hayden Hill, Haddam, CT 06438, US

DEVIDZE, Nino, 134 Plymouth Rd. Apt. 3311, Plymouth Meeting, PA 19462, US
 LOY, James, K., Route 206 and Province Line Rd., Princeton, NJ 08543, US
 BALDICK, Carl, J., Route 206 and Province Line Rd., Princeton, NJ 08543, US
 PENDRI, Annapurna, 5 Research Parkway, Wallingford, CT 06492, US
 MCDONALD, Ivar, M., 5 Research Parkway, Wallingford, CT 06492, US
 HAGEDORN, Peter, Fremtidsvej 3, 2970 Hørsholm, DK
 JENSEN, Marianne, Lerbech, Torsvej 7, 4600 Køge, DK

- (51) MKP
C07K 14/47 2006 (97) EP 3737761
C12N 15/113 2010
- (96) EP 19702766.7 1/11/2019
 (97) EP 3737761, 11/18/2020 202047, en
- (31) 201862616994 P (32) 12.01.2018 (33) US
- (54) ANTISENSE OLIGONUCLEOTIDES TARGETING ALPHA-SYNUCLEIN AND USES THEREOF
 (71) Roche Innovation Center Copenhagen A/S, Fremtidsvej 3, 2970 Hørsholm, DK
 (72) OLSON, Richard, E., 5 Research Parkway, Wallingford, CT 06492, US
 CACACE, Angela, M., 143 Injun Hollow Road, Haddam Neck, CT 06424, US
 MEREDITH JR., Jere, E., 102 Hayden Hill, Haddam, CT 06438, US
 DEVIDZE, Nino, 134 Plymouth Rd. Apt 3311, Plymouth Meeting, PA 19462, US
 LOY, James, K., Route 206 and Province Line Rd., Princeton, NJ 08543, US
 BALDICK, Carl, J., Route 206 and Province Line Rd., Princeton, NJ 08543, US
 PENDRI, Annapurna, 5 Research Parkway, Wallingford, CT 06492, US
 MCDONALD, Ivar, M., 5 Research Parkway, Wallingford, CT 06492, US
 HAGEDORN, Peter, Fremtidsvej 3, 2970 Hørsholm, DK
 JENSEN, Marianne, Lerbech, Torsvej 7, 4600 Køge, DK

- (51) MKP
A61P 11/00 2006 (97) EP 3743406
C07C 1/00 2006
C07D 213/72 2006
C07D 309/10 2006
C07D 401/12 2006
C07D 405/12 2006
C07D 413/12 2006
C07D 417/12 2006
- (96) EP 19702958.0 1/25/2019
 (97) EP 3743406, 12/2/2020 202049, en
- (31) 201801355 (32) 26.01.2018 (33) GB
- (54) COMPOUNDS
 (71) Enterprise Therapeutics Limited, Sussex Innovation Centre University of Sussex Science Park Square Falmer, Brighton, Sussex BN1 9SB, GB
 (72) COLLINGWOOD, Stephen, Enterprise Therapeutics Limited Sussex Innovation Centre, Science Park Square, Falmer Brighton BN1 9SB, GB
 MCCARTHY, Clive, Evotec (UK) Limited 114 Innovation Drive, Milton Park, Abingdon, Oxfordshire OX14 4RZ, GB
 HARGRAVE, Jonathan, David, Evotec (UK) Limited 114 Innovation Drive, Milton Park, Abingdon, Oxfordshire OX14 4RZ, GB
 HAY, Duncan, Alexander, c/o Vertex Pharmaceuticals Inc. 86-88 Jubilee Avenue, Milton Park, Abingdon, Oxfordshire OX14 4RZ, GB
 SCHOFIELD, Thomas, Beauregard, Evotec (UK) Limited 114 Innovation Drive, Milton Park, Abingdon, Oxfordshire OX14 4RZ, GB
 ELLAM, Sarah, Evotec (UK) Limited 114 Innovation Drive, Milton Park, Abingdon, Oxfordshire OX14 4RZ, GB
 BUXTON, Craig, Evotec (UK) Limited 114 Innovation Drive, Milton Park, Abingdon, Oxfordshire OX14 4RZ, GB
 HABGOOD, Matthew, Evotec (UK) Limited 114 Innovation Drive, Milton Park, Abingdon, Oxfordshire OX14 4RZ, GB
 INGRAM, Peter, Evotec (UK) Limited 114 Innovation Drive, Milton Park, Abingdon, Oxfordshire OX14 4RZ, GB
 MA, Chun Yan, Evotec (UK) Limited 114 Innovation Drive, Milton Park, Abingdon, Oxfordshire OX14 4RZ, GB
 NAPIER, Spencer, Evotec (UK) Limited 114 Innovation Drive, Milton Park, Abingdon, Oxfordshire OX14 4RZ, GB
 SHAIKH, Abdul, Evotec (UK) Limited 114 Innovation Drive, Milton Park, Abingdon, Oxfordshire OX14 4RZ, GB
 SMITH, Matthew, Evotec (UK) Limited 114 Innovation Drive, Milton Park, Abingdon, Oxfordshire OX14 4RZ, GB
 STIMSON, Christopher, Evotec (UK) Limited 114 Innovation Drive, Milton Park, Abingdon, Oxfordshire OX14 4RZ, GB
 WALKER, Edward, Evotec (UK) Limited 114 Innovation Drive, Milton Park, Abingdon, Oxfordshire OX14 4RZ, GB

- (51) MKP
A61K 31/565 2006 (97) EP 3749327
A61P 15/18 2006
- (96) EP 19703103.2 2/7/2019
 (97) EP 3749327, 12/16/2020 202051, en
- (31) 18155571 (32) 07.02.2018 (33) EP
 18160586 (32) 07.03.2018 EP

(54) CONTRACEPTIVE COMPOSITION WITH REDUCED CARDIOVASCULAR EFFECTS

(71) Estetra SPRL, Rue Saint-Georges 5-7, 4000 Liège, BE
 (72) JOST, Maud, Rue des Noctuelles, 6, 4020 Jupille-sur-Meuse, BE
 RAUSIN, Glwadys, Rue des Bruyères 1B, 4870 Trooz, BE

(51) MKP
A61K 35/74 2015 (97) EP 3740219
A61K 39/395 2006
A61P 35/00 2006

(96) EP 19703178.4 1/18/2019

(97) EP 3740219, 11/25/2020 202048, en

(31)	201800927	(32)	19.01.2018	(33)	GB
	201801502		30.01.2018		GB
	201805941		10.04.2018		GB
	201806572		23.04.2018		GB
	201808636		25.05.2018		GB

(54) COMBINATION THERAPY FOR TREATING OR PREVENTING CANCER

(72) STEVENSON, Alexander, c/o 4D Pharma PLC, 9 Bond Court, Leeds, West Yorkshire LS1 2JZ, GB

(51) MKP
A61K 35/74 2015 (97) EP 3740220
A61K 39/395 2006
A61P 35/00 2006

(96) EP 19703179.2 1/18/2019

(97) EP 3740220, 11/25/2020 202048, en

(31)	201800927	(32)	19.01.2018	(33)	GB
	201801502		30.01.2018		GB
	201805941		10.04.2018		GB
	201806572		23.04.2018		GB
	201808631		25.05.2018		GB

(54) COMBINATION THERAPY FOR TREATING OR PREVENTING CANCER

(72) STEVENSON, Alexander, c/o 4D Pharma PLC, 9 Bond Court, Leeds, West Yorkshire LS1 2JZ, GB

(51) MKP
A41D 1/22 2018 (97) EP 3752018

(96) EP 19703306.1 2/5/2019

(97) EP 3752018, 12/23/2020 202052, de

(31)	202018100846 U	(32)	15.02.2018	(33)	DE
------	----------------	------	------------	------	----

(54) ITEM OF CLOTHING HAVING A MODULAR STRUCTURE

(71) Bohnen, Eileen, Ainmillerstraße 20, 80801 München, DE

(72) Bohnen, Eileen, Ainmillerstraße 20, 80801 München, DE

(51) MKP
A61K 31/7105 2006 (97) EP 3752177
A61K 31/713 2006
A61K 38/20 2006
A61K 39/21 2006
C07K 14/54 2006
C07K 14/55 2006
C07K 14/565 2006
C07K 14/765 2006
C12N 15/62 2006

(96) EP 19703335.0 2/8/2019

(97) EP 3752177, 12/23/2020 202052, en

(31)	PCT/EP2018/053454	(32)	12.02.2018	(33)	WO
------	-------------------	------	------------	------	----

(54) TREATMENT USING CYTOKINE ENCODING RNA

(72) SAHIN, Ugur, c/o BioNTech RNA Pharmaceuticals GmbH IP Department An der Goldgrube 12, 55131 Mainz, DE
 KRANZ, Lena, c/o BioNTech RNA Pharmaceuticals GmbH IP Department An der Goldgrube 12, 55131 Mainz, DE
 VORMEHR, Mathias, c/o BioNTech RNA Pharmaceuticals GmbH IP Department An der Goldgrube 12, 55131 Mainz, DE
 DIKEN, Mustafa, c/o BioNTech RNA Pharmaceuticals GmbH IP Department An der Goldgrube 12, 55131 Mainz, DE
 KREITER, Sebastian, c/o BioNTech RNA Pharmaceuticals GmbH IP Department An der Goldgrube 12, 55131 Mainz, DE
 TILLMANN, Bodo, c/o BioNTech RNA Pharmaceuticals GmbH IP Department An der Goldgrube 12, 55131 Mainz, DE

(51) MKP
C07C 237/06 2006 (97) EP 3737679
C07D 239/34 2006
C07D 263/06 2006
C07D 413/14 2006

(96) EP 19703440.8 1/10/2019
(97) EP 3737679, 11/18/2020 202047, en

(31) 201862615678 P (32) 10.01.2018 (33) US
PCT/CN2018/076982 22.02.2018 WO

(54) NOVEL PROCESSES AND INTERMEDIATES FOR THE PREPARATION OF SOLUBLE GUANYLATE CYCLASE STIMULATORS
(72) WALLACE, Debra Jane, c/o Ironwood Pharmaceuticals, Inc. 301 Binney Street, Cambridge, MA 02142, US
ZHOU, Fenger, c/o Ironwood Pharmaceuticals, Inc. 301 Binney Street, Cambridge, MA 02142, US
WANG, Yuguang, c/o Ironwood Pharmaceuticals, Inc. 301 Binney Street, Cambridge, MA 02142, US
NAKAI, Takashi, c/o Ironwood Pharmaceuticals, Inc. 301 Binney Street, Cambridge, MA 02142, US
KARNATI, Vishnu Vardhan Reddy, c/o Ironwood Pharmaceuticals, Inc. 301 Binney Street, Cambridge, MA 02142, US
SCHAIRER, Wayne C., c/o Ironwood Pharmaceuticals, Inc. 301 Binney Street, Cambridge, MA 02142, US
KISSEL, William, c/o Ironwood Pharmaceuticals, Inc. 301 Binney Street, Cambridge, MA 02142, US
XUE, Song, c/o Ironwood Pharmaceuticals, Inc. 301 Binney Street, Cambridge, MA 02142, US
HASHASH, Ahmad, c/o Ironwood Pharmaceuticals, Inc. 301 Binney Street, Cambridge, MA 02142, US

(51) MKP
A61K 47/54 2017 (97) EP 3737694
A61K 47/60 2017
C07K 14/54 2006
C07K 16/28 2006

(96) EP 19703451.5 1/11/2019
(97) EP 3737694, 11/18/2020 202047, en

(31) 201862616733 P (32) 12.01.2018 (33) US
201862770029 P 20.11.2018 US

(54) ANTI-PD-1 ANTIBODIES AND METHODS OF TREATMENT
(72) ALI, Khaled, M.K.Z., One Amgen Center Drive, Thousand Oaks, CA 91320, US
AGRAWAL, Neeraj, Jagdish, One Amgen Center Drive, Thousand Oaks, CA 91320, US
KANNAN, Gunasekaran, One Amgen Center Drive, Thousand Oaks, CA 91320, US
FOLTZ, Ian, One Amgen Center Drive, Thousand Oaks, CA 91320, US
WANG, Zhulun, One Amgen Center Drive, Thousand Oaks, CA 91320, US
BATES, Daren, One Amgen Center Drive, Thousand Oaks, CA 91320, US
MOCK, Marissa, One Amgen Center Drive, Thousand Oaks, CA 91320, US
TAKENAKA, Shunsuke, One Amgen Center Drive, Thousand Oaks, CA 91320, US

(51) MKP
A61K 31/506 2006 (97) EP 3740479
A61K 31/5377 2006
A61K 31/5386 2006
A61P 35/00 2006
C07D 403/12 2006
C07D 413/12 2006
C12N 15/10 2006

(96) EP 19703520.7 1/16/2019
(97) EP 3740479, 11/25/2020 202048, en

(31) 201862618598 P (32) 17.01.2018 (33) US

(54) DNA-PK INHIBITORS
(72) WEINBERG, Marc, Saul, 436 Brenna Court, Encinitas, CA 92024, US
D'ASTOLFO, Diego, Sebastian, 5167 Renaissance Avenue, Unit E, San Diego, CA 92121, US
MAHAJAN, Sudipta, 11 Lowe Circle, Framingham, MA 01701, US

(51) MKP
A61M 5/142 2006 (97) EP 3740264
A61M 5/145 2006
A61M 5/315 2006

(96) EP 19703535.5 1/17/2019
(97) EP 3740264, 11/25/2020 202048, en

(31) 201862618288 P (32) 17.01.2018 (33) US

- (54) DRUG DELIVERY MECHANISM
 (72) DUTTA RAY, Sudeshna, 300 Rolling Oaks Drive, Apt. 119, Thousand Oaks, CA 91361, US
 GIBSON, Scott R., 12141 Bellando Court, Granada Hill, CA 91344, US
 GROSZMANN, Daniel Eduardo, 236 Cross St., Belmont, MA 02478, US
 MOJARRAD, Mehran, 2389 Fountain Crest Lane, 23, Thousand Oaks, CA 91362, US
 DEES, Robert Allen, 11672 Cypress Canyon Rd., San Diego, CA 92131, US
 JOHNSON, Jonathan Dean, 3424 Arborview Dr., San Marcos, CA 92078, US
 MURCIA, Antonio S., 122 S. Clementine Street, Apt. 1a, Oceanside, CA 92054, US
-

- (51) MKP
B09B 3/00 2006 (97) EP 3752648
C04B 33/04 2006
C04B 33/132 2006
C04B 33/135 2006
C04B 33/30 2006
C04B 33/32 2006
C12R 1/00 2006
 (96) EP 19703736.9 2/11/2019
 (97) EP 3752648, 12/23/2020 202052, en
 (31) 18156484 (32) 13.02.2018 (33) EP
 (54) BUILDING MATERIALS COMPRISING DIGESTATE
 (72) SØRENSEN, Hanne Risbjerg, Landsebakken 8, 2840 Holte, DK
 NØRSKOV, Linda Kaare, Rugmarken 14, 2860 Søborg, DK
-

- (51) MKP
A61K 9/00 2006 (97) EP 3735219
A61K 9/10 2006
A61K 9/16 2006
A61K 9/50 2006
 (96) EP 19703787.2 1/2/2019
 (97) EP 3735219, 11/11/2020 202046, en
 (31) 201862613198 P (32) 03.01.2018 (33) US
 (54) ORAL LIQUID PHARMACEUTICAL COMPOSITIONS OF AMINOSALICYLATES
 (71) Ferring B.V., Polaris Avenue 144, 2132 JX Hoofddorp, NL
 (72) LIANG, Alfred Chi-Yeh, c/o FERRING B.V. Polaris Avenue 144, 2132 JX Hoofddorp, NL
 EHRNSPERGER, Eric, c/o FERRING B.V. Polaris Avenue 144, 2132 JX Hoofddorp, NL
 SHEN, Xiaohong, c/o FERRING B.V. Polaris Avenue 144, 2132 JX Hoofddorp, NL
-

- (51) MKP
A61J 1/14 2006 (97) EP 3735399
B08B 11/00 2006
C03C 23/00 2006
G01N 17/00 2006
G01N 21/90 2006
G01N 33/38 2006
 (96) EP 19703788.0 1/3/2019
 (97) EP 3735399, 11/11/2020 202046, en
 (31) 201862613173 P (32) 03.01.2018 (33) US
 (54) METHOD OF PREVENTING LAMELLAR SILICA FORMATION IN GLASS CONTAINER
 (72) NASHED-SAMUEL, Yasser, One Amgen Center Drive, Thousand Oaks, CA 91320-1799, US
 GASTWIRT, Jeremy, One Amgen Center Drive, Thousand Oaks, CA 91320-1799, US
-

- (51) MKP
A61K 39/395 2006 (97) EP 3735270
A61K 39/42 2006
A61P 31/14 2006
C07K 16/10 2006
 (96) EP 19703789.8 1/4/2019
 (97) EP 3735270, 11/11/2020 202046, en
 (31) 201862613938 P (32) 05.01.2018 (33) US
 201862712599 P 31.07.2018 US
 (54) POLYNUCLEOTIDES ENCODING ANTI-CHIKUNGUNYA VIRUS ANTIBODIES

(72) HIMANSU, Sunny, ModernaTX, Inc. 200 Technology Square, Cambridge, Massachusetts 02139, US
 CROWE, James E., Jr., Vanderbilt University 305 Kirkland Hall 2201 West End Avenue, Nashville, Tennessee 37240, US
 CIARAMELLA, Giuseppe, ModernaTX, Inc. 200 Technology Square, Cambridge, Massachusetts 02139, US

(51) MKP
A61K 35/17 2015 (97) EP 3737743
C12N 5/0783 2010

(96) EP 19703794.8 1/8/2019

(97) EP 3737743, 11/18/2020 202047, en

(31)	201862614887 P	(32)	08.01.2018	(33)	US
	201862664034 P		27.04.2018		US
	201862669319 P		09.05.2018		US
	201862697921 P		13.07.2018		US
	201862734868 P		21.09.2018		US
	201862773715 P		30.11.2018		US

(54) PROCESSES FOR GENERATING TIL PRODUCTS ENRICHED FOR TUMOR ANTIGEN-SPECIFIC T-CELLS

(72) CHARTIER-COURTAUD, Cecile, 1357 Cowper Street, Palo Alto, CA 94301, US
 RITTHIPICHAJ, Krit, 11327 Autumn Court, Apt. C, Tampa, FL 33612, US

(51) MKP
A61K 31/58 2006 (97) EP 3737687
A61P 25/00 2006
C07J 73/00 2006
C07J 75/00 2006

(96) EP 19703816.9 1/11/2019

(97) EP 3737687, 11/18/2020 202047, en

(31)	201862616768 P	(32)	12.01.2018	(33)	US
	201862617134 P		12.01.2018		US
	201862728514 P		07.09.2018		US

(54) AZA-, OXA AND THIA-PREGNAN-20-ONE-3.ALPHA.-OL COMPOUNDS FOR USE IN TREATING CNS DISORDERS

(72) ROBICHAUD, Albert, Jean, 1 Franklin St. Unit 4105, Boston, MA 02110, US
 SALITURO, Francesco, G., 25 Baker Drive, Marlborough, MA 01752, US
 BLANCO-PILLADO, Maria, Jesus, 72 Thesda Street, Arlington, MA 02474, US
 LA, Daniel, 51, Randolph Road Chestnut Hill, MA 02467, US
 HARRISON, Boyd, L., 9 Wheatston Court, Princeton Junction, NJ 08550, US

(51) MKP
A61K 31/7115 2006 (97) EP 3740575
A61K 31/712 2006
A61K 31/7125 2006
C12N 15/113 2010

(96) EP 19703843.3 1/15/2019

(97) EP 3740575, 11/25/2020 202048, en

(31)	201862617411 P	(32)	15.01.2018	(33)	US
------	----------------	------	------------	------	----

(54) MODULATORS OF DNM2 EXPRESSION

(72) FREIER, Susan, M., 2855 Gazelle Ct., Carlsbad, CA 92010, US
 BUI, Huynh-Hoa, 2855 Gazelle Ct., Carlsbad, CA 92010, US
 MURRAY, Susan, F., 2855 Gazelle Ct., Carlsbad, CA 92010, US
 MONIA, Brett, P., 2855 Gazelle Ct., Carlsbad, CA 92010, US
 GUO, Shuling, 2855 Gazelle Ct., Carlsbad, CA 92010, US

(51) MKP
A61P 35/00 2006 (97) EP 3740480
C07D 239/74 2006
C07D 239/86 2006
C07D 239/88 2006
C07D 239/94 2006
C07D 401/12 2006
C07D 403/12 2006
C07D 417/12 2006
C07D 491/048 2006

(96) EP 19703858.1 1/16/2019

(97) EP 3740480, 11/25/2020 202048, en

(31) 201862618339 P (32) 17.01.2018 (33) US
 (54) DNA-PK INHIBITORS
 (72) MAXWELL, John, Patrick, 69 Gilford Road, Hingham, MA 02043, US
 JACKSON, Katrina, Lee, 55 Newton Street, Weston, MA 02493, US
 TANG, Qing, 94 Houghton Lane, Boxborough, MA 01719, US
 MORRIS, Mark, A., 37 Lowell Street, Somerville, MA 02143, US
 RONKIN, Steven, M., 16 Jensen Road, Watertown, MA 02472, US
 XU, Jinwang, 28 Wesley Road, Framingham, MA 01701, US
 COTTRELL, Kevin, M., 17B Roberts Road, Cambridge, MA 02138, US
 CHARIFSON, Paul, S., 7 Dartmouth Drive, Framingham, MA 01701, US

(51) MKP
A61K 31/4196 2006 (97) EP 3740481
A61P 9/04 2006
C07D 231/14 2006
C07D 271/06 2006
C07D 401/12 2006
C07D 403/12 2006
C07D 413/04 2006
C07D 413/12 2006
C07D 413/14 2006
C07D 417/12 2006

(96) EP 19703917.5 1/18/2019
 (97) EP 3740481, 11/25/2020 202048, en
 (31) 201862619643 P (32) 19.01.2018 (33) US
 201862745724 P 15.10.2018 US
 (54) DIHYDROBENZOFURAN AND INDEN ANALOGS AS CARDIAC SARCOMERE INHIBITORS
 (72) CHUANG, Chihyuan, 460 Bayview Avenue, Milbrae, California 94030, US
 MORGAN, Bradley P., 5948 Monzal Avenue, Oakland, California 94611, US
 VANDERWAL, Mark, 6132 Johnston Drive, Oakland, California 94611, US
 WANG, Wenye, 1028 The Dalles Avenue, Sunnyvale, California 94087, US
 ASHCRAFT, Luke W., 668 Carolina Street, San Francisco, California 94107, US

(51) MKP
A61K 39/395 2006 (97) EP 3749360
A61P 35/00 2006
C07K 16/28 2006

(96) EP 19704009.0 2/8/2019
 (97) EP 3749360, 12/16/2020 202051, en
 (31) 18156050 (32) 09.02.2018 (33) EP
 (54) PHARMACEUTICAL COMPOSITIONS COMPRISING BISPECIFIC ANTIBODIES DIRECTED AGAINST CD3 AND CD20 AND THEIR USES
 (72) VALBJOERN, Jesper, c/o Genmab A/S Kalvebod Brygge 43, 1560 Copenhagen V, DK
 HARLOW, Lene, S, c/o Genmab A/S Kalvebod Brygge 43, 1560 Copenhagen V, DK
 CLAUSEN, Jacob, D, c/o Genmab A/S Kalvebod Brygge 43, 1560 Copenhagen V, DK
 JENSEN, Mette, H, C/O Genmab A/S Kalvebod Brygge 43, 1560 Copenhagen V, DK
 CIMANDER, Christian, C/O Genmab A/S Kalvebod Brygge 43, 1560 Copenhagen V, DK
 MADSEN, Peter, J, Halvmaanen 9, 4300 Holbaek, DK

(51) MKP
A61K 31/404 2006 (97) EP 3743413
A61P 35/00 2006
C07C 215/48 2006
C07D 209/12 2006
C07D 209/30 2006
C07D 313/08 2006
C07D 333/64 2006
C07D 409/12 2006
C07D 487/04 2006

(96) EP 19704152.8 1/22/2019
 (97) EP 3743413, 12/2/2020 202049, en
 (31) 201862620441 P (32) 22.01.2018 (33) US
 (54) ESTROGEN RECEPTOR-MODULATING COMPOUNDS
 (71) RADIUS PHARMACEUTICALS, INC., 950 Winter Street, Waltham, MA 02451, US
 (72) MILLER, Chris, 821 Barneson Road, San Mateo, CA 94402, US

(51) MKP
B29C 64/245 2017 (97) EP 3743262
B29C 64/40 2017
B33Y 10/00 2015
B33Y 30/00 2015

(96) EP 19704165.0 1/23/2019
(97) EP 3743262, 12/2/2020 202049, en

(31) 201862620891 P (32) 23.01.2018 (33) US

(54) ADDITIVELY MANUFACTURED STRUCTURE AND METHOD FOR MAKING THE SAME
(71) Local Motors IP, LLC, 9185 S Farmer Ave 101, Tempe, AZ 85284, US
(72) RIHA, David, 3003 Pinex Lane, Knoxville, Tennessee 37921, US
FIECHTER, Alexis, 1636 N. Wilbur, Mesa, Arizona 85201, US
BEDSOLE, Robert, 5615 Lake Shore Drive, Knoxville, Tennessee 37920, US
HILL, Charles, 9185 S Farmer Ave 101, Tempe, Arizona 85284, US
NOVIKOV, Timofei, 1006 Dawn Drive, Friendsville, Tennessee 37737, US
ROWE, Kyle, 6516 Pine Grove Road, Knoxville, Tennessee 37914, US

(51) MKP
A61K 38/08 2019 (97) EP 3755708
C07K 7/06 2006
C07K 14/47 2006

(96) EP 19704315.1 2/8/2019
(97) EP 3755708, 12/30/2020 202053, en

(31) 102018103944 (32) 21.02.2018 (33) DE
201862633325 P 21.02.2018 US
102018107224 27.03.2018 DE

(54) PEPTIDES AND COMBINATION OF PEPTIDES OF NON-CANONICAL ORIGIN FOR USE IN IMMUNOTHERAPY AGAINST DIFFERENT TYPES OF CANCERS
(72) SCHUSTER, Heiko, Dorfackerstrasse 22, 72074 Tübingen, DE
HOFFGAARD, Franziska, Schwärzlocher Strasse 64, 72070 Tübingen, DE
FRITSCHKE, Jens, Lärchenweg 11, 72144 Dusslingen, DE
SCHOOR, Oliver, Eichhaldenstrasse 19, 72074 Tübingen, DE
WEINSCHENK, Toni, Im Morgenrain 15, 73773 Aichwald, DE
KOWALEWSKI, Daniel, Denzenbergerstrasse 29, 72074 Tübingen, DE
TSOU, Chih-Chiang, 3130, Springdale Drive Pearland, Texas 77584, US

(51) MKP
A61K 35/74 2015 (97) EP 3740221
A61K 39/395 2006
A61P 35/00 2006

(96) EP 19704381.3 1/18/2019
(97) EP 3740221, 11/25/2020 202048, en

(31) 201800927 (32) 19.01.2018 (33) GB
201801502 30.01.2018 GB
201805941 10.04.2018 GB
201806572 23.04.2018 GB
201808632 25.05.2018 GB

(54) COMBINATION THERAPY FOR TREATING OR PREVENTING CANCER
(72) STEVENSON, Alexander, 4D Pharma PLC, 9 Bond Court, Leeds, West Yorkshire LS1 2JZ, GB

(51) MKP
A23K 20/10 2016 (97) EP 3737241
A23K 20/105 2016
A23K 20/147 2016
A23K 20/158 2016
A23K 20/163 2016
A23K 50/90 2016
A61K 36/00 2006
A61K 36/02 2006
A61K 36/05 2006
A61K 36/06 2006

A61K 36/53 2006
A61K 36/886 2006
 (96) EP 19704454.8 1/9/2019
 (97) EP 3737241, 11/18/2020 202047, en
 (31) 20180000655 (32) 09.01.2018 (33) IT
 (54) NUTRITIONAL SOLID COMPOSITIONS WITH ACARICIDE ACTIVITY FOR APICULTURE AND THEIR USE FOR THE PROPHYLAXIS AND TREATMENT OF VARROA INFESTATIONS
 (71) Healthy Bees, LLC, 1111 Kane Concourse, Suite 501, Bay Harbor Islands, FL 33154, US
 (72) DEL VECCHIO, Francesca, Via Del Fiume Giallo 324G, 00144 Rome, IT

(51) MKP
A61K 31/4427 2006 (97) EP 3752487
A61P 35/00 2006
C07D 213/72 2006
 (96) EP 19704618.8 2/12/2019
 (97) EP 3752487, 12/23/2020 202052, en
 (31) 18156576 (32) 13.02.2018 (33) EP
 (54) USE OF 5-FLUORO-4-(4-FLUORO-2-METHOXYPHENYL)-N-{4-[(S-METHYLSULFONIMIDOYL)METHYL]PYRIDIN-2-YL}PYRIDIN-2-AMINE FOR TREATING DIFFUSE LARGE B-CELL LYMPHOMA
 (72) SCHOLZ, Arne, Schönhauser Allee 170, 10435 Berlin, DE

(51) MKP
A61K 31/166 2006 (97) EP 3752151
A61K 31/282 2006
A61K 31/337 2006
A61K 31/436 2006
A61K 31/439 2006
A61K 31/44 2006
A61K 31/4433 2006
A61K 31/501 2006
A61K 31/506 2006
A61K 31/7135 2006
A61K 39/395 2006
A61K 45/06 2006
A61P 35/00 2006
A61P 35/04 2006
 (96) EP 19704619.6 2/12/2019
 (97) EP 3752151, 12/23/2020 202052, en
 (31) 201802264 (32) 12.02.2018 (33) GB
 201807415 04.05.2018 GB
 (54) THIOREDOXIN REDUCTASE INHIBITORS FOR USE IN THE TREATMENT OF CANCER
 (71) Cinda Pharma AB, Arvid Wallgrens Backe 20, 413 46 Gothenburg, SE
 (72) ORWAR, Owe, Hovås Fasanstig 11b, 43650 Hovås, SE
 DAVIDSON, Max, Spetsbergsgatan 2B, 41466 Gothenburg, SE

(51) MKP
A61K 31/4375 2006 (97) EP 3743068
A61K 31/517 2006
A61P 35/00 2006
C07D 239/88 2006
C07D 471/04 2006
 (96) EP 19704968.7 1/25/2019
 (97) EP 3743068, 12/2/2020 202049, en
 (31) 20186262262 P (32) 26.01.2018 (33) US
 20186262262 P 26.01.2018 US
 (54) COMPOUNDS FOR THE TREATMENT OF KINASE-DEPENDENT DISORDERS
 (72) BANNEN, Lynne Canne, 66 Bridge Rd., Novato, CA 94945, US
 BUI, Minna, 2445 25th Ave., Oakland, CA 94601, US
 JIANG, Faming, 5780 Shadow Ridge Drive, Castro Valley, CA 94552, US
 WANG, Yong, 170 Harbor Way South, San Francisco, CA 94080, US
 XU, Wei, 327 Glasgow Circle, Danville, CA 94526, US

(51) MKP

	A61K 31/47	2006	(97) EP 3743070		
	A61K 31/4709	2006			
	A61P 35/00	2006			
	C07D 215/22	2006			
	C07D 401/04	2006			
	C07D 401/06	2006			
	C07D 401/12	2006			
	C07D 405/04	2006			
	C07D 405/12	2006			
	C07D 413/04	2006			
	C07D 413/12	2006			
(96)	EP 19704970.3 1/25/2019				
(97)	EP 3743070, 12/2/2020 202049, en				
(31)	201862622702 P		(32)	26.01.2018	(33) US
	201862758321 P			09.11.2018	US
(54)	COMPOUNDS FOR THE TREATMENT OF KINASE-DEPENDENT DISORDERS				
(72)	BANNEN, Lynne, Canne, 66 Bridge Rd., Novato, CA 94945, US				
	BUI, Minna, 2445 25th Ave., Oakland, CA 94601, US				
	JIANG, Faming, 5780 Shadow Ridge Drive, Castro Valley, CA 94552, US				
	TSO, Kin, 5000 Diamond Heights Boulevard, San Francisco, CA 94131, US				
	WANG, Yong, 170 Harbor Way South, San Francisco, CA 94080, US				
	XU, Wei, 327 Glasgow Circle, Danville, CA 94526, US				
<hr/>					
(51)	MKP				
	C07D 213/61	2006	(97) EP 3746429		
	C07D 401/04	2006			
(96)	EP 19705025.5 1/29/2019				
(97)	EP 3746429, 12/9/2020 202050, en				
(31)	201862623664 P		(32)	30.01.2018	(33) US
(54)	PROCESSES FOR PREPARING (1 -(3-FLUORO-2-(TRIFLUOROMETHYL)ISONICOTINYL)PIPERIDINE-4-ONE)				
(72)	WANG, Dengjin, Incyte Corporation 1801 Augustine Cut-Off, Wilmington, Delaware 19803, US				
	LIU, Pingli, Incyte Corporation 1801 Augustine Cut-Off, Wilmington, Delaware 19803, US				
	WU, Yongzhong, Incyte Corporation 1801 Augustine Cut-Off, Wilmington, Delaware 19803, US				
	ZHOU, Jiacheng, Incyte Corporation 1801 Augustine Cut-Off, Wilmington, Delaware 19803, US				
<hr/>					
(51)	MKP				
	A61K 48/00	2006	(97) EP 3746136		
	C07K 14/755	2006			
	C12N 15/867	2006			
(96)	EP 19705081.8 1/31/2019				
(97)	EP 3746136, 12/9/2020 202050, en				
(31)	201862625145 P		(32)	01.02.2018	(33) US
	201862671915 P			15.05.2018	US
	201962793158 P			16.01.2019	US
(54)	USE OF LENTIVIRAL VECTORS EXPRESSING FACTOR VIII				
(72)	ANNONI, Andrea, c/o San Raffaele Telethon Institute for Gene Therapy Via Olgettina 58, 20132 Milan, IT				
	CANTORE, Alessio, c/o San Raffaele Telethon Institute for Gene Therapy Via Olgettina 58, 20132 Milan, IT				
	DRAGER, Douglas, c/o Bioerativ Therapeutics, Inc. 225 Second Avenue, Waltham, Massachusetts 02451, US				
	LIU, Tongyao, 3 Buckman Drive, Lexington, Massachusetts 02421, US				
	MILANI, Michela, c/o San Raffaele Telethon Institute for Gene Therapy Via Olgettina 58, 20132 Milan, IT				
	MOFFIT, Jeff, c/o Bioerativ Therapeutics, Inc. 225 Second Avenue, Waltham, Massachusetts 02451, US				
	NALDINI, Luigi, c/o San Raffaele Telethon Institute for Gene Therapy Via Olgettina 58, 20132 Milan, IT				
	PATARROYO-WHITE, Susannah, c/o Bioerativ Therapeutics, Inc. 225 Second Avenue, Waltham, Massachusetts 02451, US				
	PETERS, Robert, 53 Parkinson Street, Needham, Massachusetts 02492, US				
	SEREGIN, Alexey, 15 Commodore Way, Westford, Massachusetts 01886, US				
<hr/>					
(51)	MKP				
	A61K 31/57	2006	(97) EP 3755339		
	A61P 25/30	2006			
(96)	EP 19705190.7 2/20/2019				
(97)	EP 3755339, 12/30/2020 202053, en				
(31)	18305177		(32)	20.02.2018	(33) EP
(54)	3BETA-(4-METHOXYBENZYLOXY)PREGN-5-EN-20-ONE FOR USE IN THE TREATMENT OF CANNABINOIDS-RELATED DISORDERS				

- (71) Aelis Farma, Centre François Magendie 146, rue Léo Saignat, 33077 Bordeaux, FR
INSERM (Institut National de la Santé et de la Recherche Médicale), 101 rue de Tolbiac, 75013 Paris, FR
UNIVERSITE DE BORDEAUX, 35, Place Pey Berland, 33000 Bordeaux, FR
- (72) PIAZZA, Pier Vincenzo, c/o Aelis Farma Neurocentre Magendie 146, rue Léo Saignat, 33077 Bordeaux, FR
FABRE, Sandy, c/o Aelis Farma Neurocentre Magendie 146, rue Léo Saignat, 33077 Bordeaux, FR
METNA, Mathilde, c/o Aelis Farma Neurocentre Magendie 146, rue Léo Saignat, 33077 Bordeaux, FR
MONLEZUN, Stéphanie, c/o Aelis Farma Neurocentre Magendie 146, rue Léo Saignat, 33077 Bordeaux, FR
BUSQUET-GARCIA, Arnau, Neurocentre Magendie INSERM U1215 146, rue Léo Saignat, 33077 Bordeaux, FR
COTA, Daniela, Neurocentre Magendie INSERM U1215 146, rue Léo Saignat, 33077 Bordeaux, FR
MARSICANO, Giovanni, Neurocentre Magendie INSERM U1215 146, rue Léo Saignat, 33077 Bordeaux, FR
REVEST, Jean-Michel, Neurocentre Magendie INSERM U1215 146, rue Léo Saignat, 33077 Bordeaux, FR
VALLÉE, Monique, Neurocentre Magendie INSERM U1215 146, rue Léo Saignat, 33077 Bordeaux, FR

- (51) MKP
A61K 35/12 2015 (97) EP 3735412
C07D 471/04 2006
C07D 487/04 2006
C07D 519/00 2006
C12N 5/0789 2010
- (96) EP 19705235.0 1/3/2019
(97) EP 3735412, 11/11/2020 202046, en
- (31) 201862613382 P (32) 03.01.2018 (33) US
201862613383 P US
201862625896 P US
201862625917 P US
201862633056 P US
201862634638 P US
201862747068 P US
201862753835 P US
201862773950 P US
- (54) COMPOSITIONS AND METHODS FOR THE EXPANSION OF HEMATOPOIETIC STEM AND PROGENITOR CELLS AND TREATMENT OF INHERITED METABOLIC DISORDERS
- (71) Magenta Therapeutics, Inc., 100 Technology Square, Cambridge, Massachusetts 02139, US
(72) BOITANO, Anthony, 27 Evelyn Road, Newton, Massachusetts 02468, US
GONCALVES, Kevin A., 135 Clarendon Street Apt. 14Z, Boston, Massachusetts 02116, US
COOKE, Michael, 135 University Road, No. 1, Brookline, Massachusetts 02445, US

- (51) MKP
A61K 31/454 2006 (97) EP 3735297
A61K 38/16 2006
A61P 9/00 2006
A61P 25/28 2006
A61P 35/00 2006
C07D 487/06 2006
- (96) EP 19705248.3 1/4/2019
(97) EP 3735297, 11/11/2020 202046, en
- (31) 201862613931 P (32) 05.01.2018 (33) US
201862758264 P 09.11.2018 US
- (54) COMPOUNDS, COMPOSITIONS, AND METHODS FOR TREATMENT OF DISEASES INVOLVING ACIDIC OR HYPOXIC DISEASED TISSUES
- (71) Cybrexa 1, Inc., 5 Science Park 395 Winchester Avenue, New Haven, Connecticut 06511, US
(72) MARSHALL, Daniel Richard, 5 Science Park 395 Winchester Avenue, New Haven, Connecticut 06511, US
CSENGERY, Johanna Marie, 5 Science Park 395 Winchester Avenue, New Haven, Connecticut 06511, US
KING, Dalton, 5 Science Park 395 Winchester Avenue, New Haven, Connecticut 06511, US
VOLKMANN, Robert A., 135 Dogwood Lane, Mystic, Connecticut 06355, US
RESHETNYAK, Yana, 2 Lippitt Rd., Kingston, RI 02881, US
ANDREEV, Oleg, 2 Lippitt Rd., Kingston, RI 02881, US
ENGLEMAN, Don, 2 Lippitt Rd., Kingston, RI 02881, US

- (51) MKP
A61K 47/68 2017 (97) EP 3737420
C07J 71/00 2006
- (96) EP 19705259.0 1/8/2019
(97) EP 3737420, 11/18/2020 202047, en
- (31) 201862614905 P (32) 08.01.2018 (33) US

(54) STEROIDS AND ANTIBODY-CONJUGATES THEREOF
 (72) HAN, Amy, c/o Regeneron Pharmaceuticals, Inc. 777 Old Saw Mill River Road, Tarrytown, New York 10591-6707, US

(51) MKP
A61K 31/47 2006 (97) EP 3737377
A61K 31/496 2006
 (96) EP 19705261.6 1/9/2019
 (97) EP 3737377, 11/18/2020 202047, en
 (31) 201862615848 P (32) 10.01.2018 (33) US
 (54) COMBINATION THERAPIES FOR THE TREATMENT OF HEPATOCELLULAR CARCINOMA
 (71) Selvaraj, Anand, 4 Crawford Street Apt. 10, Cambridge MA 02139, US
 Smith, Peter, 173A Franklin Street, Arlington MA 02474, US
 (72) SELVARAJ, Anand, 4 Crawford Street Apt. 10, Cambridge, Massachusetts 02139, US
 SMITH, Peter, 173A Franklin Street, Arlington, Massachusetts 02474, US

(51) MKP
A01G 17/06 2006 (97) EP 3742886
 (96) EP 19705389.5 1/15/2019
 (97) EP 3742886, 12/2/2020 202049, en
 (31) 201800001699 (32) 23.01.2018 (33) IT
 (54) SUPPORTING DEVICE ON A SUPPORTING POLE, IN PARTICULAR FOR CONTAINMENT WIRES OF A ROW
 (72) Bortolussi, Claudio, Via Grigoletti 3, 33080 Fiume Veneto (PN), IT
 Bortolussi, Franco, Via Grigoletti 11, 33080 Fiume Veneto (PN), IT

(51) MKP
A61P 37/06 2006 (97) EP 3755715
C07K 16/24 2006
 (96) EP 19705548.6 2/22/2019
 (97) EP 3755715, 12/30/2020 202053, en
 (31) 18158169 (32) 22.02.2018 (33) EP
 18189562 17.08.2018 EP
 18194549 14.09.2018 EP
 201916269572 07.02.2019 US
 (54) LIGANDS TO GM-CSF OR GM-CSF-RECEPTOR FOR USE IN TREATMENT OF A HAEMATOLOGIC MALIGNANCY IN A PATIENT HAVING UNDERGONE ALLO-HCT
 (71) Universität Zürich, Rämistrasse 71, 8006 Zürich, CH
 (72) TUGUES, Sonia, Neunbrunnenstrasse 51, 8050 Zürich, CH
 BECHER, Burkhard, Im Mattenacher 3, 8124 Maur, CH

(51) MKP
A61K 39/00 2006 (97) EP 3737701
A61K 39/395 2006
A61P 25/00 2006
A61P 25/28 2006
A61P 35/02 2006
C07K 16/28 2006
 (96) EP 19705597.3 1/10/2019
 (97) EP 3737701, 11/18/2020 202047, en
 (31) 201862615914 P (32) 10.01.2018 (33) US
 201862631281 P 15.02.2018 US
 201862682639 P 08.06.2018 US
 201862721275 P 22.08.2018 US
 (54) TRANSFERRIN RECEPTOR-BINDING POLYPEPTIDES AND USES THEREOF
 (72) DENNIS, Mark S., c/o Denali Therapeutics Inc. 161 Oyster Point Blvd. South, San Francisco, California 94080, US
 KARIOLIS, Mihalis, c/o Denali Therapeutics Inc. 161 Oyster Point Blvd. South, San Francisco, California 94080, US
 KWAN, Wanda, c/o Denali Therapeutics Inc. 161 Oyster Point Blvd. South, San Francisco, California 94080, US
 SILVERMAN, Adam P., c/o Denali Therapeutics Inc. 161 Oyster Point Blvd. South, San Francisco, California 94080, US
 SWEENEY, Zachary K., c/o Denali Therapeutics Inc. 161 Oyster Point Blvd. South, San Francisco, California 94080, US
 ZUCHERO, Joy Yu, c/o Denali Therapeutics Inc. 161 Oyster Point Blvd. South, San Francisco, California 94080, US

(51) MKP

A61K 31/138 2006 (97) EP 3746126
A61K 31/216 2006
A61K 45/06 2006
A61P 11/00 2006
A61P 25/00 2006
 (96) EP 19705634.4 1/30/2019
 (97) EP 3746126, 12/9/2020 202050, en
 (31) 201862623892 P (32) 30.01.2018 (33) US
 (54) METHODS AND COMPOSITIONS FOR TREATING SLEEP APNEA
 (71) APNIMED, INC. (DELAWARE), 20 Holyoke Street, Cambridge, MA 02138, US
 (72) MILLER, Lawrence G., 17 Holly Avenue, Cambridge, MA 02138, US
 WOHL, Barry, 19 Ware Street, Apt. 3, Cambridge, MA 02138, US
 LUNSMANN, Walter J., 49 Tahanto Trail, Harvard, MA 01451, US

(51) MKP
G01N 33/542 2006 (97) EP 3729088
G01N 33/58 2006
G01N 33/68 2006
 (96) EP 18833205.0 12/19/2018
 (97) EP 3729088, 10/28/2020 202044, en
 (31) PA201700738 (32) 21.12.2017 (33) DK
 (54) ASSAY, METHOD AND TREATMENT OF ALPHA-SYNUCLEINOPATHIES
 (72) MALIK, Ibrahim, John, c/o H. Lundbeck A/S Ottiliavej 9, 2500 Valby, DK
 KALLUNKI, Pekka, c/o H. Lundbeck A/S Ottiliavej 9, 2500 Valby, DK
 FOG, Karina, c/o H. Lundbeck A/S Ottiliavej 9, 2500 Valby, DK

(51) MKP
A61K 31/4188 2006 (97) EP 3720856
A61P 25/00 2006
C07D 487/14 2006
 (96) EP 18833340.5 11/30/2018
 (97) EP 3720856, 10/14/2020 202042, en
 (31) 201720189 (32) 04.12.2017 (33) GB
 201804439 20.03.2018 GB
 (54) DOPAMINE-& X392;-HYDROXYLASE INHIBITORS
 (71) BIAL - PORTELA & Cª, S.A., Av. da Siderurgia Nacional, 4745-455 São Mamede Do Coronado, PT
 (72) KISS, Laszlo Erno, Av. da Siderurgia Nacional, 4745-455 S. Mamede Do Coronado, PT
 BELIAEV, Alexander, Av. da Siderurgia Nacional, 4745-455 S. Mamede Do Coronado, PT
 ROSSI, Tino, Av. da Siderurgia Nacional, 4745-455 S. Mamede Do Coronado, PT
 PALMA, Pedro Nuno Leal, Av. da Siderurgia Nacional, 4745-455 S. Mamede Do Coronado, PT
 SOARES DA SILVA, Patrício Manuel Vieira Araujo, Av. da Siderurgia Nacional, 4745-455 S. Mamede Do Coronado, PT
 PINTO, Rui, Av. da Siderurgia Nacional, 4745-455 S. Mamede Do Coronado, PT
 CARDONA, Francisco, Av. da Siderurgia Nacional, 4745-455 S. Mamede Do Coronado, PT

(51) MKP
A61K 35/17 2015 (97) EP 3724225
A61K 39/00 2006
A61P 35/00 2006
C07K 16/18 2006
C07K 16/46 2006
 (96) EP 18833570.7 12/14/2018
 (97) EP 3724225, 10/21/2020 202043, en
 (31) 201762599682 P (32) 15.12.2017 (33) US
 (54) ANTI-CCT5 BINDING MOLECULES AND METHODS OF USE THEREOF
 (72) BYRNE, Susan, 400 Dexter Ave. N Suite 1200, Seattle, Washington 98109, US
 SULLIVAN, Richard, 400 Dexter Ave. N Suite 1200, Seattle, Washington 98109, US
 VIGNEAULT, Francois, 400 Dexter Ave. N Suite 1200, Seattle, Washington 98109, US

(51) MKP
A61K 31/517 2006 (97) EP 3728207
A61P 29/00 2006
A61P 35/00 2006
C07D 239/88 2006

	C07D 401/12	2006					
	C07D 401/14	2006					
	C07D 405/12	2006					
	C07D 405/14	2006					
	C07D 413/14	2006					
	C07D 417/14	2006					
(96)	EP 18833588.9 12/20/2018						
(97)	EP 3728207, 10/28/2020 202044, en						
(31)	201762608747 P		(32)	21.12.2017		(33)	US
	201862691025 P			28.06.2018			US
(54)	QUINAZOLINONES AS PARP14 INHIBITORS						
(71)	Ribon Therapeutics Inc., 35 Cambridgepark Drive Suite 300, Cambridge MA 02140, US						
(72)	SCHENKEL, Laurie B., 17 Hammond Street 1, Somerville, Massachusetts 02143, US						
	VASBINDER, Melissa Marie, 7 Beecher Place, Newton, Massachusetts 02459, US						
	KUNTZ, Kevin Wayne, 8 New Village Road, Woburn, Massachusetts 01801, US						
	SWINGER, Kerren Kalai, 9 Chase Ave., Lexington, Massachusetts 02421, US						
<hr/>							
(51)	MKP						
	C07K 14/705	2006	(97)	EP 3717509			
	C12N 15/85	2006					
(96)	EP 18833620.0 11/28/2018						
(97)	EP 3717509, 10/7/2020 202041, en						
(31)	17204746		(32)	30.11.2017		(33)	EP
(54)	SynP61, A PRIMATE RETINAL PIGMENT EPITHELIUM CELL-SPECIFIC PROMOTER						
(72)	JUETTNER, Josephine, Rotbergerstrasse 9, 4054 Basel, CH						
	KROL, Jacek, Wildensteinerstrasse 10, 4052 Basel, CH						
	ROSKA, Botond, In Drissel 82, 4104 Oberwil, CH						
<hr/>							
(51)	MKP						
	C12N 15/85	2006	(97)	EP 3717651			
(96)	EP 18833621.8 11/28/2018						
(97)	EP 3717651, 10/7/2020 202041, en						
(31)	17204750		(32)	30.11.2017		(33)	EP
(54)	SYNPIII, A PROMOTER FOR THE SPECIFIC EXPRESSION OF GENES IN RETINAL PIGMENT EPITHELIUM						
(72)	JUETTNER, Josephine, Rotbergerstrasse 9, 4054 Basel, CH						
	KROL, Jacek, Wildensteinerstrasse 10, 4052 Basel, CH						
	ROSKA, Botond, In Drissel 82, 4104 Oberwil, CH						
<hr/>							
(51)	MKP						
	H01G 9/04	2006	(97)	EP 3729527			
	H01L 35/22	2006					
(96)	EP 18833875.0 12/20/2018						
(97)	EP 3729527, 10/28/2020 202044, en						
(31)	PCT/EP2017/083786		(32)	20.12.2017		(33)	WO
(54)	ACTIVE MATERIAL AND ELECTRIC POWER GENERATOR CONTAINING IT						
(72)	MAGAGNIN, Luca, Via Morandi 3, 20017 RHO, IT						
	IEFFA, Simona, Via della Selva 234/18, 22070 VALMOREA, IT						
	ACCOGLI, Alessandra, Via Vecchia Diso 27, 73030 DISO, IT						
	PANZERI, Gabriele, Via Mizzi 9, 20872 CORNATE D'ADDA, IT						
	LIBERALE, Francesco, Via Villa Eleonora 13, 27100 PAVIA, IT						
	TIRELLA, Vincenzo, Via Campagnola 86C, 6877 COLDRETERIO, CH						
	GIBERTINI, Eugenio, Via Paolo Gerli, 7, 20090 CUSAGO, IT						
	SUCCA, Luca, Via Luigi Cordone, 37 In. 1, 00125 ROMA, IT						
	BRUNETTI, Simone, Via Antonio Maria Claret, 10/A, 00126 ROMA, IT						
<hr/>							
(51)	MKP						
	A61K 31/506	2006	(97)	EP 3727388			
	C07D 487/04	2006					
	C07F 9/09	2006					
(96)	EP 18834185.3 12/19/2018						
(97)	EP 3727388, 10/28/2020 202044, en						
(31)	201762607619 P		(32)	19.12.2017		(33)	US
(54)	SGC STIMULATORS						

(72) RENNIE, Glen, Robert, C/o Ironwood Pharmaceuticals, Inc. 301 Binney Street, Cambridge, MA 02142, US
 RENHOWE, Paul, Allan, C/o Ironwood Pharmaceuticals, Inc. 301 Binney Street, Cambridge, MA 02142, US
 NAKAI, Takashi, C/o Ironwood Pharmaceuticals, Inc. 301 Binney Street, Cambridge, MA 02142, US
 MERMERIAN, Ara, C/o Ironwood Pharmaceuticals, Inc. 301 Binney Street, Cambridge, MA 02142, US
 CUMBERBATCH, Helen, C/o Ironwood Pharmaceuticals, Inc. 301 Binney Street, Cambridge, MA 02142, US

(51) MKP
A01N 63/02 2006 (97) EP 3728606
C07K 14/32 2006
C07K 14/325 2006
C12N 15/31 2006
C12N 15/32 2006
C12N 15/82 2006

(96) EP 18834214.1 12/20/2018

(97) EP 3728606, 10/28/2020 202044, en

(31)	201762609777 P	(32)	22.12.2017	(33)	US
	201862634357 P		23.02.2018		US
	201862672191 P		16.05.2018		US

(54) PESTICIDAL GENES AND METHODS OF USE

(71) Agbiome, Inc., 104 T.W. Alexander Drive, Building 1, Durham, North Carolina 27709, US

(72) ROBERTS, Kira Bulazel, 1357 John Jones Road, Bahama, North Carolina 27503, US
 THAYER, Rebecca E., 100 Hammond Wood Place, Morrisville, North Carolina 27560, US
 PARKS, Jessica, 115 Little Gem Lane, Apex, North Carolina 27560, US

(51) MKP
A61K 38/45 2006 (97) EP 3727428
A61P 3/00 2006

(96) EP 18834240.6 12/20/2018

(97) EP 3727428, 10/28/2020 202044, en

(31)	201762608547 P	(32)	20.12.2017	(33)	US
------	----------------	------	------------	------	----

(54) IMPROVED COMPOSITION AND METHODS FOR TREATMENT OF ORNITHINE TRANSCARBAMYLASE DEFICIENCY

(72) ASKEW, Kim, C/o Translate Bio, Inc. 29 Hartwell Avenue, Lexington, MA 02421, US
 CHUNG, Jou-ku, C/o Translate Bio, Inc. 29 Hartwell Avenue, Lexington, MA 02421, US
 DEROSA, Frank, C/o Translate Bio, Inc. 29 Hartwell Avenue, Lexington, MA 02421, US
 HEARTLEIN, Michael, C/o Translate Bio, Inc. 29 Hartwell Avenue, Lexington, MA 02421, US
 KARVE, Shrirang, C/o Translate Bio, Inc. 29 Hartwell Avenue, Lexington, MA 02421, US
 MCCAULEY, Thomas, C/o Translate Bio, Inc. 29 Hartwell Avenue, Lexington, MA 02421, US
 SMITH, Lianne, C/o Translate Bio, Inc. 29 Hartwell Avenue, Lexington, MA 02421, US
 BARBIER, Ann, J., C/o Translate Bio, Inc. 29 Hartwell Avenue, Lexington, MA 02421, US

(51) MKP
A61K 9/127 2006 (97) EP 3735226
A61K 31/4196 2006

(96) EP 18834263.8 12/21/2018

(97) EP 3735226, 11/11/2020 202046, en

(31)	201862612893 P	(32)	02.01.2018	(33)	US
------	----------------	------	------------	------	----

(54) INJECTABLE COMPOSITIONS OF TRITERPENOID ANTIFUNGALS ENCAPSULATED IN LIPOSOMES

(72) MOTHERAM, Rajeshwar, 17 Summerfield Blvd., Dayton, New Jersey 08810, US

(51) MKP
A61K 31/44 2006 (97) EP 3732164
A61P 11/00 2006
A61P 37/00 2006
C07D 213/61 2006
C07D 213/89 2006

(96) EP 18836234.7 12/19/2018

(97) EP 3732164, 11/4/2020 202045, en

(31)	17210827	(32)	28.12.2017	(33)	EP
------	----------	------	------------	------	----

(54) USE OF 1-PHENYL-2-PYRIDINYL ALKYL ALCOHOL DERIVATIVES FOR TREATING CYSTIC FIBROSIS

(72) VILLETTI, Gino, c/o CHIESI FARMACEUTICI S.p.A. Via Palermo, 26/A, 43122 PARMA, IT
 BERTOLINI, Serena, c/o CHIESI FARMACEUTICI S.p.A. Via Palermo, 26/A, 43122 PARMA, IT
 SORIO, Claudio, c/o CHIESI FARMACEUTICI S.p.A. Via Palermo, 26/A, 43122 PARMA, IT

- (51) MKP
A61K 31/55 2006 (97) EP 3724192
A61P 25/00 2006
A61P 25/24 2006
C07D 223/06 2006
C07D 223/10 2006
C07D 487/04 2006
C07D 487/14 2006
- (96) EP 18836400.4 12/14/2018
(97) EP 3724192, 10/21/2020 202043, en
- (31) 1700521 (32) 15.12.2017 (33) HU
- (54) TRIAZOLOBENZAZEPINES AS VASOPRESSIN V1A RECEPTOR ANTAGONISTS
(72) BASKA, Ferenc, Rózsa u. 59., 1064 Budapest, HU
BOZÓ, Éva, Attila út 69., 1013 Budapest, HU
BATA, Imre, Frankel Leó út 7., 1027 Budapest, HU
SZONDINÉ KORDÁS, Krisztina, Rákosi út 163., 1162 Budapest, HU
VUKICS, Krisztina, Egrý József u. 15., 1111 Budapest, HU

- (51) MKP
A61K 31/519 2006 (97) EP 3724190
A61K 31/53 2006
A61P 35/00 2006
C07D 471/04 2006
C07D 487/04 2006
- (96) EP 18836520.9 12/13/2018
(97) EP 3724190, 10/21/2020 202043, en
- (31) 201721044886 (32) 13.12.2017 (33) IN
201821024634 02.07.2018 IN
201821040029 23.10.2018 IN
- (54) SUBSTITUTED BICYCLIC HETEROCYCLIC COMPOUNDS AS PRMT5 INHIBITORS
(71) Lupin Limited, Kalpataru Inspire 3rd Floor Off Western Express Highway Santacruz (East) Maharashtra, Mumbai 400 055, IN
(72) NAIR, Prathap, Sreedharan, Lupin Limited (Research Park), 46A / 47A, Village Nande Taluka Mulshi, Maharashtra, Pune 412115, IN
GUDADE, Ganesh, Bhausaheb, Lupin Limited (Research Park), 46A / 47A, Village Nande Taluka Mulshi, Maharashtra, Pune 412115, IN
SETHI, Sachin, Lupin Limited (Research Park), 46A / 47A, Village Nande Taluka Mulshi, Maharashtra, Pune 412115, IN
LAGAD, Dipak, Raychand, Lupin Limited (Research Park), 46A / 47A, Village Nande Taluka Mulshi, Maharashtra, Pune 412115, IN
PAWAR, Chetan, Sanjay, Lupin Limited (Research Park), 46A / 47A, Village Nande Taluka Mulshi, Maharashtra, Pune 412115, IN
TRYAMBAKE, Mahadeo, Bhaskar, Lupin Limited (Research Park), 46A / 47A, Village Nande Taluka Mulshi, Maharashtra, Pune 412115, IN
KULKARNI, Chaitanya, Prabhakar, Lupin Limited (Research Park), 46A / 47A, Village Nande Taluka Mulshi, Maharashtra, Pune 412115, IN
HAJARE, Anil, Kashiram, Lupin Limited (Research Park), 46A / 47A, Village Nande Taluka Mulshi, Maharashtra, Pune 412115, IN
GORE, Balasaheb, Arjun, Lupin Limited (Research Park), 46A / 47A, Village Nande Taluka Mulshi, Maharashtra, Pune 412115, IN
KULKARNI, Sanjeev, Anant, K52, B801, Karve Nagar Maharashtra, Pune 411052, IN
SINDKHEDKAR, Miliind, Dattatraya, Lupin Limited (Research Park), 46A / 47A, Village Nande Taluka Mulshi, Maharashtra, Pune 412115, IN
PALLE, Venkata, P., Lupin Limited (Research Park), 46A / 47A, Village Nande Taluka Mulshi, Maharashtra, Pune 412115, IN
KAMBOJ, Rajender, Kumar, Lupin Limited (Research Park), 46A / 47A, Village Nande Taluka Mulshi, Maharashtra, Pune 412115, IN

- (51) MKP
A61K 31/501 2006 (97) EP 3713930
A61P 29/00 2006
A61P 37/00 2006
C07D 401/12 2006
C07D 401/14 2006
C07D 487/04 2006
- (96) EP 18836556.3 11/19/2018
(97) EP 3713930, 9/30/2020 202040, en
- (31) 201762589165 P (32) 21.11.2017 (33) US
- (54) SULFONE PYRIDINE ALKYL AMIDE-SUBSTITUTED HETEROARYL COMPOUNDS
(72) LIU, Chunjian, c/o Bristol-Myers Squibb Company Route 206 and Province Line Road, Princeton, New Jersey 08543, US
YANG, Michael G., c/o Bristol-Myers Squibb Company Route 206 and Province Line Road, Princeton, New Jersey 08543, US
XIAO, Zili, c/o Bristol-Myers Squibb Company Route 206 and Province Line Road, New Brunswick, New Jersey 08903, US
CHEN, Ling, c/o Bristol-Myers Squibb Company Route 206 and Province Line Road, Princeton, New Jersey 08543, US
MOSLIN, Ryan M., c/o Bristol-Myers Squibb Company Route 206 and Province Line Road, Princeton, New Jersey 08543, US
TOKARSKI, John S., c/o Bristol-Myers Squibb Company Route 206 and Province Line Road, Princeton, New Jersey 08543, US

WEINSTEIN, David S., 1931 Chalcedony Street, San Diego, California 92109, US

WROBLESKI, Stephen, T., c/o Bristol-Myers Squibb Company Route 206 and Province Line Road, Princeton, NJ 08903, US

- (51) MKP
A63H 33/00 2006 (97) EP 3720582
C08K 3/26 2006
- (96) EP 18836621.5 12/6/2018
(97) EP 3720582, 10/14/2020 202042, en
(31) 201700141532 U (32) 07.12.2017 (33) IT
- (54) KIT COMPRISING A MOULD FOR KIDS AND A POWDER WATER-SENSITIVE MIXTURE FOR MAKING A BIJOU THROUGH SAID MOULD
(71) Memento S.r.L., Via Corte dei Mesagnesi 30, 73100 Lecce, IT
(72) SAMBATI, Andrea Luigi, c/o Memento S.r.l. Via Adriano Olivetti 24, 00131 Roma, IT

- (51) MKP
C07K 16/28 2006 (97) EP 3728318
C12Q 1/6851 2018
- (96) EP 18836765.0 12/20/2018
(97) EP 3728318, 10/28/2020 202044, en
(31) 201762610050 P (32) 22.12.2017 (33) US
- (54) ANTIBODIES FOR LILRB2
(72) COHEN, Heather B., c/o Jounce Therapeutics 780 Memorial Drive, Cambridge, MA 02139, US
MACKENZIE, Lauren Pepper, c/o Jounce Therapeutics 780 Memorial Drive, Cambridge, MA 02139, US
RAMSAY, Yasmin, c/o Jounce Therapeutics 780 Memorial Drive, Cambridge, MA 02139, US
SHAFFER, Donald Raymond, c/o Jounce Therapeutics 780 Memorial Drive, Cambridge, MA 02139, US
SMITH, Jeffrey, Yan-Fei, c/o Jounce Therapeutics 780 Memorial Drive, Cambridge, MA 02139, US
O'MALLEY, Kristin Shanea, c/o Jounce Therapeutics 780 Memorial Drive, Cambridge, MA 02139, US
GUAY, Kevin Patrick, c/o Jounce Therapeutics 780 Memorial Drive, Cambridge, MA 02139, US

- (51) MKP
A61K 31/519 2006 (97) EP 3727392
A61K 31/52 2006
A61K 31/5377 2006
A61K 31/675 2006
A61K 38/05 2006
A61K 38/13 2006
A61K 38/47 2006
A61K 39/395 2006
A61P 3/00 2006
A61P 21/00 2006
- (96) EP 18836774.2 12/21/2018
(97) EP 3727392, 10/28/2020 202044, en
(31) 201762609986 P (32) 22.12.2017 (33) US
- (54) BIOMARKERS OF METHOTREXATE-INDUCED IMMUNE TOLERANCE
(72) JOSEPH, Alexandra, c/o Sanofi 55 Corporate Drive Mail Code: 55A-525, Bridgewater, New Jersey 08807, US
TRAN, Johnson, c/o Sanofi 55 Corporate Drive, Mail Code 55A-525, Bridgewater, New Jersey 08807, US
RICHARDS, Susan M., c/o Sanofi 55 Corporate Drive, Mail Code 55A-525, Bridgewater, New Jersey 08807, US

- (51) MKP
G01N 33/50 2006 (97) EP 3729085
G01N 33/68 2006
- (96) EP 18836908.6 12/21/2018
(97) EP 3729085, 10/28/2020 202044, en
(31) 201700148959 (32) 22.12.2017 (33) IT
- (54) QUANTITATIVE CELLULAR METHOD FOR DETERMINING THE BIOLOGICAL ACTIVITY OF AN ANTI-CD26 LIGAND
(72) DI NARO, Antonio Francesco, Via San Bartolomé, 7, 6922 Morcote, CH

- (51) MKP
C12N 9/10 2006 (97) EP 3724337
C12N 9/18 2006
C12N 15/113 2010
- (96) EP 18836995.3 12/12/2018
(97) EP 3724337, 10/21/2020 202043, en

- | | | | | | |
|------|---|------|------------|------|----|
| (31) | 201762597841 P | (32) | 12.12.2017 | (33) | US |
| (54) | RNAI CONSTRUCTS FOR INHIBITING PNPLA3 EXPRESSION | | | | |
| (72) | RULIFSON, Ingrid, c/o Amgen Inc. One Amgen Center Drive Law Dept-Patent Operations, Mail Stop 28-5-A, Thousand Oaks California 91320-1799, US | | | | |
| | MURAY, Justin K., c/o Amgen Inc. One Amgen Center Drive Law Dept-Patent Operations, Mail Stop 28-5-A, Thousand Oaks California 91320-1799, US | | | | |
| | OLLMANN, Michael, c/o Amgen Inc. One Amgen Center Drive Law Dept-Patent Operations, Mail Stop 28-5-A, Thousand Oaks California 91320-1799, US | | | | |
| | HOMANN, Oliver, c/o Amgen Inc. One Amgen Center Drive Law Dept-Patent Operations, Mail Stop 28-5-A, Thousand Oaks California 91320-1799, US | | | | |
-

- | | | | | | |
|------|--|-------------|------------------------|------|----|
| (51) | MKP | | | | |
| | A61K 31/5513 | 2006 | (97) EP 3732178 | | |
| | A61K 47/68 | 2017 | | | |
| | A61P 35/00 | 2006 | | | |
| | C07D 471/04 | 2006 | | | |
| | C07D 487/04 | 2006 | | | |
| (96) | EP 18837084.5 12/27/2018 | | | | |
| (97) | EP 3732178, 11/4/2020 202045, en | | | | |
| (31) | 201762611056 P | (32) | 28.12.2017 | (33) | US |
| | 20186265523 P | | 10.04.2018 | | US |
| (54) | BENZODIAZEPINE DERIVATIVES | | | | |
| (72) | MILLER, Michael Louis, 4 Maymont Drive, Framingham, MA 01701, US | | | | |
| | SHIZUKA, Manami, 253 Payson Road, Belmont, MA 02478, US | | | | |
| | CHARI, Ravi V.J., 174 Winchester Street, Newton, MA 02461, US | | | | |
-

- | | | | | | |
|------|---|-------------|------------------------|------|----|
| (51) | MKP | | | | |
| | A61P 35/00 | 2006 | (97) EP 3732200 | | |
| | C07K 16/28 | 2006 | | | |
| | C07K 16/30 | 2006 | | | |
| | C07K 16/46 | 2006 | | | |
| (96) | EP 18837141.3 12/31/2018 | | | | |
| (97) | EP 3732200, 11/4/2020 202045, en | | | | |
| (31) | 201762612242 P | (32) | 29.12.2017 | (33) | US |
| | 201862687063 P | | 19.06.2018 | | US |
| (54) | BISPECIFIC ANTIBODY CONSTRUCT DIRECTED TO MUC17 AND CD3 | | | | |
| (72) | RAUM, Tobias, c/o Amgen Research (Munich) GmbH Staffelseestrasse 2, 81477 Munich, DE | | | | |
| | ARVEDSON, Tara, 323 Nevada Avenue, Moss Beach, CA 93048, US | | | | |
| | BAILIS, Julie, 111 Wilder Avenue, Los Gatos, CA 95030, US | | | | |
| | DAHLHOFF, Christoph, c/o Amgen Research (Munich) GmbH Staffelseestrasse 2, 81477 Munich, DE | | | | |
| | ROSS, Sandra, 587 Colina Vista, Ventura, CA 93003, US | | | | |
| | CHEN, Irwin, 1875 Kelson Avenue, 202, Los Angeles, CA 90025, US | | | | |
| | BLÜMEL, Claudia, c/o Amgen Research (Munich) GmbH Staffelseestrasse 2, 81477 Munich, DE | | | | |
| | NAHRWOLD, Elisabeth, c/o Amgen Research (Munich) GmbH Staffelseestrasse 2, 81477 Munich, DE | | | | |
| | PENDZIALEK, Jochen, c/o Amgen Research (Munich) GmbH Staffelseestrasse 2, 81477 Munich, DE | | | | |
| | WAHI, Joachim, c/o Amgen Research (Munich) GmbH Staffelseestrasse 2, 81477 Munich, DE | | | | |
-

- | | | | | | |
|------|---|-------------|------------------------|------|----|
| (51) | MKP | | | | |
| | A61K 39/29 | 2006 | (97) EP 3727445 | | |
| | A61K 39/295 | 2006 | | | |
| | A61P 31/20 | 2006 | | | |
| (96) | EP 18839543.8 12/18/2018 | | | | |
| (97) | EP 3727445, 10/28/2020 202044, en | | | | |
| (31) | PCT/IB2017/058142 | (32) | 19.12.2017 | (33) | WO |
| | 201762607426 P | | 19.12.2017 | | US |
| (54) | HEPATITIS B VIRUS (HBV) VACCINES AND USES THEREOF | | | | |
| (72) | BODEN, Daniel, c/o Janssen Pharmaceutica NV Turnhoutseweg 30, 2340 Beerse, BE | | | | |
| | HORTON, Helen, c/o Janssen Pharmaceutica NV Turnhoutseweg 30, 2340 Beerse, BE | | | | |
| | NEEFS, Jean-Marc Edmond Fernand Marie, c/o Janssen Pharmaceutica NV Turnhoutseweg 30, 2340 Beerse, BE | | | | |
| | ROY, Soumitra, c/o Janssen Vaccines & Prevention B.V. Archimedesweg 4-6, 2333 CN Leiden, NL | | | | |
| | DE POOTER, Dorien, c/o Janssen Pharmaceutica NV Turnhoutseweg 30, 2340 Beerse, BE | | | | |
-

- (51) MKP

G06F 21/62 2013 (97) EP 3735648

- (96) EP 18839611.3 12/6/2018
 (97) EP 3735648, 11/11/2020 202046, en
 (31) 201762595416 P (32) 06.12.2017 (33) US
 (54) METHOD AND SYSTEM FOR DATA SECURITY, VALIDATION, VERIFICATION AND PROVENANCE WITHIN INDEPENDENT COMPUTER SYSTEMS AND DIGITAL NETWORKS
 (72) KHI, Irra Ariella, c/o Orrick Herrington & Sutcliffe LLP 107 Cheapside, London EC2V 6DN, GB
 GORELIK, Aleksandr, c/o Orrick Herrington & Sutcliffe LLP 107 Cheapside, London EC2V 6DN, GB
 BATII, Iliya, c/o Orrick Herrington & Sutcliffe LLP 107 Cheapside, London EC2V 6DN, GB
 TIKHONOV, Iliya, c/o Orrick Herrington & Sutcliffe LLP 107 Cheapside, London EC2V 6DN, GB
-

(51) MKP
A61K 39/29 2006 (97) EP 3727446
C07K 14/02 2006
C12N 7/00 2006

- (96) EP 18839618.8 12/18/2018
 (97) EP 3727446, 10/28/2020 202044, en
 (31) PCT/IB2017/058148 (32) 19.12.2017 (33) WO
 201762607439 P 19.12.2017 US
 (54) METHODS AND COMPOSITIONS FOR INDUCING AN IMMUNE RESPONSE AGAINST HEPATITIS B VIRUS (HBV)
 (72) BODEN, Daniel, c/o Janssen Pharmaceutica NV Turnhoutseweg 30, 2340 Beerse, BE
 HORTON, Helen, c/o Janssen Pharmaceutica NV Turnhoutseweg 30, 2340 Beerse, BE
 NEEFS, Jean-Marc Edmond Fernand Marie, c/o Janssen Pharmaceutica NV Turnhoutseweg 30, 2340 Beerse, BE
 ROY, Soumitra, c/o Janssen Vaccines & Prevention B.V. Archimedesweg 4-6, 2333 CN Leiden, NL
 CUSTERS, Jerome Hubertina Henricus Victor, c/o Janssen Vaccines & Prevention B.V. Archimedesweg 4-6, 2333 CN Leiden, NL
 ZAHN, Roland Christian, c/o Janssen Vaccines & Prevention B.V. Archimedesweg 4-6, 2333 CN Leiden, NL
 KALLA, Markus, Wolf 6c, 82377 Penzberg, DE
 DE POOTER, Dorien, c/o Janssen Pharmaceutica NV Turnhoutseweg 30, 2340 Beerse, BE
-

(51) MKP
B63B 35/34 2006 (97) EP 3713837

- (96) EP 18839901.8 11/22/2018
 (97) EP 3713837, 9/30/2020 202040, en
 (31) 2019956 (32) 22.11.2017 (33) NL
 (54) ARRAY OF PONTOONS FOR SOLAR PANEL AND CONNECTION MODULES THEREFOR
 (71) Oceans of Energy B.V., Wassenaarseweg 75, 2223 LA Katwijk, NL
 (72) VAN HOEKEN, Allard Pieter, c/o Wassenaarseweg 75, 2223 LA Katwijk, NL
-

(51) MKP
A61K 31/56 2006 (97) EP 3728284
A61K 31/57 2006
A61K 31/575 2006
A61K 31/58 2006
A61P 25/00 2006
C07J 1/00 2006
C07J 3/00 2006
C07J 5/00 2006
C07J 7/00 2006
C07J 9/00 2006
C07J 13/00 2006
C07J 17/00 2006
C07J 21/00 2006
C07J 41/00 2006
C07J 43/00 2006
C07J 51/00 2006
C07J 71/00 2006

- (96) EP 18839991.9 12/21/2018
 (97) EP 3728284, 10/28/2020 202044, en
 (31) 201762610069 P (32) 22.12.2017 (33) US
 201762611983 P 29.12.2017 US
 201862620095 P 22.01.2018 US
 201862722781 P 24.08.2018 US
 201862734718 P 21.09.2018 US

- (54) COMPOSITIONS AND METHODS FOR TREATING CNS DISORDERS
 (72) ROBICHAUD, Albert, Jean, 1 Franklin St. Unit 4105, Boston, MA 02110, US
 SALITURO, Francesco, G., 25 Baker Drive, Marlborough, MA 01752, US
 BLANCO-PILLADO, Maria, Jesus, 72 Thesda Street, Arlington, MA 02474, US
 LA, Daniel, 51, Randolph Road Chestnut Hill, MA 02467, US
 HARRISON, Boyd, L., 9 Wheatston Court, Princeton, NJ 08550, US

- (51) MKP
A61K 31/57 2006 (97) EP 3728285
A61P 25/00 2006
C07J 61/00 2006
C07J 63/00 2006

(96) EP 18839992.7 12/21/2018

(97) EP 3728285, 10/28/2020 202044, en

(31)	201762610067 P	(32)	22.12.2017	(33)	US
	201762612164 P		29.12.2017		US
	201762612067 P		29.12.2017		US
	201762611977 P		29.12.2017		US
	201762612070 P		29.12.2017		US
	201862765164 P		17.08.2018		US
	201862728499 P		07.09.2018		US
	201862737559 P		27.09.2018		US
	201862754977 P		02.11.2018		US

- (54) COMPOSITIONS AND METHODS FOR TREATING CNS DISORDERS
 (72) ROBICHAUD, Albert, Jean, 1 Franklin St. Unit 4105, Boston, MA 02110, US
 SALITURO, Francesco, G., 25 Baker Drive, Marlborough, MA 01752, US
 BLANCO-PILLADO, Maria, Jesus, 72 Thesda Street, Arlington, MA 02474, US
 LA, Daniel, 51, Randolph Road Chestnut Hill, MA 02467, US
 HARRISON, Boyd, L., 9 Wheatston Court, Princeton Junction, NJ 08550, US

- (51) MKP
A61K 31/4184 2006 (97) EP 3731866
A61K 31/454 2006
A61K 31/496 2006
A61K 31/502 2006
A61K 31/5025 2006
A61K 31/517 2006
A61K 31/55 2006
A61K 31/555 2006
A61K 39/395 2006
A61K 45/06 2006
A61P 35/00 2006

(96) EP 18839998.4 12/27/2018

(97) EP 3731866, 11/4/2020 202045, en

(31)	201762610761 P	(32)	27.12.2017	(33)	US
	201862613372 P		03.01.2018		US
	201862680511 P		04.06.2018		US

- (54) METHODS OF TREATING CANCER
 (72) FENG, Bin, c/o Tesaro, Inc. 1000 Winter Street North, Suite 3300, Waltham, MA 02451, US
 RAMASWAMY, Sridhar, c/o Tesaro, Inc. 1000 Winter Street North, Suite 3300, Waltham, MA 02451, US
 WANG, Jing, Yu, c/o Tesaro, Inc. 1000 Winter Street North, Suite 3300, Waltham, MA 02451, US
 XIAO, Yonghong, c/o Tesaro, Inc. 1000 Winter Street North, Suite 3300, Waltham, MA 02451, US
 ZHOU, Yinghui, c/o Tesaro, Inc. 1000 Winter Street North, Suite 3300, Waltham, MA 02451, US

- (51) MKP
A61K 31/4192 2006 (97) EP 3732167
A61P 13/00 2006
C07D 249/06 2006
C07D 401/04 2006
C07D 401/06 2006
C07D 401/12 2006
C07D 403/06 2006
C07D 403/12 2006

C07D 417/04 2006
C07D 417/12 2006
 (96) EP 18840000.6 12/28/2018
 (97) EP 3732167, 11/4/2020 202045, en
 (31) 201762611995 P (32) 29.12.2017 (33) US
 201862765313 P 20.08.2018 US
 (54) GLYCOLATE OXIDASE INHIBITORS FOR THE TREATMENT OF DISEASE
 (72) WANG, Bing, 2041 Mandelay Place, San Jose, CA 95138, US
 CHAO, Qi, 7696 Marker Road, San Diego, CA 92138, US

(51) MKP
F41A 21/30 2006 (97) EP 3735566
F41A 21/32 2006
F41A 21/36 2006
 (96) EP 18840019.6 12/18/2018
 (97) EP 3735566, 11/11/2020 202046, de
 (31) 600042018 (32) 05.01.2018 (33) AT
 (54) SILENCER SYSTEM FOR A FIREARM
 (71) MDG - Muzzle Devices GmbH, Unteröd 12, 5166 Perwang am Grabensee, AT
 (72) KADA, Christian, Schmiedgasse 34, 8430 Leibnitz, AT
 HITTMANN, Karl, Waldweg 5, 5151 Nußdorf am Haunsberg, AT
 ULBING, Lukas Michael, Weikertsham 9, 5163 Palting, AT

(51) MKP
B65D 75/58 2006 (97) EP 3737620
 (96) EP 18840079.0 12/18/2018
 (97) EP 3737620, 11/18/2020 202047, en
 (31) 201700149752 (32) 09.01.2018 (33) IT
 201700149766 09.01.2018 IT
 (54) SEALED SINGLE-DOSE BREAK-OPEN PACKAGE AND RELATIVE PRODUCTION METHOD
 (72) Gustvasson, Erland Jesper, St. Dr. Kristinas vag. 1, Sigtuna, SE

(51) MKP
C07K 14/16 2006 (97) EP 3746569
C12Q 1/6851 2018
 (96) EP 19705677.3 1/31/2019
 (97) EP 3746569, 12/9/2020 202050, en
 (31) 201862624801 P (32) 31.01.2018 (33) US
 (54) METHODS AND REAGENTS FOR ASSESSING THE PRESENCE OR ABSENCE OF REPLICATION COMPETENT VIRUS
 (72) BERRY, Ruth, 400 Dexter Ave. North Suite 1200, Seattle, Washington 98109, US
 WEBB, Edwin, 400 Dexter Ave. North Suite 1200, Seattle, Washington 98109, US

(51) MKP
A61K 31/337 2006 (97) EP 3752153
A61K 31/475 2006
A61K 31/506 2006
A61K 31/519 2006
A61K 31/555 2006
A61K 31/7048 2006
A61K 31/7068 2006
A61K 33/24 2019
A61P 35/00 2006
 (96) EP 19705720.1 2/11/2019
 (97) EP 3752153, 12/23/2020 202052, en
 (31) 201862629166 P (32) 12.02.2018 (33) US
 (54) OSIMERTINIB FOR USE IN THE TREATMENT OF NON-SMALL CELL LUNG CANCER
 (72) NASH, Anthony, Francis, Patrick, AstraZeneca UK Limited da Vinci Building, Melbourn Science Park, Cambridge Road Melbourn, Cambridge SG8 6HB, GB

(51) MKP
A61K 35/17 2015 (97) EP 3740216
A61P 35/00 2006

C12N 5/10 2006
C12N 15/867 2006
 (96) EP 19705845.6 1/17/2019
 (97) EP 3740216, 11/25/2020 202048, en
 (31) 201862618295 P (32) 17.01.2018 (33) US
 102018100967 17.01.2018 DE
 (54) METHODS OF ASSESSING TRANSDUCTION POTENCY OF VIRAL VECTORS
 (71) Immatics US, Inc., 2201 W. Holcombe Blvd. Suite 205, Houston, TX 77030, US
 (72) KALRA, Mamta, 14504 Briarforest Dr. Apt 1513, Houston, TX 77077, US
 BOURGOGNE, Agathe, 4733 Hummingbird Street, Houston, TX 77035, US
 MOHAMED, Ali, 22 Dartmoor Street, Sugar Land, TX 77479, US
 WALTER, Steffen, 2901 Wroxtton Road, Houston, TX 77005, US

(51) MKP
A61K 31/439 2006 (97) EP 3749667
A61P 25/04 2006
A61P 29/00 2006
C07D 453/02 2006
 (96) EP 19705893.6 2/4/2019
 (97) EP 3749667, 12/16/2020 202051, en
 (31) 201862626499 P (32) 05.02.2018 (33) US
 (54) COMPOUNDS FOR THE TREATMENT OF PAIN
 (72) WYNN, Thomas, 94 North Street, Lexington, Massachusetts 02420, US
 ALVAREZ, Juan, 116 S Great Rd, Lincoln, Massachusetts 01773, US
 MOUSTAKAS, Demetri, 367 Pleasant St, Belmont, Massachusetts 02478, US
 HAEBERLEIN, Markus, 102 Woodlawn Ave, Wellesley, Massachusetts 02481, US
 PENNINGTON, Lewis, 16 Russell Pl, Arlington, Massachusetts 02474, US

(51) MKP
A61K 31/404 2006 (97) EP 3749301
A61K 31/443 2006
A61K 31/4439 2006
A61K 31/47 2006
A61P 11/00 2006
 (96) EP 19706111.2 2/4/2019
 (97) EP 3749301, 12/16/2020 202051, en
 (31) 201862626567 P (32) 05.02.2018 (33) US
 201862657522 P 13.04.2018 US
 (54) PHARMACEUTICAL COMPOSITIONS FOR TREATING CYSTIC FIBROSIS
 (72) CHU, Cathy, 50 Northern Avenue, Boston, Massachusetts 02210, US
 DHAMANKAR, Varsha, 50 Northern Avenue, Boston, Massachusetts 02210, US
 DOKOU, Eleni, 50 Northern Avenue, Boston, Massachusetts 02210, US
 HASELTINE, Eric L., 50 Northern Avenue, Boston, Massachusetts 02210, US
 MOSKOWITZ, Samuel, 50 Northern Avenue, Boston, Massachusetts 02210, US
 ROBERTSON, Sarah, 50 Northern Avenue, Boston, Massachusetts 02210, US
 WALTZ, David, 50 Northern Avenue, Boston, Massachusetts 02210, US
 CHEN, Weichao George, 50 Northern Avenue, Boston, Massachusetts 02210, US

(51) MKP
A61K 31/454 2006 (97) EP 3749352
A61K 39/00 2006
A61K 39/395 2006
A61K 45/06 2006
A61P 35/00 2006
 (96) EP 19706127.8 2/5/2019
 (97) EP 3749352, 12/16/2020 202051, en
 (31) 201862626644 P (32) 05.02.2018 (33) US
 201862626646 P 05.02.2018 US
 (54) PEDIATRIC NIRAPARIB FORMULATIONS AND PEDIATRIC TREATMENT METHODS
 (72) MCGURK, Simon, C/o Tesaro, Inc. 1000 Winter Street North, Suite 3300, Waltham, MA 02451, US
 LUST, David, C/o Tesaro, Inc. 1000 Winter Street North, Suite 3300, Waltham, MA 02451, US
 JOHNSTON, Kevin, C/o Tesaro, Inc. 1000 Winter Street, North, Suite 3300, Waltham, MA 02451, US
 VERWIJS, Duantel, C/o Tesaro, Inc. 1000 Winter Street North, Suite 3300, Waltham, MA 02451, US
 NELSON, Aaron, C/o Tesaro, Inc. 1000 Winter Street North, Suite 3300, Waltham, MA 02451, US

MEDENDORP, Clare, C/o Tesaro, Inc. 1000 Winter Street North, Suite 3300, Waltham, MA 02451, US
 RONSHEIM, Melanie, C/o Tesaro, Inc. 1000 Winter Street North, Suite 3300, Waltham, MA 02451, US
 CHABER, John, C/o Tesaro, Inc. 1000 Winter Street North, Suite 3300, Waltham, MA 02451, US
 RUDDY, Steve, C/o Tesaro, Inc. 1000 Winter Street North, Suite 3300, Waltham, MA 02451, US
 POUTSIAKA, Katie, C/o Tesaro, Inc. 1000 Winter Street North, Suite 3300, Waltham, MA 02451, US
 VAN HOORN, Danny, C/o Tesaro, Inc. 1000 Winter Street North, Suite 3300, Waltham, MA 02451, US
 DOWLING, Aileen, C/o Tesaro, Inc. 1000 Winter Street North, Suite 3300, Waltham, MA 02451, US

- (51) MKP
A61K 31/4168 2006 (97) EP 3752148
A61K 31/685 2006
A61P 31/04 2006
A61P 31/06 2006
- (96) EP 19706167.4 2/6/2019
 (97) EP 3752148, 12/23/2020 202052, en
- (31) 201862631100 P (32) 15.02.2018 (33) US
 201862687950 P 21.06.2018 US
- (54) PHARMACEUTICAL COMPOSITIONS COMPRISING TEIXOBACTIN
 (72) CADETE PIRES, Ana, Cristina, 2 Ellsworth Street, Cambridge, MA 02139, US
 DUAN, Aranda, Rae, 3 Washington Street Unit 1, Medford, MA 02155, US
 LING, Losee, Lucy, 131 Gloucester Street, Arlington, MA 02476, US

- (51) MKP
A61K 31/496 2006 (97) EP 3755688
A61P 25/00 2006
A61P 25/16 2006
A61P 25/18 2006
A61P 25/24 2006
A61P 25/28 2006
C07D 209/10 2006
C07D 235/10 2006
- (96) EP 19706271.4 2/20/2019
 (97) EP 3755688, 12/30/2020 202053, en
- (31) 18461519 (32) 21.02.2018 (33) EP
- (54) INDOLE AND BENZIMIDAZOLE DERIVATIVES AS DUAL 5-HT2A AND 5-HT6 RECEPTOR ANTAGONISTS
 (71) Adamed Pharma S.A., Pienkow ul. Mariana Adamkiewiczza 6A, 05-152 Czosnow, PL
 (72) KOLACZKOWSKI, Marcin, Ul. Lany 2, 32-020 Wieliczka, PL
 BUCKI, Adam, Przebieczany 558c, 32-020 Przebieczany, PL
 SNIĘCIKOWSKA, Joanna, Ul. Długa 22c/1, 32-020 Wieliczka, PL
 MARCINKOWSKA, Monika, Ul. Na mostkach 3, 31-267 Krakow, PL

- (51) MKP
A61K 39/085 2006 (97) EP 3752183
A61P 31/04 2006
- (96) EP 19706423.1 2/12/2019
 (97) EP 3752183, 12/23/2020 202052, en
- (31) 201802339 (32) 13.02.2018 (33) GB
- (54) IMMUNOGENIC COMPOSITION COMPRISING STAPHYLOCOCCAL ANTIGENS
 (72) BAGNOLI, Fabio, GlaxoSmithKline Biologicals SA via Fiorentina 1, 53100 Siena, IT
 GORAJ, Carine, GlaxoSmithKline Biologicals SA Avenue Fleming 20, 1300 Wavre, BE

- (51) MKP
H02H 9/00 2006 (97) EP 3756253
- (96) EP 19706537.8 2/18/2019
 (97) EP 3756253, 12/30/2020 202053, de
- (31) 102018202509 (32) 19.02.2018 (33) DE
 102018202579 20.02.2018 DE
 102018208292 25.05.2018 DE
- (54) DISCHARGING DEVICE, ELECTRICAL UNIT AND DISCHARGING METHOD
 (72) WIND, Christian, Katharinenstraße 53 1/2, 86899 Landsberg am Lech, DE

- (51) MKP

	H02K 1/27	2006	(97) EP 3759800				
	H02K 7/14	2006					
	H02K 21/22	2006					
(96)	EP 19706621.0	2/22/2019					
(97)	EP 3759800, 1/6/2021	202101, de					
(31)	102018202943		(32)	27.02.2018		(33)	DE
(54)	ELECTRIC MOTOR						
(72)	ZHANG, Sunny, Waterland 232, 5658 PM Eindhoven, NL SUSEMIHL, Thomas, Kühlenbergstr. 55, 97078 Würzburg, DE STEINERT, Kevin, Lerchenweg 4, 97294 Unterpleichfeld, DE						
<hr/>							
(51)	MKP						
	A61K 48/00	2006	(97) EP 3737762				
	C12N 15/113	2010					
	C12N 15/90	2006					
(96)	EP 19706777.0	1/11/2019					
(97)	EP 3737762, 11/18/2020	202047, en					
(31)	201862617044 P		(32)	12.01.2018		(33)	US
(54)	COMPOSITIONS AND METHODS FOR GENE EDITING BY TARGETING TRANSFERRIN						
(72)	BROOKS, Alan, Richard, c/o Casebia Therapeutics Limited Liability Partnership 455 Mission Bay Boulevard South, San Francisco, CA 94158, US VO, Karen, c/o Casebia Therapeutics Limited Liability Partnership 455 Mission Bay Boulevard South, San Francisco, CA 94158, US						
<hr/>							
(51)	MKP						
	C07D 241/44	2006	(97) EP 3740483				
	C07D 403/12	2006					
	C07D 405/14	2006					
	C07D 491/048	2006					
	C07D 498/08	2006					
	C12N 15/00	2006					
(96)	EP 19706791.1	1/16/2019					
(97)	EP 3740483, 11/25/2020	202048, en					
(31)	201862618385 P		(32)	17.01.2018		(33)	US
(54)	QUINOXALINONE COMPOUNDS, COMPOSITIONS, METHODS, AND KITS FOR INCREASING GENOME EDITING EFFICIENCY						
(72)	MAHAJAN, Sudipta, 11 Lowe Circle, Framingham, MA 01701, US WEINBERG, Marc, Saul, 436 Brenna Court, Encinitas, CA 92024, US D'ASTOLFO, Diego, Sebastian, 5167 Renaissance Avenue, Unit E, San Diego, CA 92121, US COTTRELL, Kevin, M., 17b Roberts Road, Cambridge, MA 02138, US MORRIS, Mark, A., 37 Lowell Street, Somerville, MA 02143, US MAXWELL, John, Patrick, 69 Gilford Road, Hingham, MA 02043, US						
<hr/>							
(51)	MKP						
	C07D 213/75	2006	(97) EP 3752488				
	C07D 513/04	2006					
(96)	EP 19706921.4	2/13/2019					
(97)	EP 3752488, 12/23/2020	202052, en					
(31)	201830131		(32)	14.02.2018		(33)	ES
(54)	METHOD FOR PREPARING TERT-BUTYL N-((1R,2S,5S)-2-((2-((5-CHLOROPYRIDIN-2-YL)AMINO)-2-OXOACETYL)AMINO)-5-(DIMETHYLCARBAMOYL)CYCLOHEXYL)CARBAMATE						
(72)	GARCÍA GARCÍA, Elena, Moehs Group Research Center (MOEHS IBERICA S.L. César Martinell i Brunet, 10 Nave 2, 08191 Rubí - Barcelona, ES DOBARRO RODRÍGUEZ, Alicia, Moehs Group Research Center (MOEHS IBERICA S.L. César Martinell i Brunet, 10 Nave 2, 08191 Rubí - Barcelona, ES						
<hr/>							
(51)	MKP						
	A61K 35/12	2015	(97) EP 3749752				
	C12N 5/071	2010					
	C12N 5/074	2010					
	G01N 33/50	2006					
(96)	EP 19707230.9	2/8/2019					
(97)	EP 3749752, 12/16/2020	202051, en					
(31)	201862628470 P		(32)	09.02.2018		(33)	US
(54)	PANCREATIC CELLS FOR TREATING DIABETES AND METHODS OF GENERATING THE SAME						

(72) RUST, William L, c/o SERAXIS, INC. 20271 Goldenrod Lane, Suite 2085, Germantown, Maryland 20876, US

(51) MKP
A61K 39/00 2006 (97) EP 3743159
A61P 35/00 2006
C07K 16/28 2006

(96) EP 19707451.1 1/19/2019

(97) EP 3743159, 12/2/2020 202049, en

(31) 201862620106 P (32) 22.01.2018 (33) US
 201962794195 P 18.01.2019 US

(54) METHODS OF TREATING CANCERS WITH ANTAGONISTIC ANTI-PD-1 ANTIBODIES

(72) ATTIYEH, Edward F., 1400 McKean Road, Spring House, Pennsylvania 19477, US

BAE, Kyoungwha, 1400 McKean Road, Spring House, Pennsylvania 19477, US

GREGGER, James G., 1400 McKean Road, Spring House, Pennsylvania 19477, US

XIE, Hong, 1400 McKean Road, Spring House, Pennsylvania 19477, US

MAYER, Christina Lourdes, 8311 Brier Creek Pkwy Suite 105-238, Raleigh, North Carolina 27617, US

(51) MKP
G01N 33/68 2006 (97) EP 3743728

(96) EP 19707520.3 1/25/2019

(97) EP 3743728, 12/2/2020 202049, en

(31) 201862622027 P (32) 25.01.2018 (33) US
 201862684507 P 13.06.2018 US
 201862738134 P 28.09.2018 US

(54) METHODS OF TREATING SPINAL MUSCULAR ATROPHY

(72) FARWELL, Wildon, Biogen MA Inc. 225 Binney Street, Cambridge, Massachusetts 02142, US

STAROPOLI, John, Biogen MA Inc. 225 Binney Street, Cambridge, Massachusetts 02142, US

ZHAO, Guolin, Biogen MA Inc. 225 Binney Street, Cambridge, Massachusetts 02142, US

MCCAMPBELL, Alexander, Biogen MA Inc. 225 Binney Street, Cambridge, Massachusetts 02142, US

STEBBINS, Christopher Cody, Biogen MA Inc. 225 Binney Street, Cambridge, Massachusetts 02142, US

(51) MKP
C12N 5/0783 2010 (97) EP 3749753

(96) EP 19707544.3 2/8/2019

(97) EP 3749753, 12/16/2020 202051, en

(31) 201862628521 P (32) 09.02.2018 (33) US
 102018102971 09.02.2018 DE
 201862633113 P 21.02.2018 US
 102018104628 28.02.2018 DE
 201862647571 P 23.03.2018 US
 102018108996 16.04.2018 DE
 201862726350 P 03.09.2018 US

(54) METHODS FOR MANUFACTURING T CELLS

(72) KALRA, Mamta, 14504 Briarforest Dr. Apt 1513, Houston, TX 77077, US

COUGHLIN, Zoe, 6611 Brazos Lakes Drive, Richmond, TX 77469, US

ALPERT, Amir, 10722 Shawnbrook Drive, Houston, TX 77071, US

WALTER, Steffen, 2901 Wroxtton Road, Houston, TX 77005, US

MOHAMED, Ali, 22 Dartmoor Street, Sugar Land, TX 77479, US

BOURGOGNE, Agathe, 4733 Hummingbird, Houston, TX 77035, US

(51) MKP
H04N 19/107 2014 (97) EP 3753253
H04N 19/117 2014
H04N 19/147 2014
H04N 19/159 2014
H04N 19/176 2014
H04N 19/46 2014
H04N 19/503 2014
H04N 19/82 2014
H04N 19/85 2014

(96) EP 19707619.3 2/13/2019

(97) EP 3753253, 12/23/2020 202052, en

(31) 201862630385 P (32) 14.02.2018 (33) US

	201862691366 P		28.06.2018		US
	201862726608 P		04.09.2018		US
	201862739402 P		01.10.2018		US
	201862772228 P		28.11.2018		US
	201862782659 P		20.12.2018		US
	201962792122 P		14.01.2019		US
(54)	IMAGE RESHAPING IN VIDEO CODING USING RATE DISTORTION OPTIMIZATION				
(71)	Dolby Laboratories Licensing Corporation, 1275 Market Street, San Francisco, CA 94103, US				
(72)	YIN, Peng, c/o Dolby Laboratories, Inc. 1275 Market Street, San Francisco, California 94103, US				
	PU, Fangjun, c/o Dolby Laboratories, Inc. 1275 Market Street, San Francisco, California 94103, US				
	LU, Taoran, c/o Dolby Laboratories, Inc. 1275 Market Street, San Francisco, California 94103, US				
	CHEN, Tao, c/o Dolby Laboratories, Inc. 1275 Market Street, San Francisco, California 94103, US				
	HUSAK, Walter J., c/o Dolby Laboratories, Inc. 1275 Market Street, San Francisco, California 94103, US				
	MCCARTHY, Sean Thomas, c/o Dolby Laboratories, Inc. 1275 Market Street, San Francisco, California 94103, US				

(51)	MKP				
	A61K 31/437	2006	(97) EP 3752510		
	A61P 11/00	2006			
	C07D 513/22	2006			
	C07D 515/22	2006			
(96)	EP 19707648.2 2/14/2019				
(97)	EP 3752510, 12/23/2020 202052, en				
(31)	201862631453 P		(32) 15.02.2018	(33)	US
(54)	MACROCYCLES AS MODULATORS OF CYSTIC FIBROSIS TRANSMEMBRANE CONDUCTANCE REGULATOR, PHARMACEUTICAL COMPOSITIONS THEREOF, THEIR USE IN THE TREATMENT OF CYCSTIC FIBROSIS, AND PROCESS FOR MAKING THEM				
(72)	CLEMENS, Jeremy J., 50 Northern Avenue, Boston, Massachusetts 02210, US				
	ABELA, Alexander Russell, 50 Northern Avenue, Boston, Massachusetts 02210, US				
	ANDERSON, Corey Don, 50 Northern Avenue, Boston, Massachusetts 02210, US				
	BUSCH, Brett B., 50 Northern Avenue, Boston, Massachusetts 02210, US				
	CHEN, Weichao George, 50 Northern Avenue, Boston, Massachusetts 02210, US				
	CLEVELAND, Thomas, 50 Northern Avenue, Boston, Massachusetts 02210, US				
	COON, Timothy Richard, 50 Northern Avenue, Boston, Massachusetts 02210, US				
	FRIEMAN, Bryan, 50 Northern Avenue, Boston, Massachusetts 02210, US				
	GHIRMAI, Senait G., 50 Northern Avenue, Boston, Massachusetts 02210, US				
	GROOTENHUIS, Peter, 50 Northern Avenue, Boston, Massachusetts 02210, US				
	GULEVICH, Anton V., 50 Northern Avenue, Boston, Massachusetts 02210, US				
	HADIDA RUAH, Sara Sabina, 50 Northern Avenue, Boston, Massachusetts 02210, US				
	HSIA, Clara Kuang-Ju, 50 Northern Avenue, Boston, Massachusetts 02210, US				
	KANG, Ping, 50 Northern Avenue, Boston, Massachusetts 02210, US				
	KHATUYA, Haripada, 50 Northern Avenue, Boston, Massachusetts 02210, US				
	MCCARTNEY, Jason, 50 Northern Avenue, Boston, Massachusetts 02210, US				
	MILLER, Mark Thomas, 50 Northern Avenue, Boston, Massachusetts 02210, US				
	PARASELLI, Prasuna, 50 Northern Avenue, Boston, Massachusetts 02210, US				
	PIERRE, Fabrice, 50 Northern Avenue, Boston, Massachusetts 02210, US				
	SWIFT, Sara E., 50 Northern Avenue, Boston, Massachusetts 02210, US				
	TERMIN, Andreas, 50 Northern Avenue, Boston, Massachusetts 02210, US				
	UY, Johnny, 50 Northern Avenue, Boston, Massachusetts 02210, US				
	VOGEL, Carl V., 50 Northern Avenue, Boston, Massachusetts 02210, US				
	ZHOU, Jinglan, 50 Northern Avenue, Boston, Massachusetts 02210, US				

(51)	MKP				
	A61K 31/4155	2006	(97) EP 3752146		
	A61K 31/437	2006			
	A61K 31/519	2006			
	A61P 37/00	2006			
(96)	EP 19707655.7 2/14/2019				
(97)	EP 3752146, 12/23/2020 202052, en				
(31)	201862710446 P		(32) 16.02.2018	(33)	US
	201862631825 P		18.02.2018		US
(54)	JAK1 PATHWAY INHIBITORS FOR THE TREATMENT OF CYTOKINE-RELATED DISORDERS				
(72)	O'NEILL MONTGOMERY, Michael, 1801 Augustine Cut-Off, Wilmington, Delaware 19803, US				
	NAIM, Ahmad, 1801 Augustine Cut-Off, Wilmington, Delaware 19803, US				
	SNODGRASS, Susan, 1801 Augustine Cut-Off, Wilmington, Delaware 19803, US				

(51) MKP
A61K 31/496 2006 (97) EP 3752189
A61K 39/395 2006
A61P 35/00 2006
(96) EP 19707667.2 2/15/2019
(97) EP 3752189, 12/23/2020 202052, en
(31) 201862763106 P (32) 16.02.2018 (33) US
201862764850 P 15.08.2018 US
(54) SELECTIVE BCL-2 INHIBITORS IN COMBINATION WITH AN ANTI-PD-1 OR AN ANTI-PD-L1 ANTIBODY FOR THE TREATMENT OF CANCERS
(72) UZIEL, Tamar, 808 Warrington Rd., Deerfield, Illinois 60015, US
LEVERSON, Joel D., 1214 Parliament Court, Libertyville, Illinois 60048, US
PAPPANO, William N., 1103 Tracy Ln., Libertyville, Illinois 60048, US
MAGANBHAI HARIBHAI, Dipica B., 1 North Waukegan Road North, Chicago, Illinois 60064, US
MATHEW, Rebecca, 1 North Waukegan Road North, Chicago, Illinois 60064, US
KOHLEHAPP, Fred, 1 North Waukegan Road North, Chicago, Illinois 60064, US
DONAWHO, Cherrie K., 8117 Schaal Road, Burlington, Wisconsin 53105, US

(51) MKP
A61K 31/4192 2006 (97) EP 3755324
(96) EP 19707683.9 2/19/2019
(97) EP 3755324, 12/30/2020 202053, en
(31) PCT/US2018/018679 (32) 20.02.2018 (33) WO
(54) METHODS OF USE FOR TRISUBSTITUTED BENZOTRIAZOLE DERIVATIVES
(72) ULANET, Danielle, 126 Montgomery Street, Unit 3, Cambridge, Massachusetts 02140, US
CHOE, Sung Eun, 12 Kimball Road, Lexington, Massachusetts 02421, US

(51) MKP
H01L 35/28 2006 (97) EP 3750194
H01L 35/34 2006
H01L 37/02 2006
(96) EP 19707709.2 2/8/2019
(97) EP 3750194, 12/16/2020 202051, en
(31) 201800002541 (32) 09.02.2018 (33) IT
(54) ACTIVE MATERIAL AND ELECTRIC POWER GENERATOR CONTAINING IT
(72) MAGAGNIN, Luca, Via Morandi 3, 20017 RHO, IT
TIRELLA, Vincenzo, Via Campagnola 86C, 6877 COLDRETERIO, CH
ACCOGLI, Alessandra, Via Vecchia Diso 27, 73030 DISO, IT
PANZERI, Gabriele, Via Mizzi 9, 20872 CORNATE D'ADDA, IT
GIBERTINI, Eugenio, Via Paolo Gerli, 7, 20090 CUSAGO, IT
SUCCA, Luca, Via Luigi Cordone, 37 In. 1, 00125 ROMA, IT
BRUNETTI, Simone, Via Antonio Maria Claret, 10/A, 00126 ROMA, IT

(51) MKP
H01M 10/36 2010 (97) EP 3750208
(96) EP 19707710.0 2/8/2019
(97) EP 3750208, 12/16/2020 202051, en
(31) 201800002547 (32) 09.02.2018 (33) IT
(54) A SEMI-SOLID BATTERY WITH RECHARGING CAPABILITY
(72) MAGAGNIN, Luca, Via Morandi 3, 20017 RHO, IT
TIRELLA, Vincenzo, Via Campagnola 86C, 6877 COLDRETERIO, CH
ACCOGLI, Alessandra, Via Vecchia Diso 27, 73030 DISO, IT
PANZERI, Gabriele, Via Mizzi 9, 20872 CORNATE D'ADDA, IT
GIBERTINI, Eugenio, Via Paolo Gerli, 7, 20090 CUSAGO, IT
SUCCA, Luca, Via Luigi Cordone, 37 In. 1, 00125 ROMA, IT
BRUNETTI, Simone, Via Antonio Maria Claret, 10/A, 00126 ROMA, IT

(51) MKP
C12Q 1/6883 2018 (97) EP 3728638
(96) EP 19707906.4 1/24/2019
(97) EP 3728638, 10/28/2020 202044, en
(31) 201862621156 P (32) 24.01.2018 (33) US

- (54) DIAGNOSTIC AND THERAPEUTIC METHODS FOR THE TREATMENT OF RHEUMATOID ARTHRITIS (RA)
 (71) GENENTECH, INC., 1 DNA Way, South San Francisco, CA 94080, US
 (72) LEWIS, Myles, Mile End Road, London E1 4NS, GB
 PITZALIS, Costantino, Mile End Road, London E1 4NS, GB
 RAMAMOORTHY, Nandhini, 1 DNA Way South, San Francisco, CA 94080-4990, US
 TOWNSEND, Michael, John, 1 DNA Way South, San Francisco, CA 94080-4990, US
 HACKNEY, Jason, 1 DNA Way South, San Francisco, CA 94080-4990, US
-

- (51) MKP
A61K 39/00 2006 (97) EP 3746117
A61K 39/395 2006
A61P 35/02 2006
C07K 16/28 2006
C07K 16/30 2006
 (96) EP 19707927.0 1/31/2019
 (97) EP 3746117, 12/9/2020 202050, en
 (31) 201862624802 P (32) 31.01.2018 (33) US
 (54) COMBINATION THERAPY USING ADOPTIVE CELL THERAPY AND CHECKPOINT INHIBITOR
 (71) CELGENE CORPORATION, 86 Morris Avenue, Summit, NJ 07901, US
 (72) FRANKEL, Stanley R., 86 Morris Avenue, Summit, New Jersey 07901, US
 HASSKARL, Jens, Route de Perreux 1, 2017 Boudry, CH
 MANZKE, Oliver, Route de Perreux 1, 2017 Boudry, CH
-

- (51) MKP
A61K 9/00 2006 (97) EP 3749363
A61K 39/395 2006
C07K 16/28 2006
C07K 16/40 2006
 (96) EP 19707948.6 2/8/2019
 (97) EP 3749363, 12/16/2020 202051, en
 (31) 201862628267 P (32) 08.02.2018 (33) US
 201962799577 P 31.01.2019 US
 (54) LOW PH PHARMACEUTICAL ANTIBODY FORMULATION
 (72) CHRISTIAN, Twinkle, R., 519 W. Gainsborough Road Apt 303, Thousand Oaks, CA 91360, US
 SHAN, Daxian, 2130 Posada Drive, Oxnard, California 93030, US
-

- (51) MKP
A61K 9/14 2006 (97) EP 3758754
A61K 9/19 2006
A61K 31/195 2006
A61K 31/198 2006
A61K 47/10 2017
A61K 47/12 2006
A61K 47/26 2006
A61K 47/32 2006
A61K 47/38 2006
 (96) EP 19708039.3 2/21/2019
 (97) EP 3758754, 1/6/2021 202101, en
 (31) 18159758 (32) 02.03.2018 (33) EP
 (54) A PHARMACEUTICAL FORMULATION FOR INTRADUODENAL ADMINISTRATION COMPRISING MELEVODOPA AND CARBIDOPA
 (72) INACIO, Ricardo, c/o CHIESI FARMACEUTICI S.P.A. Via Palermo, 26/A, 43122 PARMA, IT
 SAUNDERS, Mark, c/o CHIESI FARMACEUTICI S.P.A. Via Palermo, 26/A, 43122 PARMA, IT
 MEHTA, Bhanvi, c/o CHIESI FARMACEUTICI S.P.A. Via Palermo, 26/A, 43122 PARMA, IT
 MÜHLHÖLZL-ODÖRFER, Kathrin, c/o CHIESI FARMACEUTICI S.P.A. Via Palermo, 26/A, 43122 PARMA, IT
 FONT, Isabel Sole, c/o CHIESI FARMACEUTICI S.P.A. Via Palermo, 26/A, 43122 PARMA, IT
 CAIVANO, Grazia, c/o CHIESI FARMACEUTICI S.P.A. Via Palermo, 26/A, 43122 PARMA, IT
-

- (51) MKP
B01D 29/35 2006 (97) EP 3752267
B01D 29/90 2006
B01D 29/92 2006
B01D 35/06 2006
 (96) EP 19708168.0 2/6/2019

(97) EP 3752267, 12/23/2020 202052, en
 (31) 201800002685 (32) 14.02.2018 (33) IT
 (54) DEVICE AND METHOD FOR FILTERING A FLUID CIRCULATING IN A PLUMBING AND HEATING SYSTEM
 (72) BERTOLOTTI, Mr. Umberto, c/o I.V.A.R. S.P.A. Via IV Novembre, 181, 25080 Prevalle (BS), IT

(51) MKP
C10B 3/00 2006 (97) EP 3749734
C10B 43/14 2006
C10B 49/00 2006
C10J 3/26 2006
C10J 3/42 2006
C10J 3/72 2006
 (96) EP 19708358.7 2/6/2019
 (97) EP 3749734, 12/16/2020 202051, en
 (31) 201800002481 (32) 08.02.2018 (33) IT
 201800002482 08.02.2018 IT
 201800002483 08.02.2018 IT
 (54) GASIFICATION PLANT
 (71) Societa' per Azioni Curti - Costruzioni Meccaniche, Via Emilia Ponente, 750, 48014 Castel Bolognese (RA), IT
 (72) TOSI, Cristian, Via per Panzano 42/G, 41016 Castelfranco Emilia (Modena), IT
 CAVAZZONI, Massimo, Via Goti 11, 42019 Ventoso (Reggio Emilia), IT

(51) MKP
A61K 8/49 2006 (97) EP 3752253
A61K 31/4155 2006
A61P 17/14 2006
A61Q 7/00 2006
C07D 277/54 2006
C07D 417/12 2006
 (96) EP 19708402.3 2/13/2019
 (97) EP 3752253, 12/23/2020 202052, en
 (31) 201800002630 (32) 13.02.2018 (33) IT
 (54) COMPOSITION FOR PREVENTION AND TREATMENT OF HAIR GROWTH DISORDERS
 (72) GIULIANI, Giammaria, Vicolo delle scuole 7, 6926 MONTAGNOLA, CH
 MARZANI, Barbara, Via G. Marconi 13, 27020 Carbonara Al Ticino, IT
 PINTO, Daniela, Via P. Pasolini 4, 7/A, 20151 MILANO, IT
 BARONI, Sergio, Via Piazzolo 3, 24030 VILLA D'ADDA, IT
 PAUS, Ralf, Hummelsbuetteler Kirchenweg 82, 22339 HAMBURG, DE
 HAWKSHAW, Nathan, Apartment 114 City South, 39 City Road East MANCHESTER Greater, Manchester M15 4QE, GB

(51) MKP
A61L 2/00 2006 (97) EP 3755455
B01D 61/14 2006
B01D 61/16 2006
B01D 67/00 2006
B01D 69/02 2006
B01D 69/08 2006
B01D 71/10 2006
B01D 71/12 2006
B01D 71/16 2006
B01D 71/20 2006
C12N 7/02 2006
 (96) EP 19708734.9 2/15/2019
 (97) EP 3755455, 12/30/2020 202053, en
 (31) 201862632165 P (32) 19.02.2018 (33) US
 (54) MODIFIED FILTER MEMBRANE AND METHOD
 (72) LIU, Shengjiang, 8 Quail Run, Lafayette, California 94549, US
 WANG, Wensheng, 1163 Santa Lucia Dr., Pittsburg, California 94565, US
 HESSLEIN, Ashley, 315 Missouri Street, San Francisco, California 94107, US

(51) MKP
A61K 31/444 2006 (97) EP 3755703
A61K 31/506 2006

	A61P 35/00	2006			
	C07D 239/28	2006			
	C07D 401/14	2006			
	C07D 403/12	2006			
	C07D 403/14	2006			
	C07D 487/04	2006			
	C07D 487/08	2006			
(96)	EP 19708757.0 2/19/2019				
(97)	EP 3755703, 12/30/2020 202053, en				
(31)	201862632702 P		(32)	20.02.2018	(33) US
	201862672772 P			17.05.2018	US
	201862750371 P			25.10.2018	US
(54)	N-(PHENYL)-2-(PHENYL)PYRIMIDINE-4-CARBOXAMIDE DERIVATIVES AND RELATED COMPOUNDS AS HPK1 INHIBITORS FOR TREATING CANCER				
(72)	VECHORKIN, Oleg, 1801 Augustine Cut-Off, Wilmington, Delaware 19803, US PAN, Jun, 1801 Augustine Cut-Off, Wilmington, Delaware 19803, US SOKOLSKY, Alexander, 1801 Augustine Cut-Off, Wilmington, Delaware 19803, US STYDUHAR, Evan, 1801 Augustine Cut-Off, Wilmington, Delaware 19803, US YE, Qinda, 1801 Augustine Cut-Off, Wilmington, Delaware 19803, US YAO, Wenqing, 1801 Augustine Cut-Off, Wilmington, Delaware 19803, US				

(51)	MKP				
	A61K 31/517	2006	(97)	EP 3759083	
	A61P 1/16	2006			
	A61P 31/12	2006			
	A61P 35/00	2006			
	A61P 37/06	2006			
	C07D 239/95	2006			
(96)	EP 19708817.2 2/28/2019				
(97)	EP 3759083, 1/6/2021 202101, en				
(31)	18159583		(32)	01.03.2018	(33) EP
(54)	2,4-DIAMINOQUINAZOLINE DERIVATIVES AND MEDICAL USES THEREOF				
(72)	MC GOWAN, David, Craig, Janssen Pharmaceutica NV Turnhoutseweg 30, 2340 Beerse, BE EMBRECHTS, Werner, Constant, Johan, Janssen Pharmaceutica NV Turnhoutseweg 30, 2340 Beerse, BE GUILLEMONT, Jérôme, Émile, Georges, Janssen-Cilag 1 rue Camille Desmoulins, TSA 91003, 92787 Issy-les-Moulineaux Cedex 9, FR COOYMANS, Ludwig, Paul, Janssen Pharmaceutica NV Turnhoutseweg 30, 2340 Beerse, BE JONCKERS, Tim, Hugo, Maria, Janssen Pharmaceutica NV Turnhoutseweg 30, 2340 Beerse, BE RABOISSON, Pierre, Jean-Marie, Bernard, Avenue Denis Diderot 5, 1300 Wavre, BE				

(51)	MKP				
	G10G 5/00	2006	(97)	EP 3743910	
(96)	EP 19709096.2 1/22/2019				
(97)	EP 3743910, 12/2/2020 202049, de				
(31)	232018		(32)	23.01.2018	(33) AT
(54)	DEVICE FOR SUPPORTING A SAXOPHONE				
(71)	Granic, Mateo, Matesici 19C, 22240 Dazlina, Tisno, HR				
(72)	Granic, Mateo, Matesici 19C, 22240 Dazlina, Tisno, HR				

(51)	MKP				
	A61K 31/4375	2006	(97)	EP 3743417	
	A61K 31/4427	2006			
	A61P 35/00	2006			
	C07D 401/12	2006			
	C07D 401/14	2006			
	C07D 413/14	2006			
	C07D 471/04	2006			
	C07D 491/147	2006			
(96)	EP 19709144.0 1/25/2019				
(97)	EP 3743417, 12/2/2020 202049, en				
(31)	201862622702 P		(32)	26.01.2018	(33) US
	201862622626 P			26.01.2018	US
(54)	COMPOUNDS FOR THE TREATMENT OF KINASE-DEPENDENT DISORDERS				
(72)	BANNEN, Lynne Canne, 66 Bridge Rd., Novato, CA 94945, US BUI, Minna, 2445 25th Ave., Oakland, CA 94601, US				

JIANG, Faming, 5780 Shadow Ridge Drive, Castro Valley, CA 94552, US
 WANG, Yong, 170 Harbor Way South, San Francisco, CA 94080, US
 XU, Wei, 327 Glasgow Circle, Danville, CA 94526, US

- (51) MKP
A61K 31/4985 2006 (97) EP 3755702
A61P 35/00 2006
A61P 37/00 2006
C07D 487/04 2006
- (96) EP 19709178.8 2/15/2019
 (97) EP 3755702, 12/30/2020 202053, en
 (31) 201862631945 P (32) 19.02.2018 (33) US
- (54) INHIBITORS OF BTK AND MUTANTS THEREOF
 (71) Newave Pharmaceutical Inc., 4695 Chabot Drive Suite 200, Pleasanton, CA 94588, US
 (72) CHEN, Yi, 3447 Gravina Place, Pleasanton, CA 94566, US

- (51) MKP
A61M 5/315 2006 (97) EP 3755403
- (96) EP 19709272.9 2/20/2019
 (97) EP 3755403, 12/30/2020 202053, en
 (31) 201862633655 P (32) 22.02.2018 (33) US
 201862779652 P 14.12.2018 US
- (54) MEDICATION DELIVERY DEVICE WITH A SENSED ELEMENT
 (72) BYERLY, Roy Howard, c/o Eli Lilly and Company P.O. Box 6288, Indianapolis, Indiana 46206-6288, US
 BLUM, Timothy Mark, c/o Eli Lilly and Company P.O. Box 6288, Indianapolis, Indiana 46206-6288, US

- (51) MKP
A61M 5/315 2006 (97) EP 3755404
- (96) EP 19709275.2 2/20/2019
 (97) EP 3755404, 12/30/2020 202053, en
 (31) 201862633655 P (32) 22.02.2018 (33) US
 201862779652 P 14.12.2018 US
- (54) DOSE DETECTION SYSTEM MODULE FOR MEDICATION DELIVERY DEVICE
 (72) BAUER, Benjamin David, c/o Eli Lilly and Company P.O. Box 6288, Indianapolis, Indiana 46206-6288, US
 BLUM, Timothy Mark, c/o Eli Lilly and Company P.O. Box 6288, Indianapolis, Indiana 46206-6288, US
 BYERLY, Roy Howard, c/o Eli Lilly and Company P.O. Box 6288, Indianapolis, Indiana 46206-6288, US
 CONCU, Andrea, c/o Eli Lilly and Company P.O. Box 6288, Indianapolis, Indiana 46206-6288, US
 CORTINOVIS, Marco, c/o Eli Lilly and Company P.O. Box 6288, Indianapolis, Indiana 46206-6288, US
 DEGAN, Paolo, c/o Eli Lilly and Company P.O. Box 6288, Indianapolis, Indiana 46206-6288, US
 JUDSON, Jared Alden, c/o Eli Lilly and Company P.O. Box 6288, Indianapolis, Indiana 46206-6288, US
 MASSARI, Rossano Claudio, c/o Eli Lilly and Company P.O. Box 6288, Indianapolis, Indiana 46206-6288, US
 RINGENBERGER, Kimberly Ann, c/o Eli Lilly and Company P.O. Box 6288, Indianapolis, Indiana 46206-6288, US
 SARDO, Giorgio Maria, c/o Eli Lilly and Company P.O. Box 6288, Indianapolis, Indiana 46206-6288, US
 SEDIGHIAMIRI, Amin, c/o Eli Lilly and Company P.O. Box 6288, Indianapolis, Indiana 46206-6288, US
 VERGANI, Marco, c/o Eli Lilly and Company P.O. Box 6288, Indianapolis, Indiana 46206-6288, US

- (51) MKP
B23Q 17/20 2006 (97) EP 3755499
B23Q 17/22 2006
B23Q 17/24 2006
B29C 64/188 2017
G06T 7/33 2017
- (96) EP 19709279.4 2/20/2019
 (97) EP 3755499, 12/30/2020 202053, en
 (31) 201862632560 P (32) 20.02.2018 (33) US
- (54) METHOD AND APPARATUS FOR ADDITIVE MANUFACTURING
 (72) FIECHTER, Alexis, 1636 N. Wilbur, Mesa, Arizona 85201, US
 NOVIKOV, Timofei, 1006 Dawn Drive, Friendsville, Tennessee 37737, US
 BEDSOLE, Robert, 112 S. Gay St 403, Knoxville, Tennessee 37902, US
 ROWE, Kyle, 6516 Pine Grove Road, Knoxville, Tennessee 37914, US
 HILL, Charles, 122 Hardin Drive, Topton, North Carolina 28781, US
 RIHA, David, 3003 Pinex Lane, Knoxville, Tennessee 37921, US

(51) MKP
A61K 31/513 2006 (97) EP 3759096
A61P 35/00 2006
C07D 403/04 2006

(96) EP 19709335.4 2/22/2019
(97) EP 3759096, 1/6/2021 202101, en

(31) 201862636978 P (32) 01.03.2018 (33) US
201862775553 P 05.12.2018 US

(54) CD73 INHIBITORS
(72) DALLY, Robert Dean, c/o ELI LILLY AND COMPANY P.O. Box 6288, Indianapolis, Indiana 46206-6288, US
GARCIA PAREDES, Maria Cristina, c/o ELI LILLY AND COMPANY P.O. Box 6288, Indianapolis, Indiana 46206-6288, US
HEINZ, Lawrence Joseph II, c/o ELI LILLY AND COMPANY P.O. Box 6288, Indianapolis, Indiana 46206-6288, US
HOWELL, Jennifer Marie, c/o ELI LILLY AND COMPANY P.O. Box 6288, Indianapolis, Indiana 46206-6288, US
NJOROGÉ, Frank George, c/o ELI LILLY AND COMPANY P.O. Box 6288, Indianapolis, Indiana 46206-6288, US
WANG, Yan, c/o ELI LILLY AND COMPANY P.O. Box 6288, Indianapolis, Indiana 46206-6288, US
ZHAO, Genshi, c/o ELI LILLY AND COMPANY P.O. Box 6288, Indianapolis, Indiana 46206-6288, US

(51) MKP
A61K 39/00 2006 (97) EP 3759139
A61P 37/06 2006
C07K 16/28 2006

(96) EP 19709336.2 2/22/2019
(97) EP 3759139, 1/6/2021 202101, en

(31) 201862637643 P (32) 02.03.2018 (33) US

(54) PD-1 AGONIST ANTIBODIES AND USES THEREOF
(72) CHAI, Qing, c/o Eli Lilly and Company P.O. Box 6288, Indianapolis, Indiana 46206-6288, US
FENG, Yiqing, c/o Eli Lilly and Company P.O. Box 6288, Indianapolis, Indiana 46206-6288, US
NEWBURN, Kristin Paige, c/o Eli Lilly and Company P.O. Box 6288, Indianapolis, Indiana 46206-6288, US
TRUHLAR, Stephanie Marie, c/o Eli Lilly and Company P.O. Box 6288, Indianapolis, Indiana 46206-6288, US
VERDINO, Petra, c/o Eli Lilly and Company P.O. Box 6288, Indianapolis, Indiana 46206-6288, US
YACHI, Pia Pauliina, c/o Eli Lilly and Company P.O. Box 6288, Indianapolis, Indiana 46206-6288, US

(51) MKP
A61K 31/505 2006 (97) EP 3759098
A61K 31/506 2006
C07B 59/00 2006
C07D 239/69 2006
C07D 401/12 2006
C07D 401/14 2006
C07D 403/12 2006
C07D 413/12 2006

(96) EP 19709356.0 2/22/2019
(97) EP 3759098, 1/6/2021 202101, en

(31) PCT/CN2018/077189 (32) 26.02.2018 (33) WO

(54) PYRIDINE-SULFONAMIDE COMPOUNDS AND THEIR USE AGAINST PAIN AND RELATED CONDITIONS
(72) SUTHERLIN, Daniel, 1 DNA Way South, San Francisco, California 94080-4990, US
MCKERRALL, Steven, 1 DNA Way South, San Francisco, California 94080-4990, US
LAI, Kwong Wah, 288 Fute Zhong Road WaiGaoQiao Free Trade Zone, Shanghai 200131, CN
LIU, Zhiguo, 288 Fute Zhong Road WaiGaoQiao Free Trade Zone, Shanghai 200131, CN
LIU, Wenfeng, 288 Fute Zhong Road WaiGaoQiao Free Trade Zone, Shanghai 200131, CN
BEVERIDGE, Ramsay, 2525 Marie-Curie Avenue Montreal, Québec H4S 2E1, CA
LECLERC, Jean-Philippe, 2525 Marie-Curie Avenue Montreal, Québec H4S 2E1, CA
LEMIRE, Alexandre, 2525 Marie-Curie Avenue Montreal, Québec H4S 2E1, CA
ZHAO, Liang, 2525 Marie-Curie Avenue Montreal, Québec H4S 2E1, CA
STURINO, Claudio, 2525 Marie-Curie Avenue Montreal, Québec H4S 2E1, CA

(51) MKP
A61K 31/53 2006 (97) EP 3759088
A61P 25/00 2006
A61P 25/16 2006
A61P 25/24 2006
A61P 25/28 2006

	C07D 251/34	2006					
	C07D 401/04	2006					
	C07D 403/04	2006					
	C07D 405/04	2006					
	C07D 409/04	2006					
	C07D 417/04	2006					
(96)	EP 19710473.0 2/26/2019						
(97)	EP 3759088, 1/6/2021 202101, en						
(31)	1850217		(32)	26.02.2018		(33)	SE
	201810667			28.06.2018			GB
(54)	TRIAZINE DERIVATIVES FOR TREATING DISEASES RELATING TO NEUROTROPHINS						
(71)	Alzecure Pharma AB, Karolinska Science Park Hälsövägen 7, 141 57 Huddinge, SE						
(72)	NORDVALL, Gunnar, Sjöviksvägen 6, 144 61 Rönninge, SE						
	FORSELL, Pontus, Bergstigen 4, 141 40 Huddinge, SE						
<hr/>							
(51)	MKP						
	A61K 31/198	2006	(97)	EP 3752141			
	A61P 25/00	2006					
(96)	EP 19710788.1 2/14/2019						
(97)	EP 3752141, 12/23/2020 202052, en						
(31)	201862631383 P		(32)	15.02.2018		(33)	US
(54)	THERAPEUTIC AGENTS FOR TREATING RESTLESS LEGS SYNDROME						
(71)	IntraBio Ltd, Summit House 170 Finchley Road, London NW3 6BP, GB						
(72)	FACTOR, Mallory, 9 Hill Street, London W1J 5LF, GB						
	STRUPP, Michael, University Hospital Munich Campus GroBhadern, 81377 Marchioninstr.15, DE						
<hr/>							
(51)	MKP						
	A61K 31/69	2006	(97)	EP 3752251			
	A61P 29/00	2006					
	A61P 35/00	2006					
	C07F 5/02	2006					
(96)	EP 19710796.4 2/15/2019						
(97)	EP 3752251, 12/23/2020 202052, en						
(31)	201862631659 P		(32)	17.02.2018		(33)	US
	201862671576 P			15.05.2018			US
	201862721113 P			22.08.2018			US
	201862778002 P			11.12.2018			US
(54)	ARGINASE INHIBITORS AND METHODS OF USE THEREOF						
(71)	AstraZeneca AB, 151 85 Södertälje, SE						
(72)	MLYNARSKI, Scott Nathan, 35 Gatehouse Drive, Waltham, Massachusetts 02451, US						
	GREBE, Tyler, 35 Gatehouse Drive, Waltham, Massachusetts 02451, US						
	KAWATKAR, Sameer, 35 Gatehouse Drive, Waltham, Massachusetts 02451, US						
	FINLAY, Maurice Raymond Verschoyle, 1 Francis Crick Avenue, Cambridge Biomedical Campus, Cambridge CB2 0AA, GB						
	SIMPSON, Iain, 1 Francis Crick Avenue, Cambridge Biomedical Campus, Cambridge CB2 0AA, GB						
	WANG, Jianyan, 35 Gatehouse Drive, Waltham, Massachusetts 02451, US						
	COOK, Steve, 35 Gatehouse Drive, Waltham, Massachusetts 02451, US						
	WU, Dedong, 35 Gatehouse Drive, Waltham, MA 02451, US						
<hr/>							
(51)	MKP						
	A61K 35/17	2015	(97)	EP 3752600			
	A61K 39/00	2006					
	A61P 35/00	2006					
	C12N 5/0783	2010					
(96)	EP 19710828.5 2/12/2019						
(97)	EP 3752600, 12/23/2020 202052, en						
(31)	201862630010 P		(32)	13.02.2018		(33)	US
	201862637603 P			02.03.2018			US
	201862684698 P			13.06.2018			US
(54)	EXPANSION OF TUMOR INFILTRATING LYMPHOCYTES (TILS) WITH ADENOSINE A2A RECEPTOR ANTAGONISTS AND THERAPEUTIC COMBINATIONS OF TILS AND ADENOSINE A2A RECEPTOR ANTAGONISTS						
(72)	FARDIS, Maria, 105 Aberdeen Drive, San Carlos, CA 94070, US						
<hr/>							
(51)	MKP						

A61K 9/50 2006 (97) EP 3758722
A61K 35/00 2006
A61K 35/39 2015
A61L 27/38 2006
A61L 27/54 2006
A61P 5/48 2006
A61P 5/50 2006
 (96) EP 19710923.4 2/28/2019
 (97) EP 3758722, 1/6/2021 202101, en
 (31) 201862637085 P (32) 01.03.2018 (33) US
 (54) MACRO-ENCAPSULATED THERAPEUTIC CELLS, DEVICES, AND METHODS OF USING THE SAME
 (72) RUST, William L, c/o Seraxis, INC. 20271 Goldenrod Lane, Suite 2085, Germantown, Maryland 20876, US

(51) MKP
A61K 31/416 2006 (97) EP 3755696
A61P 17/06 2006
A61P 19/04 2006
A61P 35/00 2006
C07D 401/14 2006
C07D 403/04 2006
C07D 403/14 2006
C07D 405/14 2006
C07D 487/04 2006
 (96) EP 19711736.9 2/22/2019
 (97) EP 3755696, 12/30/2020 202053, en
 (31) 201862634656 P (32) 23.02.2018 (33) US
 (54) 5-HETEROARYL SUBSTITUTED INDAZOLE-3-CARBOXAMIDES AND PREPARATION AND USE THEREOF
 (72) KC, Sunil Kumar, 10504 Clasico Court, San Diego, California 92127, US
 MAK, Chi Ching, 11942 Caneridge Road, San Diego, California 92128, US
 MITTAPALLI, Gopi Kumar, 4158 Decoro Street 47, San Diego, California 92122, US
 HOFILENA, Brian Joseph, 4049 Florida Street, 1, San Diego, California 92104, US
 EASTMAN, Brian Walter, 10518 Caminito Pollo, San Diego, California 92126, US
 CAO, Jianguo, 9898 Avenger Court, San Diego, California 92126, US
 CHIRUTA, Chandramouli, 4158 Decoro Street Apt. 61, San Diego, California 92122, US
 BOLLU, Venkataiah, 10715 Wexford St. 6, San Diego, California 92131, US

(51) MKP
A61K 48/00 2006 (97) EP 3752616
C12N 15/113 2010
C12N 15/90 2006
 (96) EP 19712058.7 2/15/2019
 (97) EP 3752616, 12/23/2020 202052, en
 (31) 201862710415 P (32) 16.02.2018 (33) US
 (54) COMPOSITIONS AND METHODS FOR GENE EDITING BY TARGETING FIBRINOGEN-ALPHA
 (72) BROOKS, Alan, Richard, c/o Casebia Therapeutics Limited Liability Partnership 455 Mission Bay Boulevard South, San Francisco, CA 94158, US
 VO, Karen, c/o Casebia Therapeutics Limited Liability Partnership 455 Mission Bay Boulevard South, San Francisco, CA 94158, US

(51) MKP
F01K 7/16 2006 (97) EP 3737839
F01K 11/02 2006
F01K 19/08 2006
F22B 1/16 2006
F22B 3/04 2006
 (96) EP 19712266.6 1/25/2019
 (97) EP 3737839, 11/18/2020 202047, en
 (31) AP2018014694 (32) 06.02.2018 (33) GE
 (54) GEOTHERMAL ENERGY DEVICE
 (71) BERIDZE, Enriko, 10; Titcian Tabidze I Lane Apt. 4, 0179 Tbilisi, GE
 IORAMASHVILI, Solomon, 10, Z. Paliashvili Street, App. 13, 0179 Tbilisi, GE
 KOCHLADZE, Shalva, 11a, A. Kazbegi Avenue, App. 42, 0160 Tbilisi, GE
 (72) IORAMASHVILI, Solomon, 10, Z. Paliashvili Street, App.13, 0179 Tbilisi, GE
 KOCHLADZE, Shalva, 11a, A. Kazbegi Avenue, App.42, 0160 Tbilisi, GE
 JINCHARADZE, David, 25, K.Kekelidze street, App. 69, 0179 Tbilisi, GE

-
- (51) MKP
A61K 31/712 2006 (97) EP 3749767
A61K 31/7125 2006
A61P 7/06 2006
C12N 15/113 2010
- (96) EP 19713183.2 2/5/2019
(97) EP 3749767, 12/16/2020 202051, en
(31) 201862626423 P (32) 05.02.2018 (33) US
- (54) MATERIALS AND METHODS FOR TREATMENT OF HEMOGLOBINOPATHIES
(72) CHAKRABORTY, Tirtha, 610 Main Street, Cambridge, MA 02139, US
LIN, Michelle-i-ching, 610 Main Street, Cambridge, MA 02139, US
-
- (51) MKP
A61K 31/4985 2006 (97) EP 3759111
A61P 35/00 2006
C07D 487/04 2006
- (96) EP 19713584.1 3/1/2019
(97) EP 3759111, 1/6/2021 202101, en
(31) 201803439 (32) 02.03.2018 (33) GB
201814135 30.08.2018 GB
- (54) PHARMACEUTICAL COMPOUNDS
(71) Otsuka Pharmaceutical Co., Ltd., 2-9, Kanda Tsukasa-machi Chiyoda-ku, Tokyo 101-8535, JP
(72) JOHNSON, Christopher Norbert, c/o Astex Therapeutics Limited 436 Cambridge Science Park Milton Road, Cambridge CB4 0QA, GB
BUCK, Ildiko Maria, c/o Astex Therapeutics Limited 436 Cambridge Science Park Milton Road, Cambridge CB4 0QA, GB
CHESSARI, Gianni, c/o Astex Therapeutics Limited 436 Cambridge Science Park Milton Road, Cambridge CB4 0QA, GB
DAY, James Edward Harvey, c/o Astex Therapeutics Limited 436 Cambridge Science Park Milton Road, Cambridge CB4 0QA, GB
FUJIWARA, Hideto, c/o Astex Therapeutics Limited 436 Cambridge Science Park Milton Road, Cambridge CB4 0QA, GB
HAMLETT, Christopher Charles Frederick, c/o Astex Therapeutics Limited 436 Cambridge Science Park Milton Road, Cambridge CB4 0QA, GB
HISCOCK, Steven Douglas, c/o Astex Therapeutics Limited 436 Cambridge Science Park Milton Road, Cambridge CB4 0QA, GB
HOLVEY, Rhian Sara, c/o Astex Therapeutics Limited 436 Cambridge Science Park Milton Road, Cambridge CB4 0QA, GB
HOWARD, Steven, c/o Astex Therapeutics Limited 436 Cambridge Science Park Milton Road, Cambridge CB4 0QA, GB
LIEBESCHUETZ, John Walter, c/o Astex Therapeutics Limited 436 Cambridge Science Park Milton Road, Cambridge CB4 0QA, GB
PALMER, Nicholas John, c/o Astex Therapeutics Limited 436 Cambridge Science Park Milton Road, Cambridge CB4 0QA, GB
ST DENIS, Jeffrey David, c/o Astex Therapeutics Limited 436 Cambridge Science Park Milton Road, Cambridge CB4 0QA, GB
TWIGG, David Geoffrey, c/o Astex Therapeutics Limited 436 Cambridge Science Park Milton Road, Cambridge CB4 0QA, GB
WOODHEAD, Andrew James, c/o Astex Therapeutics Limited 436 Cambridge Science Park Milton Road, Cambridge CB4 0QA, GB
-
- (51) MKP
A61K 31/519 2006 (97) EP 3759112
A61P 9/00 2006
A61P 25/00 2006
A61P 29/00 2006
A61P 35/00 2006
C07D 487/04 2006
C07D 519/00 2006
- (96) EP 19713602.1 2/26/2019
(97) EP 3759112, 1/6/2021 202101, en
(31) 201862635926 P (32) 27.02.2018 (33) US
201862718216 P 13.08.2018 US
201862721312 P 22.08.2018 US
201962793015 P 16.01.2019 US
- (54) IMIDAZOPYRIMIDINES AND TRIAZOLOPYRIMIDINES AS A2A / A2B INHIBITORS
(72) WANG, Xiaozhao, 1801 Augustine Cut-Off, Wilmington, Delaware 19803, US
GAN, Pei, 1801 Augustine Cut-Off, Wilmington, Delaware 19803, US
HAN, Heeoon, 1801 Augustine Cut-Off, Wilmington, Delaware 19803, US
HUANG, Taisheng, 1801 Augustine Cut-Off, Wilmington, Delaware 19803, US
MCCAMMANT, Matthew S., 1801 Augustine Cut-Off, Wilmington, Delaware 19803, US
QI, Chao, 1801 Augustine Cut-Off, Wilmington, Delaware 19803, US
QIAN, Ding-Quan, 1801 Augustine Cut-Off, Wilmington, Delaware 19803, US
WU, Liangxing, 1801 Augustine Cut-Off, Wilmington, Delaware 19803, US
YAO, Wenqing, 1801 Augustine Cut-Off, Wilmington, Delaware 19803, US
YU, Zhiyong, 1801 Augustine Cut-Off, Wilmington, Delaware 19803, US
ZHANG, Fenglei, 1801 Augustine Cut-Off, Wilmington, Delaware 19803, US

ZHAO, Le, 1801 Augustine Cut-Off, Wilmington, Delaware 19803, US
 HE, Chunhong, 1801 Augustine Cut-Off, Wilmington, Delaware 19803, US

- (51) MKP
G01N 15/00 2006 (97) EP 3759490
G01N 33/543 2006
- (96) EP 19713906.6 2/28/2019
 (97) EP 3759490, 1/6/2021 202101, en
- (31) 201862636840 P (32) 28.02.2018 (33) US
- (54) METHODS FOR DETECTING PARTICLES PRESENT IN A CELL COMPOSITION
 (72) LIVINGSTON, Britney Jo, 400 Dexter Ave. N, Suite 1200, Seattle, Washington 98109, US
 YUE, Hai, 400 Dexter Ave. N, Suite 1200, Seattle, Washington 98109, US

- (51) MKP
E05B 5/00 2006 (97) EP 3728766
E05B 5/02 2006
E05B 47/00 2006
- (96) EP 19714503.0 2/27/2019
 (97) EP 3728766, 10/28/2020 202044, en
- (54) DOOR HANDLE ASSEMBLY WITH SAFETY FUNCTION
 (72) PIRNAR Gasper, Kermaunerjeva 9, 1000 Ljubljana, SI

- (51) MKP
C07K 16/28 2006 (97) EP 3752532
- (96) EP 19714877.8 2/11/2019
 (97) EP 3752532, 12/23/2020 202052, en
- (31) 18156288 (32) 12.02.2018 (33) EP
- (54) IMPROVED ANTAGONISTIC ANTI-HUMAN CD40 MONOCLONAL ANTIBODIES
 (71) Diabetes-Free, Inc., 3 Columbus Circle, New York NY 10019, US
 (72) ADANG, Anton Egbert Peter, c/o Yalelaan 46, 3584 CM Utrecht, NL
 DE BOER, Mark, c/o Yalelaan 46, 3584 CM Utrecht, NL

- (51) MKP
B01D 15/18 2006 (97) EP 3759467
G01N 21/35 2014
G01N 21/3577 2014
G01N 21/552 2014
G01N 21/84 2006
G01N 30/46 2006
G01N 30/78 2006
G01N 30/86 2006
G01N 30/88 2006
- (96) EP 19715277.0 3/1/2019
 (97) EP 3759467, 1/6/2021 202101, en
- (31) 201862637891 P (32) 02.03.2018 (33) US
 201862673845 P 18.05.2018 US
 201862729402 P 10.09.2018 US
- (54) MULTIVARIATE SPECTRAL ANALYSIS AND MONITORING OF BIOMANUFACTURING
 (72) WASALATHANTHRI, Dhanuka Pulasthi, 17 Tannery Rd., Fiskdale, Massachusetts 01518, US
 TEWARI, Jagdish C., c/o Sanofi U.S. 55 Corporate Drive Mail-Code: 55A- 525, Bridgewater, New Jersey 08807, US
 KANG, Xuezheng, c/o Sanofi U.S. 55 Corporate Drive Mail-Code: 55A- 525, Bridgewater, New Jersey 08807, US
 HINCAPIE, Marina, c/o Sanofi U.S. 55 Corporate Drive Mail-Code: 55A- 525, Bridgewater, New Jersey 08807, US
 BARRETT, Shawn L., c/o Sanofi U.S. 55 Corporate Drive Mail-Code: 55A- 525, Bridgewater, New Jersey 08807, US
 POLLOCK, Julie Susanne, c/o Sanofi U.S. 55 Corporate Drive Mail-Code: 55A- 525, Bridgewater, New Jersey 08807, US

- (51) MKP
A61K 31/553 2006 (97) EP 3758708
A61P 11/06 2006
- (96) EP 19716296.9 3/1/2019
 (97) EP 3758708, 1/6/2021 202101, en
- (31) 201862636944 P (32) 01.03.2018 (33) US

- (54) PHARMACEUTICAL COMPOSITIONS COMPRISING (2S)--((1S)-1-CYANO-2-[4-(3-METHYL-2-OXO-2,3-DIHYDRO-1,3-BENZOXAZOL-5-YL)PHENYL]ETHYL)-1,4-OXAZEPANE-2-CARBOXAMIDE
 (71) AstraZeneca AB, 151 85 Södertälje, SE
 (72) WIKSTRÖM, Håkan, c/o Astrazeneca R&D Gothenberg, 431 83 Mölndal, SE
 LUDVIGSSON, Jufang Wu, c/o Astrazeneca R&D Gothenberg, 431 83 Mölndal, SE
 ANDERSSON, Thomas, c/o Astrazeneca R&D Gothenberg, 431 83 Mölndal, SE

- (51) MKP
F16L 27/08 2006 (97) EP 3736479
F16L 27/12 2006
F16L 51/00 2006
F16L 51/02 2006
 (96) EP 19717958.3 2/22/2019
 (97) EP 3736479, 11/11/2020 202046, en
 (31) 201830243 (32) 12.03.2018 (33) ES
 (54) EXPANSION-COMPENSATING ELEMENT
 (71) ABN Pipe Systems, S.L.U., Carretera Baños de Arteixo 28 Parque Empresarial La Grela, 15008 La Coruña, ES
 (72) VAZQUEZ SANCHEZ, Javier Antonio, Carretera Baños de Arteixo, 28 Parque Empresarial La Grela, 15008 A CORUÑA, ES
 ROSA ARIZA, David, Carretera Baños de Arteixo, 28 Parque Empresarial La Grela, 15008 A CORUÑA, ES

- (51) MKP
A61K 31/712 2006 (97) EP 3749768
A61K 31/7125 2006
A61P 7/06 2006
C12N 15/113 2010
 (96) EP 19718194.4 2/5/2019
 (97) EP 3749768, 12/16/2020 202051, en
 (31) 201862626426 P (32) 05.02.2018 (33) US
 (54) MATERIALS AND METHODS FOR TREATMENT OF HEMOGLOBINOPATHIES
 (72) CHAKRABORTY, Tirtha, 610 Main Street, Cambridge, MA 02139, US
 MISHRA, Bibhu, Prasad, 610 Main Street, Cambridge, MA 02139, US

- (51) MKP
A61P 31/16 2006 (97) EP 3743442
C07K 16/10 2006
 (96) EP 19719656.1 1/24/2019
 (97) EP 3743442, 12/2/2020 202049, en
 (31) 201862622480 P (32) 26.01.2018 (33) US
 (54) HUMAN ANTIBODIES TO INFLUENZA HEMAGGLUTININ
 (72) PURCELL, Lisa A., c/o Regeneron Pharmaceuticals, Inc. 777 Old Saw Mill River Road Tarrytown, New York 10591, US
 VIAU, Jonathan, c/o Regeneron Pharmaceuticals, Inc. 777 Old Saw Mill River Road Tarrytown, New York 10591, US
 OLSON, William, c/o Regeneron Pharmaceuticals, Inc. 777 Old Saw Mill River Road Tarrytown, New York 10591, US

- (51) MKP
E03C 1/042 2006 (97) EP 3735548
F16L 5/10 2006
 (96) EP 19722850.5 5/3/2019
 (97) EP 3735548, 11/11/2020 202046, de
 (31) 102018110768 (32) 04.05.2018 (33) DE
 202018102495 U 04.05.2018 DE
 (54) SEALING COLLAR FOR COMPOSITE SEALS
 (72) SOMMER, Mario, Lerchenweg 12, 65594 Runkel, DE

- (51) MKP
A23L 33/135 2016 (97) EP 3743086
A61K 35/74 2015
A61K 39/02 2006
A61P 1/00 2006
A61P 3/10 2006
A61P 11/06 2006
A61P 17/06 2006
A61P 19/02 2006

	A61P 35/00	2006				
	A61P 37/00	2006				
	A61P 43/00	2006				
(96)	EP 19725068.1 5/13/2019					
(97)	EP 3743086, 12/2/2020 202049, en					
(31)	18171893		(32)	11.05.2018	(33)	EP
	18178136			15.06.2018		EP
	201810386			25.06.2018		GB
	201813460			17.08.2018		GB
	201817642			29.10.2018		GB
	201820264			12.12.2018		GB
	201820256			12.12.2018		GB
(54)	COMPOSITIONS COMPRISING BACTERIAL STRAINS					
(72)	MULDER, Imke Elisabeth, c/o 4D Pharma Research Limited Life Sciences Innovation Building Cornhill Road Aberdeen, Aberdeenshire AB25 2ZS, GB					
	FOTIADOU, Parthena, c/o 4D Pharma Research Limited Life Sciences Innovation Building Cornhill Road Aberdeen, Aberdeenshire AB25 2ZS, GB					
	HOLT, Amy Beth, c/o 4D Pharma Research Limited Life Sciences Innovation Building Cornhill Road Aberdeen, Aberdeenshire AB25 2ZS, GB					
	AHMED, Suaad, c/o 4D Pharma Research Limited Life Sciences Innovation Building Cornhill Road Aberdeen, Aberdeenshire AB25 2ZS, GB					
	ETTORRE, Anna, c/o 4D Pharma Research Limited Life Sciences Innovation Building Cornhill Road Aberdeen, Aberdeenshire AB25 2ZS, GB					
	YUILLE, Samantha, 27 Auchmill Terrace Bucksburn Aberdeen, Aberdeenshire AB21 9LF, GB					
	DINAN, Ted, Merton French's Walk Cobh County, Cork, IE					
	CRYAN, John, Sunday's Well, Cork, IE					

(51)	MKP					
	A61K 31/4704	2006	(97)	EP 3720442		
	A61K 31/4709	2006				
	A61P 35/00	2006				
	A61P 35/02	2006				
(96)	EP 19728271.8 5/16/2019					
(97)	EP 3720442, 10/14/2020 202042, en					
(31)	201862672462 P		(32)	16.05.2018	(33)	US
	201862672461 P			16.05.2018		US
	201862680571 P			04.06.2018		US
	201862680566 P			04.06.2018		US
	201862680562 P			04.06.2018		US
	201862680560 P			04.06.2018		US
	201862692598 P			29.06.2018		US
	201862692601 P			29.06.2018		US
	201862692604 P			29.06.2018		US
	201862692605 P			29.06.2018		US
	201862692591 P			29.06.2018		US
	201862773562 P			30.11.2018		US
	201962798677 P			30.01.2019		US
	201962798681 P			30.01.2019		US
	201962798684 P			30.01.2019		US
	201962798687 P			30.01.2019		US
	201962798690 P			30.01.2019		US
	201962812367 P			01.03.2019		US
(54)	INHIBITING MUTANT IDH-1					
(72)	KELLY, Patrick F., c/o Forma Therapeutics, Inc. 500 Arsenal Street Suite 100, Watertown, Massachusetts 02472, US					
	COLLIS, Alan, c/o Forma Therapeutics, Inc. 500 Arsenal Street Suite 100, Watertown, Massachusetts 02472, US					
	DAVIS, Jeff, c/o Forma Therapeutics, Inc. 500 Arsenal Street Suite 100, Watertown, Massachusetts 02472, US					
	WALKER, Duncan, c/o Forma Therapeutics, Inc. 500 Arsenal Street Suite 100, Watertown, Massachusetts 02472, US					
	ASHWELL, Susan, c/o Forma Therapeutics, Inc. 500 Arsenal Street Suite 100, Watertown, Massachusetts 02472, US					
	THOMSON, Blythe, c/o Forma Therapeutics, Inc. 500 Arsenal Street Suite 100, Watertown, Massachusetts 02472, US					

(51)	MKP					
	A61K 9/00	2006	(97)	EP 3746047		
	A61K 31/4196	2006				
	A61K 47/34	2017				
(96)	EP 19733972.4 6/12/2019					
(97)	EP 3746047, 12/9/2020 202050, en					
(31)	18382413		(32)	12.06.2018	(33)	EP
(54)	INJECTABLE COMPOSITION					

(72) FRANCO RODRÍGUEZ, Guillermo, C/ Julián Camarillo, 35, 28037 Madrid, ES
GUTIERRO ADURIZ, Ibon, C/ Julián Camarillo, 35, 28037 Madrid, ES

(51) MKP
A61K 31/351 2006 (97) EP 3737367
A61K 31/40 2006
A61K 31/4025 2006
C07D 405/00 2006
C07D 405/02 2006
C07D 405/04 2006

(96) EP 19735699.1 1/7/2019

(97) EP 3737367, 11/18/2020 202047, en

(31) 201862614923 P (32) 08.01.2018 (33) US

(54) METHODS OF TREATING SOLID TUMORS WITH CCR2 ANTAGONISTS

(71) The Regents of the University of California, Office of Technology Transfer 1111 Franklin Street, 12th Floor, Oakland, CA 94607, US

(72) CAMPBELL, James J., 2433 Downing Avenue, San Jose, California 95128, US

SINGH, Rajinder, 1832 Hillman Avenue, Belmont, California 94002, US

HWANG, Samuel, 1111 Franklin Street, 12th Floor, Oakland, California 94607, US

WU, Xuesong, 1111 Franklin Street, 12th Floor, Oakland, California 94607, US

(51) MKP
A61K 31/712 2006 (97) EP 3735252
A61K 31/7125 2006
A61K 31/713 2006
C07H 21/02 2006
C12N 15/113 2010

(96) EP 19735992.0 1/3/2019

(97) EP 3735252, 11/11/2020 202046, en

(31) 201862613742 P (32) 04.01.2018 (33) US

(54) HETERODUPLEX NUCLEIC ACID MOLECULES AND USES THEREOF

(72) GEALL, Andrew John, 10975 North Torrey Pines Road. Suite 150, La Jolla, California 92037, US

DOPPALAPUDI, Venkata Ramana, 10975 North Torrey Pines Road. Suite 150, La Jolla, California 92037, US

JOHNS, Rachel Elizabeth, 10975 N. Torrey Pines Road, Ste 150, La Jolla, California 92037, US

BURKE, Rob, 10975 North Torrey Pines Road. Suite 150, La Jolla, California 92037, US

CHU, David Sai-Ho, 10975 North Torrey Pines Road, Suite 150, La Jolla, California 92037, US

COCHRAN, Michael Caramian, 10975 North Torrey Pines Road. Suite 150, La Jolla, California 92037, US

HOOD, Michael David, 10975 North Torrey Pines Road, Suite 150, La Jolla, California 92037, US

HUANG, Hanhua, 10975 N. Torrey Pines Road, Ste 150, La Jolla, California 92037, US

(51) MKP
A61K 31/341 2006 (97) EP 3737366
A61K 31/395 2006
A61K 31/4035 2006
C07D 209/44 2006
C07D 209/46 2006
C07D 307/52 2006

(96) EP 19736005.0 1/7/2019

(97) EP 3737366, 11/18/2020 202047, en

(31) 201862614927 P (32) 08.01.2018 (33) US
 201862715503 P 07.08.2018 US

(54) METHODS OF TREATING GENERALIZED PUSTULAR PSORIASIS WITH AN ANTAGONIST OF CCR6 OR CXCR2

(72) CAMPBELL, James J., 2433 Downing Avenue, San Jose, California 95128, US

EBSWORTH, Karen, 156 Lombard Street, Apt. 24, San Francisco, California 94111, US

KRASINSKI, Antoni, 746 W. Knickerbocker Drive, Sunnyvale, California 94087, US

MALI, Venkat Reddy, 20800 Valley Green Drive, 427, Cupertino, California 95014, US

MCMAHON, Jeffrey, 15 Alta Mar Way, San Francisco, California 94121, US

SINGH, Rajinder, 1832 Hillman Avenue, Belmont, California 94002, US

YANG, Ju, 966 Clara Drive, Palo Alto, California 94303, US

YU, Chao, 555 E. Washington Avenue, Apt. 1105, Sunnyvale, California 94086, US

ZHANG, Penglie, 1036 Jamaica Street, Foster City, California 94404, US

(51) MKP

	C12N 9/02 2006		(97) EP 3737748		
	C12P 19/18 2006				
	C12Q 1/26 2006				
	C12Q 1/6806 2018				
	C12Q 1/6827 2018				
	C12Q 1/6869 2018				
(96)	EP 19736010.0	1/8/2019			
(97)	EP 3737748,	11/18/2020	202047, en		
(31)	201862614798 P			(32)	08.01.2018
	201862660523 P				20.04.2018
	201862771409 P				26.11.2018
(54)	BISULFITE-FREE, BASE-RESOLUTION IDENTIFICATION OF CYTOSINE MODIFICATIONS				
(72)	SONG, Chunxiao, C/o Ludwig Institute For Cancer Research Ltd, Oxford OX3 7BN, GB				
	LIU, Yibin, C/o Ludwig Institute For Cancer Research Ltd, Oxford OX3 7BN, GB				
<hr/>					
(51)	MKP				
	C07D 239/557 2006		(97) EP 3736568		
	C07H 19/073 2006				
	G01N 30/26 2006				
	G01N 30/34 2006				
	G01N 30/88 2006				
(96)	EP 19736109.0	1/4/2019			
(97)	EP 3736568,	11/11/2020	202046, en		
(31)	2018000881			(32)	05.01.2018
	201816040734				20.07.2018
	201810821041				24.07.2018
(54)	DETECTION METHOD FOR ANALOG DERIVED FROM TRIFLURIDINE				
(72)	TAKEDA, Daisuke, c/o TAIHO PHARMACEUTICAL CO., LTD., 3, Okubo, Tsukuba-shi, Ibaraki 300-2611, JP				
	KOJIMA, Akiyo, c/o TAIHO PHARMACEUTICAL CO., LTD., 224-2, Hiraishi Ebisuno, Kawauchi-cho, Tokushima-shi, Tokushima 771-0194, JP				
<hr/>					
(51)	MKP				
	A61K 47/68 2017		(97) EP 3737421		
	C07K 16/28 2006				
(96)	EP 19738220.3	1/11/2019			
(97)	EP 3737421,	11/18/2020	202047, en		
(31)	201862617021 P			(32)	12.01.2018
	201862673535 P				18.05.2018
(54)	METHODS FOR ANTIBODY DRUG CONJUGATION, PURIFICATION, AND FORMULATION				
(72)	MILANO, Daniel F., 53 Sturges Road, Reading, Massachusetts 01867, US				
	REARDON, Michael R., 77 Arnold Road North, Attleboro, Massachusetts 02760, US				
	SILVA, Richard A., 587 Greendale Ave., Needham, Massachusetts 02492, US				
	HUTCHINS, Benjamin M., 500 Paddock Ln Apt. 5304, Boxborough, Massachusetts 01719-1778, US				
	HERBST, Robert W., 31 Hollins Avenue, Braintree, Massachusetts 02181, US				
<hr/>					
(51)	MKP				
	A61L 2/18 2006		(97) EP 3737425		
	A61L 2/238 2006				
	C01B 11/04 2006				
(96)	EP 19739020.6	1/14/2019			
(97)	EP 3737425,	11/18/2020	202047, en		
(31)	201862617263 P			(32)	14.01.2018
	201862721991 P				23.08.2018
(54)	COMPOSITIONS, KITS, METHODS AND USES FOR CLEANING, DISINFECTING, STERILIZING AND/OR TREATING				
(71)	Collision, Inc., 1770 Corporate Circle, Petaluma, California 94954, US				
(72)	ALIMI, Hojabr, 1770 Corporate Circle, Petaluma, California 94954, US				
	PRASAD, Sridhar Govinda, 1770 Corporate Circle, Petaluma, California 94954, US				
	DE, Surya Kanta, 1770 Corporate Circle, Petaluma, California 94954, US				
<hr/>					
(51)	MKP				
	C07D 401/04 2006		(97) EP 3740475		
	C07D 498/04 2006				
	C07F 5/02 2006				
(96)	EP 19740733.1	1/16/2019			

(97) EP 3740475, 11/25/2020 202048, en
 (31) 201862618538 P (32) 17.01.2018 (33) US
 (54) PROCESS OF MAKING SOMATOSTATIN MODULATORS
 (72) REDDY, Jayachandra P., 10222 Barnes Canyon Road Building 2, San Diego, California 92121, US
 MIRMEHRABI, Mahmoud, 10222 Barnes Canyon Road Building 2, San Diego, California 92121, US
 KOTA, Madhukar, 10222 Barnes Canyon Road Building 2, San Diego, California 92121, US
 DASH, Uttam, 10222 Barnes Canyon Road Building 2, San Diego, California 92121, US
 ZHAO, Jian, 10222 Barnes Canyon Road Building 2, San Diego, California 92121, US
 ZHU, Yunfei, 10222 Barnes Canyon Road Building 2, San Diego, California 92121, US

(51) MKP
C12N 15/09 2006 (97) EP 3740571
C12N 15/63 2006
C12N 15/64 2006
C12N 15/66 2006
C12N 15/86 2006

(96) EP 19741445.1 1/18/2019
 (97) EP 3740571, 11/25/2020 202048, en
 (31) 201862619392 P (32) 19.01.2018 (33) US
 (54) CLOSED-ENDED DNA VECTORS OBTAINABLE FROM CELL-FREE SYNTHESIS AND PROCESS FOR OBTAINING CEDNA VECTORS
 (72) ALKAN, Ozan, c/o Generation Bio Co. 301 Binney Street, 4th Floor, Cambridge, Massachusetts 02142, US
 KOTIN, Robert Michael, c/o Generation Bio Co. 301 Binney Street, 4th Floor, Cambridge, Massachusetts 02142, US
 STANTON, Matthew, c/o Generation Bio Co. 301 Binney Street, 4th Floor, Cambridge, Massachusetts 02142, US
 KERR, Douglas Anthony, c/o Generation Bio Co. 301 Binney Street, 4th Floor, Cambridge, Massachusetts 02142, US
 PELLETIER, Carolyn, c/o Generation Bio Co. 301 Binney Street, 4th Floor, Cambridge, Massachusetts 02142, US

(51) MKP
B32B 15/04 2006 (97) EP 3743273
B32B 27/04 2006
H01B 5/10 2006
H01B 7/17 2006
H02G 1/02 2006
H02G 1/04 2006
H02G 7/02 2006
H02G 7/04 2006
H02G 7/05 2006
H02G 15/18 2006

(96) EP 19743339.4 1/24/2019
 (97) EP 3743273, 12/2/2020 202049, en
 (31) 201862621173 P (32) 24.01.2018 (33) US
 (54) TERMINATION ARRANGEMENT FOR AN OVERHEAD ELECTRICAL CABLE
 (71) CTC Global Corporation, 2026 McGaw Avenue, Irvine, CA 92614, US
 (72) BOSZE, Eric, 2026 McGaw Avenue, Irvine, California 92614, US
 WONG, Christopher, 2026 McGaw Avenue, Irvine, California 92614, US
 PILLING, Ian M., 2026 McGaw Avenue, Irvine, California 92614, US
 WEBB, William, 2026 McGaw Avenue, Irvine, California 92614, US
 PILLING, Douglas A., 2026 McGaw Avenue, Irvine, California 92614, US

(51) MKP
A61K 39/12 2006 (97) EP 3746462
A61K 39/155 2006
C07K 14/005 2006
C07K 14/135 2006
C12N 15/45 2006

(96) EP 19743531.6 1/24/2019
 (97) EP 3746462, 12/9/2020 202050, en
 (31) 201862623184 P (32) 29.01.2018 (33) US
 (54) STABILIZED RSV F PROTEINS AND USES THEREOF
 (72) ZHANG, Lan, 770 Sumneytown Pike, West Point, Pennsylvania 19486, US
 FRIDMAN, Arthur, 126 East Lincoln Avenue, Rahway, New Jersey 07065-0907, US
 DURR, Eberhard, 770 Sumneytown Pike, West Point, Pennsylvania 19486, US
 BETT, Andrew, 770 Sumneytown Pike, West Point, Pennsylvania 19486, US

(51) MKP
A61K 31/7105 2006 (97) EP 3746090
A61K 31/7115 2006
A61K 39/155 2006
A61P 31/14 2006
(96) EP 19743723.9 1/28/2019
(97) EP 3746090, 12/9/2020 202050, en
(31) 201862623240 P (32) 29.01.2018 (33) US
(54) RSV RNA VACCINES
(72) CIARAMELLA, Giuseppe, 1 Hawes Road, Sudbury, MA 01776, US
BAHL, Kapil, 14 Ames Street, Medford, MA 02155, US
ESPESETH, Amy, 219 Holly Drive, Chalfont, PA 18914, US
BETT, Andrew J., 834 Collins Avenue, Lansdale, PA 19446, US
CEJAS, Pedro, 2000 Bridle Lane, Oreland, PA 19075, US
ZHANG, Lan, 65 Kulp Road West, Chalfont, PA 18914, US
SHAW, Christine, 51 County Road, Reading, MA 01867, US

(51) MKP
A61K 31/403 2006 (97) EP 3743065
A61K 31/404 2006
A61K 31/4439 2006
C07D 209/42 2006
C07D 403/12 2006
(96) EP 19743778.3 1/24/2019
(97) EP 3743065, 12/2/2020 202049, en
(31) 201862621915 P (32) 25.01.2018 (33) US
(54) SULFONAMIDE DERIVATIVES FOR PROTEIN DEGRADATION
(72) GRAY, Nathanael S., 26 Greenview Avenue, Boston, MA 02130, US
FISCHER, Eric, 69 Pond Brook Road, Chestnut Hill, MA 02467, US
YOON, Hojong, 11 Peabody Terrace, 1801, Cambridge, MA 02138, US
ZHANG, Tinghu, 118 Franklin Street, Apt. 2, Brookline, MA 02445, US
FAUST, Tyler, 30 Harvard Ave, Apt. 2, Brookline, MA 02446, US
DONOVAN, Katherine, 27 Park Drive, Apt. 3, Boston, MA 02215, US
CAI, Quan, 220 Handan Rd, Yichuanxue Building Room 513 Yangpu, Shanghai 200433, CN

(51) MKP
G10L 19/00 2013 (97) EP 3743916
G10L 19/02 2013
G10L 19/16 2013
H04N 19/00 2014
(96) EP 19743801.3 1/28/2019
(97) EP 3743916, 12/2/2020 202049, en
(31) 201862622205 P (32) 26.01.2018 (33) US
(54) BACKWARD-COMPATIBLE INTEGRATION OF HIGH FREQUENCY RECONSTRUCTION TECHNIQUES FOR AUDIO SIGNALS
(72) KJOERLING, Kristofer, c/o Dolby Sweden AB Gävlegatan 12A, 113 30 Stockholm, SE
VILLEMOES, Lars, c/o Dolby Sweden AB Gävlegatan 12A, 113 30 Stockholm, SE
PURNHAGEN, Heiko, c/o Dolby Sweden AB Gävlegatan 12A, 113 30 Stockholm, SE
EKSTRAND, Per, c/o Dolby Sweden AB Gävlegatan 12A, 113 30 Stockholm, SE

(51) MKP
A61K 9/52 2006 (97) EP 3746091
A61K 31/785 2006
A61P 1/12 2006
C08F 212/14 2006
C08F 212/36 2006
(96) EP 19746690.7 1/30/2019
(97) EP 3746091, 12/9/2020 202050, en
(31) 201862623895 P (32) 30.01.2018 (33) US
(54) CHOLESTYRAMINE FORMULATIONS AND METHODS OF USE
(71) Pharmascience Inc., 6111 Royalmount Suite 100, Montréal, Québec H4P 2T4, CA
(72) TANGUAY, Sophie, 6111 Royalmount Avenue, Suite 100 Montréal, Québec H4P 2T4, CA
DEBNATH, Smita, 6111 Royalmount Avenue, Suite 100 Montréal, Québec H4P 2T4, CA
KANDIL, Mustapha, 8 rue Benoît Kirkland, Québec H9H5H7, CA

(51)	MKP							
	A61K 31/435	2006	(97) EP 3746434					
	A61P 9/04	2006						
	C07D 403/04	2006						
(96)	EP 19747117.0 2/1/2019							
(97)	EP 3746434, 12/9/2020 202050, en							
(31)	201811003855		(32)	01.02.2018		(33)		IN
	201811003859			01.02.2018				IN
	201711042921			30.05.2018				IN
(54)	PYRAZOLE COMPOUNDS AND PREPARATION THEREOF							
(71)	MyoKardia, Inc., 1000 Sierra Point Parkway, Brisbane CA 94005, US							
(72)	SHARMA, Sunil, SRF Limited, Unicrest Building, Block-C, Sector 45, Haryana, Gurgaon 122003, IN							
	JANGID, Dinesh, SRF Limited, Unicrest Building, Block-C, Sector 45, Haryana, Gurgaon 122003, IN							
	DHAKA, Priyanka, SRF Limited, Unicrest Building, Block-C, Sector 45, Haryana, Gurgaon 122003, IN							
	MADHWAL, Siddharth, SRF Limited, Unicrest Building, Block-C, Sector 45, Haryana, Gurgaon 122003, IN							
	KUMAR, Bharat, SRF Limited, Unicrest Building, Block-C, Sector 45, Haryana, Gurgaon 122003, IN							
	KUMAR, Kapil, SRF Limited, Unicrest Building, Block-C, Sector 45, Haryana, Gurgaon 122003, IN							
	ANAND, Rajdeep, SRF Limited, Unicrest Building, Block-C, Sector 45, Haryana, Gurgaon 122003, IN							
	JAIN, Anurag, SRF Limited, Unicrest Building, Block-C, Sector 45, Haryana, Gurgaon 122003, IN							

(51)	MKP							
	A61K 35/76	2015	(97) EP 3746100					
	A61K 38/17	2006						
	A61K 48/00	2006						
	A61M 1/36	2006						
	A61M 5/14	2006						
(96)	EP 19747125.3 1/30/2019							
(97)	EP 3746100, 12/9/2020 202050, en							
(31)	201862624616 P		(32)	31.01.2018		(33)		US
(54)	GENE THERAPY FOR LIMB-GIRDLE MUSCULAR DYSTROPHY TYPE 2C							
(72)	RODINO-KLAPAC, Louise R., c/o Research Institute at Nationwide Children's Hospital 700 Children's Drive, Columbus, Ohio 43205, US							

(51)	MKP							
	A61K 31/135	2006	(97) EP 3747471					
	A61K 31/397	2006						
	A61K 31/403	2006						
	A61K 31/4245	2006						
	A61K 31/426	2006						
	A61K 31/496	2006						
	A61K 45/00	2006						
	A61P 9/10	2006						
	A61P 27/02	2006						
(96)	EP 19747229.3 2/1/2019							
(97)	EP 3747471, 12/9/2020 202050, en							
(31)	2018016911		(32)	02.02.2018		(33)		JP
(54)	MEDICINE FOR PREVENTING OR TREATING OPHTHALMIC DISEASE ASSOCIATED WITH ENHANCED INTRAOCULAR NEOVASCULARIZATION AND/OR INTRAOCULAR VASCULAR PERMEABILITY							
(71)	Kyoto University, 36-1, Yoshida-honmachi Sakyo-ku, Kyoto-shi, Kyoto 606-8501, JP							
	Astellas Pharma Inc., 5-1, Nihonbashi-Honcho 2-Chome, Chuo-ku Tokyo 103-8411, JP							
(72)	HARA, Hideaki, c/o Gifu Pharmaceutical University, Daigaku-nishi 1-25-4, Gifu-shi, Gifu 501-1196, JP							
	NARUMIYA, Shuh, c/o Kyoto University, 36-1, Yoshida-honmachi, Sakyo-ku, Kyoto-shi, Kyoto 606-8501, JP							
	AOKI, Tomohiro, c/o Kyoto University, 36-1, Yoshida-honmachi, Sakyo-ku, Kyoto-shi, Kyoto 606-8501, JP							
	ARAMORI, Ichiro, c/o Astellas Pharma Inc., 5-1, Nihonbashi-Honcho 2-chome, Chuo-ku, Tokyo 103-8411, JP							
	YAMAMOTO, Rie, c/o Astellas Pharma Inc., 5-1, Nihonbashi-Honcho 2-chome, Chuo-ku, Tokyo 103-8411, JP							

(51)	MKP							
	A61K 31/437	2006	(97) EP 3747888					
	A61K 31/4985	2006						
	A61K 31/506	2006						
	A61P 3/10	2006						
	A61P 9/04	2006						
	A61P 9/12	2006						

A61P 43/00 2006
C07D 487/04 2006
C07D 498/04 2006
C07D 519/00 2006
(96) EP 19747660.9 1/30/2019
(97) EP 3747888, 12/9/2020 202050, en
(31) 2018016328 (32) 01.02.2018 (33) JP
(54) NITROGENATED HETEROCYCLIC AMIDE COMPOUND, AND USE THEREOF FOR MEDICAL PURPOSES
(71) Japan Tobacco Inc., 1-1, Toranomom 4-chome Minato-ku, Tokyo 105-6927, JP
(72) MAEBA, Takaki, c/o Central Pharmaceutical Research Institute, Japan Tobacco Inc., 1-1, Murasaki-cho, Takatsuki-shi, Osaka 569-1125, JP
SUZAWA, Koichi, c/o Central Pharmaceutical Research Institute, Japan Tobacco Inc., 1-1, Murasaki-cho, Takatsuki-shi, Osaka 569-1125, JP
KOTOKU, Masayuki, c/o Central Pharmaceutical Research Institute, Japan Tobacco Inc., 1-1, Murasaki-cho, Takatsuki-shi, Osaka 569-1125, JP
MASUO, Ritsuki, c/o Central Pharmaceutical Research Institute, Japan Tobacco Inc., 1-1, Murasaki-cho, Takatsuki-shi, Osaka 569-1125, JP
MOTODA, Dai, c/o Central Pharmaceutical Research Institute, Japan Tobacco Inc., 1-1, Murasaki-cho, Takatsuki-shi, Osaka 569-1125, JP
YAMAOKA, Nobutaka, c/o Central Pharmaceutical Research Institute, Japan Tobacco Inc., 1-1, Murasaki-cho, Takatsuki-shi, Osaka 569-1125, JP

(51) MKP
A47K 10/32 2006 (97) EP 3745935
A47K 10/34 2006
A47K 10/38 2006
(96) EP 19748283.9 1/30/2019
(97) EP 3745935, 12/9/2020 202050, en
(31) 201862623590 P (32) 30.01.2018 (33) US
(54) WIPE DISPENSING
(71) IONOGEN INC., 6321 Baum Drive, Knoxville, TN 37919, US
(72) SHANAHAN, John, Patrick, 5923 Kingston Pike Suite 123, Knoxville, TN 37919, US
KING, Christopher, Harold, 110 Parliament Court, Fayetteville, GA 30215, US

(51) MKP
C12N 7/00 2006 (97) EP 3749756
C12N 15/86 2006
C12Q 1/70 2006
(96) EP 19748361.3 2/5/2019
(97) EP 3749756, 12/16/2020 202051, en
(31) 201862626561 P (32) 05.02.2018 (33) US
(54) TRANSCRIPTION REGULATORY ELEMENTS AND USES THEREOF
(71) Audentes Therapeutics, Inc., 600 California Street 17th Floor, San Francisco, CA 94108, US
(72) GRAY, John T., 101 Montgomery Street Suite 2650, San Francisco, CA 94104, US

(51) MKP
C12M 1/00 2006 (97) EP 3749745
C12M 3/00 2006
C12N 5/071 2010
(96) EP 19750902.9 2/5/2019
(97) EP 3749745, 12/16/2020 202051, en
(31) 201862627799 P (32) 08.02.2018 (33) US
(54) TISSUE ENGINEERED SCAFFOLDS, INSTRUMENTED BIOREACTORS AND METHODS OF USE THEREOF
(71) President and Fellows of Harvard College, 17 Quincy Street, Cambridge, Massachusetts 02138, US
(72) MACQUEEN, Luke, A., 58 Oxford Street, Cambridge, MA 02138, US
PARKER, Kevin, Kit, 29 Oxford Street, Cambridge, MA 02138, US
GOSS, Josue, A., 1002 S 3rd Street, Rogers, Arkansas 72756, US
CHANTRE, Christophe, 58 Oxford Street, Cambridge, MA 02138, US

(51) MKP
C07D 401/14 2006 (97) EP 3752498
C07D 471/04 2006
(96) EP 19751144.7 2/11/2019
(97) EP 3752498, 12/23/2020 202052, en
(31) 201862629377 P (32) 12.02.2018 (33) US
201862673042 P 17.05.2018 US
201862724421 P 29.08.2018 US
(54) SOMATOSTATIN MODULATORS AND USES THEREOF

(72) ZHAO, Jian, 10222 Barnes Canyon Road Building 2, San Diego, California 92121, US
 WANG, Shimiao, 10222 Barnes Canyon Road Building 2, San Diego, California 92121, US
 ZHU, Yunfei, 10222 Barnes Canyon Road Building 2, San Diego, California 92121, US

(51) MKP
H01L 41/02 2006 (97) EP 3750196
H01L 41/04 2006
H01L 41/08 2006
H02K 7/14 2006
H02N 2/10 2006
H02N 2/14 2006

(96) EP 19751800.4 1/30/2019

(97) EP 3750196, 12/16/2020 202051, en

(31) 201862709944 P (32) 06.02.2018 (33) US
 201816350749 31.12.2018 US

(54) ELECTRICAL AMPLIFICATION SYSTEMS THROUGH RESONANCE

(71) Vital Tech LLC, 1712 Pioneer Avenue, Cheyenne, WY 82001-4406, US

(72) ALCON, Andrew R., 7437 Yolanda Drive, Fort Worth, TX 76112, US

(51) MKP
A61K 9/19 2006 (97) EP 3723777
A61K 35/74 2015
A61K 35/741 2015
A61P 1/00 2006
A61P 43/00 2006

(96) EP 19755806.7 6/25/2019

(97) EP 3723777, 10/21/2020 202043, en

(31) 18179641 (32) 25.06.2018 (33) EP
 201814836 12.09.2018 GB
 201905000 09.04.2019 GB

(54) COMPOSITIONS COMPRISING BACTERIAL STRAINS

(72) YUILLE, Samantha, 27 Auchmill Terrace Bucksburn, Aberdeen, Aberdeenshire AB21 9LF, GB

REICHARDT, Nicole, c/o 4D Pharma Research Limited Life Sciences Innovation Building, Cornhill Road, Aberdeen, Aberdeenshire AB25 2ZS, GB

REID, Sarah, c/o 4D Pharma Research Limited Life Sciences Innovation Building, Cornhill Road, Aberdeen, Aberdeenshire AB25 2ZS, GB

AHMED, Suaad, c/o 4D Pharma Research Limited Life Sciences Innovation Building, Cornhill Road, Aberdeen, Aberdeenshire AB25 2ZS, GB

SAVIGNAC, Helene, c/o 4D Pharma Research Limited Life Sciences Innovation Building, Cornhill Road, Aberdeen, Aberdeenshire AB25 2ZS, GB

MULDER, Imke Elisabeth, c/o 4D Pharma Research Limited Life Sciences Innovation Building, Cornhill Road, Aberdeen, Aberdeenshire AB25 2ZS, GB

ETTORRE, Anna, c/o 4D Pharma Research Limited Life Sciences Innovation Building, Cornhill Road, Aberdeen, Aberdeenshire AB25 2ZS, GB

(51) MKP
A61K 9/14 2006 (97) EP 3756670
A61K 9/16 2006
A61K 9/20 2006
A61K 9/48 2006
A61K 31/4965 2006
A61K 47/26 2006
A61K 47/36 2006
A61P 7/00 2006
A61P 7/02 2006
A61P 9/08 2006
A61P 11/08 2006
A61P 43/00 2006

(96) EP 19756715.9 2/20/2019

(97) EP 3756670, 12/30/2020 202053, en

(31) 2018029093 (32) 21.02.2018 (33) JP

(54) GRANULAR COMPOSITION, METHOD FOR PRODUCING GRANULAR COMPOSITION, AND METHOD FOR IMPROVING ELUTION PROPERTY OF GRANULAR COMPOSITION

(71) Nippon Shinyaku Co., Ltd., 14, Kisshoin Nishinosho Monguchicho Minami-ku, Kyoto-shi Kyoto 601-8550, JP

(72) TANAKA Toshinori, c/o NIPPON SHINYAKU CO., LTD., 14, Kisshoin Nishinosho Monguchicho, Minami-ku, Kyoto-shi, Kyoto 601-8550, JP

YAMADA Rie, c/o NIPPON SHINYAKU CO., LTD., 14, Kisshoin Nishinosho Monguchicho, Minami-ku, Kyoto-shi, Kyoto 601-8550, JP

(51)	MKP							
	A61K 9/14	2006	(97) EP 3758710					
	A61K 9/19	2006						
	A61K 31/675	2006						
(96)	EP 19756753.0	2/26/2019						
(97)	EP 3758710, 1/6/2021	202101, en						
(31)	201821007142		(32)	26.02.2018		(33)	IN	
(54)	STABLE LYOPHILIZED COMPOSITION OF CYCLOPHOSPHAMIDE							
(72)	PATEL, Aditya, Intas Pharmaceuticals Ltd. Astron Division Plot 457/458, Sarkhej-Bavla Highway Matoda 382210- Tal.: Sanand, Ahmedabad, Gujarat 382210, IN							
	PATEL, Kerul, Intas Pharmaceuticals Ltd. Astron Division Plot 457/458, Sarkhej-Bavla Highway Matoda 382210- Tal.: Sanand, Ahmedabad, Gujarat 382210, IN							
	DADHANIYA, Dhaval, Intas Pharmaceuticals Ltd. Astron Division Plot 457/458, Sarkhej-Bavla Highway Matoda 382210- Tal.: Sanand, Ahmedabad, Gujarat 382210, IN							
<hr/>								
(51)	MKP							
	A61K 31/137	2006	(97) EP 3755312					
	A61K 31/485	2006						
	A61P 25/00	2006						
	A61P 25/18	2006						
	A61P 25/24	2006						
	A61P 25/28	2006						
	A61P 25/30	2006						
(96)	EP 19756920.5	2/25/2019						
(97)	EP 3755312, 12/30/2020	202053, en						
(31)	201862634718 P		(32)	23.02.2018		(33)	US	
	201962794469 P			18.01.2019			US	
	201962809480 P			22.02.2019			US	
(54)	DOSAGE FORMS AND METHODS FOR ENANTIOMERICALLY ENRICHED OR PURE BUPROPION							
(71)	Axsome Therapeutics, Inc., 22 Cortlandt Street, 16th Floor, New York, NY 10007, US							
(72)	TABUTEAU, Herriot, 22 Cortlandt Street, 16th Floor, New York, NY 10007, US							
<hr/>								
(51)	MKP							
	C07K 16/28	2006	(97) EP 3755721					
	C07K 16/32	2006						
(96)	EP 19757000.5	2/20/2019						
(97)	EP 3755721, 12/30/2020	202053, en						
(31)	201862632756 P		(32)	20.02.2018		(33)	US	
	201862677137 P			28.05.2018			US	
(54)	MULTI-SPECIFIC BINDING PROTEINS THAT BIND CD33, NKG2D, AND CD16, AND METHODS OF USE							
(72)	CHANG, Gregory, P., 143 Saunders Street, Medford, MA 02155, US							
	CHEUNG, Ann, F., 25 Morningside Lane, Lincoln, MA 01733, US							
	GRINBERG, Asya, 37 Follen Road, Lexington, MA 02421, US							
	SETHI, Dhruv, Kam, 51 Hill Road, 610, Belmont, MA 02478, US							
	HANEY, William, 61 Lincoln Road, Wayland, MA 01778, US							
	PRINZ, Bianka, 7 Lucent Drive, Lebanon, NH 03766, US							
	LUNDE, Bradley M., 7 Lucent Drive, Lebanon, New Hampshire 03766, US							
<hr/>								
(51)	MKP							
	A61K 31/015	2006	(97) EP 3755311					
	A61K 31/03	2006						
	C07C 211/38	2006						
(96)	EP 19757004.7	2/21/2019						
(97)	EP 3755311, 12/30/2020	202053, en						
(31)	201862633973 P		(32)	22.02.2018		(33)	US	
(54)	INDANE-AMINES AS PD-L1 ANTAGONISTS							
(72)	LANGE, Christopher, 6818 Cutting Boulevard, El Cerrito, California 94530, US							
	PUNNA, Sreenivas, 938 Fontana Terrace, Sunnyvale, California 94085, US							
	SINGH, Rajinder, 1832 Hillman Avenue, Belmont, California 94002, US							
	YANG, Ju, 966 Clara Drive, Palo Alto, California 94303, US							
	ZHANG, Penglie, 1036 Jamaica Street, Foster City, California 94404, US							
<hr/>								
(51)	MKP							

C12N 15/86 2006 (97) EP 3755803
C12N 15/864 2006
C12N 15/87 2006
(96) EP 19757005.4 2/21/2019
(97) EP 3755803, 12/30/2020 202053, en
(31) 201862633757 P (32) 22.02.2018 (33) US
201862633882 P 22.02.2018 US
201862633795 P 22.02.2018 US
201862746762 P 17.10.2018 US
(54) CONTROLLED EXPRESSION OF TRANSGENES USING CLOSE-ENDED DNA (CEDNA) VECTORS
(72) KERR, Douglas A., c/o Generation Bio Co. 301 Binney Street, 4th Floor, Cambridge, Massachusetts 02142, US
STANTON, Matthew G., c/o Generation Bio Co. 301 Binney Street, 4th Floor, Cambridge, Massachusetts 02142, US
CHIOCCO, Matt, c/o Generation Bio Co. 301 Binney Street, 4th Floor, Cambridge, Massachusetts 02142, US
ANGELINO, Mark D., c/o Generation Bio Co. 301 Binney Street, 4th Floor, Cambridge, Massachusetts 02142, US
KOTIN, Robert M., c/o Generation Bio Co. 301 Binney Street, 4th Floor, Cambridge, Massachusetts 02142, US
SAMAYOA, Phillip, c/o Generation Bio Co. 301 Binney Street, 4th Floor, Cambridge, Massachusetts 02142, US

(51) MKP
A61K 35/17 2015 (97) EP 3755348
A61K 39/395 2006
A61K 48/00 2006
(96) EP 19757093.0 2/20/2019
(97) EP 3755348, 12/30/2020 202053, en
(31) 201862632756 P (32) 20.02.2018 (33) US
(54) ANTIBODY VARIABLE DOMAINS TARGETING CD33, AND USE THEREOF
(72) CHANG, Gregory, P., 143 Saunders Street, Medford, MA 02155, US
CHEUNG, Ann, F., 25 Morningside Lane, Lincoln, MA 01773, US
GRINBERG, Asya, 37 Follen Road, Lexington, MA 02421, US
SETHI, Dhruv, Kam, 51 Hill Road, 610, Belmont, MA 02478, US
HANEY, William, 61 Lincoln Road, Wayland, MA 01778, US
PRINZ, Bianka, 7 Lucent Drive, Lebanon, NH 03766, US

(51) MKP
A01N 37/10 2006 (97) EP 3755148
A61K 31/235 2006
(96) EP 19757829.7 2/22/2019
(97) EP 3755148, 12/30/2020 202053, en
(31) 201862634575 P (32) 23.02.2018 (33) US
(54) NANOSUSPENSIONS OF SALSALATE AND METHODS OF USING THE SAME
(71) RHNanoPharma, 140 Ocean Avenue, Monmouth Beach, New Jersey 07724, US
(72) ROSS, Joel, c/o RHNANOPHARMA 140 Ocean Avenue, Monmouth Beach, New Jersey 07724, US
HASAN, Izhar, c/o RHNANOPHARMA 140 Ocean Avenue, Monmouth Beach, New Jersey 07724, US

(51) MKP
A61K 9/00 2006 (97) EP 3755805
A61K 38/17 2006
A61K 48/00 2006
A61P 25/00 2006
A61P 27/16 2006
C07K 14/435 2006
C12N 15/65 2006
C12N 15/86 2006
(96) EP 19757886.7 2/22/2019
(97) EP 3755805, 12/30/2020 202053, en
(31) 201862634088 P (32) 22.02.2018 (33) US
(54) COMPOSITIONS AND METHODS FOR TREATING NON-AGE-ASSOCIATED HEARING IMPAIRMENT IN A HUMAN SUBJECT
(72) SIMONS, Emmanuel John, 7 Stetson Street, Brookline, Massachusetts 02446, US
NG, Robert, 47 Lincoln Road, Unit 1, Newton, Massachusetts 02458, US
REISINGER, Ellen, Geierweg 26, 72144 Dußlingen, DE
AL-MOYED, Hanan, Ritterplan 3, 37073 Göttingen, DE
KÜGLER, Sebastian, Valentinsbreite 63, 37073 Göttingen, DE

(51) MKP

	A61K 38/00	2006	(97) EP 3758729				
	A61K 38/20	2006					
	C07K 14/54	2006					
	C12N 15/24	2006					
(96)	EP 19758302.4 2/26/2019						
(97)	EP 3758729, 1/6/2021 202101, en						
(31)	201862635133 P		(32)	26.02.2018		(33)	US
(54)	IL-15 CONJUGATES AND USES THEREOF						
(72)	CAFFARO, Carolina E., 11099 North Torrey Pines Road, Suite 290, La Jolla, California 92037, US PTACIN, Jerod, 11099 North Torrey Pines Road, Suite 290, La Jolla, California 92037, US MILLA, Marcos, 11099 North Torrey Pines Road, Suite 290, La Jolla, California 92037, US						
(51)	MKP						
	A61K 31/513	2006	(97) EP 3760616				
	A61P 3/00	2006					
	A61P 27/04	2006					
	A61P 35/00	2006					
	A61P 37/02	2006					
	A61P 37/08	2006					
	C07D 239/22	2006					
(96)	EP 19759983.0 2/27/2019						
(97)	EP 3760616, 1/6/2021 202101, en						
(31)	2018035597		(32)	28.02.2018		(33)	JP
(54)	4-METHYLDIHYDOPYRIMIDINONE COMPOUND AND MEDICINAL USE THEREOF						
(72)	SAKAI, Takayuki, c/o Central Pharmaceutical Research Institute of Japan Tobacco Inc., 1-1, Murasaki-cho, Takatsuki-shi, Osaka 569-1125, JP IKENOGAMI, Taku, c/o Central Pharmaceutical Research Institute of Japan Tobacco Inc., 1-1, Murasaki-cho, Takatsuki-shi, Osaka 569-1125, JP						
(51)	MKP						
	A61K 31/4155	2006	(97) EP 3760624				
	A61P 3/10	2006					
	A61P 43/00	2006					
	C07D 403/12	2006					
(96)	EP 19760111.5 2/28/2019						
(97)	EP 3760624, 1/6/2021 202101, en						
(31)	2018036307		(32)	01.03.2018		(33)	JP
(54)	METHYLLACTAM RING COMPOUND AND MEDICINAL USE THEREOF						
(72)	MIURA, Tomoya, c/o Central Pharmaceutical Research Institute of Japan Tobacco Inc., 1-1, Murasaki-cho, Takatsuki-shi, Osaka 569-1125, JP TAMATANI, Yoshinori, c/o Central Pharmaceutical Research Institute of Japan Tobacco Inc., 1-1, Murasaki-cho, Takatsuki-shi, Osaka 569-1125, JP						
(51)	MKP						
	A61K 38/17	2006	(97) EP 3759125				
	A61K 39/395	2006					
	C07K 14/43	2006					
	C07K 14/435	2006					
	C07K 14/705	2006					
(96)	EP 19760261.8 2/27/2019						
(97)	EP 3759125, 1/6/2021 202101, en						
(31)	201862636236 P		(32)	28.02.2018		(33)	US
(54)	METHODS FOR TREATING CANCER USING COMBINATIONS OF ANTI-BTNL2 AND IMMUNE CHECKPOINT BLOCKADE AGENTS						
(72)	FREEMAN, Gordon J., 305 Walnut Street, Brookline, MA 02445, US XIAO, Yanping, 60 Babcock Street, Apt. 66, Brookline, MA 02446, US						
(51)	MKP						
	G01M 11/00	2006	(97) EP 3759454				
(96)	EP 19760511.6 2/27/2019						
(97)	EP 3759454, 1/6/2021 202101, en						
(31)	201862635626 P		(32)	27.02.2018		(33)	US
	201862786271 P			28.12.2018			US
	201962807298 P			19.02.2019			US
(54)	SYSTEMS, METHODS AND TOOLS FOR THE INTERROGATION OF COMPOSITE STRENGTH MEMBERS						
(72)	DONG, Xiaoyuan, 2026 McGaw Avenue, Irvine, California 92614, US WEBB, William, 2026 McGaw Avenue, Irvine, California 92614, US						

WONG, Christopher, 2026 McGaw Avenue, Irvine, California 92614, US
 PILLING, Ian, 2026 McGaw Avenue, Irvine, California 92614, US

- (51) MKP
A01N 57/12 2006 (97) EP 3758495
A01N 57/20 2006
A61K 31/661 2006
- (96) EP 19760530.6 3/1/2019
 (97) EP 3758495, 1/6/2021 202101, en
- (31) 201862637965 P (32) 02.03.2018 (33) US
 201962798859 P 30.01.2019 US
- (54) NANOPARTICLE COMPOSITIONS
 (71) January Therapeutics, Inc., 11575 Sorrento Valley Road Suite 200, San Diego, California 92121, US
 (72) RAHEJA, Raj, 11575 Sorrento Valley Road, Suite 200, San Diego, California 92121, US
 JACKMAN, Robin M., 11575 Sorrento Valley Road, Suite 200, San Diego, California 92121, US
 KAHANA, Jason A., 11575 Sorrento Valley Road, Suite 200, San Diego, California 92121, US

- (51) MKP
G06F 3/0481 2013 (97) EP 3759633
G06F 21/50 2013
H04L 12/22 2006
H04L 12/24 2006
H04L 29/06 2006
H04L 29/08 2006
- (96) EP 19760592.6 2/27/2019
 (97) EP 3759633, 1/6/2021 202101, en
- (31) 201862636368 P (32) 28.02.2018 (33) US
 201862696896 P 12.07.2018 US
- (54) METHODS AND SYSTEMS FOR CYBER-MONITORING AND VISUALLY DEPICTING CYBER-ACTIVITIES
 (71) CYBER DEFENCE QCD CORPORATION, 1268 Potter Drive, Ottawa, ON K4M 1C9, CA
 (72) DE JESUS, Tiago Alves, 1268 Potter Drive, Ottawa, ontario K4M 1C9, CA

- (51) MKP
C12N 9/14 2006 (97) EP 3759217
C12N 9/22 2006
C12N 15/00 2006
C12N 15/62 2006
C12N 15/63 2006
- (96) EP 19760769.0 3/1/2019
 (97) EP 3759217, 1/6/2021 202101, en
- (31) 201862637594 P (32) 02.03.2018 (33) US
 201862716431 P 09.08.2018 US
- (54) CLOSED-ENDED DNA (CEDNA) VECTORS FOR INSERTION OF TRANSGENES AT GENOMIC SAFE HARBORS (GSH) IN HUMANS AND MURINE GENOMES
 (72) KOTIN, Robert M., c/o Generation Bio Co. 301 Binney Street 4th Floor, Cambridge Massachusetts 02142, US

- (51) MKP
C07C 253/34 2006 (97) EP 3760612
C07C 255/03 2006
- (96) EP 19760953.0 2/26/2019
 (97) EP 3760612, 1/6/2021 202101, en
- (31) 2018033238 (32) 27.02.2018 (33) JP
- (54) METHOD FOR PURIFYING NITRILE SOLVENT
 (72) SAITO, Shota, c/o Takaoka Plant, Nippon Soda Co., Ltd., 300, Mukainohonmachi, Takaoka-shi, Toyama 933-8507, JP
 WADA, Ryoji, c/o Takaoka Plant, Nippon Soda Co., Ltd., 300, Mukainohonmachi, Takaoka-shi, Toyama 933-8507, JP
 MATSUDA, Keiichiro, c/o Takaoka Plant, Nippon Soda Co., Ltd., 300, Mukainohonmachi, Takaoka-shi, Toyama 933-8507, JP
 NAKASHIMA, Ryoyo, c/o Takaoka Plant, Nippon Soda Co., Ltd., 300, Mukainohonmachi, Takaoka-shi, Toyama 933-8507, JP
 KOMATSU, Fuminori, c/o Takaoka Plant, Nippon Soda Co., Ltd., 300, Mukainohonmachi, Takaoka-shi, Toyama 933-8507, JP

- (51) MKP
C12N 15/90 2006 (97) EP 3759226
- (96) EP 19761102.3 3/1/2019

(97) EP 3759226, 1/6/2021 202101, en
 (31) 201862637583 P (32) 02.03.2018 (33) US
 201862716421 P 09.08.2018 US
 201862743811 P 10.10.2018 US
 (54) IDENTIFYING AND CHARACTERIZING GENOMIC SAFE HARBORS (GSH) IN HUMANS AND MURINE GENOMES, AND VIRAL AND NON-VIRAL VECTOR COMPOSITIONS FOR TARGETED INTEGRATION AT AN IDENTIFIED GSH LOCI
 (71) University of Massachusetts, One Beacon Street, Boston MA 02108, US
 (72) KOTIN, Robert M., c/o Generation Bio Co. 301 Binney Street, 4th Floor, Cambridge, Massachusetts 02142, US
 HILDEBRANDT, Evin, c/o University of Massachusetts One Beacon Street, Boston, Massachusetts 02108, US

(51) MKP
B01D 1/22 2006 (97) EP 3760582
B01D 9/02 2006
C01B 21/086 2006
C01B 21/096 2006
C07C 311/48 2006
 (96) EP 19761157.7 2/26/2019
 (97) EP 3760582, 1/6/2021 202101, en
 (31) 2018035782 (32) 28.02.2018 (33) JP
 (54) METHOD FOR PRODUCING BIS(FLUOROSULFONYL)AMIDE ALKALI METAL SALT POWDER
 (72) HAYASHI, Kenichi, c/o Nihongi Plant, Nippon Soda Co., Ltd., 950, Fujisawa, Nakago-ku, Joetsu-shi, Niigata 949-2392, JP
 NISHIJIMA, Hiroyuki, c/o Takaoka Plant, Nippon Soda Co., Ltd., 300, Mukainohonmachi, Takaoka-shi, Toyama 933-8507, JP
 HORI, Masahiro, c/o Takaoka Plant, Nippon Soda Co., Ltd., 300, Mukainohonmachi, Takaoka-shi, Toyama 933-8507, JP
 NISHIZAWA, Toshiaki, c/o Takaoka Plant, Nippon Soda Co., Ltd., 300, Mukainohonmachi, Takaoka-shi, Toyama 933-8507, JP
 KOHORI, Asami, c/o Takaoka Plant, Nippon Soda Co., Ltd., 300, Mukainohonmachi, Takaoka-shi, Toyama 933-8507, JP

(51) MKP
A01N 47/02 2006 (97) EP 3760615
A01P 5/00 2006
A01P 7/04 2006
A61K 31/4155 2006
A61K 31/455 2006
A61P 33/10 2006
A61P 33/14 2006
C07D 213/81 2006
C07D 213/82 2006
C07D 409/12 2006
 (96) EP 19761269.0 2/25/2019
 (97) EP 3760615, 1/6/2021 202101, en
 (31) 2018033602 (32) 27.02.2018 (33) JP
 (54) HETEROARYL SULFONAMIDE COMPOUND AND PEST CONTROL AGENT
 (72) TAKAHASHI Jun, c/o Odawara Research Center, Nippon Soda Co., Ltd. 345, Takada, Odawara-shi, Kanagawa 250-0280, JP
 KATO Tetsuro, c/o Odawara Research Center, Nippon Soda Co., Ltd. 345, Takada, Odawara-shi, Kanagawa 250-0280, JP
 IWASA Takao, c/o Odawara Research Center, Nippon Soda Co., Ltd. 345, Takada, Odawara-shi, Kanagawa 250-0280, JP

(51) MKP
A61K 31/517 2006 (97) EP 3760619
A61K 31/519 2006
A61K 31/53 2006
A61P 3/00 2006
A61P 27/02 2006
A61P 35/00 2006
A61P 37/06 2006
A61P 37/08 2006
C07D 239/70 2006
C07D 239/80 2006
C07D 253/10 2006
C07D 487/04 2006
C07D 491/048 2006
C07D 491/052 2006
 (96) EP 19761273.2 2/27/2019
 (97) EP 3760619, 1/6/2021 202101, en
 (31) 2018035601 (32) 28.02.2018 (33) JP

- (54) SATURATED RING-CONDENSED DIHYDROPYRIMIDINONE OR DIHYDROTRIAZINONE COMPOUND, AND PHARMACEUTICAL USE THEREOF
 (72) YOKOTA, Masahiro, c/o Central Pharmaceutical Research Institute of Japan Tobacco Inc., 1-1, Murasaki-cho, Takatsuki-shi, Osaka 569-1125, JP
 SEKI, Noriyoshi, c/o Central Pharmaceutical Research Institute of Japan Tobacco Inc., 1-1, Murasaki-cho, Takatsuki-shi, Osaka 569-1125, JP
 WATANABE, Eiichi, c/o Central Pharmaceutical Research Institute of Japan Tobacco Inc., 1-1, Murasaki-cho, Takatsuki-shi, Osaka 569-1125, JP
 FUJIOKA, Shingo, c/o Central Pharmaceutical Research Institute of Japan Tobacco Inc., 1-1, Murasaki-cho, Takatsuki-shi, Osaka 569-1125, JP
-

- (51) MKP
A61K 31/70 2006 (97) EP 3758712
A61K 31/7088 2006
A61K 31/7115 2006
 (96) EP 19761384.7 3/1/2019
 (97) EP 3758712, 1/6/2021 202101, en
 (31) 201862637824 P (32) 02.03.2018 (33) US
 (54) CPG AMPHIPHILES AND USES THEREOF
 (71) Elicio Therapeutics, Inc., One Kendall Square Building 1400 West Suite 14303, Cambridge, MA 02139, US
 (72) DEMUTH, Peter, C., 74A Brookings Street, Medford, MA 02155, US
 STEINBUCK, Martin, 1 Emerson Place, Apt 6J, Boston, MA 02114, US
-

- (51) MKP
A61K 31/70 2006 (97) EP 3758713
A61K 31/7088 2006
A61K 31/7115 2006
 (96) EP 19761691.5 3/1/2019
 (97) EP 3758713, 1/6/2021 202101, en
 (31) 201862637879 P (32) 02.03.2018 (33) US
 (54) COMPOUNDS INCLUDING A MUTANT KRAS SEQUENCE AND A LIPID AND USES THEREOF
 (72) DEMUTH, Peter, C., 74a Brookings Street, Medford, MA 02155, US
 ADAMS, Julian, 673 Boylston Street, PH, Boston, MA 02116, US
 STEINBUCK, Martin, 1 Emerson Place, Apt 6J, Boston, MA 02114, US
-

- (51) MKP
A61P 9/00 2006 (97) EP 3687506
A61P 13/12 2006
A61P 25/28 2006
A61P 37/00 2006
C07D 209/08 2006
C07D 231/56 2006
C07D 235/08 2006
C07D 239/70 2006
C07D 261/20 2006
C07D 307/79 2006
C07D 307/81 2006
C07D 333/54 2006
C07D 403/10 2006
C07D 405/12 2006
C07D 407/04 2006
C07D 407/10 2006
C07D 409/12 2006
C07D 471/04 2006
C07D 487/04 2006
 (96) EP 19780738.1 4/5/2019
 (97) EP 3687506, 11/25/2020 202048, en
 (31) 201862654108 P (32) 06.04.2018 (33) US
 (54) SUBSTITUTED BENZOFURAN, BENZOPYRROLE, BENZOTHIOPHENE, AND STRUCTURALLY RELATED COMPLEMENT INHIBITORS
 (72) KOTIAN, Pravin, L., 1139 Magnolia Run, Hoover, AL 35226, US
 BABU, Yarlagadda, 4836 Southlake Parkway, Birmingham, AL 35244, US
 ZHANG, Weihe, 2645 Manchester Court, Vestavia Hills, AL 35226, US
 LU, Pen-Cheng, 1816 Altadena Ridge Place, Vestavia Hills, AL 35243, US
 WU, Minwan, 2709 Paden trail, Vestavia Hills, AL 35226, US
 LV, Wei, 5373 Park Side Circle, Hoover, AL 35244, US
 NGUYEN, Trung Xuan, 5066 Park Side Circle, Hoover, AL 35244, US
 DANG, Zhao, 1226 Parliament Lane, Vestavia Hills, AL 35244, US

CHINTAREDDY, Venkat, R., 1334 Renfro Road, Vestavia Hills, AL 35216, US
 KUMAR, V., Satish, 809 Mayapple Court, Birmingham, AL 35244, US
 RAMAN, Krishnan, 3739 Spearman Drive, Birmingham, AL 35216, US

- (51) MKP
A61K 31/13 2006 (97) EP 3740201
A61K 31/785 2006
A61P 13/12 2006
- (96) EP 19816018.6 6/4/2019
 (97) EP 3740201, 11/25/2020 202048, en
- (31) 201862680002 P (32) 04.06.2018 (33) US
 201862748361 P 19.10.2018 US
 PCT/US2018/059094 03.11.2018 WO
 201962825006 P 27.03.2019 US
 201962845290 P 08.05.2019 US
- (54) METHOD OF TREATING ACID-BASE DISORDERS
 (72) KLAERNER, Gerrit, 10 Kingswood Circle, Hillsborough, California 94010, US
 OTTO, Dawn Parsell, 3001 Kenai Dr., Cedar Park, Texas 78613-2526, US
 STASIV, Yuri, 280 Easy St. Apt. 206, Mountain View, California 94043, US
 MATHUR, Vandana, 25 Upenuf Rd., Woodside, California 94062, US
 LOCKEY, Claire, 1713 Notre Dame Avenue, Belmont, California 94002, US

- (51) MKP
A23D 9/00 2006 (97) EP 3737736
A23D 9/007 2006
B01D 11/02 2006
C11B 1/10 2006
C11B 3/12 2006
C11B 3/14 2006
- (96) EP 19842832.8 12/17/2019
 (97) EP 3737736, 11/18/2020 202047, fr
- (31) 1873103 (32) 17.12.2018 (33) FR
- (54) PROCESS FOR PRODUCING OILS AND DEFATTED MEAL BY MEANS OF SOLID/LIQUID EXTRACTION
 (71) Pennakem Europa, 224 Avenue de la Dordogne Zone d'Entreprise du Nord Gracht, 59640 Dunkerque, FR
 (72) RAPINEL, Vincent, 1171, route de l'aérodrome, 84140 Montfavet, FR
 PATOUILLEARD, Norbert, 13 ter, chemin de la halte du Méridien, 69260 Charbonnières les bains, FR
 CHEMAT, Farid, C/O Avignon Université 74 Rue Louis Pasteur, 84000 Avignon, FR
 FABIANO TIXIER, Anne-Sylvie, C/O Avignon Université 74 Rue Louis Pasteur, 84000 Avignon, FR
 RUIZ, Karine, C/O Avignon Université 74 Rue Louis Pasteur, 84000 Avignon, FR
 JACQUES, Laurence, 41, rue de l'Hôtel de Ville, 59240 Dunkerque, FR

- (51) MKP
A61B 5/00 2006 (97) EP 3680916
G16H 40/67 2018
G16H 80/00 2018
H04L 29/08 2006
H04N 7/15 2006
- (96) EP 20020007.9 1/7/2020
 (97) EP 3680916, 1/6/2021 202101, de
- (31) 102019000067 (32) 09.01.2019 (33) DE
- (54) AUDIO-VIDEO CONFERENCING SYSTEM FOR TELEMEDICINE
 (71) Lipp, Thomas, Marienbrunnenstr. 7, 04299 Leipzig, DE
 (72) Lipp, Thomas, Marienbrunnenstr. 7, 04299 Leipzig, DE

- (51) MKP
A61K 31/00 2006 (97) EP 3689910
A61K 39/395 2006
A61K 45/06 2006
A61K 47/68 2017
A61P 35/00 2006
C07K 16/28 2006
C07K 16/30 2006
- (96) EP 20150195.4 9/23/2015

(97) EP 3689910, 12/2/2020 202049, en
 (31) 201462054257 P (32) 23.09.2014 (33) US
 201462076823 P 07.11.2014 US
 201562136324 P 20.03.2015 US
 (54) METHOD OF USING ANTI-CD79B IMMUNOCONJUGATES
 (72) CHU, Yu-Waye, Genentech Inc. 1 DNA Way, San Francisco, CA California 94080, US
 YU, Shang-Fan, Genentech Inc. 1 DNA Way, San Francisco, CA California 94080, US
 POLSON, Andrew, Genentech Inc. 1 DNA Way, San Francisco, CA California 94080, US
 WENGER, Michael, F. Hoffmann-La Roche AG Grenzacherstrasse 124, CH-4070 Basel, CH

(51) MKP
A61K 47/68 2017 (97) EP 3730520
A61P 35/00 2006
C07K 16/28 2006
 (96) EP 20151844.6 7/8/2016
 (97) EP 3730520, 10/28/2020 202044, en
 (31) PCT/EP2015/065900 (32) 10.07.2015 (33) WO
 201662278283 P 13.01.2016 US
 (54) AXL-SPECIFIC ANTIBODY-DRUG CONJUGATES FOR CANCER TREATMENT
 (72) BOSHUIZEN, Julia, Legmeerstraat 83-2, NL-1058 NC Amsterdam, NL
 JACOBSEN, Kirstine, Jagtvej 40, 2., DK-5000 Odense, DK
 BREIJ, Esther, c/o Genmab B.V. Uppsalalaan 15, NL-3584 CT Utrecht, NL
 KOOPMAN, Louise, c/o Genmab B.V. Uppsalalaan 15, NL-3584 CT Utrecht, NL
 SATIJN, David, c/o Genmab B.V. Uppsalalaan 15, NL-3584 CT Utrecht, NL
 VAN DEN BRINK, Edward, c/o Genmab B.V. Uppsalalaan 15, NL-3584 CT Utrecht, NL
 VERZIJL, Dennis, c/o Genmab B.V. Uppsalalaan 15, NL-3584 CT Utrecht, NL
 DE JONG, Rob, c/o Genmab B.V. Uppsalalaan 15, NL-3584 CT Utrecht, NL
 VAN DIJKHUIZEN RADERSMA, Riemke, c/o Genmab B.V. Uppsalalaan 15, NL-3584 CT Utrecht, NL
 PEEPER, Daniel, Anton de Langelaan 2, NL-1183 DN Amstelveen, NL
 DITZEL, Henrik Jørn, Søgade 4, DK-8660 Skanderborg, DK
 PARREN, Paul, Werdorperwaard 17, NL-3984 PR Odijk, NL

(51) MKP
A45D 1/00 2006 (97) EP 3695743
A45D 1/04 2006
A45D 1/10 2006
A45D 1/18 2006
A45D 1/28 2006
A45D 2/00 2006
A45D 6/04 2006
 (96) EP 20152792.6 1/21/2020
 (97) EP 3695743, 1/6/2021 202101, de
 (31) 202019000660 U (32) 12.02.2019 (33) DE
 (54) HAIR STYLING DEVICE
 (71) KU Europe GmbH, Neckarstrasse 4, 45478 Mülheim an der Ruhr, DE
 (72) Kurbegovic, Amel, Neckarstraße 4, 45478 Mülheim an der Ruhr, DE

(51) MKP
C07D 249/08 2006 (97) EP 3663291
C07D 403/12 2006
C07D 413/12 2006
 (96) EP 20153455.9 5/9/2013
 (97) EP 3663291, 12/23/2020 202052, en
 (31) 201261644802 P (32) 09.05.2012 (33) US
 201361798188 P 15.03.2013 US
 (54) NUCLEAR TRANSPORT MODULATORS AND USES THEREOF
 (72) SANDANAYAKA, Vincent, P., 10 Laurel Avenue, Northboro, MA 01532, US
 SHECHTER, Sharon, 18 Ivy Lane, Andover, MA 01810, US
 SHACHAM, Sharon, 15 Bontempo Road, Newton, MA 02459, US
 MCCAULEY, Dilara, 85 Gore Street, Cambridge, MA 02141, US
 BALOGLU, Erkan, 8 Benjamin Terrace, Stoneham, MA 02180, US

(51) MKP

	A61K 9/00	2006	(97) EP 3679922			
	A61M 5/28	2006				
	A61M 5/31	2006				
	A61M 5/315	2006				
	A61P 27/02	2006				
	A61P 43/00	2006				
(96)	EP 20156274.1 5/30/2013					
(97)	EP 3679922, 9/30/2020 202040, en					
(31)	12170628		(32)	01.06.2012	(33)	EP
(54)	SYRINGE					
(72)	BRYANT, Andrew, Novartis Pharma AG Postfach, 4002 Basel, CH BUETTGEN, Heinrich, Novartis Pharma AG Postfach, 4002 Basel, CH PAPST, Wolfgang, Novartis Pharma AG Postfach, 4002 Basel, CH PICCI, Marie, Novartis Pharma AG Postfach, 4002 Basel, CH					
(51)	MKP					
	G01H 1/00	2006	(97) EP 3696520			
	G01H 9/00	2006				
(96)	EP 20156326.9 2/10/2020					
(97)	EP 3696520, 12/9/2020 202050, en					
(31)	201916274683		(32)	13.02.2019	(33)	US
(54)	ULTRASONIC ROTOR DEFLECTION MONITORING SYSTEM					
(71)	LOVEJOY CONTROLS CORPORATION, P.O. Box 702, Waukesha, Wisconsin 53187, US					
(72)	Lovejoy, Kim A, 3024 Cone View Lane, Waukesha, WI Wisconsin 53188, US					
(51)	MKP					
	A61K 35/76	2015	(97) EP 3701959			
	C12N 5/10	2006				
	C12N 15/85	2006				
	C12N 15/86	2006				
(96)	EP 20156693.2 3/13/2017					
(97)	EP 3701959, 11/11/2020 202046, en					
(31)	PCT/EP2016/056165		(32)	21.03.2016	(33)	WO
(54)	RNA REPLICON FOR VERSATILE AND EFFICIENT GENE EXPRESSION					
(72)	BEISSERT, Tim, Edith-Stein-Weg 4, 64521 Gross-Gerau, DE SAHIN, Ugur, Philipp-von-Zabern-Platz 1, 55116 Mainz, DE PERKOVIC, Mario, In der Weidbach 2d, 63477 Maintal, DE					
(51)	MKP					
	A61K 9/00	2006	(97) EP 3689379			
	A61K 9/14	2006				
	A61K 9/16	2006				
	A61K 31/00	2006				
	A61K 31/167	2006				
	A61K 31/194	2006				
	A61K 31/40	2006				
	A61K 31/573	2006				
	A61K 45/06	2006				
	A61K 47/12	2006				
	A61K 47/26	2006				
	A61P 11/00	2006				
	A61P 11/06	2006				
	A61P 11/08	2006				
	A61P 29/00	2006				
	A61P 43/00	2006				
(96)	EP 20156815.1 11/14/2016					
(97)	EP 3689379, 1/6/2021 202101, en					
(31)	15194661		(32)	16.11.2015	(33)	EP
(54)	A PROCESS FOR PREPARING A DRY POWDER FORMULATION COMPRISING AN ANTICHOLINERGIC, A CORTICOSTEROID AND A BETA-ADRENERGIC					
(72)	Cafiero, Claudio, Chiesi Farmaceutici S.p.A. Via Palermo 26/A, 43122 Parma, IT Ortenzi, Leonardo, Chiesi Farmaceutici S.p.A. Via Palermo 26/A, 43122 Parma, IT					

(51) MKP
A61J 1/10 2006 (97) EP 3701928
A61J 1/14 2006
A61J 1/20 2006
(96) EP 20157221.1 2/13/2020
(97) EP 3701928, 1/6/2021 202101, en
(31) 201900002745 (32) 26.02.2019 (33) IT
(54) STERILE OR STERILIZED PACKAGE FOR ADMINISTRATION OF MEDICINAL OR NUTRITIONAL SUBSTANCES
(72) GOBBI FRATTINI, Mr. Paolo Giuseppe, Via Stelvio, 12, 23035 Sondalo - SO, IT

(51) MKP
F28D 1/053 2006 (97) EP 3702717
F28F 9/26 2006
F28F 21/08 2006
(96) EP 20158609.6 2/20/2020
(97) EP 3702717, 10/21/2020 202043, en
(31) 201900002883 (32) 28.02.2019 (33) IT
(54) HEAD FOR THERMAL RADIATORS AND METHOD FOR MAKING THE HEAD
(72) LOLLI, Valter, Via Baracca 5, 40033 CASALECCHIO DI RENO, IT

(51) MKP
B01D 3/10 2006 (97) EP 3738957
B01D 3/14 2006
B01D 3/34 2006
B01D 11/04 2006
C07D 311/82 2006
(96) EP 20158964.5 2/24/2020
(97) EP 3738957, 11/18/2020 202047, en
(31) 201916415782 (32) 17.05.2019 (33) US
(54) METHOD FOR ACETYLATION OF CANNABINOIDS
(72) KO, Ryan Delmoral, c/o 68 Schooner Street Unit 3, Coquitlam, British Columbia V3K 7B1, CA
HUGHES, Brock, c/o 68 Schooner Street Unit 3, Coquitlam, British Columbia V3K 7B1, CA
PAL, Krupal Devendra, c/o 68 Schooner Street Unit 3, Coquitlam, British Columbia V3K 7B1, CA
CASSELMAN, Ivan Jason, c/o 68 Schooner Street Unit 3, Coquitlam, British Columbia V3K 7B1, CA

(51) MKP
A61K 45/06 2006 (97) EP 3739048
A61K 47/54 2017
A61P 9/00 2006
C12N 15/113 2010
(96) EP 20159104.7 5/22/2015
(97) EP 3739048, 11/18/2020 202047, en
(31) 201462001731 P (32) 22.05.2014 (33) US
201462047978 P 09.09.2014 US
(54) ANGIOTENSINOGEN (AGT) IRNA COMPOSITIONS AND METHODS OF USE THEREOF
(72) FOSTER, Donald, 300 Third Street 3rd Floor, Cambridge, MA 02142, US
BETTENCOURT, Brian, 300 Third Street 3rd Floor, Cambridge, MA 02142, US
CHARISSE, Klaus, 300 Third Street 3rd Floor, Cambridge, MA 02142, US
HINKLE, Gregory, 300 Third Street 3rd Floor, Cambridge, MA 02142, US
KUCHIMANCHI, Satyanarayana, 300 Third Street 3rd Floor, Cambridge, MA 02142, US
MAIER, Martin, 300 Third Street 3rd Floor, Cambridge, MA 02142, US
MILSTEIN, Stuart, 300 Third Street 3rd Floor, Cambridge, MA 02142, US

(51) MKP
C07K 16/00 2006 (97) EP 3738979
C07K 16/10 2006
C07K 16/28 2006
C07K 16/32 2006
(96) EP 20159405.8 1/9/2014
(97) EP 3738979, 11/18/2020 202047, en
(31) PA201300019 (32) 10.01.2013 (33) DK
201361751045 P 10.01.2013 US
PCT/EP2013/064330 05.07.2013 WO

(54) INERT FORMAT
 (72) LABRIJN, Aran Frank, c/o Genmab B.V. Uppsalalaan 15, 3584 CT Utrecht, NL
 MEESTERS, Joyce, c/o Genmab B.V. Uppsalalaan 15, 3584 CT Utrecht, NL
 NEIJSSSEN, Joost J., c/o Genmab B.V. Uppsalalaan 15, 3584 CT Utrecht, NL
 VAN DEN BRINK, Edward Norbert, c/o Genmab B.V. Uppsalalaan 15, 3584 CT Utrecht, NL
 SCHUURMAN, Janine, c/o Genmab B.V. Uppsalalaan 15, 3584 CT Utrecht, NL
 PARREN, Paul, Werdorperwaard 17, 3984 PR Odijk, NL

(51) MKP
A61K 31/7068 2006 (97) EP 3738595
A61P 35/00 2006
 (96) EP 20160070.7 12/21/2016
 (97) EP 3738595, 11/18/2020 202047, en
 (31) PCT/GB2015/054158 (32) 23.12.2015 (33) WO
 201609770 03.06.2016 GB
 (54) COMBINATION THERAPY
 (72) GRIFFITH, Hugh, c/o NuCana plc 3 Lochside Place, Edinburgh, EH12 9DT, GB

(51) MKP
A61P 25/28 2006 (97) EP 3721942
C07K 16/18 2006
 (96) EP 20160286.9 10/15/2013
 (97) EP 3721942, 10/14/2020 202042, en
 (31) 201261713996 P (32) 15.10.2012 (33) US
 (54) ANTIBODIES TO AMYLOID BETA
 (72) Groves, Maria, c/o MedImmune Limited Milstein Building Granta Park, Cambridge, CB21 6GH, GB
 Gustavsson, Suzanne, Fågelvägen 14, 14140 Huddinge, SE
 Höglund, Kina, Tomtebodavägen, 23B, Floor 4, 171 65 Solna, SE
 Lowne, David, c/o MedImmune Limited Milstein Building, Granta Park, Cambridge, CB21 6GH, GB
 Lloyd, Chris, c/o MedImmune Limited Milstein Building, Granta Park, Cambridge, CB21 6GH, GB
 Nickson, Adrian, c/o University Chemical Laboratory University of Cambridge Lensfield Road, Cambridge, Cambridgeshire CB1 2EW, GB
 Niva, Camilla, Tavelsjovägen 20, 120 59 Arsta, SE
 Simon, Sylvia, Ingenjörsvägen 40, 11759 Stockholm, SE

(51) MKP
A61K 38/00 2006 (97) EP 3721892
A61K 38/16 2006
A61K 38/17 2006
A61P 21/00 2006
A61P 21/04 2006
A61P 21/06 2006
C07K 14/47 2006
C07K 19/00 2006
C12N 15/62 2006
 (96) EP 20160287.7 6/4/2015
 (97) EP 3721892, 10/14/2020 202042, en
 (31) 201462007908 P (32) 04.06.2014 (33) US
 (54) METHODS AND COMPOSITIONS FOR TREATMENT OF DISORDERS WITH FOLLISTATIN POLYPEPTIDES
 (71) Acceleron Pharma Inc., 128 Sidney Street, Cambridge, MA 02139, US
 (72) Kumar, Ravindra, 421 Arlington Street, Acton, Massachusetts 01720, US
 Grinberg, Asya, 37 Follen Road, Lexington, Massachusetts 02421, US

(51) MKP
C12M 1/04 2006 (97) EP 3730608
C12N 5/0783 2010
 (96) EP 20161179.5 1/5/2018
 (97) EP 3730608, 10/28/2020 202044, en
 (31) 201762478506 P (32) 29.03.2017 (33) US
 201762539410 P 31.07.2017 US
 201762548306 P 21.08.2017 US
 201762554538 P 05.09.2017 US
 201762559374 P 15.09.2017 US
 201762567121 P 02.10.2017 US

201762577655 P	26.10.2017	US
201762582874 P	07.11.2017	US
201762596374 P	08.12.2017	US

- (54) PROCESSES FOR PRODUCTION OF TUMOR INFILTRATING LYMPHOCYTES AND USES OF SAME IN IMMUNOTHERAPY
 (72) WARDELL, Seth, 30204 USF Holly Drive, Tampa, FL 33620, US
 BENDER, James, 3 Cloverdale, Rancho Santa Margarita, CA 92688, US
 LOTZE, Michael, T., 5134 Westminster Place, Pittsburgh, PA 15232, US
-

(51) MKP
C12M 1/04 2006 (97) EP 3722415
C12N 5/0783 2010

- (96) EP 20161276.9 1/5/2018
 (97) EP 3722415, 10/14/2020 202042, en
 (31) 201762478506 P (32) 29.03.2017 (33) US
 201762539410 P 31.07.2017 US
 201762548306 P 21.08.2017 US
 201762554538 P 05.09.2017 US
 201762559374 P 15.09.2017 US
 201762567121 P 02.10.2017 US
 201762577655 P 26.10.2017 US
 201762582874 P 07.11.2017 US
 201762596374 P 08.12.2017 US

- (54) PROCESSES FOR PRODUCTION OF TUMOR INFILTRATING LYMPHOCYTES AND USES OF SAME IN IMMUNOTHERAPY
 (72) WARDELL, Seth, 30204 USF Holly Drive, Tampa, FL 33620, US
 BENDER, James, 3 Cloverdale, Rancho Santa Margarita, CA 92688, US
 LOTZE, Michael, T., 5134 Westminster Place, Pittsburgh, PA 15232, US
-

(51) MKP
F41A 3/44 2006 (97) EP 3686541
F41A 5/02 2006

- (96) EP 20162141.4 4/20/2016
 (97) EP 3686541, 10/21/2020 202043, en
 (54) HANDGUN WITH A LOCKING DEVICE
 (72) STRESHINSKI, Dimitry, Place de l'Alma, 5, 75008 PARIS, FR
-

(51) MKP
A61K 31/517 2006 (97) EP 3719014
C07D 403/04 2006

- (96) EP 20162228.9 5/17/2013
 (97) EP 3719014, 10/7/2020 202041, en
 (31) 201261648536 P (32) 17.05.2012 (33) US
 (54) SOLID FORMS OF AN AKT INHIBITING PYRIMIDINYL-CYCLOPENTANE COMPOUND, COMPOSITIONS AND METHODS THEREOF
 (72) CHAKRAVARTY, Paroma, c/o Genentech, Inc. 1 DNA Way, South San Francisco, CA 94080-4990, US
 KOTHARI, Sanjeev, c/o Genentech, Inc. 1 DNA Way, South San Francisco, CA 94080-4990, US
 GOSSELIN, Francis, c/o Genentech, Inc. 1 DNA Way, South San Francisco, CA 94080-4990, US
 SAVAGE, Scott J., c/o Genentech, Inc. 1 DNA Way, South San Francisco, CA 94080-4990, US
 STULTS, Jeffrey, c/o Genentech, Inc. 1 DNA Way, South San Francisco, CA 94080-4990, US
-

(51) MKP
B66B 5/00 2006 (97) EP 3733582

- (96) EP 20164444.0 3/20/2020
 (97) EP 3733582, 11/4/2020 202045, de
 (31) 3519 U (32) 22.03.2019 (33) AT
 (54) SHAFT SEPARATION ELEMENT
 (71) InoVA Solutions GmbH, Grosssulzerstrasse 13/6, 8142 Wundschuh, AT
 (72) Thomasser, Markus, RICHARD PFLUGER GASSE 37, A - 8200 GLEISDORF, DE
 Kerubichler, Markus, JAKOBI WEG 16, A - 8072 MELLACH, DE
-

(51) MKP
A61K 31/7125 2006 (97) EP 3730618
C12N 15/113 2010

- (96) EP 20164459.8 11/16/2012

(97) EP 3730618, 10/28/2020 202044, en
 (31) 201161561710 P (32) 18.11.2011 (33) US
 201261615618 P 26.03.2012 US
 201261680098 P 06.08.2012 US
 (54) RNAI AGENTS, COMPOSITIONS AND METHODS OF USE THEREOF FOR TREATING TRANSTHYRETIN (TTR) ASSOCIATED DISEASES
 (72) KALLANTHOTTATHIL, Rajeev G., c/o Alnylam Pharmaceuticals, Inc. 300 Third Street, 3rd Floor, Cambridge, MA 02142, US
 ZIMMERMANN, Tracy, c/o Alnylam Pharmaceuticals, Inc. 300 Third Street, 3rd Floor, Cambridge, MA 02142, US
 MANOHARAN, Muthiah, c/o Alnylam Pharmaceuticals, Inc. 300 Third Street, 3rd Floor, Cambridge, MA 02142, US
 MAIER, Martin, c/o Alnylam Pharmaceuticals, Inc. 300 Third Street, 3rd Floor, Cambridge, MA 02142, US
 KUCHIMANCHI, Satyanarayana, c/o Alnylam Pharmaceuticals, Inc. 300 Third Street, 3rd Floor, Cambridge, MA 02142, US
 CHARISSE, Klaus, c/o Alnylam Pharmaceuticals, Inc. 300 Third Street, 3rd Floor, Cambridge, MA 02142, US

(51) MKP
A61K 31/519 2006 (97) EP 3722297
A61P 31/18 2006
A61P 31/20 2006
A61P 35/00 2006
C07D 471/04 2006
 (96) EP 20166675.7 3/2/2016
 (97) EP 3722297, 10/14/2020 202042, en
 (31) 201562128397 P (32) 04.03.2015 (33) US
 201562250403 P 03.11.2015 US
 (54) TOLL-LIKE RECEPTOR MODULATING 4,6-DIAMINO-PYRIDO[3,2-D]PYRIMIDINE COMPOUNDS
 (72) PYUN, Hyung-jung, c/o Gilead Sciences, Inc. 333 Lakeside Drive, Foster City, California 94404, US
 ZABLOCKI, Jeff, c/o Gilead Sciences, Inc. 333 Lakeside Drive, Foster City, California 94404, US
 MACKMAN, Richard L., c/o Gilead Sciences, Inc. 333 Lakeside Drive, Foster City, California 94404, US
 MISH, Michael R., c/o Gilead Sciences, Inc. 333 Lakeside Drive, Foster City, California 94404, US
 AKTOUDIANAKIS, Evangelos, c/o Gilead Sciences, Inc. 333 Lakeside Drive, Foster City, California 94404, US
 CHIN, Gregory, c/o Gilead Sciences, Inc. 333 Lakeside Drive, Foster City, California 94404, US
 METOBO, Samuel, E., c/o Gilead Sciences, Inc. 333 Lakeside Drive, Foster City, California 94404, US

(51) MKP
A01K 67/027 2006 (97) EP 3733701
A61K 39/00 2006
A61K 39/395 2006
A61P 11/06 2006
C07K 14/54 2006
C07K 14/715 2006
C07K 16/24 2006
 (96) EP 20169253.0 3/30/2016
 (97) EP 3733701, 11/4/2020 202045, en
 (31) 201562140913 P (32) 31.03.2015 (33) US
 (54) A NOVEL IL33 FORM, MUTATED FORMS OF IL33, ANTIBODIES, ASSAYS AND METHODS OF USING THE SAME
 (72) COHEN, Emma, S, MedImmune Limited Granta Park, Cambridge, Cambridgeshire CB21 6GH, GB
 LOWE, David, C, MedImmune Limited Granta Park, Cambridge, Cambridgeshire CB21 6GH, GB
 BUTLER, Robin, MedImmune Limited Granta Park, Cambridge, Cambridgeshire CB21 6GH, GB
 SCOTT, Ian, C, MedImmune Limited Granta Park, Cambridge, Cambridgeshire CB21 6GH, GB
 VOUSDEN, Katherine, A, MedImmune Limited Granta Park, Cambridge, Cambridgeshire CB21 6GH, GB
 STRAIN, Martin, D, MedImmune Limited Granta Park, Cambridge, Cambridgeshire CB21 6GH, GB
 CARMEN, Sara, MedImmune Limited Granta Park, Cambridge, Cambridgeshire CB21 6GH, GB
 ENGLAND, Elizabeth, H, MedImmune Limited Granta Park, Cambridge, Cambridgeshire CB21 6GH, GB
 KEMP, Benjamin, P, MedImmune Limited Granta Park, Cambridge, Cambridgeshire CB21 6GH, GB
 REES, David, G, MedImmune Limited Granta Park, Cambridge, Cambridgeshire CB21 6GH, GB
 OVERED-SAYER, Catherine, L, MedImmune Limited Granta Park, Cambridge, Cambridgeshire CB21 6GH, GB
 MUSTELIN, Tomas, M, MedImmune, LLC One MedImmune Way, Gaithersburg, MD 20878, US
 SLEEMAN, Matthew, MedImmune Limited Granta Park, Cambridge, Cambridgeshire CB21 6GH, GB
 HOUSLAY, Kirsty, MedImmune Limited Granta Park, Cambridge, Cambridgeshire CB21 6GH, GB

(51) MKP
A01N 43/50 2006 (97) EP 3733664
A01N 43/54 2006
A01N 43/60 2006
A61P 33/00 2006

C07D 413/10 2006
C07D 413/12 2006
 (96) EP 20169448.6 10/30/2014
 (97) EP 3733664, 11/4/2020 202045, en
 (31) 201361898578 P (32) 01.11.2013 (33) US
 (54) ANTIPARISITIC AND PESTICIDAL ISOXAZOLINE COMPOUNDS
 (72) MENG, Charles, Q., 2291 Chance Lane, Grayson, GA Georgia 30017, US

(51) MKP
A61K 38/00 2006 (97) EP 3712165
C07K 14/47 2006
 (96) EP 20170129.9 6/29/2016
 (97) EP 3712165, 12/2/2020 202049, en
 (31) 201562187507 P (32) 01.07.2015 (33) US
 201511546 01.07.2015 GB
 (54) NOVEL PEPTIDES AND COMBINATION OF PEPTIDES FOR USE IN IMMUNOTHERAPY AGAINST OVARIAN CANCER AND OTHER
 CANCERS
 (72) MAHR, Andrea, Horemer 17, 72067 Tübingen, DE
 WEINSCHENK, Toni, Im Morgenrain 15, 73773 Aichwald, DE
 HÖRZER, Helen, Untere Strasse 20, 72070 Tübingen, DE
 SCHOOR, Oliver, Eichhaldenstrasse 19, 72074 Tübingen, DE
 FRITSCHKE, Jens, Lärchenweg 11, 72144 Dusslingen, DE
 SINGH, Harpreet, 5122 Morningside Dr. Apt. 525, Houston, TX 77005, US

(51) MKP
A61K 39/00 2006 (97) EP 3708185
A61P 35/02 2006
 (96) EP 20170980.5 6/17/2015
 (97) EP 3708185, 11/4/2020 202045, en
 (31) 201462014849 P (32) 20.06.2014 (33) US
 201411037 20.06.2014 GB
 (54) NOVEL IMMUNOTHERAPY AGAINST SEVERAL TUMORS OF THE BLOOD, IN PARTICULAR CHRONIC LYMPHOID LEUKEMIA (CLL)
 (72) STICKEL, Juliane, Quenstedtstrasse 28, 72076 Tübingen, DE
 KOWALEWSKI, Daniel, Denzenbergstrasse 29, 72074 Tübingen, DE
 RAMMENSEE, Hans-Georg, Sommerhalde 3, 72070 Tübingen, DE
 STEVANOVIC, Stefan, Auf der Burg 3, 72074 Tübingen, DE

(51) MKP
A61K 35/39 2015 (97) EP 3747450
A61K 35/74 2015
A61K 38/46 2006
 (96) EP 20171785.7 11/25/2015
 (97) EP 3747450, 12/9/2020 202050, en
 (31) 201462084537 P (32) 25.11.2014 (33) US
 201462084536 P 25.11.2014 US
 201462084540 P 25.11.2014 US
 201562117637 P 18.02.2015 US
 201562117639 P 18.02.2015 US
 201562117632 P 18.02.2015 US
 201562162562 P 15.05.2015 US
 201562257714 P 19.11.2015 US
 (54) PHARMACEUTICAL COMPOSITION CONSISTING OF BLAUTIA, FOR ORAL ADMINISTRATION
 (72) Rahman, Shaila, 409 Walden St, Cambridge, MA 02138-1349, US
 Berry, David, 155 Beethoven Avenue, Waban, MA Massachusetts 02468, US
 Afeyan, Noubar B., 1 Sunset Ridge, Lexington, MA Massachusetts 02421, US
 Kaplan, Johanne, 123 Mill Street, Sherborn, MA Massachusetts 01770, US

(51) MKP
A61K 38/04 2006 (97) EP 3715357
A61K 39/00 2006
A61P 35/00 2006
C07K 7/08 2006
 (96) EP 20172206.3 12/16/2015

(97) EP 3715357, 9/30/2020 202040, en
 (31) 201423016 (32) 23.12.2014 (33) GB
 201462096165 P 23.12.2014 US
 201501017 21.01.2015 GB
 (54) NOVEL PEPTIDES AND COMBINATION OF PEPTIDES FOR USE IN IMMUNOTHERAPY AGAINST HEPATOCELLULAR CARCINOMA (HCC) AND OTHER CANCERS
 (72) WEINSCHENK, Toni, Im Morgenrain 15, 73773 Aichwald, DE
 MAHR, Andrea, Horemer 17, 72076 Tübingen, DE
 FRITSCHKE, Jens, Lärchenweg 11, 72144 Dusslingen, DE
 MÜLLER, Phillip, Obere Karlsstrasse 14, 34117 Kassel, DE
 WIEBE, Anita, Quellenstraße 49, 72124 Ruebgarten, DE
 MISSEL, Sarah, Französische Allee 13, 72072 Tübingen, DE

(51) MKP
C12Q 1/6886 2018 (97) EP 3744861
 (96) EP 20172435.8 3/9/2018
 (97) EP 3744861, 12/2/2020 202049, en
 (31) 17160346 (32) 10.03.2017 (33) EP
 (54) A METHYLATION CLASSIFIER FOR DETECTION OF HPV-INDUCED INVASIVE CANCERS, NONHPV- INDUCED GYNAECOLOGICAL AND ANOGENITAL CANCERS AND THEIR HIGH-GRADE PRECURSOR LESIONS
 (72) MEIJER, Christophorus Joannes Lambertus Maria, c/o Biothof 15 1, 1098 RX Amsterdam, NL
 STEENBERGEN, Renske Daniëla Maria, c/o Biothof 15 1, 1098 RX Amsterdam, NL
 SNIJDERS, Petrus Josephus Ferdinandus, -, deceased, NL
 HEIDEMAN, Daniëlle Anne Marie, c/o Biothof 15 1, 1098 RX Amsterdam, NL

(51) MKP
A01N 51/00 2006 (97) EP 3753927
A61P 25/00 2006
C07D 231/14 2006
C07D 295/033 2006
 (96) EP 20172589.2 10/16/2015
 (97) EP 3753927, 12/23/2020 202052, en
 (31) 201462064957 P (32) 16.10.2014 (33) US
 (54) COMPOSITIONS AND METHODS FOR TREATING CNS DISORDERS
 (72) MARTINEZ BOTELLA, Gabriel, 17 Parmenter Road, Wayland, MA 01778, US
 SALITURO, Francesco G., 25 Baker Drive, Marlborough, MA 01752, US
 ROBICHAUD, Albert Jean, 2 Earhart Street 915, Cambridge, MA 02141, US
 HARRISON, Boyd L., 9 Wheatston Court, Princeton Junction, NJ 08550, US

(51) MKP
C12N 15/85 2006 (97) EP 3722433
 (96) EP 20173389.6 10/14/2015
 (97) EP 3722433, 10/14/2020 202042, en
 (31) 201462064335 P (32) 15.10.2014 (33) US
 (54) PROMOTER AND REGULATORY ELEMENTS FOR IMPROVED EXPRESSION OF HETEROLOGOUS GENES IN HOST CELLS
 (72) DARIS, Mark, 1210 Rotella Street, Newbury Park, CA 91320, US
 STEVENS, Jennitte LeAnn, 126 Siesta Avenue, Thousand Oaks, CA 91360, US
 LI, Chi-Ming Kevin, 3001 Avenida de los Arboles, Thousand Oaks, CA 91362, US
 GE, Huanying, 104 Dumbledore Court, Cary, NC 27519, US

(51) MKP
A61K 39/00 2006 (97) EP 3725327
A61P 35/00 2006
C07K 14/47 2006
G01N 33/50 2006
 (96) EP 20175071.8 4/10/2018
 (97) EP 3725327, 10/21/2020 202043, en
 (31) 102017107697 (32) 10.04.2017 (33) DE
 201762483702 P 10.04.2017 US
 (54) PEPTIDES AND COMBINATION THEREOF FOR USE IN THE IMMUNOTHERAPY AGAINST CANCERS
 (72) DI MARCO, Moreno, Memmingerstrasse 18/1, 72072 Tübingen, DE
 HAEN, Sebastian, Brombergstrasse 15, 72070 Tübingen, DE

KOWALEWSKI, Daniel, Peter-Imhoff-Straße 1, 72138 Kirchentellinsfurt, DE
 LÖFFLER, Markus, Sandgrabenstrasse 20, 72119 Ammerbuch, DE
 NELDE, Annika, Hagellochter Weg 17, 42070 Tuebingen, DE
 RAMMENSEE, Hans-Georg, Sommerhalde 3, 72070 Unterjesingen, DE
 STEVANOVIĆ, Stefan, Auf der Burg 3, 72074 Tübingen, DE
 TRAUTWEIN, Nico, Pelargusstrasse 2, 70180 Stuttgart, DE
 WALZ, Juliane Sarah, Gartenstrasse 71, 72076 Tübingen, DE

- (51) MKP
A61K 39/00 2006 (97) EP 3736283
C07K 14/47 2006
C07K 14/635 2006
- (96) EP 20175260.7 7/5/2016
 (97) EP 3736283, 11/11/2020 202046, en
- (31) 201511792 (32) 06.07.2015 (33) GB
 201562188870 P 06.07.2015 US
- (54) NOVEL PEPTIDES AND COMBINATION OF PEPTIDES FOR USE IN IMMUNOTHERAPY AGAINST ESOPHAGEAL CANCER AND OTHER CANCERS
- (72) MAHR, Andrea, Kirschenweg 22, 72076 Tübingen, DE
 WEINSCHENK, Toni, Im Morgenrain 15, 73773 Aichwald, DE
 SONG, Colette, Willi-Baumeister-Weg 21, 73760 Ostfildern, DE
 SCHOOR, Oliver, Eichhaldenstrasse 19, 72074 Tübingen, DE
 FRITSCHE, Jens, Lärchenweg 11, 72144 Dusslingen, DE
 SINGH, Harpreet, 5122 Morningside Dr. Apt. 525, Houston, TX 77005, US

- (51) MKP
A61K 31/415 2006 (97) EP 3722281
A61P 29/00 2006
C07D 231/18 2006
- (96) EP 20176198.8 4/23/2019
 (97) EP 3722281, 10/14/2020 202042, en
- (31) 201806578 (32) 23.04.2018 (33) GB
- (54) A SODIUM SALT OF N-((1,2,3,5,6,7-HEXAHYDRO-S-INDACEN-4-YL)CARBAMOYL)-1-ISOPROPYL-1H-PYRAZOLE-3-SULFONAMIDE
- (72) MILLER, David, c/o Inflazome UK Limited D6 Grain House Mill Court Great Shelford, Cambridge, Cambridgeshire CB22 5LD, GB
 MACLEOD, Angus, c/o Inflazome UK Limited D6 Grain House Mill Court Great Shelford, Cambridge, Cambridgeshire CB22 5LD, GB
 DEL RIO GANCEDO, Susana, c/o Johnson Matthey Pharmorphix® Solid State Services 250 Cambridge Science Park Milton Road, Cambridge, Cambridgeshire CB4 0WE, GB
 STRATFORD, Samuel Alexander, c/o Johnson Matthey Pharmorphix® Solid State Services 250 Cambridge Science Park Milton Road, Cambridge, Cambridgeshire CB4 0WE, GB

- (51) MKP
A61K 38/48 2006 (97) EP 3744840
A61P 7/02 2006
A61P 7/04 2006
A61P 43/00 2006
C07K 14/46 2006
C12N 9/64 2006
- (96) EP 20177786.9 5/26/2015
 (97) EP 3744840, 12/2/2020 202049, en
- (31) 14169895 (32) 26.05.2014 (33) EP
- (54) PROHEMOSTATIC PROTEINS FOR THE TREATMENT OF BLEEDING
- (72) VERHOEF, Daniël, c/o Einthoven Laboratory of Experimental, Vascular Medicine, Department of Thrombosis and Hemostasis LUMC, Albinusdreef 2, 2333 ZA Leiden, NL
 REITSMA, Pieter H., c/o Einthoven Laboratory of Experimental, Vascular Medicine, Department of Thrombosis and Hemostasis LUMC, Albinusdreef 2, 2333 ZA Leiden, NL
 BOS, Mettine H.A., c/o Einthoven Laboratory of Experimental, Vascular Medicine, Department of Thrombosis and Hemostasis LUMC, Albinusdreef 2, 2333 ZA Leiden, NL

- (51) MKP
A61K 38/05 2006 (97) EP 3753567
A61P 1/04 2006
A61P 3/10 2006
A61P 5/14 2006

A61P 5/38 2006
A61P 7/00 2006
A61P 7/06 2006
A61P 9/00 2006
A61P 9/10 2006
A61P 11/00 2006
A61P 13/12 2006
A61P 15/00 2006
A61P 17/00 2006
A61P 17/06 2006
A61P 17/14 2006
A61P 19/00 2006
A61P 19/02 2006
A61P 21/02 2006
A61P 21/04 2006
C07K 14/78 2006
C07K 16/28 2006

(96) EP 20177799.2 10/10/2012

(97) EP 3753567, 12/23/2020 202052, en

(31) 201161546028 P (32) 11.10.2011 (33) US

(54) CD40L-SPECIFIC TN3-DERIVED SCAFFOLDS AND METHODS OF USE THEREOF

(71) Viela Bio, Inc., One MedImmune Way, Gaithersburg, MD 20878, US

(72) Coyle, Anthony, 12 Union Park, Boston, MA 02118, US

Baca, Manuel, c/o MedImmune LLC One MedImmune Way, Gaithersburg, MD 20878, US

Thisted, Thomas, c/o MedImmune LLC One MedImmune Way, Gaithersburg, MD 20878, US

Drabic, Stacey, c/o MedImmune LLC One MedImmune Way, Gaithersburg, MD 20878, US

Grinberg, Luba, c/o MedImmune LLC One MedImmune Way, Gaithersburg, MD 20878, US

Novarra, Shabazz, c/o MedImmune LLC One MedImmune Way, Gaithersburg, MD 20878, US

Oganesyan, Vaheh, c/o MedImmune LLC One MedImmune Way, Gaithersburg, MD 20878, US

Herbst, Ronald, c/o MedImmune LLC One MedImmune Way, Gaithersburg, MD 20878, US

Spencer, David Kenneth, c/o MedImmune LLC One MedImmune Way, Gaithersburg, MD 20878, US

(51) MKP

A61K 9/16 2006 (97) EP 3725778

A61K 31/4164 2006

A61K 31/4166 2006

A61P 13/08 2006

A61P 15/00 2006

A61P 15/08 2006

A61P 15/14 2006

A61P 35/00 2006

A61P 43/00 2006

C07D 233/86 2006

(96) EP 20177837.0 9/11/2013

(97) EP 3725778, 10/21/2020 202043, en

(31) 201261699351 P (32) 11.09.2012 (33) US

(54) FORMULATIONS OF ENZALUTAMIDE

(71) Medivation Prostate Therapeutics LLC, 525 Market Street 36th Floor, San Francisco, CA 94105, US

(72) LORENZ, Douglas Alan, c/o Bend Research 64550 Research Road, Bend, OR 97701, US

KONAGURTHU, Sanjay, c/o Bend Research 64550 Research Road, Bend, OR 97701, US

WALD, Randy J., c/o Bend Research 64550 Research Road, Bend, OR 97701, US

EVERETT, Jason A., c/o Bend Research 64550 Research Road, Bend, OR 97701, US

MATZ, Sheila, c/o Medivation Prostate Therapeutics LLC 525 Market Street 36th Floor, San Francisco, CA 94105, US

TAKAISHI, Yuuki, c/o Astellas Pharma Inc. 3-11 Nihonbashi-Honcho 2-chome, Chuo-Ku, Tokyo 103-8411, JP

SAKAI, Toshiro, c/o Astellas Pharma Inc. 3-11 Nihonbashi-Honcho 2-chome, Chuo-Ku, Tokyo 103-8411, JP

IRIE, Ryosuke, c/o Astellas Pharma Inc. 3-11 Nihonbashi-Honcho 2-chome, Chuo-Ku, Tokyo 103-8411, JP

OBA, Shinsuke, c/o Astellas Pharma Inc. 3-11 Nihonbashi-Honcho 2-chome, Chuo-Ku, Tokyo 103-8411, JP

TOYOTA, Hiroyasu, c/o Astellas Pharma Inc. 3-11 Nihonbashi-Honcho 2-chome, Chuo-Ku, Tokyo 103-8411, JP

NISHIMURA, Koji, c/o Astellas Pharma Inc. 3-11 Nihonbashi-Honcho 2-chome, Chuo-Ku, Tokyo 103-8411, JP

KANBAYASHI, Atsushi, c/o Astellas Pharma Inc. 3-11 Nihonbashi-Honcho 2-chome, Chuo-Ku, Tokyo 103-8411, JP

(51) MKP

C12C 1/02 2006 (97) EP 3736321

C12C 1/027 2006

	C12C 1/047 2006					
	C12C 7/047 2006					
(96)	EP 20178256.2	6/23/2017				
(97)	EP 3736321, 11/11/2020	202046, en				
(31)	16177402		(32)	01.07.2016	(33)	EP
(54)	REFINED CEREAL-BASED BEVERAGES					
(71)	Carlsberg Breweries A/S, J.C. Jacobsens Gade 1, 1799 Copenhagen V, DK					
(72)	Skadhauge, Birgitte, Lindehøjvej 31B, 3460 Birkerød, DK Lok, Finn, Kongshaven 15, 2500 Valby, DK Knudsen, Søren, Bakkesvinget 18, 2760 Måløv, DK Wendt, Toni, Sankt Nikolaj Vej 30 st. tv., 1953 Frederiksberg, DK Krucewicz, Katarzyna, Søborghus Park 2, 1.th., 2860 Søborg, DK Marri, Lucia, Peter Bangs Vej 141, 3. th., 2000 Frederiksberg, DK Olsen, Ole, Holmbladsgade 102, 2.tv., 2300, DK					
(51)	MKP					
	A01K 7/06 2006		(97) EP 3747265			
	A01M 25/00 2006					
(96)	EP 20178258.8	6/4/2020				
(97)	EP 3747265, 12/9/2020	202050, en				
(31)	201930514		(32)	06.06.2019	(33)	ES
(54)	LIQUID SELF-DISPENSING DEVICE FOR SMALL ANIMALS					
(71)	Laboratorios Agrochem, S.L., Tres Rieres, 10. P.I.SUR, 08292 Esparraguera, ES					
(72)	LOPEZ AZNAR, Xavier, LABORATORIOS AGROCHEM, S.L. Tres Rieres, 10. P.I.SUR, 08292 ESPARRAGUERA, ES					
(51)	MKP					
	A61K 31/45 2006		(97) EP 3725785			
	A61P 11/02 2006					
	A61P 31/16 2006					
	C07D 401/06 2006					
(96)	EP 20178488.1	4/10/2014				
(97)	EP 3725785, 10/21/2020	202043, en				
(31)	2013116826		(32)	12.04.2013	(33)	RU
(54)	GLUTARIMIDE DERIVATIVES, USE THEREOF, PHARMACEUTICAL COMPOSITION BASED THEREON AND METHODS FOR PRODUCING GLUTARIMIDE DERIVATIVES					
(72)	Nebolsin, Vladimir Evgenievich, ul. Golitsynskaya, 457 Borzye Istrinsky r-n, 143581 Moskovskaya obl., RU Kromova, Tatyana Alexandrovna, ul. Bilibina 17-60, 248010 Kaluga, RU					
(51)	MKP					
	A61K 31/45 2006		(97) EP 3722290			
	A61P 11/02 2006					
	A61P 31/16 2006					
	C07D 401/06 2006					
(96)	EP 20178489.9	4/10/2014				
(97)	EP 3722290, 10/14/2020	202042, en				
(31)	2013116826		(32)	12.04.2013	(33)	RU
(54)	GLUTARIMIDE DERIVATIVES, USE THEREOF, PHARMACEUTICAL COMPOSITION BASED THEREON AND METHODS FOR PRODUCING GLUTARIMIDE DERIVATIVES					
(72)	Nebolsin, Vladimir Evgenievich, ul. Golitsynskaya, 457 Borzye Istrinsky r-n, 143581 Moskovskaya obl., RU Kromova, Tatyana Alexandrovna, ul. Bilibina 17-60, 248010 Kaluga, RU					
(51)	MKP					
	A61K 38/48 2006		(97) EP 3753570			
	A61K 39/00 2006					
	A61P 35/00 2006					
	C07K 7/06 2006					
	C07K 7/08 2006					
	G01N 33/50 2006					
(96)	EP 20179380.9	3/15/2011				
(97)	EP 3753570, 12/23/2020	202052, en				
(31)	31570410 P		(32)	19.03.2010	(33)	US
	201004551			19.03.2010		GB
(54)	NOVEL IMMUNOTHERAPY AGAINST SEVERAL TUMORS INCLUDING GASTROINTESTINAL AND GASTRIC CANCER					

(72) WEINSCHENK, Toni, Im Morgenrain 15, 73773 Aichwald, DE
 FRITSCHKE, Jens, Lärchenweg 11, 72144 Dusslingen, DE
 WALTER, Steffen, 2901 Wroxtton Road, Houston, TX Texas 77005, US
 LEWANDROWSKI, Peter, Grabenstrasse 11, 72070 Tübingen-Hirschau, DE
 SINGH, Harpreet, 5122 Morningside Dr, Apt. 525, Houston, TX Texas 77005, US

(51) MKP
A61K 39/00 2006 (97) EP 3760225
A61P 35/00 2006
C07K 14/47 2006
C07K 16/00 2006

(96) EP 20179381.7 4/22/2016

(97) EP 3760225, 1/6/2021 202101, en

(31) 201507030 (32) 24.04.2015 (33) GB
 201562152258 P 24.04.2015 US

(54) NOVEL PEPTIDES AND COMBINATION OF PEPTIDES FOR USE IN IMMUNOTHERAPY AGAINST LUNG CANCER, INCLUDING NSCLC AND OTHER CANCERS

(72) MAHR, Andrea, Horemer 17, 72076 Tübingen, DE
 WEINSCHENK, Toni, Im Morgenrain 15, 73773 Aichwald, DE
 SCHOOR, Oliver, Eichhaldenstrasse 19, 72074 Tübingen, DE
 FRITSCHKE, Jens, Lärchenweg 11, 72144 Dusslingen, DE
 SINGH, Harpreet, 5122 Morningside Dr. Apt. 525, Houston, TX 77005, US
 WAGNER, Claudia, Nürtinger Strasse 32, 72074 Tübingen, DE
 LEIBOLD, Julia, Wiesenweg 1, 6336 Langkampfen, AT
 SONG, Colette, Willi-Baumeister-Weg 21, 73760 Ostfildern, DE

(51) MKP
A61K 39/00 2006 (97) EP 3750557
A61P 35/00 2006
C07K 14/47 2006

(96) EP 20179382.5 4/22/2016

(97) EP 3750557, 12/16/2020 202051, en

(31) 201507030 (32) 24.04.2015 (33) GB
 201562152258 P 24.04.2015 US

(54) NOVEL PEPTIDES AND COMBINATION OF PEPTIDES FOR USE IN IMMUNOTHERAPY AGAINST LUNG CANCER, INCLUDING NSCLC AND OTHER CANCERS

(72) MAHR, Andrea, Horemer 17, 72076 Tübingen, DE
 WEINSCHENK, Toni, Im Morgenrain 15, 73773 Aichwald, DE
 SCHOOR, Oliver, Eichhaldenstrasse 19, 72074 Tübingen, DE
 FRITSCHKE, Jens, Lärchenweg 11, 72144 Dusslingen, DE
 SINGH, Harpreet, 5122 Morningside Dr. Apt. 525, Houston, TX 77005, US
 WAGNER, Claudia, Nürtinger Strasse 32, 72074 Tübingen, DE
 LEIBOLD, Julia, Wiesenweg 1, 6336 Langkampfen, AT
 SONG, Colette, Willi-Baumeister-Weg 21, 73760 Ostfildern, DE

(51) MKP
A61K 39/00 2006 (97) EP 3750558
A61P 35/00 2006
C07K 14/47 2006

(96) EP 20179383.3 4/22/2016

(97) EP 3750558, 12/16/2020 202051, en

(31) 201507030 (32) 24.04.2015 (33) GB
 201562152258 P 24.04.2015 US

(54) NOVEL PEPTIDES AND COMBINATION OF PEPTIDES FOR USE IN IMMUNOTHERAPY AGAINST LUNG CANCER, INCLUDING NSCLC AND OTHER CANCERS

(72) MAHR, Andrea, Horemer 17, 72076 Tübingen, DE
 WEINSCHENK, Toni, Im Morgenrain 15, 73773 Aichwald, DE
 SCHOOR, Oliver, Eichhaldenstrasse 19, 72074 Tübingen, DE
 FRITSCHKE, Jens, Lärchenweg 11, 72144 Dusslingen, DE
 SINGH, Harpreet, 5122 Morningside Dr. Apt. 525, Houston, TX 77005, US
 WAGNER, Claudia, Nürtinger Strasse 32, 72074 Tübingen, DE
 LEIBOLD, Julia, Wiesenweg 1, 6336 Langkampfen, AT
 SONG, Colette, Willi-Baumeister-Weg 21, 73760 Ostfildern, DE

- (51) MKP
A61K 39/00 2006 (97) EP 3750559
A61P 35/00 2006
C07K 14/47 2006
- (96) EP 20179384.1 4/22/2016
(97) EP 3750559, 12/16/2020 202051, en
- (31) 201507030 (32) 24.04.2015 (33) GB
201562152258 P 24.04.2015 US
- (54) NOVEL PEPTIDES AND COMBINATION OF PEPTIDES FOR USE IN IMMUNOTHERAPY AGAINST LUNG CANCER, INCLUDING NSCLC AND OTHER CANCERS
- (72) MAHR, Andrea, Horemer 17, 72076 Tübingen, DE
WEINSCHENK, Toni, Im Morgenrain 15, 73773 Aichwald, DE
SCHOOR, Oliver, Eichhaldenstrasse 19, 72074 Tübingen, DE
FRITSCHKE, Jens, Lärchenweg 11, 72144 Dusslingen, DE
SINGH, Harpreet, 5122 Morningside Dr. Apt. 525, Houston, TX 77005, US
WAGNER, Claudia, Nürtinger Strasse 32, 72074 Tübingen, DE
LEIBOLD, Julia, Wiesenweg 1, 6336 Langkampfen, AT
SONG, Colette, Willi-Baumeister-Weg 21, 73760 Ostfildern, DE
-

- (51) MKP
A61K 38/17 2006 (97) EP 3738606
A61K 38/39 2006
A61K 39/00 2006
A61P 35/00 2006
C07K 7/06 2006
C07K 7/08 2006
G01N 33/50 2006
- (96) EP 20179386.6 3/15/2011
(97) EP 3738606, 11/18/2020 202047, en
- (31) 31570410 P (32) 19.03.2010 (33) US
201004551 19.03.2010 GB
- (54) NOVEL IMMUNOTHERAPY AGAINST SEVERAL TUMORS INCLUDING GASTROINTESTINAL AND GASTRIC CANCER
- (72) WEINSCHENK, Toni, Im Morgenrain 15, 73773 Aichwald, DE
FRITSCHKE, Jens, Lärchenweg 11, 72144 Dusslingen, DE
WALTER, Steffen, 2901 Wroxtton Road, Houston, TX Texas 77005, US
LEWANDROWSKI, Peter, Grabenstrasse 11, 72070 Tübingen-Hirschau, DE
SINGH, Harpreet, 5122 Morningside Dr, Apt. 525, Houston, TX Texas 77005, US
-

- (51) MKP
A61B 17/00 2006 (97) EP 3738531
A61B 17/32 2006
A61B 17/3207 2006
- (96) EP 20182946.2 2/9/2011
(97) EP 3738531, 11/18/2020 202047, en
- (31) 70386010 (32) 11.02.2010 (33) US
- (54) ULTRASONICALLY POWERED SURGICAL INSTRUMENTS WITH ROTATING CUTTING IMPLEMENT
- (71) Ethicon LLC, 475 Street C, Suite 401 Los Frailes Industrial Park, 00969 Guaynabo, PR
(72) ROBERTSON, Galen C., 5752 Doerger Lane, Cincinnati, OH Ohio 45212, US
TIMM, Richard W., 3405 Monteith Avenue 1, Cincinnati, OH Ohio 45208, US
MUMAW, Daniel J., 953 Long Lane, Milford, OH Ohio 45150, US
STULEN, Foster B., 6245 Bridgewater Court, Mason, OH Ohio 45040, US
JOHNSON, Gregory W., 907 Center Street, Milford, OH Ohio 45150, US
MORGAN, Jerome R., 3275 S. Whitetree Circle, Cincinnati, OH Ohio 45236, US
HOUSER, Kevin L., 570 Foliage Lane, Springboro, OH Ohio 45066, US
NEUROHR, Mark A., 658 Nelson Place, Newport, KY Kentucky 41071, US
MALAVIYA, Prasanna, 5860 Maxfli Lane, Mason, OH Ohio 45040, US
FORTSON, Reginald D., 3404 Walworth Avenue, Cincinnati, OH Ohio 45226, US
CONLON, Sean P., 6234 North Shadow Hill Way Apt. C, Loveland, OH Ohio 45140, US
DANNAHER, William D., 8907 Eldora Drive, Cincinnati, OH Ohio 45236, US
WIENER, Eitan T., 9519 Croton Drive, Cincinnati, OH Ohio 45242, US
BODIN, Kristi M., 7449 Kilkeny Drive, West Chester, OH Ohio 45069, US
JOACHIM, William S. Jr., 7398 Airy View Drive, Liberty Township, OH Ohio 45044, US
-

- (51) MKP

- A61K 31/4709 2006 (97) EP 3736270**
A61P 11/00 2006
C07C 311/45 2006
C07D 213/64 2006
C07D 213/71 2006
C07D 215/36 2006
C07D 231/56 2006
C07D 235/28 2006
C07D 401/12 2006
C07D 471/04 2006
- (96) EP 20183402.5 9/13/2018
(97) EP 3736270, 11/11/2020 202046, en
- (31) 201762558430 P (32) 14.09.2017 (33) US
201762608846 P 21.12.2017 US
- (54) MODULATORS OF THE CYSTIC FIBROSIS TRANSMEMBRANE CONDUCTANCE REGULATOR PROTEIN AND METHODS OF USE
(72) ALTENBACH, Robert J, 7405 North Oketo Avenue, Chicago, IL 60631, US
BOGDAN, Andrew, 2526 Jackson Avenue, No. 25 Evanston, Evanston, IL 60201, US
COUTY, Sylvain, Galapagos SASU 102 Avenue Gaston Roussel, 93230 Romainville, FR
DESROY, Nicolas, Galapagos SASU 102 Avenue Gaston Roussel, 93230 Romainville, FR
GFESSER, Gregory A., 110 Timber Lane, Lindenhurst, IL 60046, US
HOUSSEMAN, Christopher Gaëtan, Galapagos SASU 102 Avenue Gaston Roussel, 93230 Romainville, FR
KYM, Philip R., 1002 Gracewood Avenue, Libertyville, IL 60048, US
LIU, Bo, 4529 West Tucker Lane, Waukegan, IL 60085, US
MAI, Thi Thu Trang, Galapagos SASU 102 Avenue Gaston Roussel, 93230 Romainville, FR
MALAGU, Karine Fabienne, Charles Laboratories Chesterford Research Park, Saffron Walden, Cambridgeshire CB10 1XL, GB
MERAYO MERAYO, Nuria, Galapagos SASU 102 Avenue Gaston Roussel, 93230 Romainville, FR
PICOLET, Olivier Laurent, Galapagos SASU 102 Avenue Gaston Roussel, 93230 Romainville, FR
PIZZONERO, Mathieu Rafaël, Galapagos SASU 102 Avenue Gaston Roussel, 93230 Romainville, FR
SEARLE, Xenia B., 38 North Alleghany Road, Grayslake, IL 60030, US
VAN DER PLAS, Steven Emiel, Galapagos NV Generaal de Wittelaan L11 A3, 2800 Mechelen, BE
WANG, Xueqing, Pharmacyclics LLC 955 East Arques Avenue, Sunnysvale, IL 94085, US
YEUNG, Ming C., 34422 North Tanager Drive, Grayslake, IL 60030, US
-

- (51) MKP
A61K 31/4709 2006 (97) EP 3736267
A61P 11/00 2006
C07C 311/45 2006
C07D 213/64 2006
C07D 213/71 2006
C07D 215/36 2006
C07D 231/56 2006
C07D 235/28 2006
C07D 401/12 2006
C07D 471/04 2006
- (96) EP 20183405.8 9/13/2018
(97) EP 3736267, 11/11/2020 202046, en
- (31) 201762558430 P (32) 14.09.2017 (33) US
201762608846 P 21.12.2017 US
- (54) MODULATORS OF THE CYSTIC FIBROSIS TRANSMEMBRANE CONDUCTANCE REGULATOR PROTEIN AND METHODS OF USE
(72) ALTENBACH, Robert J, 7405 North Oketo Avenue, Chicago, IL 60631, US
BOGDAN, Andrew, 2526 Jackson Avenue, No. 25 Evanston, Evanston, IL 60201, US
COUTY, Sylvain, Galapagos SASU 102 Avenue Gaston Roussel, 93230 Romainville, FR
DESROY, Nicolas, Galapagos SASU 102 Avenue Gaston Roussel, 93230 Romainville, FR
GFESSER, Gregory A., 110 Timber Lane, Lindenhurst, IL 60046, US
HOUSSEMAN, Christopher Gaëtan, Galapagos SASU 102 Avenue Gaston Roussel, 93230 Romainville, FR
KYM, Philip R., 1002 Gracewood Avenue, Libertyville, IL 60048, US
LIU, Bo, 4529 West Tucker Lane, Waukegan, IL 60085, US
MAI, Thi Thu Trang, Galapagos SASU 102 Avenue Gaston Roussel, 93230 Romainville, FR
MALAGU, Karine Fabienne, Charles Laboratories Chesterford Research Park, Saffron Walden, Cambridgeshire CB10 1XL, GB
MERAYO MERAYO, Nuria, Galapagos SASU 102 Avenue Gaston Roussel, 93230 Romainville, FR
PICOLET, Olivier Laurent, Galapagos SASU 102 Avenue Gaston Roussel, 93230 Romainville, FR
PIZZONERO, Mathieu Rafaël, Galapagos SASU 102 Avenue Gaston Roussel, 93230 Romainville, FR
SEARLE, Xenia B., 38 North Alleghany Road, Grayslake, IL 60030, US
VAN DER PLAS, Steven Emiel, Galapagos NV Generaal de Wittelaan L11 A3, 2800 Mechelen, BE
WANG, Xueqing, Pharmacyclics LLC 955 East Arques Avenue, Sunnysvale, IL 94085, US
YEUNG, Ming C., 34422 North Tanager Drive, Grayslake, IL 60030, US

(51) MKP
C07K 14/705 2006 (97) EP 3747898
(96) EP 20183978.4 2/22/2013
(97) EP 3747898, 12/9/2020 202050, en
(31) 201261601910 P (32) 22.02.2012 (33) US
(54) USE OF ICOS-BASED CARS TO ENHANCE ANTITUMOR ACTIVITY AND CAR PERSISTENCE
(72) JUNE, Carl, H., 409 Baird Road, Merion Station, PA 19066, US
GUEDAN CARRIO, Sonia, 4515 Kingsessing Avenue, Suite 1, Philadelphia, PA 19143, US
ZHAO, Yangbing, 6 Gladiola Lane, Lumberton, NJ 08048, US
SCHOLLER, John, 410 Gilpin Road, Narberth, PA 19072, US

(51) MKP
A61K 31/437 2006 (97) EP 3757104
A61P 35/00 2006
C07D 471/04 2006
(96) EP 20186809.8 5/5/2016
(97) EP 3757104, 12/30/2020 202053, en
(31) 201562157902 P (32) 06.05.2015 (33) US
(54) SOLID FORMS OF A COMPOUND MODULATING KINASES
(72) IBRAHIM, Prabha N., c/o Plexxikon Inc. 91 Boliver Drive, Suite A, Berkeley, CA 94710, US
VISOR, Gary Conrad, c/o Plexxikon Inc. 91 Bolivar Drive, Suite A, Berkeley, CA 94710, US

(51) MKP
A61K 31/519 2006 (97) EP 3757126
A61K 39/395 2006
C07K 16/24 2006
(96) EP 20187001.1 11/4/2011
(97) EP 3757126, 12/30/2020 202053, en
(31) 41053310 P (32) 05.11.2010 (33) US
(54) METHODS OF TREATING PSORIATIC ARTHRITIS USING IL-17 ANTAGONISTS
(72) MPOFU, Shepard, Novartis Pharma AG Postfach, 4002 Basel, CH
RICHARDS, Hanno, Novartis Pharma AG Postfach, 4002 Basel, CH
THANGAVELU, Karthinathan, Novartis Pharma AG Postfach, 4002 Basel, CH
MACHACEK, Matthias, Novartis Pharma AG Postfach, 4002 Basel, CH

(51) MKP
A61K 31/223 2006 (97) EP 3750534
A61K 31/573 2006
(96) EP 20187064.9 12/1/2016
(97) EP 3750534, 12/16/2020 202051, en
(31) 201521217 (32) 01.12.2015 (33) GB
(54) MELFLUFEN DOSAGE REGIMENS FOR CANCER
(72) LINDBERG, Jakob, c/o Oncopeptides AB Västra Trädgårdsgatan 15, 111 53 Stockholm, SE

(51) MKP
A61K 31/56 2006 (97) EP 3750910
A61K 31/58 2006
A61P 31/18 2006
C07C 309/65 2006
C07F 5/02 2006
C07J 63/00 2006
(96) EP 20187878.2 4/9/2015
(97) EP 3750910, 12/16/2020 202051, en
(31) 201461978306 P (32) 11.04.2014 (33) US
(54) TRITERPENOIDS WITH HIV MATURATION INHIBITORY ACTIVITY
(72) SIT, Sing-Yuen, c/o Bristol-Myers Squibb Company 5 Research Parkway, Wallingford, CT Connecticut 06492, US
CHEN, Yan, c/o Bristol-Myers Squibb Company 5 Research Parkway, Wallingford, CT Connecticut 06492, US
CHEN, Jie, c/o Bristol-Myers Squibb Company 5 Research Parkway, Wallingford, ct Connecticut 06492, US
SWIDORSKI, Jacob, c/o Bristol-Myers Squibb Company 5 Research Parkway, Wallingford, CT Connecticut 06492, US
VENABLES, Brian Lee, c/o Bristol-Myers Squibb Company 5 Research Parkway, Wallingford, CT Connecticut 06492, US
SIN, Ny, c/o Bristol-Myers Squibb Company 5 Research Parkway, Wallingford, CT Connecticut 06492, US

MEANWELL, Nicholas A., c/o Bristol-Myers Squibb Company 5 Research Parkway, Wallingford, CT Connecticut 06492, US
 REGUEIRO-REN, Alicia, c/o Bristol-Myers Squibb Company 5 Research Parkway, Wallingford, CT Connecticut 06492, US
 HARTZ, Richard A., c/o Bristol-Myers Squibb Company 5 Research Parkway, Wallingford, CT Connecticut 06492, US
 XU, Li, c/o Bristol-Myers Squibb Company 5 Research Parkway, Wallingford, CT Connecticut 06492, US
 LIU, Zheng, c/o Bristol-Myers Squibb Company 5 Research Parkway, Wallingford, CT Connecticut 06492, US

- (51) MKP
A61K 9/00 2006 (97) EP 3757112
A61K 9/08 2006
A61K 31/7068 2006
A61K 47/16 2006
A61K 47/20 2006
A61K 47/22 2006
A61P 35/00 2006
C07H 19/10 2006
- (96) EP 20187951.7 6/25/2015
 (97) EP 3757112, 12/30/2020 202053, en
- (31) 201411253 (32) 25.06.2014 (33) GB
 2050MU2014 25.06.2014 IN
- (54) GEMCITABINE PRODRUGS
 (72) GRIFFITH, Hugh, NuCana plc 3 Lochside Way, Edinburgh, Scotland EH12 9DT, GB
 MCGUIGAN, Christopher, -, deceased, GB
 SLUSARCZYK, Magdalena, School of Pharmacy and Pharmaceutical Sciences, Cardiff University Redwood Building King Edward VII Avenue, Cardiff, South Glamorgan CF10 3NB, GB
 SERPI, Michaela, School of Pharmacy and Pharmaceutical Sciences, Cardiff University Redwood Building King Edward VII Avenue, Cardiff, South Glamorgan CF10 3NB, GB
 FERRARI, Valentina, 83 West Cliff Road, Ramsgate, Kent CT11 9NS, GB

- (51) MKP
A61K 31/232 2006 (97) EP 3750535
A61K 31/366 2006
A61K 31/40 2006
A61K 31/505 2006
A61K 45/06 2006
A61P 9/10 2006
- (96) EP 20189100.9 4/22/2019
 (97) EP 3750535, 12/16/2020 202051, en
- (31) 201862735670 P (32) 24.09.2018 (33) US
 201862735680 P 24.09.2018 US
 201862758387 P 09.11.2018 US
 201962813888 P 05.03.2019 US
 201962818514 P 14.03.2019 US
- (54) METHODS OF REDUCING THE RISK OF CARDIOVASCULAR EVENTS IN A SUBJECT
 (72) SONI, Paresh, 148 Long Wharf Drive, Mystic, CT Connecticut 06355, US

- (51) MKP
A61K 31/232 2006 (97) EP 3750536
A61K 31/366 2006
A61K 31/40 2006
A61K 31/505 2006
A61K 45/06 2006
A61P 9/10 2006
- (96) EP 20189112.4 4/22/2019
 (97) EP 3750536, 12/16/2020 202051, en
- (31) 201862735670 P (32) 24.09.2018 (33) US
 201862735680 P 24.09.2018 US
 201862758387 P 09.11.2018 US
 201962813888 P 05.03.2019 US
 201962818514 P 14.03.2019 US
- (54) METHODS OF REDUCING THE RISK OF CARDIOVASCULAR EVENTS IN A SUBJECT
 (72) SONI, Paresh, 148 Long Wharf Drive, Mystic, CT Connecticut 06355, US

- (51) MKP

A61K 31/4745 2006 (97) EP 3760202

A61P 35/00 2006

C07D 401/12 2006

C07D 471/04 2006

(96) EP 20190341.6 2/27/2018

(97) EP 3760202, 1/6/2021 202101, en

(31) 201762465047 P

(32) 28.02.2017

(33) US

(54) INHIBITORS OF (ALPHA-V)(BETA-6) INTEGRIN

(72) HARRISON, Bryce, Alden, 7 Old Wood Road, Framingham, Massachusetts 01701, US

BURSAVICH, Matthew, Gregory, 172 Damon Road, Needham, Massachusetts 02494, US

GERASYUTO, Aleksey, Lgorevich, 20 Skyline Drive, Flemington, New Jersey 08822, US

HAHN, Kristopher, Neil, 32 Webster Street, Medford, Massachusetts 02155, US

KONZE, Kyle, David, 339 3rd Street Apt. 2C, Brooklyn, New York 11215, US

LIN, Fu-Yang, 44 Saxony Drive, Sudbury, Massachusetts 01776, US

LIPPA, Blaise, Scott, 784 Commonwealth Avenue, Newton, Massachusetts 02459, US

LUGOVSKOY, Alexey, Alexandrovich, 35 Audrey Road, Belmont, Massachusetts 02478, US

ROGERS, Bruce, Nelsen, 252 Common Street, Belmont, Massachusetts 02478, US

SVENSSON, Mats, Ake, 160 West 24th Street Apt. 19C, New York, New York 10011, US

TROAST, Dawn, Marie, 325 Springs Road, Bedford, Massachusetts 01730, US

INDEKS BROJEVA ZAHTJEVA ZA PROŠIRENJE EVROPSKIH PRIJAVA PATENTA Index on number of requests for extension on european patent application

Broj objave evropske prijava patenta (97)	MKP (51)
3165185	A61B 17/00 (2006.01) A61B 17/34 (2006.01)
3165186	A61B 17/34 (2006.01)
3242549	A01H 1/02 (2006.01) A01H 1/04 (2006.01) A01H 1/06 (2006.01) A01H 5/04 (2006.01) C07K 14/415 (2006.01) C12N 15/82 (2006.01)
3727516	A61M 5/20 (2006.01) A61M 5/28 (2006.01) A61M 5/31 (2006.01) A61M 5/315 (2006.01) A61M 5/32 (2006.01)
3256299	B29B 11/16 (2006.01) B29B 13/10 (2006.01) B29C 70/54 (2006.01) B29D 99/00 (2010.01) B65H 45/00 (2006.01)
3247330	A61K 9/00 (2006.01) A61K 9/10 (2006.01) A61K 31/195 (2006.01) A61K 31/198 (2006.01) A61K 47/38 (2006.01)
3627050	C01B 3/02 (2006.01) C09C 1/48 (2006.01) C10B 47/44 (2006.01) C10B 53/07 (2006.01) C10G 1/10 (2006.01) C10L 1/00 (2006.01) F23G 5/027 (2006.01) F23G 5/08 (2006.01) F23G 7/06 (2006.01) F23G 7/12 (2006.01) F23K 1/04 (2006.01)
3643414	B08B 3/02 (2006.01) B08B 9/023 (2006.01)
3624056	A61B 5/0456 (2006.01) G06T 7/246 (2017.01)
3746877	G06F 3/14 (2006.01) G06F 11/16 (2006.01) G06F 11/32 (2006.01) G09G 5/00 (2006.01)
3714229	F42B 12/10 (2006.01) F42B 12/16 (2006.01) F42B 12/18 (2006.01)

Broj objave evropske prijava patenta (97)	MKP (51)
3598396	G06K 9/00 (2006.01) G07C 5/08 (2006.01)
3154187	A61B 17/00 (2006.01) H02P 7/03 (2016.01)
3154186	A61B 17/00 (2006.01) H02P 7/00 (2016.01) H02P 7/06 (2006.01)
3154188	A61B 17/00 (2006.01) G01R 19/00 (2006.01) H02P 7/29 (2016.01)
3150150	A61B 17/34 (2006.01)
3713927	A61K 31/444 (2006.01) A61P 19/10 (2006.01) C07D 401/14 (2006.01) C07D 405/14 (2006.01) C07D 471/04 (2006.01)
3660290	F01N 1/16 (2006.01) F01N 1/18 (2006.01) F01N 13/04 (2010.01) F01N 13/08 (2010.01) F16K 1/00 (2006.01) F16K 11/08 (2006.01)
3659594	A61K 9/08 (2006.01) A61K 31/216 (2006.01) A61M 5/178 (2006.01)
3660075	C08G 64/02 (2006.01) C08G 64/08 (2006.01) C08G 64/12 (2006.01) C08G 64/14 (2006.01) C08G 64/42 (2006.01)
3666341	A61K 9/70 (2006.01) A61K 35/747 (2015.01) A61L 15/00 (2006.01) A61P 17/00 (2006.01) A61Q 19/00 (2006.01)
3670292	B62B 3/14 (2006.01) B62B 3/16 (2006.01) B62B 5/00 (2006.01)
3620921	G06F 9/54 (2006.01)
3644620	H04R (2006.01)
3626927	E06B 3/263 (2006.01) E06B 3/36 (2006.01)
3755684	A61K 31/165 (2006.01) A61P 25/14 (2006.01) A61P 25/18 (2006.01) A61P 25/22 (2006.01) A61P 25/24 (2006.01) A61P 25/28 (2006.01)

Broj objave evropske prijava patenta (97)	MKP (51)
	C07C 235/08 (2006.01) C07C 235/40 (2006.01)
3631468	G01N 33/68 (2006.01)
3720990	C25B 1/04 (2006.01) F03D 9/19 (2016.01)
3753084	H02J 3/32 (2006.01) H02J 9/06 (2006.01)
3553267	E06B 3/667 (2006.01) E06B 3/964 (2006.01)
3586861	A61K 31/131 (2006.01) A61K 31/132 (2006.01) A61K 31/215 (2006.01) A61K 31/56 (2006.01) A61K 38/00 (2006.01) A61K 38/16 (2006.01) A61K 38/43 (2006.01)
3713552	A61K 9/48 (2006.01) A61K 31/047 (2006.01) A61P 15/00 (2006.01)
3630111	A61K 31/439 (2006.01) A61P 31/04 (2006.01) C07D 471/08 (2006.01)
3756173	G07F 19/00 (2006.01)
3727026	A23L 2/42 (2006.01) A23L 3/015 (2006.01)
3713568	A61K 31/4045 (2006.01) A61K 45/06 (2006.01) A61P 25/00 (2006.01)
3737619	B65B 9/02 (2006.01) B65D 75/58 (2006.01)
3740154	A61C 17/20 (2006.01) A61C 17/22 (2006.01) A61C 17/34 (2006.01)
3636250	A61K 9/00 (2006.01) A61K 9/08 (2006.01) A61K 38/22 (2006.01) A61K 38/26 (2006.01) A61K 38/28 (2006.01) A61K 47/02 (2006.01) A61K 47/10 (2017.01) A61K 47/26 (2006.01)
3593730	A61B 17/04 (2006.01) A61B 17/06 (2006.01)
3617205	A61K 31/4375 (2006.01) A61K 31/444 (2006.01) A61K 31/519 (2006.01) A61K 31/5377 (2006.01)

Broj objave evropske prijave patenta (97)	MKP (51)
	A61K 31/541 (2006.01) A61P 19/00 (2006.01) A61P 35/00 (2006.01) C07D 471/04 (2006.01)
3646876	A61K 31/7088 (2006.01) A61K 31/7125 (2006.01) A61P 7/00 (2006.01) A61P 7/06 (2006.01) A61P 35/00 (2006.01) A61P 35/02 (2006.01)
3626248	A61K 35/74 (2015.01) A61K 35/745 (2015.01) A61P 1/00 (2006.01) A61P 11/06 (2006.01) A61P 19/02 (2006.01) A61P 25/28 (2006.01) A61P 29/00 (2006.01) A61P 35/00 (2006.01) C12N 1/20 (2006.01)
3583966	A61M 5/142 (2006.01) A61M 5/145 (2006.01) A61M 5/20 (2006.01) A61M 5/315 (2006.01) A61M 5/32 (2006.01)
3620522	A61K 31/7125 (2006.01) A61P 13/12 (2006.01) C12N 15/113 (2010.01)
3617529	F04D 29/54 (2006.01)
3640251	A61K 31/4738 (2006.01) A61K 31/497 (2006.01) A61P 35/00 (2006.01) C07D 471/04 (2006.01)
3636272	A61K 35/74 (2015.01) A61K 35/745 (2015.01) A61P 1/00 (2006.01) A61P 11/06 (2006.01) A61P 19/02 (2006.01) A61P 25/28 (2006.01) A61P 29/00 (2006.01) A61P 35/00 (2006.01) C12N 1/20 (2006.01)
3632466	A61K 39/395 (2006.01) A61P 17/06 (2006.01) C07K 16/28 (2006.01)
3604154	B31B 120/40 (2017.01) B65D 5/56 (2006.01) B65D 77/20 (2006.01)
3632931	A61K 39/00 (2006.01) A61P 27/02 (2006.01) C07K 16/24 (2006.01)
3626720	A61K 31/519 (2006.01) A61P 35/00 (2006.01)

Broj objave evropske prijava patenta (97)	MKP (51)
	A61P 35/02 (2006.01) C07D 487/04 (2006.01) C07D 519/00 (2006.01)
3626714	A61K 31/445 (2006.01) C07D 211/98 (2006.01) C07D 401/04 (2006.01) C07D 401/14 (2006.01) C07D 405/12 (2006.01) C07D 405/14 (2006.01) C07D 413/06 (2006.01) C07D 417/14 (2006.01)
3636742	C07H 21/00 (2006.01) C12N 1/08 (2006.01) C12N 15/10 (2006.01)
3626713	A61K 31/397 (2006.01) A61K 31/438 (2006.01) A61K 31/4427 (2006.01) A61K 31/4439 (2006.01) A61K 31/445 (2006.01) A61K 31/4468 (2006.01) A61K 31/454 (2006.01) A61K 31/4545 (2006.01) A61K 31/496 (2006.01) A61K 31/501 (2006.01) A61K 31/506 (2006.01) C07D 205/04 (2006.01) C07D 211/14 (2006.01) C07D 211/16 (2006.01) C07D 211/58 (2006.01) C07D 401/06 (2006.01) C07D 401/12 (2006.01) C07D 471/10 (2006.01)
3626710	C07D 239/46 (2006.01)
3672771	B27N 3/00 (2006.01) B27N 3/02 (2006.01) B27N 3/04 (2006.01) B32B 21/02 (2006.01) B32B 21/04 (2006.01) B32B 21/14 (2006.01) C08L 97/02 (2006.01)
3639851	A61K 39/00 (2006.01) A61K 39/12 (2006.01)
3743579	E05F 11/38 (2006.01) E05F 11/48 (2006.01)
3723744	A61K 31/165 (2006.01) A61K 31/18 (2006.01) A61K 31/381 (2006.01) A61K 31/40 (2006.01) A61K 31/422 (2006.01) A61K 31/427 (2006.01) A61K 31/431 (2006.01) A61K 31/4406 (2006.01) A61K 31/445 (2006.01) A61P 25/02 (2006.01)

Broj objave evropske prijava patenta (97)	MKP (51)
3728566	C12N 5/073 (2010.01) C12N 5/0775 (2010.01)
3716992	A61K 38/17 (2006.01) A61P 27/02 (2006.01)
3714055	A61P 27/02 (2006.01) C12N 9/22 (2006.01) C12N 15/113 (2010.01)
3720855	A61K 31/437 (2006.01) A61K 31/5377 (2006.01) A61P 25/00 (2006.01) A61P 25/24 (2006.01) C07D 471/04 (2006.01)
3717510	A61P 13/12 (2006.01) C07K 16/08 (2006.01)
3723827	A61M 5/20 (2006.01) A61M 5/315 (2006.01) A61M 5/32 (2006.01)
3720469	A61K 38/19 (2006.01) A61P 7/04 (2006.01)
3724176	A61K 31/497 (2006.01) A61P 25/30 (2006.01) C07D 401/12 (2006.01)
3720880	A61K 31/137 (2006.01) A61K 31/225 (2006.01) A61K 31/277 (2006.01) A61P 25/00 (2006.01) C07K 16/28 (2006.01)
3723480	A01G 13/06 (2006.01) A01M 21/04 (2006.01)
3729100	G01N 33/50 (2006.01) G01N 33/74 (2006.01)
3720877	A61P 37/06 (2006.01) C07K 16/00 (2006.01)
3724182	A61K 31/40 (2006.01) A61P 37/00 (2006.01) C07D 207/36 (2006.01) C07D 403/12 (2006.01)
3728246	A61K 31/437 (2006.01) A61P 9/00 (2006.01) A61P 11/00 (2006.01) C07D 471/04 (2006.01)
3728247	A61K 31/437 (2006.01) A61P 9/00 (2006.01) A61P 11/00 (2006.01) C07D 471/04 (2006.01)
3728248	A61K 31/541 (2006.01) A61P 11/00 (2006.01)

Broj objave evropske prijave patenta (97)	MKP (51)
	C07D 471/04 (2006.01) C07D 487/04 (2006.01) C07D 519/00 (2006.01)
3720537	A61M 31/00 (2006.01)
3717369	B65D 33/25 (2006.01)
3720473	A61K 38/46 (2006.01) C12N 9/22 (2006.01) C12N 15/10 (2006.01) C12N 15/113 (2010.01)
3720859	A61K 31/51 (2006.01) A61P 25/00 (2006.01) C07D 495/14 (2006.01)
3720860	A61K 31/519 (2006.01) A61P 25/00 (2006.01) C07D 495/14 (2006.01)
3720849	C07D 231/20 (2006.01) C07D 401/04 (2006.01) C07D 401/14 (2006.01) C07D 405/04 (2006.01)
3720949	C12N 5/0783 (2010.01)
3724228	A61K 39/00 (2006.01) A61K 39/395 (2006.01) A61P 25/16 (2006.01) A61P 25/28 (2006.01) C07K 16/28 (2006.01)
3724224	C07K 16/18 (2006.01)
3728313	A61K 39/395 (2006.01) A61K 45/06 (2006.01) A61P 35/00 (2006.01) C07K 16/28 (2006.01)
3720478	A61K 38/17 (2006.01) A61K 39/00 (2006.01) C07K 14/47 (2006.01) C07K 14/725 (2006.01)
3720874	A61K 35/17 (2015.01) C07K 14/725 (2006.01) C12N 5/0783 (2010.01)
3723807	A61K 31/437 (2006.01) A61K 31/444 (2006.01) A61K 31/497 (2006.01) A61K 31/506 (2006.01) A61K 45/06 (2006.01) A61P 25/00 (2006.01) A61P 25/18 (2006.01) A61P 25/22 (2006.01) A61P 25/24 (2006.01) A61P 25/28 (2006.01)

Broj objave evropske prijave patenta (97)	MKP (51)
3723808	A61K 31/437 (2006.01) A61K 31/444 (2006.01) A61K 31/497 (2006.01) A61K 31/506 (2006.01) A61K 45/06 (2006.01) A61P 25/00 (2006.01) A61P 25/18 (2006.01) A61P 25/22 (2006.01) A61P 25/24 (2006.01) A61P 25/28 (2006.01)
3723800	A61K 39/395 (2006.01) A61P 21/00 (2006.01) A61P 37/00 (2006.01) C07K 16/28 (2006.01)
3727341	A61K 9/16 (2006.01) A61K 9/20 (2006.01) A61K 9/28 (2006.01) A61K 31/155 (2006.01) A61K 31/702 (2006.01) A61K 45/06 (2006.01)
3720457	A61K 8/99 (2017.01) A61K 35/74 (2015.01) A61P 17/00 (2006.01) A61Q 19/00 (2006.01)
3717634	C12N 5/0783 (2010.01)
3723797	A61K 39/00 (2006.01) A61K 39/12 (2006.01) A61P 31/20 (2006.01)
3749903	F25B 19/00 (2006.01) F25B 25/00 (2006.01) F25D 3/10 (2006.01) H02G 15/34 (2006.01)
3717461	A01N 43/80 (2006.01) A61K 31/42 (2006.01) A61P 33/00 (2006.01) C07D 261/08 (2006.01)
3720875	C07K 14/435 (2006.01) C07K 14/78 (2006.01) C12N 15/82 (2006.01)
3720867	A61K 31/58 (2006.01) A61P 25/24 (2006.01) C07J 1/00 (2006.01) C07J 7/00 (2006.01) C07J 13/00 (2006.01) C07J 43/00 (2006.01)
3727425	A61K 38/26 (2006.01) A61P 3/00 (2006.01) C07K 14/605 (2006.01)
3727426	A61K 38/26 (2006.01) A61P 3/00 (2006.01) C07K 14/605 (2006.01)

Broj objave evropske prijava patenta (97)	MKP (51)
3724332	C12N 9/22 (2006.01) C12N 15/10 (2006.01)
3728252	A61K 31/437 (2006.01) A61P 37/00 (2006.01) C07D 471/04 (2006.01) C07D 519/00 (2006.01)
3724178	A61K 31/496 (2006.01) A61P 35/00 (2006.01) C07D 401/06 (2006.01) C07D 401/14 (2006.01) C07D 471/04 (2006.01) C07D 471/10 (2006.01) C07D 491/107 (2006.01) C07D 491/113 (2006.01) C07D 491/20 (2006.01) C07D 495/04 (2006.01) C07D 495/10 (2006.01) C07D 497/10 (2006.01)
3728315	A61K 39/00 (2006.01) A61K 39/395 (2006.01) A61P 3/04 (2006.01) A61P 3/10 (2006.01) C07K 16/28 (2006.01)
3728254	A61K 31/519 (2006.01) A61P 35/00 (2006.01) C07D 453/02 (2006.01) C07D 471/04 (2006.01) C07D 519/00 (2006.01)
3723509	A23L 33/00 (2016.01) A23L 33/105 (2016.01) A61K 36/00 (2006.01)
3728302	C07K 14/55 (2006.01) C12N 15/62 (2006.01)
3727441	A61K 39/12 (2006.01) A61K 39/29 (2006.01) A61N 1/00 (2006.01) A61P 31/14 (2006.01)
3752704	E21B 21/00 (2006.01)
3720462	A61K 36/185 (2006.01) A61K 36/24 (2006.01) A61K 36/28 (2006.01) A61K 36/47 (2006.01) A61K 36/59 (2006.01) A61K 36/708 (2006.01) A61K 36/739 (2006.01) A61K 36/756 (2006.01) A61K 36/82 (2006.01) A61K 36/886 (2006.01) A61P 13/08 (2006.01) A61P 15/00 (2006.01) A61P 35/00 (2006.01)
3720483	A61K 39/00 (2006.01) A61K 39/09 (2006.01) A61K 39/385 (2006.01)

Broj objave evropske prijave patenta (97)	MKP (51)
	A61P 31/04 (2006.01)
3727582	A61N 5/00 (2006.01) A61N 5/06 (2006.01) F21L 4/00 (2006.01) F21L 4/02 (2006.01) F21V 1/00 (2006.01) F21V 3/00 (2015.01) F21V 3/02 (2006.01) F21V 3/04 (2018.01)
3716624	H04N 19/124 (2014.01) H04N 19/30 (2014.01)
3713402	A01K 61/60 (2017.01)
3713601	A61K 9/51 (2006.01) A61K 31/7115 (2006.01) A61K 39/245 (2006.01) A61P 31/22 (2006.01) C12N 7/00 (2006.01)
3717483	A61K 31/437 (2006.01) A61P 35/00 (2006.01) C07D 471/04 (2006.01) C07D 519/00 (2006.01)
3713403	A01K 61/60 (2017.01)
3717473	C07D 403/12 (2006.01) C07D 403/14 (2006.01) C07D 405/14 (2006.01) C07D 413/14 (2006.01)
3713594	A61K 38/28 (2006.01) C07K 14/62 (2006.01)
3717512	A61K 39/00 (2006.01) A61K 51/10 (2006.01) C07K 16/18 (2006.01)
3717462	A61K 31/4245 (2006.01) A61P 35/00 (2006.01) C07D 271/113 (2006.01) C07D 413/12 (2006.01)
3717022	A61K 47/68 (2017.01)
3716982	A61K 31/585 (2006.01) A61K 39/395 (2006.01) C07K 16/28 (2006.01)
3716964	A61K 31/165 (2006.01) A61K 31/18 (2006.01) A61K 31/40 (2006.01) C07C 255/00 (2006.01) C07C 307/02 (2006.01) C07C 317/50 (2006.01)
3717519	A61K 38/00 (2006.01) C07K 16/28 (2006.01)

Broj objave evropske prijava patenta (97)	MKP (51)
3718545	A61K 31/4245 (2006.01) A61K 45/00 (2006.01) A61P 35/00 (2006.01) A61P 43/00 (2006.01) C07D 249/04 (2006.01)
3719004	A01N 43/40 (2006.01) A01N 43/50 (2006.01) A01N 43/54 (2006.01) A01N 43/56 (2006.01) A01N 43/60 (2006.01) A01N 43/76 (2006.01) A01N 43/78 (2006.01) A01N 43/80 (2006.01) A01N 43/836 (2006.01) A01N 47/02 (2006.01) A01P 7/02 (2006.01) A01P 7/04 (2006.01) A01P 17/00 (2006.01) A61K 31/4425 (2006.01) A61P 33/00 (2006.01) C07D 213/89 (2006.01) C07D 401/12 (2006.01) C07D 405/12 (2006.01) C07D 409/12 (2006.01) C07D 413/12 (2006.01) C07D 417/12 (2006.01)
3717505	A61K 38/00 (2006.01) C07K 14/00 (2006.01) C12Q 1/68 (2018.01)
3720438	A61K 31/42 (2006.01) A61K 31/505 (2006.01) A61K 31/506 (2006.01) C07D 247/02 (2006.01) C07D 261/02 (2006.01) C07D 261/06 (2006.01)
3720448	A61K 31/7088 (2006.01) A61K 31/712 (2006.01) A61K 31/713 (2006.01) A61K 39/395 (2006.01) A61K 47/68 (2017.01) C12N 15/113 (2010.01)
3720421	A61K 9/08 (2006.01) A61K 31/198 (2006.01) A61K 31/375 (2006.01) A61K 31/4415 (2006.01) A61K 31/51 (2006.01) A61K 31/525 (2006.01) A61K 31/714 (2006.01) A61K 33/14 (2006.01) A61K 47/18 (2017.01)
3720952	C12N 5/10 (2006.01) C12N 9/22 (2006.01) C12N 15/09 (2006.01) C12N 15/113 (2010.01) C12N 15/63 (2006.01) C12N 15/64 (2006.01) C12N 15/66 (2006.01) C12N 15/90 (2006.01)

Broj objave evropske prijave patenta (97)	MKP (51)
3720487	A61K 9/00 (2006.01) A61K 9/14 (2006.01) A61K 39/12 (2006.01) A61K 47/26 (2006.01)
3724227	C07K 16/18 (2006.01) C07K 16/34 (2006.01) C07K 16/44 (2006.01) G01N 33/53 (2006.01) G01N 33/577 (2006.01) G01N 33/72 (2006.01)
3724300	C10L 5/14 (2006.01) C10L 5/44 (2006.01)
3723788	A61K 38/17 (2006.01) A61K 39/395 (2006.01) C07K 14/705 (2006.01) C07K 16/28 (2006.01)
3724208	C07K 7/00 (2006.01) C07K 7/06 (2006.01) C12P 21/00 (2006.01)
3726298	G03G 21/18 (2006.01)
3723757	A61K 31/437 (2006.01) C07D 409/14 (2006.01) C07D 513/16 (2006.01)
3723787	A61K 38/16 (2006.01) C07K 14/435 (2006.01) C12N 15/62 (2006.01)
3724220	C07K 14/705 (2006.01) C12N 5/00 (2006.01)
3724211	A61K 38/04 (2006.01) A61K 38/12 (2006.01) C07K 7/06 (2006.01) C07K 7/50 (2006.01) C07K 7/64 (2006.01) C07K 14/47 (2006.01)
3727353	A61K 9/16 (2006.01) A61K 9/72 (2006.01) A61P 11/16 (2006.01) C07K 14/785 (2006.01)
3728202	C07D 231/56 (2006.01) C07D 471/04 (2006.01)
3729160	A01G 9/24 (2006.01) G02B 19/00 (2006.01)
3728203	C07D 231/56 (2006.01) C07D 471/04 (2006.01)
3730935	A61K 31/513 (2006.01) A61K 31/7072 (2006.01) A61P 35/00 (2006.01) C07H 19/073 (2006.01)

Broj objave evropske prijava patenta (97)	MKP (51)
	G01N 30/26 (2006.01) G01N 30/88 (2006.01)
3727468	A61K 9/00 (2006.01) A61K 39/395 (2006.01) A61K 48/00 (2006.01) A61P 27/16 (2006.01) C12N 15/113 (2010.01)
3727363	A61K 31/155 (2006.01) A61K 31/4164 (2006.01) A61K 31/496 (2006.01)
3727368	A61K 31/282 (2006.01) A61K 31/436 (2006.01) A61K 31/513 (2006.01) A61K 31/519 (2006.01) A61K 39/395 (2006.01) A61P 35/00 (2006.01)
3729375	A47F 9/04 (2006.01) G06Q 30/06 (2012.01) G06T 7/41 (2017.01) G07G 1/12 (2006.01)
3728260	A61K 31/47 (2006.01) A61K 31/519 (2006.01) A61P 35/02 (2006.01) C07D 471/10 (2006.01) C07D 487/10 (2006.01) C07D 495/04 (2006.01)
3730620	A61K 39/12 (2006.01) A61K 39/145 (2006.01) A61K 39/295 (2006.01) A61P 31/14 (2006.01) A61P 31/16 (2006.01) C07K 14/08 (2006.01) C07K 14/11 (2006.01) C07K 19/00 (2006.01) C12N 15/40 (2006.01) C12N 15/44 (2006.01) C12N 15/62 (2006.01)
3732205	C07K 16/46 (2006.01)
3727377	A61K 31/427 (2006.01) A61K 31/4439 (2006.01)
3730612	A61K 35/17 (2015.01) A61P 35/00 (2006.01) C07K 14/52 (2006.01) C07K 14/54 (2006.01) C07K 14/705 (2006.01) C07K 19/00 (2006.01) C12N 5/0783 (2010.01) C12N 15/09 (2006.01)
3727418	A61K 38/00 (2006.01) C07K 14/435 (2006.01) C07K 19/00 (2006.01)

Broj objave evropske prijava patenta (97)	MKP (51)
3732187	C07H 21/04 (2006.01) C07K 14/34 (2006.01) C12N 1/20 (2006.01) C12N 1/21 (2006.01)
3732166	C07D 239/47 (2006.01) C07D 401/10 (2006.01) C07D 401/12 (2006.01)
3636637	A61K 31/438 (2006.01) A61P 1/16 (2006.01) C07D 221/20 (2006.01) C07D 401/06 (2006.01) C07D 401/10 (2006.01) C07D 405/06 (2006.01) C07D 405/14 (2006.01) C07D 409/14 (2006.01) C07D 413/06 (2006.01) C07D 413/10 (2006.01) C07D 413/14 (2006.01)
3628688	A61P 35/00 (2006.01) C07K 16/28 (2006.01)
3629092	G03G 15/00 (2006.01)
3639666	A01N 25/12 (2006.01) A01N 37/04 (2006.01) A01N 43/90 (2006.01) A01N 57/12 (2006.01) A01P 7/00 (2006.01)
3620175	A61K 39/395 (2006.01) A61K 47/12 (2006.01) C07K 16/22 (2006.01)
3653701	A61K 39/145 (2006.01) A61P 31/16 (2006.01) C12N 7/04 (2006.01)
3656399	A61K 39/00 (2006.01) A61K 39/395 (2006.01) A61P 3/06 (2006.01) C07K 16/40 (2006.01)
3640816	G06F 8/60 (2018.01) G06F 16/28 (2019.01)
3641221	H04L 12/24 (2006.01)
3650047	A61K 9/51 (2006.01) A61K 39/00 (2006.01) A61K 47/69 (2017.01) A61P 1/00 (2006.01) A61P 11/06 (2006.01) A61P 13/12 (2006.01) A61P 19/06 (2006.01) A61P 25/00 (2006.01)
3653733	A61K 31/00 (2006.01) C07K 14/72 (2006.01) C07K 16/28 (2006.01)

Broj objave evropske prijave patenta (97)	MKP (51)
	C12Q 1/6886 (2018.01)
3626267	A61K 39/395 (2006.01) C07K 16/22 (2006.01)
3626185	A61B 17/32 (2006.01) A61B 18/14 (2006.01)
3628335	A61K 48/00 (2006.01)
3657566	H01M 2/02 (2006.01) H01M 2/20 (2006.01) H01M 2/30 (2006.01)
3632442	A61K 31/519 (2006.01) A61K 31/5377 (2006.01) A61P 35/00 (2006.01)
3656384	A61K 31/513 (2006.01) A61P 31/18 (2006.01)
3660381	F17C 13/04 (2006.01)
3661050	H02S 20/00 (2014.01)
3656396	A61K 39/155 (2006.01)
3636073	A01K 67/027 (2006.01) A61K 49/00 (2006.01) C07K 14/47 (2006.01) C12N 15/85 (2006.01)
3653225	A61K 39/395 (2006.01) C07K 16/28 (2006.01)
3699195	C07K 16/28 (2006.01) C07K 16/30 (2006.01) C07K 16/46 (2006.01)
3660011	C07D 401/14 (2006.01)
3656379	A61K 9/16 (2006.01) A61K 9/28 (2006.01) A61K 31/225 (2006.01)
3660047	A61K 39/35 (2006.01) A61P 37/08 (2006.01) C07K 16/18 (2006.01)
3685855	A61K 39/00 (2006.01) A61K 39/395 (2006.01) A61K 45/06 (2006.01) A61P 35/00 (2006.01) C07K 16/28 (2006.01)
3713554	A61K 31/192 (2006.01) A61P 29/00 (2006.01)

Broj objave evropske prijava patenta (97)	MKP (51)
3714449	G09F 3/02 (2006.01) G09F 3/10 (2006.01)
3717143	B21B 21/00 (2006.01)
3717088	A63H 33/08 (2006.01) E04B 2/08 (2006.01) E04H 9/02 (2006.01)
3717486	A61K 31/381 (2006.01) A61P 31/16 (2006.01) C07D 487/04 (2006.01) C07D 495/04 (2006.01) C07D 513/04 (2006.01) C07D 519/00 (2006.01)
3607938	A61K 9/20 (2006.01) A61K 9/48 (2006.01) A61K 9/50 (2006.01) A61K 31/198 (2006.01) A61K 45/06 (2006.01) A61K 47/58 (2017.01)
3633461	G03G 15/00 (2006.01) G03G 15/08 (2006.01) G03G 21/16 (2006.01) G03G 21/18 (2006.01)
3587400	C07C 51/16 (2006.01) C07C 67/30 (2006.01) C07C 67/39 (2006.01) C07D 213/61 (2006.01) C07D 213/89 (2006.01)
3617192	A61K 31/404 (2006.01) A61P 31/14 (2006.01) C07D 209/14 (2006.01) C07D 401/08 (2006.01) C07D 401/12 (2006.01) C07D 401/14 (2006.01) C07D 403/08 (2006.01) C07D 403/10 (2006.01) C07D 403/12 (2006.01) C07D 405/12 (2006.01) C07D 409/08 (2006.01) C07D 409/12 (2006.01) C07D 413/08 (2006.01) C07D 413/12 (2006.01) C07D 417/14 (2006.01) C07D 471/04 (2006.01) C07D 487/04 (2006.01) C07D 495/04 (2006.01) C07D 498/04 (2006.01) C07D 513/04 (2006.01)
3620467	A61K 39/395 (2006.01) A61P 35/00 (2006.01) A61P 35/02 (2006.01) C07K 16/28 (2006.01)
3728288	C07K 1/22 (2006.01)
3724342	C12N 9/22 (2006.01) C12N 15/113 (2010.01)

Broj objave evropske prijave patenta (97)	MKP (51)
	C12N 15/90 (2006.01)
3728594	A61P 27/02 (2006.01) C12N 15/113 (2010.01)
3728595	A61P 27/02 (2006.01) C12N 15/113 (2010.01)
3733196	A61K 38/17 (2006.01) A61P 29/00 (2006.01) C07K 14/47 (2006.01)
3728291	A61K 39/245 (2006.01) A61K 39/295 (2006.01) C07K 14/05 (2006.01)
3731933	A61K 31/11 (2006.01) A61P 31/12 (2006.01) C07C 43/20 (2006.01) C07C 47/57 (2006.01) C07C 69/736 (2006.01) C07C 243/18 (2006.01) C07C 245/12 (2006.01) C07C 251/24 (2006.01) C07C 309/13 (2006.01) C07D 207/14 (2006.01) C07D 211/60 (2006.01) C07D 213/74 (2006.01) C07D 215/38 (2006.01)
3720480	A61K 39/00 (2006.01) C12N 5/0783 (2010.01)
3732316	C25B 1/08 (2006.01) C25B 9/18 (2006.01) C25B 9/20 (2006.01) C25B 15/02 (2006.01)
3717025	A61K 51/04 (2006.01) A61K 101/00 (2006.01) A61K 101/02 (2006.01) C07B 59/00 (2006.01) C07D 491/048 (2006.01)
3720428	A61K 31/185 (2006.01) A61P 27/02 (2006.01)
3724198	A61K 31/433 (2006.01) A61P 25/08 (2006.01) C07D 513/04 (2006.01)
3720851	A61K 31/4245 (2006.01) A61P 9/00 (2006.01) A61P 25/00 (2006.01) A61P 31/00 (2006.01) C07D 413/14 (2006.01)
3716944	A61K 9/00 (2006.01) A61K 9/06 (2006.01) A61K 31/192 (2006.01) A61K 47/40 (2006.01)

Broj objave evropske prijave patenta (97)	MKP (51)
3717007	A61K 31/337 (2006.01) A61K 39/395 (2006.01) A61P 35/00 (2006.01) A61P 37/04 (2006.01) C07K 16/28 (2006.01)
3720440	A61K 31/437 (2006.01) A61K 31/519 (2006.01) A61P 11/00 (2006.01) A61P 31/14 (2006.01)
3717471	A61K 31/437 (2006.01) A61P 9/00 (2006.01) A61P 37/00 (2006.01) C07D 403/04 (2006.01) C07D 471/04 (2006.01)
3716755	A01G 17/06 (2006.01)
3727114	A47K 10/32 (2006.01) A47K 10/38 (2006.01) A47K 10/40 (2006.01) B65H 16/06 (2006.01) B65H 75/24 (2006.01)
3724165	A61K 31/185 (2006.01) A61K 31/44 (2006.01) A61K 31/444 (2006.01) A61K 31/50 (2006.01) A61P 35/00 (2006.01) C07C 237/20 (2006.01) C07C 255/50 (2006.01) C07D 213/75 (2006.01) C07D 237/20 (2006.01) C07D 295/192 (2006.01) C07D 401/04 (2006.01)
3713593	A61K 38/26 (2006.01) A61P 3/10 (2006.01)
3717482	A61K 31/519 (2006.01) A61K 31/52 (2006.01) A61P 35/00 (2006.01) A61P 37/00 (2006.01) C07D 471/04 (2006.01) C07D 473/30 (2006.01) C07D 495/04 (2006.01)
3716952	A61K 9/16 (2006.01) A61K 9/20 (2006.01) A61K 9/28 (2006.01) A61K 9/48 (2006.01) A61K 31/00 (2006.01)
3713933	A61K 31/473 (2006.01) A61P 25/00 (2006.01) C07D 405/12 (2006.01) C07D 405/14 (2006.01)
3714047	A61K 48/00 (2006.01) A61P 3/00 (2006.01) C12N 9/02 (2006.01)

Broj objave evropske prijava patenta (97)	MKP (51)
	C12N 15/67 (2006.01)
3714045	A61K 48/00 (2006.01) A61P 3/00 (2006.01) C12N 9/00 (2006.01) C12N 15/67 (2006.01)
3716791	A23G 9/42 (2006.01) A23L 9/20 (2016.01) A23L 33/185 (2016.01) A61K 36/48 (2006.01)
3720865	A61K 31/505 (2006.01) A61P 35/00 (2006.01) C07D 307/94 (2006.01) C07D 317/44 (2006.01) C07D 471/04 (2006.01) C07H 19/14 (2006.01)
3714048	A61K 48/00 (2006.01) A61P 3/00 (2006.01) C12N 9/10 (2006.01) C12N 15/67 (2006.01)
3717455	C07B 59/00 (2006.01) C07C 33/18 (2006.01) C07C 69/96 (2006.01) C07D 215/56 (2006.01)
3713928	A61K 31/4709 (2006.01) A61K 31/5377 (2006.01) A61P 11/06 (2006.01) A61P 25/28 (2006.01) A61P 29/00 (2006.01) C07D 401/04 (2006.01) C07D 401/14 (2006.01) C07D 405/14 (2006.01) C07D 413/14 (2006.01) C07D 417/14 (2006.01)
3717514	A61K 39/00 (2006.01) C07K 16/28 (2006.01)
3720864	A61K 31/7052 (2006.01) A61P 35/00 (2006.01) C07H 19/10 (2006.01) C07H 19/20 (2006.01)
3720416	A61K 8/81 (2006.01) A61Q 11/00 (2006.01)
3720563	A61K 8/81 (2006.01) A61Q 11/00 (2006.01)
3720564	A61K 8/02 (2006.01) A61K 8/24 (2006.01) A61Q 11/00 (2006.01) G01N 1/30 (2006.01) G01N 21/17 (2006.01) G01N 33/15 (2006.01)
3713919	A61K 31/4709 (2006.01) A61P 7/06 (2006.01)

Broj objave evropske prijave patenta (97)	MKP (51)
	C07D 215/36 (2006.01)
3720526	A61M 5/24 (2006.01) A61M 5/315 (2006.01)
3716980	A61K 31/573 (2006.01) A61P 43/00 (2006.01) C07K 16/28 (2006.01) G01N 33/68 (2006.01)
3720279	A01K 67/027 (2006.01) C07K 16/00 (2006.01) C07K 16/46 (2006.01) C12N 9/12 (2006.01)
3713940	A61K 31/437 (2006.01) A61P 25/00 (2006.01) C07D 471/04 (2006.01)
3720858	A61K 31/4525 (2006.01) A61P 9/04 (2006.01) C07D 491/10 (2006.01)
3727359	A61K 31/047 (2006.01) A61P 43/00 (2006.01)
3752972	G06Q 40/00 (2012.01)
3752191	A61K 39/395 (2006.01) C07K 14/47 (2006.01) C12N 15/864 (2006.01)
3752193	A61K 39/395 (2006.01) C07K 16/28 (2006.01) C07K 16/30 (2006.01)
3752440	B07C 3/00 (2006.01) B07C 5/00 (2006.01) B65G 15/22 (2006.01) B65G 17/26 (2006.01) B65G 47/08 (2006.01)
3753941	A61K 31/519 (2006.01) A61K 31/55 (2006.01) A61K 45/06 (2006.01) A61P 35/00 (2006.01) A61P 35/02 (2006.01) C07D 487/04 (2006.01) C07D 519/00 (2006.01)
3752491	A61K 31/538 (2006.01) C07D 265/36 (2006.01) C07D 413/14 (2006.01)
3752216	A61M 1/36 (2006.01) C09D 11/50 (2014.01) F28D 9/00 (2006.01)
3752142	A61K 31/366 (2006.01) A61K 31/381 (2006.01) A61K 31/4025 (2006.01)

Broj objave evropske prijava patenta (97)	MKP (51)
3752143	A61K 31/366 (2006.01) A61K 31/381 (2006.01) A61K 31/4025 (2006.01)
3755613	B60R 11/02 (2006.01) B62D 1/04 (2006.01) B62K 11/14 (2006.01)
3614208	G03G 15/00 (2006.01)
3614209	G03G 15/00 (2006.01)
3656398	A61K 39/395 (2006.01) A61P 35/00 (2006.01) C07K 16/28 (2006.01) C07K 16/30 (2006.01)
3623385	A61K 39/395 (2006.01) A61P 35/02 (2006.01) A61P 37/00 (2006.01) C07K 16/28 (2006.01)
3628373	A61K 39/39 (2006.01) A61P 27/02 (2006.01)
3636279	A61K 39/395 (2006.01)
3622956	A61K 31/506 (2006.01) A61P 25/00 (2006.01)
3656758	C07C 233/18 (2006.01) C07D 213/30 (2006.01) C07D 319/08 (2006.01)
3636251	A61K 9/00 (2006.01) A61K 31/137 (2006.01) A61K 47/02 (2006.01) A61K 47/28 (2006.01)
3626717	A61K 31/47 (2006.01) A61K 31/535 (2006.01) A61P 37/00 (2006.01) C07D 215/48 (2006.01) C07D 401/10 (2006.01) C07D 401/14 (2006.01) C07D 403/14 (2006.01) C07D 413/04 (2006.01) C07D 413/14 (2006.01) C07D 417/14 (2006.01) C07D 451/04 (2006.01) C07D 471/04 (2006.01) C07D 471/10 (2006.01) C07D 487/04 (2006.01) C07D 487/10 (2006.01) C07D 493/10 (2006.01)
3633035	A61K 31/7088 (2006.01) A61P 21/00 (2006.01) C12N 15/11 (2006.01) C12N 15/113 (2010.01)
3616678	A61K 8/34 (2006.01) A61K 8/9728 (2017.01)

Broj objave evropske prijava patenta (97)	MKP (51)
	A61Q 19/00 (2006.01)
3617206	A61K 31/4375 (2006.01) A61P 11/00 (2006.01) C07D 471/04 (2006.01)
3616681	A61K 8/67 (2006.01) A61K 8/9728 (2017.01) A61Q 19/00 (2006.01)
3616684	A61K 8/60 (2006.01) A61K 8/9728 (2017.01) A61Q 17/00 (2006.01) A61Q 19/00 (2006.01)
3628161	A01N 63/00 (2020.01) A01N 65/00 (2009.01) A61K 35/742 (2015.01) A61K 35/744 (2015.01) A61K 35/745 (2015.01) A61K 35/747 (2015.01) A61P 1/12 (2006.01) A61P 31/04 (2006.01)
3656771	C07D 471/04 (2006.01)
3624112	G10K 11/178 (2006.01) H04R 1/10 (2006.01)
3620213	A61K 8/31 (2006.01) A61K 8/37 (2006.01) A61K 8/39 (2006.01) A61K 8/67 (2006.01) A61K 8/86 (2006.01) A61P 17/00 (2006.01) A61P 17/10 (2006.01) A61Q 19/00 (2006.01) A61Q 19/06 (2006.01) A61Q 19/08 (2006.01)
3623245	B61D 7/20 (2006.01) B61D 7/28 (2006.01) B61D 7/32 (2006.01) E01B 27/02 (2006.01)
3636867	E05F 11/48 (2006.01) E05F 15/689 (2015.01)
3623215	B60P 1/16 (2006.01) B60P 1/64 (2006.01)
3623218	B60P 1/64 (2006.01)
3650363	A23L 3/00 (2006.01) A23L 3/04 (2006.01) B65B 55/02 (2006.01) B65B 55/04 (2006.01) B65B 55/10 (2006.01)
3613745	A61K 31/4985 (2006.01) A61P 35/00 (2006.01)

Broj objave evropske prijava patenta (97)	MKP (51)
	C07D 487/04 (2006.01)
3653645	C07K 16/24 (2006.01) G01N 33/53 (2006.01)
3647412	C12N 5/0781 (2010.01) C12N 5/0783 (2010.01)
3653209	A61K 31/44 (2006.01) A61K 31/519 (2006.01) A61K 31/527 (2006.01) A61P 35/00 (2006.01) C07D 491/14 (2006.01)
3627024	F16B 21/02 (2006.01) F16L 1/024 (2006.01) F16L 3/10 (2006.01) F16L 3/24 (2006.01) H02G 3/30 (2006.01) H02G 3/32 (2006.01)
3627025	F16B 21/02 (2006.01) F16L 1/024 (2006.01) F16L 3/10 (2006.01) F16L 3/24 (2006.01) H02G 3/30 (2006.01) H02G 3/32 (2006.01)
3653228	A61K 47/68 (2017.01) A61P 35/00 (2006.01) C07K 16/28 (2006.01)
3620159	A61K 31/337 (2006.01) A61K 31/519 (2006.01) A61P 35/00 (2006.01)
3660029	A61K 39/00 (2006.01) C07H 21/04 (2006.01)
3650042	A61K 31/225 (2006.01) A61K 39/05 (2006.01) A61K 39/09 (2006.01) A61P 25/28 (2006.01) A61P 31/00 (2006.01)
3653628	C07D 487/04 (2006.01)
3745850	A01K 29/00 (2006.01) A01K 31/18 (2006.01) A01K 31/19 (2006.01) A01K 31/22 (2006.01)
3725635	B61C 17/00 (2006.01)
3717371	B65D 23/00 (2006.01) B65D 43/16 (2006.01) B65D 81/32 (2006.01) B65D 81/38 (2006.01) B65D 85/80 (2006.01)
3725638	B61D 17/00 (2006.01) B61F 1/00 (2006.01)

Broj objave evropske prijava patenta (97)	MKP (51)
	B61F 19/04 (2006.01)
3756606	A61B 17/00 (2006.01) A61B 34/30 (2016.01)
3742269	G06F 3/048 (2013.01)
3744392	A61N 2/00 (2006.01)
3623064	B08B 3/02 (2006.01) B08B 9/08 (2006.01)
3735411	A61K 31/437 (2006.01) A61P 25/28 (2006.01) C07D 471/04 (2006.01)
3735227	A61K 9/20 (2006.01) A61K 31/192 (2006.01) A61K 31/205 (2006.01)
3737780	B44C 1/22 (2006.01) C23F 1/02 (2006.01)
3740478	A61K 31/4184 (2006.01) A61P 29/00 (2006.01) C07D 403/12 (2006.01) C07D 403/14 (2006.01) C07D 405/14 (2006.01) C07D 413/12 (2006.01) C07D 413/14 (2006.01) C07D 487/04 (2006.01)
3740489	A61K 31/519 (2006.01) A61P 31/16 (2006.01) C07D 487/04 (2006.01)
3740191	A61K 9/00 (2006.01) A61K 31/454 (2006.01) A61K 47/40 (2006.01) A61P 27/14 (2006.01)
3746437	A61K 31/437 (2006.01) A61P 1/16 (2006.01) A61P 19/02 (2006.01) A61P 25/00 (2006.01) C07D 405/04 (2006.01) C07D 471/04 (2006.01)
3740218	A61K 35/74 (2015.01) A61K 39/395 (2006.01) A61P 35/00 (2006.01)
3740492	A61K 31/407 (2006.01) A61P 35/00 (2006.01) A61P 37/00 (2006.01) C07D 487/10 (2006.01)
3737386	A61K 9/00 (2006.01) A61K 31/7105 (2006.01) A61K 39/12 (2006.01) C12N 15/87 (2006.01)

Broj objave evropske prijava patenta (97)	MKP (51)
3743440	C07K 16/00 (2006.01) C07K 16/28 (2006.01) C07K 16/30 (2006.01)
3746450	A61K 31/437 (2006.01) A61P 3/04 (2006.01) A61P 3/10 (2006.01) C07D 498/04 (2006.01)
3737232	A01N 25/04 (2006.01) A01N 25/28 (2006.01) A01N 37/20 (2006.01)
3743160	A61K 8/02 (2006.01) A61K 8/19 (2006.01) A61Q 1/02 (2006.01) A61Q 1/06 (2006.01) A61Q 1/10 (2006.01) C01F 11/18 (2006.01)
3743164	A61K 8/02 (2006.01) A61K 8/19 (2006.01) A61Q 19/00 (2006.01) A61Q 19/08 (2006.01)
3746451	A61K 31/437 (2006.01) A61K 31/444 (2006.01) A61K 31/4545 (2006.01) A61K 31/497 (2006.01) A61K 31/501 (2006.01) A61K 31/5377 (2006.01) A61P 3/00 (2006.01) A61P 3/10 (2006.01) C07D 498/04 (2006.01) C07D 519/00 (2006.01)
3746443	A61K 31/519 (2006.01) A61P 3/00 (2006.01) C07D 487/04 (2006.01)
3744106	H04N 21/63 (2011.01)
3746045	A23L 33/16 (2016.01) A61K 9/00 (2006.01) A61K 33/10 (2006.01)
3746444	A61K 31/519 (2006.01) A61P 31/14 (2006.01) C07D 487/04 (2006.01)
3749668	B01J 19/00 (2006.01) C07D 471/04 (2006.01)
3749372	A61K 47/68 (2017.01) A61P 35/00 (2006.01) C07K 14/54 (2006.01) C07K 16/18 (2006.01)
3743511	A61K 35/17 (2015.01) C12N 5/0783 (2010.01)

Broj objave evropske prijava patenta (97)	MKP (51)
3737387	A61K 31/712 (2006.01) C12N 15/113 (2010.01)
3737761	C07K 14/47 (2006.01) C12N 15/113 (2010.01)
3743406	A61P 11/00 (2006.01) C07C 1/00 (2006.01) C07D 213/72 (2006.01) C07D 309/10 (2006.01) C07D 401/12 (2006.01) C07D 405/12 (2006.01) C07D 413/12 (2006.01) C07D 417/12 (2006.01)
3749327	A61K 31/565 (2006.01) A61P 15/18 (2006.01)
3740219	A61K 35/74 (2015.01) A61K 39/395 (2006.01) A61P 35/00 (2006.01)
3740220	A61K 35/74 (2015.01) A61K 39/395 (2006.01) A61P 35/00 (2006.01)
3752018	A41D 1/22 (2018.01)
3752177	A61K 31/7105 (2006.01) A61K 31/713 (2006.01) A61K 38/20 (2006.01) A61K 39/21 (2006.01) C07K 14/54 (2006.01) C07K 14/55 (2006.01) C07K 14/565 (2006.01) C07K 14/765 (2006.01) C12N 15/62 (2006.01)
3737679	C07C 237/06 (2006.01) C07D 239/34 (2006.01) C07D 263/06 (2006.01) C07D 413/14 (2006.01)
3737694	A61K 47/54 (2017.01) A61K 47/60 (2017.01) C07K 14/54 (2006.01) C07K 16/28 (2006.01)
3740479	A61K 31/506 (2006.01) A61K 31/5377 (2006.01) A61K 31/5386 (2006.01) A61P 35/00 (2006.01) C07D 403/12 (2006.01) C07D 413/12 (2006.01) C12N 15/10 (2006.01)
3740264	A61M 5/142 (2006.01) A61M 5/145 (2006.01) A61M 5/315 (2006.01)
3752648	B09B 3/00 (2006.01) C04B 33/04 (2006.01) C04B 33/132 (2006.01)

Broj objave evropske prijave patenta (97)	MKP (51)
	C04B 33/135 (2006.01) C04B 33/30 (2006.01) C04B 33/32 (2006.01) C12R 1/00 (2006.01)
3735219	A61K 9/00 (2006.01) A61K 9/10 (2006.01) A61K 9/16 (2006.01) A61K 9/50 (2006.01)
3735399	A61J 1/14 (2006.01) B08B 11/00 (2006.01) C03C 23/00 (2006.01) G01N 17/00 (2006.01) G01N 21/90 (2006.01) G01N 33/38 (2006.01)
3735270	A61K 39/395 (2006.01) A61K 39/42 (2006.01) A61P 31/14 (2006.01) C07K 16/10 (2006.01)
3737743	A61K 35/17 (2015.01) C12N 5/0783 (2010.01)
3737687	A61K 31/58 (2006.01) A61P 25/00 (2006.01) C07J 73/00 (2006.01) C07J 75/00 (2006.01)
3740575	A61K 31/7115 (2006.01) A61K 31/712 (2006.01) A61K 31/7125 (2006.01) C12N 15/113 (2010.01)
3740480	A61P 35/00 (2006.01) C07D 239/74 (2006.01) C07D 239/86 (2006.01) C07D 239/88 (2006.01) C07D 239/94 (2006.01) C07D 401/12 (2006.01) C07D 403/12 (2006.01) C07D 417/12 (2006.01) C07D 491/048 (2006.01)
3740481	A61K 31/4196 (2006.01) A61P 9/04 (2006.01) C07D 231/14 (2006.01) C07D 271/06 (2006.01) C07D 401/12 (2006.01) C07D 403/12 (2006.01) C07D 413/04 (2006.01) C07D 413/12 (2006.01) C07D 413/14 (2006.01) C07D 417/12 (2006.01)
3749360	A61K 39/395 (2006.01) A61P 35/00 (2006.01) C07K 16/28 (2006.01)
3743413	A61K 31/404 (2006.01) A61P 35/00 (2006.01) C07C 215/48 (2006.01) C07D 209/12 (2006.01)

Broj objave evropske prijava patenta (97)	MKP (51)
	C07D 209/30 (2006.01) C07D 313/08 (2006.01) C07D 333/64 (2006.01) C07D 409/12 (2006.01) C07D 487/04 (2006.01)
3743262	B29C 64/245 (2017.01) B29C 64/40 (2017.01) B33Y 10/00 (2015.01) B33Y 30/00 (2015.01)
3755708	A61K 38/08 (2019.01) C07K 7/06 (2006.01) C07K 14/47 (2006.01)
3740221	A61K 35/74 (2015.01) A61K 39/395 (2006.01) A61P 35/00 (2006.01)
3737241	A23K 20/10 (2016.01) A23K 20/105 (2016.01) A23K 20/147 (2016.01) A23K 20/158 (2016.01) A23K 20/163 (2016.01) A23K 50/90 (2016.01) A61K 36/00 (2006.01) A61K 36/02 (2006.01) A61K 36/05 (2006.01) A61K 36/06 (2006.01) A61K 36/53 (2006.01) A61K 36/886 (2006.01)
3752487	A61K 31/4427 (2006.01) A61P 35/00 (2006.01) C07D 213/72 (2006.01)
3752151	A61K 31/166 (2006.01) A61K 31/282 (2006.01) A61K 31/337 (2006.01) A61K 31/436 (2006.01) A61K 31/439 (2006.01) A61K 31/44 (2006.01) A61K 31/4433 (2006.01) A61K 31/501 (2006.01) A61K 31/506 (2006.01) A61K 31/7135 (2006.01) A61K 39/395 (2006.01) A61K 45/06 (2006.01) A61P 35/00 (2006.01) A61P 35/04 (2006.01)
3743068	A61K 31/4375 (2006.01) A61K 31/517 (2006.01) A61P 35/00 (2006.01) C07D 239/88 (2006.01) C07D 471/04 (2006.01)
3743070	A61K 31/47 (2006.01) A61K 31/4709 (2006.01) A61P 35/00 (2006.01) C07D 215/22 (2006.01) C07D 401/04 (2006.01) C07D 401/06 (2006.01) C07D 401/12 (2006.01) C07D 405/04 (2006.01)

Broj objave evropske prijave patenta (97)	MKP (51)
	C07D 405/12 (2006.01) C07D 413/04 (2006.01) C07D 413/12 (2006.01)
3746429	C07D 213/61 (2006.01) C07D 401/04 (2006.01)
3746136	A61K 48/00 (2006.01) C07K 14/755 (2006.01) C12N 15/867 (2006.01)
3755339	A61K 31/57 (2006.01) A61P 25/30 (2006.01)
3735412	A61K 35/12 (2015.01) C07D 471/04 (2006.01) C07D 487/04 (2006.01) C07D 519/00 (2006.01) C12N 5/0789 (2010.01)
3735297	A61K 31/454 (2006.01) A61K 38/16 (2006.01) A61P 9/00 (2006.01) A61P 25/28 (2006.01) A61P 35/00 (2006.01) C07D 487/06 (2006.01)
3737420	A61K 47/68 (2017.01) C07J 71/00 (2006.01)
3737377	A61K 31/47 (2006.01) A61K 31/496 (2006.01)
3742886	A01G 17/06 (2006.01)
3755715	A61P 37/06 (2006.01) C07K 16/24 (2006.01)
3737701	A61K 39/00 (2006.01) A61K 39/395 (2006.01) A61P 25/00 (2006.01) A61P 25/28 (2006.01) A61P 35/02 (2006.01) C07K 16/28 (2006.01)
3746126	A61K 31/138 (2006.01) A61K 31/216 (2006.01) A61K 45/06 (2006.01) A61P 11/00 (2006.01) A61P 25/00 (2006.01)
3729088	G01N 33/542 (2006.01) G01N 33/58 (2006.01) G01N 33/68 (2006.01)
3720856	A61K 31/4188 (2006.01) A61P 25/00 (2006.01) C07D 487/14 (2006.01)
3724225	A61K 35/17 (2015.01) A61K 39/00 (2006.01) A61P 35/00 (2006.01)

Broj objave evropske prijave patenta (97)	MKP (51)
	C07K 16/18 (2006.01) C07K 16/46 (2006.01)
3728207	A61K 31/517 (2006.01) A61P 29/00 (2006.01) A61P 35/00 (2006.01) C07D 239/88 (2006.01) C07D 401/12 (2006.01) C07D 401/14 (2006.01) C07D 405/12 (2006.01) C07D 405/14 (2006.01) C07D 413/14 (2006.01) C07D 417/14 (2006.01)
3717509	C07K 14/705 (2006.01) C12N 15/85 (2006.01)
3717651	C12N 15/85 (2006.01)
3729527	H01G 9/04 (2006.01) H01L 35/22 (2006.01)
3727388	A61K 31/506 (2006.01) C07D 487/04 (2006.01) C07F 9/09 (2006.01)
3728606	A01N 63/02 (2006.01) C07K 14/32 (2006.01) C07K 14/325 (2006.01) C12N 15/31 (2006.01) C12N 15/32 (2006.01) C12N 15/82 (2006.01)
3727428	A61K 38/45 (2006.01) A61P 3/00 (2006.01)
3735226	A61K 9/127 (2006.01) A61K 31/4196 (2006.01)
3732164	A61K 31/44 (2006.01) A61P 11/00 (2006.01) A61P 37/00 (2006.01) C07D 213/61 (2006.01) C07D 213/89 (2006.01)
3724192	A61K 31/55 (2006.01) A61P 25/00 (2006.01) A61P 25/24 (2006.01) C07D 223/06 (2006.01) C07D 223/10 (2006.01) C07D 487/04 (2006.01) C07D 487/14 (2006.01)
3724190	A61K 31/519 (2006.01) A61K 31/53 (2006.01) A61P 35/00 (2006.01) C07D 471/04 (2006.01) C07D 487/04 (2006.01)
3713930	A61K 31/501 (2006.01) A61P 29/00 (2006.01) A61P 37/00 (2006.01) C07D 401/12 (2006.01)

Broj objave evropske prijave patenta (97)	MKP (51)
	C07D 401/14 (2006.01) C07D 487/04 (2006.01)
3720582	A63H 33/00 (2006.01) C08K 3/26 (2006.01)
3728318	C07K 16/28 (2006.01) C12Q 1/6851 (2018.01)
3727392	A61K 31/519 (2006.01) A61K 31/52 (2006.01) A61K 31/5377 (2006.01) A61K 31/675 (2006.01) A61K 38/05 (2006.01) A61K 38/13 (2006.01) A61K 38/47 (2006.01) A61K 39/395 (2006.01) A61P 3/00 (2006.01) A61P 21/00 (2006.01)
3729085	G01N 33/50 (2006.01) G01N 33/68 (2006.01)
3724337	C12N 9/10 (2006.01) C12N 9/18 (2006.01) C12N 15/113 (2010.01)
3732178	A61K 31/5513 (2006.01) A61K 47/68 (2017.01) A61P 35/00 (2006.01) C07D 471/04 (2006.01) C07D 487/04 (2006.01)
3732200	A61P 35/00 (2006.01) C07K 16/28 (2006.01) C07K 16/30 (2006.01) C07K 16/46 (2006.01)
3727445	A61K 39/29 (2006.01) A61K 39/295 (2006.01) A61P 31/20 (2006.01)
3735648	G06F 21/62 (2013.01)
3727446	A61K 39/29 (2006.01) C07K 14/02 (2006.01) C12N 7/00 (2006.01)
3713837	B63B 35/34 (2006.01)
3728284	A61K 31/56 (2006.01) A61K 31/57 (2006.01) A61K 31/575 (2006.01) A61K 31/58 (2006.01) A61P 25/00 (2006.01) C07J 1/00 (2006.01) C07J 3/00 (2006.01) C07J 5/00 (2006.01) C07J 7/00 (2006.01) C07J 9/00 (2006.01) C07J 13/00 (2006.01) C07J 17/00 (2006.01) C07J 21/00 (2006.01)

Broj objave evropske prijava patenta (97)	MKP (51)
	C07J 41/00 (2006.01) C07J 43/00 (2006.01) C07J 51/00 (2006.01) C07J 71/00 (2006.01)
3728285	A61K 31/57 (2006.01) A61P 25/00 (2006.01) C07J 61/00 (2006.01) C07J 63/00 (2006.01)
3731866	A61K 31/4184 (2006.01) A61K 31/454 (2006.01) A61K 31/496 (2006.01) A61K 31/502 (2006.01) A61K 31/5025 (2006.01) A61K 31/517 (2006.01) A61K 31/55 (2006.01) A61K 31/555 (2006.01) A61K 39/395 (2006.01) A61K 45/06 (2006.01) A61P 35/00 (2006.01)
3732167	A61K 31/4192 (2006.01) A61P 13/00 (2006.01) C07D 249/06 (2006.01) C07D 401/04 (2006.01) C07D 401/06 (2006.01) C07D 401/12 (2006.01) C07D 403/06 (2006.01) C07D 403/12 (2006.01) C07D 417/04 (2006.01) C07D 417/12 (2006.01)
3735566	F41A 21/30 (2006.01) F41A 21/32 (2006.01) F41A 21/36 (2006.01)
3737620	B65D 75/58 (2006.01)
3746569	C07K 14/16 (2006.01) C12Q 1/6851 (2018.01)
3752153	A61K 31/337 (2006.01) A61K 31/475 (2006.01) A61K 31/506 (2006.01) A61K 31/519 (2006.01) A61K 31/555 (2006.01) A61K 31/7048 (2006.01) A61K 31/7068 (2006.01) A61K 33/24 (2019.01) A61P 35/00 (2006.01)
3740216	A61K 35/17 (2015.01) A61P 35/00 (2006.01) C12N 5/10 (2006.01) C12N 15/867 (2006.01)
3749667	A61K 31/439 (2006.01) A61P 25/04 (2006.01) A61P 29/00 (2006.01) C07D 453/02 (2006.01)
3749301	A61K 31/404 (2006.01) A61K 31/443 (2006.01)

Broj objave evropske prijava patenta (97)	MKP (51)
	A61K 31/4439 (2006.01) A61K 31/47 (2006.01) A61P 11/00 (2006.01)
3749352	A61K 31/454 (2006.01) A61K 39/00 (2006.01) A61K 39/395 (2006.01) A61K 45/06 (2006.01) A61P 35/00 (2006.01)
3752148	A61K 31/4168 (2006.01) A61K 31/685 (2006.01) A61P 31/04 (2006.01) A61P 31/06 (2006.01)
3755688	A61K 31/496 (2006.01) A61P 25/00 (2006.01) A61P 25/16 (2006.01) A61P 25/18 (2006.01) A61P 25/24 (2006.01) A61P 25/28 (2006.01) C07D 209/10 (2006.01) C07D 235/10 (2006.01)
3752183	A61K 39/085 (2006.01) A61P 31/04 (2006.01)
3756253	H02H 9/00 (2006.01)
3759800	H02K 1/27 (2006.01) H02K 7/14 (2006.01) H02K 21/22 (2006.01)
3737762	A61K 48/00 (2006.01) C12N 15/113 (2010.01) C12N 15/90 (2006.01)
3740483	C07D 241/44 (2006.01) C07D 403/12 (2006.01) C07D 405/14 (2006.01) C07D 491/048 (2006.01) C07D 498/08 (2006.01) C12N 15/00 (2006.01)
3752488	C07D 213/75 (2006.01) C07D 513/04 (2006.01)
3749752	A61K 35/12 (2015.01) C12N 5/071 (2010.01) C12N 5/074 (2010.01) G01N 33/50 (2006.01)
3743159	A61K 39/00 (2006.01) A61P 35/00 (2006.01) C07K 16/28 (2006.01)
3743728	G01N 33/68 (2006.01)
3749753	C12N 5/0783 (2010.01)
3753253	H04N 19/107 (2014.01) H04N 19/117 (2014.01)

Broj objave evropske prijava patenta (97)	MKP (51)
	H04N 19/147 (2014.01) H04N 19/159 (2014.01) H04N 19/176 (2014.01) H04N 19/46 (2014.01) H04N 19/503 (2014.01) H04N 19/82 (2014.01) H04N 19/85 (2014.01)
3752510	A61K 31/437 (2006.01) A61P 11/00 (2006.01) C07D 513/22 (2006.01) C07D 515/22 (2006.01)
3752146	A61K 31/4155 (2006.01) A61K 31/437 (2006.01) A61K 31/519 (2006.01) A61P 37/00 (2006.01)
3752189	A61K 31/496 (2006.01) A61K 39/395 (2006.01) A61P 35/00 (2006.01)
3755324	A61K 31/4192 (2006.01)
3750194	H01L 35/28 (2006.01) H01L 35/34 (2006.01) H01L 37/02 (2006.01)
3750208	H01M 10/36 (2010.01)
3728638	C12Q 1/6883 (2018.01)
3746117	A61K 39/00 (2006.01) A61K 39/395 (2006.01) A61P 35/02 (2006.01) C07K 16/28 (2006.01) C07K 16/30 (2006.01)
3749363	A61K 9/00 (2006.01) A61K 39/395 (2006.01) C07K 16/28 (2006.01) C07K 16/40 (2006.01)
3758754	A61K 9/14 (2006.01) A61K 9/19 (2006.01) A61K 31/195 (2006.01) A61K 31/198 (2006.01) A61K 47/10 (2017.01) A61K 47/12 (2006.01) A61K 47/26 (2006.01) A61K 47/32 (2006.01) A61K 47/38 (2006.01)
3752267	B01D 29/35 (2006.01) B01D 29/90 (2006.01) B01D 29/92 (2006.01) B01D 35/06 (2006.01)
3749734	C10B 3/00 (2006.01) C10B 43/14 (2006.01) C10B 49/00 (2006.01) C10J 3/26 (2006.01) C10J 3/42 (2006.01)

Broj objave evropske prijava patenta (97)	MKP (51)
	C10J 3/72 (2006.01)
3752253	A61K 8/49 (2006.01) A61K 31/4155 (2006.01) A61P 17/14 (2006.01) A61Q 7/00 (2006.01) C07D 277/54 (2006.01) C07D 417/12 (2006.01)
3755455	A61L 2/00 (2006.01) B01D 61/14 (2006.01) B01D 61/16 (2006.01) B01D 67/00 (2006.01) B01D 69/02 (2006.01) B01D 69/08 (2006.01) B01D 71/10 (2006.01) B01D 71/12 (2006.01) B01D 71/16 (2006.01) B01D 71/20 (2006.01) C12N 7/02 (2006.01)
3755703	A61K 31/444 (2006.01) A61K 31/506 (2006.01) A61P 35/00 (2006.01) C07D 239/28 (2006.01) C07D 401/14 (2006.01) C07D 403/12 (2006.01) C07D 403/14 (2006.01) C07D 487/04 (2006.01) C07D 487/08 (2006.01)
3759083	A61K 31/517 (2006.01) A61P 1/16 (2006.01) A61P 31/12 (2006.01) A61P 35/00 (2006.01) A61P 37/06 (2006.01) C07D 239/95 (2006.01)
3743910	G10G 5/00 (2006.01)
3743417	A61K 31/4375 (2006.01) A61K 31/4427 (2006.01) A61P 35/00 (2006.01) C07D 401/12 (2006.01) C07D 401/14 (2006.01) C07D 413/14 (2006.01) C07D 471/04 (2006.01) C07D 491/147 (2006.01)
3755702	A61K 31/4985 (2006.01) A61P 35/00 (2006.01) A61P 37/00 (2006.01) C07D 487/04 (2006.01)
3755403	A61M 5/315 (2006.01)
3755404	A61M 5/315 (2006.01)
3755499	B23Q 17/20 (2006.01) B23Q 17/22 (2006.01) B23Q 17/24 (2006.01) B29C 64/188 (2017.01)

Broj objave evropske prijave patenta (97)	MKP (51)
	G06T 7/33 (2017.01)
3759096	A61K 31/513 (2006.01) A61P 35/00 (2006.01) C07D 403/04 (2006.01)
3759139	A61K 39/00 (2006.01) A61P 37/06 (2006.01) C07K 16/28 (2006.01)
3759098	A61K 31/505 (2006.01) A61K 31/506 (2006.01) C07B 59/00 (2006.01) C07D 239/69 (2006.01) C07D 401/12 (2006.01) C07D 401/14 (2006.01) C07D 403/12 (2006.01) C07D 413/12 (2006.01)
3759088	A61K 31/53 (2006.01) A61P 25/00 (2006.01) A61P 25/16 (2006.01) A61P 25/24 (2006.01) A61P 25/28 (2006.01) C07D 251/34 (2006.01) C07D 401/04 (2006.01) C07D 403/04 (2006.01) C07D 405/04 (2006.01) C07D 409/04 (2006.01) C07D 417/04 (2006.01)
3752141	A61K 31/198 (2006.01) A61P 25/00 (2006.01)
3752251	A61K 31/69 (2006.01) A61P 29/00 (2006.01) A61P 35/00 (2006.01) C07F 5/02 (2006.01)
3752600	A61K 35/17 (2015.01) A61K 39/00 (2006.01) A61P 35/00 (2006.01) C12N 5/0783 (2010.01)
3758722	A61K 9/50 (2006.01) A61K 35/00 (2006.01) A61K 35/39 (2015.01) A61L 27/38 (2006.01) A61L 27/54 (2006.01) A61P 5/48 (2006.01) A61P 5/50 (2006.01)
3755696	A61K 31/416 (2006.01) A61P 17/06 (2006.01) A61P 19/04 (2006.01) A61P 35/00 (2006.01) C07D 401/14 (2006.01) C07D 403/04 (2006.01) C07D 403/14 (2006.01) C07D 405/14 (2006.01) C07D 487/04 (2006.01)
3752616	A61K 48/00 (2006.01) C12N 15/113 (2010.01)

Broj objave evropske prijava patenta (97)	MKP (51)
	C12N 15/90 (2006.01)
3737839	F01K 7/16 (2006.01) F01K 11/02 (2006.01) F01K 19/08 (2006.01) F22B 1/16 (2006.01) F22B 3/04 (2006.01)
3749767	A61K 31/712 (2006.01) A61K 31/7125 (2006.01) A61P 7/06 (2006.01) C12N 15/113 (2010.01)
3759111	A61K 31/4985 (2006.01) A61P 35/00 (2006.01) C07D 487/04 (2006.01)
3759112	A61K 31/519 (2006.01) A61P 9/00 (2006.01) A61P 25/00 (2006.01) A61P 29/00 (2006.01) A61P 35/00 (2006.01) C07D 487/04 (2006.01) C07D 519/00 (2006.01)
3759490	G01N 15/00 (2006.01) G01N 33/543 (2006.01)
3728766	E05B 5/00 (2006.01) E05B 5/02 (2006.01) E05B 47/00 (2006.01)
3752532	C07K 16/28 (2006.01)
3759467	B01D 15/18 (2006.01) G01N 21/35 (2014.01) G01N 21/3577 (2014.01) G01N 21/552 (2014.01) G01N 21/84 (2006.01) G01N 30/46 (2006.01) G01N 30/78 (2006.01) G01N 30/86 (2006.01) G01N 30/88 (2006.01)
3758708	A61K 31/553 (2006.01) A61P 11/06 (2006.01)
3736479	F16L 27/08 (2006.01) F16L 27/12 (2006.01) F16L 51/00 (2006.01) F16L 51/02 (2006.01)
3749768	A61K 31/712 (2006.01) A61K 31/7125 (2006.01) A61P 7/06 (2006.01) C12N 15/113 (2010.01)
3743442	A61P 31/16 (2006.01) C07K 16/10 (2006.01)

Broj objave evropske prijava patenta (97)	MKP (51)
3735548	E03C 1/042 (2006.01) F16L 5/10 (2006.01)
3743086	A23L 33/135 (2016.01) A61K 35/74 (2015.01) A61K 39/02 (2006.01) A61P 1/00 (2006.01) A61P 3/10 (2006.01) A61P 11/06 (2006.01) A61P 17/06 (2006.01) A61P 19/02 (2006.01) A61P 35/00 (2006.01) A61P 37/00 (2006.01) A61P 43/00 (2006.01)
3720442	A61K 31/4704 (2006.01) A61K 31/4709 (2006.01) A61P 35/00 (2006.01) A61P 35/02 (2006.01)
3746047	A61K 9/00 (2006.01) A61K 31/4196 (2006.01) A61K 47/34 (2017.01)
3737367	A61K 31/351 (2006.01) A61K 31/40 (2006.01) A61K 31/4025 (2006.01) C07D 405/00 (2006.01) C07D 405/02 (2006.01) C07D 405/04 (2006.01)
3735252	A61K 31/712 (2006.01) A61K 31/7125 (2006.01) A61K 31/713 (2006.01) C07H 21/02 (2006.01) C12N 15/113 (2010.01)
3737366	A61K 31/341 (2006.01) A61K 31/395 (2006.01) A61K 31/4035 (2006.01) C07D 209/44 (2006.01) C07D 209/46 (2006.01) C07D 307/52 (2006.01)
3737748	C12N 9/02 (2006.01) C12P 19/18 (2006.01) C12Q 1/26 (2006.01) C12Q 1/6806 (2018.01) C12Q 1/6827 (2018.01) C12Q 1/6869 (2018.01)
3736568	C07D 239/557 (2006.01) C07H 19/073 (2006.01) G01N 30/26 (2006.01) G01N 30/34 (2006.01) G01N 30/88 (2006.01)
3737421	A61K 47/68 (2017.01) C07K 16/28 (2006.01)
3737425	A61L 2/18 (2006.01) A61L 2/238 (2006.01)

Broj objave evropske prijava patenta (97)	MKP (51)
	C01B 11/04 (2006.01)
3740475	C07D 401/04 (2006.01) C07D 498/04 (2006.01) C07F 5/02 (2006.01)
3740571	C12N 15/09 (2006.01) C12N 15/63 (2006.01) C12N 15/64 (2006.01) C12N 15/66 (2006.01) C12N 15/86 (2006.01)
3743273	B32B 15/04 (2006.01) B32B 27/04 (2006.01) H01B 5/10 (2006.01) H01B 7/17 (2006.01) H02G 1/02 (2006.01) H02G 1/04 (2006.01) H02G 7/02 (2006.01) H02G 7/04 (2006.01) H02G 7/05 (2006.01) H02G 15/18 (2006.01)
3746462	A61K 39/12 (2006.01) A61K 39/155 (2006.01) C07K 14/005 (2006.01) C07K 14/135 (2006.01) C12N 15/45 (2006.01)
3746090	A61K 31/7105 (2006.01) A61K 31/7115 (2006.01) A61K 39/155 (2006.01) A61P 31/14 (2006.01)
3743065	A61K 31/403 (2006.01) A61K 31/404 (2006.01) A61K 31/4439 (2006.01) C07D 209/42 (2006.01) C07D 403/12 (2006.01)
3743916	G10L 19/00 (2013.01) G10L 19/02 (2013.01) G10L 19/16 (2013.01) H04N 19/00 (2014.01)
3746091	A61K 9/52 (2006.01) A61K 31/785 (2006.01) A61P 1/12 (2006.01) C08F 212/14 (2006.01) C08F 212/36 (2006.01)
3746434	A61K 31/435 (2006.01) A61P 9/04 (2006.01) C07D 403/04 (2006.01)
3746100	A61K 35/76 (2015.01) A61K 38/17 (2006.01) A61K 48/00 (2006.01) A61M 1/36 (2006.01) A61M 5/14 (2006.01)
3747471	A61K 31/135 (2006.01) A61K 31/397 (2006.01)

Broj objave evropske prijava patenta (97)	MKP (51)
	A61K 31/403 (2006.01) A61K 31/4245 (2006.01) A61K 31/426 (2006.01) A61K 31/496 (2006.01) A61K 45/00 (2006.01) A61P 9/10 (2006.01) A61P 27/02 (2006.01)
3747888	A61K 31/437 (2006.01) A61K 31/4985 (2006.01) A61K 31/506 (2006.01) A61P 3/10 (2006.01) A61P 9/04 (2006.01) A61P 9/12 (2006.01) A61P 43/00 (2006.01) C07D 487/04 (2006.01) C07D 498/04 (2006.01) C07D 519/00 (2006.01)
3745935	A47K 10/32 (2006.01) A47K 10/34 (2006.01) A47K 10/38 (2006.01)
3749756	C12N 7/00 (2006.01) C12N 15/86 (2006.01) C12Q 1/70 (2006.01)
3749745	C12M 1/00 (2006.01) C12M 3/00 (2006.01) C12N 5/071 (2010.01)
3752498	C07D 401/14 (2006.01) C07D 471/04 (2006.01)
3750196	H01L 41/02 (2006.01) H01L 41/04 (2006.01) H01L 41/08 (2006.01) H02K 7/14 (2006.01) H02N 2/10 (2006.01) H02N 2/14 (2006.01)
3723777	A61K 9/19 (2006.01) A61K 35/74 (2015.01) A61K 35/741 (2015.01) A61P 1/00 (2006.01) A61P 43/00 (2006.01)
3756670	A61K 9/14 (2006.01) A61K 9/16 (2006.01) A61K 9/20 (2006.01) A61K 9/48 (2006.01) A61K 31/4965 (2006.01) A61K 47/26 (2006.01) A61K 47/36 (2006.01) A61P 7/00 (2006.01) A61P 7/02 (2006.01) A61P 9/08 (2006.01) A61P 11/08 (2006.01) A61P 43/00 (2006.01)
3758710	A61K 9/14 (2006.01) A61K 9/19 (2006.01) A61K 31/675 (2006.01)

Broj objave evropske prijave patenta (97)	MKP (51)
3755312	A61K 31/137 (2006.01) A61K 31/485 (2006.01) A61P 25/00 (2006.01) A61P 25/18 (2006.01) A61P 25/24 (2006.01) A61P 25/28 (2006.01) A61P 25/30 (2006.01)
3755721	C07K 16/28 (2006.01) C07K 16/32 (2006.01)
3755311	A61K 31/015 (2006.01) A61K 31/03 (2006.01) C07C 211/38 (2006.01)
3755803	C12N 15/86 (2006.01) C12N 15/864 (2006.01) C12N 15/87 (2006.01)
3755348	A61K 35/17 (2015.01) A61K 39/395 (2006.01) A61K 48/00 (2006.01)
3755148	A01N 37/10 (2006.01) A61K 31/235 (2006.01)
3755805	A61K 9/00 (2006.01) A61K 38/17 (2006.01) A61K 48/00 (2006.01) A61P 25/00 (2006.01) A61P 27/16 (2006.01) C07K 14/435 (2006.01) C12N 15/65 (2006.01) C12N 15/86 (2006.01)
3758729	A61K 38/00 (2006.01) A61K 38/20 (2006.01) C07K 14/54 (2006.01) C12N 15/24 (2006.01)
3760616	A61K 31/513 (2006.01) A61P 3/00 (2006.01) A61P 27/04 (2006.01) A61P 35/00 (2006.01) A61P 37/02 (2006.01) A61P 37/08 (2006.01) C07D 239/22 (2006.01)
3760624	A61K 31/4155 (2006.01) A61P 3/10 (2006.01) A61P 43/00 (2006.01) C07D 403/12 (2006.01)
3759125	A61K 38/17 (2006.01) A61K 39/395 (2006.01) C07K 14/43 (2006.01) C07K 14/435 (2006.01) C07K 14/705 (2006.01)
3759454	G01M 11/00 (2006.01)
3758495	A01N 57/12 (2006.01) A01N 57/20 (2006.01)

Broj objave evropske prijava patenta (97)	MKP (51)
	A61K 31/661 (2006.01)
3759633	G06F 3/0481 (2013.01) G06F 21/50 (2013.01) H04L 12/22 (2006.01) H04L 12/24 (2006.01) H04L 29/06 (2006.01) H04L 29/08 (2006.01)
3759217	C12N 9/14 (2006.01) C12N 9/22 (2006.01) C12N 15/00 (2006.01) C12N 15/62 (2006.01) C12N 15/63 (2006.01)
3760612	C07C 253/34 (2006.01) C07C 255/03 (2006.01)
3759226	C12N 15/90 (2006.01)
3760582	B01D 1/22 (2006.01) B01D 9/02 (2006.01) C01B 21/086 (2006.01) C01B 21/096 (2006.01) C07C 311/48 (2006.01)
3760615	A01N 47/02 (2006.01) A01P 5/00 (2006.01) A01P 7/04 (2006.01) A61K 31/4155 (2006.01) A61K 31/455 (2006.01) A61P 33/10 (2006.01) A61P 33/14 (2006.01) C07D 213/81 (2006.01) C07D 213/82 (2006.01) C07D 409/12 (2006.01)
3760619	A61K 31/517 (2006.01) A61K 31/519 (2006.01) A61K 31/53 (2006.01) A61P 3/00 (2006.01) A61P 27/02 (2006.01) A61P 35/00 (2006.01) A61P 37/06 (2006.01) A61P 37/08 (2006.01) C07D 239/70 (2006.01) C07D 239/80 (2006.01) C07D 253/10 (2006.01) C07D 487/04 (2006.01) C07D 491/048 (2006.01) C07D 491/052 (2006.01)
3758712	A61K 31/70 (2006.01) A61K 31/7088 (2006.01) A61K 31/7115 (2006.01)
3758713	A61K 31/70 (2006.01) A61K 31/7088 (2006.01) A61K 31/7115 (2006.01)
3687506	A61P 9/00 (2006.01) A61P 13/12 (2006.01) A61P 25/28 (2006.01) A61P 37/00 (2006.01)

Broj objave evropske prijave patenta (97)	MKP (51)
	C07D 209/08 (2006.01) C07D 231/56 (2006.01) C07D 235/08 (2006.01) C07D 239/70 (2006.01) C07D 261/20 (2006.01) C07D 307/79 (2006.01) C07D 307/81 (2006.01) C07D 333/54 (2006.01) C07D 403/10 (2006.01) C07D 405/12 (2006.01) C07D 407/04 (2006.01) C07D 407/10 (2006.01) C07D 409/12 (2006.01) C07D 471/04 (2006.01) C07D 487/04 (2006.01)
3740201	A61K 31/13 (2006.01) A61K 31/785 (2006.01) A61P 13/12 (2006.01)
3737736	A23D 9/00 (2006.01) A23D 9/007 (2006.01) B01D 11/02 (2006.01) C11B 1/10 (2006.01) C11B 3/12 (2006.01) C11B 3/14 (2006.01)
3680916	A61B 5/00 (2006.01) G16H 40/67 (2018.01) G16H 80/00 (2018.01) H04L 29/08 (2006.01) H04N 7/15 (2006.01)
3689910	A61K 31/00 (2006.01) A61K 39/395 (2006.01) A61K 45/06 (2006.01) A61K 47/68 (2017.01) A61P 35/00 (2006.01) C07K 16/28 (2006.01) C07K 16/30 (2006.01)
3730520	A61K 47/68 (2017.01) A61P 35/00 (2006.01) C07K 16/28 (2006.01)
3695743	A45D 1/00 (2006.01) A45D 1/04 (2006.01) A45D 1/10 (2006.01) A45D 1/18 (2006.01) A45D 1/28 (2006.01) A45D 2/00 (2006.01) A45D 6/04 (2006.01)
3663291	C07D 249/08 (2006.01) C07D 403/12 (2006.01) C07D 413/12 (2006.01)
3679922	A61K 9/00 (2006.01) A61M 5/28 (2006.01) A61M 5/31 (2006.01) A61M 5/315 (2006.01) A61P 27/02 (2006.01) A61P 43/00 (2006.01)

Broj objave evropske prijave patenta (97)	MKP (51)
3696520	G01H 1/00 (2006.01) G01H 9/00 (2006.01)
3701959	A61K 35/76 (2015.01) C12N 5/10 (2006.01) C12N 15/85 (2006.01) C12N 15/86 (2006.01)
3689379	A61K 9/00 (2006.01) A61K 9/14 (2006.01) A61K 9/16 (2006.01) A61K 31/00 (2006.01) A61K 31/167 (2006.01) A61K 31/194 (2006.01) A61K 31/40 (2006.01) A61K 31/573 (2006.01) A61K 45/06 (2006.01) A61K 47/12 (2006.01) A61K 47/26 (2006.01) A61P 11/00 (2006.01) A61P 11/06 (2006.01) A61P 11/08 (2006.01) A61P 29/00 (2006.01) A61P 43/00 (2006.01)
3701928	A61J 1/10 (2006.01) A61J 1/14 (2006.01) A61J 1/20 (2006.01)
3702717	F28D 1/053 (2006.01) F28F 9/26 (2006.01) F28F 21/08 (2006.01)
3738957	B01D 3/10 (2006.01) B01D 3/14 (2006.01) B01D 3/34 (2006.01) B01D 11/04 (2006.01) C07D 311/82 (2006.01)
3739048	A61K 45/06 (2006.01) A61K 47/54 (2017.01) A61P 9/00 (2006.01) C12N 15/113 (2010.01)
3738979	C07K 16/00 (2006.01) C07K 16/10 (2006.01) C07K 16/28 (2006.01) C07K 16/32 (2006.01)
3738595	A61K 31/7068 (2006.01) A61P 35/00 (2006.01)
3721942	A61P 25/28 (2006.01) C07K 16/18 (2006.01)
3721892	A61K 38/00 (2006.01) A61K 38/16 (2006.01) A61K 38/17 (2006.01) A61P 21/00 (2006.01) A61P 21/04 (2006.01) A61P 21/06 (2006.01) C07K 14/47 (2006.01) C07K 19/00 (2006.01)

Broj objave evropske prijave patenta (97)	MKP (51)
	C12N 15/62 (2006.01)
3730608	C12M 1/04 (2006.01) C12N 5/0783 (2010.01)
3722415	C12M 1/04 (2006.01) C12N 5/0783 (2010.01)
3686541	F41A 3/44 (2006.01) F41A 5/02 (2006.01)
3719014	A61K 31/517 (2006.01) C07D 403/04 (2006.01)
3733582	B66B 5/00 (2006.01)
3730618	A61K 31/7125 (2006.01) C12N 15/113 (2010.01)
3722297	A61K 31/519 (2006.01) A61P 31/18 (2006.01) A61P 31/20 (2006.01) A61P 35/00 (2006.01) C07D 471/04 (2006.01)
3733701	A01K 67/027 (2006.01) A61K 39/00 (2006.01) A61K 39/395 (2006.01) A61P 11/06 (2006.01) C07K 14/54 (2006.01) C07K 14/715 (2006.01) C07K 16/24 (2006.01)
3733664	A01N 43/50 (2006.01) A01N 43/54 (2006.01) A01N 43/60 (2006.01) A61P 33/00 (2006.01) C07D 413/10 (2006.01) C07D 413/12 (2006.01)
3712165	A61K 38/00 (2006.01) C07K 14/47 (2006.01)
3708185	A61K 39/00 (2006.01) A61P 35/02 (2006.01)
3747450	A61K 35/39 (2015.01) A61K 35/74 (2015.01) A61K 38/46 (2006.01)
3715357	A61K 38/04 (2006.01) A61K 39/00 (2006.01) A61P 35/00 (2006.01) C07K 7/08 (2006.01)
3744861	C12Q 1/6886 (2018.01)
3753927	A01N 51/00 (2006.01) A61P 25/00 (2006.01) C07D 231/14 (2006.01) C07D 295/033 (2006.01)

Broj objave evropske prijava patenta (97)	MKP (51)
3722433	C12N 15/85 (2006.01)
3725327	A61K 39/00 (2006.01) A61P 35/00 (2006.01) C07K 14/47 (2006.01) G01N 33/50 (2006.01)
3736283	A61K 39/00 (2006.01) C07K 14/47 (2006.01) C07K 14/635 (2006.01)
3722281	A61K 31/415 (2006.01) A61P 29/00 (2006.01) C07D 231/18 (2006.01)
3744840	A61K 38/48 (2006.01) A61P 7/02 (2006.01) A61P 7/04 (2006.01) A61P 43/00 (2006.01) C07K 14/46 (2006.01) C12N 9/64 (2006.01)
3753567	A61K 38/05 (2006.01) A61P 1/04 (2006.01) A61P 3/10 (2006.01) A61P 5/14 (2006.01) A61P 5/38 (2006.01) A61P 7/00 (2006.01) A61P 7/06 (2006.01) A61P 9/00 (2006.01) A61P 9/10 (2006.01) A61P 11/00 (2006.01) A61P 13/12 (2006.01) A61P 15/00 (2006.01) A61P 17/00 (2006.01) A61P 17/06 (2006.01) A61P 17/14 (2006.01) A61P 19/00 (2006.01) A61P 19/02 (2006.01) A61P 21/02 (2006.01) A61P 21/04 (2006.01) C07K 14/78 (2006.01) C07K 16/28 (2006.01)
3725778	A61K 9/16 (2006.01) A61K 31/4164 (2006.01) A61K 31/4166 (2006.01) A61P 13/08 (2006.01) A61P 15/00 (2006.01) A61P 15/08 (2006.01) A61P 15/14 (2006.01) A61P 35/00 (2006.01) A61P 43/00 (2006.01) C07D 233/86 (2006.01)
3736321	C12C 1/02 (2006.01) C12C 1/027 (2006.01) C12C 1/047 (2006.01) C12C 7/047 (2006.01)
3747265	A01K 7/06 (2006.01) A01M 25/00 (2006.01)

Broj objave evropske prijave patenta (97)	MKP (51)
3725785	A61K 31/45 (2006.01) A61P 11/02 (2006.01) A61P 31/16 (2006.01) C07D 401/06 (2006.01)
3722290	A61K 31/45 (2006.01) A61P 11/02 (2006.01) A61P 31/16 (2006.01) C07D 401/06 (2006.01)
3753570	A61K 38/48 (2006.01) A61K 39/00 (2006.01) A61P 35/00 (2006.01) C07K 7/06 (2006.01) C07K 7/08 (2006.01) G01N 33/50 (2006.01)
3760225	A61K 39/00 (2006.01) A61P 35/00 (2006.01) C07K 14/47 (2006.01) C07K 16/00 (2006.01)
3750557	A61K 39/00 (2006.01) A61P 35/00 (2006.01) C07K 14/47 (2006.01)
3750558	A61K 39/00 (2006.01) A61P 35/00 (2006.01) C07K 14/47 (2006.01)
3750559	A61K 39/00 (2006.01) A61P 35/00 (2006.01) C07K 14/47 (2006.01)
3738606	A61K 38/17 (2006.01) A61K 38/39 (2006.01) A61K 39/00 (2006.01) A61P 35/00 (2006.01) C07K 7/06 (2006.01) C07K 7/08 (2006.01) G01N 33/50 (2006.01)
3738531	A61B 17/00 (2006.01) A61B 17/32 (2006.01) A61B 17/3207 (2006.01)
3736270	A61K 31/4709 (2006.01) A61P 11/00 (2006.01) C07C 311/45 (2006.01) C07D 213/64 (2006.01) C07D 213/71 (2006.01) C07D 215/36 (2006.01) C07D 231/56 (2006.01) C07D 235/28 (2006.01) C07D 401/12 (2006.01) C07D 471/04 (2006.01)
3736267	A61K 31/4709 (2006.01) A61P 11/00 (2006.01) C07C 311/45 (2006.01) C07D 213/64 (2006.01) C07D 213/71 (2006.01) C07D 215/36 (2006.01) C07D 231/56 (2006.01)

Broj objave evropske prijave patenta (97)	MKP (51)
	C07D 235/28 (2006.01) C07D 401/12 (2006.01) C07D 471/04 (2006.01)
3747898	C07K 14/705 (2006.01)
3757104	A61K 31/437 (2006.01) A61P 35/00 (2006.01) C07D 471/04 (2006.01)
3757126	A61K 31/519 (2006.01) A61K 39/395 (2006.01) C07K 16/24 (2006.01)
3750534	A61K 31/223 (2006.01) A61K 31/573 (2006.01)
3750910	A61K 31/56 (2006.01) A61K 31/58 (2006.01) A61P 31/18 (2006.01) C07C 309/65 (2006.01) C07F 5/02 (2006.01) C07J 63/00 (2006.01)
3757112	A61K 9/00 (2006.01) A61K 9/08 (2006.01) A61K 31/7068 (2006.01) A61K 47/16 (2006.01) A61K 47/20 (2006.01) A61K 47/22 (2006.01) A61P 35/00 (2006.01) C07H 19/10 (2006.01)
3750535	A61K 31/232 (2006.01) A61K 31/366 (2006.01) A61K 31/40 (2006.01) A61K 31/505 (2006.01) A61K 45/06 (2006.01) A61P 9/10 (2006.01)
3750536	A61K 31/232 (2006.01) A61K 31/366 (2006.01) A61K 31/40 (2006.01) A61K 31/505 (2006.01) A61K 45/06 (2006.01) A61P 9/10 (2006.01)
3760202	A61K 31/4745 (2006.01) A61P 35/00 (2006.01) C07D 401/12 (2006.01) C07D 471/04 (2006.01)

**INDEKS KLASIFIKACIONIH OZNAKA ZAHTJEVA ZA PROŠIRENJE EVROPSKIH
PRIJAVA PATENTA PREMA MEĐUNARODNOJ KLASIFIKACIJI PATENATA
Index on classification marks on requests for extension of european patent
application in accordance with the international patent classification**

MKP (51)	Broj objave evropske prijava patenta (97)	Naziv pronalaska (54)
A61B 17/00 (2006.01)	3165185	MULTI-HEAD REPOSITORY FOR USE WITH A SURGICAL DEVICE
A61B 17/34 (2006.01)	3165185	MULTI-HEAD REPOSITORY FOR USE WITH A SURGICAL DEVICE
A61B 17/34 (2006.01)	3165186	SURGICAL END EFFECTOR LOADING DEVICE AND TROCAR INTEGRATION
A01H 1/02 (2006.01)	3242549	SEX DETERMINATION GENES AND THEIR USE IN BREEDING
A01H 1/04 (2006.01)	3242549	SEX DETERMINATION GENES AND THEIR USE IN BREEDING
A01H 1/06 (2006.01)	3242549	SEX DETERMINATION GENES AND THEIR USE IN BREEDING
A01H 5/04 (2006.01)	3242549	SEX DETERMINATION GENES AND THEIR USE IN BREEDING
C07K 14/415 (2006.01)	3242549	SEX DETERMINATION GENES AND THEIR USE IN BREEDING
C12N 15/82 (2006.01)	3242549	SEX DETERMINATION GENES AND THEIR USE IN BREEDING
A61M 5/20 (2006.01)	3727516	AUTO-INJECTION DRUG DELIVERY DEVICE
A61M 5/28 (2006.01)	3727516	AUTO-INJECTION DRUG DELIVERY DEVICE
A61M 5/31 (2006.01)	3727516	AUTO-INJECTION DRUG DELIVERY DEVICE
A61M 5/315 (2006.01)	3727516	AUTO-INJECTION DRUG DELIVERY DEVICE
A61M 5/32 (2006.01)	3727516	AUTO-INJECTION DRUG DELIVERY DEVICE
B29B 11/16 (2006.01)	3256299	WIND TURBINE ROTOR BLADE COMPONENTS AND MACHINE FOR MAKING SAME
B29B 13/10 (2006.01)	3256299	WIND TURBINE ROTOR BLADE COMPONENTS AND MACHINE FOR MAKING SAME
B29C 70/54 (2006.01)	3256299	WIND TURBINE ROTOR BLADE COMPONENTS AND MACHINE FOR MAKING SAME
B29D 99/00 (2010.01)	3256299	WIND TURBINE ROTOR BLADE COMPONENTS AND MACHINE FOR MAKING SAME
B65H 45/00 (2006.01)	3256299	WIND TURBINE ROTOR BLADE COMPONENTS AND MACHINE FOR MAKING SAME
A61K 9/00 (2006.01)	3247330	LEVODOPA AND CARBIDOPA INTESTINAL GEL AND METHODS OF USE
A61K 9/10 (2006.01)	3247330	LEVODOPA AND CARBIDOPA INTESTINAL GEL AND METHODS OF USE
A61K 31/195 (2006.01)	3247330	LEVODOPA AND CARBIDOPA INTESTINAL GEL AND METHODS OF USE
A61K 31/198 (2006.01)	3247330	LEVODOPA AND CARBIDOPA INTESTINAL GEL AND METHODS OF USE
A61K 47/38 (2006.01)	3247330	LEVODOPA AND CARBIDOPA INTESTINAL GEL AND METHODS OF USE
C01B 3/02 (2006.01)	3627050	PYROLYSIS PLANT
C09C 1/48 (2006.01)	3627050	PYROLYSIS PLANT
C10B 47/44 (2006.01)	3627050	PYROLYSIS PLANT
C10B 53/07 (2006.01)	3627050	PYROLYSIS PLANT
C10G 1/10 (2006.01)	3627050	PYROLYSIS PLANT
C10L 1/00 (2006.01)	3627050	PYROLYSIS PLANT
F23G 5/027 (2006.01)	3627050	PYROLYSIS PLANT
F23G 5/08 (2006.01)	3627050	PYROLYSIS PLANT
F23G 7/06 (2006.01)	3627050	PYROLYSIS PLANT
F23G 7/12 (2006.01)	3627050	PYROLYSIS PLANT
F23K 1/04 (2006.01)	3627050	PYROLYSIS PLANT
B08B 3/02 (2006.01)	3643414	AN ULTRA-HIGH-PRESSURE WATER JETTING (UHPWJ) HYDRO- BLASTING CLEANING SYSTEM FOR SURFACES OF VERY LARGE DIMENSIONS AND/OR OF COMPLEX SHAPES AND/OR OF DIFFICULT ACCESS AND/OR WITH A HIGH ELEVATION
B08B 9/023 (2006.01)	3643414	AN ULTRA-HIGH-PRESSURE WATER JETTING (UHPWJ) HYDRO- BLASTING CLEANING SYSTEM FOR SURFACES OF VERY LARGE DIMENSIONS AND/OR OF COMPLEX SHAPES AND/OR OF DIFFICULT ACCESS AND/OR WITH A HIGH ELEVATION
A61B 5/0456 (2006.01)	3624056	PROCESSING IMAGE FRAMES OF A SEQUENCE OF CARDIAC IMAGES
G06T 7/246 (2017.01)	3624056	PROCESSING IMAGE FRAMES OF A SEQUENCE OF CARDIAC IMAGES
G06F 3/14 (2006.01)	3746877	METHOD AND DEVICE FOR DISPLAYING SAFETY UNIT SIGNALS WITH INFORMATION REGARDING RELIABILITY OF DISPLAYED SIGNALS
G06F 11/16 (2006.01)	3746877	METHOD AND DEVICE FOR DISPLAYING SAFETY UNIT SIGNALS WITH INFORMATION REGARDING RELIABILITY OF DISPLAYED SIGNALS
G06F 11/32 (2006.01)	3746877	METHOD AND DEVICE FOR DISPLAYING SAFETY UNIT SIGNALS WITH INFORMATION REGARDING RELIABILITY OF DISPLAYED SIGNALS
G09G 5/00 (2006.01)	3746877	METHOD AND DEVICE FOR DISPLAYING SAFETY UNIT SIGNALS WITH INFORMATION REGARDING RELIABILITY OF DISPLAYED SIGNALS

MKP (51)	Broj objave evropske prijava patenta (97)	Naziv pronalaska (54)
F42B 12/10 (2006.01)	3714229	TANDEM-CUMULATIVE SHOT
F42B 12/16 (2006.01)	3714229	TANDEM-CUMULATIVE SHOT
F42B 12/18 (2006.01)	3714229	TANDEM-CUMULATIVE SHOT
G06K 9/00 (2006.01)	3598396	COMPUTER-SUPPORTED METHOD FOR ANALYZING OF PERSONAL ACCIDENT DATA
G07C 5/08 (2006.01)	3598396	COMPUTER-SUPPORTED METHOD FOR ANALYZING OF PERSONAL ACCIDENT DATA
A61B 17/00 (2006.01)	3154187	SURGICAL STAPLER HAVING DOWNSTREAM CURRENT-BASED MOTOR CONTROL
H02P 7/03 (2016.01)	3154187	SURGICAL STAPLER HAVING DOWNSTREAM CURRENT-BASED MOTOR CONTROL
A61B 17/00 (2006.01)	3154186	SURGICAL STAPLER HAVING MOTOR CONTROL BASED ON A DRIVE SYSTEM COMPONENT
H02P 7/00 (2016.01)	3154186	SURGICAL STAPLER HAVING MOTOR CONTROL BASED ON A DRIVE SYSTEM COMPONENT
H02P 7/06 (2006.01)	3154186	SURGICAL STAPLER HAVING MOTOR CONTROL BASED ON A DRIVE SYSTEM COMPONENT
A61B 17/00 (2006.01)	3154188	SURGICAL STAPLER HAVING CURRENT MIRROR-BASED MOTOR CONTROL
G01R 19/00 (2006.01)	3154188	SURGICAL STAPLER HAVING CURRENT MIRROR-BASED MOTOR CONTROL
H02P 7/29 (2016.01)	3154188	SURGICAL STAPLER HAVING CURRENT MIRROR-BASED MOTOR CONTROL
A61B 17/34 (2006.01)	3150150	ADJUSTABLE ACCESS DEVICE FOR USE WITH SURGICAL INSTRUMENTS
A61K 31/444 (2006.01)	3713927	PYRIDINONE DERIVATIVES AND THEIR USE AS SELECTIVE ALK-2 INHIBITORS
A61P 19/10 (2006.01)	3713927	PYRIDINONE DERIVATIVES AND THEIR USE AS SELECTIVE ALK-2 INHIBITORS
C07D 401/14 (2006.01)	3713927	PYRIDINONE DERIVATIVES AND THEIR USE AS SELECTIVE ALK-2 INHIBITORS
C07D 405/14 (2006.01)	3713927	PYRIDINONE DERIVATIVES AND THEIR USE AS SELECTIVE ALK-2 INHIBITORS
C07D 471/04 (2006.01)	3713927	PYRIDINONE DERIVATIVES AND THEIR USE AS SELECTIVE ALK-2 INHIBITORS
F01N 1/16 (2006.01)	3660290	GAS FLOW AND SOUND CONTROL VALVE AND EXHAUST GAS SYSTEM
F01N 1/18 (2006.01)	3660290	GAS FLOW AND SOUND CONTROL VALVE AND EXHAUST GAS SYSTEM
F01N 13/04 (2010.01)	3660290	GAS FLOW AND SOUND CONTROL VALVE AND EXHAUST GAS SYSTEM
F01N 13/08 (2010.01)	3660290	GAS FLOW AND SOUND CONTROL VALVE AND EXHAUST GAS SYSTEM
F16K 1/00 (2006.01)	3660290	GAS FLOW AND SOUND CONTROL VALVE AND EXHAUST GAS SYSTEM
F16K 11/08 (2006.01)	3660290	GAS FLOW AND SOUND CONTROL VALVE AND EXHAUST GAS SYSTEM
A61K 9/08 (2006.01)	3659594	A STERILE SOLUTION WITH AN APPLICATION INJECTOR COMPRISING A MEDICAL AGENT AND METHOD FOR PRODUCING SAME
A61K 31/216 (2006.01)	3659594	A STERILE SOLUTION WITH AN APPLICATION INJECTOR COMPRISING A MEDICAL AGENT AND METHOD FOR PRODUCING SAME
A61M 5/178 (2006.01)	3659594	A STERILE SOLUTION WITH AN APPLICATION INJECTOR COMPRISING A MEDICAL AGENT AND METHOD FOR PRODUCING SAME
C08G 64/02 (2006.01)	3660075	ENDCAPPED POLYCARBONATES, METHODS OF MANUFACTURE, AND ARTICLES FORMED THEREFROM
C08G 64/08 (2006.01)	3660075	ENDCAPPED POLYCARBONATES, METHODS OF MANUFACTURE, AND ARTICLES FORMED THEREFROM
C08G 64/12 (2006.01)	3660075	ENDCAPPED POLYCARBONATES, METHODS OF MANUFACTURE, AND ARTICLES FORMED THEREFROM
C08G 64/14 (2006.01)	3660075	ENDCAPPED POLYCARBONATES, METHODS OF MANUFACTURE, AND ARTICLES FORMED THEREFROM
C08G 64/42 (2006.01)	3660075	ENDCAPPED POLYCARBONATES, METHODS OF MANUFACTURE, AND ARTICLES FORMED THEREFROM
A61K 9/70 (2006.01)	3666341	TOPICAL FORMULATION IN FORM OF A PATCH, A BANDAGE OR A PLASTER COMPRISING PROBIOTIC BACTERIA, AND USE THEREOF IN A METHOD FOR TREATING OR PREVENTING SKIN DISORDERS

MKP (51)	Broj objave evropske prijava patenta (97)	Naziv pronalaska (54)
A61K 35/747 (2015.01)	3666341	TOPICAL FORMULATION IN FORM OF A PATCH, A BANDAGE OR A PLASTER COMPRISING PROBIOTIC BACTERIA, AND USE THEREOF IN A METHOD FOR TREATING OR PREVENTING SKIN DISORDERS
A61L 15/00 (2006.01)	3666341	TOPICAL FORMULATION IN FORM OF A PATCH, A BANDAGE OR A PLASTER COMPRISING PROBIOTIC BACTERIA, AND USE THEREOF IN A METHOD FOR TREATING OR PREVENTING SKIN DISORDERS
A61P 17/00 (2006.01)	3666341	TOPICAL FORMULATION IN FORM OF A PATCH, A BANDAGE OR A PLASTER COMPRISING PROBIOTIC BACTERIA, AND USE THEREOF IN A METHOD FOR TREATING OR PREVENTING SKIN DISORDERS
A61Q 19/00 (2006.01)	3666341	TOPICAL FORMULATION IN FORM OF A PATCH, A BANDAGE OR A PLASTER COMPRISING PROBIOTIC BACTERIA, AND USE THEREOF IN A METHOD FOR TREATING OR PREVENTING SKIN DISORDERS
B62B 3/14 (2006.01)	3670292	SYSTEM FOR TRANSPORTING, HANDLING AND/OR STORAGE OF GOODS
B62B 3/16 (2006.01)	3670292	SYSTEM FOR TRANSPORTING, HANDLING AND/OR STORAGE OF GOODS
B62B 5/00 (2006.01)	3670292	SYSTEM FOR TRANSPORTING, HANDLING AND/OR STORAGE OF GOODS
G06F 9/54 (2006.01)	3620921	COMPUTER-IMPLEMENTED METHOD, DATA PROCESSING APPARATUS, COMPUTER PROGRAM, AND DATA CARRIER SIGNAL
H04R (2006.01)	3644620	IN-EAR ANC EARPHONE
E06B 3/263 (2006.01)	3626927	COMPOSITE PROFILE FOR WINDOWS AND/OR DOORS
E06B 3/36 (2006.01)	3626927	COMPOSITE PROFILE FOR WINDOWS AND/OR DOORS
A61K 31/165 (2006.01)	3755684	ALCOHOL DERIVATIVES AS KV7 POTASSIUM CHANNEL OPENERS
A61P 25/14 (2006.01)	3755684	ALCOHOL DERIVATIVES AS KV7 POTASSIUM CHANNEL OPENERS
A61P 25/18 (2006.01)	3755684	ALCOHOL DERIVATIVES AS KV7 POTASSIUM CHANNEL OPENERS
A61P 25/22 (2006.01)	3755684	ALCOHOL DERIVATIVES AS KV7 POTASSIUM CHANNEL OPENERS
A61P 25/24 (2006.01)	3755684	ALCOHOL DERIVATIVES AS KV7 POTASSIUM CHANNEL OPENERS
A61P 25/28 (2006.01)	3755684	ALCOHOL DERIVATIVES AS KV7 POTASSIUM CHANNEL OPENERS
C07C 235/08 (2006.01)	3755684	ALCOHOL DERIVATIVES AS KV7 POTASSIUM CHANNEL OPENERS
C07C 235/40 (2006.01)	3755684	ALCOHOL DERIVATIVES AS KV7 POTASSIUM CHANNEL OPENERS
G01N 33/68 (2006.01)	3631468	ARTICLES OF MANUFACTURE AND METHODS RELATED TO TOXICITY ASSOCIATED WITH CELL THERAPY
C25B 1/04 (2006.01)	3720990	A METHOD OF HYDROGEN AND OXYGEN PRODUCTION BY ELECTROLYSIS METHOD, IN PARTICULAR ELECTROLYSIS OF WATER
F03D 9/19 (2016.01)	3720990	A METHOD OF HYDROGEN AND OXYGEN PRODUCTION BY ELECTROLYSIS METHOD, IN PARTICULAR ELECTROLYSIS OF WATER
H02J 3/32 (2006.01)	3753084	POWER CONTROL SYSTEM
H02J 9/06 (2006.01)	3753084	POWER CONTROL SYSTEM
E06B 3/667 (2006.01)	3553267	FITTING
E06B 3/964 (2006.01)	3553267	FITTING
A61K 31/131 (2006.01)	3586861	LIPID NANOPARTICLE COMPOSITIONS AND METHODS FOR MRNA DELIVERY
A61K 31/132 (2006.01)	3586861	LIPID NANOPARTICLE COMPOSITIONS AND METHODS FOR MRNA DELIVERY
A61K 31/215 (2006.01)	3586861	LIPID NANOPARTICLE COMPOSITIONS AND METHODS FOR MRNA DELIVERY
A61K 31/56 (2006.01)	3586861	LIPID NANOPARTICLE COMPOSITIONS AND METHODS FOR MRNA DELIVERY
A61K 38/00 (2006.01)	3586861	LIPID NANOPARTICLE COMPOSITIONS AND METHODS FOR MRNA DELIVERY
A61K 38/16 (2006.01)	3586861	LIPID NANOPARTICLE COMPOSITIONS AND METHODS FOR MRNA DELIVERY
A61K 38/43 (2006.01)	3586861	LIPID NANOPARTICLE COMPOSITIONS AND METHODS FOR MRNA DELIVERY
A61K 9/48 (2006.01)	3713552	METHOD FOR INCREASING EMBRYO IMPLANTATION RATE IN A FEMALE SUBJECT SUFFERING POLYCYSTIC OVARY SYNDROME
A61K 31/047 (2006.01)	3713552	METHOD FOR INCREASING EMBRYO IMPLANTATION RATE IN A FEMALE SUBJECT SUFFERING POLYCYSTIC OVARY SYNDROME
A61P 15/00 (2006.01)	3713552	METHOD FOR INCREASING EMBRYO IMPLANTATION RATE IN A FEMALE SUBJECT SUFFERING POLYCYSTIC OVARY SYNDROME
A61K 31/439 (2006.01)	3630111	COMPOUNDS AND METHODS FOR TREATING BACTERIAL INFECTIONS

MKP (51)	Broj objave evropske prijava patenta (97)	Naziv pronalaska (54)
A61P 31/04 (2006.01)	3630111	COMPOUNDS AND METHODS FOR TREATING BACTERIAL INFECTIONS
C07D 471/08 (2006.01)	3630111	COMPOUNDS AND METHODS FOR TREATING BACTERIAL INFECTIONS
G07F 19/00 (2006.01)	3756173	METHOD FOR DETECTING THE PRESENCE OF A SMART CARD CLONING DEVICE IN AN AUTOMATIC PAYMENT AND/OR WITHDRAWAL TERMINAL AND RESPECTIVE AUTOMATIC PAYMENT AND/OR WITHDRAWAL TERMINAL
A23L 2/42 (2006.01)	3727026	METHOD FOR THE INACTIVATION OF MICROORGANISMS IN FOODS
A23L 3/015 (2006.01)	3727026	METHOD FOR THE INACTIVATION OF MICROORGANISMS IN FOODS
A61K 31/4045 (2006.01)	3713568	COMBINATION PRODUCT FOR THE TREATMENT OF NEUROLOGICAL AND/OR PSYCHIATRIC DISORDERS
A61K 45/06 (2006.01)	3713568	COMBINATION PRODUCT FOR THE TREATMENT OF NEUROLOGICAL AND/OR PSYCHIATRIC DISORDERS
A61P 25/00 (2006.01)	3713568	COMBINATION PRODUCT FOR THE TREATMENT OF NEUROLOGICAL AND/OR PSYCHIATRIC DISORDERS
B65B 9/02 (2006.01)	3737619	APPARATUS AND METHOD FOR PRODUCING A SEALED SINGLE-DOSE BREAK-OPEN PACKAGE
B65D 75/58 (2006.01)	3737619	APPARATUS AND METHOD FOR PRODUCING A SEALED SINGLE-DOSE BREAK-OPEN PACKAGE
A61C 17/20 (2006.01)	3740154	TEETH CLEANING DEVICE AND CARRIER STRUCTURE FOR MOUTHPIECE OF A TEETH CLEANING DEVICE
A61C 17/22 (2006.01)	3740154	TEETH CLEANING DEVICE AND CARRIER STRUCTURE FOR MOUTHPIECE OF A TEETH CLEANING DEVICE
A61C 17/34 (2006.01)	3740154	TEETH CLEANING DEVICE AND CARRIER STRUCTURE FOR MOUTHPIECE OF A TEETH CLEANING DEVICE
A61K 9/00 (2006.01)	3636250	LONG-ACTING FORMULATIONS OF INSULINS
A61K 9/08 (2006.01)	3636250	LONG-ACTING FORMULATIONS OF INSULINS
A61K 38/22 (2006.01)	3636250	LONG-ACTING FORMULATIONS OF INSULINS
A61K 38/26 (2006.01)	3636250	LONG-ACTING FORMULATIONS OF INSULINS
A61K 38/28 (2006.01)	3636250	LONG-ACTING FORMULATIONS OF INSULINS
A61K 47/02 (2006.01)	3636250	LONG-ACTING FORMULATIONS OF INSULINS
A61K 47/10 (2017.01)	3636250	LONG-ACTING FORMULATIONS OF INSULINS
A61K 47/26 (2006.01)	3636250	LONG-ACTING FORMULATIONS OF INSULINS
A61B 17/04 (2006.01)	3593730	ADJUSTABLE LOOP WITH LOCKING KNOT
A61B 17/06 (2006.01)	3593730	ADJUSTABLE LOOP WITH LOCKING KNOT
A61K 31/4375 (2006.01)	3617205	BICYCLIC HETEROCYCLES AS FGFR INHIBITORS
A61K 31/444 (2006.01)	3617205	BICYCLIC HETEROCYCLES AS FGFR INHIBITORS
A61K 31/519 (2006.01)	3617205	BICYCLIC HETEROCYCLES AS FGFR INHIBITORS
A61K 31/5377 (2006.01)	3617205	BICYCLIC HETEROCYCLES AS FGFR INHIBITORS
A61K 31/541 (2006.01)	3617205	BICYCLIC HETEROCYCLES AS FGFR INHIBITORS
A61P 19/00 (2006.01)	3617205	BICYCLIC HETEROCYCLES AS FGFR INHIBITORS
A61P 35/00 (2006.01)	3617205	BICYCLIC HETEROCYCLES AS FGFR INHIBITORS
C07D 471/04 (2006.01)	3617205	BICYCLIC HETEROCYCLES AS FGFR INHIBITORS
A61K 31/7088 (2006.01)	3646876	USE OF TELOMERASE INHIBITORS FOR THE TREATMENT OF MYELOPROLIFERATIVE DISORDERS AND MYELOPROLIFERATIVE NEOPLASMS
A61K 31/7125 (2006.01)	3646876	USE OF TELOMERASE INHIBITORS FOR THE TREATMENT OF MYELOPROLIFERATIVE DISORDERS AND MYELOPROLIFERATIVE NEOPLASMS
A61P 7/00 (2006.01)	3646876	USE OF TELOMERASE INHIBITORS FOR THE TREATMENT OF MYELOPROLIFERATIVE DISORDERS AND MYELOPROLIFERATIVE NEOPLASMS
A61P 7/06 (2006.01)	3646876	USE OF TELOMERASE INHIBITORS FOR THE TREATMENT OF MYELOPROLIFERATIVE DISORDERS AND MYELOPROLIFERATIVE NEOPLASMS
A61P 35/00 (2006.01)	3646876	USE OF TELOMERASE INHIBITORS FOR THE TREATMENT OF MYELOPROLIFERATIVE DISORDERS AND MYELOPROLIFERATIVE NEOPLASMS
A61P 35/02 (2006.01)	3646876	USE OF TELOMERASE INHIBITORS FOR THE TREATMENT OF MYELOPROLIFERATIVE DISORDERS AND MYELOPROLIFERATIVE NEOPLASMS
A61K 35/74 (2015.01)	3626248	COMPOSITIONS COMPRISING BACTERIAL STRAINS
A61K 35/745 (2015.01)	3626248	COMPOSITIONS COMPRISING BACTERIAL STRAINS
A61P 1/00 (2006.01)	3626248	COMPOSITIONS COMPRISING BACTERIAL STRAINS
A61P 11/06 (2006.01)	3626248	COMPOSITIONS COMPRISING BACTERIAL STRAINS
A61P 19/02 (2006.01)	3626248	COMPOSITIONS COMPRISING BACTERIAL STRAINS
A61P 25/28 (2006.01)	3626248	COMPOSITIONS COMPRISING BACTERIAL STRAINS

MKP (51)	Broj objave evropske prijava patenta (97)	Naziv pronalaska (54)
A61P 29/00 (2006.01)	3626248	COMPOSITIONS COMPRISING BACTERIAL STRAINS
A61P 35/00 (2006.01)	3626248	COMPOSITIONS COMPRISING BACTERIAL STRAINS
C12N 1/20 (2006.01)	3626248	COMPOSITIONS COMPRISING BACTERIAL STRAINS
A61M 5/142 (2006.01)	3583966	SINGLE-USE AUTO-INJECTOR
A61M 5/145 (2006.01)	3583966	SINGLE-USE AUTO-INJECTOR
A61M 5/20 (2006.01)	3583966	SINGLE-USE AUTO-INJECTOR
A61M 5/315 (2006.01)	3583966	SINGLE-USE AUTO-INJECTOR
A61M 5/32 (2006.01)	3583966	SINGLE-USE AUTO-INJECTOR
A61K 31/7125 (2006.01)	3620522	METHODS FOR TREATMENT OF ALPORT SYNDROME
A61P 13/12 (2006.01)	3620522	METHODS FOR TREATMENT OF ALPORT SYNDROME
C12N 15/113 (2010.01)	3620522	METHODS FOR TREATMENT OF ALPORT SYNDROME
F04D 29/54 (2006.01)	3617529	FAN FRAME OF A MOTOR VEHICLE
A61K 31/4738 (2006.01)	3640251	6,7,8,9-TETRAHYDRO-3H-PYRAZOLO[4,3-F]ISOQUINOLINE DERIVATIVES USEFUL IN THE TREATMENT OF CANCER
A61K 31/497 (2006.01)	3640251	6,7,8,9-TETRAHYDRO-3H-PYRAZOLO[4,3-F]ISOQUINOLINE DERIVATIVES USEFUL IN THE TREATMENT OF CANCER
A61P 35/00 (2006.01)	3640251	6,7,8,9-TETRAHYDRO-3H-PYRAZOLO[4,3-F]ISOQUINOLINE DERIVATIVES USEFUL IN THE TREATMENT OF CANCER
C07D 471/04 (2006.01)	3640251	6,7,8,9-TETRAHYDRO-3H-PYRAZOLO[4,3-F]ISOQUINOLINE DERIVATIVES USEFUL IN THE TREATMENT OF CANCER
A61K 35/74 (2015.01)	3636272	COMPOSITIONS COMPRISING BACTERIAL STRAINS
A61K 35/745 (2015.01)	3636272	COMPOSITIONS COMPRISING BACTERIAL STRAINS
A61P 1/00 (2006.01)	3636272	COMPOSITIONS COMPRISING BACTERIAL STRAINS
A61P 11/06 (2006.01)	3636272	COMPOSITIONS COMPRISING BACTERIAL STRAINS
A61P 19/02 (2006.01)	3636272	COMPOSITIONS COMPRISING BACTERIAL STRAINS
A61P 25/28 (2006.01)	3636272	COMPOSITIONS COMPRISING BACTERIAL STRAINS
A61P 29/00 (2006.01)	3636272	COMPOSITIONS COMPRISING BACTERIAL STRAINS
A61P 35/00 (2006.01)	3636272	COMPOSITIONS COMPRISING BACTERIAL STRAINS
C12N 1/20 (2006.01)	3636272	COMPOSITIONS COMPRISING BACTERIAL STRAINS
A61K 39/395 (2006.01)	3632466	ANTI IL-17RA ANTIBODY FORMULATION AND THERAPEUTIC REGIMENS FOR TREATING PSORIASIS
A61P 17/06 (2006.01)	3632466	ANTI IL-17RA ANTIBODY FORMULATION AND THERAPEUTIC REGIMENS FOR TREATING PSORIASIS
C07K 16/28 (2006.01)	3632466	ANTI IL-17RA ANTIBODY FORMULATION AND THERAPEUTIC REGIMENS FOR TREATING PSORIASIS
B31B 120/40 (2017.01)	3604154	PACKAGING
B65D 5/56 (2006.01)	3604154	PACKAGING
B65D 77/20 (2006.01)	3604154	PACKAGING
A61K 39/00 (2006.01)	3632931	IMPROVED IL-6 ANTIBODIES
A61P 27/02 (2006.01)	3632931	IMPROVED IL-6 ANTIBODIES
C07K 16/24 (2006.01)	3632931	IMPROVED IL-6 ANTIBODIES
A61K 31/519 (2006.01)	3626720	HETEROCYCLIC COMPOUNDS AS LSD1 INHIBITORS
A61P 35/00 (2006.01)	3626720	HETEROCYCLIC COMPOUNDS AS LSD1 INHIBITORS
A61P 35/02 (2006.01)	3626720	HETEROCYCLIC COMPOUNDS AS LSD1 INHIBITORS
C07D 487/04 (2006.01)	3626720	HETEROCYCLIC COMPOUNDS AS LSD1 INHIBITORS
C07D 519/00 (2006.01)	3626720	HETEROCYCLIC COMPOUNDS AS LSD1 INHIBITORS
A61K 31/445 (2006.01)	3626714	CYCLOPROPYLAMINES AS LSD1 INHIBITORS
C07D 211/98 (2006.01)	3626714	CYCLOPROPYLAMINES AS LSD1 INHIBITORS
C07D 401/04 (2006.01)	3626714	CYCLOPROPYLAMINES AS LSD1 INHIBITORS
C07D 401/14 (2006.01)	3626714	CYCLOPROPYLAMINES AS LSD1 INHIBITORS
C07D 405/12 (2006.01)	3626714	CYCLOPROPYLAMINES AS LSD1 INHIBITORS
C07D 405/14 (2006.01)	3626714	CYCLOPROPYLAMINES AS LSD1 INHIBITORS
C07D 413/06 (2006.01)	3626714	CYCLOPROPYLAMINES AS LSD1 INHIBITORS
C07D 417/14 (2006.01)	3626714	CYCLOPROPYLAMINES AS LSD1 INHIBITORS
C07H 21/00 (2006.01)	3636742	METHODS FOR PURIFICATION OF MESSENGER RNA
C12N 1/08 (2006.01)	3636742	METHODS FOR PURIFICATION OF MESSENGER RNA
C12N 15/10 (2006.01)	3636742	METHODS FOR PURIFICATION OF MESSENGER RNA
A61K 31/397 (2006.01)	3626713	CYCLOPROPYLAMINES AS LSD1 INHIBITORS
A61K 31/438 (2006.01)	3626713	CYCLOPROPYLAMINES AS LSD1 INHIBITORS
A61K 31/4427 (2006.01)	3626713	CYCLOPROPYLAMINES AS LSD1 INHIBITORS
A61K 31/4439 (2006.01)	3626713	CYCLOPROPYLAMINES AS LSD1 INHIBITORS
A61K 31/445 (2006.01)	3626713	CYCLOPROPYLAMINES AS LSD1 INHIBITORS
A61K 31/4468 (2006.01)	3626713	CYCLOPROPYLAMINES AS LSD1 INHIBITORS
A61K 31/454 (2006.01)	3626713	CYCLOPROPYLAMINES AS LSD1 INHIBITORS
A61K 31/4545 (2006.01)	3626713	CYCLOPROPYLAMINES AS LSD1 INHIBITORS
A61K 31/496 (2006.01)	3626713	CYCLOPROPYLAMINES AS LSD1 INHIBITORS
A61K 31/501 (2006.01)	3626713	CYCLOPROPYLAMINES AS LSD1 INHIBITORS
A61K 31/506 (2006.01)	3626713	CYCLOPROPYLAMINES AS LSD1 INHIBITORS
C07D 205/04 (2006.01)	3626713	CYCLOPROPYLAMINES AS LSD1 INHIBITORS
C07D 211/14 (2006.01)	3626713	CYCLOPROPYLAMINES AS LSD1 INHIBITORS

MKP (51)	Broj objave evropske prijava patenta (97)	Naziv pronalaska (54)
C07D 211/16 (2006.01)	3626713	CYCLOPROPYLAMINES AS LSD1 INHIBITORS
C07D 211/58 (2006.01)	3626713	CYCLOPROPYLAMINES AS LSD1 INHIBITORS
C07D 401/06 (2006.01)	3626713	CYCLOPROPYLAMINES AS LSD1 INHIBITORS
C07D 401/12 (2006.01)	3626713	CYCLOPROPYLAMINES AS LSD1 INHIBITORS
C07D 471/10 (2006.01)	3626713	CYCLOPROPYLAMINES AS LSD1 INHIBITORS
C07D 239/46 (2006.01)	3626710	PROCESSES FOR PREPARING (CYCLOPENTYL[D]PYRIMIDIN-4-YL)PIPERAZINE COMPOUNDS
B27N 3/00 (2006.01)	3672771	METHOD FOR PRODUCING LIGNOCELLULOSE MATERIALS IN THE PRESENCE OF CAPROLACTAM AND OLIGOMERS OF CAPROLACTAM
B27N 3/02 (2006.01)	3672771	METHOD FOR PRODUCING LIGNOCELLULOSE MATERIALS IN THE PRESENCE OF CAPROLACTAM AND OLIGOMERS OF CAPROLACTAM
B27N 3/04 (2006.01)	3672771	METHOD FOR PRODUCING LIGNOCELLULOSE MATERIALS IN THE PRESENCE OF CAPROLACTAM AND OLIGOMERS OF CAPROLACTAM
B32B 21/02 (2006.01)	3672771	METHOD FOR PRODUCING LIGNOCELLULOSE MATERIALS IN THE PRESENCE OF CAPROLACTAM AND OLIGOMERS OF CAPROLACTAM
B32B 21/04 (2006.01)	3672771	METHOD FOR PRODUCING LIGNOCELLULOSE MATERIALS IN THE PRESENCE OF CAPROLACTAM AND OLIGOMERS OF CAPROLACTAM
B32B 21/14 (2006.01)	3672771	METHOD FOR PRODUCING LIGNOCELLULOSE MATERIALS IN THE PRESENCE OF CAPROLACTAM AND OLIGOMERS OF CAPROLACTAM
C08L 97/02 (2006.01)	3672771	METHOD FOR PRODUCING LIGNOCELLULOSE MATERIALS IN THE PRESENCE OF CAPROLACTAM AND OLIGOMERS OF CAPROLACTAM
A61K 39/00 (2006.01)	3639851	METHODS AND COMPOSITIONS FOR ENHANCING VACCINE IMMUNE RESPONSES
A61K 39/12 (2006.01)	3639851	METHODS AND COMPOSITIONS FOR ENHANCING VACCINE IMMUNE RESPONSES
E05F 11/38 (2006.01)	3743579	DRIVER FOR A VEHICLE WINDOW REGULATOR, AND VEHICLE WINDOW REGULATOR
E05F 11/48 (2006.01)	3743579	DRIVER FOR A VEHICLE WINDOW REGULATOR, AND VEHICLE WINDOW REGULATOR
A61K 31/165 (2006.01)	3723744	C5AR INHIBITORS FOR USE IN THE TREATMENT OF CHEMOTHERAPY-INDUCED IATROGENIC PAIN
A61K 31/18 (2006.01)	3723744	C5AR INHIBITORS FOR USE IN THE TREATMENT OF CHEMOTHERAPY-INDUCED IATROGENIC PAIN
A61K 31/381 (2006.01)	3723744	C5AR INHIBITORS FOR USE IN THE TREATMENT OF CHEMOTHERAPY-INDUCED IATROGENIC PAIN
A61K 31/40 (2006.01)	3723744	C5AR INHIBITORS FOR USE IN THE TREATMENT OF CHEMOTHERAPY-INDUCED IATROGENIC PAIN
A61K 31/422 (2006.01)	3723744	C5AR INHIBITORS FOR USE IN THE TREATMENT OF CHEMOTHERAPY-INDUCED IATROGENIC PAIN
A61K 31/427 (2006.01)	3723744	C5AR INHIBITORS FOR USE IN THE TREATMENT OF CHEMOTHERAPY-INDUCED IATROGENIC PAIN
A61K 31/431 (2006.01)	3723744	C5AR INHIBITORS FOR USE IN THE TREATMENT OF CHEMOTHERAPY-INDUCED IATROGENIC PAIN
A61K 31/4406 (2006.01)	3723744	C5AR INHIBITORS FOR USE IN THE TREATMENT OF CHEMOTHERAPY-INDUCED IATROGENIC PAIN
A61K 31/445 (2006.01)	3723744	C5AR INHIBITORS FOR USE IN THE TREATMENT OF CHEMOTHERAPY-INDUCED IATROGENIC PAIN
A61P 25/02 (2006.01)	3723744	C5AR INHIBITORS FOR USE IN THE TREATMENT OF CHEMOTHERAPY-INDUCED IATROGENIC PAIN
C12N 5/073 (2010.01)	3728566	MESENCHYMAL STROMAL CELLS AND METHODS FOR OBTAINING MESENCHYMAL STROMAL CELLS FROM UMBILICAL CORD
C12N 5/0775 (2010.01)	3728566	MESENCHYMAL STROMAL CELLS AND METHODS FOR OBTAINING MESENCHYMAL STROMAL CELLS FROM UMBILICAL CORD
A61K 38/17 (2006.01)	3716992	USE OF A VEGF ANTAGONIST TO TREAT ANGIOGENIC EYE DISORDERS
A61P 27/02 (2006.01)	3716992	USE OF A VEGF ANTAGONIST TO TREAT ANGIOGENIC EYE DISORDERS
A61P 27/02 (2006.01)	3714055	MATERIALS AND METHODS FOR TREATMENT OF AUTOSOMAL DOMINANT RETINITIS PIGMENTOSA
C12N 9/22 (2006.01)	3714055	MATERIALS AND METHODS FOR TREATMENT OF AUTOSOMAL DOMINANT RETINITIS PIGMENTOSA

MKP (51)	Broj objave evropske prijava patenta (97)	Naziv pronalaska (54)
C12N 15/113 (2010.01)	3714055	MATERIALS AND METHODS FOR TREATMENT OF AUTOSOMAL DOMINANT RETINITIS PIGMENTOSA
A61K 31/437 (2006.01)	3720855	IMIDAZOPYRIDINE DERIVATIVES AND THE USE THEREOF AS MEDICAMENT
A61K 31/5377 (2006.01)	3720855	IMIDAZOPYRIDINE DERIVATIVES AND THE USE THEREOF AS MEDICAMENT
A61P 25/00 (2006.01)	3720855	IMIDAZOPYRIDINE DERIVATIVES AND THE USE THEREOF AS MEDICAMENT
A61P 25/24 (2006.01)	3720855	IMIDAZOPYRIDINE DERIVATIVES AND THE USE THEREOF AS MEDICAMENT
C07D 471/04 (2006.01)	3720855	IMIDAZOPYRIDINE DERIVATIVES AND THE USE THEREOF AS MEDICAMENT
A61P 13/12 (2006.01)	3717510	POLYOMAVIRUS NEUTRALIZING ANTIBODIES
C07K 16/08 (2006.01)	3717510	POLYOMAVIRUS NEUTRALIZING ANTIBODIES
A61M 5/20 (2006.01)	3723827	MEDICATION DELIVERY DEVICE WITH SYRINGE SENSING SYSTEM
A61M 5/315 (2006.01)	3723827	MEDICATION DELIVERY DEVICE WITH SYRINGE SENSING SYSTEM
A61M 5/32 (2006.01)	3723827	MEDICATION DELIVERY DEVICE WITH SYRINGE SENSING SYSTEM
A61K 38/19 (2006.01)	3720469	METHOD OF TREATING IDIOPATHIC THROMBOCYTOPENIA PURPURA (ITP) WITH ROMIPLOSTIM
A61P 7/04 (2006.01)	3720469	METHOD OF TREATING IDIOPATHIC THROMBOCYTOPENIA PURPURA (ITP) WITH ROMIPLOSTIM
A61K 31/497 (2006.01)	3724176	FUMARATE SALT OF (R)-3-(1-(2,3-DICHLORO-4-(PYRAZIN-2-YL)PHENYL)-2,2,2-TRIFLUOROETHYL)-1-METHYL-1-(1-METHYLPYPERIDIN-4-YL) UREA, METHODS OF PREPARATION, AND USES THEREOF
A61P 25/30 (2006.01)	3724176	FUMARATE SALT OF (R)-3-(1-(2,3-DICHLORO-4-(PYRAZIN-2-YL)PHENYL)-2,2,2-TRIFLUOROETHYL)-1-METHYL-1-(1-METHYLPYPERIDIN-4-YL) UREA, METHODS OF PREPARATION, AND USES THEREOF
C07D 401/12 (2006.01)	3724176	FUMARATE SALT OF (R)-3-(1-(2,3-DICHLORO-4-(PYRAZIN-2-YL)PHENYL)-2,2,2-TRIFLUOROETHYL)-1-METHYL-1-(1-METHYLPYPERIDIN-4-YL) UREA, METHODS OF PREPARATION, AND USES THEREOF
A61K 31/137 (2006.01)	3720880	COMBINATION THERAPY OF MULTIPLE SCLEROSIS COMPRISING A CD20 LIGAND
A61K 31/225 (2006.01)	3720880	COMBINATION THERAPY OF MULTIPLE SCLEROSIS COMPRISING A CD20 LIGAND
A61K 31/277 (2006.01)	3720880	COMBINATION THERAPY OF MULTIPLE SCLEROSIS COMPRISING A CD20 LIGAND
A61P 25/00 (2006.01)	3720880	COMBINATION THERAPY OF MULTIPLE SCLEROSIS COMPRISING A CD20 LIGAND
C07K 16/28 (2006.01)	3720880	COMBINATION THERAPY OF MULTIPLE SCLEROSIS COMPRISING A CD20 LIGAND
A01G 13/06 (2006.01)	3723480	A METHOD AND APPARATUS FOR CONTROLLING VEGETATION BY MEANS OF A HEATED GAS
A01M 21/04 (2006.01)	3723480	A METHOD AND APPARATUS FOR CONTROLLING VEGETATION BY MEANS OF A HEATED GAS
G01N 33/50 (2006.01)	3729100	METHOD OF ASSESSING GROWTH HORMONE DEFICIENCY IN HUMANS BY A MACIMORELIN CONTAINING COMPOSITION
G01N 33/74 (2006.01)	3729100	METHOD OF ASSESSING GROWTH HORMONE DEFICIENCY IN HUMANS BY A MACIMORELIN CONTAINING COMPOSITION
A61P 37/06 (2006.01)	3720877	USE OF FCRN ANTAGONISTS FOR TREATMENT OF GENERALIZED MYASTHENIA GRAVIS
C07K 16/00 (2006.01)	3720877	USE OF FCRN ANTAGONISTS FOR TREATMENT OF GENERALIZED MYASTHENIA GRAVIS
A61K 31/40 (2006.01)	3724182	PYRROLE DERIVATIVES AS ACC INHIBITORS
A61P 37/00 (2006.01)	3724182	PYRROLE DERIVATIVES AS ACC INHIBITORS
C07D 207/36 (2006.01)	3724182	PYRROLE DERIVATIVES AS ACC INHIBITORS
C07D 403/12 (2006.01)	3724182	PYRROLE DERIVATIVES AS ACC INHIBITORS
A61K 31/437 (2006.01)	3728246	META TYROSINE DERIVATIVES AS RHO-KINASE INHIBITORS
A61P 9/00 (2006.01)	3728246	META TYROSINE DERIVATIVES AS RHO-KINASE INHIBITORS
A61P 11/00 (2006.01)	3728246	META TYROSINE DERIVATIVES AS RHO-KINASE INHIBITORS
C07D 471/04 (2006.01)	3728246	META TYROSINE DERIVATIVES AS RHO-KINASE INHIBITORS
A61K 31/437 (2006.01)	3728247	OXADIAZOLE DERIVATIVES AS RHO-KINASE INHIBITORS
A61P 9/00 (2006.01)	3728247	OXADIAZOLE DERIVATIVES AS RHO-KINASE INHIBITORS
A61P 11/00 (2006.01)	3728247	OXADIAZOLE DERIVATIVES AS RHO-KINASE INHIBITORS
C07D 471/04 (2006.01)	3728247	OXADIAZOLE DERIVATIVES AS RHO-KINASE INHIBITORS

MKP (51)	Broj objave evropske prijava patenta (97)	Naziv pronalaska (54)
A61K 31/541 (2006.01)	3728248	AZAINDOLE DERIVATIVES AS RHO-KINASE INHIBITORS
A61P 11/00 (2006.01)	3728248	AZAINDOLE DERIVATIVES AS RHO-KINASE INHIBITORS
C07D 471/04 (2006.01)	3728248	AZAINDOLE DERIVATIVES AS RHO-KINASE INHIBITORS
C07D 487/04 (2006.01)	3728248	AZAINDOLE DERIVATIVES AS RHO-KINASE INHIBITORS
C07D 519/00 (2006.01)	3728248	AZAINDOLE DERIVATIVES AS RHO-KINASE INHIBITORS
A61M 31/00 (2006.01)	3720537	LONG ACTING GASTRIC RESIDENCE SYSTEM
B65D 33/25 (2006.01)	3717369	CHILD RESISTANT SLIDER, ZIPPER CLOSURE SYSTEM USING SLIDER, AND METHODS OF USE
A61K 38/46 (2006.01)	3720473	CRISPR-CAS9 MODIFIED CD34+ HUMAN HEMATOPOIETIC STEM AND PROGENITOR CELLS AND USES THEREOF
C12N 9/22 (2006.01)	3720473	CRISPR-CAS9 MODIFIED CD34+ HUMAN HEMATOPOIETIC STEM AND PROGENITOR CELLS AND USES THEREOF
C12N 15/10 (2006.01)	3720473	CRISPR-CAS9 MODIFIED CD34+ HUMAN HEMATOPOIETIC STEM AND PROGENITOR CELLS AND USES THEREOF
C12N 15/113 (2010.01)	3720473	CRISPR-CAS9 MODIFIED CD34+ HUMAN HEMATOPOIETIC STEM AND PROGENITOR CELLS AND USES THEREOF
A61K 31/51 (2006.01)	3720859	POSITIVE ALLOSTERIC MODULATORS OF THE MUSCARINIC ACETYLCHOLINE RECEPTOR M4
A61P 25/00 (2006.01)	3720859	POSITIVE ALLOSTERIC MODULATORS OF THE MUSCARINIC ACETYLCHOLINE RECEPTOR M4
C07D 495/14 (2006.01)	3720859	POSITIVE ALLOSTERIC MODULATORS OF THE MUSCARINIC ACETYLCHOLINE RECEPTOR M4
A61K 31/519 (2006.01)	3720860	POSITIVE ALLOSTERIC MODULATORS OF THE MUSCARINIC ACETYLCHOLINE RECEPTOR M4
A61P 25/00 (2006.01)	3720860	POSITIVE ALLOSTERIC MODULATORS OF THE MUSCARINIC ACETYLCHOLINE RECEPTOR M4
C07D 495/14 (2006.01)	3720860	POSITIVE ALLOSTERIC MODULATORS OF THE MUSCARINIC ACETYLCHOLINE RECEPTOR M4
C07D 231/20 (2006.01)	3720849	PROCESSES FOR MAKING MODULATORS OF CYSTIC FIBROSIS TRANSMEMBRANE CONDUCTANCE REGULATOR
C07D 401/04 (2006.01)	3720849	PROCESSES FOR MAKING MODULATORS OF CYSTIC FIBROSIS TRANSMEMBRANE CONDUCTANCE REGULATOR
C07D 401/14 (2006.01)	3720849	PROCESSES FOR MAKING MODULATORS OF CYSTIC FIBROSIS TRANSMEMBRANE CONDUCTANCE REGULATOR
C07D 405/04 (2006.01)	3720849	PROCESSES FOR MAKING MODULATORS OF CYSTIC FIBROSIS TRANSMEMBRANE CONDUCTANCE REGULATOR
C12N 5/0783 (2010.01)	3720949	SERUM-FREE MEDIA FORMULATION FOR CULTURING CELLS AND METHODS OF USE THEREOF
A61K 39/00 (2006.01)	3724228	ANTI-ALPHA SYNUCLEIN ANTIBODIES
A61K 39/395 (2006.01)	3724228	ANTI-ALPHA SYNUCLEIN ANTIBODIES
A61P 25/16 (2006.01)	3724228	ANTI-ALPHA SYNUCLEIN ANTIBODIES
A61P 25/28 (2006.01)	3724228	ANTI-ALPHA SYNUCLEIN ANTIBODIES
C07K 16/28 (2006.01)	3724228	ANTI-ALPHA SYNUCLEIN ANTIBODIES
C07K 16/18 (2006.01)	3724224	ANTI-ALPHA-SYNUCLEIN ANTIBODIES
A61K 39/395 (2006.01)	3728313	COMBINATION ANTI CANCER THERAPY WITH AN IAP ANTAGONIST AND AN ANTI PD-1 MOLECULE
A61K 45/06 (2006.01)	3728313	COMBINATION ANTI CANCER THERAPY WITH AN IAP ANTAGONIST AND AN ANTI PD-1 MOLECULE
A61P 35/00 (2006.01)	3728313	COMBINATION ANTI CANCER THERAPY WITH AN IAP ANTAGONIST AND AN ANTI PD-1 MOLECULE
C07K 16/28 (2006.01)	3728313	COMBINATION ANTI CANCER THERAPY WITH AN IAP ANTAGONIST AND AN ANTI PD-1 MOLECULE
A61K 38/17 (2006.01)	3720478	HLA CLASS I-RESTRICTED T CELL RECEPTORS AGAINST MUTATED RAS
A61K 39/00 (2006.01)	3720478	HLA CLASS I-RESTRICTED T CELL RECEPTORS AGAINST MUTATED RAS
C07K 14/47 (2006.01)	3720478	HLA CLASS I-RESTRICTED T CELL RECEPTORS AGAINST MUTATED RAS
C07K 14/725 (2006.01)	3720478	HLA CLASS I-RESTRICTED T CELL RECEPTORS AGAINST MUTATED RAS
A61K 35/17 (2015.01)	3720874	PROCESS FOR PRODUCING A COMPOSITION OF ENGINEERED T CELLS
C07K 14/725 (2006.01)	3720874	PROCESS FOR PRODUCING A COMPOSITION OF ENGINEERED T CELLS
C12N 5/0783 (2010.01)	3720874	PROCESS FOR PRODUCING A COMPOSITION OF ENGINEERED T CELLS
A61K 31/437 (2006.01)	3723807	COMBINATION TREATMENTS COMPRISING ADMINISTRATION OF 1H-PYRAZOLO[4,3-B]PYRIDINES
A61K 31/444 (2006.01)	3723807	COMBINATION TREATMENTS COMPRISING ADMINISTRATION OF 1H-PYRAZOLO[4,3-B]PYRIDINES

MKP (51)	Broj objave evropske prijava patenta (97)	Naziv pronalaska (54)
A61K 31/497 (2006.01)	3723807	COMBINATION TREATMENTS COMPRISING ADMINISTRATION OF 1H-PYRAZOLO[4,3-B]PYRIDINES
A61K 31/506 (2006.01)	3723807	COMBINATION TREATMENTS COMPRISING ADMINISTRATION OF 1H-PYRAZOLO[4,3-B]PYRIDINES
A61K 45/06 (2006.01)	3723807	COMBINATION TREATMENTS COMPRISING ADMINISTRATION OF 1H-PYRAZOLO[4,3-B]PYRIDINES
A61P 25/00 (2006.01)	3723807	COMBINATION TREATMENTS COMPRISING ADMINISTRATION OF 1H-PYRAZOLO[4,3-B]PYRIDINES
A61P 25/18 (2006.01)	3723807	COMBINATION TREATMENTS COMPRISING ADMINISTRATION OF 1H-PYRAZOLO[4,3-B]PYRIDINES
A61P 25/22 (2006.01)	3723807	COMBINATION TREATMENTS COMPRISING ADMINISTRATION OF 1H-PYRAZOLO[4,3-B]PYRIDINES
A61P 25/24 (2006.01)	3723807	COMBINATION TREATMENTS COMPRISING ADMINISTRATION OF 1H-PYRAZOLO[4,3-B]PYRIDINES
A61P 25/28 (2006.01)	3723807	COMBINATION TREATMENTS COMPRISING ADMINISTRATION OF 1H-PYRAZOLO[4,3-B]PYRIDINES
A61K 31/437 (2006.01)	3723808	COMBINATION TREATMENTS COMPRISING ADMINISTRATION OF 1H-PYRAZOLO[4,3-B]PYRIDINES
A61K 31/444 (2006.01)	3723808	COMBINATION TREATMENTS COMPRISING ADMINISTRATION OF 1H-PYRAZOLO[4,3-B]PYRIDINES
A61K 31/497 (2006.01)	3723808	COMBINATION TREATMENTS COMPRISING ADMINISTRATION OF 1H-PYRAZOLO[4,3-B]PYRIDINES
A61K 31/506 (2006.01)	3723808	COMBINATION TREATMENTS COMPRISING ADMINISTRATION OF 1H-PYRAZOLO[4,3-B]PYRIDINES
A61K 45/06 (2006.01)	3723808	COMBINATION TREATMENTS COMPRISING ADMINISTRATION OF 1H-PYRAZOLO[4,3-B]PYRIDINES
A61P 25/00 (2006.01)	3723808	COMBINATION TREATMENTS COMPRISING ADMINISTRATION OF 1H-PYRAZOLO[4,3-B]PYRIDINES
A61P 25/18 (2006.01)	3723808	COMBINATION TREATMENTS COMPRISING ADMINISTRATION OF 1H-PYRAZOLO[4,3-B]PYRIDINES
A61P 25/22 (2006.01)	3723808	COMBINATION TREATMENTS COMPRISING ADMINISTRATION OF 1H-PYRAZOLO[4,3-B]PYRIDINES
A61P 25/24 (2006.01)	3723808	COMBINATION TREATMENTS COMPRISING ADMINISTRATION OF 1H-PYRAZOLO[4,3-B]PYRIDINES
A61P 25/28 (2006.01)	3723808	COMBINATION TREATMENTS COMPRISING ADMINISTRATION OF 1H-PYRAZOLO[4,3-B]PYRIDINES
A61K 39/395 (2006.01)	3723800	TREATMENT OF MONOGENIC DISEASES WITH AN ANTI-CD45RC ANTIBODY
A61P 21/00 (2006.01)	3723800	TREATMENT OF MONOGENIC DISEASES WITH AN ANTI-CD45RC ANTIBODY
A61P 37/00 (2006.01)	3723800	TREATMENT OF MONOGENIC DISEASES WITH AN ANTI-CD45RC ANTIBODY
C07K 16/28 (2006.01)	3723800	TREATMENT OF MONOGENIC DISEASES WITH AN ANTI-CD45RC ANTIBODY
A61K 9/16 (2006.01)	3727341	FIXED DOSE COMBINATION TABLET FORMULATION OF ACARBOSE AND METFORMIN AND PROCESS FOR PRODUCING THE SAME
A61K 9/20 (2006.01)	3727341	FIXED DOSE COMBINATION TABLET FORMULATION OF ACARBOSE AND METFORMIN AND PROCESS FOR PRODUCING THE SAME
A61K 9/28 (2006.01)	3727341	FIXED DOSE COMBINATION TABLET FORMULATION OF ACARBOSE AND METFORMIN AND PROCESS FOR PRODUCING THE SAME
A61K 31/155 (2006.01)	3727341	FIXED DOSE COMBINATION TABLET FORMULATION OF ACARBOSE AND METFORMIN AND PROCESS FOR PRODUCING THE SAME
A61K 31/702 (2006.01)	3727341	FIXED DOSE COMBINATION TABLET FORMULATION OF ACARBOSE AND METFORMIN AND PROCESS FOR PRODUCING THE SAME
A61K 45/06 (2006.01)	3727341	FIXED DOSE COMBINATION TABLET FORMULATION OF ACARBOSE AND METFORMIN AND PROCESS FOR PRODUCING THE SAME
A61K 8/99 (2017.01)	3720457	COMPOSITION BASED ON PROBIOTICS AND USES THEREOF
A61K 35/74 (2015.01)	3720457	COMPOSITION BASED ON PROBIOTICS AND USES THEREOF
A61P 17/00 (2006.01)	3720457	COMPOSITION BASED ON PROBIOTICS AND USES THEREOF
A61Q 19/00 (2006.01)	3720457	COMPOSITION BASED ON PROBIOTICS AND USES THEREOF
C12N 5/0783 (2010.01)	3717634	METHODS FOR ACTIVATING, MODIFYING AND EXPANDING GAMMA DELTA T CELLS FOR THE TREATMENT OF CANCER AND RELATED MALIGNANCIES
A61K 39/00 (2006.01)	3723797	HEPATITIS B IMMUNISATION REGIMEN AND COMPOSITIONS

MKP (51)	Broj objave evropske prijava patenta (97)	Naziv pronalaska (54)
A61K 39/12 (2006.01)	3723797	HEPATITIS B IMMUNISATION REGIMEN AND COMPOSITIONS
A61P 31/20 (2006.01)	3723797	HEPATITIS B IMMUNISATION REGIMEN AND COMPOSITIONS
F25B 19/00 (2006.01)	3749903	METHOD AND DEVICE FOR COOLING A SUPERCONDUCTING CURRENT CARRIER
F25B 25/00 (2006.01)	3749903	METHOD AND DEVICE FOR COOLING A SUPERCONDUCTING CURRENT CARRIER
F25D 3/10 (2006.01)	3749903	METHOD AND DEVICE FOR COOLING A SUPERCONDUCTING CURRENT CARRIER
H02G 15/34 (2006.01)	3749903	METHOD AND DEVICE FOR COOLING A SUPERCONDUCTING CURRENT CARRIER
A01N 43/80 (2006.01)	3717461	A NOVEL ISOXAZOLE COMPOUND OR A SALT THEREOF
A61K 31/42 (2006.01)	3717461	A NOVEL ISOXAZOLE COMPOUND OR A SALT THEREOF
A61P 33/00 (2006.01)	3717461	A NOVEL ISOXAZOLE COMPOUND OR A SALT THEREOF
C07D 261/08 (2006.01)	3717461	A NOVEL ISOXAZOLE COMPOUND OR A SALT THEREOF
C07K 14/435 (2006.01)	3720875	ANTIMICROBIAL PEPTIDES AND METHODS OF USING SAME
C07K 14/78 (2006.01)	3720875	ANTIMICROBIAL PEPTIDES AND METHODS OF USING SAME
C12N 15/82 (2006.01)	3720875	ANTIMICROBIAL PEPTIDES AND METHODS OF USING SAME
A61K 31/58 (2006.01)	3720867	DEUTERATED 21 -[4-CYANO-PYRAZOL-1 -YL]-19-NOR-PREGAN-3. ALPHA-OL-20-ONE DERIVATIVES FOR TREATING CNS DISORDERS
A61P 25/24 (2006.01)	3720867	DEUTERATED 21 -[4-CYANO-PYRAZOL-1 -YL]-19-NOR-PREGAN-3. ALPHA-OL-20-ONE DERIVATIVES FOR TREATING CNS DISORDERS
C07J 1/00 (2006.01)	3720867	DEUTERATED 21 -[4-CYANO-PYRAZOL-1 -YL]-19-NOR-PREGAN-3. ALPHA-OL-20-ONE DERIVATIVES FOR TREATING CNS DISORDERS
C07J 7/00 (2006.01)	3720867	DEUTERATED 21 -[4-CYANO-PYRAZOL-1 -YL]-19-NOR-PREGAN-3. ALPHA-OL-20-ONE DERIVATIVES FOR TREATING CNS DISORDERS
C07J 13/00 (2006.01)	3720867	DEUTERATED 21 -[4-CYANO-PYRAZOL-1 -YL]-19-NOR-PREGAN-3. ALPHA-OL-20-ONE DERIVATIVES FOR TREATING CNS DISORDERS
C07J 43/00 (2006.01)	3720867	DEUTERATED 21 -[4-CYANO-PYRAZOL-1 -YL]-19-NOR-PREGAN-3. ALPHA-OL-20-ONE DERIVATIVES FOR TREATING CNS DISORDERS
A61K 38/26 (2006.01)	3727425	INCRETIN ANALOGS AND USES THEREOF
A61P 3/00 (2006.01)	3727425	INCRETIN ANALOGS AND USES THEREOF
C07K 14/605 (2006.01)	3727425	INCRETIN ANALOGS AND USES THEREOF
A61K 38/26 (2006.01)	3727426	INCRETIN ANALOGS AND USES THEREOF
A61P 3/00 (2006.01)	3727426	INCRETIN ANALOGS AND USES THEREOF
C07K 14/605 (2006.01)	3727426	INCRETIN ANALOGS AND USES THEREOF
C12N 9/22 (2006.01)	3724332	NOVEL RNA-PROGRAMMABLE ENDONUCLEASE SYSTEMS AND THEIR USE IN GENOME EDITING AND OTHER APPLICATIONS
C12N 15/10 (2006.01)	3724332	NOVEL RNA-PROGRAMMABLE ENDONUCLEASE SYSTEMS AND THEIR USE IN GENOME EDITING AND OTHER APPLICATIONS
A61K 31/437 (2006.01)	3728252	4-AZAINDOLE COMPOUNDS
A61P 37/00 (2006.01)	3728252	4-AZAINDOLE COMPOUNDS
C07D 471/04 (2006.01)	3728252	4-AZAINDOLE COMPOUNDS
C07D 519/00 (2006.01)	3728252	4-AZAINDOLE COMPOUNDS
A61K 31/496 (2006.01)	3724178	1 -(PIPERIDINOCARBONYLMETHYL)-2-OXOPIPERAZINE DERIVATIVES FOR TREATING CANCER
A61P 35/00 (2006.01)	3724178	1 -(PIPERIDINOCARBONYLMETHYL)-2-OXOPIPERAZINE DERIVATIVES FOR TREATING CANCER
C07D 401/06 (2006.01)	3724178	1 -(PIPERIDINOCARBONYLMETHYL)-2-OXOPIPERAZINE DERIVATIVES FOR TREATING CANCER
C07D 401/14 (2006.01)	3724178	1 -(PIPERIDINOCARBONYLMETHYL)-2-OXOPIPERAZINE DERIVATIVES FOR TREATING CANCER
C07D 471/04 (2006.01)	3724178	1 -(PIPERIDINOCARBONYLMETHYL)-2-OXOPIPERAZINE DERIVATIVES FOR TREATING CANCER
C07D 471/10 (2006.01)	3724178	1 -(PIPERIDINOCARBONYLMETHYL)-2-OXOPIPERAZINE DERIVATIVES FOR TREATING CANCER
C07D 491/107 (2006.01)	3724178	1 -(PIPERIDINOCARBONYLMETHYL)-2-OXOPIPERAZINE DERIVATIVES FOR TREATING CANCER
C07D 491/113 (2006.01)	3724178	1 -(PIPERIDINOCARBONYLMETHYL)-2-OXOPIPERAZINE DERIVATIVES FOR TREATING CANCER
C07D 491/20 (2006.01)	3724178	1 -(PIPERIDINOCARBONYLMETHYL)-2-OXOPIPERAZINE DERIVATIVES FOR TREATING CANCER
C07D 495/04 (2006.01)	3724178	1 -(PIPERIDINOCARBONYLMETHYL)-2-OXOPIPERAZINE DERIVATIVES FOR TREATING CANCER

MKP (51)	Broj objave evropske prijava patenta (97)	Naziv pronalaska (54)
C07D 495/10 (2006.01)	3724178	1 -(PIPERIDINOCARBONYLMETHYL)-2-OXOPIPERAZINE DERIVATIVES FOR TREATING CANCER
C07D 497/10 (2006.01)	3724178	1 -(PIPERIDINOCARBONYLMETHYL)-2-OXOPIPERAZINE DERIVATIVES FOR TREATING CANCER
A61K 39/00 (2006.01)	3728315	BISPECIFIC ANTIGEN BINDING MOLECULES THAT BIND LEPTIN RECEPTOR AND/OR GP130, AND METHODS OF USE THEREOF
A61K 39/395 (2006.01)	3728315	BISPECIFIC ANTIGEN BINDING MOLECULES THAT BIND LEPTIN RECEPTOR AND/OR GP130, AND METHODS OF USE THEREOF
A61P 3/04 (2006.01)	3728315	BISPECIFIC ANTIGEN BINDING MOLECULES THAT BIND LEPTIN RECEPTOR AND/OR GP130, AND METHODS OF USE THEREOF
A61P 3/10 (2006.01)	3728315	BISPECIFIC ANTIGEN BINDING MOLECULES THAT BIND LEPTIN RECEPTOR AND/OR GP130, AND METHODS OF USE THEREOF
C07K 16/28 (2006.01)	3728315	BISPECIFIC ANTIGEN BINDING MOLECULES THAT BIND LEPTIN RECEPTOR AND/OR GP130, AND METHODS OF USE THEREOF
A61K 31/519 (2006.01)	3728254	NOVEL BENZYLAMINO SUBSTITUTED PYRIDOPYRIMIDINONES AND DERIVATIVES AS SOS1 INHIBITORS
A61P 35/00 (2006.01)	3728254	NOVEL BENZYLAMINO SUBSTITUTED PYRIDOPYRIMIDINONES AND DERIVATIVES AS SOS1 INHIBITORS
C07D 453/02 (2006.01)	3728254	NOVEL BENZYLAMINO SUBSTITUTED PYRIDOPYRIMIDINONES AND DERIVATIVES AS SOS1 INHIBITORS
C07D 471/04 (2006.01)	3728254	NOVEL BENZYLAMINO SUBSTITUTED PYRIDOPYRIMIDINONES AND DERIVATIVES AS SOS1 INHIBITORS
C07D 519/00 (2006.01)	3728254	NOVEL BENZYLAMINO SUBSTITUTED PYRIDOPYRIMIDINONES AND DERIVATIVES AS SOS1 INHIBITORS
A23L 33/00 (2016.01)	3723509	DIETARY SUPPLEMENT
A23L 33/105 (2016.01)	3723509	DIETARY SUPPLEMENT
A61K 36/00 (2006.01)	3723509	DIETARY SUPPLEMENT
C07K 14/55 (2006.01)	3728302	ENGINEERED IL-2 FC FUSION PROTEINS
C12N 15/62 (2006.01)	3728302	ENGINEERED IL-2 FC FUSION PROTEINS
A61K 39/12 (2006.01)	3727441	METHODS AND APPARATUS FOR THE DELIVERY OF HEPATITIS B VIRUS (HBV) VACCINES
A61K 39/29 (2006.01)	3727441	METHODS AND APPARATUS FOR THE DELIVERY OF HEPATITIS B VIRUS (HBV) VACCINES
A61N 1/00 (2006.01)	3727441	METHODS AND APPARATUS FOR THE DELIVERY OF HEPATITIS B VIRUS (HBV) VACCINES
A61P 31/14 (2006.01)	3727441	METHODS AND APPARATUS FOR THE DELIVERY OF HEPATITIS B VIRUS (HBV) VACCINES
E21B 21/00 (2006.01)	3752704	CURING A LOST CIRCULATION ZONE IN A WELLBORE
A61K 36/185 (2006.01)	3720462	INHIBITION OF ANDROGEN RECEPTOR BY EXTRACTS OF MEDICINAL HERBS AND COMPOSITIONS THEREOF
A61K 36/24 (2006.01)	3720462	INHIBITION OF ANDROGEN RECEPTOR BY EXTRACTS OF MEDICINAL HERBS AND COMPOSITIONS THEREOF
A61K 36/28 (2006.01)	3720462	INHIBITION OF ANDROGEN RECEPTOR BY EXTRACTS OF MEDICINAL HERBS AND COMPOSITIONS THEREOF
A61K 36/47 (2006.01)	3720462	INHIBITION OF ANDROGEN RECEPTOR BY EXTRACTS OF MEDICINAL HERBS AND COMPOSITIONS THEREOF
A61K 36/59 (2006.01)	3720462	INHIBITION OF ANDROGEN RECEPTOR BY EXTRACTS OF MEDICINAL HERBS AND COMPOSITIONS THEREOF
A61K 36/708 (2006.01)	3720462	INHIBITION OF ANDROGEN RECEPTOR BY EXTRACTS OF MEDICINAL HERBS AND COMPOSITIONS THEREOF
A61K 36/739 (2006.01)	3720462	INHIBITION OF ANDROGEN RECEPTOR BY EXTRACTS OF MEDICINAL HERBS AND COMPOSITIONS THEREOF
A61K 36/756 (2006.01)	3720462	INHIBITION OF ANDROGEN RECEPTOR BY EXTRACTS OF MEDICINAL HERBS AND COMPOSITIONS THEREOF
A61K 36/82 (2006.01)	3720462	INHIBITION OF ANDROGEN RECEPTOR BY EXTRACTS OF MEDICINAL HERBS AND COMPOSITIONS THEREOF
A61K 36/886 (2006.01)	3720462	INHIBITION OF ANDROGEN RECEPTOR BY EXTRACTS OF MEDICINAL HERBS AND COMPOSITIONS THEREOF
A61P 13/08 (2006.01)	3720462	INHIBITION OF ANDROGEN RECEPTOR BY EXTRACTS OF MEDICINAL HERBS AND COMPOSITIONS THEREOF
A61P 15/00 (2006.01)	3720462	INHIBITION OF ANDROGEN RECEPTOR BY EXTRACTS OF MEDICINAL HERBS AND COMPOSITIONS THEREOF
A61P 35/00 (2006.01)	3720462	INHIBITION OF ANDROGEN RECEPTOR BY EXTRACTS OF MEDICINAL HERBS AND COMPOSITIONS THEREOF
A61K 39/00 (2006.01)	3720483	COMPOSITIONS COMPRISING STREPTOCOCCUS PNEUMONIAE POLYSACCHARIDE-PROTEIN CONJUGATES AND METHODS OF USE THEREOF
A61K 39/09 (2006.01)	3720483	COMPOSITIONS COMPRISING STREPTOCOCCUS PNEUMONIAE POLYSACCHARIDE-PROTEIN CONJUGATES AND METHODS OF USE THEREOF

MKP (51)	Broj objave evropske prijava patenta (97)	Naziv pronalaska (54)
A61K 39/385 (2006.01)	3720483	COMPOSITIONS COMPRISING STREPTOCOCCUS PNEUMONIAE POLYSACCHARIDE-PROTEIN CONJUGATES AND METHODS OF USE THEREOF
A61P 31/04 (2006.01)	3720483	COMPOSITIONS COMPRISING STREPTOCOCCUS PNEUMONIAE POLYSACCHARIDE-PROTEIN CONJUGATES AND METHODS OF USE THEREOF
A61N 5/00 (2006.01)	3727582	FLESH-ILLUMINATING DEVICE
A61N 5/06 (2006.01)	3727582	FLESH-ILLUMINATING DEVICE
F21L 4/00 (2006.01)	3727582	FLESH-ILLUMINATING DEVICE
F21L 4/02 (2006.01)	3727582	FLESH-ILLUMINATING DEVICE
F21V 1/00 (2006.01)	3727582	FLESH-ILLUMINATING DEVICE
F21V 3/00 (2015.01)	3727582	FLESH-ILLUMINATING DEVICE
F21V 3/02 (2006.01)	3727582	FLESH-ILLUMINATING DEVICE
F21V 3/04 (2018.01)	3727582	FLESH-ILLUMINATING DEVICE
H04N 19/124 (2014.01)	3716624	VIDEO ENCODING METHOD, COMPUTER DEVICE AND STORAGE MEDIUM
H04N 19/30 (2014.01)	3716624	VIDEO ENCODING METHOD, COMPUTER DEVICE AND STORAGE MEDIUM
A01K 61/60 (2017.01)	3713402	ROOF COVER FOR FISH FARM
A61K 9/51 (2006.01)	3713601	EPSTEIN-BARR VIRUS VACCINES
A61K 31/7115 (2006.01)	3713601	EPSTEIN-BARR VIRUS VACCINES
A61K 39/245 (2006.01)	3713601	EPSTEIN-BARR VIRUS VACCINES
A61P 31/22 (2006.01)	3713601	EPSTEIN-BARR VIRUS VACCINES
C12N 7/00 (2006.01)	3713601	EPSTEIN-BARR VIRUS VACCINES
A61K 31/437 (2006.01)	3717483	PYRAZOLOPYRIDINONE COMPOUNDS
A61P 35/00 (2006.01)	3717483	PYRAZOLOPYRIDINONE COMPOUNDS
C07D 471/04 (2006.01)	3717483	PYRAZOLOPYRIDINONE COMPOUNDS
C07D 519/00 (2006.01)	3717483	PYRAZOLOPYRIDINONE COMPOUNDS
A01K 61/60 (2017.01)	3713403	FISH FARM
C07D 403/12 (2006.01)	3717473	POLYMORPHS AND SOLID FORMS OF A PYRIMIDINYLAMINO-PYRAZOLE COMPOUND, AND METHODS OF PRODUCTION
C07D 403/14 (2006.01)	3717473	POLYMORPHS AND SOLID FORMS OF A PYRIMIDINYLAMINO-PYRAZOLE COMPOUND, AND METHODS OF PRODUCTION
C07D 405/14 (2006.01)	3717473	POLYMORPHS AND SOLID FORMS OF A PYRIMIDINYLAMINO-PYRAZOLE COMPOUND, AND METHODS OF PRODUCTION
C07D 413/14 (2006.01)	3717473	POLYMORPHS AND SOLID FORMS OF A PYRIMIDINYLAMINO-PYRAZOLE COMPOUND, AND METHODS OF PRODUCTION
A61K 38/28 (2006.01)	3713594	CHARGE-SWITCHABLE POLYMERIC DEPOT FOR GLUCOSE-TRIGGERED INSULIN DELIVERY WITH ULTRAFAST RESPONSE
C07K 14/62 (2006.01)	3713594	CHARGE-SWITCHABLE POLYMERIC DEPOT FOR GLUCOSE-TRIGGERED INSULIN DELIVERY WITH ULTRAFAST RESPONSE
A61K 39/00 (2006.01)	3717512	LYOPHILIZED FORMULATION OF A MONOCLONAL ANTIBODY AGAINST TRANSTHYRETIN
A61K 51/10 (2006.01)	3717512	LYOPHILIZED FORMULATION OF A MONOCLONAL ANTIBODY AGAINST TRANSTHYRETIN
C07K 16/18 (2006.01)	3717512	LYOPHILIZED FORMULATION OF A MONOCLONAL ANTIBODY AGAINST TRANSTHYRETIN
A61K 31/4245 (2006.01)	3717462	SULFONAMIDE COMPOUNDS AND USE THEREOF
A61P 35/00 (2006.01)	3717462	SULFONAMIDE COMPOUNDS AND USE THEREOF
C07D 271/113 (2006.01)	3717462	SULFONAMIDE COMPOUNDS AND USE THEREOF
C07D 413/12 (2006.01)	3717462	SULFONAMIDE COMPOUNDS AND USE THEREOF
A61K 47/68 (2017.01)	3717022	COMPOSITIONS AND METHODS FOR THE DEPLETION OF CD5+ CELLS
A61K 31/585 (2006.01)	3716982	ANTI-CD40 ANTIBODY DRUG CONJUGATES
A61K 39/395 (2006.01)	3716982	ANTI-CD40 ANTIBODY DRUG CONJUGATES
C07K 16/28 (2006.01)	3716982	ANTI-CD40 ANTIBODY DRUG CONJUGATES
A61K 31/165 (2006.01)	3716964	MYST FAMILY HISTONE ACETYLTRANSFERASE INHIBITORS
A61K 31/18 (2006.01)	3716964	MYST FAMILY HISTONE ACETYLTRANSFERASE INHIBITORS
A61K 31/40 (2006.01)	3716964	MYST FAMILY HISTONE ACETYLTRANSFERASE INHIBITORS
C07C 255/00 (2006.01)	3716964	MYST FAMILY HISTONE ACETYLTRANSFERASE INHIBITORS
C07C 307/02 (2006.01)	3716964	MYST FAMILY HISTONE ACETYLTRANSFERASE INHIBITORS
C07C 317/50 (2006.01)	3716964	MYST FAMILY HISTONE ACETYLTRANSFERASE INHIBITORS
A61K 38/00 (2006.01)	3717519	COMPOSITIONS AND METHODS FOR THE DEPLETION OF CD2+ CELLS
C07K 16/28 (2006.01)	3717519	COMPOSITIONS AND METHODS FOR THE DEPLETION OF CD2+ CELLS
A61K 31/4245 (2006.01)	3718545	ANTITUMOR AGENT
A61K 45/00 (2006.01)	3718545	ANTITUMOR AGENT
A61P 35/00 (2006.01)	3718545	ANTITUMOR AGENT
A61P 43/00 (2006.01)	3718545	ANTITUMOR AGENT

MKP (51)	Broj objave evropske prijava patenta (97)	Naziv pronalaska (54)
C07D 249/04 (2006.01)	3718545	ANTITUMOR AGENT
A01N 43/40 (2006.01)	3719004	PYRIDINIUM SALT AND PEST CONTROL AGENT
A01N 43/50 (2006.01)	3719004	PYRIDINIUM SALT AND PEST CONTROL AGENT
A01N 43/54 (2006.01)	3719004	PYRIDINIUM SALT AND PEST CONTROL AGENT
A01N 43/56 (2006.01)	3719004	PYRIDINIUM SALT AND PEST CONTROL AGENT
A01N 43/60 (2006.01)	3719004	PYRIDINIUM SALT AND PEST CONTROL AGENT
A01N 43/76 (2006.01)	3719004	PYRIDINIUM SALT AND PEST CONTROL AGENT
A01N 43/78 (2006.01)	3719004	PYRIDINIUM SALT AND PEST CONTROL AGENT
A01N 43/80 (2006.01)	3719004	PYRIDINIUM SALT AND PEST CONTROL AGENT
A01N 43/836 (2006.01)	3719004	PYRIDINIUM SALT AND PEST CONTROL AGENT
A01N 47/02 (2006.01)	3719004	PYRIDINIUM SALT AND PEST CONTROL AGENT
A01P 7/02 (2006.01)	3719004	PYRIDINIUM SALT AND PEST CONTROL AGENT
A01P 7/04 (2006.01)	3719004	PYRIDINIUM SALT AND PEST CONTROL AGENT
A01P 17/00 (2006.01)	3719004	PYRIDINIUM SALT AND PEST CONTROL AGENT
A61K 31/4425 (2006.01)	3719004	PYRIDINIUM SALT AND PEST CONTROL AGENT
A61P 33/00 (2006.01)	3719004	PYRIDINIUM SALT AND PEST CONTROL AGENT
C07D 213/89 (2006.01)	3719004	PYRIDINIUM SALT AND PEST CONTROL AGENT
C07D 401/12 (2006.01)	3719004	PYRIDINIUM SALT AND PEST CONTROL AGENT
C07D 405/12 (2006.01)	3719004	PYRIDINIUM SALT AND PEST CONTROL AGENT
C07D 409/12 (2006.01)	3719004	PYRIDINIUM SALT AND PEST CONTROL AGENT
C07D 413/12 (2006.01)	3719004	PYRIDINIUM SALT AND PEST CONTROL AGENT
C07D 417/12 (2006.01)	3719004	PYRIDINIUM SALT AND PEST CONTROL AGENT
A61K 38/00 (2006.01)	3717505	ENGINEERED DNA BINDING PROTEINS
C07K 14/00 (2006.01)	3717505	ENGINEERED DNA BINDING PROTEINS
C12Q 1/68 (2018.01)	3717505	ENGINEERED DNA BINDING PROTEINS
A61K 31/42 (2006.01)	3720438	HETEROCYCLE SUBSTITUTED PYRIDINE DERIVATIVE ANTIFUNGAL AGENTS
A61K 31/505 (2006.01)	3720438	HETEROCYCLE SUBSTITUTED PYRIDINE DERIVATIVE ANTIFUNGAL AGENTS
A61K 31/506 (2006.01)	3720438	HETEROCYCLE SUBSTITUTED PYRIDINE DERIVATIVE ANTIFUNGAL AGENTS
C07D 247/02 (2006.01)	3720438	HETEROCYCLE SUBSTITUTED PYRIDINE DERIVATIVE ANTIFUNGAL AGENTS
C07D 261/02 (2006.01)	3720438	HETEROCYCLE SUBSTITUTED PYRIDINE DERIVATIVE ANTIFUNGAL AGENTS
C07D 261/06 (2006.01)	3720438	HETEROCYCLE SUBSTITUTED PYRIDINE DERIVATIVE ANTIFUNGAL AGENTS
A61K 31/7088 (2006.01)	3720448	COMPOSITIONS AND METHODS OF TREATING MUSCLE ATROPHY AND MYOTONIC DYSTROPHY
A61K 31/712 (2006.01)	3720448	COMPOSITIONS AND METHODS OF TREATING MUSCLE ATROPHY AND MYOTONIC DYSTROPHY
A61K 31/713 (2006.01)	3720448	COMPOSITIONS AND METHODS OF TREATING MUSCLE ATROPHY AND MYOTONIC DYSTROPHY
A61K 39/395 (2006.01)	3720448	COMPOSITIONS AND METHODS OF TREATING MUSCLE ATROPHY AND MYOTONIC DYSTROPHY
A61K 47/68 (2017.01)	3720448	COMPOSITIONS AND METHODS OF TREATING MUSCLE ATROPHY AND MYOTONIC DYSTROPHY
C12N 15/113 (2010.01)	3720448	COMPOSITIONS AND METHODS OF TREATING MUSCLE ATROPHY AND MYOTONIC DYSTROPHY
A61K 9/08 (2006.01)	3720421	COMPOSITIONS AND METHODS FOR THE TREATMENT OF METABOLIC CONDITIONS
A61K 31/198 (2006.01)	3720421	COMPOSITIONS AND METHODS FOR THE TREATMENT OF METABOLIC CONDITIONS
A61K 31/375 (2006.01)	3720421	COMPOSITIONS AND METHODS FOR THE TREATMENT OF METABOLIC CONDITIONS
A61K 31/4415 (2006.01)	3720421	COMPOSITIONS AND METHODS FOR THE TREATMENT OF METABOLIC CONDITIONS
A61K 31/51 (2006.01)	3720421	COMPOSITIONS AND METHODS FOR THE TREATMENT OF METABOLIC CONDITIONS
A61K 31/525 (2006.01)	3720421	COMPOSITIONS AND METHODS FOR THE TREATMENT OF METABOLIC CONDITIONS
A61K 31/714 (2006.01)	3720421	COMPOSITIONS AND METHODS FOR THE TREATMENT OF METABOLIC CONDITIONS
A61K 33/14 (2006.01)	3720421	COMPOSITIONS AND METHODS FOR THE TREATMENT OF METABOLIC CONDITIONS
A61K 47/18 (2017.01)	3720421	COMPOSITIONS AND METHODS FOR THE TREATMENT OF METABOLIC CONDITIONS
C12N 5/10 (2006.01)	3720952	GENE EDITING USING A MODIFIED CLOSED-ENDED DNA (CEDNA)
C12N 9/22 (2006.01)	3720952	GENE EDITING USING A MODIFIED CLOSED-ENDED DNA (CEDNA)
C12N 15/09 (2006.01)	3720952	GENE EDITING USING A MODIFIED CLOSED-ENDED DNA (CEDNA)

MKP (51)	Broj objave evropske prijava patenta (97)	Naziv pronalaska (54)
C12N 15/113 (2010.01)	3720952	GENE EDITING USING A MODIFIED CLOSED-ENDED DNA (CEDNA)
C12N 15/63 (2006.01)	3720952	GENE EDITING USING A MODIFIED CLOSED-ENDED DNA (CEDNA)
C12N 15/64 (2006.01)	3720952	GENE EDITING USING A MODIFIED CLOSED-ENDED DNA (CEDNA)
C12N 15/66 (2006.01)	3720952	GENE EDITING USING A MODIFIED CLOSED-ENDED DNA (CEDNA)
C12N 15/90 (2006.01)	3720952	GENE EDITING USING A MODIFIED CLOSED-ENDED DNA (CEDNA)
A61K 9/00 (2006.01)	3720487	FORMULATIONS OF DENGUE VIRUS VACCINE COMPOSITIONS
A61K 9/14 (2006.01)	3720487	FORMULATIONS OF DENGUE VIRUS VACCINE COMPOSITIONS
A61K 39/12 (2006.01)	3720487	FORMULATIONS OF DENGUE VIRUS VACCINE COMPOSITIONS
A61K 47/26 (2006.01)	3720487	FORMULATIONS OF DENGUE VIRUS VACCINE COMPOSITIONS
C07K 16/18 (2006.01)	3724227	SICKLED BETA GLOBIN ANTIBODIES
C07K 16/34 (2006.01)	3724227	SICKLED BETA GLOBIN ANTIBODIES
C07K 16/44 (2006.01)	3724227	SICKLED BETA GLOBIN ANTIBODIES
G01N 33/53 (2006.01)	3724227	SICKLED BETA GLOBIN ANTIBODIES
G01N 33/577 (2006.01)	3724227	SICKLED BETA GLOBIN ANTIBODIES
G01N 33/72 (2006.01)	3724227	SICKLED BETA GLOBIN ANTIBODIES
C10L 5/14 (2006.01)	3724300	TORREFIED BIOMASS BRIQUETTES AND RELATED METHODS
C10L 5/44 (2006.01)	3724300	TORREFIED BIOMASS BRIQUETTES AND RELATED METHODS
A61K 38/17 (2006.01)	3723788	CD19 VARIANTS
A61K 39/395 (2006.01)	3723788	CD19 VARIANTS
C07K 14/705 (2006.01)	3723788	CD19 VARIANTS
C07K 16/28 (2006.01)	3723788	CD19 VARIANTS
C07K 7/00 (2006.01)	3724208	COMPOSITIONS COMPRISING CIRCULAR POLYRIBONUCLEOTIDES AND USES THEREOF
C07K 7/06 (2006.01)	3724208	COMPOSITIONS COMPRISING CIRCULAR POLYRIBONUCLEOTIDES AND USES THEREOF
C12P 21/00 (2006.01)	3724208	COMPOSITIONS COMPRISING CIRCULAR POLYRIBONUCLEOTIDES AND USES THEREOF
G03G 21/18 (2006.01)	3726298	CARTRIDGE AND IMAGE FORMING DEVICE {}
A61K 31/437 (2006.01)	3723757	SMALL MOLECULE DEGRADERS THAT RECRUIT DCAFT15
C07D 409/14 (2006.01)	3723757	SMALL MOLECULE DEGRADERS THAT RECRUIT DCAFT15
C07D 513/16 (2006.01)	3723757	SMALL MOLECULE DEGRADERS THAT RECRUIT DCAFT15
A61K 38/16 (2006.01)	3723787	DARIC INTERLEUKIN RECEPTORS
C07K 14/435 (2006.01)	3723787	DARIC INTERLEUKIN RECEPTORS
C12N 15/62 (2006.01)	3723787	DARIC INTERLEUKIN RECEPTORS
C07K 14/705 (2006.01)	3724220	NKG2D DARIC RECEPTORS
C12N 5/00 (2006.01)	3724220	NKG2D DARIC RECEPTORS
A61K 38/04 (2006.01)	3724211	DOSING REGIMENS AND RELATED COMPOSITIONS AND METHODS
A61K 38/12 (2006.01)	3724211	DOSING REGIMENS AND RELATED COMPOSITIONS AND METHODS
C07K 7/06 (2006.01)	3724211	DOSING REGIMENS AND RELATED COMPOSITIONS AND METHODS
C07K 7/50 (2006.01)	3724211	DOSING REGIMENS AND RELATED COMPOSITIONS AND METHODS
C07K 7/64 (2006.01)	3724211	DOSING REGIMENS AND RELATED COMPOSITIONS AND METHODS
C07K 14/47 (2006.01)	3724211	DOSING REGIMENS AND RELATED COMPOSITIONS AND METHODS
A61K 9/16 (2006.01)	3727353	SURFACTANT FORMULATIONS FOR INHALATION
A61K 9/72 (2006.01)	3727353	SURFACTANT FORMULATIONS FOR INHALATION
A61P 11/16 (2006.01)	3727353	SURFACTANT FORMULATIONS FOR INHALATION
C07K 14/785 (2006.01)	3727353	SURFACTANT FORMULATIONS FOR INHALATION
C07D 231/56 (2006.01)	3728202	DIARYL SUBSTITUTED 5,5-FUSED RING COMPOUNDS AS C5AR INHIBITORS
C07D 471/04 (2006.01)	3728202	DIARYL SUBSTITUTED 5,5-FUSED RING COMPOUNDS AS C5AR INHIBITORS
A01G 9/24 (2006.01)	3729160	METHODS AND DEVICES FOR STIMULATING GROWTH OF GRAPE VINES, GRAPE VINE REPLANTS OR AGRICULTURAL CROPS
G02B 19/00 (2006.01)	3729160	METHODS AND DEVICES FOR STIMULATING GROWTH OF GRAPE VINES, GRAPE VINE REPLANTS OR AGRICULTURAL CROPS
C07D 231/56 (2006.01)	3728203	DIARYL SUBSTITUTED 6,5-FUSED RING COMPOUNDS AS C5aR INHIBITORS
C07D 471/04 (2006.01)	3728203	DIARYL SUBSTITUTED 6,5-FUSED RING COMPOUNDS AS C5aR INHIBITORS
A61K 31/513 (2006.01)	3730935	METHOD FOR DETECTING TRIFLURIDINE- AND/OR TIPIRACIL- DERIVED ANALOGS
A61K 31/7072 (2006.01)	3730935	METHOD FOR DETECTING TRIFLURIDINE- AND/OR TIPIRACIL- DERIVED ANALOGS
A61P 35/00 (2006.01)	3730935	METHOD FOR DETECTING TRIFLURIDINE- AND/OR TIPIRACIL- DERIVED ANALOGS

MKP (51)	Broj objave evropske prijava patenta (97)	Naziv pronalaska (54)
C07H 19/073 (2006.01)	3730935	METHOD FOR DETECTING TRIFLURIDINE- AND/OR TPIRACIL-DERIVED ANALOGS
G01N 30/26 (2006.01)	3730935	METHOD FOR DETECTING TRIFLURIDINE- AND/OR TPIRACIL-DERIVED ANALOGS
G01N 30/88 (2006.01)	3730935	METHOD FOR DETECTING TRIFLURIDINE- AND/OR TPIRACIL-DERIVED ANALOGS
A61K 9/00 (2006.01)	3727468	AAV-MEDIATED DELIVERY OF THERAPEUTIC ANTIBODIES TO THE INNER EAR
A61K 39/395 (2006.01)	3727468	AAV-MEDIATED DELIVERY OF THERAPEUTIC ANTIBODIES TO THE INNER EAR
A61K 48/00 (2006.01)	3727468	AAV-MEDIATED DELIVERY OF THERAPEUTIC ANTIBODIES TO THE INNER EAR
A61P 27/16 (2006.01)	3727468	AAV-MEDIATED DELIVERY OF THERAPEUTIC ANTIBODIES TO THE INNER EAR
C12N 15/113 (2010.01)	3727468	AAV-MEDIATED DELIVERY OF THERAPEUTIC ANTIBODIES TO THE INNER EAR
A61K 31/155 (2006.01)	3727363	TRANSDERMAL NON-AQUEOUS NANOEMULGELS FOR SYSTEMIC DELIVERY OF AROMATASE INHIBITOR
A61K 31/4164 (2006.01)	3727363	TRANSDERMAL NON-AQUEOUS NANOEMULGELS FOR SYSTEMIC DELIVERY OF AROMATASE INHIBITOR
A61K 31/496 (2006.01)	3727363	TRANSDERMAL NON-AQUEOUS NANOEMULGELS FOR SYSTEMIC DELIVERY OF AROMATASE INHIBITOR
A61K 31/282 (2006.01)	3727368	METHODS OF TREATING COLON CANCER USING NANOPARTICLE MTOR INHIBITOR COMBINATION THERAPY
A61K 31/436 (2006.01)	3727368	METHODS OF TREATING COLON CANCER USING NANOPARTICLE MTOR INHIBITOR COMBINATION THERAPY
A61K 31/513 (2006.01)	3727368	METHODS OF TREATING COLON CANCER USING NANOPARTICLE MTOR INHIBITOR COMBINATION THERAPY
A61K 31/519 (2006.01)	3727368	METHODS OF TREATING COLON CANCER USING NANOPARTICLE MTOR INHIBITOR COMBINATION THERAPY
A61K 39/395 (2006.01)	3727368	METHODS OF TREATING COLON CANCER USING NANOPARTICLE MTOR INHIBITOR COMBINATION THERAPY
A61P 35/00 (2006.01)	3727368	METHODS OF TREATING COLON CANCER USING NANOPARTICLE MTOR INHIBITOR COMBINATION THERAPY
A47F 9/04 (2006.01)	3729375	A RETAIL CHECKOUT TERMINAL FRESH PRODUCE IDENTIFICATION SYSTEM
G06Q 30/06 (2012.01)	3729375	A RETAIL CHECKOUT TERMINAL FRESH PRODUCE IDENTIFICATION SYSTEM
G06T 7/41 (2017.01)	3729375	A RETAIL CHECKOUT TERMINAL FRESH PRODUCE IDENTIFICATION SYSTEM
G07G 1/12 (2006.01)	3729375	A RETAIL CHECKOUT TERMINAL FRESH PRODUCE IDENTIFICATION SYSTEM
A61K 31/47 (2006.01)	3728260	EXO-AZA SPIRO INHIBITORS OF MENIN-MLL INTERACTION
A61K 31/519 (2006.01)	3728260	EXO-AZA SPIRO INHIBITORS OF MENIN-MLL INTERACTION
A61P 35/02 (2006.01)	3728260	EXO-AZA SPIRO INHIBITORS OF MENIN-MLL INTERACTION
C07D 471/10 (2006.01)	3728260	EXO-AZA SPIRO INHIBITORS OF MENIN-MLL INTERACTION
C07D 487/10 (2006.01)	3728260	EXO-AZA SPIRO INHIBITORS OF MENIN-MLL INTERACTION
C07D 495/04 (2006.01)	3728260	EXO-AZA SPIRO INHIBITORS OF MENIN-MLL INTERACTION
A61K 39/12 (2006.01)	3730620	CROSS-IMMUNIZING ANTIGEN VACCINE AND METHOD FOR PREPARATION THEREOF
A61K 39/145 (2006.01)	3730620	CROSS-IMMUNIZING ANTIGEN VACCINE AND METHOD FOR PREPARATION THEREOF
A61K 39/295 (2006.01)	3730620	CROSS-IMMUNIZING ANTIGEN VACCINE AND METHOD FOR PREPARATION THEREOF
A61P 31/14 (2006.01)	3730620	CROSS-IMMUNIZING ANTIGEN VACCINE AND METHOD FOR PREPARATION THEREOF
A61P 31/16 (2006.01)	3730620	CROSS-IMMUNIZING ANTIGEN VACCINE AND METHOD FOR PREPARATION THEREOF
C07K 14/08 (2006.01)	3730620	CROSS-IMMUNIZING ANTIGEN VACCINE AND METHOD FOR PREPARATION THEREOF
C07K 14/11 (2006.01)	3730620	CROSS-IMMUNIZING ANTIGEN VACCINE AND METHOD FOR PREPARATION THEREOF
C07K 19/00 (2006.01)	3730620	CROSS-IMMUNIZING ANTIGEN VACCINE AND METHOD FOR PREPARATION THEREOF
C12N 15/40 (2006.01)	3730620	CROSS-IMMUNIZING ANTIGEN VACCINE AND METHOD FOR PREPARATION THEREOF
C12N 15/44 (2006.01)	3730620	CROSS-IMMUNIZING ANTIGEN VACCINE AND METHOD FOR PREPARATION THEREOF
C12N 15/62 (2006.01)	3730620	CROSS-IMMUNIZING ANTIGEN VACCINE AND METHOD FOR PREPARATION THEREOF

MKP (51)	Broj objave evropske prijava patenta (97)	Naziv pronalaska (54)
C07K 16/46 (2006.01)	3732205	MULTIVALENT CHIMERIC ANTIGEN RECEPTOR
A61K 31/427 (2006.01)	3727377	PROCESS FOR THE PREPARATION OF PYRIMIDINYL-4-AMINOPYRAZOLE COMPOUNDS
A61K 31/4439 (2006.01)	3727377	PROCESS FOR THE PREPARATION OF PYRIMIDINYL-4-AMINOPYRAZOLE COMPOUNDS
A61K 35/17 (2015.01)	3730612	IMMUNOCOMPETENT CELL THAT EXPRESSES A CELL SURFACE MOLECULE SPECIFICALLY RECOGNIZING HUMAN MESOTHELIN, IL-7 AND CCL19
A61P 35/00 (2006.01)	3730612	IMMUNOCOMPETENT CELL THAT EXPRESSES A CELL SURFACE MOLECULE SPECIFICALLY RECOGNIZING HUMAN MESOTHELIN, IL-7 AND CCL19
C07K 14/52 (2006.01)	3730612	IMMUNOCOMPETENT CELL THAT EXPRESSES A CELL SURFACE MOLECULE SPECIFICALLY RECOGNIZING HUMAN MESOTHELIN, IL-7 AND CCL19
C07K 14/54 (2006.01)	3730612	IMMUNOCOMPETENT CELL THAT EXPRESSES A CELL SURFACE MOLECULE SPECIFICALLY RECOGNIZING HUMAN MESOTHELIN, IL-7 AND CCL19
C07K 14/705 (2006.01)	3730612	IMMUNOCOMPETENT CELL THAT EXPRESSES A CELL SURFACE MOLECULE SPECIFICALLY RECOGNIZING HUMAN MESOTHELIN, IL-7 AND CCL19
C07K 19/00 (2006.01)	3730612	IMMUNOCOMPETENT CELL THAT EXPRESSES A CELL SURFACE MOLECULE SPECIFICALLY RECOGNIZING HUMAN MESOTHELIN, IL-7 AND CCL19
C12N 5/0783 (2010.01)	3730612	IMMUNOCOMPETENT CELL THAT EXPRESSES A CELL SURFACE MOLECULE SPECIFICALLY RECOGNIZING HUMAN MESOTHELIN, IL-7 AND CCL19
C12N 15/09 (2006.01)	3730612	IMMUNOCOMPETENT CELL THAT EXPRESSES A CELL SURFACE MOLECULE SPECIFICALLY RECOGNIZING HUMAN MESOTHELIN, IL-7 AND CCL19
A61K 38/00 (2006.01)	3727418	SURFACTANT FORMULATIONS FOR INHALATION
C07K 14/435 (2006.01)	3727418	SURFACTANT FORMULATIONS FOR INHALATION
C07K 19/00 (2006.01)	3727418	SURFACTANT FORMULATIONS FOR INHALATION
C07H 21/04 (2006.01)	3732187	UNNATURAL BASE PAIR COMPOSITIONS AND METHODS OF USE
C07K 14/34 (2006.01)	3732187	UNNATURAL BASE PAIR COMPOSITIONS AND METHODS OF USE
C12N 1/20 (2006.01)	3732187	UNNATURAL BASE PAIR COMPOSITIONS AND METHODS OF USE
C12N 1/21 (2006.01)	3732187	UNNATURAL BASE PAIR COMPOSITIONS AND METHODS OF USE
C07D 239/47 (2006.01)	3732166	PROCESS FOR THE PREPARATION OF AN AMINO-PYRIMIDINE AND INTERMEDIATES THEREOF
C07D 401/10 (2006.01)	3732166	PROCESS FOR THE PREPARATION OF AN AMINO-PYRIMIDINE AND INTERMEDIATES THEREOF
C07D 401/12 (2006.01)	3732166	PROCESS FOR THE PREPARATION OF AN AMINO-PYRIMIDINE AND INTERMEDIATES THEREOF
A61K 31/438 (2006.01)	3636637	INHIBITING FATTY ACID SYNTHASE (FASN)
A61P 1/16 (2006.01)	3636637	INHIBITING FATTY ACID SYNTHASE (FASN)
C07D 221/20 (2006.01)	3636637	INHIBITING FATTY ACID SYNTHASE (FASN)
C07D 401/06 (2006.01)	3636637	INHIBITING FATTY ACID SYNTHASE (FASN)
C07D 401/10 (2006.01)	3636637	INHIBITING FATTY ACID SYNTHASE (FASN)
C07D 405/06 (2006.01)	3636637	INHIBITING FATTY ACID SYNTHASE (FASN)
C07D 405/14 (2006.01)	3636637	INHIBITING FATTY ACID SYNTHASE (FASN)
C07D 409/14 (2006.01)	3636637	INHIBITING FATTY ACID SYNTHASE (FASN)
C07D 413/06 (2006.01)	3636637	INHIBITING FATTY ACID SYNTHASE (FASN)
C07D 413/10 (2006.01)	3636637	INHIBITING FATTY ACID SYNTHASE (FASN)
C07D 413/14 (2006.01)	3636637	INHIBITING FATTY ACID SYNTHASE (FASN)
A61P 35/00 (2006.01)	3628688	ANTI-CEACAM6 ANTIBODIES AND USES THEREOF
C07K 16/28 (2006.01)	3628688	ANTI-CEACAM6 ANTIBODIES AND USES THEREOF
G03G 15/00 (2006.01)	3629092	DRUM UNIT, CARTRIDGE, ELECTROPHOTOGRAPHIC IMAGE FORMING APPARATUS AND COUPLING MEMBER
A01N 25/12 (2006.01)	3639666	USE OF LECITHINS AS A BIOCIDES AGAINST ARTHROPODS
A01N 37/04 (2006.01)	3639666	USE OF LECITHINS AS A BIOCIDES AGAINST ARTHROPODS
A01N 43/90 (2006.01)	3639666	USE OF LECITHINS AS A BIOCIDES AGAINST ARTHROPODS
A01N 57/12 (2006.01)	3639666	USE OF LECITHINS AS A BIOCIDES AGAINST ARTHROPODS
A01P 7/00 (2006.01)	3639666	USE OF LECITHINS AS A BIOCIDES AGAINST ARTHROPODS
A61K 39/395 (2006.01)	3620175	HIGH CONCENTRATION ANTIBODY FORMULATIONS
A61K 47/12 (2006.01)	3620175	HIGH CONCENTRATION ANTIBODY FORMULATIONS
C07K 16/22 (2006.01)	3620175	HIGH CONCENTRATION ANTIBODY FORMULATIONS
A61K 39/145 (2006.01)	3653701	ATTENUATED INFLUENZA VIRUSES AND VACCINES
A61P 31/16 (2006.01)	3653701	ATTENUATED INFLUENZA VIRUSES AND VACCINES
C12N 7/04 (2006.01)	3653701	ATTENUATED INFLUENZA VIRUSES AND VACCINES
A61K 39/00 (2006.01)	3656399	STABLE FORMULATIONS CONTAINING ANTI-PCSK9 ANTIBODIES
A61K 39/395 (2006.01)	3656399	STABLE FORMULATIONS CONTAINING ANTI-PCSK9 ANTIBODIES

MKP (51)	Broj objave evropske prijava patenta (97)	Naziv pronalaska (54)
A61P 3/06 (2006.01)	3656399	STABLE FORMULATIONS CONTAINING ANTI-PCSK9 ANTIBODIES
C07K 16/40 (2006.01)	3656399	STABLE FORMULATIONS CONTAINING ANTI-PCSK9 ANTIBODIES
G06F 8/60 (2018.01)	3640816	IDENTIFYING APPLICATIONS WITH MACHINE LEARNING
G06F 16/28 (2019.01)	3640816	IDENTIFYING APPLICATIONS WITH MACHINE LEARNING
H04L 12/24 (2006.01)	3641221	IDENTIFYING COMPUTING DEVICES IN A MANAGED NETWORK THAT ARE INVOLVED IN BLOCKCHAIN-BASED MINING
A61K 9/51 (2006.01)	3650047	PEPTIDE CONJUGATED PARTICLES
A61K 39/00 (2006.01)	3650047	PEPTIDE CONJUGATED PARTICLES
A61K 47/69 (2017.01)	3650047	PEPTIDE CONJUGATED PARTICLES
A61P 1/00 (2006.01)	3650047	PEPTIDE CONJUGATED PARTICLES
A61P 11/06 (2006.01)	3650047	PEPTIDE CONJUGATED PARTICLES
A61P 13/12 (2006.01)	3650047	PEPTIDE CONJUGATED PARTICLES
A61P 19/06 (2006.01)	3650047	PEPTIDE CONJUGATED PARTICLES
A61P 25/00 (2006.01)	3650047	PEPTIDE CONJUGATED PARTICLES
A61K 31/00 (2006.01)	3653733	METHODS AND COMPOSITIONS FOR DETERMINING RESISTANCE TO ANDROGEN RECEPTOR THERAPY
C07K 14/72 (2006.01)	3653733	METHODS AND COMPOSITIONS FOR DETERMINING RESISTANCE TO ANDROGEN RECEPTOR THERAPY
C07K 16/28 (2006.01)	3653733	METHODS AND COMPOSITIONS FOR DETERMINING RESISTANCE TO ANDROGEN RECEPTOR THERAPY
C12Q 1/6886 (2018.01)	3653733	METHODS AND COMPOSITIONS FOR DETERMINING RESISTANCE TO ANDROGEN RECEPTOR THERAPY
A61K 39/395 (2006.01)	3626267	TREATMENT FOR BONE DISEASES
C07K 16/22 (2006.01)	3626267	TREATMENT FOR BONE DISEASES
A61B 17/32 (2006.01)	3626185	SURGICAL INSTRUMENT WITH FUNCTION SELECTOR
A61B 18/14 (2006.01)	3626185	SURGICAL INSTRUMENT WITH FUNCTION SELECTOR
A61K 48/00 (2006.01)	3628335	LIPIDIC NANOPARTICLES FOR MRNA DELIVERY IN THE LUNGS
H01M 2/02 (2006.01)	3657566	PLUG DEVICE FOR BATTERY, BATTERY AND MOTOR VEHICLE
H01M 2/20 (2006.01)	3657566	PLUG DEVICE FOR BATTERY, BATTERY AND MOTOR VEHICLE
H01M 2/30 (2006.01)	3657566	PLUG DEVICE FOR BATTERY, BATTERY AND MOTOR VEHICLE
A61K 31/519 (2006.01)	3632442	USE OF PYRAZOLOPYRIMIDINE DERIVATIVES FOR THE TREATMENT OF PI3K RELATED DISORDERS
A61K 31/5377 (2006.01)	3632442	USE OF PYRAZOLOPYRIMIDINE DERIVATIVES FOR THE TREATMENT OF PI3K RELATED DISORDERS
A61P 35/00 (2006.01)	3632442	USE OF PYRAZOLOPYRIMIDINE DERIVATIVES FOR THE TREATMENT OF PI3K RELATED DISORDERS
A61K 31/513 (2006.01)	3656384	COMBINATIONS COMPRISING 5-PHENOXY-3H-PYRIMIDIN-4-ONE DERIVATIVES AND THEIR USE FOR THE PROPHYLAXIS OR TREATMENT OF INFECTION BY HIV
A61P 31/18 (2006.01)	3656384	COMBINATIONS COMPRISING 5-PHENOXY-3H-PYRIMIDIN-4-ONE DERIVATIVES AND THEIR USE FOR THE PROPHYLAXIS OR TREATMENT OF INFECTION BY HIV
F17C 13/04 (2006.01)	3660381	FITTING FOR LIQUEFIED GAS BOTTLES AND FILLING METHOD
H02S 20/00 (2014.01)	3661050	SUBSTRUCTURE FOR SOLAR MODULES IN FRAMES AND MODULE CLAMP FOR MOUNTING SOLAR MODULES IN FRAMES ON A MODULE SUPPORT
A61K 39/155 (2006.01)	3656396	RECOMBINANT MODIFIED VACCINIA VIRUS ANKARA (MVA) RESPIRATORY SYNCYTIAL VIRUS (RSV) VACCINE
A01K 67/027 (2006.01)	3636073	HUMANIZED C5 AND C3 ANIMALS
A61K 49/00 (2006.01)	3636073	HUMANIZED C5 AND C3 ANIMALS
C07K 14/47 (2006.01)	3636073	HUMANIZED C5 AND C3 ANIMALS
C12N 15/85 (2006.01)	3636073	HUMANIZED C5 AND C3 ANIMALS
A61K 39/395 (2006.01)	3653225	METHODS FOR TREATING OR PREVENTING MIGRAINE HEADACHE USING ANTIBODIES DIRECTED AT THE CGRP RECEPTOR
C07K 16/28 (2006.01)	3653225	METHODS FOR TREATING OR PREVENTING MIGRAINE HEADACHE USING ANTIBODIES DIRECTED AT THE CGRP RECEPTOR
C07K 16/28 (2006.01)	3699195	BISPECIFIC ANTIBODIES THAT BIND TO CD38 AND CD3
C07K 16/30 (2006.01)	3699195	BISPECIFIC ANTIBODIES THAT BIND TO CD38 AND CD3
C07K 16/46 (2006.01)	3699195	BISPECIFIC ANTIBODIES THAT BIND TO CD38 AND CD3
C07D 401/14 (2006.01)	3660011	BENZOIMIDAZOL-2-YL PYRIMIDINE MODULATORS OF THE HISTAMINE H4 RECEPTOR
A61K 9/16 (2006.01)	3656379	PHARMACEUTICAL COMPOSITIONS COMPRISING DIMETHYL FUMARATE
A61K 9/28 (2006.01)	3656379	PHARMACEUTICAL COMPOSITIONS COMPRISING DIMETHYL FUMARATE
A61K 31/225 (2006.01)	3656379	PHARMACEUTICAL COMPOSITIONS COMPRISING DIMETHYL FUMARATE

MKP (51)	Broj objave evropske prijava patenta (97)	Naziv pronalaska (54)
A61K 39/35 (2006.01)	3660047	HUMAN ANTIBODIES TO FEL D1 AND METHODS OF USE THEREOF
A61P 37/08 (2006.01)	3660047	HUMAN ANTIBODIES TO FEL D1 AND METHODS OF USE THEREOF
C07K 16/18 (2006.01)	3660047	HUMAN ANTIBODIES TO FEL D1 AND METHODS OF USE THEREOF
A61K 39/00 (2006.01)	3685855	HUMAN ANTI-VEGFR-2/KDR ANTIBODIES
A61K 39/395 (2006.01)	3685855	HUMAN ANTI-VEGFR-2/KDR ANTIBODIES
A61K 45/06 (2006.01)	3685855	HUMAN ANTI-VEGFR-2/KDR ANTIBODIES
A61P 35/00 (2006.01)	3685855	HUMAN ANTI-VEGFR-2/KDR ANTIBODIES
C07K 16/28 (2006.01)	3685855	HUMAN ANTI-VEGFR-2/KDR ANTIBODIES
A61K 31/192 (2006.01)	3713554	DOSAGE REGIMEN OF VIDOFLUDIMUS FOR USE IN THE PREVENTION OR TREATMENT OF CHRONIC INFLAMMATORY AND/OR AUTOIMMUNE DISEASES
A61P 29/00 (2006.01)	3713554	DOSAGE REGIMEN OF VIDOFLUDIMUS FOR USE IN THE PREVENTION OR TREATMENT OF CHRONIC INFLAMMATORY AND/OR AUTOIMMUNE DISEASES
G09F 3/02 (2006.01)	3714449	LABEL AND MANUFACTURING METHOD
G09F 3/10 (2006.01)	3714449	LABEL AND MANUFACTURING METHOD
B21B 21/00 (2006.01)	3717143	ROLL STAND
A63H 33/08 (2006.01)	3717088	KIT FOR CONSTRUCTING DRY-MOUNTED WALLS
E04B 2/08 (2006.01)	3717088	KIT FOR CONSTRUCTING DRY-MOUNTED WALLS
E04H 9/02 (2006.01)	3717088	KIT FOR CONSTRUCTING DRY-MOUNTED WALLS
A61K 31/381 (2006.01)	3717486	PYRAZOLOPYRIMIDINES HAVING ACTIVITY AGAINST THE RESPIRATORY SYNCYTIAL VIRUS (RSV)
A61P 31/16 (2006.01)	3717486	PYRAZOLOPYRIMIDINES HAVING ACTIVITY AGAINST THE RESPIRATORY SYNCYTIAL VIRUS (RSV)
C07D 487/04 (2006.01)	3717486	PYRAZOLOPYRIMIDINES HAVING ACTIVITY AGAINST THE RESPIRATORY SYNCYTIAL VIRUS (RSV)
C07D 495/04 (2006.01)	3717486	PYRAZOLOPYRIMIDINES HAVING ACTIVITY AGAINST THE RESPIRATORY SYNCYTIAL VIRUS (RSV)
C07D 513/04 (2006.01)	3717486	PYRAZOLOPYRIMIDINES HAVING ACTIVITY AGAINST THE RESPIRATORY SYNCYTIAL VIRUS (RSV)
C07D 519/00 (2006.01)	3717486	PYRAZOLOPYRIMIDINES HAVING ACTIVITY AGAINST THE RESPIRATORY SYNCYTIAL VIRUS (RSV)
A61K 9/20 (2006.01)	3607938	PHARMACEUTICAL COMPOSITION
A61K 9/48 (2006.01)	3607938	PHARMACEUTICAL COMPOSITION
A61K 9/50 (2006.01)	3607938	PHARMACEUTICAL COMPOSITION
A61K 31/198 (2006.01)	3607938	PHARMACEUTICAL COMPOSITION
A61K 45/06 (2006.01)	3607938	PHARMACEUTICAL COMPOSITION
A61K 47/58 (2017.01)	3607938	PHARMACEUTICAL COMPOSITION
G03G 15/00 (2006.01)	3633461	DRUM UNIT, CARTRIDGE AND COUPLING MEMBER
G03G 15/08 (2006.01)	3633461	DRUM UNIT, CARTRIDGE AND COUPLING MEMBER
G03G 21/16 (2006.01)	3633461	DRUM UNIT, CARTRIDGE AND COUPLING MEMBER
G03G 21/18 (2006.01)	3633461	DRUM UNIT, CARTRIDGE AND COUPLING MEMBER
C07C 51/16 (2006.01)	3587400	PROCESS FOR THE PREPARATION OF A PDE4 INHIBITOR
C07C 67/30 (2006.01)	3587400	PROCESS FOR THE PREPARATION OF A PDE4 INHIBITOR
C07C 67/39 (2006.01)	3587400	PROCESS FOR THE PREPARATION OF A PDE4 INHIBITOR
C07D 213/61 (2006.01)	3587400	PROCESS FOR THE PREPARATION OF A PDE4 INHIBITOR
C07D 213/89 (2006.01)	3587400	PROCESS FOR THE PREPARATION OF A PDE4 INHIBITOR
A61K 31/404 (2006.01)	3617192	VIRAL REPLICATION INHIBITORS
A61P 31/14 (2006.01)	3617192	VIRAL REPLICATION INHIBITORS
C07D 209/14 (2006.01)	3617192	VIRAL REPLICATION INHIBITORS
C07D 401/08 (2006.01)	3617192	VIRAL REPLICATION INHIBITORS
C07D 401/12 (2006.01)	3617192	VIRAL REPLICATION INHIBITORS
C07D 401/14 (2006.01)	3617192	VIRAL REPLICATION INHIBITORS
C07D 403/08 (2006.01)	3617192	VIRAL REPLICATION INHIBITORS
C07D 403/10 (2006.01)	3617192	VIRAL REPLICATION INHIBITORS
C07D 403/12 (2006.01)	3617192	VIRAL REPLICATION INHIBITORS
C07D 405/12 (2006.01)	3617192	VIRAL REPLICATION INHIBITORS
C07D 409/08 (2006.01)	3617192	VIRAL REPLICATION INHIBITORS
C07D 409/12 (2006.01)	3617192	VIRAL REPLICATION INHIBITORS
C07D 413/08 (2006.01)	3617192	VIRAL REPLICATION INHIBITORS
C07D 413/12 (2006.01)	3617192	VIRAL REPLICATION INHIBITORS
C07D 417/14 (2006.01)	3617192	VIRAL REPLICATION INHIBITORS
C07D 471/04 (2006.01)	3617192	VIRAL REPLICATION INHIBITORS
C07D 487/04 (2006.01)	3617192	VIRAL REPLICATION INHIBITORS
C07D 495/04 (2006.01)	3617192	VIRAL REPLICATION INHIBITORS
C07D 498/04 (2006.01)	3617192	VIRAL REPLICATION INHIBITORS
C07D 513/04 (2006.01)	3617192	VIRAL REPLICATION INHIBITORS

MKP (51)	Broj objave evropske prijava patenta (97)	Naziv pronalaska (54)
A61K 39/395 (2006.01)	3620467	CD37-BINDING MOLECULES AND IMMUNOCONJUGATES THEREOF
A61P 35/00 (2006.01)	3620467	CD37-BINDING MOLECULES AND IMMUNOCONJUGATES THEREOF
A61P 35/02 (2006.01)	3620467	CD37-BINDING MOLECULES AND IMMUNOCONJUGATES THEREOF
C07K 16/28 (2006.01)	3620467	CD37-BINDING MOLECULES AND IMMUNOCONJUGATES THEREOF
C07K 1/22 (2006.01)	3728288	METHODS FOR ENHANCED REMOVAL OF IMPURITIES DURING PROTEIN A CHROMATOGRAPHY
C12N 9/22 (2006.01)	3724342	MATERIALS AND METHODS FOR TREATMENT OF AUTOSOMAL DOMINANT CONE-ROD DYSTROPHY
C12N 15/113 (2010.01)	3724342	MATERIALS AND METHODS FOR TREATMENT OF AUTOSOMAL DOMINANT CONE-ROD DYSTROPHY
C12N 15/90 (2006.01)	3724342	MATERIALS AND METHODS FOR TREATMENT OF AUTOSOMAL DOMINANT CONE-ROD DYSTROPHY
A61P 27/02 (2006.01)	3728594	MATERIALS AND METHODS FOR TREATMENT OF USHER SYNDROME TYPE 2A
C12N 15/113 (2010.01)	3728594	MATERIALS AND METHODS FOR TREATMENT OF USHER SYNDROME TYPE 2A
A61P 27/02 (2006.01)	3728595	MATERIALS AND METHODS FOR TREATMENT OF USHER SYNDROME TYPE 2A AND/OR NON-SYNDROMIC AUTOSOMAL RECESSIVE RETINITIS PIGMENTOSA (ARRP)
C12N 15/113 (2010.01)	3728595	MATERIALS AND METHODS FOR TREATMENT OF USHER SYNDROME TYPE 2A AND/OR NON-SYNDROMIC AUTOSOMAL RECESSIVE RETINITIS PIGMENTOSA (ARRP)
A61K 38/17 (2006.01)	3733196	PHARMACEUTICAL COMPOSITION COMPRISING AN APL PEPTIDE
A61P 29/00 (2006.01)	3733196	PHARMACEUTICAL COMPOSITION COMPRISING AN APL PEPTIDE
C07K 14/47 (2006.01)	3733196	PHARMACEUTICAL COMPOSITION COMPRISING AN APL PEPTIDE
A61K 39/245 (2006.01)	3728291	EPSTEIN-BARR VIRUS ANTIGEN CONSTRUCTS
A61K 39/295 (2006.01)	3728291	EPSTEIN-BARR VIRUS ANTIGEN CONSTRUCTS
C07K 14/05 (2006.01)	3728291	EPSTEIN-BARR VIRUS ANTIGEN CONSTRUCTS
A61K 31/11 (2006.01)	3731933	ASYMMETRIC DERIVATIVES OF POLYPHENOLS OF THE DINAPHTHALINE SERIES, PROCESS OF PREPARING AND USE THEREOF
A61P 31/12 (2006.01)	3731933	ASYMMETRIC DERIVATIVES OF POLYPHENOLS OF THE DINAPHTHALINE SERIES, PROCESS OF PREPARING AND USE THEREOF
C07C 43/20 (2006.01)	3731933	ASYMMETRIC DERIVATIVES OF POLYPHENOLS OF THE DINAPHTHALINE SERIES, PROCESS OF PREPARING AND USE THEREOF
C07C 47/57 (2006.01)	3731933	ASYMMETRIC DERIVATIVES OF POLYPHENOLS OF THE DINAPHTHALINE SERIES, PROCESS OF PREPARING AND USE THEREOF
C07C 69/736 (2006.01)	3731933	ASYMMETRIC DERIVATIVES OF POLYPHENOLS OF THE DINAPHTHALINE SERIES, PROCESS OF PREPARING AND USE THEREOF
C07C 243/18 (2006.01)	3731933	ASYMMETRIC DERIVATIVES OF POLYPHENOLS OF THE DINAPHTHALINE SERIES, PROCESS OF PREPARING AND USE THEREOF
C07C 245/12 (2006.01)	3731933	ASYMMETRIC DERIVATIVES OF POLYPHENOLS OF THE DINAPHTHALINE SERIES, PROCESS OF PREPARING AND USE THEREOF
C07C 251/24 (2006.01)	3731933	ASYMMETRIC DERIVATIVES OF POLYPHENOLS OF THE DINAPHTHALINE SERIES, PROCESS OF PREPARING AND USE THEREOF
C07C 309/13 (2006.01)	3731933	ASYMMETRIC DERIVATIVES OF POLYPHENOLS OF THE DINAPHTHALINE SERIES, PROCESS OF PREPARING AND USE THEREOF
C07D 207/14 (2006.01)	3731933	ASYMMETRIC DERIVATIVES OF POLYPHENOLS OF THE DINAPHTHALINE SERIES, PROCESS OF PREPARING AND USE THEREOF
C07D 211/60 (2006.01)	3731933	ASYMMETRIC DERIVATIVES OF POLYPHENOLS OF THE DINAPHTHALINE SERIES, PROCESS OF PREPARING AND USE THEREOF
C07D 213/74 (2006.01)	3731933	ASYMMETRIC DERIVATIVES OF POLYPHENOLS OF THE DINAPHTHALINE SERIES, PROCESS OF PREPARING AND USE THEREOF

MKP (51)	Broj objave evropske prijava patenta (97)	Naziv pronalaska (54)
C07D 215/38 (2006.01)	3731933	ASYMMETRIC DERIVATIVES OF POLYPHENOLS OF THE DINAPHTHALINE SERIES, PROCESS OF PREPARING AND USE THEREOF
A61K 39/00 (2006.01)	3720480	PHENOTYPIC MARKERS FOR CELL THERAPY AND RELATED METHODS
C12N 5/0783 (2010.01)	3720480	PHENOTYPIC MARKERS FOR CELL THERAPY AND RELATED METHODS
C25B 1/08 (2006.01)	3732316	MODULAR DEVICE AND PROCEDURE FOR PRODUCING REPRODUCIBLE QUALITY HYDROGEN AND OXYGEN GASES
C25B 9/18 (2006.01)	3732316	MODULAR DEVICE AND PROCEDURE FOR PRODUCING REPRODUCIBLE QUALITY HYDROGEN AND OXYGEN GASES
C25B 9/20 (2006.01)	3732316	MODULAR DEVICE AND PROCEDURE FOR PRODUCING REPRODUCIBLE QUALITY HYDROGEN AND OXYGEN GASES
C25B 15/02 (2006.01)	3732316	MODULAR DEVICE AND PROCEDURE FOR PRODUCING REPRODUCIBLE QUALITY HYDROGEN AND OXYGEN GASES
A61K 51/04 (2006.01)	3717025	IMAGING AGENTS
A61K 101/00 (2006.01)	3717025	IMAGING AGENTS
A61K 101/02 (2006.01)	3717025	IMAGING AGENTS
C07B 59/00 (2006.01)	3717025	IMAGING AGENTS
C07D 491/048 (2006.01)	3717025	IMAGING AGENTS
A61K 31/185 (2006.01)	3720428	OPHTHALMIC TOPICAL COMPOSITION COMPRISING DOBESILIC ACID FOR TREATING DISEASES OF THE POSTERIOR SEGMENT OF THE EYE
A61P 27/02 (2006.01)	3720428	OPHTHALMIC TOPICAL COMPOSITION COMPRISING DOBESILIC ACID FOR TREATING DISEASES OF THE POSTERIOR SEGMENT OF THE EYE
A61K 31/433 (2006.01)	3724198	2-OXO-1-PYRROLIDINYL IMIDAZOTHIADIAZOLE DERIVATIVES
A61P 25/08 (2006.01)	3724198	2-OXO-1-PYRROLIDINYL IMIDAZOTHIADIAZOLE DERIVATIVES
C07D 513/04 (2006.01)	3724198	2-OXO-1-PYRROLIDINYL IMIDAZOTHIADIAZOLE DERIVATIVES
A61K 31/4245 (2006.01)	3720851	1,2,4-OXADIAZOLE DERIVATIVES AS HISTONE DEACETYLASE 6 INHIBITORS
A61P 9/00 (2006.01)	3720851	1,2,4-OXADIAZOLE DERIVATIVES AS HISTONE DEACETYLASE 6 INHIBITORS
A61P 25/00 (2006.01)	3720851	1,2,4-OXADIAZOLE DERIVATIVES AS HISTONE DEACETYLASE 6 INHIBITORS
A61P 31/00 (2006.01)	3720851	1,2,4-OXADIAZOLE DERIVATIVES AS HISTONE DEACETYLASE 6 INHIBITORS
C07D 413/14 (2006.01)	3720851	1,2,4-OXADIAZOLE DERIVATIVES AS HISTONE DEACETYLASE 6 INHIBITORS
A61K 9/00 (2006.01)	3716944	STABLE LIQUID COMPOSITION OF KETOPROFEN, SALTS AND ENANTIOMERS THEREOF
A61K 9/06 (2006.01)	3716944	STABLE LIQUID COMPOSITION OF KETOPROFEN, SALTS AND ENANTIOMERS THEREOF
A61K 31/192 (2006.01)	3716944	STABLE LIQUID COMPOSITION OF KETOPROFEN, SALTS AND ENANTIOMERS THEREOF
A61K 47/40 (2006.01)	3716944	STABLE LIQUID COMPOSITION OF KETOPROFEN, SALTS AND ENANTIOMERS THEREOF
A61K 31/337 (2006.01)	3717007	ILDR2 ANTAGONISTS AND COMBINATIONS THEREOF
A61K 39/395 (2006.01)	3717007	ILDR2 ANTAGONISTS AND COMBINATIONS THEREOF
A61P 35/00 (2006.01)	3717007	ILDR2 ANTAGONISTS AND COMBINATIONS THEREOF
A61P 37/04 (2006.01)	3717007	ILDR2 ANTAGONISTS AND COMBINATIONS THEREOF
C07K 16/28 (2006.01)	3717007	ILDR2 ANTAGONISTS AND COMBINATIONS THEREOF
A61K 31/437 (2006.01)	3720440	TREATMENT OF RSV WITH COMBINATION PRODUCT
A61K 31/519 (2006.01)	3720440	TREATMENT OF RSV WITH COMBINATION PRODUCT
A61P 11/00 (2006.01)	3720440	TREATMENT OF RSV WITH COMBINATION PRODUCT
A61P 31/14 (2006.01)	3720440	TREATMENT OF RSV WITH COMBINATION PRODUCT
A61K 31/437 (2006.01)	3717471	NOVEL COMPOUNDS AND PHARMACEUTICAL COMPOSITIONS THEREOF FOR THE TREATMENT OF DISEASES
A61P 9/00 (2006.01)	3717471	NOVEL COMPOUNDS AND PHARMACEUTICAL COMPOSITIONS THEREOF FOR THE TREATMENT OF DISEASES
A61P 37/00 (2006.01)	3717471	NOVEL COMPOUNDS AND PHARMACEUTICAL COMPOSITIONS THEREOF FOR THE TREATMENT OF DISEASES
C07D 403/04 (2006.01)	3717471	NOVEL COMPOUNDS AND PHARMACEUTICAL COMPOSITIONS THEREOF FOR THE TREATMENT OF DISEASES
C07D 471/04 (2006.01)	3717471	NOVEL COMPOUNDS AND PHARMACEUTICAL COMPOSITIONS THEREOF FOR THE TREATMENT OF DISEASES
A01G 17/06 (2006.01)	3716755	A DEVICE FOR TENSIONING PLANT SUPPORT WIRES, SUPPORT SYSTEM OF SAID PLANTS COMPRISING SUCH DEVICE AND THE METHOD OF SUPPORT THEREOF
A47K 10/32 (2006.01)	3727114	REFILL FOR A DISPENSER

MKP (51)	Broj objave evropske prijava patenta (97)	Naziv pronalaska (54)
A47K 10/38 (2006.01)	3727114	REFILL FOR A DISPENSER
A47K 10/40 (2006.01)	3727114	REFILL FOR A DISPENSER
B65H 16/06 (2006.01)	3727114	REFILL FOR A DISPENSER
B65H 75/24 (2006.01)	3727114	REFILL FOR A DISPENSER
A61K 31/185 (2006.01)	3724165	NEW BENZAMIDE DERIVATIVES AS PPAR-GAMMA MODULATORS
A61K 31/44 (2006.01)	3724165	NEW BENZAMIDE DERIVATIVES AS PPAR-GAMMA MODULATORS
A61K 31/444 (2006.01)	3724165	NEW BENZAMIDE DERIVATIVES AS PPAR-GAMMA MODULATORS
A61K 31/50 (2006.01)	3724165	NEW BENZAMIDE DERIVATIVES AS PPAR-GAMMA MODULATORS
A61P 35/00 (2006.01)	3724165	NEW BENZAMIDE DERIVATIVES AS PPAR-GAMMA MODULATORS
C07C 237/20 (2006.01)	3724165	NEW BENZAMIDE DERIVATIVES AS PPAR-GAMMA MODULATORS
C07C 255/50 (2006.01)	3724165	NEW BENZAMIDE DERIVATIVES AS PPAR-GAMMA MODULATORS
C07D 213/75 (2006.01)	3724165	NEW BENZAMIDE DERIVATIVES AS PPAR-GAMMA MODULATORS
C07D 237/20 (2006.01)	3724165	NEW BENZAMIDE DERIVATIVES AS PPAR-GAMMA MODULATORS
C07D 295/192 (2006.01)	3724165	NEW BENZAMIDE DERIVATIVES AS PPAR-GAMMA MODULATORS
C07D 401/04 (2006.01)	3724165	NEW BENZAMIDE DERIVATIVES AS PPAR-GAMMA MODULATORS
A61K 38/26 (2006.01)	3713593	METHODS OF USING AND COMPOSITIONS CONTAINING DULAGLUTIDE
A61P 3/10 (2006.01)	3713593	METHODS OF USING AND COMPOSITIONS CONTAINING DULAGLUTIDE
A61K 31/519 (2006.01)	3717482	NEW PIPERIDINYL DERIVATIVES AS INHIBITORS OF UBIQUITIN SPECIFIC PROTEASE 7
A61K 31/52 (2006.01)	3717482	NEW PIPERIDINYL DERIVATIVES AS INHIBITORS OF UBIQUITIN SPECIFIC PROTEASE 7
A61P 35/00 (2006.01)	3717482	NEW PIPERIDINYL DERIVATIVES AS INHIBITORS OF UBIQUITIN SPECIFIC PROTEASE 7
A61P 37/00 (2006.01)	3717482	NEW PIPERIDINYL DERIVATIVES AS INHIBITORS OF UBIQUITIN SPECIFIC PROTEASE 7
C07D 471/04 (2006.01)	3717482	NEW PIPERIDINYL DERIVATIVES AS INHIBITORS OF UBIQUITIN SPECIFIC PROTEASE 7
C07D 473/30 (2006.01)	3717482	NEW PIPERIDINYL DERIVATIVES AS INHIBITORS OF UBIQUITIN SPECIFIC PROTEASE 7
C07D 495/04 (2006.01)	3717482	NEW PIPERIDINYL DERIVATIVES AS INHIBITORS OF UBIQUITIN SPECIFIC PROTEASE 7
A61K 9/16 (2006.01)	3716952	DOSAGE FORMS COMPRISING A PLASMA KALLIKREIN INHIBITOR
A61K 9/20 (2006.01)	3716952	DOSAGE FORMS COMPRISING A PLASMA KALLIKREIN INHIBITOR
A61K 9/28 (2006.01)	3716952	DOSAGE FORMS COMPRISING A PLASMA KALLIKREIN INHIBITOR
A61K 9/48 (2006.01)	3716952	DOSAGE FORMS COMPRISING A PLASMA KALLIKREIN INHIBITOR
A61K 31/00 (2006.01)	3716952	DOSAGE FORMS COMPRISING A PLASMA KALLIKREIN INHIBITOR
A61K 31/473 (2006.01)	3713933	NEW CATECHOLAMINE PRODRUGS FOR USE IN THE TREATMENT OF PARKINSON'S DISEASE
A61P 25/00 (2006.01)	3713933	NEW CATECHOLAMINE PRODRUGS FOR USE IN THE TREATMENT OF PARKINSON'S DISEASE
C07D 405/12 (2006.01)	3713933	NEW CATECHOLAMINE PRODRUGS FOR USE IN THE TREATMENT OF PARKINSON'S DISEASE
C07D 405/14 (2006.01)	3713933	NEW CATECHOLAMINE PRODRUGS FOR USE IN THE TREATMENT OF PARKINSON'S DISEASE
A61K 48/00 (2006.01)	3714047	POLYNUCLEOTIDES ENCODING PHENYLALANINE HYDROXYLASE FOR THE TREATMENT OF PHENYLKETONURIA
A61P 3/00 (2006.01)	3714047	POLYNUCLEOTIDES ENCODING PHENYLALANINE HYDROXYLASE FOR THE TREATMENT OF PHENYLKETONURIA
C12N 9/02 (2006.01)	3714047	POLYNUCLEOTIDES ENCODING PHENYLALANINE HYDROXYLASE FOR THE TREATMENT OF PHENYLKETONURIA
C12N 15/67 (2006.01)	3714047	POLYNUCLEOTIDES ENCODING PHENYLALANINE HYDROXYLASE FOR THE TREATMENT OF PHENYLKETONURIA
A61K 48/00 (2006.01)	3714045	POLYNUCLEOTIDES ENCODING PROPIONYL-COA CARBOXYLASE ALPHA AND BETA SUBUNITS FOR THE TREATMENT OF PROPIONIC ACIDEMIA
A61P 3/00 (2006.01)	3714045	POLYNUCLEOTIDES ENCODING PROPIONYL-COA CARBOXYLASE ALPHA AND BETA SUBUNITS FOR THE TREATMENT OF PROPIONIC ACIDEMIA
C12N 9/00 (2006.01)	3714045	POLYNUCLEOTIDES ENCODING PROPIONYL-COA CARBOXYLASE ALPHA AND BETA SUBUNITS FOR THE TREATMENT OF PROPIONIC ACIDEMIA
C12N 15/67 (2006.01)	3714045	POLYNUCLEOTIDES ENCODING PROPIONYL-COA CARBOXYLASE ALPHA AND BETA SUBUNITS FOR THE TREATMENT OF PROPIONIC ACIDEMIA
A23G 9/42 (2006.01)	3716791	CREAM SUBSTITUTE COMPRISING PULSE PROTEIN
A23L 9/20 (2016.01)	3716791	CREAM SUBSTITUTE COMPRISING PULSE PROTEIN
A23L 33/185 (2016.01)	3716791	CREAM SUBSTITUTE COMPRISING PULSE PROTEIN
A61K 36/48 (2006.01)	3716791	CREAM SUBSTITUTE COMPRISING PULSE PROTEIN

MKP (51)	Broj objave evropske prijava patenta (97)	Naziv pronalaska (54)
A61K 31/505 (2006.01)	3720865	NOVEL SPIROBICYCLIC ANALOGUES
A61P 35/00 (2006.01)	3720865	NOVEL SPIROBICYCLIC ANALOGUES
C07D 307/94 (2006.01)	3720865	NOVEL SPIROBICYCLIC ANALOGUES
C07D 317/44 (2006.01)	3720865	NOVEL SPIROBICYCLIC ANALOGUES
C07D 471/04 (2006.01)	3720865	NOVEL SPIROBICYCLIC ANALOGUES
C07H 19/14 (2006.01)	3720865	NOVEL SPIROBICYCLIC ANALOGUES
A61K 48/00 (2006.01)	3714048	POLYNUCLEOTIDES ENCODING ORNITHINE TRANSCARBAMYLASE FOR THE TREATMENT OF UREA CYCLE DISORDERS
A61P 3/00 (2006.01)	3714048	POLYNUCLEOTIDES ENCODING ORNITHINE TRANSCARBAMYLASE FOR THE TREATMENT OF UREA CYCLE DISORDERS
C12N 9/10 (2006.01)	3714048	POLYNUCLEOTIDES ENCODING ORNITHINE TRANSCARBAMYLASE FOR THE TREATMENT OF UREA CYCLE DISORDERS
C12N 15/67 (2006.01)	3714048	POLYNUCLEOTIDES ENCODING ORNITHINE TRANSCARBAMYLASE FOR THE TREATMENT OF UREA CYCLE DISORDERS
C07B 59/00 (2006.01)	3717455	PROCESSES FOR MAKING MODULATORS OF CYSTIC FIBROSIS TRANSMEMBRANE CONDUCTANCE REGULATOR
C07C 33/18 (2006.01)	3717455	PROCESSES FOR MAKING MODULATORS OF CYSTIC FIBROSIS TRANSMEMBRANE CONDUCTANCE REGULATOR
C07C 69/96 (2006.01)	3717455	PROCESSES FOR MAKING MODULATORS OF CYSTIC FIBROSIS TRANSMEMBRANE CONDUCTANCE REGULATOR
C07D 215/56 (2006.01)	3717455	PROCESSES FOR MAKING MODULATORS OF CYSTIC FIBROSIS TRANSMEMBRANE CONDUCTANCE REGULATOR
A61K 31/4709 (2006.01)	3713928	NOVEL BRADYKININ B2 RECEPTOR ANTAGONISTS
A61K 31/5377 (2006.01)	3713928	NOVEL BRADYKININ B2 RECEPTOR ANTAGONISTS
A61P 11/06 (2006.01)	3713928	NOVEL BRADYKININ B2 RECEPTOR ANTAGONISTS
A61P 25/28 (2006.01)	3713928	NOVEL BRADYKININ B2 RECEPTOR ANTAGONISTS
A61P 29/00 (2006.01)	3713928	NOVEL BRADYKININ B2 RECEPTOR ANTAGONISTS
C07D 401/04 (2006.01)	3713928	NOVEL BRADYKININ B2 RECEPTOR ANTAGONISTS
C07D 401/14 (2006.01)	3713928	NOVEL BRADYKININ B2 RECEPTOR ANTAGONISTS
C07D 405/14 (2006.01)	3713928	NOVEL BRADYKININ B2 RECEPTOR ANTAGONISTS
C07D 413/14 (2006.01)	3713928	NOVEL BRADYKININ B2 RECEPTOR ANTAGONISTS
C07D 417/14 (2006.01)	3713928	NOVEL BRADYKININ B2 RECEPTOR ANTAGONISTS
A61K 39/00 (2006.01)	3717514	ANTI-TRKB MONOCLONAL ANTIBODIES AND METHODS OF USE
C07K 16/28 (2006.01)	3717514	ANTI-TRKB MONOCLONAL ANTIBODIES AND METHODS OF USE
A61K 31/7052 (2006.01)	3720864	SALTS OF DIPHOSPHATE PHOSPHORAMIDATE OF NUCLEOSIDES AS ANTICANCER COMPOUNDS
A61P 35/00 (2006.01)	3720864	SALTS OF DIPHOSPHATE PHOSPHORAMIDATE OF NUCLEOSIDES AS ANTICANCER COMPOUNDS
C07H 19/10 (2006.01)	3720864	SALTS OF DIPHOSPHATE PHOSPHORAMIDATE OF NUCLEOSIDES AS ANTICANCER COMPOUNDS
C07H 19/20 (2006.01)	3720864	SALTS OF DIPHOSPHATE PHOSPHORAMIDATE OF NUCLEOSIDES AS ANTICANCER COMPOUNDS
A61K 8/81 (2006.01)	3720416	ORAL CARE COMPOSITION
A61Q 11/00 (2006.01)	3720416	ORAL CARE COMPOSITION
A61K 8/81 (2006.01)	3720563	ORAL CARE COMPOSITIONS
A61Q 11/00 (2006.01)	3720563	ORAL CARE COMPOSITIONS
A61K 8/02 (2006.01)	3720564	HIGH-THROUGHPUT METHOD FOR DETECTING TOOTH STAIN PREVENTION AND REMOVAL
A61K 8/24 (2006.01)	3720564	HIGH-THROUGHPUT METHOD FOR DETECTING TOOTH STAIN PREVENTION AND REMOVAL
A61Q 11/00 (2006.01)	3720564	HIGH-THROUGHPUT METHOD FOR DETECTING TOOTH STAIN PREVENTION AND REMOVAL
G01N 1/30 (2006.01)	3720564	HIGH-THROUGHPUT METHOD FOR DETECTING TOOTH STAIN PREVENTION AND REMOVAL
G01N 21/17 (2006.01)	3720564	HIGH-THROUGHPUT METHOD FOR DETECTING TOOTH STAIN PREVENTION AND REMOVAL
G01N 33/15 (2006.01)	3720564	HIGH-THROUGHPUT METHOD FOR DETECTING TOOTH STAIN PREVENTION AND REMOVAL
A61K 31/4709 (2006.01)	3713919	CRYSTALLINE FORMS OF N-(4-(4-(CYCLOPROPYLMETHYL) PIPERAZINE-1-CARBONYL)PHENYL)QUINOLINE-8-SULFONAMIDE
A61P 7/06 (2006.01)	3713919	CRYSTALLINE FORMS OF N-(4-(4-(CYCLOPROPYLMETHYL) PIPERAZINE-1-CARBONYL)PHENYL)QUINOLINE-8-SULFONAMIDE
C07D 215/36 (2006.01)	3713919	CRYSTALLINE FORMS OF N-(4-(4-(CYCLOPROPYLMETHYL) PIPERAZINE-1-CARBONYL)PHENYL)QUINOLINE-8-SULFONAMIDE
A61M 5/24 (2006.01)	3720526	MEDICAL DELIVERY DEVICE WITH AXIALLY EXPANDABLE DRIVE RIBBON

MKP (51)	Broj objave evropske prijava patenta (97)	Naziv pronalaska (54)
A61M 5/315 (2006.01)	3720526	MEDICAL DELIVERY DEVICE WITH AXIALLY EXPANDABLE DRIVE RIBBON
A61K 31/573 (2006.01)	3716980	METHODS FOR DOSING AND FOR MODULATION OF GENETICALLY ENGINEERED CELLS
A61P 43/00 (2006.01)	3716980	METHODS FOR DOSING AND FOR MODULATION OF GENETICALLY ENGINEERED CELLS
C07K 16/28 (2006.01)	3716980	METHODS FOR DOSING AND FOR MODULATION OF GENETICALLY ENGINEERED CELLS
G01N 33/68 (2006.01)	3716980	METHODS FOR DOSING AND FOR MODULATION OF GENETICALLY ENGINEERED CELLS
A01K 67/027 (2006.01)	3720279	NON-HUMAN ANIMALS HAVING AN ENGINEERED IMMUNOGLOBULIN LAMBDA LIGHT CHAIN AND USES THEREOF
C07K 16/00 (2006.01)	3720279	NON-HUMAN ANIMALS HAVING AN ENGINEERED IMMUNOGLOBULIN LAMBDA LIGHT CHAIN AND USES THEREOF
C07K 16/46 (2006.01)	3720279	NON-HUMAN ANIMALS HAVING AN ENGINEERED IMMUNOGLOBULIN LAMBDA LIGHT CHAIN AND USES THEREOF
C12N 9/12 (2006.01)	3720279	NON-HUMAN ANIMALS HAVING AN ENGINEERED IMMUNOGLOBULIN LAMBDA LIGHT CHAIN AND USES THEREOF
A61K 31/437 (2006.01)	3713940	SUBSTITUTED AZACYCLES AS MUSCARINIC M1 RECEPTOR POSITIVE ALLOSTERIC MODULATORS
A61P 25/00 (2006.01)	3713940	SUBSTITUTED AZACYCLES AS MUSCARINIC M1 RECEPTOR POSITIVE ALLOSTERIC MODULATORS
C07D 471/04 (2006.01)	3713940	SUBSTITUTED AZACYCLES AS MUSCARINIC M1 RECEPTOR POSITIVE ALLOSTERIC MODULATORS
A61K 31/4525 (2006.01)	3720858	MODULATORS OF THE BETA-3 ADRENERGIC RECEPTOR USEFUL FOR THE TREATMENT OR PREVENTION OF HEART FAILURE AND DISORDERS RELATED THERETO
A61P 9/04 (2006.01)	3720858	MODULATORS OF THE BETA-3 ADRENERGIC RECEPTOR USEFUL FOR THE TREATMENT OR PREVENTION OF HEART FAILURE AND DISORDERS RELATED THERETO
C07D 491/10 (2006.01)	3720858	MODULATORS OF THE BETA-3 ADRENERGIC RECEPTOR USEFUL FOR THE TREATMENT OR PREVENTION OF HEART FAILURE AND DISORDERS RELATED THERETO
A61K 31/047 (2006.01)	3727359	TREATMENT OF FIBROSIS WITH INOSITOL
A61P 43/00 (2006.01)	3727359	TREATMENT OF FIBROSIS WITH INOSITOL
G06Q 40/00 (2012.01)	3752972	SYSTEM AND METHOD FOR AUTHENTICATED SHARIA LAW COMPLIANT LOTTERY, SPORTS BETTING AND GAMING
A61K 39/395 (2006.01)	3752191	NON-VIRAL DNA VECTORS AND USES THEREOF FOR ANTIBODY AND FUSION PROTEIN PRODUCTION
C07K 14/47 (2006.01)	3752191	NON-VIRAL DNA VECTORS AND USES THEREOF FOR ANTIBODY AND FUSION PROTEIN PRODUCTION
C12N 15/864 (2006.01)	3752191	NON-VIRAL DNA VECTORS AND USES THEREOF FOR ANTIBODY AND FUSION PROTEIN PRODUCTION
A61K 39/395 (2006.01)	3752193	METHODS FOR TREATING CANCER WITH ANTI PD-1 ANTIBODIES AND ANTI CTLA4 ANTIBODIES
C07K 16/28 (2006.01)	3752193	METHODS FOR TREATING CANCER WITH ANTI PD-1 ANTIBODIES AND ANTI CTLA4 ANTIBODIES
C07K 16/30 (2006.01)	3752193	METHODS FOR TREATING CANCER WITH ANTI PD-1 ANTIBODIES AND ANTI CTLA4 ANTIBODIES
B07C 3/00 (2006.01)	3752440	GROUPING STATION FOR LOADING PALLETS
B07C 5/00 (2006.01)	3752440	GROUPING STATION FOR LOADING PALLETS
B65G 15/22 (2006.01)	3752440	GROUPING STATION FOR LOADING PALLETS
B65G 17/26 (2006.01)	3752440	GROUPING STATION FOR LOADING PALLETS
B65G 47/08 (2006.01)	3752440	GROUPING STATION FOR LOADING PALLETS
A61K 31/519 (2006.01)	3753941	PYRIMIDINE-FUSED CYCLIC COMPOUND, PREPARATION METHOD THEREFOR AND APPLICATION THEREOF
A61K 31/55 (2006.01)	3753941	PYRIMIDINE-FUSED CYCLIC COMPOUND, PREPARATION METHOD THEREFOR AND APPLICATION THEREOF
A61K 45/06 (2006.01)	3753941	PYRIMIDINE-FUSED CYCLIC COMPOUND, PREPARATION METHOD THEREFOR AND APPLICATION THEREOF
A61P 35/00 (2006.01)	3753941	PYRIMIDINE-FUSED CYCLIC COMPOUND, PREPARATION METHOD THEREFOR AND APPLICATION THEREOF
A61P 35/02 (2006.01)	3753941	PYRIMIDINE-FUSED CYCLIC COMPOUND, PREPARATION METHOD THEREFOR AND APPLICATION THEREOF
C07D 487/04 (2006.01)	3753941	PYRIMIDINE-FUSED CYCLIC COMPOUND, PREPARATION METHOD THEREFOR AND APPLICATION THEREOF
C07D 519/00 (2006.01)	3753941	PYRIMIDINE-FUSED CYCLIC COMPOUND, PREPARATION METHOD THEREFOR AND APPLICATION THEREOF
A61K 31/538 (2006.01)	3752491	HETEROCYCLIC COMPOUNDS AS KINASE INHIBITORS
C07D 265/36 (2006.01)	3752491	HETEROCYCLIC COMPOUNDS AS KINASE INHIBITORS

MKP (51)	Broj objave evropske prijava patenta (97)	Naziv pronalaska (54)
C07D 413/14 (2006.01)	3752491	HETEROCYCLIC COMPOUNDS AS KINASE INHIBITORS
A61M 1/36 (2006.01)	3752216	USING THERMOCHROMIC INK FOR BLOOD SIMULATION IN MEDICAL TRAINING
C09D 11/50 (2014.01)	3752216	USING THERMOCHROMIC INK FOR BLOOD SIMULATION IN MEDICAL TRAINING
F28D 9/00 (2006.01)	3752216	USING THERMOCHROMIC INK FOR BLOOD SIMULATION IN MEDICAL TRAINING
A61K 31/366 (2006.01)	3752142	ANTIBACTERIAL AGENTS: SOLUBLE SALTS AND AQUEOUS FORMULATIONS OF PYRONINS
A61K 31/381 (2006.01)	3752142	ANTIBACTERIAL AGENTS: SOLUBLE SALTS AND AQUEOUS FORMULATIONS OF PYRONINS
A61K 31/4025 (2006.01)	3752142	ANTIBACTERIAL AGENTS: SOLUBLE SALTS AND AQUEOUS FORMULATIONS OF PYRONINS
A61K 31/366 (2006.01)	3752143	ANTIBACTERIAL AGENTS: O-ALKYL-DEUTERATED PYRONINS
A61K 31/381 (2006.01)	3752143	ANTIBACTERIAL AGENTS: O-ALKYL-DEUTERATED PYRONINS
A61K 31/4025 (2006.01)	3752143	ANTIBACTERIAL AGENTS: O-ALKYL-DEUTERATED PYRONINS
B60R 11/02 (2006.01)	3755613	ERGONOMIC CONTROL SYSTEM FOR BICYCLES AND ELECTRONIC DEVICES
B62D 1/04 (2006.01)	3755613	ERGONOMIC CONTROL SYSTEM FOR BICYCLES AND ELECTRONIC DEVICES
B62K 11/14 (2006.01)	3755613	ERGONOMIC CONTROL SYSTEM FOR BICYCLES AND ELECTRONIC DEVICES
G03G 15/00 (2006.01)	3614208	OPTICAL SENSOR AND IMAGE FORMING APPARATUS
G03G 15/00 (2006.01)	3614209	IMAGE FORMING APPARATUS
A61K 39/395 (2006.01)	3656398	ANTI-B7-H1 ANTIBODIES FOR TREATING TUMORS
A61P 35/00 (2006.01)	3656398	ANTI-B7-H1 ANTIBODIES FOR TREATING TUMORS
C07K 16/28 (2006.01)	3656398	ANTI-B7-H1 ANTIBODIES FOR TREATING TUMORS
C07K 16/30 (2006.01)	3656398	ANTI-B7-H1 ANTIBODIES FOR TREATING TUMORS
A61K 39/395 (2006.01)	3623385	BINDING MOLECULES FOR BCMA AND CD3
A61P 35/02 (2006.01)	3623385	BINDING MOLECULES FOR BCMA AND CD3
A61P 37/00 (2006.01)	3623385	BINDING MOLECULES FOR BCMA AND CD3
C07K 16/28 (2006.01)	3623385	BINDING MOLECULES FOR BCMA AND CD3
A61K 39/39 (2006.01)	3628373	METHODS FOR TREATING OR PREVENTING OPHTHALMOLOGICAL CONDITIONS
A61P 27/02 (2006.01)	3628373	METHODS FOR TREATING OR PREVENTING OPHTHALMOLOGICAL CONDITIONS
A61K 39/395 (2006.01)	3636279	METHODS FOR INCREASING EFFICACY OF FOLR1 CANCER THERAPY
A61K 31/506 (2006.01)	3622956	SUBSTITUTED 2-AZABICYCLES AND THEIR USE AS OREXIN RECEPTOR MODULATORS
A61P 25/00 (2006.01)	3622956	SUBSTITUTED 2-AZABICYCLES AND THEIR USE AS OREXIN RECEPTOR MODULATORS
C07C 233/18 (2006.01)	3656758	INTERMEDIATES FOR THE PREPARATION OF C-TERMINAL HSP90 INHIBITORS
C07D 213/30 (2006.01)	3656758	INTERMEDIATES FOR THE PREPARATION OF C-TERMINAL HSP90 INHIBITORS
C07D 319/08 (2006.01)	3656758	INTERMEDIATES FOR THE PREPARATION OF C-TERMINAL HSP90 INHIBITORS
A61K 9/00 (2006.01)	3636251	PHARMACEUTICAL COMPOSITION OF S-KETAMINE HYDROCHLORIDE
A61K 31/137 (2006.01)	3636251	PHARMACEUTICAL COMPOSITION OF S-KETAMINE HYDROCHLORIDE
A61K 47/02 (2006.01)	3636251	PHARMACEUTICAL COMPOSITION OF S-KETAMINE HYDROCHLORIDE
A61K 47/28 (2006.01)	3636251	PHARMACEUTICAL COMPOSITION OF S-KETAMINE HYDROCHLORIDE
A61K 31/47 (2006.01)	3626717	SELECTIVELY SUBSTITUTED QUINOLINE COMPOUNDS
A61K 31/535 (2006.01)	3626717	SELECTIVELY SUBSTITUTED QUINOLINE COMPOUNDS
A61P 37/00 (2006.01)	3626717	SELECTIVELY SUBSTITUTED QUINOLINE COMPOUNDS
C07D 215/48 (2006.01)	3626717	SELECTIVELY SUBSTITUTED QUINOLINE COMPOUNDS
C07D 401/10 (2006.01)	3626717	SELECTIVELY SUBSTITUTED QUINOLINE COMPOUNDS
C07D 401/14 (2006.01)	3626717	SELECTIVELY SUBSTITUTED QUINOLINE COMPOUNDS
C07D 403/14 (2006.01)	3626717	SELECTIVELY SUBSTITUTED QUINOLINE COMPOUNDS
C07D 413/04 (2006.01)	3626717	SELECTIVELY SUBSTITUTED QUINOLINE COMPOUNDS
C07D 413/14 (2006.01)	3626717	SELECTIVELY SUBSTITUTED QUINOLINE COMPOUNDS
C07D 417/14 (2006.01)	3626717	SELECTIVELY SUBSTITUTED QUINOLINE COMPOUNDS
C07D 451/04 (2006.01)	3626717	SELECTIVELY SUBSTITUTED QUINOLINE COMPOUNDS
C07D 471/04 (2006.01)	3626717	SELECTIVELY SUBSTITUTED QUINOLINE COMPOUNDS
C07D 471/10 (2006.01)	3626717	SELECTIVELY SUBSTITUTED QUINOLINE COMPOUNDS
C07D 487/04 (2006.01)	3626717	SELECTIVELY SUBSTITUTED QUINOLINE COMPOUNDS

MKP (51)	Broj objave evropske prijava patenta (97)	Naziv pronalaska (54)
C07D 487/10 (2006.01)	3626717	SELECTIVELY SUBSTITUTED QUINOLINE COMPOUNDS
C07D 493/10 (2006.01)	3626717	SELECTIVELY SUBSTITUTED QUINOLINE COMPOUNDS
A61K 31/7088 (2006.01)	3633035	EXON SKIPPING COMPOSITIONS FOR TREATING MUSCULAR DYSTROPHY
A61P 21/00 (2006.01)	3633035	EXON SKIPPING COMPOSITIONS FOR TREATING MUSCULAR DYSTROPHY
C12N 15/11 (2006.01)	3633035	EXON SKIPPING COMPOSITIONS FOR TREATING MUSCULAR DYSTROPHY
C12N 15/113 (2010.01)	3633035	EXON SKIPPING COMPOSITIONS FOR TREATING MUSCULAR DYSTROPHY
A61K 8/34 (2006.01)	3616678	TOPICAL COMPOSITION CONTAINING GLYCERIN AND YEAST EXTRACT
A61K 8/9728 (2017.01)	3616678	TOPICAL COMPOSITION CONTAINING GLYCERIN AND YEAST EXTRACT
A61Q 19/00 (2006.01)	3616678	TOPICAL COMPOSITION CONTAINING GLYCERIN AND YEAST EXTRACT
A61K 31/4375 (2006.01)	3617206	INTEGRIN INHIBITORS
A61P 11/00 (2006.01)	3617206	INTEGRIN INHIBITORS
C07D 471/04 (2006.01)	3617206	INTEGRIN INHIBITORS
A61K 8/67 (2006.01)	3616681	TOPICAL COMPOSITIONS COMPRISING PICHIA ANOMALA AND RETINOL
A61K 8/9728 (2017.01)	3616681	TOPICAL COMPOSITIONS COMPRISING PICHIA ANOMALA AND RETINOL
A61Q 19/00 (2006.01)	3616681	TOPICAL COMPOSITIONS COMPRISING PICHIA ANOMALA AND RETINOL
A61K 8/60 (2006.01)	3616684	TOPICAL COMPOSITIONS COMPRISING PICHIA ANOMALA AND N-ACETYL GLUCOSAMINE
A61K 8/9728 (2017.01)	3616684	TOPICAL COMPOSITIONS COMPRISING PICHIA ANOMALA AND N-ACETYL GLUCOSAMINE
A61Q 17/00 (2006.01)	3616684	TOPICAL COMPOSITIONS COMPRISING PICHIA ANOMALA AND N-ACETYL GLUCOSAMINE
A61Q 19/00 (2006.01)	3616684	TOPICAL COMPOSITIONS COMPRISING PICHIA ANOMALA AND N-ACETYL GLUCOSAMINE
A01N 63/00 (2020.01)	3628161	SYNERGISTIC BACTERIAL COMPOSITIONS AND METHODS OF PRODUCTION AND USE THEREOF
A01N 65/00 (2009.01)	3628161	SYNERGISTIC BACTERIAL COMPOSITIONS AND METHODS OF PRODUCTION AND USE THEREOF
A61K 35/742 (2015.01)	3628161	SYNERGISTIC BACTERIAL COMPOSITIONS AND METHODS OF PRODUCTION AND USE THEREOF
A61K 35/744 (2015.01)	3628161	SYNERGISTIC BACTERIAL COMPOSITIONS AND METHODS OF PRODUCTION AND USE THEREOF
A61K 35/745 (2015.01)	3628161	SYNERGISTIC BACTERIAL COMPOSITIONS AND METHODS OF PRODUCTION AND USE THEREOF
A61K 35/747 (2015.01)	3628161	SYNERGISTIC BACTERIAL COMPOSITIONS AND METHODS OF PRODUCTION AND USE THEREOF
A61P 1/12 (2006.01)	3628161	SYNERGISTIC BACTERIAL COMPOSITIONS AND METHODS OF PRODUCTION AND USE THEREOF
A61P 31/04 (2006.01)	3628161	SYNERGISTIC BACTERIAL COMPOSITIONS AND METHODS OF PRODUCTION AND USE THEREOF
C07D 471/04 (2006.01)	3656771	PROCESS FOR THE PREPARATION OF A SYNTHETIC INTERMEDIATE FOR APOPTOSIS-INDUCING AGENTS
G10K 11/178 (2006.01)	3624112	IN-EAR ANC EARPHONE
H04R 1/10 (2006.01)	3624112	IN-EAR ANC EARPHONE
A61K 8/31 (2006.01)	3620213	RETINOL OIL COMPOSITION
A61K 8/37 (2006.01)	3620213	RETINOL OIL COMPOSITION
A61K 8/39 (2006.01)	3620213	RETINOL OIL COMPOSITION
A61K 8/67 (2006.01)	3620213	RETINOL OIL COMPOSITION
A61K 8/86 (2006.01)	3620213	RETINOL OIL COMPOSITION
A61P 17/00 (2006.01)	3620213	RETINOL OIL COMPOSITION
A61P 17/10 (2006.01)	3620213	RETINOL OIL COMPOSITION
A61Q 19/00 (2006.01)	3620213	RETINOL OIL COMPOSITION
A61Q 19/06 (2006.01)	3620213	RETINOL OIL COMPOSITION
A61Q 19/08 (2006.01)	3620213	RETINOL OIL COMPOSITION
B61D 7/20 (2006.01)	3623245	DEVICE FOR UNLOADING BALLAST, AND RAILWAY VEHICLE FOR BALLASTING EQUIPPED WITH SUCH A DEVICE
B61D 7/28 (2006.01)	3623245	DEVICE FOR UNLOADING BALLAST, AND RAILWAY VEHICLE FOR BALLASTING EQUIPPED WITH SUCH A DEVICE
B61D 7/32 (2006.01)	3623245	DEVICE FOR UNLOADING BALLAST, AND RAILWAY VEHICLE FOR BALLASTING EQUIPPED WITH SUCH A DEVICE

MKP (51)	Broj objave evropske prijava patenta (97)	Naziv pronalaska (54)
E01B 27/02 (2006.01)	3623245	DEVICE FOR UNLOADING BALLAST, AND RAILWAY VEHICLE FOR BALLASTING EQUIPPED WITH SUCH A DEVICE
E05F 11/48 (2006.01)	3636867	DEVICE AND METHOD FOR CONNECTING TWO COMPONENTS, ESPECIALLY A MOTOR VEHICLE WINDOW REGULATOR
E05F 15/689 (2015.01)	3636867	DEVICE AND METHOD FOR CONNECTING TWO COMPONENTS, ESPECIALLY A MOTOR VEHICLE WINDOW REGULATOR
B60P 1/16 (2006.01)	3623215	TRANSPORT VEHICLE FOR ROLLING CONTAINERS
B60P 1/64 (2006.01)	3623215	TRANSPORT VEHICLE FOR ROLLING CONTAINERS
B60P 1/64 (2006.01)	3623218	CARRIAGE FOR A TRANSPORT VEHICLE FOR TRANSPORTING ROLLING CONTAINERS
A23L 3/00 (2006.01)	3650363	FOOD PROCESSING SYSTEM WITH SEVERAL CLOSED AREAS, BETWEEN WHICH A CONTAINER CONVEYOR IS ARRANGED
A23L 3/04 (2006.01)	3650363	FOOD PROCESSING SYSTEM WITH SEVERAL CLOSED AREAS, BETWEEN WHICH A CONTAINER CONVEYOR IS ARRANGED
B65B 55/02 (2006.01)	3650363	FOOD PROCESSING SYSTEM WITH SEVERAL CLOSED AREAS, BETWEEN WHICH A CONTAINER CONVEYOR IS ARRANGED
B65B 55/04 (2006.01)	3650363	FOOD PROCESSING SYSTEM WITH SEVERAL CLOSED AREAS, BETWEEN WHICH A CONTAINER CONVEYOR IS ARRANGED
B65B 55/10 (2006.01)	3650363	FOOD PROCESSING SYSTEM WITH SEVERAL CLOSED AREAS, BETWEEN WHICH A CONTAINER CONVEYOR IS ARRANGED
A61K 31/4985 (2006.01)	3613745	SOLID FORMS AND FORMULATIONS OF (S)-4-(8-AMINO-3-(1-(BUT-2-YNOYL)PYRROLIDIN-2-YL)IMIDAZO[1,5-A]PYRAZIN-1-YL)-N-(PYRIDIN-2-YL)BENZAMIDE
A61P 35/00 (2006.01)	3613745	SOLID FORMS AND FORMULATIONS OF (S)-4-(8-AMINO-3-(1-(BUT-2-YNOYL)PYRROLIDIN-2-YL)IMIDAZO[1,5-A]PYRAZIN-1-YL)-N-(PYRIDIN-2-YL)BENZAMIDE
C07D 487/04 (2006.01)	3613745	SOLID FORMS AND FORMULATIONS OF (S)-4-(8-AMINO-3-(1-(BUT-2-YNOYL)PYRROLIDIN-2-YL)IMIDAZO[1,5-A]PYRAZIN-1-YL)-N-(PYRIDIN-2-YL)BENZAMIDE
C07K 16/24 (2006.01)	3653645	INTERLEUKIN-31 MONOCLONAL ANTIBODY
G01N 33/53 (2006.01)	3653645	INTERLEUKIN-31 MONOCLONAL ANTIBODY
C12N 5/0781 (2010.01)	3647412	METHODS FOR ISOLATING, CULTURING, AND GENETICALLY ENGINEERING IMMUNE CELL POPULATIONS FOR ADOPTIVE THERAPY
C12N 5/0783 (2010.01)	3647412	METHODS FOR ISOLATING, CULTURING, AND GENETICALLY ENGINEERING IMMUNE CELL POPULATIONS FOR ADOPTIVE THERAPY
A61K 31/44 (2006.01)	3653209	TRANSIENT PROTECTION OF NORMAL CELLS DURING CHEMOTHERAPY
A61K 31/519 (2006.01)	3653209	TRANSIENT PROTECTION OF NORMAL CELLS DURING CHEMOTHERAPY
A61K 31/527 (2006.01)	3653209	TRANSIENT PROTECTION OF NORMAL CELLS DURING CHEMOTHERAPY
A61P 35/00 (2006.01)	3653209	TRANSIENT PROTECTION OF NORMAL CELLS DURING CHEMOTHERAPY
C07D 491/14 (2006.01)	3653209	TRANSIENT PROTECTION OF NORMAL CELLS DURING CHEMOTHERAPY
F16B 21/02 (2006.01)	3627024	INSERTABLE TUBE CLAMP WITH FRAME AND CLAMP
F16L 1/024 (2006.01)	3627024	INSERTABLE TUBE CLAMP WITH FRAME AND CLAMP
F16L 3/10 (2006.01)	3627024	INSERTABLE TUBE CLAMP WITH FRAME AND CLAMP
F16L 3/24 (2006.01)	3627024	INSERTABLE TUBE CLAMP WITH FRAME AND CLAMP
H02G 3/30 (2006.01)	3627024	INSERTABLE TUBE CLAMP WITH FRAME AND CLAMP
H02G 3/32 (2006.01)	3627024	INSERTABLE TUBE CLAMP WITH FRAME AND CLAMP
F16B 21/02 (2006.01)	3627025	INSERTABLE TUBE CLAMP WITH FLOOR PLATE
F16L 1/024 (2006.01)	3627025	INSERTABLE TUBE CLAMP WITH FLOOR PLATE
F16L 3/10 (2006.01)	3627025	INSERTABLE TUBE CLAMP WITH FLOOR PLATE
F16L 3/24 (2006.01)	3627025	INSERTABLE TUBE CLAMP WITH FLOOR PLATE
H02G 3/30 (2006.01)	3627025	INSERTABLE TUBE CLAMP WITH FLOOR PLATE
H02G 3/32 (2006.01)	3627025	INSERTABLE TUBE CLAMP WITH FLOOR PLATE
A61K 47/68 (2017.01)	3653228	ANTI-FOLR1 IMMUNOCONJUGATE DOSING REGIMENS
A61P 35/00 (2006.01)	3653228	ANTI-FOLR1 IMMUNOCONJUGATE DOSING REGIMENS
C07K 16/28 (2006.01)	3653228	ANTI-FOLR1 IMMUNOCONJUGATE DOSING REGIMENS
A61K 31/337 (2006.01)	3620159	THERAPEUTIC TREATMENT
A61K 31/519 (2006.01)	3620159	THERAPEUTIC TREATMENT
A61P 35/00 (2006.01)	3620159	THERAPEUTIC TREATMENT
A61K 39/00 (2006.01)	3660029	USE OF CHIMERIC ANTIGEN RECEPTOR-MODIFIED T CELLS TO TREAT CANCER
C07H 21/04 (2006.01)	3660029	USE OF CHIMERIC ANTIGEN RECEPTOR-MODIFIED T CELLS TO TREAT CANCER
A61K 31/225 (2006.01)	3650042	DIMETHYL FUMARATE AND VACCINATION REGIMENS

MKP (51)	Broj objave evropske prijava patenta (97)	Naziv pronalaska (54)
A61K 39/05 (2006.01)	3650042	DIMETHYL FUMARATE AND VACCINATION REGIMENS
A61K 39/09 (2006.01)	3650042	DIMETHYL FUMARATE AND VACCINATION REGIMENS
A61P 25/28 (2006.01)	3650042	DIMETHYL FUMARATE AND VACCINATION REGIMENS
A61P 31/00 (2006.01)	3650042	DIMETHYL FUMARATE AND VACCINATION REGIMENS
C07D 487/04 (2006.01)	3653628	METHODS OF PREPARING CYTOTOXIC BENZODIAZEPINE DERIVATIVES
A01K 29/00 (2006.01)	3745850	METHOD AND DEVICE FOR RAISING JUVENILE FARM ANIMALS
A01K 31/18 (2006.01)	3745850	METHOD AND DEVICE FOR RAISING JUVENILE FARM ANIMALS
A01K 31/19 (2006.01)	3745850	METHOD AND DEVICE FOR RAISING JUVENILE FARM ANIMALS
A01K 31/22 (2006.01)	3745850	METHOD AND DEVICE FOR RAISING JUVENILE FARM ANIMALS
B61C 17/00 (2006.01)	3725635	ACTIVATION CONTROL METHOD AND DEVICE FOR RAIL TRAIN
B65D 23/00 (2006.01)	3717371	DISPENSING CONTAINER WITH INTERIOR ACCESS
B65D 43/16 (2006.01)	3717371	DISPENSING CONTAINER WITH INTERIOR ACCESS
B65D 81/32 (2006.01)	3717371	DISPENSING CONTAINER WITH INTERIOR ACCESS
B65D 81/38 (2006.01)	3717371	DISPENSING CONTAINER WITH INTERIOR ACCESS
B65D 85/80 (2006.01)	3717371	DISPENSING CONTAINER WITH INTERIOR ACCESS
B61D 17/00 (2006.01)	3725638	COLLISION ENERGY ABSORPTION STRUCTURE AND RAIL VEHICLE HAVING SAME
B61F 1/00 (2006.01)	3725638	COLLISION ENERGY ABSORPTION STRUCTURE AND RAIL VEHICLE HAVING SAME
B61F 19/04 (2006.01)	3725638	COLLISION ENERGY ABSORPTION STRUCTURE AND RAIL VEHICLE HAVING SAME
A61B 17/00 (2006.01)	3756606	SURGICAL ROBOT MECHANISM WITH SINGLE-PORT AND MULTI-PORT MINIMALLY INVASIVE OPERATION FUNCTIONS
A61B 34/30 (2016.01)	3756606	SURGICAL ROBOT MECHANISM WITH SINGLE-PORT AND MULTI-PORT MINIMALLY INVASIVE OPERATION FUNCTIONS
G06F 3/048 (2013.01)	3742269	VIEWING ANGLE ADJUSTMENT METHOD AND APPARATUS, STORAGE MEDIUM, AND ELECTRONIC APPARATUS
A61N 2/00 (2006.01)	3744392	METHOD FOR CARTILAGE REGENERATION, MAGNETIC PULSE DEVICE, AND COIL APPLIED TO MAGNETIC PULSE DEVICE
B08B 3/02 (2006.01)	3623064	A DEVICE AND METHOD FOR WASHING STORAGE CONTAINERS
B08B 9/08 (2006.01)	3623064	A DEVICE AND METHOD FOR WASHING STORAGE CONTAINERS
A61K 31/437 (2006.01)	3735411	1, 3, 4, 5-TETRAHYDRO-2H-PYRIDO[4,3-B]INDOLE DERIVATIVES FOR THE TREATMENT, ALLEVIATION OR PREVENTION OF DISORDERS ASSOCIATED WITH TAU AGGREGATES LIKE ALZHEIMER'S DISEASE
A61P 25/28 (2006.01)	3735411	1, 3, 4, 5-TETRAHYDRO-2H-PYRIDO[4,3-B]INDOLE DERIVATIVES FOR THE TREATMENT, ALLEVIATION OR PREVENTION OF DISORDERS ASSOCIATED WITH TAU AGGREGATES LIKE ALZHEIMER'S DISEASE
C07D 471/04 (2006.01)	3735411	1, 3, 4, 5-TETRAHYDRO-2H-PYRIDO[4,3-B]INDOLE DERIVATIVES FOR THE TREATMENT, ALLEVIATION OR PREVENTION OF DISORDERS ASSOCIATED WITH TAU AGGREGATES LIKE ALZHEIMER'S DISEASE
A61K 9/20 (2006.01)	3735227	IMMEDIATE-RELEASE PHARMACEUTICAL COMPOSITIONS CONTAINING KETOPROFEN LYSINE SALT
A61K 31/192 (2006.01)	3735227	IMMEDIATE-RELEASE PHARMACEUTICAL COMPOSITIONS CONTAINING KETOPROFEN LYSINE SALT
A61K 31/205 (2006.01)	3735227	IMMEDIATE-RELEASE PHARMACEUTICAL COMPOSITIONS CONTAINING KETOPROFEN LYSINE SALT
B44C 1/22 (2006.01)	3737780	PROCESS FOR MAKING ETCHED PATTERNS
C23F 1/02 (2006.01)	3737780	PROCESS FOR MAKING ETCHED PATTERNS
A61K 31/4184 (2006.01)	3740478	FUSED IMIDAZOLE DERIVATIVES AS IL-17 MODULATORS
A61P 29/00 (2006.01)	3740478	FUSED IMIDAZOLE DERIVATIVES AS IL-17 MODULATORS
C07D 403/12 (2006.01)	3740478	FUSED IMIDAZOLE DERIVATIVES AS IL-17 MODULATORS
C07D 403/14 (2006.01)	3740478	FUSED IMIDAZOLE DERIVATIVES AS IL-17 MODULATORS
C07D 405/14 (2006.01)	3740478	FUSED IMIDAZOLE DERIVATIVES AS IL-17 MODULATORS
C07D 413/12 (2006.01)	3740478	FUSED IMIDAZOLE DERIVATIVES AS IL-17 MODULATORS
C07D 413/14 (2006.01)	3740478	FUSED IMIDAZOLE DERIVATIVES AS IL-17 MODULATORS
C07D 487/04 (2006.01)	3740478	FUSED IMIDAZOLE DERIVATIVES AS IL-17 MODULATORS
A61K 31/519 (2006.01)	3740489	PI4KIIIBETA INHIBITORS
A61P 31/16 (2006.01)	3740489	PI4KIIIBETA INHIBITORS
C07D 487/04 (2006.01)	3740489	PI4KIIIBETA INHIBITORS
A61K 9/00 (2006.01)	3740191	OPHTHALMIC COMPOSITIONS COMPRISING BILASTINE, A BETA-CYCLODEXTRIN AND AT LEAST ONE GELLING AGENT
A61K 31/454 (2006.01)	3740191	OPHTHALMIC COMPOSITIONS COMPRISING BILASTINE, A BETA-CYCLODEXTRIN AND AT LEAST ONE GELLING AGENT
A61K 47/40 (2006.01)	3740191	OPHTHALMIC COMPOSITIONS COMPRISING BILASTINE, A BETA-CYCLODEXTRIN AND AT LEAST ONE GELLING AGENT

MKP (51)	Broj objave evropske prijava patenta (97)	Naziv pronalaska (54)
A61P 27/14 (2006.01)	3740191	OPHTHALMIC COMPOSITIONS COMPRISING BILASTINE, A BETA-CYCLODEXTRIN AND AT LEAST ONE GELLING AGENT
A61K 31/437 (2006.01)	3746437	PROTEIN KINASE MKK4 INHIBITORS FOR PROMOTING LIVER REGENERATION OR REDUCING OR PREVENTING HEPATOCYTE DEATH
A61P 1/16 (2006.01)	3746437	PROTEIN KINASE MKK4 INHIBITORS FOR PROMOTING LIVER REGENERATION OR REDUCING OR PREVENTING HEPATOCYTE DEATH
A61P 19/02 (2006.01)	3746437	PROTEIN KINASE MKK4 INHIBITORS FOR PROMOTING LIVER REGENERATION OR REDUCING OR PREVENTING HEPATOCYTE DEATH
A61P 25/00 (2006.01)	3746437	PROTEIN KINASE MKK4 INHIBITORS FOR PROMOTING LIVER REGENERATION OR REDUCING OR PREVENTING HEPATOCYTE DEATH
C07D 405/04 (2006.01)	3746437	PROTEIN KINASE MKK4 INHIBITORS FOR PROMOTING LIVER REGENERATION OR REDUCING OR PREVENTING HEPATOCYTE DEATH
C07D 471/04 (2006.01)	3746437	PROTEIN KINASE MKK4 INHIBITORS FOR PROMOTING LIVER REGENERATION OR REDUCING OR PREVENTING HEPATOCYTE DEATH
A61K 35/74 (2015.01)	3740218	COMBINATION THERAPY FOR TREATING OR PREVENTING CANCER
A61K 39/395 (2006.01)	3740218	COMBINATION THERAPY FOR TREATING OR PREVENTING CANCER
A61P 35/00 (2006.01)	3740218	COMBINATION THERAPY FOR TREATING OR PREVENTING CANCER
A61K 31/407 (2006.01)	3740492	1,2,3',5'-TETRAHYDRO-2'H-SPIRO[INDOLE-3,1'-PYRROLO[3,4-C]PYRROLE]-2,3'-DIONE COMPOUNDS AS THERAPEUTIC AGENTS ACTIVATING TP53
A61P 35/00 (2006.01)	3740492	1,2,3',5'-TETRAHYDRO-2'H-SPIRO[INDOLE-3,1'-PYRROLO[3,4-C]PYRROLE]-2,3'-DIONE COMPOUNDS AS THERAPEUTIC AGENTS ACTIVATING TP53
A61P 37/00 (2006.01)	3740492	1,2,3',5'-TETRAHYDRO-2'H-SPIRO[INDOLE-3,1'-PYRROLO[3,4-C]PYRROLE]-2,3'-DIONE COMPOUNDS AS THERAPEUTIC AGENTS ACTIVATING TP53
C07D 487/10 (2006.01)	3740492	1,2,3',5'-TETRAHYDRO-2'H-SPIRO[INDOLE-3,1'-PYRROLO[3,4-C]PYRROLE]-2,3'-DIONE COMPOUNDS AS THERAPEUTIC AGENTS ACTIVATING TP53
A61K 9/00 (2006.01)	3737386	FORMULATION FOR ADMINISTRATION OF RNA
A61K 31/7105 (2006.01)	3737386	FORMULATION FOR ADMINISTRATION OF RNA
A61K 39/12 (2006.01)	3737386	FORMULATION FOR ADMINISTRATION OF RNA
C12N 15/87 (2006.01)	3737386	FORMULATION FOR ADMINISTRATION OF RNA
C07K 16/00 (2006.01)	3743440	POLYPEPTIDE VARIANTS AND USES THEREOF
C07K 16/28 (2006.01)	3743440	POLYPEPTIDE VARIANTS AND USES THEREOF
C07K 16/30 (2006.01)	3743440	POLYPEPTIDE VARIANTS AND USES THEREOF
A61K 31/437 (2006.01)	3746450	HETEROCYCLYL-SUBSTITUTED OXADIAZOLOPYRIDINE DERIVATIVES FOR USE AS GHRELIN O-ACYL TRANSFERASE (GOAT) INHIBITORS
A61P 3/04 (2006.01)	3746450	HETEROCYCLYL-SUBSTITUTED OXADIAZOLOPYRIDINE DERIVATIVES FOR USE AS GHRELIN O-ACYL TRANSFERASE (GOAT) INHIBITORS
A61P 3/10 (2006.01)	3746450	HETEROCYCLYL-SUBSTITUTED OXADIAZOLOPYRIDINE DERIVATIVES FOR USE AS GHRELIN O-ACYL TRANSFERASE (GOAT) INHIBITORS
C07D 498/04 (2006.01)	3746450	HETEROCYCLYL-SUBSTITUTED OXADIAZOLOPYRIDINE DERIVATIVES FOR USE AS GHRELIN O-ACYL TRANSFERASE (GOAT) INHIBITORS
A01N 25/04 (2006.01)	3737232	HERBICIDAL COMPOSITIONS COMPRISING A CAPSULE SUSPENSION FORMULATION OF PETHOXAMID
A01N 25/28 (2006.01)	3737232	HERBICIDAL COMPOSITIONS COMPRISING A CAPSULE SUSPENSION FORMULATION OF PETHOXAMID
A01N 37/20 (2006.01)	3737232	HERBICIDAL COMPOSITIONS COMPRISING A CAPSULE SUSPENSION FORMULATION OF PETHOXAMID
A61K 8/02 (2006.01)	3743160	SURFACE-REACTED CALCIUM CARBONATE FOR THE USE AS SKIN APPEARANCE MODIFIER
A61K 8/19 (2006.01)	3743160	SURFACE-REACTED CALCIUM CARBONATE FOR THE USE AS SKIN APPEARANCE MODIFIER
A61Q 1/02 (2006.01)	3743160	SURFACE-REACTED CALCIUM CARBONATE FOR THE USE AS SKIN APPEARANCE MODIFIER

MKP (51)	Broj objave evropske prijava patenta (97)	Naziv pronalaska (54)
A61Q 1/06 (2006.01)	3743160	SURFACE-REACTED CALCIUM CARBONATE FOR THE USE AS SKIN APPEARANCE MODIFIER
A61Q 1/10 (2006.01)	3743160	SURFACE-REACTED CALCIUM CARBONATE FOR THE USE AS SKIN APPEARANCE MODIFIER
C01F 11/18 (2006.01)	3743160	SURFACE-REACTED CALCIUM CARBONATE FOR THE USE AS SKIN APPEARANCE MODIFIER
A61K 8/02 (2006.01)	3743164	SURFACE-REACTED CALCIUM CARBONATE FOR MODIFYING THE BIOMECHANICAL PROPERTIES OF THE SKIN
A61K 8/19 (2006.01)	3743164	SURFACE-REACTED CALCIUM CARBONATE FOR MODIFYING THE BIOMECHANICAL PROPERTIES OF THE SKIN
A61Q 19/00 (2006.01)	3743164	SURFACE-REACTED CALCIUM CARBONATE FOR MODIFYING THE BIOMECHANICAL PROPERTIES OF THE SKIN
A61Q 19/08 (2006.01)	3743164	SURFACE-REACTED CALCIUM CARBONATE FOR MODIFYING THE BIOMECHANICAL PROPERTIES OF THE SKIN
A61K 31/437 (2006.01)	3746451	BENZYL-, (PYRIDIN-3-YL)METHYL- OR (PYRIDIN-4-YL)METHYL-SUBSTITUTED OXADIAZOLOPYRIDINE DERIVATIVES AS GHRELIN O-ACYL TRANSFERASE (GOAT) INHIBITORS
A61K 31/444 (2006.01)	3746451	BENZYL-, (PYRIDIN-3-YL)METHYL- OR (PYRIDIN-4-YL)METHYL-SUBSTITUTED OXADIAZOLOPYRIDINE DERIVATIVES AS GHRELIN O-ACYL TRANSFERASE (GOAT) INHIBITORS
A61K 31/4545 (2006.01)	3746451	BENZYL-, (PYRIDIN-3-YL)METHYL- OR (PYRIDIN-4-YL)METHYL-SUBSTITUTED OXADIAZOLOPYRIDINE DERIVATIVES AS GHRELIN O-ACYL TRANSFERASE (GOAT) INHIBITORS
A61K 31/497 (2006.01)	3746451	BENZYL-, (PYRIDIN-3-YL)METHYL- OR (PYRIDIN-4-YL)METHYL-SUBSTITUTED OXADIAZOLOPYRIDINE DERIVATIVES AS GHRELIN O-ACYL TRANSFERASE (GOAT) INHIBITORS
A61K 31/501 (2006.01)	3746451	BENZYL-, (PYRIDIN-3-YL)METHYL- OR (PYRIDIN-4-YL)METHYL-SUBSTITUTED OXADIAZOLOPYRIDINE DERIVATIVES AS GHRELIN O-ACYL TRANSFERASE (GOAT) INHIBITORS
A61K 31/5377 (2006.01)	3746451	BENZYL-, (PYRIDIN-3-YL)METHYL- OR (PYRIDIN-4-YL)METHYL-SUBSTITUTED OXADIAZOLOPYRIDINE DERIVATIVES AS GHRELIN O-ACYL TRANSFERASE (GOAT) INHIBITORS
A61P 3/00 (2006.01)	3746451	BENZYL-, (PYRIDIN-3-YL)METHYL- OR (PYRIDIN-4-YL)METHYL-SUBSTITUTED OXADIAZOLOPYRIDINE DERIVATIVES AS GHRELIN O-ACYL TRANSFERASE (GOAT) INHIBITORS
A61P 3/10 (2006.01)	3746451	BENZYL-, (PYRIDIN-3-YL)METHYL- OR (PYRIDIN-4-YL)METHYL-SUBSTITUTED OXADIAZOLOPYRIDINE DERIVATIVES AS GHRELIN O-ACYL TRANSFERASE (GOAT) INHIBITORS
C07D 498/04 (2006.01)	3746451	BENZYL-, (PYRIDIN-3-YL)METHYL- OR (PYRIDIN-4-YL)METHYL-SUBSTITUTED OXADIAZOLOPYRIDINE DERIVATIVES AS GHRELIN O-ACYL TRANSFERASE (GOAT) INHIBITORS
C07D 519/00 (2006.01)	3746451	BENZYL-, (PYRIDIN-3-YL)METHYL- OR (PYRIDIN-4-YL)METHYL-SUBSTITUTED OXADIAZOLOPYRIDINE DERIVATIVES AS GHRELIN O-ACYL TRANSFERASE (GOAT) INHIBITORS
A61K 31/519 (2006.01)	3746443	TRIAZOLOPYRIMIDINE DERIVATIVES FOR USE AS GHRELIN O-ACYL TRANSFERASE (GOAT) INHIBITORS
A61P 3/00 (2006.01)	3746443	TRIAZOLOPYRIMIDINE DERIVATIVES FOR USE AS GHRELIN O-ACYL TRANSFERASE (GOAT) INHIBITORS
C07D 487/04 (2006.01)	3746443	TRIAZOLOPYRIMIDINE DERIVATIVES FOR USE AS GHRELIN O-ACYL TRANSFERASE (GOAT) INHIBITORS
H04N 21/63 (2011.01)	3744106	A LIVE VIDEO RENDERING AND BROADCASTING SYSTEM
A23L 33/16 (2016.01)	3746045	USE OF FUNCTIONALIZED CALCIUM CARBONATE AS ACTIVE INGREDIENT
A61K 9/00 (2006.01)	3746045	USE OF FUNCTIONALIZED CALCIUM CARBONATE AS ACTIVE INGREDIENT
A61K 33/10 (2006.01)	3746045	USE OF FUNCTIONALIZED CALCIUM CARBONATE AS ACTIVE INGREDIENT
A61K 31/519 (2006.01)	3746444	CYCLOALKYL SUBSTITUTED PYRAZOLOPYRIMIDINES HAVING ACTIVITY AGAINST RSV
A61P 31/14 (2006.01)	3746444	CYCLOALKYL SUBSTITUTED PYRAZOLOPYRIMIDINES HAVING ACTIVITY AGAINST RSV
C07D 487/04 (2006.01)	3746444	CYCLOALKYL SUBSTITUTED PYRAZOLOPYRIMIDINES HAVING ACTIVITY AGAINST RSV
B01J 19/00 (2006.01)	3749668	CONTINUOUS PROCESS FOR THE PREPARATION OF TRAZODONE
C07D 471/04 (2006.01)	3749668	CONTINUOUS PROCESS FOR THE PREPARATION OF TRAZODONE
A61K 47/68 (2017.01)	3749372	EDB TARGETING IL-12 COMPOSITIONS
A61P 35/00 (2006.01)	3749372	EDB TARGETING IL-12 COMPOSITIONS
C07K 14/54 (2006.01)	3749372	EDB TARGETING IL-12 COMPOSITIONS

MKP (51)	Broj objave evropske prijava patenta (97)	Naziv pronalaska (54)
C07K 16/18 (2006.01)	3749372	EDB TARGETING IL-12 COMPOSITIONS
A61K 35/17 (2015.01)	3743511	BIOMARKER PREDICTIVE OF TUMOUR INFILTRATING LYMPHOCYTE THERAPY AND USES THEREOF
C12N 5/0783 (2010.01)	3743511	BIOMARKER PREDICTIVE OF TUMOUR INFILTRATING LYMPHOCYTE THERAPY AND USES THEREOF
A61K 31/712 (2006.01)	3737387	ANTISENSE OLIGONUCLEOTIDES TARGETING ALPHA-SYNUCLEIN AND USES THEREOF
C12N 15/113 (2010.01)	3737387	ANTISENSE OLIGONUCLEOTIDES TARGETING ALPHA-SYNUCLEIN AND USES THEREOF
C07K 14/47 (2006.01)	3737761	ANTISENSE OLIGONUCLEOTIDES TARGETING ALPHA-SYNUCLEIN AND USES THEREOF
C12N 15/113 (2010.01)	3737761	ANTISENSE OLIGONUCLEOTIDES TARGETING ALPHA-SYNUCLEIN AND USES THEREOF
A61P 11/00 (2006.01)	3743406	COMPOUNDS
C07C 1/00 (2006.01)	3743406	COMPOUNDS
C07D 213/72 (2006.01)	3743406	COMPOUNDS
C07D 309/10 (2006.01)	3743406	COMPOUNDS
C07D 401/12 (2006.01)	3743406	COMPOUNDS
C07D 405/12 (2006.01)	3743406	COMPOUNDS
C07D 413/12 (2006.01)	3743406	COMPOUNDS
C07D 417/12 (2006.01)	3743406	COMPOUNDS
A61K 31/565 (2006.01)	3749327	CONTRACEPTIVE COMPOSITION WITH REDUCED CARDIOVASCULAR EFFECTS
A61P 15/18 (2006.01)	3749327	CONTRACEPTIVE COMPOSITION WITH REDUCED CARDIOVASCULAR EFFECTS
A61K 35/74 (2015.01)	3740219	COMBINATION THERAPY FOR TREATING OR PREVENTING CANCER
A61K 39/395 (2006.01)	3740219	COMBINATION THERAPY FOR TREATING OR PREVENTING CANCER
A61P 35/00 (2006.01)	3740219	COMBINATION THERAPY FOR TREATING OR PREVENTING CANCER
A61K 35/74 (2015.01)	3740220	COMBINATION THERAPY FOR TREATING OR PREVENTING CANCER
A61K 39/395 (2006.01)	3740220	COMBINATION THERAPY FOR TREATING OR PREVENTING CANCER
A61P 35/00 (2006.01)	3740220	COMBINATION THERAPY FOR TREATING OR PREVENTING CANCER
A41D 1/22 (2018.01)	3752018	ITEM OF CLOTHING HAVING A MODULAR STRUCTURE
A61K 31/7105 (2006.01)	3752177	TREATMENT USING CYTOKINE ENCODING RNA
A61K 31/713 (2006.01)	3752177	TREATMENT USING CYTOKINE ENCODING RNA
A61K 38/20 (2006.01)	3752177	TREATMENT USING CYTOKINE ENCODING RNA
A61K 39/21 (2006.01)	3752177	TREATMENT USING CYTOKINE ENCODING RNA
C07K 14/54 (2006.01)	3752177	TREATMENT USING CYTOKINE ENCODING RNA
C07K 14/55 (2006.01)	3752177	TREATMENT USING CYTOKINE ENCODING RNA
C07K 14/565 (2006.01)	3752177	TREATMENT USING CYTOKINE ENCODING RNA
C07K 14/765 (2006.01)	3752177	TREATMENT USING CYTOKINE ENCODING RNA
C12N 15/62 (2006.01)	3752177	TREATMENT USING CYTOKINE ENCODING RNA
C07C 237/06 (2006.01)	3737679	NOVEL PROCESSES AND INTERMEDIATES FOR THE PREPARATION OF SOLUBLE GUANYLATE CYCLASE STIMULATORS
C07D 239/34 (2006.01)	3737679	NOVEL PROCESSES AND INTERMEDIATES FOR THE PREPARATION OF SOLUBLE GUANYLATE CYCLASE STIMULATORS
C07D 263/06 (2006.01)	3737679	NOVEL PROCESSES AND INTERMEDIATES FOR THE PREPARATION OF SOLUBLE GUANYLATE CYCLASE STIMULATORS
C07D 413/14 (2006.01)	3737679	NOVEL PROCESSES AND INTERMEDIATES FOR THE PREPARATION OF SOLUBLE GUANYLATE CYCLASE STIMULATORS
A61K 47/54 (2017.01)	3737694	ANTI-PD-1 ANTIBODIES AND METHODS OF TREATMENT
A61K 47/60 (2017.01)	3737694	ANTI-PD-1 ANTIBODIES AND METHODS OF TREATMENT
C07K 14/54 (2006.01)	3737694	ANTI-PD-1 ANTIBODIES AND METHODS OF TREATMENT
C07K 16/28 (2006.01)	3737694	ANTI-PD-1 ANTIBODIES AND METHODS OF TREATMENT
A61K 31/506 (2006.01)	3740479	DNA-PK INHIBITORS
A61K 31/5377 (2006.01)	3740479	DNA-PK INHIBITORS
A61K 31/5386 (2006.01)	3740479	DNA-PK INHIBITORS
A61P 35/00 (2006.01)	3740479	DNA-PK INHIBITORS
C07D 403/12 (2006.01)	3740479	DNA-PK INHIBITORS
C07D 413/12 (2006.01)	3740479	DNA-PK INHIBITORS
C12N 15/10 (2006.01)	3740479	DNA-PK INHIBITORS

MKP (51)	Broj objave evropske prijava patenta (97)	Naziv pronalaska (54)
A61M 5/142 (2006.01)	3740264	DRUG DELIVERY MECHANISM
A61M 5/145 (2006.01)	3740264	DRUG DELIVERY MECHANISM
A61M 5/315 (2006.01)	3740264	DRUG DELIVERY MECHANISM
B09B 3/00 (2006.01)	3752648	BUILDING MATERIALS COMPRISING DIGESTATE
C04B 33/04 (2006.01)	3752648	BUILDING MATERIALS COMPRISING DIGESTATE
C04B 33/132 (2006.01)	3752648	BUILDING MATERIALS COMPRISING DIGESTATE
C04B 33/135 (2006.01)	3752648	BUILDING MATERIALS COMPRISING DIGESTATE
C04B 33/30 (2006.01)	3752648	BUILDING MATERIALS COMPRISING DIGESTATE
C04B 33/32 (2006.01)	3752648	BUILDING MATERIALS COMPRISING DIGESTATE
C12R 1/00 (2006.01)	3752648	BUILDING MATERIALS COMPRISING DIGESTATE
A61K 9/00 (2006.01)	3735219	ORAL LIQUID PHARMACEUTICAL COMPOSITIONS OF AMINOSALICYLATES
A61K 9/10 (2006.01)	3735219	ORAL LIQUID PHARMACEUTICAL COMPOSITIONS OF AMINOSALICYLATES
A61K 9/16 (2006.01)	3735219	ORAL LIQUID PHARMACEUTICAL COMPOSITIONS OF AMINOSALICYLATES
A61K 9/50 (2006.01)	3735219	ORAL LIQUID PHARMACEUTICAL COMPOSITIONS OF AMINOSALICYLATES
A61J 1/14 (2006.01)	3735399	METHOD OF PREVENTING LAMELLAR SILICA FORMATION IN GLASS CONTAINER
B08B 11/00 (2006.01)	3735399	METHOD OF PREVENTING LAMELLAR SILICA FORMATION IN GLASS CONTAINER
C03C 23/00 (2006.01)	3735399	METHOD OF PREVENTING LAMELLAR SILICA FORMATION IN GLASS CONTAINER
G01N 17/00 (2006.01)	3735399	METHOD OF PREVENTING LAMELLAR SILICA FORMATION IN GLASS CONTAINER
G01N 21/90 (2006.01)	3735399	METHOD OF PREVENTING LAMELLAR SILICA FORMATION IN GLASS CONTAINER
G01N 33/38 (2006.01)	3735399	METHOD OF PREVENTING LAMELLAR SILICA FORMATION IN GLASS CONTAINER
A61K 39/395 (2006.01)	3735270	POLYNUCLEOTIDES ENCODING ANTI-CHIKUNGUNYA VIRUS ANTIBODIES
A61K 39/42 (2006.01)	3735270	POLYNUCLEOTIDES ENCODING ANTI-CHIKUNGUNYA VIRUS ANTIBODIES
A61P 31/14 (2006.01)	3735270	POLYNUCLEOTIDES ENCODING ANTI-CHIKUNGUNYA VIRUS ANTIBODIES
C07K 16/10 (2006.01)	3735270	POLYNUCLEOTIDES ENCODING ANTI-CHIKUNGUNYA VIRUS ANTIBODIES
A61K 35/17 (2015.01)	3737743	PROCESSES FOR GENERATING TIL PRODUCTS ENRICHED FOR TUMOR ANTIGEN-SPECIFIC T-CELLS
C12N 5/0783 (2010.01)	3737743	PROCESSES FOR GENERATING TIL PRODUCTS ENRICHED FOR TUMOR ANTIGEN-SPECIFIC T-CELLS
A61K 31/58 (2006.01)	3737687	AZA-, OXA AND THIA-PREGNAN-20-ONE-3.ALPHA.-OL COMPOUNDS FOR USE IN TREATING CNS DISORDERS
A61P 25/00 (2006.01)	3737687	AZA-, OXA AND THIA-PREGNAN-20-ONE-3.ALPHA.-OL COMPOUNDS FOR USE IN TREATING CNS DISORDERS
C07J 73/00 (2006.01)	3737687	AZA-, OXA AND THIA-PREGNAN-20-ONE-3.ALPHA.-OL COMPOUNDS FOR USE IN TREATING CNS DISORDERS
C07J 75/00 (2006.01)	3737687	AZA-, OXA AND THIA-PREGNAN-20-ONE-3.ALPHA.-OL COMPOUNDS FOR USE IN TREATING CNS DISORDERS
A61K 31/7115 (2006.01)	3740575	MODULATORS OF DNM2 EXPRESSION
A61K 31/712 (2006.01)	3740575	MODULATORS OF DNM2 EXPRESSION
A61K 31/7125 (2006.01)	3740575	MODULATORS OF DNM2 EXPRESSION
C12N 15/113 (2010.01)	3740575	MODULATORS OF DNM2 EXPRESSION
A61P 35/00 (2006.01)	3740480	DNA-PK INHIBITORS
C07D 239/74 (2006.01)	3740480	DNA-PK INHIBITORS
C07D 239/86 (2006.01)	3740480	DNA-PK INHIBITORS
C07D 239/88 (2006.01)	3740480	DNA-PK INHIBITORS
C07D 239/94 (2006.01)	3740480	DNA-PK INHIBITORS
C07D 401/12 (2006.01)	3740480	DNA-PK INHIBITORS
C07D 403/12 (2006.01)	3740480	DNA-PK INHIBITORS
C07D 417/12 (2006.01)	3740480	DNA-PK INHIBITORS
C07D 491/048 (2006.01)	3740480	DNA-PK INHIBITORS
A61K 31/4196 (2006.01)	3740481	DIHYDROBENZOFURAN AND INDEN ANALOGS AS CARDIAC SARCOMERE INHIBITORS
A61P 9/04 (2006.01)	3740481	DIHYDROBENZOFURAN AND INDEN ANALOGS AS CARDIAC SARCOMERE INHIBITORS
C07D 231/14 (2006.01)	3740481	DIHYDROBENZOFURAN AND INDEN ANALOGS AS CARDIAC SARCOMERE INHIBITORS

MKP (51)	Broj objave evropske prijava patenta (97)	Naziv pronalaska (54)
C07D 271/06 (2006.01)	3740481	DIHYDROBENZOFURAN AND INDEN ANALOGS AS CARDIAC SARCOMERE INHIBITORS
C07D 401/12 (2006.01)	3740481	DIHYDROBENZOFURAN AND INDEN ANALOGS AS CARDIAC SARCOMERE INHIBITORS
C07D 403/12 (2006.01)	3740481	DIHYDROBENZOFURAN AND INDEN ANALOGS AS CARDIAC SARCOMERE INHIBITORS
C07D 413/04 (2006.01)	3740481	DIHYDROBENZOFURAN AND INDEN ANALOGS AS CARDIAC SARCOMERE INHIBITORS
C07D 413/12 (2006.01)	3740481	DIHYDROBENZOFURAN AND INDEN ANALOGS AS CARDIAC SARCOMERE INHIBITORS
C07D 413/14 (2006.01)	3740481	DIHYDROBENZOFURAN AND INDEN ANALOGS AS CARDIAC SARCOMERE INHIBITORS
C07D 417/12 (2006.01)	3740481	DIHYDROBENZOFURAN AND INDEN ANALOGS AS CARDIAC SARCOMERE INHIBITORS
A61K 39/395 (2006.01)	3749360	PHARMACEUTICAL COMPOSITIONS COMPRISING BISPECIFIC ANTIBODIES DIRECTED AGAINST CD3 AND CD20 AND THEIR USES
A61P 35/00 (2006.01)	3749360	PHARMACEUTICAL COMPOSITIONS COMPRISING BISPECIFIC ANTIBODIES DIRECTED AGAINST CD3 AND CD20 AND THEIR USES
C07K 16/28 (2006.01)	3749360	PHARMACEUTICAL COMPOSITIONS COMPRISING BISPECIFIC ANTIBODIES DIRECTED AGAINST CD3 AND CD20 AND THEIR USES
A61K 31/404 (2006.01)	3743413	ESTROGEN RECEPTOR-MODULATING COMPOUNDS
A61P 35/00 (2006.01)	3743413	ESTROGEN RECEPTOR-MODULATING COMPOUNDS
C07C 215/48 (2006.01)	3743413	ESTROGEN RECEPTOR-MODULATING COMPOUNDS
C07D 209/12 (2006.01)	3743413	ESTROGEN RECEPTOR-MODULATING COMPOUNDS
C07D 209/30 (2006.01)	3743413	ESTROGEN RECEPTOR-MODULATING COMPOUNDS
C07D 313/08 (2006.01)	3743413	ESTROGEN RECEPTOR-MODULATING COMPOUNDS
C07D 333/64 (2006.01)	3743413	ESTROGEN RECEPTOR-MODULATING COMPOUNDS
C07D 409/12 (2006.01)	3743413	ESTROGEN RECEPTOR-MODULATING COMPOUNDS
C07D 487/04 (2006.01)	3743413	ESTROGEN RECEPTOR-MODULATING COMPOUNDS
B29C 64/245 (2017.01)	3743262	ADDITIVELY MANUFACTURED STRUCTURE AND METHOD FOR MAKING THE SAME
B29C 64/40 (2017.01)	3743262	ADDITIVELY MANUFACTURED STRUCTURE AND METHOD FOR MAKING THE SAME
B33Y 10/00 (2015.01)	3743262	ADDITIVELY MANUFACTURED STRUCTURE AND METHOD FOR MAKING THE SAME
B33Y 30/00 (2015.01)	3743262	ADDITIVELY MANUFACTURED STRUCTURE AND METHOD FOR MAKING THE SAME
A61K 38/08 (2019.01)	3755708	PEPTIDES AND COMBINATION OF PEPTIDES OF NON-CANONICAL ORIGIN FOR USE IN IMMUNOTHERAPY AGAINST DIFFERENT TYPES OF CANCERS
C07K 7/06 (2006.01)	3755708	PEPTIDES AND COMBINATION OF PEPTIDES OF NON-CANONICAL ORIGIN FOR USE IN IMMUNOTHERAPY AGAINST DIFFERENT TYPES OF CANCERS
C07K 14/47 (2006.01)	3755708	PEPTIDES AND COMBINATION OF PEPTIDES OF NON-CANONICAL ORIGIN FOR USE IN IMMUNOTHERAPY AGAINST DIFFERENT TYPES OF CANCERS
A61K 35/74 (2015.01)	3740221	COMBINATION THERAPY FOR TREATING OR PREVENTING CANCER
A61K 39/395 (2006.01)	3740221	COMBINATION THERAPY FOR TREATING OR PREVENTING CANCER
A61P 35/00 (2006.01)	3740221	COMBINATION THERAPY FOR TREATING OR PREVENTING CANCER
A23K 20/10 (2016.01)	3737241	NUTRITIONAL SOLID COMPOSITIONS WITH ACARICIDE ACTIVITY FOR APICULTURE AND THEIR USE FOR THE PROPHYLAXIS AND TREATMENT OF VARROA INFESTATIONS
A23K 20/105 (2016.01)	3737241	NUTRITIONAL SOLID COMPOSITIONS WITH ACARICIDE ACTIVITY FOR APICULTURE AND THEIR USE FOR THE PROPHYLAXIS AND TREATMENT OF VARROA INFESTATIONS
A23K 20/147 (2016.01)	3737241	NUTRITIONAL SOLID COMPOSITIONS WITH ACARICIDE ACTIVITY FOR APICULTURE AND THEIR USE FOR THE PROPHYLAXIS AND TREATMENT OF VARROA INFESTATIONS
A23K 20/158 (2016.01)	3737241	NUTRITIONAL SOLID COMPOSITIONS WITH ACARICIDE ACTIVITY FOR APICULTURE AND THEIR USE FOR THE PROPHYLAXIS AND TREATMENT OF VARROA INFESTATIONS
A23K 20/163 (2016.01)	3737241	NUTRITIONAL SOLID COMPOSITIONS WITH ACARICIDE ACTIVITY FOR APICULTURE AND THEIR USE FOR THE PROPHYLAXIS AND TREATMENT OF VARROA INFESTATIONS

MKP (51)	Broj objave evropske prijava patenta (97)	Naziv pronalaska (54)
A23K 50/90 (2016.01)	3737241	NUTRITIONAL SOLID COMPOSITIONS WITH ACARICIDE ACTIVITY FOR APICULTURE AND THEIR USE FOR THE PROPHYLAXIS AND TREATMENT OF VARROA INFESTATIONS
A61K 36/00 (2006.01)	3737241	NUTRITIONAL SOLID COMPOSITIONS WITH ACARICIDE ACTIVITY FOR APICULTURE AND THEIR USE FOR THE PROPHYLAXIS AND TREATMENT OF VARROA INFESTATIONS
A61K 36/02 (2006.01)	3737241	NUTRITIONAL SOLID COMPOSITIONS WITH ACARICIDE ACTIVITY FOR APICULTURE AND THEIR USE FOR THE PROPHYLAXIS AND TREATMENT OF VARROA INFESTATIONS
A61K 36/05 (2006.01)	3737241	NUTRITIONAL SOLID COMPOSITIONS WITH ACARICIDE ACTIVITY FOR APICULTURE AND THEIR USE FOR THE PROPHYLAXIS AND TREATMENT OF VARROA INFESTATIONS
A61K 36/06 (2006.01)	3737241	NUTRITIONAL SOLID COMPOSITIONS WITH ACARICIDE ACTIVITY FOR APICULTURE AND THEIR USE FOR THE PROPHYLAXIS AND TREATMENT OF VARROA INFESTATIONS
A61K 36/53 (2006.01)	3737241	NUTRITIONAL SOLID COMPOSITIONS WITH ACARICIDE ACTIVITY FOR APICULTURE AND THEIR USE FOR THE PROPHYLAXIS AND TREATMENT OF VARROA INFESTATIONS
A61K 36/886 (2006.01)	3737241	NUTRITIONAL SOLID COMPOSITIONS WITH ACARICIDE ACTIVITY FOR APICULTURE AND THEIR USE FOR THE PROPHYLAXIS AND TREATMENT OF VARROA INFESTATIONS
A61K 31/4427 (2006.01)	3752487	USE OF 5-FLUORO-4-(4-FLUORO-2-METHOXYPHENYL)-N-{4-[(S-METHYLSULFONIMIDOYL)METHYL]PYRIDIN-2-YL}PYRIDIN-2-AMINE FOR TREATING DIFFUSE LARGE B-CELL LYMPHOMA
A61P 35/00 (2006.01)	3752487	USE OF 5-FLUORO-4-(4-FLUORO-2-METHOXYPHENYL)-N-{4-[(S-METHYLSULFONIMIDOYL)METHYL]PYRIDIN-2-YL}PYRIDIN-2-AMINE FOR TREATING DIFFUSE LARGE B-CELL LYMPHOMA
C07D 213/72 (2006.01)	3752487	USE OF 5-FLUORO-4-(4-FLUORO-2-METHOXYPHENYL)-N-{4-[(S-METHYLSULFONIMIDOYL)METHYL]PYRIDIN-2-YL}PYRIDIN-2-AMINE FOR TREATING DIFFUSE LARGE B-CELL LYMPHOMA
A61K 31/166 (2006.01)	3752151	THIOREDOXIN REDUCTASE INHIBITORS FOR USE IN THE TREATMENT OF CANCER
A61K 31/282 (2006.01)	3752151	THIOREDOXIN REDUCTASE INHIBITORS FOR USE IN THE TREATMENT OF CANCER
A61K 31/337 (2006.01)	3752151	THIOREDOXIN REDUCTASE INHIBITORS FOR USE IN THE TREATMENT OF CANCER
A61K 31/436 (2006.01)	3752151	THIOREDOXIN REDUCTASE INHIBITORS FOR USE IN THE TREATMENT OF CANCER
A61K 31/439 (2006.01)	3752151	THIOREDOXIN REDUCTASE INHIBITORS FOR USE IN THE TREATMENT OF CANCER
A61K 31/44 (2006.01)	3752151	THIOREDOXIN REDUCTASE INHIBITORS FOR USE IN THE TREATMENT OF CANCER
A61K 31/4433 (2006.01)	3752151	THIOREDOXIN REDUCTASE INHIBITORS FOR USE IN THE TREATMENT OF CANCER
A61K 31/501 (2006.01)	3752151	THIOREDOXIN REDUCTASE INHIBITORS FOR USE IN THE TREATMENT OF CANCER
A61K 31/506 (2006.01)	3752151	THIOREDOXIN REDUCTASE INHIBITORS FOR USE IN THE TREATMENT OF CANCER
A61K 31/7135 (2006.01)	3752151	THIOREDOXIN REDUCTASE INHIBITORS FOR USE IN THE TREATMENT OF CANCER
A61K 39/395 (2006.01)	3752151	THIOREDOXIN REDUCTASE INHIBITORS FOR USE IN THE TREATMENT OF CANCER
A61K 45/06 (2006.01)	3752151	THIOREDOXIN REDUCTASE INHIBITORS FOR USE IN THE TREATMENT OF CANCER
A61P 35/00 (2006.01)	3752151	THIOREDOXIN REDUCTASE INHIBITORS FOR USE IN THE TREATMENT OF CANCER
A61P 35/04 (2006.01)	3752151	THIOREDOXIN REDUCTASE INHIBITORS FOR USE IN THE TREATMENT OF CANCER
A61K 31/4375 (2006.01)	3743068	COMPOUNDS FOR THE TREATMENT OF KINASE-DEPENDENT DISORDERS
A61K 31/517 (2006.01)	3743068	COMPOUNDS FOR THE TREATMENT OF KINASE-DEPENDENT DISORDERS
A61P 35/00 (2006.01)	3743068	COMPOUNDS FOR THE TREATMENT OF KINASE-DEPENDENT DISORDERS
C07D 239/88 (2006.01)	3743068	COMPOUNDS FOR THE TREATMENT OF KINASE-DEPENDENT DISORDERS
C07D 471/04 (2006.01)	3743068	COMPOUNDS FOR THE TREATMENT OF KINASE-DEPENDENT DISORDERS
A61K 31/47 (2006.01)	3743070	COMPOUNDS FOR THE TREATMENT OF KINASE-DEPENDENT DISORDERS

MKP (51)	Broj objave evropske prijava patenta (97)	Naziv pronalaska (54)
A61K 31/4709 (2006.01)	3743070	COMPOUNDS FOR THE TREATMENT OF KINASE-DEPENDENT DISORDERS
A61P 35/00 (2006.01)	3743070	COMPOUNDS FOR THE TREATMENT OF KINASE-DEPENDENT DISORDERS
C07D 215/22 (2006.01)	3743070	COMPOUNDS FOR THE TREATMENT OF KINASE-DEPENDENT DISORDERS
C07D 401/04 (2006.01)	3743070	COMPOUNDS FOR THE TREATMENT OF KINASE-DEPENDENT DISORDERS
C07D 401/06 (2006.01)	3743070	COMPOUNDS FOR THE TREATMENT OF KINASE-DEPENDENT DISORDERS
C07D 401/12 (2006.01)	3743070	COMPOUNDS FOR THE TREATMENT OF KINASE-DEPENDENT DISORDERS
C07D 405/04 (2006.01)	3743070	COMPOUNDS FOR THE TREATMENT OF KINASE-DEPENDENT DISORDERS
C07D 405/12 (2006.01)	3743070	COMPOUNDS FOR THE TREATMENT OF KINASE-DEPENDENT DISORDERS
C07D 413/04 (2006.01)	3743070	COMPOUNDS FOR THE TREATMENT OF KINASE-DEPENDENT DISORDERS
C07D 413/12 (2006.01)	3743070	COMPOUNDS FOR THE TREATMENT OF KINASE-DEPENDENT DISORDERS
C07D 213/61 (2006.01)	3746429	PROCESSES FOR PREPARING (1 -(3-FLUORO-2-(TRIFLUOROMETHYL)ISONICOTINYL)PIPERIDINE-4-ONE)
C07D 401/04 (2006.01)	3746429	PROCESSES FOR PREPARING (1 -(3-FLUORO-2-(TRIFLUOROMETHYL)ISONICOTINYL)PIPERIDINE-4-ONE)
A61K 48/00 (2006.01)	3746136	USE OF LENTIVIRAL VECTORS EXPRESSING FACTOR VIII
C07K 14/755 (2006.01)	3746136	USE OF LENTIVIRAL VECTORS EXPRESSING FACTOR VIII
C12N 15/867 (2006.01)	3746136	USE OF LENTIVIRAL VECTORS EXPRESSING FACTOR VIII
A61K 31/57 (2006.01)	3755339	3BETA-(4-METHOXYBENZYLOXY)PREGN-5-EN-20-ONE FOR USE IN THE TREATMENT OF CANNABINOIDS-RELATED DISORDERS
A61P 25/30 (2006.01)	3755339	3BETA-(4-METHOXYBENZYLOXY)PREGN-5-EN-20-ONE FOR USE IN THE TREATMENT OF CANNABINOIDS-RELATED DISORDERS
A61K 35/12 (2015.01)	3735412	COMPOSITIONS AND METHODS FOR THE EXPANSION OF HEMATOPOIETIC STEM AND PROGENITOR CELLS AND TREATMENT OF INHERITED METABOLIC DISORDERS
C07D 471/04 (2006.01)	3735412	COMPOSITIONS AND METHODS FOR THE EXPANSION OF HEMATOPOIETIC STEM AND PROGENITOR CELLS AND TREATMENT OF INHERITED METABOLIC DISORDERS
C07D 487/04 (2006.01)	3735412	COMPOSITIONS AND METHODS FOR THE EXPANSION OF HEMATOPOIETIC STEM AND PROGENITOR CELLS AND TREATMENT OF INHERITED METABOLIC DISORDERS
C07D 519/00 (2006.01)	3735412	COMPOSITIONS AND METHODS FOR THE EXPANSION OF HEMATOPOIETIC STEM AND PROGENITOR CELLS AND TREATMENT OF INHERITED METABOLIC DISORDERS
C12N 5/0789 (2010.01)	3735412	COMPOSITIONS AND METHODS FOR THE EXPANSION OF HEMATOPOIETIC STEM AND PROGENITOR CELLS AND TREATMENT OF INHERITED METABOLIC DISORDERS
A61K 31/454 (2006.01)	3735297	COMPOUNDS, COMPOSITIONS, AND METHODS FOR TREATMENT OF DISEASES INVOLVING ACIDIC OR HYPOXIC DISEASED TISSUES
A61K 38/16 (2006.01)	3735297	COMPOUNDS, COMPOSITIONS, AND METHODS FOR TREATMENT OF DISEASES INVOLVING ACIDIC OR HYPOXIC DISEASED TISSUES
A61P 9/00 (2006.01)	3735297	COMPOUNDS, COMPOSITIONS, AND METHODS FOR TREATMENT OF DISEASES INVOLVING ACIDIC OR HYPOXIC DISEASED TISSUES
A61P 25/28 (2006.01)	3735297	COMPOUNDS, COMPOSITIONS, AND METHODS FOR TREATMENT OF DISEASES INVOLVING ACIDIC OR HYPOXIC DISEASED TISSUES
A61P 35/00 (2006.01)	3735297	COMPOUNDS, COMPOSITIONS, AND METHODS FOR TREATMENT OF DISEASES INVOLVING ACIDIC OR HYPOXIC DISEASED TISSUES
C07D 487/06 (2006.01)	3735297	COMPOUNDS, COMPOSITIONS, AND METHODS FOR TREATMENT OF DISEASES INVOLVING ACIDIC OR HYPOXIC DISEASED TISSUES
A61K 47/68 (2017.01)	3737420	STEROIDS AND ANTIBODY-CONJUGATES THEREOF
C07J 71/00 (2006.01)	3737420	STEROIDS AND ANTIBODY-CONJUGATES THEREOF
A61K 31/47 (2006.01)	3737377	COMBINATION THERAPIES FOR THE TREATMENT OF HEPATOCELLULAR CARCINOMA
A61K 31/496 (2006.01)	3737377	COMBINATION THERAPIES FOR THE TREATMENT OF HEPATOCELLULAR CARCINOMA

MKP (51)	Broj objave evropske prijava patenta (97)	Naziv pronalaska (54)
A01G 17/06 (2006.01)	3742886	SUPPORTING DEVICE ON A SUPPORTING POLE, IN PARTICULAR FOR CONTAINMENT WIRES OF A ROW
A61P 37/06 (2006.01)	3755715	LIGANDS TO GM-CSF OR GM-CSF-RECEPTOR FOR USE IN TREATMENT OF A HAEMATOLOGIC MALIGNANCY IN A PATIENT HAVING UNDERGONE ALLO-HCT
C07K 16/24 (2006.01)	3755715	LIGANDS TO GM-CSF OR GM-CSF-RECEPTOR FOR USE IN TREATMENT OF A HAEMATOLOGIC MALIGNANCY IN A PATIENT HAVING UNDERGONE ALLO-HCT
A61K 39/00 (2006.01)	3737701	TRANSFERRIN RECEPTOR-BINDING POLYPEPTIDES AND USES THEREOF
A61K 39/395 (2006.01)	3737701	TRANSFERRIN RECEPTOR-BINDING POLYPEPTIDES AND USES THEREOF
A61P 25/00 (2006.01)	3737701	TRANSFERRIN RECEPTOR-BINDING POLYPEPTIDES AND USES THEREOF
A61P 25/28 (2006.01)	3737701	TRANSFERRIN RECEPTOR-BINDING POLYPEPTIDES AND USES THEREOF
A61P 35/02 (2006.01)	3737701	TRANSFERRIN RECEPTOR-BINDING POLYPEPTIDES AND USES THEREOF
C07K 16/28 (2006.01)	3737701	TRANSFERRIN RECEPTOR-BINDING POLYPEPTIDES AND USES THEREOF
A61K 31/138 (2006.01)	3746126	METHODS AND COMPOSITIONS FOR TREATING SLEEP APNEA
A61K 31/216 (2006.01)	3746126	METHODS AND COMPOSITIONS FOR TREATING SLEEP APNEA
A61K 45/06 (2006.01)	3746126	METHODS AND COMPOSITIONS FOR TREATING SLEEP APNEA
A61P 11/00 (2006.01)	3746126	METHODS AND COMPOSITIONS FOR TREATING SLEEP APNEA
A61P 25/00 (2006.01)	3746126	METHODS AND COMPOSITIONS FOR TREATING SLEEP APNEA
G01N 33/542 (2006.01)	3729088	ASSAY, METHOD AND TREATMENT OF ALPHA-SYNUCLEINOPATHIES
G01N 33/58 (2006.01)	3729088	ASSAY, METHOD AND TREATMENT OF ALPHA-SYNUCLEINOPATHIES
G01N 33/68 (2006.01)	3729088	ASSAY, METHOD AND TREATMENT OF ALPHA-SYNUCLEINOPATHIES
A61K 31/4188 (2006.01)	3720856	DOPAMINE-& X392;-HYDROXYLASE INHIBITORS
A61P 25/00 (2006.01)	3720856	DOPAMINE-& X392;-HYDROXYLASE INHIBITORS
C07D 487/14 (2006.01)	3720856	DOPAMINE-& X392;-HYDROXYLASE INHIBITORS
A61K 35/17 (2015.01)	3724225	ANTI-CCT5 BINDING MOLECULES AND METHODS OF USE THEREOF
A61K 39/00 (2006.01)	3724225	ANTI-CCT5 BINDING MOLECULES AND METHODS OF USE THEREOF
A61P 35/00 (2006.01)	3724225	ANTI-CCT5 BINDING MOLECULES AND METHODS OF USE THEREOF
C07K 16/18 (2006.01)	3724225	ANTI-CCT5 BINDING MOLECULES AND METHODS OF USE THEREOF
C07K 16/46 (2006.01)	3724225	ANTI-CCT5 BINDING MOLECULES AND METHODS OF USE THEREOF
A61K 31/517 (2006.01)	3728207	QUINAZOLINONES AS PARP14 INHIBITORS
A61P 29/00 (2006.01)	3728207	QUINAZOLINONES AS PARP14 INHIBITORS
A61P 35/00 (2006.01)	3728207	QUINAZOLINONES AS PARP14 INHIBITORS
C07D 239/88 (2006.01)	3728207	QUINAZOLINONES AS PARP14 INHIBITORS
C07D 401/12 (2006.01)	3728207	QUINAZOLINONES AS PARP14 INHIBITORS
C07D 401/14 (2006.01)	3728207	QUINAZOLINONES AS PARP14 INHIBITORS
C07D 405/12 (2006.01)	3728207	QUINAZOLINONES AS PARP14 INHIBITORS
C07D 405/14 (2006.01)	3728207	QUINAZOLINONES AS PARP14 INHIBITORS
C07D 413/14 (2006.01)	3728207	QUINAZOLINONES AS PARP14 INHIBITORS
C07D 417/14 (2006.01)	3728207	QUINAZOLINONES AS PARP14 INHIBITORS
C07K 14/705 (2006.01)	3717509	SynP61, A PRIMATE RETINAL PIGMENT EPITHELIUM CELL-SPECIFIC PROMOTER
C12N 15/85 (2006.01)	3717509	SynP61, A PRIMATE RETINAL PIGMENT EPITHELIUM CELL-SPECIFIC PROMOTER
C12N 15/85 (2006.01)	3717651	SYNPIII, A PROMOTER FOR THE SPECIFIC EXPRESSION OF GENES IN RETINAL PIGMENT EPITHELIUM
H01G 9/04 (2006.01)	3729527	ACTIVE MATERIAL AND ELECTRIC POWER GENERATOR CONTAINING IT
H01L 35/22 (2006.01)	3729527	ACTIVE MATERIAL AND ELECTRIC POWER GENERATOR CONTAINING IT
A61K 31/506 (2006.01)	3727388	SGC STIMULATORS
C07D 487/04 (2006.01)	3727388	SGC STIMULATORS
C07F 9/09 (2006.01)	3727388	SGC STIMULATORS
A01N 63/02 (2006.01)	3728606	PESTICIDAL GENES AND METHODS OF USE
C07K 14/32 (2006.01)	3728606	PESTICIDAL GENES AND METHODS OF USE
C07K 14/325 (2006.01)	3728606	PESTICIDAL GENES AND METHODS OF USE

MKP (51)	Broj objave evropske prijava patenta (97)	Naziv pronalaska (54)
C12N 15/31 (2006.01)	3728606	PESTICIDAL GENES AND METHODS OF USE
C12N 15/32 (2006.01)	3728606	PESTICIDAL GENES AND METHODS OF USE
C12N 15/82 (2006.01)	3728606	PESTICIDAL GENES AND METHODS OF USE
A61K 38/45 (2006.01)	3727428	IMPROVED COMPOSITION AND METHODS FOR TREATMENT OF ORNITHINE TRANSCARBAMYLASE DEFICIENCY
A61P 3/00 (2006.01)	3727428	IMPROVED COMPOSITION AND METHODS FOR TREATMENT OF ORNITHINE TRANSCARBAMYLASE DEFICIENCY
A61K 9/127 (2006.01)	3735226	INJECTABLE COMPOSITIONS OF TRITERPENOID ANTIFUNGALS ENCAPSULATED IN LIPOSOMES
A61K 31/4196 (2006.01)	3735226	INJECTABLE COMPOSITIONS OF TRITERPENOID ANTIFUNGALS ENCAPSULATED IN LIPOSOMES
A61K 31/44 (2006.01)	3732164	USE OF 1-PHENYL-2-PYRIDINYL ALKYL ALCOHOL DERIVATIVES FOR TREATING CYSTIC FIBROSIS
A61P 11/00 (2006.01)	3732164	USE OF 1-PHENYL-2-PYRIDINYL ALKYL ALCOHOL DERIVATIVES FOR TREATING CYSTIC FIBROSIS
A61P 37/00 (2006.01)	3732164	USE OF 1-PHENYL-2-PYRIDINYL ALKYL ALCOHOL DERIVATIVES FOR TREATING CYSTIC FIBROSIS
C07D 213/61 (2006.01)	3732164	USE OF 1-PHENYL-2-PYRIDINYL ALKYL ALCOHOL DERIVATIVES FOR TREATING CYSTIC FIBROSIS
C07D 213/89 (2006.01)	3732164	USE OF 1-PHENYL-2-PYRIDINYL ALKYL ALCOHOL DERIVATIVES FOR TREATING CYSTIC FIBROSIS
A61K 31/55 (2006.01)	3724192	TRIAZOLOBENZAZEPINES AS VASOPRESSIN V1A RECEPTOR ANTAGONISTS
A61P 25/00 (2006.01)	3724192	TRIAZOLOBENZAZEPINES AS VASOPRESSIN V1A RECEPTOR ANTAGONISTS
A61P 25/24 (2006.01)	3724192	TRIAZOLOBENZAZEPINES AS VASOPRESSIN V1A RECEPTOR ANTAGONISTS
C07D 223/06 (2006.01)	3724192	TRIAZOLOBENZAZEPINES AS VASOPRESSIN V1A RECEPTOR ANTAGONISTS
C07D 223/10 (2006.01)	3724192	TRIAZOLOBENZAZEPINES AS VASOPRESSIN V1A RECEPTOR ANTAGONISTS
C07D 487/04 (2006.01)	3724192	TRIAZOLOBENZAZEPINES AS VASOPRESSIN V1A RECEPTOR ANTAGONISTS
C07D 487/14 (2006.01)	3724192	TRIAZOLOBENZAZEPINES AS VASOPRESSIN V1A RECEPTOR ANTAGONISTS
A61K 31/519 (2006.01)	3724190	SUBSTITUTED BICYCLIC HETEROCYCLIC COMPOUNDS AS PRMT5 INHIBITORS
A61K 31/53 (2006.01)	3724190	SUBSTITUTED BICYCLIC HETEROCYCLIC COMPOUNDS AS PRMT5 INHIBITORS
A61P 35/00 (2006.01)	3724190	SUBSTITUTED BICYCLIC HETEROCYCLIC COMPOUNDS AS PRMT5 INHIBITORS
C07D 471/04 (2006.01)	3724190	SUBSTITUTED BICYCLIC HETEROCYCLIC COMPOUNDS AS PRMT5 INHIBITORS
C07D 487/04 (2006.01)	3724190	SUBSTITUTED BICYCLIC HETEROCYCLIC COMPOUNDS AS PRMT5 INHIBITORS
A61K 31/501 (2006.01)	3713930	SULFONE PYRIDINE ALKYL AMIDE-SUBSTITUTED HETEROARYL COMPOUNDS
A61P 29/00 (2006.01)	3713930	SULFONE PYRIDINE ALKYL AMIDE-SUBSTITUTED HETEROARYL COMPOUNDS
A61P 37/00 (2006.01)	3713930	SULFONE PYRIDINE ALKYL AMIDE-SUBSTITUTED HETEROARYL COMPOUNDS
C07D 401/12 (2006.01)	3713930	SULFONE PYRIDINE ALKYL AMIDE-SUBSTITUTED HETEROARYL COMPOUNDS
C07D 401/14 (2006.01)	3713930	SULFONE PYRIDINE ALKYL AMIDE-SUBSTITUTED HETEROARYL COMPOUNDS
C07D 487/04 (2006.01)	3713930	SULFONE PYRIDINE ALKYL AMIDE-SUBSTITUTED HETEROARYL COMPOUNDS
A63H 33/00 (2006.01)	3720582	KIT COMPRISING A MOULD FOR KIDS AND A POWDER WATER-SENSITIVE MIXTURE FOR MAKING A BIJOU THROUGH SAID MOULD
C08K 3/26 (2006.01)	3720582	KIT COMPRISING A MOULD FOR KIDS AND A POWDER WATER-SENSITIVE MIXTURE FOR MAKING A BIJOU THROUGH SAID MOULD
C07K 16/28 (2006.01)	3728318	ANTIBODIES FOR LILRB2
C12Q 1/6851 (2018.01)	3728318	ANTIBODIES FOR LILRB2
A61K 31/519 (2006.01)	3727392	BIOMARKERS OF METHOTREXATE-INDUCED IMMUNE TOLERANCE
A61K 31/52 (2006.01)	3727392	BIOMARKERS OF METHOTREXATE-INDUCED IMMUNE TOLERANCE

MKP (51)	Broj objave evropske prijava patenta (97)	Naziv pronalaska (54)
A61K 31/5377 (2006.01)	3727392	BIOMARKERS OF METHOTREXATE-INDUCED IMMUNE TOLERANCE
A61K 31/675 (2006.01)	3727392	BIOMARKERS OF METHOTREXATE-INDUCED IMMUNE TOLERANCE
A61K 38/05 (2006.01)	3727392	BIOMARKERS OF METHOTREXATE-INDUCED IMMUNE TOLERANCE
A61K 38/13 (2006.01)	3727392	BIOMARKERS OF METHOTREXATE-INDUCED IMMUNE TOLERANCE
A61K 38/47 (2006.01)	3727392	BIOMARKERS OF METHOTREXATE-INDUCED IMMUNE TOLERANCE
A61K 39/395 (2006.01)	3727392	BIOMARKERS OF METHOTREXATE-INDUCED IMMUNE TOLERANCE
A61P 3/00 (2006.01)	3727392	BIOMARKERS OF METHOTREXATE-INDUCED IMMUNE TOLERANCE
A61P 21/00 (2006.01)	3727392	BIOMARKERS OF METHOTREXATE-INDUCED IMMUNE TOLERANCE
G01N 33/50 (2006.01)	3729085	QUANTITATIVE CELLULAR METHOD FOR DETERMINING THE BIOLOGICAL ACTIVITY OF AN ANTI-CD26 LIGAND
G01N 33/68 (2006.01)	3729085	QUANTITATIVE CELLULAR METHOD FOR DETERMINING THE BIOLOGICAL ACTIVITY OF AN ANTI-CD26 LIGAND
C12N 9/10 (2006.01)	3724337	RNAI CONSTRUCTS FOR INHIBITING PNPLA3 EXPRESSION
C12N 9/18 (2006.01)	3724337	RNAI CONSTRUCTS FOR INHIBITING PNPLA3 EXPRESSION
C12N 15/113 (2010.01)	3724337	RNAI CONSTRUCTS FOR INHIBITING PNPLA3 EXPRESSION
A61K 31/5513 (2006.01)	3732178	BENZODIAZEPINE DERIVATIVES
A61K 47/68 (2017.01)	3732178	BENZODIAZEPINE DERIVATIVES
A61P 35/00 (2006.01)	3732178	BENZODIAZEPINE DERIVATIVES
C07D 471/04 (2006.01)	3732178	BENZODIAZEPINE DERIVATIVES
C07D 487/04 (2006.01)	3732178	BENZODIAZEPINE DERIVATIVES
A61P 35/00 (2006.01)	3732200	BISPECIFIC ANTIBODY CONSTRUCT DIRECTED TO MUC17 AND CD3
C07K 16/28 (2006.01)	3732200	BISPECIFIC ANTIBODY CONSTRUCT DIRECTED TO MUC17 AND CD3
C07K 16/30 (2006.01)	3732200	BISPECIFIC ANTIBODY CONSTRUCT DIRECTED TO MUC17 AND CD3
C07K 16/46 (2006.01)	3732200	BISPECIFIC ANTIBODY CONSTRUCT DIRECTED TO MUC17 AND CD3
A61K 39/29 (2006.01)	3727445	HEPATITIS B VIRUS (HBV) VACCINES AND USES THEREOF
A61K 39/295 (2006.01)	3727445	HEPATITIS B VIRUS (HBV) VACCINES AND USES THEREOF
A61P 31/20 (2006.01)	3727445	HEPATITIS B VIRUS (HBV) VACCINES AND USES THEREOF
G06F 21/62 (2013.01)	3735648	METHOD AND SYSTEM FOR DATA SECURITY, VALIDATION, VERIFICATION AND PROVENANCE WITHIN INDEPENDENT COMPUTER SYSTEMS AND DIGITAL NETWORKS
A61K 39/29 (2006.01)	3727446	METHODS AND COMPOSITIONS FOR INDUCING AN IMMUNE RESPONSE AGAINST HEPATITIS B VIRUS (HBV)
C07K 14/02 (2006.01)	3727446	METHODS AND COMPOSITIONS FOR INDUCING AN IMMUNE RESPONSE AGAINST HEPATITIS B VIRUS (HBV)
C12N 7/00 (2006.01)	3727446	METHODS AND COMPOSITIONS FOR INDUCING AN IMMUNE RESPONSE AGAINST HEPATITIS B VIRUS (HBV)
B63B 35/34 (2006.01)	3713837	ARRAY OF PONTOONS FOR SOLAR PANEL AND CONNECTION MODULES THEREFOR
A61K 31/56 (2006.01)	3728284	COMPOSITIONS AND METHODS FOR TREATING CNS DISORDERS
A61K 31/57 (2006.01)	3728284	COMPOSITIONS AND METHODS FOR TREATING CNS DISORDERS
A61K 31/575 (2006.01)	3728284	COMPOSITIONS AND METHODS FOR TREATING CNS DISORDERS
A61K 31/58 (2006.01)	3728284	COMPOSITIONS AND METHODS FOR TREATING CNS DISORDERS
A61P 25/00 (2006.01)	3728284	COMPOSITIONS AND METHODS FOR TREATING CNS DISORDERS
C07J 1/00 (2006.01)	3728284	COMPOSITIONS AND METHODS FOR TREATING CNS DISORDERS
C07J 3/00 (2006.01)	3728284	COMPOSITIONS AND METHODS FOR TREATING CNS DISORDERS
C07J 5/00 (2006.01)	3728284	COMPOSITIONS AND METHODS FOR TREATING CNS DISORDERS
C07J 7/00 (2006.01)	3728284	COMPOSITIONS AND METHODS FOR TREATING CNS DISORDERS
C07J 9/00 (2006.01)	3728284	COMPOSITIONS AND METHODS FOR TREATING CNS DISORDERS
C07J 13/00 (2006.01)	3728284	COMPOSITIONS AND METHODS FOR TREATING CNS DISORDERS
C07J 17/00 (2006.01)	3728284	COMPOSITIONS AND METHODS FOR TREATING CNS DISORDERS
C07J 21/00 (2006.01)	3728284	COMPOSITIONS AND METHODS FOR TREATING CNS DISORDERS
C07J 41/00 (2006.01)	3728284	COMPOSITIONS AND METHODS FOR TREATING CNS DISORDERS
C07J 43/00 (2006.01)	3728284	COMPOSITIONS AND METHODS FOR TREATING CNS DISORDERS
C07J 51/00 (2006.01)	3728284	COMPOSITIONS AND METHODS FOR TREATING CNS DISORDERS
C07J 71/00 (2006.01)	3728284	COMPOSITIONS AND METHODS FOR TREATING CNS DISORDERS
A61K 31/57 (2006.01)	3728285	COMPOSITIONS AND METHODS FOR TREATING CNS DISORDERS
A61P 25/00 (2006.01)	3728285	COMPOSITIONS AND METHODS FOR TREATING CNS DISORDERS
C07J 61/00 (2006.01)	3728285	COMPOSITIONS AND METHODS FOR TREATING CNS DISORDERS

MKP (51)	Broj objave evropske prijava patenta (97)	Naziv pronalaska (54)
C07J 63/00 (2006.01)	3728285	COMPOSITIONS AND METHODS FOR TREATING CNS DISORDERS
A61K 31/4184 (2006.01)	3731866	METHODS OF TREATING CANCER
A61K 31/454 (2006.01)	3731866	METHODS OF TREATING CANCER
A61K 31/496 (2006.01)	3731866	METHODS OF TREATING CANCER
A61K 31/502 (2006.01)	3731866	METHODS OF TREATING CANCER
A61K 31/5025 (2006.01)	3731866	METHODS OF TREATING CANCER
A61K 31/517 (2006.01)	3731866	METHODS OF TREATING CANCER
A61K 31/55 (2006.01)	3731866	METHODS OF TREATING CANCER
A61K 31/555 (2006.01)	3731866	METHODS OF TREATING CANCER
A61K 39/395 (2006.01)	3731866	METHODS OF TREATING CANCER
A61K 45/06 (2006.01)	3731866	METHODS OF TREATING CANCER
A61P 35/00 (2006.01)	3731866	METHODS OF TREATING CANCER
A61K 31/4192 (2006.01)	3732167	GLYCOLATE OXIDASE INHIBITORS FOR THE TREATMENT OF DISEASE
A61P 13/00 (2006.01)	3732167	GLYCOLATE OXIDASE INHIBITORS FOR THE TREATMENT OF DISEASE
C07D 249/06 (2006.01)	3732167	GLYCOLATE OXIDASE INHIBITORS FOR THE TREATMENT OF DISEASE
C07D 401/04 (2006.01)	3732167	GLYCOLATE OXIDASE INHIBITORS FOR THE TREATMENT OF DISEASE
C07D 401/06 (2006.01)	3732167	GLYCOLATE OXIDASE INHIBITORS FOR THE TREATMENT OF DISEASE
C07D 401/12 (2006.01)	3732167	GLYCOLATE OXIDASE INHIBITORS FOR THE TREATMENT OF DISEASE
C07D 403/06 (2006.01)	3732167	GLYCOLATE OXIDASE INHIBITORS FOR THE TREATMENT OF DISEASE
C07D 403/12 (2006.01)	3732167	GLYCOLATE OXIDASE INHIBITORS FOR THE TREATMENT OF DISEASE
C07D 417/04 (2006.01)	3732167	GLYCOLATE OXIDASE INHIBITORS FOR THE TREATMENT OF DISEASE
C07D 417/12 (2006.01)	3732167	GLYCOLATE OXIDASE INHIBITORS FOR THE TREATMENT OF DISEASE
F41A 21/30 (2006.01)	3735566	SILENCER SYSTEM FOR A FIREARM
F41A 21/32 (2006.01)	3735566	SILENCER SYSTEM FOR A FIREARM
F41A 21/36 (2006.01)	3735566	SILENCER SYSTEM FOR A FIREARM
B65D 75/58 (2006.01)	3737620	SEALED SINGLE-DOSE BREAK-OPEN PACKAGE AND RELATIVE PRODUCTION METHOD
C07K 14/16 (2006.01)	3746569	METHODS AND REAGENTS FOR ASSESSING THE PRESENCE OR ABSENCE OF REPLICATION COMPETENT VIRUS
C12Q 1/6851 (2018.01)	3746569	METHODS AND REAGENTS FOR ASSESSING THE PRESENCE OR ABSENCE OF REPLICATION COMPETENT VIRUS
A61K 31/337 (2006.01)	3752153	OSIMERTINIB FOR USE IN THE TREATMENT OF NON-SMALL CELL LUNG CANCER
A61K 31/475 (2006.01)	3752153	OSIMERTINIB FOR USE IN THE TREATMENT OF NON-SMALL CELL LUNG CANCER
A61K 31/506 (2006.01)	3752153	OSIMERTINIB FOR USE IN THE TREATMENT OF NON-SMALL CELL LUNG CANCER
A61K 31/519 (2006.01)	3752153	OSIMERTINIB FOR USE IN THE TREATMENT OF NON-SMALL CELL LUNG CANCER
A61K 31/555 (2006.01)	3752153	OSIMERTINIB FOR USE IN THE TREATMENT OF NON-SMALL CELL LUNG CANCER
A61K 31/7048 (2006.01)	3752153	OSIMERTINIB FOR USE IN THE TREATMENT OF NON-SMALL CELL LUNG CANCER
A61K 31/7068 (2006.01)	3752153	OSIMERTINIB FOR USE IN THE TREATMENT OF NON-SMALL CELL LUNG CANCER
A61K 33/24 (2019.01)	3752153	OSIMERTINIB FOR USE IN THE TREATMENT OF NON-SMALL CELL LUNG CANCER
A61P 35/00 (2006.01)	3752153	OSIMERTINIB FOR USE IN THE TREATMENT OF NON-SMALL CELL LUNG CANCER
A61K 35/17 (2015.01)	3740216	METHODS OF ASSESSING TRANSDUCTION POTENCY OF VIRAL VECTORS
A61P 35/00 (2006.01)	3740216	METHODS OF ASSESSING TRANSDUCTION POTENCY OF VIRAL VECTORS
C12N 5/10 (2006.01)	3740216	METHODS OF ASSESSING TRANSDUCTION POTENCY OF VIRAL VECTORS
C12N 15/867 (2006.01)	3740216	METHODS OF ASSESSING TRANSDUCTION POTENCY OF VIRAL VECTORS
A61K 31/439 (2006.01)	3749667	COMPOUNDS FOR THE TREATMENT OF PAIN
A61P 25/04 (2006.01)	3749667	COMPOUNDS FOR THE TREATMENT OF PAIN
A61P 29/00 (2006.01)	3749667	COMPOUNDS FOR THE TREATMENT OF PAIN

MKP (51)	Broj objave evropske prijava patenta (97)	Naziv pronalaska (54)
C07D 453/02 (2006.01)	3749667	COMPOUNDS FOR THE TREATMENT OF PAIN
A61K 31/404 (2006.01)	3749301	PHARMACEUTICAL COMPOSITIONS FOR TREATING CYSTIC FIBROSIS
A61K 31/443 (2006.01)	3749301	PHARMACEUTICAL COMPOSITIONS FOR TREATING CYSTIC FIBROSIS
A61K 31/4439 (2006.01)	3749301	PHARMACEUTICAL COMPOSITIONS FOR TREATING CYSTIC FIBROSIS
A61K 31/47 (2006.01)	3749301	PHARMACEUTICAL COMPOSITIONS FOR TREATING CYSTIC FIBROSIS
A61P 11/00 (2006.01)	3749301	PHARMACEUTICAL COMPOSITIONS FOR TREATING CYSTIC FIBROSIS
A61K 31/454 (2006.01)	3749352	PEDIATRIC NIRAPARIB FORMULATIONS AND PEDIATRIC TREATMENT METHODS
A61K 39/00 (2006.01)	3749352	PEDIATRIC NIRAPARIB FORMULATIONS AND PEDIATRIC TREATMENT METHODS
A61K 39/395 (2006.01)	3749352	PEDIATRIC NIRAPARIB FORMULATIONS AND PEDIATRIC TREATMENT METHODS
A61K 45/06 (2006.01)	3749352	PEDIATRIC NIRAPARIB FORMULATIONS AND PEDIATRIC TREATMENT METHODS
A61P 35/00 (2006.01)	3749352	PEDIATRIC NIRAPARIB FORMULATIONS AND PEDIATRIC TREATMENT METHODS
A61K 31/4168 (2006.01)	3752148	PHARMACEUTICAL COMPOSITIONS COMPRISING TEIXOBACTIN
A61K 31/685 (2006.01)	3752148	PHARMACEUTICAL COMPOSITIONS COMPRISING TEIXOBACTIN
A61P 31/04 (2006.01)	3752148	PHARMACEUTICAL COMPOSITIONS COMPRISING TEIXOBACTIN
A61P 31/06 (2006.01)	3752148	PHARMACEUTICAL COMPOSITIONS COMPRISING TEIXOBACTIN
A61K 31/496 (2006.01)	3755688	INDOLE AND BENZIMIDAZOLE DERIVATIVES AS DUAL 5-HT2A AND 5-HT6 RECEPTOR ANTAGONISTS
A61P 25/00 (2006.01)	3755688	INDOLE AND BENZIMIDAZOLE DERIVATIVES AS DUAL 5-HT2A AND 5-HT6 RECEPTOR ANTAGONISTS
A61P 25/16 (2006.01)	3755688	INDOLE AND BENZIMIDAZOLE DERIVATIVES AS DUAL 5-HT2A AND 5-HT6 RECEPTOR ANTAGONISTS
A61P 25/18 (2006.01)	3755688	INDOLE AND BENZIMIDAZOLE DERIVATIVES AS DUAL 5-HT2A AND 5-HT6 RECEPTOR ANTAGONISTS
A61P 25/24 (2006.01)	3755688	INDOLE AND BENZIMIDAZOLE DERIVATIVES AS DUAL 5-HT2A AND 5-HT6 RECEPTOR ANTAGONISTS
A61P 25/28 (2006.01)	3755688	INDOLE AND BENZIMIDAZOLE DERIVATIVES AS DUAL 5-HT2A AND 5-HT6 RECEPTOR ANTAGONISTS
C07D 209/10 (2006.01)	3755688	INDOLE AND BENZIMIDAZOLE DERIVATIVES AS DUAL 5-HT2A AND 5-HT6 RECEPTOR ANTAGONISTS
C07D 235/10 (2006.01)	3755688	INDOLE AND BENZIMIDAZOLE DERIVATIVES AS DUAL 5-HT2A AND 5-HT6 RECEPTOR ANTAGONISTS
A61K 39/085 (2006.01)	3752183	IMMUNOGENIC COMPOSITION COMPRISING STAPHYLOCOCCAL ANTIGENS
A61P 31/04 (2006.01)	3752183	IMMUNOGENIC COMPOSITION COMPRISING STAPHYLOCOCCAL ANTIGENS
H02H 9/00 (2006.01)	3756253	DISCHARGING DEVICE, ELECTRICAL UNIT AND DISCHARGING METHOD
H02K 1/27 (2006.01)	3759800	ELECTRIC MOTOR
H02K 7/14 (2006.01)	3759800	ELECTRIC MOTOR
H02K 21/22 (2006.01)	3759800	ELECTRIC MOTOR
A61K 48/00 (2006.01)	3737762	COMPOSITIONS AND METHODS FOR GENE EDITING BY TARGETING TRANSFERRIN
C12N 15/113 (2010.01)	3737762	COMPOSITIONS AND METHODS FOR GENE EDITING BY TARGETING TRANSFERRIN
C12N 15/90 (2006.01)	3737762	COMPOSITIONS AND METHODS FOR GENE EDITING BY TARGETING TRANSFERRIN
C07D 241/44 (2006.01)	3740483	QUINOXALINONE COMPOUNDS, COMPOSITIONS, METHODS, AND KITS FOR INCREASING GENOME EDITING EFFICIENCY
C07D 403/12 (2006.01)	3740483	QUINOXALINONE COMPOUNDS, COMPOSITIONS, METHODS, AND KITS FOR INCREASING GENOME EDITING EFFICIENCY
C07D 405/14 (2006.01)	3740483	QUINOXALINONE COMPOUNDS, COMPOSITIONS, METHODS, AND KITS FOR INCREASING GENOME EDITING EFFICIENCY
C07D 491/048 (2006.01)	3740483	QUINOXALINONE COMPOUNDS, COMPOSITIONS, METHODS, AND KITS FOR INCREASING GENOME EDITING EFFICIENCY
C07D 498/08 (2006.01)	3740483	QUINOXALINONE COMPOUNDS, COMPOSITIONS, METHODS, AND KITS FOR INCREASING GENOME EDITING EFFICIENCY
C12N 15/00 (2006.01)	3740483	QUINOXALINONE COMPOUNDS, COMPOSITIONS, METHODS, AND KITS FOR INCREASING GENOME EDITING EFFICIENCY

MKP (51)	Broj objave evropske prijava patenta (97)	Naziv pronalaska (54)
C07D 213/75 (2006.01)	3752488	METHOD FOR PREPARING TERT-BUTYL N-((1R,2S,5S)-2-((2-((5-CHLOROPYRIDIN-2-YL)AMINO)-2-OXOACETYL)AMINO)-5-(DIMETHYLCARBAMOYL)CYCLOHEXYL)CARBAMATE
C07D 513/04 (2006.01)	3752488	METHOD FOR PREPARING TERT-BUTYL N-((1R,2S,5S)-2-((2-((5-CHLOROPYRIDIN-2-YL)AMINO)-2-OXOACETYL)AMINO)-5-(DIMETHYLCARBAMOYL)CYCLOHEXYL)CARBAMATE
A61K 35/12 (2015.01)	3749752	PANCREATIC CELLS FOR TREATING DIABETES AND METHODS OF GENERATING THE SAME
C12N 5/071 (2010.01)	3749752	PANCREATIC CELLS FOR TREATING DIABETES AND METHODS OF GENERATING THE SAME
C12N 5/074 (2010.01)	3749752	PANCREATIC CELLS FOR TREATING DIABETES AND METHODS OF GENERATING THE SAME
G01N 33/50 (2006.01)	3749752	PANCREATIC CELLS FOR TREATING DIABETES AND METHODS OF GENERATING THE SAME
A61K 39/00 (2006.01)	3743159	METHODS OF TREATING CANCERS WITH ANTAGONISTIC ANTI-PD-1 ANTIBODIES
A61P 35/00 (2006.01)	3743159	METHODS OF TREATING CANCERS WITH ANTAGONISTIC ANTI-PD-1 ANTIBODIES
C07K 16/28 (2006.01)	3743159	METHODS OF TREATING CANCERS WITH ANTAGONISTIC ANTI-PD-1 ANTIBODIES
G01N 33/68 (2006.01)	3743728	METHODS OF TREATING SPINAL MUSCULAR ATROPHY
C12N 5/0783 (2010.01)	3749753	METHODS FOR MANUFACTURING T CELLS
H04N 19/107 (2014.01)	3753253	IMAGE RESHAPING IN VIDEO CODING USING RATE DISTORTION OPTIMIZATION
H04N 19/117 (2014.01)	3753253	IMAGE RESHAPING IN VIDEO CODING USING RATE DISTORTION OPTIMIZATION
H04N 19/147 (2014.01)	3753253	IMAGE RESHAPING IN VIDEO CODING USING RATE DISTORTION OPTIMIZATION
H04N 19/159 (2014.01)	3753253	IMAGE RESHAPING IN VIDEO CODING USING RATE DISTORTION OPTIMIZATION
H04N 19/176 (2014.01)	3753253	IMAGE RESHAPING IN VIDEO CODING USING RATE DISTORTION OPTIMIZATION
H04N 19/46 (2014.01)	3753253	IMAGE RESHAPING IN VIDEO CODING USING RATE DISTORTION OPTIMIZATION
H04N 19/503 (2014.01)	3753253	IMAGE RESHAPING IN VIDEO CODING USING RATE DISTORTION OPTIMIZATION
H04N 19/82 (2014.01)	3753253	IMAGE RESHAPING IN VIDEO CODING USING RATE DISTORTION OPTIMIZATION
H04N 19/85 (2014.01)	3753253	IMAGE RESHAPING IN VIDEO CODING USING RATE DISTORTION OPTIMIZATION
A61K 31/437 (2006.01)	3752510	MACROCYCLES AS MODULATORS OF CYSTIC FIBROSIS TRANSMEMBRANE CONDUCTANCE REGULATOR, PHARMACEUTICAL COMPOSITIONS THEREOF, THEIR USE IN THE TREATMENT OF CYCSTIC FIBROSIS, AND PROCESS FOR MAKING THEM
A61P 11/00 (2006.01)	3752510	MACROCYCLES AS MODULATORS OF CYSTIC FIBROSIS TRANSMEMBRANE CONDUCTANCE REGULATOR, PHARMACEUTICAL COMPOSITIONS THEREOF, THEIR USE IN THE TREATMENT OF CYCSTIC FIBROSIS, AND PROCESS FOR MAKING THEM
C07D 513/22 (2006.01)	3752510	MACROCYCLES AS MODULATORS OF CYSTIC FIBROSIS TRANSMEMBRANE CONDUCTANCE REGULATOR, PHARMACEUTICAL COMPOSITIONS THEREOF, THEIR USE IN THE TREATMENT OF CYCSTIC FIBROSIS, AND PROCESS FOR MAKING THEM
C07D 515/22 (2006.01)	3752510	MACROCYCLES AS MODULATORS OF CYSTIC FIBROSIS TRANSMEMBRANE CONDUCTANCE REGULATOR, PHARMACEUTICAL COMPOSITIONS THEREOF, THEIR USE IN THE TREATMENT OF CYCSTIC FIBROSIS, AND PROCESS FOR MAKING THEM
A61K 31/4155 (2006.01)	3752146	JAK1 PATHWAY INHIBITORS FOR THE TREATMENT OF CYTOKINE-RELATED DISORDERS
A61K 31/437 (2006.01)	3752146	JAK1 PATHWAY INHIBITORS FOR THE TREATMENT OF CYTOKINE-RELATED DISORDERS
A61K 31/519 (2006.01)	3752146	JAK1 PATHWAY INHIBITORS FOR THE TREATMENT OF CYTOKINE-RELATED DISORDERS
A61P 37/00 (2006.01)	3752146	JAK1 PATHWAY INHIBITORS FOR THE TREATMENT OF CYTOKINE-RELATED DISORDERS

MKP (51)	Broj objave evropske prijava patenta (97)	Naziv pronalaska (54)
A61K 31/496 (2006.01)	3752189	SELECTIVE BCL-2 INHIBITORS IN COMBINATION WITH AN ANTI-PD-1 OR AN ANTI-PD-L1 ANTIBODY FOR THE TREATMENT OF CANCERS
A61K 39/395 (2006.01)	3752189	SELECTIVE BCL-2 INHIBITORS IN COMBINATION WITH AN ANTI-PD-1 OR AN ANTI-PD-L1 ANTIBODY FOR THE TREATMENT OF CANCERS
A61P 35/00 (2006.01)	3752189	SELECTIVE BCL-2 INHIBITORS IN COMBINATION WITH AN ANTI-PD-1 OR AN ANTI-PD-L1 ANTIBODY FOR THE TREATMENT OF CANCERS
A61K 31/4192 (2006.01)	3755324	METHODS OF USE FOR TRISUBSTITUTED BENZOTRIAZOLE DERIVATIVES
H01L 35/28 (2006.01)	3750194	ACTIVE MATERIAL AND ELECTRIC POWER GENERATOR CONTAINING IT
H01L 35/34 (2006.01)	3750194	ACTIVE MATERIAL AND ELECTRIC POWER GENERATOR CONTAINING IT
H01L 37/02 (2006.01)	3750194	ACTIVE MATERIAL AND ELECTRIC POWER GENERATOR CONTAINING IT
H01M 10/36 (2010.01)	3750208	A SEMI-SOLID BATTERY WITH RECHARGING CAPABILITY
C12Q 1/6883 (2018.01)	3728638	DIAGNOSTIC AND THERAPEUTIC METHODS FOR THE TREATMENT OF RHEUMATOID ARTHRITIS (RA)
A61K 39/00 (2006.01)	3746117	COMBINATION THERAPY USING ADOPTIVE CELL THERAPY AND CHECKPOINT INHIBITOR
A61K 39/395 (2006.01)	3746117	COMBINATION THERAPY USING ADOPTIVE CELL THERAPY AND CHECKPOINT INHIBITOR
A61P 35/02 (2006.01)	3746117	COMBINATION THERAPY USING ADOPTIVE CELL THERAPY AND CHECKPOINT INHIBITOR
C07K 16/28 (2006.01)	3746117	COMBINATION THERAPY USING ADOPTIVE CELL THERAPY AND CHECKPOINT INHIBITOR
C07K 16/30 (2006.01)	3746117	COMBINATION THERAPY USING ADOPTIVE CELL THERAPY AND CHECKPOINT INHIBITOR
A61K 9/00 (2006.01)	3749363	LOW PH PHARMACEUTICAL ANTIBODY FORMULATION
A61K 39/395 (2006.01)	3749363	LOW PH PHARMACEUTICAL ANTIBODY FORMULATION
C07K 16/28 (2006.01)	3749363	LOW PH PHARMACEUTICAL ANTIBODY FORMULATION
C07K 16/40 (2006.01)	3749363	LOW PH PHARMACEUTICAL ANTIBODY FORMULATION
A61K 9/14 (2006.01)	3758754	A PHARMACEUTICAL FORMULATION FOR INTRADUODENAL ADMINISTRATION COMPRISING MELEVODOPA AND CARBIDOPA
A61K 9/19 (2006.01)	3758754	A PHARMACEUTICAL FORMULATION FOR INTRADUODENAL ADMINISTRATION COMPRISING MELEVODOPA AND CARBIDOPA
A61K 31/195 (2006.01)	3758754	A PHARMACEUTICAL FORMULATION FOR INTRADUODENAL ADMINISTRATION COMPRISING MELEVODOPA AND CARBIDOPA
A61K 31/198 (2006.01)	3758754	A PHARMACEUTICAL FORMULATION FOR INTRADUODENAL ADMINISTRATION COMPRISING MELEVODOPA AND CARBIDOPA
A61K 47/10 (2017.01)	3758754	A PHARMACEUTICAL FORMULATION FOR INTRADUODENAL ADMINISTRATION COMPRISING MELEVODOPA AND CARBIDOPA
A61K 47/12 (2006.01)	3758754	A PHARMACEUTICAL FORMULATION FOR INTRADUODENAL ADMINISTRATION COMPRISING MELEVODOPA AND CARBIDOPA
A61K 47/26 (2006.01)	3758754	A PHARMACEUTICAL FORMULATION FOR INTRADUODENAL ADMINISTRATION COMPRISING MELEVODOPA AND CARBIDOPA
A61K 47/32 (2006.01)	3758754	A PHARMACEUTICAL FORMULATION FOR INTRADUODENAL ADMINISTRATION COMPRISING MELEVODOPA AND CARBIDOPA
A61K 47/38 (2006.01)	3758754	A PHARMACEUTICAL FORMULATION FOR INTRADUODENAL ADMINISTRATION COMPRISING MELEVODOPA AND CARBIDOPA
B01D 29/35 (2006.01)	3752267	DEVICE AND METHOD FOR FILTERING A FLUID CIRCULATING IN A PLUMBING AND HEATING SYSTEM
B01D 29/90 (2006.01)	3752267	DEVICE AND METHOD FOR FILTERING A FLUID CIRCULATING IN A PLUMBING AND HEATING SYSTEM
B01D 29/92 (2006.01)	3752267	DEVICE AND METHOD FOR FILTERING A FLUID CIRCULATING IN A PLUMBING AND HEATING SYSTEM
B01D 35/06 (2006.01)	3752267	DEVICE AND METHOD FOR FILTERING A FLUID CIRCULATING IN A PLUMBING AND HEATING SYSTEM
C10B 3/00 (2006.01)	3749734	GASIFICATION PLANT
C10B 43/14 (2006.01)	3749734	GASIFICATION PLANT
C10B 49/00 (2006.01)	3749734	GASIFICATION PLANT
C10J 3/26 (2006.01)	3749734	GASIFICATION PLANT
C10J 3/42 (2006.01)	3749734	GASIFICATION PLANT
C10J 3/72 (2006.01)	3749734	GASIFICATION PLANT
A61K 8/49 (2006.01)	3752253	COMPOSITION FOR PREVENTION AND TREATMENT OF HAIR GROWTH DISORDERS
A61K 31/4155 (2006.01)	3752253	COMPOSITION FOR PREVENTION AND TREATMENT OF HAIR GROWTH DISORDERS

MKP (51)	Broj objave evropske prijava patenta (97)	Naziv pronalaska (54)
A61P 17/14 (2006.01)	3752253	COMPOSITION FOR PREVENTION AND TREATMENT OF HAIR GROWTH DISORDERS
A61Q 7/00 (2006.01)	3752253	COMPOSITION FOR PREVENTION AND TREATMENT OF HAIR GROWTH DISORDERS
C07D 277/54 (2006.01)	3752253	COMPOSITION FOR PREVENTION AND TREATMENT OF HAIR GROWTH DISORDERS
C07D 417/12 (2006.01)	3752253	COMPOSITION FOR PREVENTION AND TREATMENT OF HAIR GROWTH DISORDERS
A61L 2/00 (2006.01)	3755455	MODIFIED FILTER MEMBRANE AND METHOD
B01D 61/14 (2006.01)	3755455	MODIFIED FILTER MEMBRANE AND METHOD
B01D 61/16 (2006.01)	3755455	MODIFIED FILTER MEMBRANE AND METHOD
B01D 67/00 (2006.01)	3755455	MODIFIED FILTER MEMBRANE AND METHOD
B01D 69/02 (2006.01)	3755455	MODIFIED FILTER MEMBRANE AND METHOD
B01D 69/08 (2006.01)	3755455	MODIFIED FILTER MEMBRANE AND METHOD
B01D 71/10 (2006.01)	3755455	MODIFIED FILTER MEMBRANE AND METHOD
B01D 71/12 (2006.01)	3755455	MODIFIED FILTER MEMBRANE AND METHOD
B01D 71/16 (2006.01)	3755455	MODIFIED FILTER MEMBRANE AND METHOD
B01D 71/20 (2006.01)	3755455	MODIFIED FILTER MEMBRANE AND METHOD
C12N 7/02 (2006.01)	3755455	MODIFIED FILTER MEMBRANE AND METHOD
A61K 31/444 (2006.01)	3755703	N-(PHENYL)-2-(PHENYL)PYRIMIDINE-4-CARBOXAMIDE DERIVATIVES AND RELATED COMPOUNDS AS HPK1 INHIBITORS FOR TREATING CANCER
A61K 31/506 (2006.01)	3755703	N-(PHENYL)-2-(PHENYL)PYRIMIDINE-4-CARBOXAMIDE DERIVATIVES AND RELATED COMPOUNDS AS HPK1 INHIBITORS FOR TREATING CANCER
A61P 35/00 (2006.01)	3755703	N-(PHENYL)-2-(PHENYL)PYRIMIDINE-4-CARBOXAMIDE DERIVATIVES AND RELATED COMPOUNDS AS HPK1 INHIBITORS FOR TREATING CANCER
C07D 239/28 (2006.01)	3755703	N-(PHENYL)-2-(PHENYL)PYRIMIDINE-4-CARBOXAMIDE DERIVATIVES AND RELATED COMPOUNDS AS HPK1 INHIBITORS FOR TREATING CANCER
C07D 401/14 (2006.01)	3755703	N-(PHENYL)-2-(PHENYL)PYRIMIDINE-4-CARBOXAMIDE DERIVATIVES AND RELATED COMPOUNDS AS HPK1 INHIBITORS FOR TREATING CANCER
C07D 403/12 (2006.01)	3755703	N-(PHENYL)-2-(PHENYL)PYRIMIDINE-4-CARBOXAMIDE DERIVATIVES AND RELATED COMPOUNDS AS HPK1 INHIBITORS FOR TREATING CANCER
C07D 403/14 (2006.01)	3755703	N-(PHENYL)-2-(PHENYL)PYRIMIDINE-4-CARBOXAMIDE DERIVATIVES AND RELATED COMPOUNDS AS HPK1 INHIBITORS FOR TREATING CANCER
C07D 487/04 (2006.01)	3755703	N-(PHENYL)-2-(PHENYL)PYRIMIDINE-4-CARBOXAMIDE DERIVATIVES AND RELATED COMPOUNDS AS HPK1 INHIBITORS FOR TREATING CANCER
C07D 487/08 (2006.01)	3755703	N-(PHENYL)-2-(PHENYL)PYRIMIDINE-4-CARBOXAMIDE DERIVATIVES AND RELATED COMPOUNDS AS HPK1 INHIBITORS FOR TREATING CANCER
A61K 31/517 (2006.01)	3759083	2,4-DIAMINOQUINAZOLINE DERIVATIVES AND MEDICAL USES THEREOF
A61P 1/16 (2006.01)	3759083	2,4-DIAMINOQUINAZOLINE DERIVATIVES AND MEDICAL USES THEREOF
A61P 31/12 (2006.01)	3759083	2,4-DIAMINOQUINAZOLINE DERIVATIVES AND MEDICAL USES THEREOF
A61P 35/00 (2006.01)	3759083	2,4-DIAMINOQUINAZOLINE DERIVATIVES AND MEDICAL USES THEREOF
A61P 37/06 (2006.01)	3759083	2,4-DIAMINOQUINAZOLINE DERIVATIVES AND MEDICAL USES THEREOF
C07D 239/95 (2006.01)	3759083	2,4-DIAMINOQUINAZOLINE DERIVATIVES AND MEDICAL USES THEREOF
G10G 5/00 (2006.01)	3743910	DEVICE FOR SUPPORTING A SAXOPHONE
A61K 31/4375 (2006.01)	3743417	COMPOUNDS FOR THE TREATMENT OF KINASE-DEPENDENT DISORDERS
A61K 31/4427 (2006.01)	3743417	COMPOUNDS FOR THE TREATMENT OF KINASE-DEPENDENT DISORDERS
A61P 35/00 (2006.01)	3743417	COMPOUNDS FOR THE TREATMENT OF KINASE-DEPENDENT DISORDERS
C07D 401/12 (2006.01)	3743417	COMPOUNDS FOR THE TREATMENT OF KINASE-DEPENDENT DISORDERS
C07D 401/14 (2006.01)	3743417	COMPOUNDS FOR THE TREATMENT OF KINASE-DEPENDENT DISORDERS

MKP (51)	Broj objave evropske prijava patenta (97)	Naziv pronalaska (54)
C07D 413/14 (2006.01)	3743417	COMPOUNDS FOR THE TREATMENT OF KINASE-DEPENDENT DISORDERS
C07D 471/04 (2006.01)	3743417	COMPOUNDS FOR THE TREATMENT OF KINASE-DEPENDENT DISORDERS
C07D 491/147 (2006.01)	3743417	COMPOUNDS FOR THE TREATMENT OF KINASE-DEPENDENT DISORDERS
A61K 31/4985 (2006.01)	3755702	INHIBITORS OF BTK AND MUTANTS THEREOF
A61P 35/00 (2006.01)	3755702	INHIBITORS OF BTK AND MUTANTS THEREOF
A61P 37/00 (2006.01)	3755702	INHIBITORS OF BTK AND MUTANTS THEREOF
C07D 487/04 (2006.01)	3755702	INHIBITORS OF BTK AND MUTANTS THEREOF
A61M 5/315 (2006.01)	3755403	MEDICATION DELIVERY DEVICE WITH A SENSED ELEMENT
A61M 5/315 (2006.01)	3755404	DOSE DETECTION SYSTEM MODULE FOR MEDICATION DELIVERY DEVICE
B23Q 17/20 (2006.01)	3755499	METHOD AND APPARATUS FOR ADDITIVE MANUFACTURING
B23Q 17/22 (2006.01)	3755499	METHOD AND APPARATUS FOR ADDITIVE MANUFACTURING
B23Q 17/24 (2006.01)	3755499	METHOD AND APPARATUS FOR ADDITIVE MANUFACTURING
B29C 64/188 (2017.01)	3755499	METHOD AND APPARATUS FOR ADDITIVE MANUFACTURING
G06T 7/33 (2017.01)	3755499	METHOD AND APPARATUS FOR ADDITIVE MANUFACTURING
A61K 31/513 (2006.01)	3759096	CD73 INHIBITORS
A61P 35/00 (2006.01)	3759096	CD73 INHIBITORS
C07D 403/04 (2006.01)	3759096	CD73 INHIBITORS
A61K 39/00 (2006.01)	3759139	PD-1 AGONIST ANTIBODIES AND USES THEREOF
A61P 37/06 (2006.01)	3759139	PD-1 AGONIST ANTIBODIES AND USES THEREOF
C07K 16/28 (2006.01)	3759139	PD-1 AGONIST ANTIBODIES AND USES THEREOF
A61K 31/505 (2006.01)	3759098	PYRIDINE-SULFONAMIDE COMPOUNDS AND THEIR USE AGAINST PAIN AND RELATED CONDITIONS
A61K 31/506 (2006.01)	3759098	PYRIDINE-SULFONAMIDE COMPOUNDS AND THEIR USE AGAINST PAIN AND RELATED CONDITIONS
C07B 59/00 (2006.01)	3759098	PYRIDINE-SULFONAMIDE COMPOUNDS AND THEIR USE AGAINST PAIN AND RELATED CONDITIONS
C07D 239/69 (2006.01)	3759098	PYRIDINE-SULFONAMIDE COMPOUNDS AND THEIR USE AGAINST PAIN AND RELATED CONDITIONS
C07D 401/12 (2006.01)	3759098	PYRIDINE-SULFONAMIDE COMPOUNDS AND THEIR USE AGAINST PAIN AND RELATED CONDITIONS
C07D 401/14 (2006.01)	3759098	PYRIDINE-SULFONAMIDE COMPOUNDS AND THEIR USE AGAINST PAIN AND RELATED CONDITIONS
C07D 403/12 (2006.01)	3759098	PYRIDINE-SULFONAMIDE COMPOUNDS AND THEIR USE AGAINST PAIN AND RELATED CONDITIONS
C07D 413/12 (2006.01)	3759098	PYRIDINE-SULFONAMIDE COMPOUNDS AND THEIR USE AGAINST PAIN AND RELATED CONDITIONS
A61K 31/53 (2006.01)	3759088	TRIAZINE DERIVATIVES FOR TREATING DISEASES RELATING TO NEUROTROPHINS
A61P 25/00 (2006.01)	3759088	TRIAZINE DERIVATIVES FOR TREATING DISEASES RELATING TO NEUROTROPHINS
A61P 25/16 (2006.01)	3759088	TRIAZINE DERIVATIVES FOR TREATING DISEASES RELATING TO NEUROTROPHINS
A61P 25/24 (2006.01)	3759088	TRIAZINE DERIVATIVES FOR TREATING DISEASES RELATING TO NEUROTROPHINS
A61P 25/28 (2006.01)	3759088	TRIAZINE DERIVATIVES FOR TREATING DISEASES RELATING TO NEUROTROPHINS
C07D 251/34 (2006.01)	3759088	TRIAZINE DERIVATIVES FOR TREATING DISEASES RELATING TO NEUROTROPHINS
C07D 401/04 (2006.01)	3759088	TRIAZINE DERIVATIVES FOR TREATING DISEASES RELATING TO NEUROTROPHINS
C07D 403/04 (2006.01)	3759088	TRIAZINE DERIVATIVES FOR TREATING DISEASES RELATING TO NEUROTROPHINS
C07D 405/04 (2006.01)	3759088	TRIAZINE DERIVATIVES FOR TREATING DISEASES RELATING TO NEUROTROPHINS
C07D 409/04 (2006.01)	3759088	TRIAZINE DERIVATIVES FOR TREATING DISEASES RELATING TO NEUROTROPHINS
C07D 417/04 (2006.01)	3759088	TRIAZINE DERIVATIVES FOR TREATING DISEASES RELATING TO NEUROTROPHINS
A61K 31/198 (2006.01)	3752141	THERAPEUTIC AGENTS FOR TREATING RESTLESS LEGS SYNDROME
A61P 25/00 (2006.01)	3752141	THERAPEUTIC AGENTS FOR TREATING RESTLESS LEGS SYNDROME
A61K 31/69 (2006.01)	3752251	ARGINASE INHIBITORS AND METHODS OF USE THEREOF
A61P 29/00 (2006.01)	3752251	ARGINASE INHIBITORS AND METHODS OF USE THEREOF
A61P 35/00 (2006.01)	3752251	ARGINASE INHIBITORS AND METHODS OF USE THEREOF
C07F 5/02 (2006.01)	3752251	ARGINASE INHIBITORS AND METHODS OF USE THEREOF

MKP (51)	Broj objave evropske prijava patenta (97)	Naziv pronalaska (54)
A61K 35/17 (2015.01)	3752600	EXPANSION OF TUMOR INFILTRATING LYMPHOCYTES (TILS) WITH ADENOSINE A2A RECEPTOR ANTAGONISTS AND THERAPEUTIC COMBINATIONS OF TILS AND ADENOSINE A2A RECEPTOR ANTAGONISTS
A61K 39/00 (2006.01)	3752600	EXPANSION OF TUMOR INFILTRATING LYMPHOCYTES (TILS) WITH ADENOSINE A2A RECEPTOR ANTAGONISTS AND THERAPEUTIC COMBINATIONS OF TILS AND ADENOSINE A2A RECEPTOR ANTAGONISTS
A61P 35/00 (2006.01)	3752600	EXPANSION OF TUMOR INFILTRATING LYMPHOCYTES (TILS) WITH ADENOSINE A2A RECEPTOR ANTAGONISTS AND THERAPEUTIC COMBINATIONS OF TILS AND ADENOSINE A2A RECEPTOR ANTAGONISTS
C12N 5/0783 (2010.01)	3752600	EXPANSION OF TUMOR INFILTRATING LYMPHOCYTES (TILS) WITH ADENOSINE A2A RECEPTOR ANTAGONISTS AND THERAPEUTIC COMBINATIONS OF TILS AND ADENOSINE A2A RECEPTOR ANTAGONISTS
A61K 9/50 (2006.01)	3758722	MACRO-ENCAPSULATED THERAPEUTIC CELLS, DEVICES, AND METHODS OF USING THE SAME
A61K 35/00 (2006.01)	3758722	MACRO-ENCAPSULATED THERAPEUTIC CELLS, DEVICES, AND METHODS OF USING THE SAME
A61K 35/39 (2015.01)	3758722	MACRO-ENCAPSULATED THERAPEUTIC CELLS, DEVICES, AND METHODS OF USING THE SAME
A61L 27/38 (2006.01)	3758722	MACRO-ENCAPSULATED THERAPEUTIC CELLS, DEVICES, AND METHODS OF USING THE SAME
A61L 27/54 (2006.01)	3758722	MACRO-ENCAPSULATED THERAPEUTIC CELLS, DEVICES, AND METHODS OF USING THE SAME
A61P 5/48 (2006.01)	3758722	MACRO-ENCAPSULATED THERAPEUTIC CELLS, DEVICES, AND METHODS OF USING THE SAME
A61P 5/50 (2006.01)	3758722	MACRO-ENCAPSULATED THERAPEUTIC CELLS, DEVICES, AND METHODS OF USING THE SAME
A61K 31/416 (2006.01)	3755696	5-HETEROARYL SUBSTITUTED INDAZOLE-3-CARBOXAMIDES AND PREPARATION AND USE THEREOF
A61P 17/06 (2006.01)	3755696	5-HETEROARYL SUBSTITUTED INDAZOLE-3-CARBOXAMIDES AND PREPARATION AND USE THEREOF
A61P 19/04 (2006.01)	3755696	5-HETEROARYL SUBSTITUTED INDAZOLE-3-CARBOXAMIDES AND PREPARATION AND USE THEREOF
A61P 35/00 (2006.01)	3755696	5-HETEROARYL SUBSTITUTED INDAZOLE-3-CARBOXAMIDES AND PREPARATION AND USE THEREOF
C07D 401/14 (2006.01)	3755696	5-HETEROARYL SUBSTITUTED INDAZOLE-3-CARBOXAMIDES AND PREPARATION AND USE THEREOF
C07D 403/04 (2006.01)	3755696	5-HETEROARYL SUBSTITUTED INDAZOLE-3-CARBOXAMIDES AND PREPARATION AND USE THEREOF
C07D 403/14 (2006.01)	3755696	5-HETEROARYL SUBSTITUTED INDAZOLE-3-CARBOXAMIDES AND PREPARATION AND USE THEREOF
C07D 405/14 (2006.01)	3755696	5-HETEROARYL SUBSTITUTED INDAZOLE-3-CARBOXAMIDES AND PREPARATION AND USE THEREOF
C07D 487/04 (2006.01)	3755696	5-HETEROARYL SUBSTITUTED INDAZOLE-3-CARBOXAMIDES AND PREPARATION AND USE THEREOF
A61K 48/00 (2006.01)	3752616	COMPOSITIONS AND METHODS FOR GENE EDITING BY TARGETING FIBRINOGEN-ALPHA
C12N 15/113 (2010.01)	3752616	COMPOSITIONS AND METHODS FOR GENE EDITING BY TARGETING FIBRINOGEN-ALPHA
C12N 15/90 (2006.01)	3752616	COMPOSITIONS AND METHODS FOR GENE EDITING BY TARGETING FIBRINOGEN-ALPHA
F01K 7/16 (2006.01)	3737839	GEOHERMAL ENERGY DEVICE
F01K 11/02 (2006.01)	3737839	GEOHERMAL ENERGY DEVICE
F01K 19/08 (2006.01)	3737839	GEOHERMAL ENERGY DEVICE
F22B 1/16 (2006.01)	3737839	GEOHERMAL ENERGY DEVICE
F22B 3/04 (2006.01)	3737839	GEOHERMAL ENERGY DEVICE
A61K 31/712 (2006.01)	3749767	MATERIALS AND METHODS FOR TREATMENT OF HEMOGLOBINOPATHIES
A61K 31/7125 (2006.01)	3749767	MATERIALS AND METHODS FOR TREATMENT OF HEMOGLOBINOPATHIES
A61P 7/06 (2006.01)	3749767	MATERIALS AND METHODS FOR TREATMENT OF HEMOGLOBINOPATHIES
C12N 15/113 (2010.01)	3749767	MATERIALS AND METHODS FOR TREATMENT OF HEMOGLOBINOPATHIES
A61K 31/4985 (2006.01)	3759111	PHARMACEUTICAL COMPOUNDS
A61P 35/00 (2006.01)	3759111	PHARMACEUTICAL COMPOUNDS
C07D 487/04 (2006.01)	3759111	PHARMACEUTICAL COMPOUNDS

MKP (51)	Broj objave evropske prijava patenta (97)	Naziv pronalaska (54)
A61K 31/519 (2006.01)	3759112	IMIDAZOPYRIMIDINES AND TRIAZOLOPYRIMIDINES AS A2A / A2B INHIBITORS
A61P 9/00 (2006.01)	3759112	IMIDAZOPYRIMIDINES AND TRIAZOLOPYRIMIDINES AS A2A / A2B INHIBITORS
A61P 25/00 (2006.01)	3759112	IMIDAZOPYRIMIDINES AND TRIAZOLOPYRIMIDINES AS A2A / A2B INHIBITORS
A61P 29/00 (2006.01)	3759112	IMIDAZOPYRIMIDINES AND TRIAZOLOPYRIMIDINES AS A2A / A2B INHIBITORS
A61P 35/00 (2006.01)	3759112	IMIDAZOPYRIMIDINES AND TRIAZOLOPYRIMIDINES AS A2A / A2B INHIBITORS
C07D 487/04 (2006.01)	3759112	IMIDAZOPYRIMIDINES AND TRIAZOLOPYRIMIDINES AS A2A / A2B INHIBITORS
C07D 519/00 (2006.01)	3759112	IMIDAZOPYRIMIDINES AND TRIAZOLOPYRIMIDINES AS A2A / A2B INHIBITORS
G01N 15/00 (2006.01)	3759490	METHODS FOR DETECTING PARTICLES PRESENT IN A CELL COMPOSITION
G01N 33/543 (2006.01)	3759490	METHODS FOR DETECTING PARTICLES PRESENT IN A CELL COMPOSITION
E05B 5/00 (2006.01)	3728766	DOOR HANDLE ASSEMBLY WITH SAFETY FUNCTION
E05B 5/02 (2006.01)	3728766	DOOR HANDLE ASSEMBLY WITH SAFETY FUNCTION
E05B 47/00 (2006.01)	3728766	DOOR HANDLE ASSEMBLY WITH SAFETY FUNCTION
C07K 16/28 (2006.01)	3752532	IMPROVED ANTAGONISTIC ANTI-HUMAN CD40 MONOCLONAL ANTIBODIES
B01D 15/18 (2006.01)	3759467	MULTIVARIATE SPECTRAL ANALYSIS AND MONITORING OF BIOMANUFACTURING
G01N 21/35 (2014.01)	3759467	MULTIVARIATE SPECTRAL ANALYSIS AND MONITORING OF BIOMANUFACTURING
G01N 21/3577 (2014.01)	3759467	MULTIVARIATE SPECTRAL ANALYSIS AND MONITORING OF BIOMANUFACTURING
G01N 21/552 (2014.01)	3759467	MULTIVARIATE SPECTRAL ANALYSIS AND MONITORING OF BIOMANUFACTURING
G01N 21/84 (2006.01)	3759467	MULTIVARIATE SPECTRAL ANALYSIS AND MONITORING OF BIOMANUFACTURING
G01N 30/46 (2006.01)	3759467	MULTIVARIATE SPECTRAL ANALYSIS AND MONITORING OF BIOMANUFACTURING
G01N 30/78 (2006.01)	3759467	MULTIVARIATE SPECTRAL ANALYSIS AND MONITORING OF BIOMANUFACTURING
G01N 30/86 (2006.01)	3759467	MULTIVARIATE SPECTRAL ANALYSIS AND MONITORING OF BIOMANUFACTURING
G01N 30/88 (2006.01)	3759467	MULTIVARIATE SPECTRAL ANALYSIS AND MONITORING OF BIOMANUFACTURING
A61K 31/553 (2006.01)	3758708	PHARMACEUTICAL COMPOSITIONS COMPRISING (2S)-{(1S)-1-CYANO-2-[4-(3-METHYL-2-OXO-2,3-DIHYDRO-1,3-BENZOXAZOL-5-YL)PHENYL]ETHYL}-1,4-OXAZEPANE-2-CARBOXAMIDE
A61P 11/06 (2006.01)	3758708	PHARMACEUTICAL COMPOSITIONS COMPRISING (2S)-{(1S)-1-CYANO-2-[4-(3-METHYL-2-OXO-2,3-DIHYDRO-1,3-BENZOXAZOL-5-YL)PHENYL]ETHYL}-1,4-OXAZEPANE-2-CARBOXAMIDE
F16L 27/08 (2006.01)	3736479	EXPANSION-COMPENSATING ELEMENT
F16L 27/12 (2006.01)	3736479	EXPANSION-COMPENSATING ELEMENT
F16L 51/00 (2006.01)	3736479	EXPANSION-COMPENSATING ELEMENT
F16L 51/02 (2006.01)	3736479	EXPANSION-COMPENSATING ELEMENT
A61K 31/712 (2006.01)	3749768	MATERIALS AND METHODS FOR TREATMENT OF HEMOGLOBINOPATHIES
A61K 31/7125 (2006.01)	3749768	MATERIALS AND METHODS FOR TREATMENT OF HEMOGLOBINOPATHIES
A61P 7/06 (2006.01)	3749768	MATERIALS AND METHODS FOR TREATMENT OF HEMOGLOBINOPATHIES
C12N 15/113 (2010.01)	3749768	MATERIALS AND METHODS FOR TREATMENT OF HEMOGLOBINOPATHIES
A61P 31/16 (2006.01)	3743442	HUMAN ANTIBODIES TO INFLUENZA HEMAGGLUTININ
C07K 16/10 (2006.01)	3743442	HUMAN ANTIBODIES TO INFLUENZA HEMAGGLUTININ
E03C 1/042 (2006.01)	3735548	SEALING COLLAR FOR COMPOSITE SEALS
F16L 5/10 (2006.01)	3735548	SEALING COLLAR FOR COMPOSITE SEALS
A23L 33/135 (2016.01)	3743086	COMPOSITIONS COMPRISING BACTERIAL STRAINS
A61K 35/74 (2015.01)	3743086	COMPOSITIONS COMPRISING BACTERIAL STRAINS
A61K 39/02 (2006.01)	3743086	COMPOSITIONS COMPRISING BACTERIAL STRAINS
A61P 1/00 (2006.01)	3743086	COMPOSITIONS COMPRISING BACTERIAL STRAINS
A61P 3/10 (2006.01)	3743086	COMPOSITIONS COMPRISING BACTERIAL STRAINS
A61P 11/06 (2006.01)	3743086	COMPOSITIONS COMPRISING BACTERIAL STRAINS
A61P 17/06 (2006.01)	3743086	COMPOSITIONS COMPRISING BACTERIAL STRAINS

MKP (51)	Broj objave evropske prijava patenta (97)	Naziv pronalaska (54)
A61P 19/02 (2006.01)	3743086	COMPOSITIONS COMPRISING BACTERIAL STRAINS
A61P 35/00 (2006.01)	3743086	COMPOSITIONS COMPRISING BACTERIAL STRAINS
A61P 37/00 (2006.01)	3743086	COMPOSITIONS COMPRISING BACTERIAL STRAINS
A61P 43/00 (2006.01)	3743086	COMPOSITIONS COMPRISING BACTERIAL STRAINS
A61K 31/4704 (2006.01)	3720442	INHIBITING MUTANT IDH-1
A61K 31/4709 (2006.01)	3720442	INHIBITING MUTANT IDH-1
A61P 35/00 (2006.01)	3720442	INHIBITING MUTANT IDH-1
A61P 35/02 (2006.01)	3720442	INHIBITING MUTANT IDH-1
A61K 9/00 (2006.01)	3746047	INJECTABLE COMPOSITION
A61K 31/4196 (2006.01)	3746047	INJECTABLE COMPOSITION
A61K 47/34 (2017.01)	3746047	INJECTABLE COMPOSITION
A61K 31/351 (2006.01)	3737367	METHODS OF TREATING SOLID TUMORS WITH CCR2 ANTAGONISTS
A61K 31/40 (2006.01)	3737367	METHODS OF TREATING SOLID TUMORS WITH CCR2 ANTAGONISTS
A61K 31/4025 (2006.01)	3737367	METHODS OF TREATING SOLID TUMORS WITH CCR2 ANTAGONISTS
C07D 405/00 (2006.01)	3737367	METHODS OF TREATING SOLID TUMORS WITH CCR2 ANTAGONISTS
C07D 405/02 (2006.01)	3737367	METHODS OF TREATING SOLID TUMORS WITH CCR2 ANTAGONISTS
C07D 405/04 (2006.01)	3737367	METHODS OF TREATING SOLID TUMORS WITH CCR2 ANTAGONISTS
A61K 31/712 (2006.01)	3735252	HETERODUPLEX NUCLEIC ACID MOLECULES AND USES THEREOF
A61K 31/7125 (2006.01)	3735252	HETERODUPLEX NUCLEIC ACID MOLECULES AND USES THEREOF
A61K 31/713 (2006.01)	3735252	HETERODUPLEX NUCLEIC ACID MOLECULES AND USES THEREOF
C07H 21/02 (2006.01)	3735252	HETERODUPLEX NUCLEIC ACID MOLECULES AND USES THEREOF
C12N 15/113 (2010.01)	3735252	HETERODUPLEX NUCLEIC ACID MOLECULES AND USES THEREOF
A61K 31/341 (2006.01)	3737366	METHODS OF TREATING GENERALIZED PUSTULAR PSORIASIS WITH AN ANTAGONIST OF CCR6 OR CXCR2
A61K 31/395 (2006.01)	3737366	METHODS OF TREATING GENERALIZED PUSTULAR PSORIASIS WITH AN ANTAGONIST OF CCR6 OR CXCR2
A61K 31/4035 (2006.01)	3737366	METHODS OF TREATING GENERALIZED PUSTULAR PSORIASIS WITH AN ANTAGONIST OF CCR6 OR CXCR2
C07D 209/44 (2006.01)	3737366	METHODS OF TREATING GENERALIZED PUSTULAR PSORIASIS WITH AN ANTAGONIST OF CCR6 OR CXCR2
C07D 209/46 (2006.01)	3737366	METHODS OF TREATING GENERALIZED PUSTULAR PSORIASIS WITH AN ANTAGONIST OF CCR6 OR CXCR2
C07D 307/52 (2006.01)	3737366	METHODS OF TREATING GENERALIZED PUSTULAR PSORIASIS WITH AN ANTAGONIST OF CCR6 OR CXCR2
C12N 9/02 (2006.01)	3737748	BISULFITE-FREE, BASE-RESOLUTION IDENTIFICATION OF CYTOSINE MODIFICATIONS
C12P 19/18 (2006.01)	3737748	BISULFITE-FREE, BASE-RESOLUTION IDENTIFICATION OF CYTOSINE MODIFICATIONS
C12Q 1/26 (2006.01)	3737748	BISULFITE-FREE, BASE-RESOLUTION IDENTIFICATION OF CYTOSINE MODIFICATIONS
C12Q 1/6806 (2018.01)	3737748	BISULFITE-FREE, BASE-RESOLUTION IDENTIFICATION OF CYTOSINE MODIFICATIONS
C12Q 1/6827 (2018.01)	3737748	BISULFITE-FREE, BASE-RESOLUTION IDENTIFICATION OF CYTOSINE MODIFICATIONS
C12Q 1/6869 (2018.01)	3737748	BISULFITE-FREE, BASE-RESOLUTION IDENTIFICATION OF CYTOSINE MODIFICATIONS
C07D 239/557 (2006.01)	3736568	DETECTION METHOD FOR ANALOG DERIVED FROM TRIFLURIDINE
C07H 19/073 (2006.01)	3736568	DETECTION METHOD FOR ANALOG DERIVED FROM TRIFLURIDINE
G01N 30/26 (2006.01)	3736568	DETECTION METHOD FOR ANALOG DERIVED FROM TRIFLURIDINE
G01N 30/34 (2006.01)	3736568	DETECTION METHOD FOR ANALOG DERIVED FROM TRIFLURIDINE
G01N 30/88 (2006.01)	3736568	DETECTION METHOD FOR ANALOG DERIVED FROM TRIFLURIDINE
A61K 47/68 (2017.01)	3737421	METHODS FOR ANTIBODY DRUG CONJUGATION, PURIFICATION, AND FORMULATION

MKP (51)	Broj objave evropske prijava patenta (97)	Naziv pronalaska (54)
C07K 16/28 (2006.01)	3737421	METHODS FOR ANTIBODY DRUG CONJUGATION, PURIFICATION, AND FORMULATION
A61L 2/18 (2006.01)	3737425	COMPOSITIONS, KITS, METHODS AND USES FOR CLEANING, DISINFECTING, STERILIZING AND/OR TREATING
A61L 2/238 (2006.01)	3737425	COMPOSITIONS, KITS, METHODS AND USES FOR CLEANING, DISINFECTING, STERILIZING AND/OR TREATING
C01B 11/04 (2006.01)	3737425	COMPOSITIONS, KITS, METHODS AND USES FOR CLEANING, DISINFECTING, STERILIZING AND/OR TREATING
C07D 401/04 (2006.01)	3740475	PROCESS OF MAKING SOMATOSTATIN MODULATORS
C07D 498/04 (2006.01)	3740475	PROCESS OF MAKING SOMATOSTATIN MODULATORS
C07F 5/02 (2006.01)	3740475	PROCESS OF MAKING SOMATOSTATIN MODULATORS
C12N 15/09 (2006.01)	3740571	CLOSED-ENDED DNA VECTORS OBTAINABLE FROM CELL-FREE SYNTHESIS AND PROCESS FOR OBTAINING CEDNA VECTORS
C12N 15/63 (2006.01)	3740571	CLOSED-ENDED DNA VECTORS OBTAINABLE FROM CELL-FREE SYNTHESIS AND PROCESS FOR OBTAINING CEDNA VECTORS
C12N 15/64 (2006.01)	3740571	CLOSED-ENDED DNA VECTORS OBTAINABLE FROM CELL-FREE SYNTHESIS AND PROCESS FOR OBTAINING CEDNA VECTORS
C12N 15/66 (2006.01)	3740571	CLOSED-ENDED DNA VECTORS OBTAINABLE FROM CELL-FREE SYNTHESIS AND PROCESS FOR OBTAINING CEDNA VECTORS
C12N 15/86 (2006.01)	3740571	CLOSED-ENDED DNA VECTORS OBTAINABLE FROM CELL-FREE SYNTHESIS AND PROCESS FOR OBTAINING CEDNA VECTORS
B32B 15/04 (2006.01)	3743273	TERMINATION ARRANGEMENT FOR AN OVERHEAD ELECTRICAL CABLE
B32B 27/04 (2006.01)	3743273	TERMINATION ARRANGEMENT FOR AN OVERHEAD ELECTRICAL CABLE
H01B 5/10 (2006.01)	3743273	TERMINATION ARRANGEMENT FOR AN OVERHEAD ELECTRICAL CABLE
H01B 7/17 (2006.01)	3743273	TERMINATION ARRANGEMENT FOR AN OVERHEAD ELECTRICAL CABLE
H02G 1/02 (2006.01)	3743273	TERMINATION ARRANGEMENT FOR AN OVERHEAD ELECTRICAL CABLE
H02G 1/04 (2006.01)	3743273	TERMINATION ARRANGEMENT FOR AN OVERHEAD ELECTRICAL CABLE
H02G 7/02 (2006.01)	3743273	TERMINATION ARRANGEMENT FOR AN OVERHEAD ELECTRICAL CABLE
H02G 7/04 (2006.01)	3743273	TERMINATION ARRANGEMENT FOR AN OVERHEAD ELECTRICAL CABLE
H02G 7/05 (2006.01)	3743273	TERMINATION ARRANGEMENT FOR AN OVERHEAD ELECTRICAL CABLE
H02G 15/18 (2006.01)	3743273	TERMINATION ARRANGEMENT FOR AN OVERHEAD ELECTRICAL CABLE
A61K 39/12 (2006.01)	3746462	STABILIZED RSV F PROTEINS AND USES THEREOF
A61K 39/155 (2006.01)	3746462	STABILIZED RSV F PROTEINS AND USES THEREOF
C07K 14/005 (2006.01)	3746462	STABILIZED RSV F PROTEINS AND USES THEREOF
C07K 14/135 (2006.01)	3746462	STABILIZED RSV F PROTEINS AND USES THEREOF
C12N 15/45 (2006.01)	3746462	STABILIZED RSV F PROTEINS AND USES THEREOF
A61K 31/7105 (2006.01)	3746090	RSV RNA VACCINES
A61K 31/7115 (2006.01)	3746090	RSV RNA VACCINES
A61K 39/155 (2006.01)	3746090	RSV RNA VACCINES
A61P 31/14 (2006.01)	3746090	RSV RNA VACCINES
A61K 31/403 (2006.01)	3743065	SULFONAMIDE DERIVATIVES FOR PROTEIN DEGRADATION
A61K 31/404 (2006.01)	3743065	SULFONAMIDE DERIVATIVES FOR PROTEIN DEGRADATION
A61K 31/4439 (2006.01)	3743065	SULFONAMIDE DERIVATIVES FOR PROTEIN DEGRADATION
C07D 209/42 (2006.01)	3743065	SULFONAMIDE DERIVATIVES FOR PROTEIN DEGRADATION
C07D 403/12 (2006.01)	3743065	SULFONAMIDE DERIVATIVES FOR PROTEIN DEGRADATION
G10L 19/00 (2013.01)	3743916	BACKWARD-COMPATIBLE INTEGRATION OF HIGH FREQUENCY RECONSTRUCTION TECHNIQUES FOR AUDIO SIGNALS
G10L 19/02 (2013.01)	3743916	BACKWARD-COMPATIBLE INTEGRATION OF HIGH FREQUENCY RECONSTRUCTION TECHNIQUES FOR AUDIO SIGNALS
G10L 19/16 (2013.01)	3743916	BACKWARD-COMPATIBLE INTEGRATION OF HIGH FREQUENCY RECONSTRUCTION TECHNIQUES FOR AUDIO SIGNALS
H04N 19/00 (2014.01)	3743916	BACKWARD-COMPATIBLE INTEGRATION OF HIGH FREQUENCY RECONSTRUCTION TECHNIQUES FOR AUDIO SIGNALS
A61K 9/52 (2006.01)	3746091	CHOLESTYRAMINE FORMULATIONS AND METHODS OF USE
A61K 31/785 (2006.01)	3746091	CHOLESTYRAMINE FORMULATIONS AND METHODS OF USE
A61P 1/12 (2006.01)	3746091	CHOLESTYRAMINE FORMULATIONS AND METHODS OF USE
C08F 212/14 (2006.01)	3746091	CHOLESTYRAMINE FORMULATIONS AND METHODS OF USE
C08F 212/36 (2006.01)	3746091	CHOLESTYRAMINE FORMULATIONS AND METHODS OF USE
A61K 31/435 (2006.01)	3746434	PYRAZOLE COMPOUNDS AND PREPARATION THEREOF
A61P 9/04 (2006.01)	3746434	PYRAZOLE COMPOUNDS AND PREPARATION THEREOF

MKP (51)	Broj objave evropske prijava patenta (97)	Naziv pronalaska (54)
C07D 403/04 (2006.01)	3746434	PYRAZOLE COMPOUNDS AND PREPARATION THEREOF
A61K 35/76 (2015.01)	3746100	GENE THERAPY FOR LIMB-GIRDLE MUSCULAR DYSTROPHY TYPE 2C
A61K 38/17 (2006.01)	3746100	GENE THERAPY FOR LIMB-GIRDLE MUSCULAR DYSTROPHY TYPE 2C
A61K 48/00 (2006.01)	3746100	GENE THERAPY FOR LIMB-GIRDLE MUSCULAR DYSTROPHY TYPE 2C
A61M 1/36 (2006.01)	3746100	GENE THERAPY FOR LIMB-GIRDLE MUSCULAR DYSTROPHY TYPE 2C
A61M 5/14 (2006.01)	3746100	GENE THERAPY FOR LIMB-GIRDLE MUSCULAR DYSTROPHY TYPE 2C
A61K 31/135 (2006.01)	3747471	MEDICINE FOR PREVENTING OR TREATING OPHTHALMIC DISEASE ASSOCIATED WITH ENHANCED INTRAOCULAR NEOVASCULARIZATION AND/OR INTRAOCULAR VASCULAR PERMEABILITY
A61K 31/397 (2006.01)	3747471	MEDICINE FOR PREVENTING OR TREATING OPHTHALMIC DISEASE ASSOCIATED WITH ENHANCED INTRAOCULAR NEOVASCULARIZATION AND/OR INTRAOCULAR VASCULAR PERMEABILITY
A61K 31/403 (2006.01)	3747471	MEDICINE FOR PREVENTING OR TREATING OPHTHALMIC DISEASE ASSOCIATED WITH ENHANCED INTRAOCULAR NEOVASCULARIZATION AND/OR INTRAOCULAR VASCULAR PERMEABILITY
A61K 31/4245 (2006.01)	3747471	MEDICINE FOR PREVENTING OR TREATING OPHTHALMIC DISEASE ASSOCIATED WITH ENHANCED INTRAOCULAR NEOVASCULARIZATION AND/OR INTRAOCULAR VASCULAR PERMEABILITY
A61K 31/426 (2006.01)	3747471	MEDICINE FOR PREVENTING OR TREATING OPHTHALMIC DISEASE ASSOCIATED WITH ENHANCED INTRAOCULAR NEOVASCULARIZATION AND/OR INTRAOCULAR VASCULAR PERMEABILITY
A61K 31/496 (2006.01)	3747471	MEDICINE FOR PREVENTING OR TREATING OPHTHALMIC DISEASE ASSOCIATED WITH ENHANCED INTRAOCULAR NEOVASCULARIZATION AND/OR INTRAOCULAR VASCULAR PERMEABILITY
A61K 45/00 (2006.01)	3747471	MEDICINE FOR PREVENTING OR TREATING OPHTHALMIC DISEASE ASSOCIATED WITH ENHANCED INTRAOCULAR NEOVASCULARIZATION AND/OR INTRAOCULAR VASCULAR PERMEABILITY
A61P 9/10 (2006.01)	3747471	MEDICINE FOR PREVENTING OR TREATING OPHTHALMIC DISEASE ASSOCIATED WITH ENHANCED INTRAOCULAR NEOVASCULARIZATION AND/OR INTRAOCULAR VASCULAR PERMEABILITY
A61P 27/02 (2006.01)	3747471	MEDICINE FOR PREVENTING OR TREATING OPHTHALMIC DISEASE ASSOCIATED WITH ENHANCED INTRAOCULAR NEOVASCULARIZATION AND/OR INTRAOCULAR VASCULAR PERMEABILITY
A61K 31/437 (2006.01)	3747888	NITROGENATED HETEROCYCLIC AMIDE COMPOUND, AND USE THEREOF FOR MEDICAL PURPOSES
A61K 31/4985 (2006.01)	3747888	NITROGENATED HETEROCYCLIC AMIDE COMPOUND, AND USE THEREOF FOR MEDICAL PURPOSES
A61K 31/506 (2006.01)	3747888	NITROGENATED HETEROCYCLIC AMIDE COMPOUND, AND USE THEREOF FOR MEDICAL PURPOSES
A61P 3/10 (2006.01)	3747888	NITROGENATED HETEROCYCLIC AMIDE COMPOUND, AND USE THEREOF FOR MEDICAL PURPOSES
A61P 9/04 (2006.01)	3747888	NITROGENATED HETEROCYCLIC AMIDE COMPOUND, AND USE THEREOF FOR MEDICAL PURPOSES
A61P 9/12 (2006.01)	3747888	NITROGENATED HETEROCYCLIC AMIDE COMPOUND, AND USE THEREOF FOR MEDICAL PURPOSES
A61P 43/00 (2006.01)	3747888	NITROGENATED HETEROCYCLIC AMIDE COMPOUND, AND USE THEREOF FOR MEDICAL PURPOSES
C07D 487/04 (2006.01)	3747888	NITROGENATED HETEROCYCLIC AMIDE COMPOUND, AND USE THEREOF FOR MEDICAL PURPOSES
C07D 498/04 (2006.01)	3747888	NITROGENATED HETEROCYCLIC AMIDE COMPOUND, AND USE THEREOF FOR MEDICAL PURPOSES
C07D 519/00 (2006.01)	3747888	NITROGENATED HETEROCYCLIC AMIDE COMPOUND, AND USE THEREOF FOR MEDICAL PURPOSES
A47K 10/32 (2006.01)	3745935	WIPE DISPENSING
A47K 10/34 (2006.01)	3745935	WIPE DISPENSING
A47K 10/38 (2006.01)	3745935	WIPE DISPENSING

MKP (51)	Broj objave evropske prijava patenta (97)	Naziv pronalaska (54)
C12N 7/00 (2006.01)	3749756	TRANSCRIPTION REGULATORY ELEMENTS AND USES THEREOF
C12N 15/86 (2006.01)	3749756	TRANSCRIPTION REGULATORY ELEMENTS AND USES THEREOF
C12Q 1/70 (2006.01)	3749756	TRANSCRIPTION REGULATORY ELEMENTS AND USES THEREOF
C12M 1/00 (2006.01)	3749745	TISSUE ENGINEERED SCAFFOLDS, INSTRUMENTED BIOREACTORS AND METHODS OF USE THEREOF
C12M 3/00 (2006.01)	3749745	TISSUE ENGINEERED SCAFFOLDS, INSTRUMENTED BIOREACTORS AND METHODS OF USE THEREOF
C12N 5/071 (2010.01)	3749745	TISSUE ENGINEERED SCAFFOLDS, INSTRUMENTED BIOREACTORS AND METHODS OF USE THEREOF
C07D 401/14 (2006.01)	3752498	SOMATOSTATIN MODULATORS AND USES THEREOF
C07D 471/04 (2006.01)	3752498	SOMATOSTATIN MODULATORS AND USES THEREOF
H01L 41/02 (2006.01)	3750196	ELECTRICAL AMPLIFICATION SYSTEMS THROUGH RESONANCE
H01L 41/04 (2006.01)	3750196	ELECTRICAL AMPLIFICATION SYSTEMS THROUGH RESONANCE
H01L 41/08 (2006.01)	3750196	ELECTRICAL AMPLIFICATION SYSTEMS THROUGH RESONANCE
H02K 7/14 (2006.01)	3750196	ELECTRICAL AMPLIFICATION SYSTEMS THROUGH RESONANCE
H02N 2/10 (2006.01)	3750196	ELECTRICAL AMPLIFICATION SYSTEMS THROUGH RESONANCE
H02N 2/14 (2006.01)	3750196	ELECTRICAL AMPLIFICATION SYSTEMS THROUGH RESONANCE
A61K 9/19 (2006.01)	3723777	COMPOSITIONS COMPRISING BACTERIAL STRAINS
A61K 35/74 (2015.01)	3723777	COMPOSITIONS COMPRISING BACTERIAL STRAINS
A61K 35/741 (2015.01)	3723777	COMPOSITIONS COMPRISING BACTERIAL STRAINS
A61P 1/00 (2006.01)	3723777	COMPOSITIONS COMPRISING BACTERIAL STRAINS
A61P 43/00 (2006.01)	3723777	COMPOSITIONS COMPRISING BACTERIAL STRAINS
A61K 9/14 (2006.01)	3756670	GRANULAR COMPOSITION, METHOD FOR PRODUCING GRANULAR COMPOSITION, AND METHOD FOR IMPROVING ELUTION PROPERTY OF GRANULAR COMPOSITION
A61K 9/16 (2006.01)	3756670	GRANULAR COMPOSITION, METHOD FOR PRODUCING GRANULAR COMPOSITION, AND METHOD FOR IMPROVING ELUTION PROPERTY OF GRANULAR COMPOSITION
A61K 9/20 (2006.01)	3756670	GRANULAR COMPOSITION, METHOD FOR PRODUCING GRANULAR COMPOSITION, AND METHOD FOR IMPROVING ELUTION PROPERTY OF GRANULAR COMPOSITION
A61K 9/48 (2006.01)	3756670	GRANULAR COMPOSITION, METHOD FOR PRODUCING GRANULAR COMPOSITION, AND METHOD FOR IMPROVING ELUTION PROPERTY OF GRANULAR COMPOSITION
A61K 31/4965 (2006.01)	3756670	GRANULAR COMPOSITION, METHOD FOR PRODUCING GRANULAR COMPOSITION, AND METHOD FOR IMPROVING ELUTION PROPERTY OF GRANULAR COMPOSITION
A61K 47/26 (2006.01)	3756670	GRANULAR COMPOSITION, METHOD FOR PRODUCING GRANULAR COMPOSITION, AND METHOD FOR IMPROVING ELUTION PROPERTY OF GRANULAR COMPOSITION
A61K 47/36 (2006.01)	3756670	GRANULAR COMPOSITION, METHOD FOR PRODUCING GRANULAR COMPOSITION, AND METHOD FOR IMPROVING ELUTION PROPERTY OF GRANULAR COMPOSITION
A61P 7/00 (2006.01)	3756670	GRANULAR COMPOSITION, METHOD FOR PRODUCING GRANULAR COMPOSITION, AND METHOD FOR IMPROVING ELUTION PROPERTY OF GRANULAR COMPOSITION
A61P 7/02 (2006.01)	3756670	GRANULAR COMPOSITION, METHOD FOR PRODUCING GRANULAR COMPOSITION, AND METHOD FOR IMPROVING ELUTION PROPERTY OF GRANULAR COMPOSITION
A61P 9/08 (2006.01)	3756670	GRANULAR COMPOSITION, METHOD FOR PRODUCING GRANULAR COMPOSITION, AND METHOD FOR IMPROVING ELUTION PROPERTY OF GRANULAR COMPOSITION
A61P 11/08 (2006.01)	3756670	GRANULAR COMPOSITION, METHOD FOR PRODUCING GRANULAR COMPOSITION, AND METHOD FOR IMPROVING ELUTION PROPERTY OF GRANULAR COMPOSITION
A61P 43/00 (2006.01)	3756670	GRANULAR COMPOSITION, METHOD FOR PRODUCING GRANULAR COMPOSITION, AND METHOD FOR IMPROVING ELUTION PROPERTY OF GRANULAR COMPOSITION
A61K 9/14 (2006.01)	3758710	STABLE LYOPHILIZED COMPOSITION OF CYCLOPHOSPHAMIDE
A61K 9/19 (2006.01)	3758710	STABLE LYOPHILIZED COMPOSITION OF CYCLOPHOSPHAMIDE
A61K 31/675 (2006.01)	3758710	STABLE LYOPHILIZED COMPOSITION OF CYCLOPHOSPHAMIDE
A61K 31/137 (2006.01)	3755312	DOSAGE FORMS AND METHODS FOR ENANTIOMERICALLY ENRICHED OR PURE BUPROPION
A61K 31/485 (2006.01)	3755312	DOSAGE FORMS AND METHODS FOR ENANTIOMERICALLY ENRICHED OR PURE BUPROPION
A61P 25/00 (2006.01)	3755312	DOSAGE FORMS AND METHODS FOR ENANTIOMERICALLY ENRICHED OR PURE BUPROPION
A61P 25/18 (2006.01)	3755312	DOSAGE FORMS AND METHODS FOR ENANTIOMERICALLY ENRICHED OR PURE BUPROPION

MKP (51)	Broj objave evropske prijava patenta (97)	Naziv pronalaska (54)
A61P 25/24 (2006.01)	3755312	DOSAGE FORMS AND METHODS FOR ENANTIOMERICALLY ENRICHED OR PURE BUPROPION
A61P 25/28 (2006.01)	3755312	DOSAGE FORMS AND METHODS FOR ENANTIOMERICALLY ENRICHED OR PURE BUPROPION
A61P 25/30 (2006.01)	3755312	DOSAGE FORMS AND METHODS FOR ENANTIOMERICALLY ENRICHED OR PURE BUPROPION
C07K 16/28 (2006.01)	3755721	MULTI-SPECIFIC BINDING PROTEINS THAT BIND CD33, NKG2D, AND CD16, AND METHODS OF USE
C07K 16/32 (2006.01)	3755721	MULTI-SPECIFIC BINDING PROTEINS THAT BIND CD33, NKG2D, AND CD16, AND METHODS OF USE
A61K 31/015 (2006.01)	3755311	INDANE-AMINES AS PD-L1 ANTAGONISTS
A61K 31/03 (2006.01)	3755311	INDANE-AMINES AS PD-L1 ANTAGONISTS
C07C 211/38 (2006.01)	3755311	INDANE-AMINES AS PD-L1 ANTAGONISTS
C12N 15/86 (2006.01)	3755803	CONTROLLED EXPRESSION OF TRANSGENES USING CLOSE-ENDED DNA (CEDNA) VECTORS
C12N 15/864 (2006.01)	3755803	CONTROLLED EXPRESSION OF TRANSGENES USING CLOSE-ENDED DNA (CEDNA) VECTORS
C12N 15/87 (2006.01)	3755803	CONTROLLED EXPRESSION OF TRANSGENES USING CLOSE-ENDED DNA (CEDNA) VECTORS
A61K 35/17 (2015.01)	3755348	ANTIBODY VARIABLE DOMAINS TARGETING CD33, AND USE THEREOF
A61K 39/395 (2006.01)	3755348	ANTIBODY VARIABLE DOMAINS TARGETING CD33, AND USE THEREOF
A61K 48/00 (2006.01)	3755348	ANTIBODY VARIABLE DOMAINS TARGETING CD33, AND USE THEREOF
A01N 37/10 (2006.01)	3755148	NANOSUSPENSIONS OF SALSALATE AND METHODS OF USING THE SAME
A61K 31/235 (2006.01)	3755148	NANOSUSPENSIONS OF SALSALATE AND METHODS OF USING THE SAME
A61K 9/00 (2006.01)	3755805	COMPOSITIONS AND METHODS FOR TREATING NON-AGE-ASSOCIATED HEARING IMPAIRMENT IN A HUMAN SUBJECT
A61K 38/17 (2006.01)	3755805	COMPOSITIONS AND METHODS FOR TREATING NON-AGE-ASSOCIATED HEARING IMPAIRMENT IN A HUMAN SUBJECT
A61K 48/00 (2006.01)	3755805	COMPOSITIONS AND METHODS FOR TREATING NON-AGE-ASSOCIATED HEARING IMPAIRMENT IN A HUMAN SUBJECT
A61P 25/00 (2006.01)	3755805	COMPOSITIONS AND METHODS FOR TREATING NON-AGE-ASSOCIATED HEARING IMPAIRMENT IN A HUMAN SUBJECT
A61P 27/16 (2006.01)	3755805	COMPOSITIONS AND METHODS FOR TREATING NON-AGE-ASSOCIATED HEARING IMPAIRMENT IN A HUMAN SUBJECT
C07K 14/435 (2006.01)	3755805	COMPOSITIONS AND METHODS FOR TREATING NON-AGE-ASSOCIATED HEARING IMPAIRMENT IN A HUMAN SUBJECT
C12N 15/65 (2006.01)	3755805	COMPOSITIONS AND METHODS FOR TREATING NON-AGE-ASSOCIATED HEARING IMPAIRMENT IN A HUMAN SUBJECT
C12N 15/86 (2006.01)	3755805	COMPOSITIONS AND METHODS FOR TREATING NON-AGE-ASSOCIATED HEARING IMPAIRMENT IN A HUMAN SUBJECT
A61K 38/00 (2006.01)	3758729	IL-15 CONJUGATES AND USES THEREOF
A61K 38/20 (2006.01)	3758729	IL-15 CONJUGATES AND USES THEREOF
C07K 14/54 (2006.01)	3758729	IL-15 CONJUGATES AND USES THEREOF
C12N 15/24 (2006.01)	3758729	IL-15 CONJUGATES AND USES THEREOF
A61K 31/513 (2006.01)	3760616	4-METHYLDIHYDROPYRIMIDINONE COMPOUND AND MEDICINAL USE THEREOF
A61P 3/00 (2006.01)	3760616	4-METHYLDIHYDROPYRIMIDINONE COMPOUND AND MEDICINAL USE THEREOF
A61P 27/04 (2006.01)	3760616	4-METHYLDIHYDROPYRIMIDINONE COMPOUND AND MEDICINAL USE THEREOF
A61P 35/00 (2006.01)	3760616	4-METHYLDIHYDROPYRIMIDINONE COMPOUND AND MEDICINAL USE THEREOF
A61P 37/02 (2006.01)	3760616	4-METHYLDIHYDROPYRIMIDINONE COMPOUND AND MEDICINAL USE THEREOF
A61P 37/08 (2006.01)	3760616	4-METHYLDIHYDROPYRIMIDINONE COMPOUND AND MEDICINAL USE THEREOF
C07D 239/22 (2006.01)	3760616	4-METHYLDIHYDROPYRIMIDINONE COMPOUND AND MEDICINAL USE THEREOF
A61K 31/4155 (2006.01)	3760624	METHYLLACTAM RING COMPOUND AND MEDICINAL USE THEREOF
A61P 3/10 (2006.01)	3760624	METHYLLACTAM RING COMPOUND AND MEDICINAL USE THEREOF
A61P 43/00 (2006.01)	3760624	METHYLLACTAM RING COMPOUND AND MEDICINAL USE THEREOF

MKP (51)	Broj objave evropske prijava patenta (97)	Naziv pronalaska (54)
C07D 403/12 (2006.01)	3760624	METHYLLACTAM RING COMPOUND AND MEDICINAL USE THEREOF
A61K 38/17 (2006.01)	3759125	METHODS FOR TREATING CANCER USING COMBINATIONS OF ANTI-BTNL2 AND IMMUNE CHECKPOINT BLOCKADE AGENTS
A61K 39/395 (2006.01)	3759125	METHODS FOR TREATING CANCER USING COMBINATIONS OF ANTI-BTNL2 AND IMMUNE CHECKPOINT BLOCKADE AGENTS
C07K 14/43 (2006.01)	3759125	METHODS FOR TREATING CANCER USING COMBINATIONS OF ANTI-BTNL2 AND IMMUNE CHECKPOINT BLOCKADE AGENTS
C07K 14/435 (2006.01)	3759125	METHODS FOR TREATING CANCER USING COMBINATIONS OF ANTI-BTNL2 AND IMMUNE CHECKPOINT BLOCKADE AGENTS
C07K 14/705 (2006.01)	3759125	METHODS FOR TREATING CANCER USING COMBINATIONS OF ANTI-BTNL2 AND IMMUNE CHECKPOINT BLOCKADE AGENTS
G01M 11/00 (2006.01)	3759454	SYSTEMS, METHODS AND TOOLS FOR THE INTERROGATION OF COMPOSITE STRENGTH MEMBERS
A01N 57/12 (2006.01)	3758495	NANOPARTICLE COMPOSITIONS
A01N 57/20 (2006.01)	3758495	NANOPARTICLE COMPOSITIONS
A61K 31/661 (2006.01)	3758495	NANOPARTICLE COMPOSITIONS
G06F 3/0481 (2013.01)	3759633	METHODS AND SYSTEMS FOR CYBER-MONITORING AND VISUALLY DEPICTING CYBER-ACTIVITIES
G06F 21/50 (2013.01)	3759633	METHODS AND SYSTEMS FOR CYBER-MONITORING AND VISUALLY DEPICTING CYBER-ACTIVITIES
H04L 12/22 (2006.01)	3759633	METHODS AND SYSTEMS FOR CYBER-MONITORING AND VISUALLY DEPICTING CYBER-ACTIVITIES
H04L 12/24 (2006.01)	3759633	METHODS AND SYSTEMS FOR CYBER-MONITORING AND VISUALLY DEPICTING CYBER-ACTIVITIES
H04L 29/06 (2006.01)	3759633	METHODS AND SYSTEMS FOR CYBER-MONITORING AND VISUALLY DEPICTING CYBER-ACTIVITIES
H04L 29/08 (2006.01)	3759633	METHODS AND SYSTEMS FOR CYBER-MONITORING AND VISUALLY DEPICTING CYBER-ACTIVITIES
C12N 9/14 (2006.01)	3759217	CLOSED-ENDED DNA (CEDNA) VECTORS FOR INSERTION OF TRANSGENES AT GENOMIC SAFE HARBORS (GSH) IN HUMANS AND MURINE GENOMES
C12N 9/22 (2006.01)	3759217	CLOSED-ENDED DNA (CEDNA) VECTORS FOR INSERTION OF TRANSGENES AT GENOMIC SAFE HARBORS (GSH) IN HUMANS AND MURINE GENOMES
C12N 15/00 (2006.01)	3759217	CLOSED-ENDED DNA (CEDNA) VECTORS FOR INSERTION OF TRANSGENES AT GENOMIC SAFE HARBORS (GSH) IN HUMANS AND MURINE GENOMES
C12N 15/62 (2006.01)	3759217	CLOSED-ENDED DNA (CEDNA) VECTORS FOR INSERTION OF TRANSGENES AT GENOMIC SAFE HARBORS (GSH) IN HUMANS AND MURINE GENOMES
C12N 15/63 (2006.01)	3759217	CLOSED-ENDED DNA (CEDNA) VECTORS FOR INSERTION OF TRANSGENES AT GENOMIC SAFE HARBORS (GSH) IN HUMANS AND MURINE GENOMES
C07C 253/34 (2006.01)	3760612	METHOD FOR PURIFYING NITRILE SOLVENT
C07C 255/03 (2006.01)	3760612	METHOD FOR PURIFYING NITRILE SOLVENT
C12N 15/90 (2006.01)	3759226	IDENTIFYING AND CHARACTERIZING GENOMIC SAFE HARBORS (GSH) IN HUMANS AND MURINE GENOMES, AND VIRAL AND NON-VIRAL VECTOR COMPOSITIONS FOR TARGETED INTEGRATION AT AN IDENTIFIED GSH LOCI
B01D 1/22 (2006.01)	3760582	METHOD FOR PRODUCING BIS(FLUOROSULFONYL)AMIDE ALKALI METAL SALT POWDER
B01D 9/02 (2006.01)	3760582	METHOD FOR PRODUCING BIS(FLUOROSULFONYL)AMIDE ALKALI METAL SALT POWDER
C01B 21/086 (2006.01)	3760582	METHOD FOR PRODUCING BIS(FLUOROSULFONYL)AMIDE ALKALI METAL SALT POWDER
C01B 21/096 (2006.01)	3760582	METHOD FOR PRODUCING BIS(FLUOROSULFONYL)AMIDE ALKALI METAL SALT POWDER
C07C 311/48 (2006.01)	3760582	METHOD FOR PRODUCING BIS(FLUOROSULFONYL)AMIDE ALKALI METAL SALT POWDER
A01N 47/02 (2006.01)	3760615	HETEROARYL SULFONAMIDE COMPOUND AND PEST CONTROL AGENT
A01P 5/00 (2006.01)	3760615	HETEROARYL SULFONAMIDE COMPOUND AND PEST CONTROL AGENT
A01P 7/04 (2006.01)	3760615	HETEROARYL SULFONAMIDE COMPOUND AND PEST CONTROL AGENT
A61K 31/4155 (2006.01)	3760615	HETEROARYL SULFONAMIDE COMPOUND AND PEST CONTROL AGENT
A61K 31/455 (2006.01)	3760615	HETEROARYL SULFONAMIDE COMPOUND AND PEST CONTROL AGENT

MKP (51)	Broj objave evropske prijava patenta (97)	Naziv pronalaska (54)
A61P 33/10 (2006.01)	3760615	HETEROARYL SULFONAMIDE COMPOUND AND PEST CONTROL AGENT
A61P 33/14 (2006.01)	3760615	HETEROARYL SULFONAMIDE COMPOUND AND PEST CONTROL AGENT
C07D 213/81 (2006.01)	3760615	HETEROARYL SULFONAMIDE COMPOUND AND PEST CONTROL AGENT
C07D 213/82 (2006.01)	3760615	HETEROARYL SULFONAMIDE COMPOUND AND PEST CONTROL AGENT
C07D 409/12 (2006.01)	3760615	HETEROARYL SULFONAMIDE COMPOUND AND PEST CONTROL AGENT
A61K 31/517 (2006.01)	3760619	SATURATED RING-CONDENSED DIHYDROPYRIMIDINONE OR DIHYDROTRIAZINONE COMPOUND, AND PHARMACEUTICAL USE THEREOF
A61K 31/519 (2006.01)	3760619	SATURATED RING-CONDENSED DIHYDROPYRIMIDINONE OR DIHYDROTRIAZINONE COMPOUND, AND PHARMACEUTICAL USE THEREOF
A61K 31/53 (2006.01)	3760619	SATURATED RING-CONDENSED DIHYDROPYRIMIDINONE OR DIHYDROTRIAZINONE COMPOUND, AND PHARMACEUTICAL USE THEREOF
A61P 3/00 (2006.01)	3760619	SATURATED RING-CONDENSED DIHYDROPYRIMIDINONE OR DIHYDROTRIAZINONE COMPOUND, AND PHARMACEUTICAL USE THEREOF
A61P 27/02 (2006.01)	3760619	SATURATED RING-CONDENSED DIHYDROPYRIMIDINONE OR DIHYDROTRIAZINONE COMPOUND, AND PHARMACEUTICAL USE THEREOF
A61P 35/00 (2006.01)	3760619	SATURATED RING-CONDENSED DIHYDROPYRIMIDINONE OR DIHYDROTRIAZINONE COMPOUND, AND PHARMACEUTICAL USE THEREOF
A61P 37/06 (2006.01)	3760619	SATURATED RING-CONDENSED DIHYDROPYRIMIDINONE OR DIHYDROTRIAZINONE COMPOUND, AND PHARMACEUTICAL USE THEREOF
A61P 37/08 (2006.01)	3760619	SATURATED RING-CONDENSED DIHYDROPYRIMIDINONE OR DIHYDROTRIAZINONE COMPOUND, AND PHARMACEUTICAL USE THEREOF
C07D 239/70 (2006.01)	3760619	SATURATED RING-CONDENSED DIHYDROPYRIMIDINONE OR DIHYDROTRIAZINONE COMPOUND, AND PHARMACEUTICAL USE THEREOF
C07D 239/80 (2006.01)	3760619	SATURATED RING-CONDENSED DIHYDROPYRIMIDINONE OR DIHYDROTRIAZINONE COMPOUND, AND PHARMACEUTICAL USE THEREOF
C07D 253/10 (2006.01)	3760619	SATURATED RING-CONDENSED DIHYDROPYRIMIDINONE OR DIHYDROTRIAZINONE COMPOUND, AND PHARMACEUTICAL USE THEREOF
C07D 487/04 (2006.01)	3760619	SATURATED RING-CONDENSED DIHYDROPYRIMIDINONE OR DIHYDROTRIAZINONE COMPOUND, AND PHARMACEUTICAL USE THEREOF
C07D 491/048 (2006.01)	3760619	SATURATED RING-CONDENSED DIHYDROPYRIMIDINONE OR DIHYDROTRIAZINONE COMPOUND, AND PHARMACEUTICAL USE THEREOF
C07D 491/052 (2006.01)	3760619	SATURATED RING-CONDENSED DIHYDROPYRIMIDINONE OR DIHYDROTRIAZINONE COMPOUND, AND PHARMACEUTICAL USE THEREOF
A61K 31/70 (2006.01)	3758712	CPG AMPHIPHILES AND USES THEREOF
A61K 31/7088 (2006.01)	3758712	CPG AMPHIPHILES AND USES THEREOF
A61K 31/7115 (2006.01)	3758712	CPG AMPHIPHILES AND USES THEREOF
A61K 31/70 (2006.01)	3758713	COMPOUNDS INCLUDING A MUTANT KRAS SEQUENCE AND A LIPID AND USES THEREOF
A61K 31/7088 (2006.01)	3758713	COMPOUNDS INCLUDING A MUTANT KRAS SEQUENCE AND A LIPID AND USES THEREOF
A61K 31/7115 (2006.01)	3758713	COMPOUNDS INCLUDING A MUTANT KRAS SEQUENCE AND A LIPID AND USES THEREOF
A61P 9/00 (2006.01)	3687506	SUBSTITUTED BENZOFURAN, BENZOPYRROLE, BENZOTHIOPHENE, AND STRUCTURALLY RELATED COMPLEMENT INHIBITORS
A61P 13/12 (2006.01)	3687506	SUBSTITUTED BENZOFURAN, BENZOPYRROLE, BENZOTHIOPHENE, AND STRUCTURALLY RELATED COMPLEMENT INHIBITORS
A61P 25/28 (2006.01)	3687506	SUBSTITUTED BENZOFURAN, BENZOPYRROLE, BENZOTHIOPHENE, AND STRUCTURALLY RELATED COMPLEMENT INHIBITORS

MKP (51)	Broj objave evropske prijava patenta (97)	Naziv pronalaska (54)
A61P 37/00 (2006.01)	3687506	SUBSTITUTED BENZOFURAN, BENZOPYRROLE, BENZOTHIOPHENE, AND STRUCTURALLY RELATED COMPLEMENT INHIBITORS
C07D 209/08 (2006.01)	3687506	SUBSTITUTED BENZOFURAN, BENZOPYRROLE, BENZOTHIOPHENE, AND STRUCTURALLY RELATED COMPLEMENT INHIBITORS
C07D 231/56 (2006.01)	3687506	SUBSTITUTED BENZOFURAN, BENZOPYRROLE, BENZOTHIOPHENE, AND STRUCTURALLY RELATED COMPLEMENT INHIBITORS
C07D 235/08 (2006.01)	3687506	SUBSTITUTED BENZOFURAN, BENZOPYRROLE, BENZOTHIOPHENE, AND STRUCTURALLY RELATED COMPLEMENT INHIBITORS
C07D 239/70 (2006.01)	3687506	SUBSTITUTED BENZOFURAN, BENZOPYRROLE, BENZOTHIOPHENE, AND STRUCTURALLY RELATED COMPLEMENT INHIBITORS
C07D 261/20 (2006.01)	3687506	SUBSTITUTED BENZOFURAN, BENZOPYRROLE, BENZOTHIOPHENE, AND STRUCTURALLY RELATED COMPLEMENT INHIBITORS
C07D 307/79 (2006.01)	3687506	SUBSTITUTED BENZOFURAN, BENZOPYRROLE, BENZOTHIOPHENE, AND STRUCTURALLY RELATED COMPLEMENT INHIBITORS
C07D 307/81 (2006.01)	3687506	SUBSTITUTED BENZOFURAN, BENZOPYRROLE, BENZOTHIOPHENE, AND STRUCTURALLY RELATED COMPLEMENT INHIBITORS
C07D 333/54 (2006.01)	3687506	SUBSTITUTED BENZOFURAN, BENZOPYRROLE, BENZOTHIOPHENE, AND STRUCTURALLY RELATED COMPLEMENT INHIBITORS
C07D 403/10 (2006.01)	3687506	SUBSTITUTED BENZOFURAN, BENZOPYRROLE, BENZOTHIOPHENE, AND STRUCTURALLY RELATED COMPLEMENT INHIBITORS
C07D 405/12 (2006.01)	3687506	SUBSTITUTED BENZOFURAN, BENZOPYRROLE, BENZOTHIOPHENE, AND STRUCTURALLY RELATED COMPLEMENT INHIBITORS
C07D 407/04 (2006.01)	3687506	SUBSTITUTED BENZOFURAN, BENZOPYRROLE, BENZOTHIOPHENE, AND STRUCTURALLY RELATED COMPLEMENT INHIBITORS
C07D 407/10 (2006.01)	3687506	SUBSTITUTED BENZOFURAN, BENZOPYRROLE, BENZOTHIOPHENE, AND STRUCTURALLY RELATED COMPLEMENT INHIBITORS
C07D 409/12 (2006.01)	3687506	SUBSTITUTED BENZOFURAN, BENZOPYRROLE, BENZOTHIOPHENE, AND STRUCTURALLY RELATED COMPLEMENT INHIBITORS
C07D 471/04 (2006.01)	3687506	SUBSTITUTED BENZOFURAN, BENZOPYRROLE, BENZOTHIOPHENE, AND STRUCTURALLY RELATED COMPLEMENT INHIBITORS
C07D 487/04 (2006.01)	3687506	SUBSTITUTED BENZOFURAN, BENZOPYRROLE, BENZOTHIOPHENE, AND STRUCTURALLY RELATED COMPLEMENT INHIBITORS
A61K 31/13 (2006.01)	3740201	METHOD OF TREATING ACID-BASE DISORDERS
A61K 31/785 (2006.01)	3740201	METHOD OF TREATING ACID-BASE DISORDERS
A61P 13/12 (2006.01)	3740201	METHOD OF TREATING ACID-BASE DISORDERS
A23D 9/00 (2006.01)	3737736	PROCESS FOR PRODUCING OILS AND DEFATTED MEAL BY MEANS OF SOLID/LIQUID EXTRACTION
A23D 9/007 (2006.01)	3737736	PROCESS FOR PRODUCING OILS AND DEFATTED MEAL BY MEANS OF SOLID/LIQUID EXTRACTION
B01D 11/02 (2006.01)	3737736	PROCESS FOR PRODUCING OILS AND DEFATTED MEAL BY MEANS OF SOLID/LIQUID EXTRACTION
C11B 1/10 (2006.01)	3737736	PROCESS FOR PRODUCING OILS AND DEFATTED MEAL BY MEANS OF SOLID/LIQUID EXTRACTION
C11B 3/12 (2006.01)	3737736	PROCESS FOR PRODUCING OILS AND DEFATTED MEAL BY MEANS OF SOLID/LIQUID EXTRACTION
C11B 3/14 (2006.01)	3737736	PROCESS FOR PRODUCING OILS AND DEFATTED MEAL BY MEANS OF SOLID/LIQUID EXTRACTION
A61B 5/00 (2006.01)	3680916	AUDIO-VIDEO CONFERENCING SYSTEM FOR TELEMEDICINE
G16H 40/67 (2018.01)	3680916	AUDIO-VIDEO CONFERENCING SYSTEM FOR TELEMEDICINE
G16H 80/00 (2018.01)	3680916	AUDIO-VIDEO CONFERENCING SYSTEM FOR TELEMEDICINE
H04L 29/08 (2006.01)	3680916	AUDIO-VIDEO CONFERENCING SYSTEM FOR TELEMEDICINE
H04N 7/15 (2006.01)	3680916	AUDIO-VIDEO CONFERENCING SYSTEM FOR TELEMEDICINE
A61K 31/00 (2006.01)	3689910	METHOD OF USING ANTI-CD79B IMMUNOCONJUGATES
A61K 39/395 (2006.01)	3689910	METHOD OF USING ANTI-CD79B IMMUNOCONJUGATES

MKP (51)	Broj objave evropske prijava patenta (97)	Naziv pronalaska (54)
A61K 45/06 (2006.01)	3689910	METHOD OF USING ANTI-CD79B IMMUNOCONJUGATES
A61K 47/68 (2017.01)	3689910	METHOD OF USING ANTI-CD79B IMMUNOCONJUGATES
A61P 35/00 (2006.01)	3689910	METHOD OF USING ANTI-CD79B IMMUNOCONJUGATES
C07K 16/28 (2006.01)	3689910	METHOD OF USING ANTI-CD79B IMMUNOCONJUGATES
C07K 16/30 (2006.01)	3689910	METHOD OF USING ANTI-CD79B IMMUNOCONJUGATES
A61K 47/68 (2017.01)	3730520	AXL-SPECIFIC ANTIBODY-DRUG CONJUGATES FOR CANCER TREATMENT
A61P 35/00 (2006.01)	3730520	AXL-SPECIFIC ANTIBODY-DRUG CONJUGATES FOR CANCER TREATMENT
C07K 16/28 (2006.01)	3730520	AXL-SPECIFIC ANTIBODY-DRUG CONJUGATES FOR CANCER TREATMENT
A45D 1/00 (2006.01)	3695743	HAIR STYLING DEVICE
A45D 1/04 (2006.01)	3695743	HAIR STYLING DEVICE
A45D 1/10 (2006.01)	3695743	HAIR STYLING DEVICE
A45D 1/18 (2006.01)	3695743	HAIR STYLING DEVICE
A45D 1/28 (2006.01)	3695743	HAIR STYLING DEVICE
A45D 2/00 (2006.01)	3695743	HAIR STYLING DEVICE
A45D 6/04 (2006.01)	3695743	HAIR STYLING DEVICE
C07D 249/08 (2006.01)	3663291	NUCLEAR TRANSPORT MODULATORS AND USES THEREOF
C07D 403/12 (2006.01)	3663291	NUCLEAR TRANSPORT MODULATORS AND USES THEREOF
C07D 413/12 (2006.01)	3663291	NUCLEAR TRANSPORT MODULATORS AND USES THEREOF
A61K 9/00 (2006.01)	3679922	SYRINGE
A61M 5/28 (2006.01)	3679922	SYRINGE
A61M 5/31 (2006.01)	3679922	SYRINGE
A61M 5/315 (2006.01)	3679922	SYRINGE
A61P 27/02 (2006.01)	3679922	SYRINGE
A61P 43/00 (2006.01)	3679922	SYRINGE
G01H 1/00 (2006.01)	3696520	ULTRASONIC ROTOR DEFLECTION MONITORING SYSTEM
G01H 9/00 (2006.01)	3696520	ULTRASONIC ROTOR DEFLECTION MONITORING SYSTEM
A61K 35/76 (2015.01)	3701959	RNA REPLICON FOR VERSATILE AND EFFICIENT GENE EXPRESSION
C12N 5/10 (2006.01)	3701959	RNA REPLICON FOR VERSATILE AND EFFICIENT GENE EXPRESSION
C12N 15/85 (2006.01)	3701959	RNA REPLICON FOR VERSATILE AND EFFICIENT GENE EXPRESSION
C12N 15/86 (2006.01)	3701959	RNA REPLICON FOR VERSATILE AND EFFICIENT GENE EXPRESSION
A61K 9/00 (2006.01)	3689379	A PROCESS FOR PREPARING A DRY POWDER FORMULATION COMPRISING AN ANTICHOLINERGIC, A CORTICOSTEROID AND A BETA-ADRENERGIC
A61K 9/14 (2006.01)	3689379	A PROCESS FOR PREPARING A DRY POWDER FORMULATION COMPRISING AN ANTICHOLINERGIC, A CORTICOSTEROID AND A BETA-ADRENERGIC
A61K 9/16 (2006.01)	3689379	A PROCESS FOR PREPARING A DRY POWDER FORMULATION COMPRISING AN ANTICHOLINERGIC, A CORTICOSTEROID AND A BETA-ADRENERGIC
A61K 31/00 (2006.01)	3689379	A PROCESS FOR PREPARING A DRY POWDER FORMULATION COMPRISING AN ANTICHOLINERGIC, A CORTICOSTEROID AND A BETA-ADRENERGIC
A61K 31/167 (2006.01)	3689379	A PROCESS FOR PREPARING A DRY POWDER FORMULATION COMPRISING AN ANTICHOLINERGIC, A CORTICOSTEROID AND A BETA-ADRENERGIC
A61K 31/194 (2006.01)	3689379	A PROCESS FOR PREPARING A DRY POWDER FORMULATION COMPRISING AN ANTICHOLINERGIC, A CORTICOSTEROID AND A BETA-ADRENERGIC
A61K 31/40 (2006.01)	3689379	A PROCESS FOR PREPARING A DRY POWDER FORMULATION COMPRISING AN ANTICHOLINERGIC, A CORTICOSTEROID AND A BETA-ADRENERGIC
A61K 31/573 (2006.01)	3689379	A PROCESS FOR PREPARING A DRY POWDER FORMULATION COMPRISING AN ANTICHOLINERGIC, A CORTICOSTEROID AND A BETA-ADRENERGIC
A61K 45/06 (2006.01)	3689379	A PROCESS FOR PREPARING A DRY POWDER FORMULATION COMPRISING AN ANTICHOLINERGIC, A CORTICOSTEROID AND A BETA-ADRENERGIC
A61K 47/12 (2006.01)	3689379	A PROCESS FOR PREPARING A DRY POWDER FORMULATION COMPRISING AN ANTICHOLINERGIC, A CORTICOSTEROID AND A BETA-ADRENERGIC
A61K 47/26 (2006.01)	3689379	A PROCESS FOR PREPARING A DRY POWDER FORMULATION COMPRISING AN ANTICHOLINERGIC, A CORTICOSTEROID AND A BETA-ADRENERGIC

MKP (51)	Broj objave evropske prijava patenta (97)	Naziv pronalaska (54)
A61P 11/00 (2006.01)	3689379	A PROCESS FOR PREPARING A DRY POWDER FORMULATION COMPRISING AN ANTICHOLINERGIC, A CORTICOSTEROID AND A BETA-ADRENERGIC
A61P 11/06 (2006.01)	3689379	A PROCESS FOR PREPARING A DRY POWDER FORMULATION COMPRISING AN ANTICHOLINERGIC, A CORTICOSTEROID AND A BETA-ADRENERGIC
A61P 11/08 (2006.01)	3689379	A PROCESS FOR PREPARING A DRY POWDER FORMULATION COMPRISING AN ANTICHOLINERGIC, A CORTICOSTEROID AND A BETA-ADRENERGIC
A61P 29/00 (2006.01)	3689379	A PROCESS FOR PREPARING A DRY POWDER FORMULATION COMPRISING AN ANTICHOLINERGIC, A CORTICOSTEROID AND A BETA-ADRENERGIC
A61P 43/00 (2006.01)	3689379	A PROCESS FOR PREPARING A DRY POWDER FORMULATION COMPRISING AN ANTICHOLINERGIC, A CORTICOSTEROID AND A BETA-ADRENERGIC
A61J 1/10 (2006.01)	3701928	STERILE OR STERILIZED PACKAGE FOR ADMINISTRATION OF MEDICINAL OR NUTRITIONAL SUBSTANCES
A61J 1/14 (2006.01)	3701928	STERILE OR STERILIZED PACKAGE FOR ADMINISTRATION OF MEDICINAL OR NUTRITIONAL SUBSTANCES
A61J 1/20 (2006.01)	3701928	STERILE OR STERILIZED PACKAGE FOR ADMINISTRATION OF MEDICINAL OR NUTRITIONAL SUBSTANCES
F28D 1/053 (2006.01)	3702717	HEAD FOR THERMAL RADIATORS AND METHOD FOR MAKING THE HEAD
F28F 9/26 (2006.01)	3702717	HEAD FOR THERMAL RADIATORS AND METHOD FOR MAKING THE HEAD
F28F 21/08 (2006.01)	3702717	HEAD FOR THERMAL RADIATORS AND METHOD FOR MAKING THE HEAD
B01D 3/10 (2006.01)	3738957	METHOD FOR ACETYLATION OF CANNABINOIDS
B01D 3/14 (2006.01)	3738957	METHOD FOR ACETYLATION OF CANNABINOIDS
B01D 3/34 (2006.01)	3738957	METHOD FOR ACETYLATION OF CANNABINOIDS
B01D 11/04 (2006.01)	3738957	METHOD FOR ACETYLATION OF CANNABINOIDS
C07D 311/82 (2006.01)	3738957	METHOD FOR ACETYLATION OF CANNABINOIDS
A61K 45/06 (2006.01)	3739048	ANGIOTENSINOGEN (AGT) IRNA COMPOSITIONS AND METHODS OF USE THEREOF
A61K 47/54 (2017.01)	3739048	ANGIOTENSINOGEN (AGT) IRNA COMPOSITIONS AND METHODS OF USE THEREOF
A61P 9/00 (2006.01)	3739048	ANGIOTENSINOGEN (AGT) IRNA COMPOSITIONS AND METHODS OF USE THEREOF
C12N 15/113 (2010.01)	3739048	ANGIOTENSINOGEN (AGT) IRNA COMPOSITIONS AND METHODS OF USE THEREOF
C07K 16/00 (2006.01)	3738979	INERT FORMAT
C07K 16/10 (2006.01)	3738979	INERT FORMAT
C07K 16/28 (2006.01)	3738979	INERT FORMAT
C07K 16/32 (2006.01)	3738979	INERT FORMAT
A61K 31/7068 (2006.01)	3738595	COMBINATION THERAPY
A61P 35/00 (2006.01)	3738595	COMBINATION THERAPY
A61P 25/28 (2006.01)	3721942	ANTIBODIES TO AMYLOID BETA
C07K 16/18 (2006.01)	3721942	ANTIBODIES TO AMYLOID BETA
A61K 38/00 (2006.01)	3721892	METHODS AND COMPOSITIONS FOR TREATMENT OF DISORDERS WITH FOLLISTATIN POLYPEPTIDES
A61K 38/16 (2006.01)	3721892	METHODS AND COMPOSITIONS FOR TREATMENT OF DISORDERS WITH FOLLISTATIN POLYPEPTIDES
A61K 38/17 (2006.01)	3721892	METHODS AND COMPOSITIONS FOR TREATMENT OF DISORDERS WITH FOLLISTATIN POLYPEPTIDES
A61P 21/00 (2006.01)	3721892	METHODS AND COMPOSITIONS FOR TREATMENT OF DISORDERS WITH FOLLISTATIN POLYPEPTIDES
A61P 21/04 (2006.01)	3721892	METHODS AND COMPOSITIONS FOR TREATMENT OF DISORDERS WITH FOLLISTATIN POLYPEPTIDES
A61P 21/06 (2006.01)	3721892	METHODS AND COMPOSITIONS FOR TREATMENT OF DISORDERS WITH FOLLISTATIN POLYPEPTIDES
C07K 14/47 (2006.01)	3721892	METHODS AND COMPOSITIONS FOR TREATMENT OF DISORDERS WITH FOLLISTATIN POLYPEPTIDES
C07K 19/00 (2006.01)	3721892	METHODS AND COMPOSITIONS FOR TREATMENT OF DISORDERS WITH FOLLISTATIN POLYPEPTIDES
C12N 15/62 (2006.01)	3721892	METHODS AND COMPOSITIONS FOR TREATMENT OF DISORDERS WITH FOLLISTATIN POLYPEPTIDES
C12M 1/04 (2006.01)	3730608	PROCESSES FOR PRODUCTION OF TUMOR INFILTRATING LYMPHOCYTES AND USES OF SAME IN IMMUNOTHERAPY
C12N 5/0783 (2010.01)	3730608	PROCESSES FOR PRODUCTION OF TUMOR INFILTRATING LYMPHOCYTES AND USES OF SAME IN IMMUNOTHERAPY

MKP (51)	Broj objave evropske prijava patenta (97)	Naziv pronalaska (54)
C12M 1/04 (2006.01)	3722415	PROCESSES FOR PRODUCTION OF TUMOR INFILTRATING LYMPHOCYTES AND USES OF SAME IN IMMUNOTHERAPY
C12N 5/0783 (2010.01)	3722415	PROCESSES FOR PRODUCTION OF TUMOR INFILTRATING LYMPHOCYTES AND USES OF SAME IN IMMUNOTHERAPY
F41A 3/44 (2006.01)	3686541	HANDGUN WITH A LOCKING DEVICE
F41A 5/02 (2006.01)	3686541	HANDGUN WITH A LOCKING DEVICE
A61K 31/517 (2006.01)	3719014	SOLID FORMS OF AN AKT INHIBITING PYRIMIDINYL-CYCLOPENTANE COMPOUND, COMPOSITIONS AND METHODS THEREOF
C07D 403/04 (2006.01)	3719014	SOLID FORMS OF AN AKT INHIBITING PYRIMIDINYL-CYCLOPENTANE COMPOUND, COMPOSITIONS AND METHODS THEREOF
B66B 5/00 (2006.01)	3733582	SHAFT SEPARATION ELEMENT
A61K 31/7125 (2006.01)	3730618	RNAI AGENTS, COMPOSITIONS AND METHODS OF USE THEREOF FOR TREATING TRANSTHYRETIN (TTR) ASSOCIATED DISEASES
C12N 15/113 (2010.01)	3730618	RNAI AGENTS, COMPOSITIONS AND METHODS OF USE THEREOF FOR TREATING TRANSTHYRETIN (TTR) ASSOCIATED DISEASES
A61K 31/519 (2006.01)	3722297	TOLL-LIKE RECEPTOR MODULATING 4,6-DIAMINO-PYRIDO[3,2-D]PYRIMIDINE COMPOUNDS
A61P 31/18 (2006.01)	3722297	TOLL-LIKE RECEPTOR MODULATING 4,6-DIAMINO-PYRIDO[3,2-D]PYRIMIDINE COMPOUNDS
A61P 31/20 (2006.01)	3722297	TOLL-LIKE RECEPTOR MODULATING 4,6-DIAMINO-PYRIDO[3,2-D]PYRIMIDINE COMPOUNDS
A61P 35/00 (2006.01)	3722297	TOLL-LIKE RECEPTOR MODULATING 4,6-DIAMINO-PYRIDO[3,2-D]PYRIMIDINE COMPOUNDS
C07D 471/04 (2006.01)	3722297	TOLL-LIKE RECEPTOR MODULATING 4,6-DIAMINO-PYRIDO[3,2-D]PYRIMIDINE COMPOUNDS
A01K 67/027 (2006.01)	3733701	A NOVEL IL33 FORM, MUTATED FORMS OF IL33, ANTIBODIES, ASSAYS AND METHODS OF USING THE SAME
A61K 39/00 (2006.01)	3733701	A NOVEL IL33 FORM, MUTATED FORMS OF IL33, ANTIBODIES, ASSAYS AND METHODS OF USING THE SAME
A61K 39/395 (2006.01)	3733701	A NOVEL IL33 FORM, MUTATED FORMS OF IL33, ANTIBODIES, ASSAYS AND METHODS OF USING THE SAME
A61P 11/06 (2006.01)	3733701	A NOVEL IL33 FORM, MUTATED FORMS OF IL33, ANTIBODIES, ASSAYS AND METHODS OF USING THE SAME
C07K 14/54 (2006.01)	3733701	A NOVEL IL33 FORM, MUTATED FORMS OF IL33, ANTIBODIES, ASSAYS AND METHODS OF USING THE SAME
C07K 14/715 (2006.01)	3733701	A NOVEL IL33 FORM, MUTATED FORMS OF IL33, ANTIBODIES, ASSAYS AND METHODS OF USING THE SAME
C07K 16/24 (2006.01)	3733701	A NOVEL IL33 FORM, MUTATED FORMS OF IL33, ANTIBODIES, ASSAYS AND METHODS OF USING THE SAME
A01N 43/50 (2006.01)	3733664	ANTIPARASITIC AND PESTICIDAL ISOXAZOLINE COMPOUNDS
A01N 43/54 (2006.01)	3733664	ANTIPARASITIC AND PESTICIDAL ISOXAZOLINE COMPOUNDS
A01N 43/60 (2006.01)	3733664	ANTIPARASITIC AND PESTICIDAL ISOXAZOLINE COMPOUNDS
A61P 33/00 (2006.01)	3733664	ANTIPARASITIC AND PESTICIDAL ISOXAZOLINE COMPOUNDS
C07D 413/10 (2006.01)	3733664	ANTIPARASITIC AND PESTICIDAL ISOXAZOLINE COMPOUNDS
C07D 413/12 (2006.01)	3733664	ANTIPARASITIC AND PESTICIDAL ISOXAZOLINE COMPOUNDS
A61K 38/00 (2006.01)	3712165	NOVEL PEPTIDES AND COMBINATION OF PEPTIDES FOR USE IN IMMUNOTHERAPY AGAINST OVARIAN CANCER AND OTHER CANCERS
C07K 14/47 (2006.01)	3712165	NOVEL PEPTIDES AND COMBINATION OF PEPTIDES FOR USE IN IMMUNOTHERAPY AGAINST OVARIAN CANCER AND OTHER CANCERS
A61K 39/00 (2006.01)	3708185	NOVEL IMMUNOTHERAPY AGAINST SEVERAL TUMORS OF THE BLOOD, IN PARTICULAR CHRONIC LYMPHOID LEUKEMIA (CLL)
A61P 35/02 (2006.01)	3708185	NOVEL IMMUNOTHERAPY AGAINST SEVERAL TUMORS OF THE BLOOD, IN PARTICULAR CHRONIC LYMPHOID LEUKEMIA (CLL)
A61K 35/39 (2015.01)	3747450	PHARMACEUTICAL COMPOSITION CONSISTING OF BLAUTIA, FOR ORAL ADMINISTRATION
A61K 35/74 (2015.01)	3747450	PHARMACEUTICAL COMPOSITION CONSISTING OF BLAUTIA, FOR ORAL ADMINISTRATION
A61K 38/46 (2006.01)	3747450	PHARMACEUTICAL COMPOSITION CONSISTING OF BLAUTIA, FOR ORAL ADMINISTRATION
A61K 38/04 (2006.01)	3715357	NOVEL PEPTIDES AND COMBINATION OF PEPTIDES FOR USE IN IMMUNOTHERAPY AGAINST HEPATOCELLULAR CARCINOMA (HCC) AND OTHER CANCERS
A61K 39/00 (2006.01)	3715357	NOVEL PEPTIDES AND COMBINATION OF PEPTIDES FOR USE IN IMMUNOTHERAPY AGAINST HEPATOCELLULAR CARCINOMA (HCC) AND OTHER CANCERS

MKP (51)	Broj objave evropske prijava patenta (97)	Naziv pronalaska (54)
A61P 35/00 (2006.01)	3715357	NOVEL PEPTIDES AND COMBINATION OF PEPTIDES FOR USE IN IMMUNOTHERAPY AGAINST HEPATOCELLULAR CARCINOMA (HCC) AND OTHER CANCERS
C07K 7/08 (2006.01)	3715357	NOVEL PEPTIDES AND COMBINATION OF PEPTIDES FOR USE IN IMMUNOTHERAPY AGAINST HEPATOCELLULAR CARCINOMA (HCC) AND OTHER CANCERS
C12Q 1/6886 (2018.01)	3744861	A METHYLATION CLASSIFIER FOR DETECTION OF HPV-INDUCED INVASIVE CANCERS, NONHPV- INDUCED GYNAECOLOGICAL AND ANOGENITAL CANCERS AND THEIR HIGH-GRADE PRECURSOR LESIONS
A01N 51/00 (2006.01)	3753927	COMPOSITIONS AND METHODS FOR TREATING CNS DISORDERS
A61P 25/00 (2006.01)	3753927	COMPOSITIONS AND METHODS FOR TREATING CNS DISORDERS
C07D 231/14 (2006.01)	3753927	COMPOSITIONS AND METHODS FOR TREATING CNS DISORDERS
C07D 295/033 (2006.01)	3753927	COMPOSITIONS AND METHODS FOR TREATING CNS DISORDERS
C12N 15/85 (2006.01)	3722433	PROMOTER AND REGULATORY ELEMENTS FOR IMPROVED EXPRESSION OF HETEROLOGOUS GENES IN HOST CELLS
A61K 39/00 (2006.01)	3725327	PEPTIDES AND COMBINATION THEREOF FOR USE IN THE IMMUNOTHERAPY AGAINST CANCERS
A61P 35/00 (2006.01)	3725327	PEPTIDES AND COMBINATION THEREOF FOR USE IN THE IMMUNOTHERAPY AGAINST CANCERS
C07K 14/47 (2006.01)	3725327	PEPTIDES AND COMBINATION THEREOF FOR USE IN THE IMMUNOTHERAPY AGAINST CANCERS
G01N 33/50 (2006.01)	3725327	PEPTIDES AND COMBINATION THEREOF FOR USE IN THE IMMUNOTHERAPY AGAINST CANCERS
A61K 39/00 (2006.01)	3736283	NOVEL PEPTIDES AND COMBINATION OF PEPTIDES FOR USE IN IMMUNOTHERAPY AGAINST ESOPHAGEAL CANCER AND OTHER CANCERS
C07K 14/47 (2006.01)	3736283	NOVEL PEPTIDES AND COMBINATION OF PEPTIDES FOR USE IN IMMUNOTHERAPY AGAINST ESOPHAGEAL CANCER AND OTHER CANCERS
C07K 14/635 (2006.01)	3736283	NOVEL PEPTIDES AND COMBINATION OF PEPTIDES FOR USE IN IMMUNOTHERAPY AGAINST ESOPHAGEAL CANCER AND OTHER CANCERS
A61K 31/415 (2006.01)	3722281	A SODIUM SALT OF N-((1,2,3,5,6,7-HEXAHYDRO-S-INDACEN-4-YL)CARBAMOYL)-1-ISOPROPYL-1H-PYRAZOLE-3-SULFONAMIDE
A61P 29/00 (2006.01)	3722281	A SODIUM SALT OF N-((1,2,3,5,6,7-HEXAHYDRO-S-INDACEN-4-YL)CARBAMOYL)-1-ISOPROPYL-1H-PYRAZOLE-3-SULFONAMIDE
C07D 231/18 (2006.01)	3722281	A SODIUM SALT OF N-((1,2,3,5,6,7-HEXAHYDRO-S-INDACEN-4-YL)CARBAMOYL)-1-ISOPROPYL-1H-PYRAZOLE-3-SULFONAMIDE
A61K 38/48 (2006.01)	3744840	PROHEMOSTATIC PROTEINS FOR THE TREATMENT OF BLEEDING
A61P 7/02 (2006.01)	3744840	PROHEMOSTATIC PROTEINS FOR THE TREATMENT OF BLEEDING
A61P 7/04 (2006.01)	3744840	PROHEMOSTATIC PROTEINS FOR THE TREATMENT OF BLEEDING
A61P 43/00 (2006.01)	3744840	PROHEMOSTATIC PROTEINS FOR THE TREATMENT OF BLEEDING
C07K 14/46 (2006.01)	3744840	PROHEMOSTATIC PROTEINS FOR THE TREATMENT OF BLEEDING
C12N 9/64 (2006.01)	3744840	PROHEMOSTATIC PROTEINS FOR THE TREATMENT OF BLEEDING
A61K 38/05 (2006.01)	3753567	CD40L-SPECIFIC TN3-DERIVED SCAFFOLDS AND METHODS OF USE THEREOF
A61P 1/04 (2006.01)	3753567	CD40L-SPECIFIC TN3-DERIVED SCAFFOLDS AND METHODS OF USE THEREOF
A61P 3/10 (2006.01)	3753567	CD40L-SPECIFIC TN3-DERIVED SCAFFOLDS AND METHODS OF USE THEREOF
A61P 5/14 (2006.01)	3753567	CD40L-SPECIFIC TN3-DERIVED SCAFFOLDS AND METHODS OF USE THEREOF
A61P 5/38 (2006.01)	3753567	CD40L-SPECIFIC TN3-DERIVED SCAFFOLDS AND METHODS OF USE THEREOF
A61P 7/00 (2006.01)	3753567	CD40L-SPECIFIC TN3-DERIVED SCAFFOLDS AND METHODS OF USE THEREOF
A61P 7/06 (2006.01)	3753567	CD40L-SPECIFIC TN3-DERIVED SCAFFOLDS AND METHODS OF USE THEREOF
A61P 9/00 (2006.01)	3753567	CD40L-SPECIFIC TN3-DERIVED SCAFFOLDS AND METHODS OF USE THEREOF
A61P 9/10 (2006.01)	3753567	CD40L-SPECIFIC TN3-DERIVED SCAFFOLDS AND METHODS OF USE THEREOF

MKP (51)	Broj objave evropske prijava patenta (97)	Naziv pronalaska (54)
A61P 11/00 (2006.01)	3753567	CD40L-SPECIFIC TN3-DERIVED SCAFFOLDS AND METHODS OF USE THEREOF
A61P 13/12 (2006.01)	3753567	CD40L-SPECIFIC TN3-DERIVED SCAFFOLDS AND METHODS OF USE THEREOF
A61P 15/00 (2006.01)	3753567	CD40L-SPECIFIC TN3-DERIVED SCAFFOLDS AND METHODS OF USE THEREOF
A61P 17/00 (2006.01)	3753567	CD40L-SPECIFIC TN3-DERIVED SCAFFOLDS AND METHODS OF USE THEREOF
A61P 17/06 (2006.01)	3753567	CD40L-SPECIFIC TN3-DERIVED SCAFFOLDS AND METHODS OF USE THEREOF
A61P 17/14 (2006.01)	3753567	CD40L-SPECIFIC TN3-DERIVED SCAFFOLDS AND METHODS OF USE THEREOF
A61P 19/00 (2006.01)	3753567	CD40L-SPECIFIC TN3-DERIVED SCAFFOLDS AND METHODS OF USE THEREOF
A61P 19/02 (2006.01)	3753567	CD40L-SPECIFIC TN3-DERIVED SCAFFOLDS AND METHODS OF USE THEREOF
A61P 21/02 (2006.01)	3753567	CD40L-SPECIFIC TN3-DERIVED SCAFFOLDS AND METHODS OF USE THEREOF
A61P 21/04 (2006.01)	3753567	CD40L-SPECIFIC TN3-DERIVED SCAFFOLDS AND METHODS OF USE THEREOF
C07K 14/78 (2006.01)	3753567	CD40L-SPECIFIC TN3-DERIVED SCAFFOLDS AND METHODS OF USE THEREOF
C07K 16/28 (2006.01)	3753567	CD40L-SPECIFIC TN3-DERIVED SCAFFOLDS AND METHODS OF USE THEREOF
A61K 9/16 (2006.01)	3725778	FORMULATIONS OF ENZALUTAMIDE
A61K 31/4164 (2006.01)	3725778	FORMULATIONS OF ENZALUTAMIDE
A61K 31/4166 (2006.01)	3725778	FORMULATIONS OF ENZALUTAMIDE
A61P 13/08 (2006.01)	3725778	FORMULATIONS OF ENZALUTAMIDE
A61P 15/00 (2006.01)	3725778	FORMULATIONS OF ENZALUTAMIDE
A61P 15/08 (2006.01)	3725778	FORMULATIONS OF ENZALUTAMIDE
A61P 15/14 (2006.01)	3725778	FORMULATIONS OF ENZALUTAMIDE
A61P 35/00 (2006.01)	3725778	FORMULATIONS OF ENZALUTAMIDE
A61P 43/00 (2006.01)	3725778	FORMULATIONS OF ENZALUTAMIDE
C07D 233/86 (2006.01)	3725778	FORMULATIONS OF ENZALUTAMIDE
C12C 1/02 (2006.01)	3736321	REFINED CEREAL-BASED BEVERAGES
C12C 1/027 (2006.01)	3736321	REFINED CEREAL-BASED BEVERAGES
C12C 1/047 (2006.01)	3736321	REFINED CEREAL-BASED BEVERAGES
C12C 7/047 (2006.01)	3736321	REFINED CEREAL-BASED BEVERAGES
A01K 7/06 (2006.01)	3747265	LIQUID SELF-DISPENSING DEVICE FOR SMALL ANIMALS
A01M 25/00 (2006.01)	3747265	LIQUID SELF-DISPENSING DEVICE FOR SMALL ANIMALS
A61K 31/45 (2006.01)	3725785	GLUTARIMIDE DERIVATIVES, USE THEREOF, PHARMACEUTICAL COMPOSITION BASED THEREON AND METHODS FOR PRODUCING GLUTARIMIDE DERIVATIVES
A61P 11/02 (2006.01)	3725785	GLUTARIMIDE DERIVATIVES, USE THEREOF, PHARMACEUTICAL COMPOSITION BASED THEREON AND METHODS FOR PRODUCING GLUTARIMIDE DERIVATIVES
A61P 31/16 (2006.01)	3725785	GLUTARIMIDE DERIVATIVES, USE THEREOF, PHARMACEUTICAL COMPOSITION BASED THEREON AND METHODS FOR PRODUCING GLUTARIMIDE DERIVATIVES
C07D 401/06 (2006.01)	3725785	GLUTARIMIDE DERIVATIVES, USE THEREOF, PHARMACEUTICAL COMPOSITION BASED THEREON AND METHODS FOR PRODUCING GLUTARIMIDE DERIVATIVES
A61K 31/45 (2006.01)	3722290	GLUTARIMIDE DERIVATIVES, USE THEREOF, PHARMACEUTICAL COMPOSITION BASED THEREON AND METHODS FOR PRODUCING GLUTARIMIDE DERIVATIVES
A61P 11/02 (2006.01)	3722290	GLUTARIMIDE DERIVATIVES, USE THEREOF, PHARMACEUTICAL COMPOSITION BASED THEREON AND METHODS FOR PRODUCING GLUTARIMIDE DERIVATIVES
A61P 31/16 (2006.01)	3722290	GLUTARIMIDE DERIVATIVES, USE THEREOF, PHARMACEUTICAL COMPOSITION BASED THEREON AND METHODS FOR PRODUCING GLUTARIMIDE DERIVATIVES
C07D 401/06 (2006.01)	3722290	GLUTARIMIDE DERIVATIVES, USE THEREOF, PHARMACEUTICAL COMPOSITION BASED THEREON AND METHODS FOR PRODUCING GLUTARIMIDE DERIVATIVES
A61K 38/48 (2006.01)	3753570	NOVEL IMMUNOTHERAPY AGAINST SEVERAL TUMORS INCLUDING GASTROINTESTINAL AND GASTRIC CANCER
A61K 39/00 (2006.01)	3753570	NOVEL IMMUNOTHERAPY AGAINST SEVERAL TUMORS INCLUDING GASTROINTESTINAL AND GASTRIC CANCER
A61P 35/00 (2006.01)	3753570	NOVEL IMMUNOTHERAPY AGAINST SEVERAL TUMORS INCLUDING GASTROINTESTINAL AND GASTRIC CANCER

MKP (51)	Broj objave evropske prijava patenta (97)	Naziv pronalaska (54)
C07K 7/06 (2006.01)	3753570	NOVEL IMMUNOTHERAPY AGAINST SEVERAL TUMORS INCLUDING GASTROINTESTINAL AND GASTRIC CANCER
C07K 7/08 (2006.01)	3753570	NOVEL IMMUNOTHERAPY AGAINST SEVERAL TUMORS INCLUDING GASTROINTESTINAL AND GASTRIC CANCER
G01N 33/50 (2006.01)	3753570	NOVEL IMMUNOTHERAPY AGAINST SEVERAL TUMORS INCLUDING GASTROINTESTINAL AND GASTRIC CANCER
A61K 39/00 (2006.01)	3760225	NOVEL PEPTIDES AND COMBINATION OF PEPTIDES FOR USE IN IMMUNOTHERAPY AGAINST LUNG CANCER, INCLUDING NSCLC AND OTHER CANCERS
A61P 35/00 (2006.01)	3760225	NOVEL PEPTIDES AND COMBINATION OF PEPTIDES FOR USE IN IMMUNOTHERAPY AGAINST LUNG CANCER, INCLUDING NSCLC AND OTHER CANCERS
C07K 14/47 (2006.01)	3760225	NOVEL PEPTIDES AND COMBINATION OF PEPTIDES FOR USE IN IMMUNOTHERAPY AGAINST LUNG CANCER, INCLUDING NSCLC AND OTHER CANCERS
C07K 16/00 (2006.01)	3760225	NOVEL PEPTIDES AND COMBINATION OF PEPTIDES FOR USE IN IMMUNOTHERAPY AGAINST LUNG CANCER, INCLUDING NSCLC AND OTHER CANCERS
A61K 39/00 (2006.01)	3750557	NOVEL PEPTIDES AND COMBINATION OF PEPTIDES FOR USE IN IMMUNOTHERAPY AGAINST LUNG CANCER, INCLUDING NSCLC AND OTHER CANCERS
A61P 35/00 (2006.01)	3750557	NOVEL PEPTIDES AND COMBINATION OF PEPTIDES FOR USE IN IMMUNOTHERAPY AGAINST LUNG CANCER, INCLUDING NSCLC AND OTHER CANCERS
C07K 14/47 (2006.01)	3750557	NOVEL PEPTIDES AND COMBINATION OF PEPTIDES FOR USE IN IMMUNOTHERAPY AGAINST LUNG CANCER, INCLUDING NSCLC AND OTHER CANCERS
A61K 39/00 (2006.01)	3750558	NOVEL PEPTIDES AND COMBINATION OF PEPTIDES FOR USE IN IMMUNOTHERAPY AGAINST LUNG CANCER, INCLUDING NSCLC AND OTHER CANCERS
A61P 35/00 (2006.01)	3750558	NOVEL PEPTIDES AND COMBINATION OF PEPTIDES FOR USE IN IMMUNOTHERAPY AGAINST LUNG CANCER, INCLUDING NSCLC AND OTHER CANCERS
C07K 14/47 (2006.01)	3750558	NOVEL PEPTIDES AND COMBINATION OF PEPTIDES FOR USE IN IMMUNOTHERAPY AGAINST LUNG CANCER, INCLUDING NSCLC AND OTHER CANCERS
A61K 39/00 (2006.01)	3750559	NOVEL PEPTIDES AND COMBINATION OF PEPTIDES FOR USE IN IMMUNOTHERAPY AGAINST LUNG CANCER, INCLUDING NSCLC AND OTHER CANCERS
A61P 35/00 (2006.01)	3750559	NOVEL PEPTIDES AND COMBINATION OF PEPTIDES FOR USE IN IMMUNOTHERAPY AGAINST LUNG CANCER, INCLUDING NSCLC AND OTHER CANCERS
C07K 14/47 (2006.01)	3750559	NOVEL PEPTIDES AND COMBINATION OF PEPTIDES FOR USE IN IMMUNOTHERAPY AGAINST LUNG CANCER, INCLUDING NSCLC AND OTHER CANCERS
A61K 38/17 (2006.01)	3738606	NOVEL IMMUNOTHERAPY AGAINST SEVERAL TUMORS INCLUDING GASTROINTESTINAL AND GASTRIC CANCER
A61K 38/39 (2006.01)	3738606	NOVEL IMMUNOTHERAPY AGAINST SEVERAL TUMORS INCLUDING GASTROINTESTINAL AND GASTRIC CANCER
A61K 39/00 (2006.01)	3738606	NOVEL IMMUNOTHERAPY AGAINST SEVERAL TUMORS INCLUDING GASTROINTESTINAL AND GASTRIC CANCER
A61P 35/00 (2006.01)	3738606	NOVEL IMMUNOTHERAPY AGAINST SEVERAL TUMORS INCLUDING GASTROINTESTINAL AND GASTRIC CANCER
C07K 7/06 (2006.01)	3738606	NOVEL IMMUNOTHERAPY AGAINST SEVERAL TUMORS INCLUDING GASTROINTESTINAL AND GASTRIC CANCER
C07K 7/08 (2006.01)	3738606	NOVEL IMMUNOTHERAPY AGAINST SEVERAL TUMORS INCLUDING GASTROINTESTINAL AND GASTRIC CANCER
G01N 33/50 (2006.01)	3738606	NOVEL IMMUNOTHERAPY AGAINST SEVERAL TUMORS INCLUDING GASTROINTESTINAL AND GASTRIC CANCER
A61B 17/00 (2006.01)	3738531	ULTRASONICALLY POWERED SURGICAL INSTRUMENTS WITH ROTATING CUTTING IMPLEMENT
A61B 17/32 (2006.01)	3738531	ULTRASONICALLY POWERED SURGICAL INSTRUMENTS WITH ROTATING CUTTING IMPLEMENT
A61B 17/3207 (2006.01)	3738531	ULTRASONICALLY POWERED SURGICAL INSTRUMENTS WITH ROTATING CUTTING IMPLEMENT
A61K 31/4709 (2006.01)	3736270	MODULATORS OF THE CYSTIC FIBROSIS TRANSMEMBRANE CONDUCTANCE REGULATOR PROTEIN AND METHODS OF USE
A61P 11/00 (2006.01)	3736270	MODULATORS OF THE CYSTIC FIBROSIS TRANSMEMBRANE CONDUCTANCE REGULATOR PROTEIN AND METHODS OF USE

MKP (51)	Broj objave evropske prijava patenta (97)	Naziv pronalaska (54)
C07C 311/45 (2006.01)	3736270	MODULATORS OF THE CYSTIC FIBROSIS TRANSMEMBRANE CONDUCTANCE REGULATOR PROTEIN AND METHODS OF USE
C07D 213/64 (2006.01)	3736270	MODULATORS OF THE CYSTIC FIBROSIS TRANSMEMBRANE CONDUCTANCE REGULATOR PROTEIN AND METHODS OF USE
C07D 213/71 (2006.01)	3736270	MODULATORS OF THE CYSTIC FIBROSIS TRANSMEMBRANE CONDUCTANCE REGULATOR PROTEIN AND METHODS OF USE
C07D 215/36 (2006.01)	3736270	MODULATORS OF THE CYSTIC FIBROSIS TRANSMEMBRANE CONDUCTANCE REGULATOR PROTEIN AND METHODS OF USE
C07D 231/56 (2006.01)	3736270	MODULATORS OF THE CYSTIC FIBROSIS TRANSMEMBRANE CONDUCTANCE REGULATOR PROTEIN AND METHODS OF USE
C07D 235/28 (2006.01)	3736270	MODULATORS OF THE CYSTIC FIBROSIS TRANSMEMBRANE CONDUCTANCE REGULATOR PROTEIN AND METHODS OF USE
C07D 401/12 (2006.01)	3736270	MODULATORS OF THE CYSTIC FIBROSIS TRANSMEMBRANE CONDUCTANCE REGULATOR PROTEIN AND METHODS OF USE
C07D 471/04 (2006.01)	3736270	MODULATORS OF THE CYSTIC FIBROSIS TRANSMEMBRANE CONDUCTANCE REGULATOR PROTEIN AND METHODS OF USE
A61K 31/4709 (2006.01)	3736267	MODULATORS OF THE CYSTIC FIBROSIS TRANSMEMBRANE CONDUCTANCE REGULATOR PROTEIN AND METHODS OF USE
A61P 11/00 (2006.01)	3736267	MODULATORS OF THE CYSTIC FIBROSIS TRANSMEMBRANE CONDUCTANCE REGULATOR PROTEIN AND METHODS OF USE
C07C 311/45 (2006.01)	3736267	MODULATORS OF THE CYSTIC FIBROSIS TRANSMEMBRANE CONDUCTANCE REGULATOR PROTEIN AND METHODS OF USE
C07D 213/64 (2006.01)	3736267	MODULATORS OF THE CYSTIC FIBROSIS TRANSMEMBRANE CONDUCTANCE REGULATOR PROTEIN AND METHODS OF USE
C07D 213/71 (2006.01)	3736267	MODULATORS OF THE CYSTIC FIBROSIS TRANSMEMBRANE CONDUCTANCE REGULATOR PROTEIN AND METHODS OF USE
C07D 215/36 (2006.01)	3736267	MODULATORS OF THE CYSTIC FIBROSIS TRANSMEMBRANE CONDUCTANCE REGULATOR PROTEIN AND METHODS OF USE
C07D 231/56 (2006.01)	3736267	MODULATORS OF THE CYSTIC FIBROSIS TRANSMEMBRANE CONDUCTANCE REGULATOR PROTEIN AND METHODS OF USE
C07D 235/28 (2006.01)	3736267	MODULATORS OF THE CYSTIC FIBROSIS TRANSMEMBRANE CONDUCTANCE REGULATOR PROTEIN AND METHODS OF USE
C07D 401/12 (2006.01)	3736267	MODULATORS OF THE CYSTIC FIBROSIS TRANSMEMBRANE CONDUCTANCE REGULATOR PROTEIN AND METHODS OF USE
C07D 471/04 (2006.01)	3736267	MODULATORS OF THE CYSTIC FIBROSIS TRANSMEMBRANE CONDUCTANCE REGULATOR PROTEIN AND METHODS OF USE
C07K 14/705 (2006.01)	3747898	USE OF ICOS-BASED CARs TO ENHANCE ANTITUMOR ACTIVITY AND CAR PERSISTENCE
A61K 31/437 (2006.01)	3757104	SOLID FORMS OF A COMPOUND MODULATING KINASES
A61P 35/00 (2006.01)	3757104	SOLID FORMS OF A COMPOUND MODULATING KINASES
C07D 471/04 (2006.01)	3757104	SOLID FORMS OF A COMPOUND MODULATING KINASES
A61K 31/519 (2006.01)	3757126	METHODS OF TREATING PSORIATIC ARTHRITIS USING IL-17 ANTAGONISTS
A61K 39/395 (2006.01)	3757126	METHODS OF TREATING PSORIATIC ARTHRITIS USING IL-17 ANTAGONISTS
C07K 16/24 (2006.01)	3757126	METHODS OF TREATING PSORIATIC ARTHRITIS USING IL-17 ANTAGONISTS
A61K 31/223 (2006.01)	3750534	MELFLUFEN DOSAGE REGIMENS FOR CANCER
A61K 31/573 (2006.01)	3750534	MELFLUFEN DOSAGE REGIMENS FOR CANCER
A61K 31/56 (2006.01)	3750910	TRITERPENOIDs WITH HIV MATURATION INHIBITORY ACTIVITY
A61K 31/58 (2006.01)	3750910	TRITERPENOIDs WITH HIV MATURATION INHIBITORY ACTIVITY
A61P 31/18 (2006.01)	3750910	TRITERPENOIDs WITH HIV MATURATION INHIBITORY ACTIVITY
C07C 309/65 (2006.01)	3750910	TRITERPENOIDs WITH HIV MATURATION INHIBITORY ACTIVITY
C07F 5/02 (2006.01)	3750910	TRITERPENOIDs WITH HIV MATURATION INHIBITORY ACTIVITY
C07J 63/00 (2006.01)	3750910	TRITERPENOIDs WITH HIV MATURATION INHIBITORY ACTIVITY
A61K 9/00 (2006.01)	3757112	GEMCITABINE PRODRUGS
A61K 9/08 (2006.01)	3757112	GEMCITABINE PRODRUGS
A61K 31/7068 (2006.01)	3757112	GEMCITABINE PRODRUGS
A61K 47/16 (2006.01)	3757112	GEMCITABINE PRODRUGS
A61K 47/20 (2006.01)	3757112	GEMCITABINE PRODRUGS
A61K 47/22 (2006.01)	3757112	GEMCITABINE PRODRUGS
A61P 35/00 (2006.01)	3757112	GEMCITABINE PRODRUGS
C07H 19/10 (2006.01)	3757112	GEMCITABINE PRODRUGS
A61K 31/232 (2006.01)	3750535	METHODS OF REDUCING THE RISK OF CARDIOVASCULAR EVENTS IN A SUBJECT
A61K 31/366 (2006.01)	3750535	METHODS OF REDUCING THE RISK OF CARDIOVASCULAR EVENTS IN A SUBJECT
A61K 31/40 (2006.01)	3750535	METHODS OF REDUCING THE RISK OF CARDIOVASCULAR EVENTS IN A SUBJECT

MKP (51)	Broj objave evropske prijava patenta (97)	Naziv pronalaska (54)
A61K 31/505 (2006.01)	3750535	METHODS OF REDUCING THE RISK OF CARDIOVASCULAR EVENTS IN A SUBJECT
A61K 45/06 (2006.01)	3750535	METHODS OF REDUCING THE RISK OF CARDIOVASCULAR EVENTS IN A SUBJECT
A61P 9/10 (2006.01)	3750535	METHODS OF REDUCING THE RISK OF CARDIOVASCULAR EVENTS IN A SUBJECT
A61K 31/232 (2006.01)	3750536	METHODS OF REDUCING THE RISK OF CARDIOVASCULAR EVENTS IN A SUBJECT
A61K 31/366 (2006.01)	3750536	METHODS OF REDUCING THE RISK OF CARDIOVASCULAR EVENTS IN A SUBJECT
A61K 31/40 (2006.01)	3750536	METHODS OF REDUCING THE RISK OF CARDIOVASCULAR EVENTS IN A SUBJECT
A61K 31/505 (2006.01)	3750536	METHODS OF REDUCING THE RISK OF CARDIOVASCULAR EVENTS IN A SUBJECT
A61K 45/06 (2006.01)	3750536	METHODS OF REDUCING THE RISK OF CARDIOVASCULAR EVENTS IN A SUBJECT
A61P 9/10 (2006.01)	3750536	METHODS OF REDUCING THE RISK OF CARDIOVASCULAR EVENTS IN A SUBJECT
A61K 31/4745 (2006.01)	3760202	INHIBITORS OF (ALPHA-V)(BETA-6) INTEGRIN
A61P 35/00 (2006.01)	3760202	INHIBITORS OF (ALPHA-V)(BETA-6) INTEGRIN
C07D 401/12 (2006.01)	3760202	INHIBITORS OF (ALPHA-V)(BETA-6) INTEGRIN
C07D 471/04 (2006.01)	3760202	INHIBITORS OF (ALPHA-V)(BETA-6) INTEGRIN

INDEKS PODNOSILACA ZAHTJEVA ZA PROŠIRENJE EVROPSKIH PRIJAVA PATENTA

Index on number of applications for extension of european patent application

Podnosilac evropske prijave patenta (71)	MKP (51)	Broj objave evropske prijave patenta (97)	Naziv pronalaska (54)
Limgroup B.V.	A61B 17/00 (2006.01)	3165185	MULTI-HEAD REPOSITORY FOR USE WITH A SURGICAL DEVICE
	A61B 17/34 (2006.01)		
	A61B 17/34 (2006.01)	3165186	SURGICAL END EFFECTOR LOADING DEVICE AND TROCAR INTEGRATION
	A01H 1/02 (2006.01)		
	A01H 1/04 (2006.01)	3242549	SEX DETERMINATION GENES AND THEIR USE IN BREEDING
	A01H 1/06 (2006.01)		
	A01H 5/04 (2006.01)		
	C07K 14/415 (2006.01)		
	C12N 15/82 (2006.01)		
	A61M 5/20 (2006.01)		
Servion GmbH Upton, Daniel E.	A61M 5/28 (2006.01)	3727516	AUTO-INJECTION DRUG DELIVERY DEVICE
	A61M 5/31 (2006.01)		
	A61M 5/315 (2006.01)	3256299	WIND TURBINE ROTOR BLADE COMPONENTS AND MACHINE FOR MAKING SAME
	A61M 5/32 (2006.01)		
	B29B 11/16 (2006.01)		
	B29B 13/10 (2006.01)		
	B29C 70/54 (2006.01)		
	B29D 99/00 (2010.01)		
	B65H 45/00 (2006.01)	3247330	LEVODOPA AND CARBIDOPA INTESTINAL GEL AND METHODS OF USE
	A61K 9/00 (2006.01)		
A61K 9/10 (2006.01)			
A61K 31/195 (2006.01)			
Carreira, Germano Araújo	A61K 31/198 (2006.01)	3627050	PYROLYSIS PLANT
	A61K 47/38 (2006.01)		
	C01B 3/02 (2006.01)		
	C09C 1/48 (2006.01)		
	C10B 47/44 (2006.01)		
	C10B 53/07 (2006.01)		
	C10G 1/10 (2006.01)	3627050	PYROLYSIS PLANT
	C10L 1/00 (2006.01)		
	F23G 5/027 (2006.01)		
	F23G 5/027 (2006.01)		

Podnosilac evropske prijave patenta (71)	MKP (51)	Broj objave evropske prijave patenta (97)	Naziv pronalaska (54)	
Impresa Donelli SRL AMBPR	F23G 5/08 (2006.01)	3643414	AN ULTRA-HIGH-PRESSURE WATER JETTING (UHPWJ) HYDRO-BLASTING CLEANING SYSTEM FOR SURFACES OF VERY LARGE DIMENSIONS AND/OR OF COMPLEX SHAPES AND/OR OF DIFFICULT ACCESS AND/OR WITH A HIGH ELEVATION	
	F23G 7/06 (2006.01)			
	F23G 7/12 (2006.01)			
	F23K 1/04 (2006.01)			
	B08B 3/02 (2006.01)			
Siemens Healthcare GmbH	B08B 9/023 (2006.01)	3624056	PROCESSING IMAGE FRAMES OF A SEQUENCE OF CARDIAC IMAGES	
	A61B 5/0456 (2006.01)			
Koncar - Inzenjering Za Energetiku I Transport D.D. Koncar - Institut Za Elektrotehniku D.D.	G06T 7/246 (2017.01)	3746877	METHOD AND DEVICE FOR DISPLAYING SAFETY UNIT SIGNALS WITH INFORMATION REGARDING RELIABILITY OF DISPLAYED SIGNALS	
	G06F 3/14 (2006.01)			
	G06F 11/16 (2006.01)			
	G06F 11/32 (2006.01)			
	G09G 5/00 (2006.01)			
Rothenbühler, Rudolf Bono, Caroline	F42B 12/10 (2006.01)	3714229	TANDEM-CUMULATIVE SHOT	
	F42B 12/16 (2006.01)			
	F42B 12/18 (2006.01)			
	G06K 9/00 (2006.01)			
Ethicon Endo-Surgery, LLC	G07C 5/08 (2006.01)	3598396	COMPUTER-SUPPORTED METHOD FOR ANALYZING OF PERSONAL ACCIDENT DATA	
	A61B 17/00 (2006.01)			
	H02P 7/03 (2016.01)			
	A61B 17/00 (2006.01)			
	H02P 7/00 (2016.01)			
Ethicon Endo-Surgery, LLC	H02P 7/06 (2006.01)	3154187	SURGICAL STAPLER HAVING DOWNSTREAM CURRENT-BASED MOTOR CONTROL	
	A61B 17/00 (2006.01)			
	H02P 7/00 (2016.01)	3154186	SURGICAL STAPLER HAVING MOTOR CONTROL BASED ON A DRIVE SYSTEM COMPONENT	
	H02P 7/06 (2006.01)			
	A61B 17/00 (2006.01)	3154188	SURGICAL STAPLER HAVING CURRENT MIRROR-BASED MOTOR CONTROL	
	G01R 19/00 (2006.01)			
	H02P 7/29 (2016.01)			
	Ethicon Endo-Surgery, LLC	A61B 17/34 (2006.01)	3150150	ADJUSTABLE ACCESS DEVICE FOR USE WITH SURGICAL INSTRUMENTS
		A61K 31/444 (2006.01)		
		A61P 19/10 (2006.01)	3713927	PYRIDINONE DERIVATIVES AND THEIR USE AS SELECTIVE ALK-2 INHIBITORS
C07D 401/14 (2006.01)				
C07D 405/14 (2006.01)				
C07D 471/04 (2006.01)				
F01N 1/16 (2006.01)		3660290	GAS FLOW AND SOUND CONTROL VALVE AND EXHAUST GAS SYSTEM	
F01N 1/18 (2006.01)				
F01N 13/04 (2010.01)				

Podnosilac evropske prijave patenta (71)	MKP (51)	Broj objave evropske prijave patenta (97)	Naziv pronalaska (54)
Stegemann, Klaus	F01N 13/08 (2010.01)	3659594	A STERILE SOLUTION WITH AN APPLICATION INJECTOR COMPRISING A MEDICAL AGENT AND METHOD FOR PRODUCING SAME
	F16K 1/00 (2006.01)		
	F16K 11/08 (2006.01)		
	A61K 9/08 (2006.01)		
	A61K 31/216 (2006.01)		
	A61M 5/178 (2006.01)		
	C08G 64/02 (2006.01)		
	C08G 64/08 (2006.01)		
	C08G 64/12 (2006.01)		
	C08G 64/14 (2006.01)		
DWI - Leibniz-Institut für Interaktive Materialien e.V.	C08G 64/42 (2006.01)	3666075	ENDCAPPED POLYCARBONATES, METHODS OF MANUFACTURE, AND ARTICLES FORMED THEREFROM
	A61K 9/70 (2006.01)		
	A61K 35/747 (2015.01)		
	A61L 15/00 (2006.01)		
	A61P 17/00 (2006.01)		
Koch, Hilko	A61Q 19/00 (2006.01)	3666341	TOPICAL FORMULATION IN FORM OF A PATCH, A BANDAGE OR A PLASTER COMPRISING PROBIOTIC BACTERIA, AND USE THEREOF IN A METHOD FOR TREATING OR PREVENTING SKIN DISORDERS
	B62B 3/14 (2006.01)		
	B62B 3/16 (2006.01)		
	B62B 5/00 (2006.01)		
Forcam GmbH	G06F 9/54 (2006.01)	3620921	COMPUTER-IMPLEMENTED METHOD, DATA PROCESSING APPARATUS, COMPUTER PROGRAM, AND DATA CARRIER SIGNAL
	H04R (2006.01)		
RP Technik GmbH Profilsysteme	E06B 3/263 (2006.01)	3644620	IN-EAR ANC EARPHONE
	E06B 3/36 (2006.01)		
Promet-Past S.C. Elzbieta Jezewska Andrzej Jezewska Jezewski, Andrzej	A61K 31/165 (2006.01)	3755684	ALCOHOL DERIVATIVES AS KV7 POTASSIUM CHANNEL OPENERS
	A61P 25/14 (2006.01)		
	A61P 25/18 (2006.01)		
	A61P 25/22 (2006.01)		
	A61P 25/24 (2006.01)		
	A61P 25/28 (2006.01)		
	C07C 235/08 (2006.01)		
	C07C 235/40 (2006.01)		
	G01N 33/68 (2006.01)		
	G01N 33/68 (2006.01)		
Promet-Past S.C. Elzbieta Jezewska Andrzej Jezewski, Andrzej	C25B 1/04 (2006.01)	3720990	ARTICLES OF MANUFACTURE AND METHODS RELATED TO TOXICITY ASSOCIATED WITH CELL THERAPY A METHOD OF HYDROGEN AND OXYGEN PRODUCTION BY ELECTROLYSIS METHOD, IN PARTICULAR ELECTROLYSIS OF WATER
	F03D 9/19 (2016.01)		

Podnosilac evropske prijave patenta (71)	MKP (51)	Broj objave evropske prijave patenta (97)	Naziv pronalaska (54)
	H02J 3/32 (2006.01)	3753084	POWER CONTROL SYSTEM
	H02J 9/06 (2006.01)		
	E06B 3/667 (2006.01)	3553267	FITTING
	E06B 3/964 (2006.01)		
	A61K 31/131 (2006.01)	3586861	LIPID NANOPARTICLE COMPOSITIONS AND METHODS FOR MRNA DELIVERY
	A61K 31/132 (2006.01)		
	A61K 31/215 (2006.01)		
	A61K 31/56 (2006.01)		
	A61K 38/00 (2006.01)		
	A61K 38/16 (2006.01)		
	A61K 38/43 (2006.01)		
Biosearch S.A.	A61K 9/48 (2006.01)	3713552	METHOD FOR INCREASING EMBRYO IMPLANTATION RATE IN A FEMALE SUBJECT SUFFERING POLYCYSTIC OVARY SYNDROME
	A61K 31/047 (2006.01)		
	A61P 15/00 (2006.01)		
Entasis Therapeutics, Inc.	A61K 31/439 (2006.01)	3630111	COMPOUNDS AND METHODS FOR TREATING BACTERIAL INFECTIONS
	A61P 31/04 (2006.01)		
	C07D 471/08 (2006.01)		
Madic Italia S.p.A.	G07F 19/00 (2006.01)	3756173	METHOD FOR DETECTING THE PRESENCE OF A SMART CARD CLONING DEVICE IN AN AUTOMATIC PAYMENT AND/OR WITHDRAWAL TERMINAL AND RESPECTIVE AUTOMATIC PAYMENT AND/OR WITHDRAWAL TERMINAL
	A23L 2/42 (2006.01)	3727026	METHOD FOR THE INACTIVATION OF MICROORGANISMS IN FOODS
	A23L 3/015 (2006.01)		
Consejo Superior de Investigaciones Científicas (CSIC)	A61K 31/4045 (2006.01)	3713568	COMBINATION PRODUCT FOR THE TREATMENT OF NEUROLOGICAL AND/OR PSYCHIATRIC DISORDERS
Universidad Autónoma de Madrid	A61K 45/06 (2006.01)		
Centro De Investigación Biomédica En Red De Enfermedades Neurodegenerativas Cibermed	A61P 25/00 (2006.01)		
BlumenTech S.L.			
Institut Recerca Hospital de la Santa Creu i Sant Pau			
V-Shapes S.r.l.	B65B 9/02 (2006.01)	3737619	APPARATUS AND METHOD FOR PRODUCING A SEALED SINGLE-DOSE BREAK-OPEN PACKAGE
	B65D 75/58 (2006.01)		
	A61C 17/20 (2006.01)	3740154	TEETH CLEANING DEVICE AND CARRIER STRUCTURE FOR MOUTHPIECE OF A TEETH CLEANING DEVICE
	A61C 17/22 (2006.01)		
	A61C 17/34 (2006.01)		
	A61K 9/00 (2006.01)	3636250	LONG-ACTING FORMULATIONS OF INSULINS
	A61K 9/08		

Podnosilac evropske prijave patenta (71)	MKP (51)	Broj objave evropske prijave patenta (97)	Naziv pronalaska (54)
DePuy Synthes Products, LLC	(2006.01) A61K 38/22 (2006.01) A61K 38/26 (2006.01) A61K 38/28 (2006.01) A61K 47/02 (2006.01) A61K 47/10 (2017.01) A61K 47/26 (2006.01) A61B 17/04 (2006.01) A61B 17/06 (2006.01) A61K 31/4375 (2006.01) A61K 31/444 (2006.01) A61K 31/519 (2006.01) A61K 31/5377 (2006.01) A61K 31/541 (2006.01) A61P 19/00 (2006.01) A61P 35/00 (2006.01) C07D 471/04 (2006.01)	3593730	ADJUSTABLE LOOP WITH LOCKING KNOT
	A61K 31/4375 (2006.01) A61K 31/444 (2006.01) A61K 31/519 (2006.01) A61K 31/5377 (2006.01) A61K 31/541 (2006.01) A61P 19/00 (2006.01) A61P 35/00 (2006.01) C07D 471/04 (2006.01)	3617205	BICYCLIC HETEROCYCLES AS FGFR INHIBITORS
	A61K 31/7088 (2006.01) A61K 31/7125 (2006.01) A61P 7/00 (2006.01) A61P 7/06 (2006.01) A61P 35/00 (2006.01) A61P 35/02 (2006.01) A61K 35/74 (2015.01) A61K 35/745 (2015.01) A61P 1/00 (2006.01) A61P 11/06 (2006.01) A61P 19/02 (2006.01) A61P 25/28 (2006.01) A61P 29/00 (2006.01) A61P 35/00 (2006.01) C12N 1/20 (2006.01) A61M 5/142 (2006.01) A61M 5/145 (2006.01) A61M 5/20 (2006.01) A61M 5/315	3646876	USE OF TELOMERASE INHIBITORS FOR THE TREATMENT OF MYELOPROLIFERATIVE DISORDERS AND MYELOPROLIFERATIVE NEOPLASMS
	A61K 35/74 (2015.01) A61K 35/745 (2015.01) A61P 1/00 (2006.01) A61P 11/06 (2006.01) A61P 19/02 (2006.01) A61P 25/28 (2006.01) A61P 29/00 (2006.01) A61P 35/00 (2006.01) C12N 1/20 (2006.01) A61M 5/142 (2006.01) A61M 5/145 (2006.01) A61M 5/20 (2006.01) A61M 5/315	3626248	COMPOSITIONS COMPRISING BACTERIAL STRAINS
	A61M 5/142 (2006.01) A61M 5/145 (2006.01) A61M 5/20 (2006.01) A61M 5/315	3583966	SINGLE-USE AUTO-INJECTOR

Podnosilac evropske prijave patenta (71)	MKP (51)	Broj objave evropske prijave patenta (97)	Naziv pronalaska (54)
	(2006.01) A61M 5/32 (2006.01)		
	A61K 31/7125 (2006.01)	3620522	METHODS FOR TREATMENT OF ALPORT SYNDROME
	A61P 13/12 (2006.01)		
	C12N 15/113 (2010.01)		
	F04D 29/54 (2006.01)	3617529	FAN FRAME OF A MOTOR VEHICLE
	A61K 31/4738 (2006.01)	3640251	6,7,8,9-TETRAHYDRO-3H-PYRAZOLO[4,3-F]ISOQUINOLINE DERIVATIVES USEFUL IN THE TREATMENT OF CANCER
	A61K 31/497 (2006.01)		
	A61P 35/00 (2006.01)		
	C07D 471/04 (2006.01)		
	A61K 35/74 (2015.01)	3636272	COMPOSITIONS COMPRISING BACTERIAL STRAINS
	A61K 35/745 (2015.01)		
	A61P 1/00 (2006.01)		
	A61P 11/06 (2006.01)		
	A61P 19/02 (2006.01)		
	A61P 25/28 (2006.01)		
	A61P 29/00 (2006.01)		
	A61P 35/00 (2006.01)		
	C12N 1/20 (2006.01)		
Amgen K-A, Inc.	A61K 39/395 (2006.01)	3632466	ANTI IL-17RA ANTIBODY FORMULATION AND THERAPEUTIC REGIMENS FOR TREATING PSORIASIS
	A61P 17/06 (2006.01)		
	C07K 16/28 (2006.01)		
	B31B 120/40 (2017.01)	3604154	PACKAGING
	B65D 5/56 (2006.01)		
	B65D 77/20 (2006.01)		
Sesen Bio, Inc.	A61K 39/00 (2006.01)	3632931	IMPROVED IL-6 ANTIBODIES
	A61P 27/02 (2006.01)		
	C07K 16/24 (2006.01)		
	A61K 31/519 (2006.01)	3626720	HETEROCYCLIC COMPOUNDS AS LSD1 INHIBITORS
	A61P 35/00 (2006.01)		
	A61P 35/02 (2006.01)		
	C07D 487/04 (2006.01)		
	C07D 519/00 (2006.01)		
	A61K 31/445 (2006.01)	3626714	CYCLOPROPYLAMINES AS LSD1 INHIBITORS
	C07D 211/98 (2006.01)		
	C07D 401/04		

Podnosilac evropske prijave patenta (71)	MKP (51)	Broj objave evropske prijave patenta (97)	Naziv pronalaska (54)
	(2006.01) C07D 401/14 (2006.01) C07D 405/12 (2006.01) C07D 405/14 (2006.01) C07D 413/06 (2006.01) C07D 417/14 (2006.01)		
	C07H 21/00 (2006.01) C12N 1/08 (2006.01) C12N 15/10 (2006.01)	3636742	METHODS FOR PURIFICATION OF MESSENGER RNA
	A61K 31/397 (2006.01) A61K 31/438 (2006.01) A61K 31/4427 (2006.01) A61K 31/4439 (2006.01) A61K 31/445 (2006.01) A61K 31/4468 (2006.01) A61K 31/454 (2006.01) A61K 31/4545 (2006.01) A61K 31/496 (2006.01) A61K 31/501 (2006.01) A61K 31/506 (2006.01) C07D 205/04 (2006.01) C07D 211/14 (2006.01) C07D 211/16 (2006.01) C07D 211/58 (2006.01) C07D 401/06 (2006.01) C07D 401/12 (2006.01) C07D 471/10 (2006.01)	3626713	CYCLOPROPYLAMINES AS LSD1 INHIBITORS
	C07D 239/46 (2006.01)	3626710	PROCESSES FOR PREPARING (CYCLOPENTYL[D]PYRIMIDIN-4-YL)PIPERAZINE COMPOUNDS
	B27N 3/00 (2006.01) B27N 3/02 (2006.01) B27N 3/04 (2006.01) B32B 21/02 (2006.01) B32B 21/04 (2006.01) B32B 21/14 (2006.01) C08L 97/02 (2006.01)	3672771	METHOD FOR PRODUCING LIGNOCELLULOSE MATERIALS IN THE PRESENCE OF CAPROLACTAM AND OLIGOMERS OF CAPROLACTAM

Podnosilac evropske prijave patenta (71)	MKP (51)	Broj objave evropske prijave patenta (97)	Naziv pronalaska (54)
Bayer HealthCare LLC	A61K 39/00 (2006.01)	3639851	METHODS AND COMPOSITIONS FOR ENHANCING VACCINE IMMUNE RESPONSES
	A61K 39/12 (2006.01)		
	E05F 11/38 (2006.01)	3743579	DRIVER FOR A VEHICLE WINDOW REGULATOR, AND VEHICLE WINDOW REGULATOR
	E05F 11/48 (2006.01)		
	A61K 31/165 (2006.01)	3723744	C5AR INHIBITORS FOR USE IN THE TREATMENT OF CHEMOTHERAPY-INDUCED IATROGENIC PAIN
	A61K 31/18 (2006.01)		
	A61K 31/381 (2006.01)		
	A61K 31/40 (2006.01)		
	A61K 31/422 (2006.01)		
	A61K 31/427 (2006.01)		
	A61K 31/431 (2006.01)		
	A61K 31/4406 (2006.01)		
	A61K 31/445 (2006.01)		
	A61P 25/02 (2006.01)		
	C12N 5/073 (2010.01)	3728566	MESENCHYMAL STROMAL CELLS AND METHODS FOR OBTAINING MESENCHYMAL STROMAL CELLS FROM UMBILICAL CORD
	C12N 5/0775 (2010.01)		
	A61K 38/17 (2006.01)	3716992	USE OF A VEGF ANTAGONIST TO TREAT ANGIOGENIC EYE DISORDERS
	A61P 27/02 (2006.01)		
	A61P 27/02 (2006.01)	3714055	MATERIALS AND METHODS FOR TREATMENT OF AUTOSOMAL DOMINANT RETINITIS PIGMENTOSA
	C12N 9/22 (2006.01)		
	C12N 15/113 (2010.01)		
	A61K 31/437 (2006.01)	3720855	IMIDAZOPYRIDINE DERIVATIVES AND THE USE THEREOF AS MEDICAMENT
	A61K 31/5377 (2006.01)		
	A61P 25/00 (2006.01)		
	A61P 25/24 (2006.01)		
	C07D 471/04 (2006.01)		
	A61P 13/12 (2006.01)	3717510	POLYOMAVIRUS NEUTRALIZING ANTIBODIES
	C07K 16/08 (2006.01)		
	A61M 5/20 (2006.01)	3723827	MEDICATION DELIVERY DEVICE WITH SYRINGE SENSING SYSTEM
	A61M 5/315 (2006.01)		
A61M 5/32 (2006.01)			
A61K 38/19 (2006.01)	3720469	METHOD OF TREATING IDIOPATHIC THROMBOCYTOPENIA PURPURA (ITP) WITH ROMIPLOSTIM	
A61P 7/04 (2006.01)			
A61K 31/497 (2006.01)	3724176	FUMARATE SALT OF (R)-3-(1-(2,3-DICHLORO-4-(PYRAZIN-2-YL)PHENYL)-2,2,2-TRIFLUOROETHYL)-1-METHYL-1-(1-METHYLPYPERIDIN-4-YL) UREA, METHODS OF PREPARATION, AND USES THEREOF	
A61P 25/30 (2006.01)			

Podnosilac evropske prijave patenta (71)	MKP (51)	Broj objave evropske prijave patenta (97)	Naziv pronalaska (54)
Mabion SA	C07D 401/12 (2006.01) A61K 31/137 (2006.01) A61K 31/225 (2006.01) A61K 31/277 (2006.01) A61P 25/00 (2006.01) C07K 16/28 (2006.01)	3720880	COMBINATION THERAPY OF MULTIPLE SCLEROSIS COMPRISING A CD20 LIGAND
AGROFROST, naamloze vennootschap	A01G 13/06 (2006.01) A01M 21/04 (2006.01)	3723480	A METHOD AND APPARATUS FOR CONTROLLING VEGETATION BY MEANS OF A HEATED GAS
Aeterna Zentaris GmbH	G01N 33/50 (2006.01) G01N 33/74 (2006.01)	3729100	METHOD OF ASSESSING GROWTH HORMONE DEFICIENCY IN HUMANS BY A MACIMORELIN CONTAINING COMPOSITION
Argenx BVBA	A61P 37/06 (2006.01) C07K 16/00 (2006.01) A61K 31/40 (2006.01) A61P 37/00 (2006.01) C07D 207/36 (2006.01) C07D 403/12 (2006.01) A61K 31/437 (2006.01) A61P 9/00 (2006.01) A61P 11/00 (2006.01) C07D 471/04 (2006.01) A61K 31/437 (2006.01) A61P 9/00 (2006.01) A61P 11/00 (2006.01) C07D 471/04 (2006.01) A61K 31/541 (2006.01) A61P 11/00 (2006.01) C07D 471/04 (2006.01) C07D 487/04 (2006.01) C07D 519/00 (2006.01) A61M 31/00 (2006.01)	3720877	USE OF FCRN ANTAGONISTS FOR TREATMENT OF GENERALIZED MYASTHENIA GRAVIS
	A61K 31/40 (2006.01) A61P 37/00 (2006.01) C07D 207/36 (2006.01) C07D 403/12 (2006.01) A61K 31/437 (2006.01) A61P 9/00 (2006.01) A61P 11/00 (2006.01) C07D 471/04 (2006.01) A61K 31/437 (2006.01) A61P 9/00 (2006.01) A61P 11/00 (2006.01) C07D 471/04 (2006.01) A61K 31/541 (2006.01) A61P 11/00 (2006.01) C07D 471/04 (2006.01) C07D 487/04 (2006.01) C07D 519/00 (2006.01) A61M 31/00 (2006.01)	3724182	PYRROLE DERIVATIVES AS ACC INHIBITORS
	A61K 31/437 (2006.01) A61P 9/00 (2006.01) A61P 11/00 (2006.01) C07D 471/04 (2006.01) A61K 31/437 (2006.01) A61P 9/00 (2006.01) A61P 11/00 (2006.01) C07D 471/04 (2006.01) A61K 31/541 (2006.01) A61P 11/00 (2006.01) C07D 471/04 (2006.01) C07D 487/04 (2006.01) C07D 519/00 (2006.01) A61M 31/00 (2006.01)	3728246	META TYROSINE DERIVATIVES AS RHO-KINASE INHIBITORS
	A61K 31/437 (2006.01) A61P 9/00 (2006.01) A61P 11/00 (2006.01) C07D 471/04 (2006.01) A61K 31/437 (2006.01) A61P 9/00 (2006.01) A61P 11/00 (2006.01) C07D 471/04 (2006.01) A61K 31/541 (2006.01) A61P 11/00 (2006.01) C07D 471/04 (2006.01) C07D 487/04 (2006.01) C07D 519/00 (2006.01) A61M 31/00 (2006.01)	3728247	OXADIAZOLE DERIVATIVES AS RHO-KINASE INHIBITORS
	A61K 31/437 (2006.01) A61P 9/00 (2006.01) A61P 11/00 (2006.01) C07D 471/04 (2006.01) A61K 31/541 (2006.01) A61P 11/00 (2006.01) C07D 471/04 (2006.01) C07D 487/04 (2006.01) C07D 519/00 (2006.01) A61M 31/00 (2006.01)	3728248	AZAINDOLE DERIVATIVES AS RHO-KINASE INHIBITORS
Reynolds Presto Products Inc.	B65D 33/25 (2006.01) A61K 38/46 (2006.01) C12N 9/22 (2006.01) C12N 15/10 (2006.01) C12N 15/113 (2010.01)	3720537	LONG ACTING GASTRIC RESIDENCE SYSTEM
	B65D 33/25 (2006.01) A61K 38/46 (2006.01) C12N 9/22 (2006.01) C12N 15/10 (2006.01) C12N 15/113 (2010.01)	3717369	CHILD RESISTANT SLIDER, ZIPPER CLOSURE SYSTEM USING SLIDER, AND METHODS OF USE
	B65D 33/25 (2006.01) A61K 38/46 (2006.01) C12N 9/22 (2006.01) C12N 15/10 (2006.01) C12N 15/113 (2010.01)	3720473	CRISPR-CAS9 MODIFIED CD34+ HUMAN HEMATOPOIETIC STEM AND PROGENITOR CELLS AND USES THEREOF

Podnosilac evropske prijave patenta (71)	MKP (51)	Broj objave evropske prijave patenta (97)	Naziv pronalaska (54)
The United States of America, as represented by the Secretary, Department of Health and Human Services	A61K 31/51 (2006.01)	3720859	POSITIVE ALLOSTERIC MODULATORS OF THE MUSCARINIC ACETYLCHOLINE RECEPTOR M4
	A61P 25/00 (2006.01)		
	C07D 495/14 (2006.01)	3720860	POSITIVE ALLOSTERIC MODULATORS OF THE MUSCARINIC ACETYLCHOLINE RECEPTOR M4
	A61K 31/519 (2006.01)		
	A61P 25/00 (2006.01)		
	C07D 495/14 (2006.01)		
	C07D 231/20 (2006.01)	3720849	PROCESSES FOR MAKING MODULATORS OF CYSTIC FIBROSIS TRANSMEMBRANE CONDUCTANCE REGULATOR
	C07D 401/04 (2006.01)		
	C07D 401/14 (2006.01)		
	C07D 405/04 (2006.01)		
	C12N 5/0783 (2010.01)	3720949	SERUM-FREE MEDIA FORMULATION FOR CULTURING CELLS AND METHODS OF USE THEREOF
	A61K 39/00 (2006.01)	3724228	ANTI-ALPHA SYNUCLEIN ANTIBODIES
	A61K 39/395 (2006.01)	3724224	ANTI-ALPHA-SYNUCLEIN ANTIBODIES
	A61P 25/16 (2006.01)		
	A61P 25/28 (2006.01)		
	C07K 16/28 (2006.01)		
	C07K 16/18 (2006.01)		
	A61K 39/395 (2006.01)		
	A61K 45/06 (2006.01)	3720478	HLA CLASS I-RESTRICTED T CELL RECEPTORS AGAINST MUTATED RAS
	A61P 35/00 (2006.01)		
	C07K 16/28 (2006.01)		
	A61K 38/17 (2006.01)		
	A61K 39/00 (2006.01)		
	C07K 14/47 (2006.01)		
	C07K 14/725 (2006.01)	3720874	PROCESS FOR PRODUCING A COMPOSITION OF ENGINEERED T CELLS
	A61K 35/17 (2015.01)		
	C07K 14/725 (2006.01)		
	C12N 5/0783 (2010.01)		
	A61K 31/437 (2006.01)	3723807	COMBINATION TREATMENTS COMPRISING ADMINISTRATION OF 1H-PYRAZOLO[4,3-B]PYRIDINES
	A61K 31/444 (2006.01)		
	A61K 31/497 (2006.01)		
	A61K 31/506 (2006.01)		
A61K 45/06 (2006.01)			
A61P 25/00 (2006.01)			
A61P 25/18			

Podnosilac evropske prijave patenta (71)	MKP (51)	Broj objave evropske prijave patenta (97)	Naziv pronalaska (54)
	(2006.01) A61P 25/22 (2006.01) A61P 25/24 (2006.01) A61P 25/28 (2006.01) A61K 31/437 (2006.01) A61K 31/444 (2006.01) A61K 31/497 (2006.01) A61K 31/506 (2006.01) A61K 45/06 (2006.01) A61P 25/00 (2006.01) A61P 25/18 (2006.01) A61P 25/22 (2006.01) A61P 25/24 (2006.01) A61P 25/28 (2006.01)	3723808	COMBINATION TREATMENTS COMPRISING ADMINISTRATION OF 1H-PYRAZOLO[4,3-B]PYRIDINES
Centre Hospitalier Universitaire De Nantes Université de Nantes	A61K 39/395 (2006.01) A61P 21/00 (2006.01) A61P 37/00 (2006.01) C07K 16/28 (2006.01) A61K 9/16 (2006.01) A61K 9/20 (2006.01) A61K 9/28 (2006.01) A61K 31/155 (2006.01) A61K 31/702 (2006.01) A61K 45/06 (2006.01)	3723800	TREATMENT OF MONOGENIC DISEASES WITH AN ANTI-CD45RC ANTIBODY
	A61K 9/16 (2006.01) A61K 9/20 (2006.01) A61K 9/28 (2006.01) A61K 31/155 (2006.01) A61K 31/702 (2006.01) A61K 45/06 (2006.01)	3727341	FIXED DOSE COMBINATION TABLET FORMULATION OF ACARBOSE AND METFORMIN AND PROCESS FOR PRODUCING THE SAME
LAC2BIOME S.R.L.	A61K 8/99 (2017.01) A61K 35/74 (2015.01) A61P 17/00 (2006.01) A61Q 19/00 (2006.01)	3720457	COMPOSITION BASED ON PROBIOTICS AND USES THEREOF
Immatics US, Inc.	C12N 5/0783 (2010.01)	3717634	METHODS FOR ACTIVATING, MODIFYING AND EXPANDING GAMMA DELTA T CELLS FOR THE TREATMENT OF CANCER AND RELATED MALIGNANCIES
	A61K 39/00 (2006.01) A61K 39/12 (2006.01) A61P 31/20 (2006.01)	3723797	HEPATITIS B IMMUNISATION REGIMEN AND COMPOSITIONS
	F25B 19/00 (2006.01) F25B 25/00 (2006.01) F25D 3/10	3749903	METHOD AND DEVICE FOR COOLING A SUPERCONDUCTING CURRENT CARRIER

Podnosilac evropske prijave patenta (71)	MKP (51)	Broj objave evropske prijave patenta (97)	Naziv pronalaska (54)	
OAT Agrio Co., Ltd.	(2006.01) H02G 15/34 (2006.01) A01N 43/80 (2006.01) A61K 31/42 (2006.01) A61P 33/00 (2006.01) C07D 261/08 (2006.01) C07K 14/435	3717461	A NOVEL ISOXAZOLE COMPOUND OR A SALT THEREOF	
	(2006.01) C07K 14/78 (2006.01) C12N 15/82 (2006.01) A61K 31/58 (2006.01) A61P 25/24 (2006.01) C07J 1/00 (2006.01) C07J 7/00 (2006.01) C07J 13/00 (2006.01) C07J 43/00 (2006.01) A61K 38/26 (2006.01) A61P 3/00 (2006.01) C07K 14/605 (2006.01) A61K 38/26 (2006.01) A61P 3/00 (2006.01) C07K 14/605 (2006.01) C12N 9/22 (2006.01) C12N 15/10 (2006.01) A61K 31/437 (2006.01) A61P 37/00 (2006.01) C07D 471/04 (2006.01) C07D 519/00 (2006.01) A61K 31/496 (2006.01) A61P 35/00 (2006.01) C07D 401/06 (2006.01) C07D 401/14 (2006.01) C07D 471/04 (2006.01) C07D 471/10 (2006.01) C07D 491/107 (2006.01) C07D 491/113 (2006.01) C07D 491/20			3720875
			3720867	DEUTERATED 21 -[4-CYANO-PYRAZOL-1 -YL]-19-NOR-PREGAN-3. ALPHA-OL-20-ONE DERIVATIVES FOR TREATING CNS DISORDERS
			3727425	INCRETIN ANALOGS AND USES THEREOF
			3727426	INCRETIN ANALOGS AND USES THEREOF
	Bayer HealthCare, LLC		3724332	NOVEL RNA-PROGRAMMABLE ENDONUCLEASE SYSTEMS AND THEIR USE IN GENOME EDITING AND OTHER APPLICATIONS
			3728252	4-AZAINDOLE COMPOUNDS
	Inthera Bioscience AG		3724178	1 -(PIPERIDINOCARBONYLMETHYL)-2-OXOPIPERAZINE DERIVATIVES FOR TREATING CANCER

Podnosilac evropske prijave patenta (71)	MKP (51)	Broj objave evropske prijave patenta (97)	Naziv pronalaska (54)
	(2006.01) C07D 495/04 (2006.01) C07D 495/10 (2006.01) C07D 497/10 (2006.01) A61K 39/00 (2006.01) A61K 39/395 (2006.01) A61P 3/04 (2006.01) A61P 3/10 (2006.01) C07K 16/28 (2006.01) A61K 31/519 (2006.01) A61P 35/00 (2006.01) C07D 453/02 (2006.01) C07D 471/04 (2006.01) C07D 519/00 (2006.01)	3728315	BISPECIFIC ANTIGEN BINDING MOLECULES THAT BIND LEPTIN RECEPTOR AND/OR GP130, AND METHODS OF USE THEREOF
Sala, Stefano	A23L 33/00 (2016.01) A23L 33/105 (2016.01) A61K 36/00 (2006.01) C07K 14/55 (2006.01) C12N 15/62 (2006.01)	3723509	DIETARY SUPPLEMENT
	A61K 39/12 (2006.01) A61K 39/29 (2006.01) A61N 1/00 (2006.01) A61P 31/14 (2006.01) E21B 21/00 (2006.01)	3728302	ENGINEERED IL-2 FC FUSION PROTEINS
Ichor Medical Systems, Inc.	A61K 39/12 (2006.01) A61K 39/29 (2006.01) A61N 1/00 (2006.01) A61P 31/14 (2006.01) E21B 21/00 (2006.01)	3727441	METHODS AND APPARATUS FOR THE DELIVERY OF HEPATITIS B VIRUS (HBV) VACCINES
	A61K 36/185 (2006.01) A61K 36/24 (2006.01) A61K 36/28 (2006.01) A61K 36/47 (2006.01) A61K 36/59 (2006.01) A61K 36/708 (2006.01) A61K 36/739 (2006.01) A61K 36/756 (2006.01) A61K 36/82 (2006.01) A61K 36/886 (2006.01) A61P 13/08 (2006.01) A61P 15/00	3752704 3720462	CURING A LOST CIRCULATION ZONE IN A WELLBORE INHIBITION OF ANDROGEN RECEPTOR BY EXTRACTS OF MEDICINAL HERBS AND COMPOSITIONS THEREOF

Podnosilac evropske prijave patenta (71)	MKP (51)	Broj objave evropske prijave patenta (97)	Naziv pronalaska (54)
Merck Sharp & Dohme Corp.	(2006.01) A61P 35/00 (2006.01)	3720483	COMPOSITIONS COMPRISING STREPTOCOCCUS PNEUMONIAE POLYSACCHARIDE-PROTEIN CONJUGATES AND METHODS OF USE THEREOF
	A61K 39/00 (2006.01)		
	A61K 39/09 (2006.01)		
	A61K 39/385 (2006.01)		
Project LEAH, LLC Nanev, Aleksandar	A61P 31/04 (2006.01)	3727582	FLESH-ILLUMINATING DEVICE
	A61N 5/00 (2006.01)		
	A61N 5/06 (2006.01)		
	F21L 4/00 (2006.01)		
	F21L 4/02 (2006.01)		
	F21V 1/00 (2006.01)		
	F21V 3/00 (2015.01)		
	F21V 3/02 (2006.01)		
	F21V 3/04 (2018.01)		
	H04N 19/124 (2014.01)		
	H04N 19/30 (2014.01)		
Tencent Technology (Shenzhen) Company Limited	H04N 19/30 (2014.01)	3716624	VIDEO ENCODING METHOD, COMPUTER DEVICE AND STORAGE MEDIUM
	A01K 61/60 (2017.01)	3713402	ROOF COVER FOR FISH FARM
Unitech Offshore AS	A61K 9/51 (2006.01)	3713601	EPSTEIN-BARR VIRUS VACCINES
	A61K 31/7115 (2006.01)	3717483	PYRAZOLOPYRIDINONE COMPOUNDS
A61K 39/245 (2006.01)			
A61P 31/22 (2006.01)			
C12N 7/00 (2006.01)			
North Carolina State University	A61K 31/437 (2006.01)	3717483	PYRAZOLOPYRIDINONE COMPOUNDS
	A61P 35/00 (2006.01)	3713403	FISH FARM
	C07D 471/04 (2006.01)		
	C07D 519/00 (2006.01)		
	A01K 61/60 (2017.01)		
	C07D 403/12 (2006.01)	3717473	POLYMORPHS AND SOLID FORMS OF A PYRIMIDINYLAMINO-PYRAZOLE COMPOUND, AND METHODS OF PRODUCTION
	C07D 403/14 (2006.01)	3713594	CHARGE-SWITCHABLE POLYMERIC DEPOT FOR GLUCOSE-TRIGGERED INSULIN DELIVERY WITH ULTRAFast RESPONSE
	C07D 405/14 (2006.01)		
	C07D 413/14 (2006.01)		
	A61K 38/28 (2006.01)		
C07K 14/62 (2006.01)	3717512	LYOPHILIZED FORMULATION OF A MONOCLONAL ANTIBODY AGAINST TRANSTHYRETIN	
A61K 39/00 (2006.01)			
	A61K 51/10 (2006.01)		

Podnosilac evropske prijave patenta (71)	MKP (51)	Broj objave evropske prijave patenta (97)	Naziv pronalaska (54)
	C07K 16/18 (2006.01)		
	A61K 31/4245 (2006.01)	3717462	SULFONAMIDE COMPOUNDS AND USE THEREOF
	A61P 35/00 (2006.01)		
	C07D 271/113 (2006.01)		
	C07D 413/12 (2006.01)		
	A61K 47/68 (2017.01)	3717022	COMPOSITIONS AND METHODS FOR THE DEPLETION OF CD5+ CELLS
	A61K 31/585 (2006.01)	3716982	ANTI-CD40 ANTIBODY DRUG CONJUGATES
	A61K 39/395 (2006.01)		
	C07K 16/28 (2006.01)		
	A61K 31/165 (2006.01)	3716964	MYST FAMILY HISTONE ACETYLTRANSFERASE INHIBITORS
	A61K 31/18 (2006.01)		
	A61K 31/40 (2006.01)		
	C07C 255/00 (2006.01)		
	C07C 307/02 (2006.01)		
	C07C 317/50 (2006.01)		
	A61K 38/00 (2006.01)	3717519	COMPOSITIONS AND METHODS FOR THE DEPLETION OF CD2+ CELLS
	C07K 16/28 (2006.01)		
	A61K 31/4245 (2006.01)	3718545	ANTITUMOR AGENT
	A61K 45/00 (2006.01)		
	A61P 35/00 (2006.01)		
	A61P 43/00 (2006.01)		
	C07D 249/04 (2006.01)		
	A01N 43/40 (2006.01)	3719004	PYRIDINIUM SALT AND PEST CONTROL AGENT
	A01N 43/50 (2006.01)		
	A01N 43/54 (2006.01)		
	A01N 43/56 (2006.01)		
	A01N 43/60 (2006.01)		
	A01N 43/76 (2006.01)		
	A01N 43/78 (2006.01)		
	A01N 43/80 (2006.01)		
	A01N 43/836 (2006.01)		
	A01N 47/02 (2006.01)		
	A01P 7/02 (2006.01)		
	A01P 7/04 (2006.01)		
	A01P 17/00 (2006.01)		

Podnosilac evropske prijave patenta (71)	MKP (51)	Broj objave evropske prijave patenta (97)	Naziv pronalaska (54)
	A61K 31/4425 (2006.01)		
	A61P 33/00 (2006.01)		
	C07D 213/89 (2006.01)		
	C07D 401/12 (2006.01)		
	C07D 405/12 (2006.01)		
	C07D 409/12 (2006.01)		
	C07D 413/12 (2006.01)		
	C07D 417/12 (2006.01)		
	A61K 38/00 (2006.01)	3717505	ENGINEERED DNA BINDING PROTEINS
	C07K 14/00 (2006.01)		
	C12Q 1/68 (2018.01)		
Amplix Pharmaceuticals, Inc.	A61K 31/42 (2006.01)	3720438	HETEROCYCLE SUBSTITUTED PYRIDINE DERIVATIVE ANTIFUNGAL AGENTS
	A61K 31/505 (2006.01)		
	A61K 31/506 (2006.01)		
	C07D 247/02 (2006.01)		
	C07D 261/02 (2006.01)		
	C07D 261/06 (2006.01)		
	A61K 31/7088 (2006.01)	3720448	COMPOSITIONS AND METHODS OF TREATING MUSCLE ATROPHY AND MYOTONIC DYSTROPHY
	A61K 31/712 (2006.01)		
	A61K 31/713 (2006.01)		
	A61K 39/395 (2006.01)		
	A61K 47/68 (2017.01)		
	C12N 15/113 (2010.01)		
Reven IP Holdco LLC	A61K 9/08 (2006.01)	3720421	COMPOSITIONS AND METHODS FOR THE TREATMENT OF METABOLIC CONDITIONS
	A61K 31/198 (2006.01)		
	A61K 31/375 (2006.01)		
	A61K 31/4415 (2006.01)		
	A61K 31/51 (2006.01)		
	A61K 31/525 (2006.01)		
	A61K 31/714 (2006.01)		
	A61K 33/14 (2006.01)		
	A61K 47/18 (2017.01)		
	C12N 5/10 (2006.01)	3720952	GENE EDITING USING A MODIFIED CLOSED-ENDED DNA (CEDNA)
	C12N 9/22 (2006.01)		
	C12N 15/09 (2006.01)		

Podnosilac evropske prijave patenta (71)	MKP (51)	Broj objave evropske prijave patenta (97)	Naziv pronalaska (54)
	C12N 15/113 (2010.01)	3720487	FORMULATIONS OF DENGUE VIRUS VACCINE COMPOSITIONS
	C12N 15/63 (2006.01)		
	C12N 15/64 (2006.01)		
	C12N 15/66 (2006.01)		
	C12N 15/90 (2006.01)		
	A61K 9/00 (2006.01)		
	A61K 9/14 (2006.01)		
	A61K 39/12 (2006.01)		
	A61K 47/26 (2006.01)		
	C07K 16/18 (2006.01)		
	C07K 16/34 (2006.01)		
	C07K 16/44 (2006.01)		
	G01N 33/53 (2006.01)		
	G01N 33/577 (2006.01)		
G01N 33/72 (2006.01)			
C10L 5/14 (2006.01)	3724300	TORREFIED BIOMASS BRIQUETTES AND RELATED METHODS	
C10L 5/44 (2006.01)	3723788	CD19 VARIANTS	
A61K 38/17 (2006.01)			
A61K 39/395 (2006.01)			
C07K 14/705 (2006.01)			
C07K 16/28 (2006.01)	3724208	COMPOSITIONS COMPRISING CIRCULAR POLYRIBONUCLEOTIDES AND USES THEREOF	
C07K 7/00 (2006.01)			
C07K 7/06 (2006.01)			
C12P 21/00 (2006.01)	3726298	CARTRIDGE AND IMAGE FORMING DEVICE {}	
G03G 21/18 (2006.01)			
Regents of the University of Minnesota	A61K 31/437 (2006.01)	3723757	SMALL MOLECULE DEGRADERS THAT RECRUIT DCAFT15
	C07D 409/14 (2006.01)	3723787	DARIC INTERLEUKIN RECEPTORS
	C07D 513/16 (2006.01)		
	A61K 38/16 (2006.01)		
	C07K 14/435 (2006.01)	3724220	NKG2D DARIC RECEPTORS
	C12N 15/62 (2006.01)		
	C07K 14/705 (2006.01)		
	C12N 5/00 (2006.01)	3724211	DOSING REGIMENS AND RELATED COMPOSITIONS AND METHODS
	A61K 38/04 (2006.01)		
	A61K 38/12 (2006.01)		

Podnosilac evropske prijave patenta (71)	MKP (51)	Broj objave evropske prijave patenta (97)	Naziv pronalaska (54)			
Opti-Harvest, Inc.	C07K 7/06 (2006.01)	3727353	SURFACTANT FORMULATIONS FOR INHALATION			
	C07K 7/50 (2006.01)					
	C07K 7/64 (2006.01)					
	C07K 14/47 (2006.01)					
	A61K 9/16 (2006.01)					
	A61K 9/72 (2006.01)					
	A61P 11/16 (2006.01)					
	C07K 14/785 (2006.01)					
	C07D 231/56 (2006.01)					
	C07D 471/04 (2006.01)					
	A01G 9/24 (2006.01)					
	G02B 19/00 (2006.01)					
	C07D 231/56 (2006.01)					
	C07D 471/04 (2006.01)					
Akouos, Inc.	A61K 31/513 (2006.01)	3730935	METHOD FOR DETECTING TRIFLURIDINE- AND/OR TIPIRACIL-DERIVED ANALOGS			
	A61K 31/7072 (2006.01)					
	A61P 35/00 (2006.01)					
	C07H 19/073 (2006.01)					
	G01N 30/26 (2006.01)					
	G01N 30/88 (2006.01)					
	A61K 9/00 (2006.01)					
	A61K 39/395 (2006.01)					
	A61K 48/00 (2006.01)					
	A61P 27/16 (2006.01)					
	C12N 15/113 (2010.01)					
	Qatar University			A61K 31/155 (2006.01)	3727363	TRANSDERMAL NON-AQUEOUS NANOEMULGELS FOR SYSTEMIC DELIVERY OF AROMATASE INHIBITOR
				A61K 31/4164 (2006.01)		
				A61K 31/496 (2006.01)		
Abraxis BioScience, LLC	A61K 31/282 (2006.01)	3727368	METHODS OF TREATING COLON CANCER USING NANOPARTICLE MTOR INHIBITOR COMBINATION THERAPY			
	A61K 31/436 (2006.01)					
	A61K 31/513 (2006.01)					
	A61K 31/519 (2006.01)					
	A61K 39/395 (2006.01)					
	A61P 35/00 (2006.01)					
TILITER PTY LTD	A47F 9/04 (2006.01)	3729375	A RETAIL CHECKOUT TERMINAL FRESH PRODUCE IDENTIFICATION SYSTEM			

Podnosilac evropske prijave patenta (71)	MKP (51)	Broj objave evropske prijave patenta (97)	Naziv pronalaska (54)
Green Biomed, Inc. KIRIN HOLDINGS KABUSHIKI KAISHA	G06Q 30/06 (2012.01)	3728260	EXO-AZA SPIRO INHIBITORS OF MENIN-MLL INTERACTION
	G06T 7/41 (2017.01)		
	G07G 1/12 (2006.01)		
	A61K 31/47 (2006.01)		
	A61K 31/519 (2006.01)		
	A61P 35/02 (2006.01)		
	C07D 471/10 (2006.01)		
	C07D 487/10 (2006.01)		
	C07D 495/04 (2006.01)		
	A61K 39/12 (2006.01)		
	A61K 39/145 (2006.01)		
	A61K 39/295 (2006.01)		
	A61P 31/14 (2006.01)		
	A61P 31/16 (2006.01)		
	C07K 14/08 (2006.01)		
	C07K 14/11 (2006.01)		
	C07K 19/00 (2006.01)		
	C12N 15/40 (2006.01)		
	C12N 15/44 (2006.01)		
	C12N 15/62 (2006.01)	3732205	MULTIVALENT CHIMERIC ANTIGEN RECEPTOR
	C07K 16/46 (2006.01)		
	A61K 31/427 (2006.01)	3727377	PROCESS FOR THE PREPARATION OF PYRIMIDINYL-4-AMINOPYRAZOLE COMPOUNDS
	A61K 31/4439 (2006.01)	3730612	IMMUNOCOMPETENT CELL THAT EXPRESSES A CELL SURFACE MOLECULE SPECIFICALLY RECOGNIZING HUMAN MESOTHELIN, IL-7 AND CCL19
	A61K 35/17 (2015.01)		
	A61P 35/00 (2006.01)		
	C07K 14/52 (2006.01)		
	C07K 14/54 (2006.01)		
	C07K 14/705 (2006.01)		
	C07K 19/00 (2006.01)		
	C12N 5/0783 (2010.01)		
	C12N 15/09 (2006.01)		
	A61K 38/00 (2006.01)		
C07K 14/435 (2006.01)			
C07K 19/00 (2006.01)	3732187	UNNATURAL BASE PAIR COMPOSITIONS AND METHODS OF USE	
C07H 21/04 (2006.01)			

Podnosilac evropske prijave patenta (71)	MKP (51)	Broj objave evropske prijave patenta (97)	Naziv pronalaska (54)
	C07K 14/34 (2006.01)		
	C12N 1/20 (2006.01)		
	C12N 1/21 (2006.01)		
	C07D 239/47 (2006.01)	3732166	PROCESS FOR THE PREPARATION OF AN AMINO-PYRIMIDINE AND INTERMEDIATES THEREOF
	C07D 401/10 (2006.01)		
	C07D 401/12 (2006.01)		
	A61K 31/438 (2006.01)	3636637	INHIBITING FATTY ACID SYNTHASE (FASN)
	A61P 1/16 (2006.01)		
	C07D 221/20 (2006.01)		
	C07D 401/06 (2006.01)		
	C07D 401/10 (2006.01)		
	C07D 405/06 (2006.01)		
	C07D 405/14 (2006.01)		
	C07D 409/14 (2006.01)		
	C07D 413/06 (2006.01)		
	C07D 413/10 (2006.01)		
	C07D 413/14 (2006.01)		
	A61P 35/00 (2006.01)	3628688	ANTI-CEACAM6 ANTIBODIES AND USES THEREOF
	C07K 16/28 (2006.01)		
	G03G 15/00 (2006.01)	3629092	DRUM UNIT, CARTRIDGE, ELECTROPHOTOGRAPHIC IMAGE FORMING APPARATUS AND COUPLING MEMBER
Martin Bretones, Germán Ortega Carrasco, Javier Carlos Fernandez Aguilera, Juan Antonio	A01N 25/12 (2006.01)	3639666	USE OF LECITHINS AS A BIOCIDES AGAINST ARTHROPODS
	A01N 37/04 (2006.01)		
	A01N 43/90 (2006.01)		
	A01N 57/12 (2006.01)		
	A01P 7/00 (2006.01)		
Amgen Inc.	A61K 39/395 (2006.01)	3620175	HIGH CONCENTRATION ANTIBODY FORMULATIONS
	A61K 47/12 (2006.01)		
	C07K 16/22 (2006.01)		
The Research Foundation for The State University of New York	A61K 39/145 (2006.01)	3653701	ATTENUATED INFLUENZA VIRUSES AND VACCINES
	A61P 31/16 (2006.01)		
	C12N 7/04 (2006.01)		
	A61K 39/00 (2006.01)	3656399	STABLE FORMULATIONS CONTAINING ANTI-PCSK9 ANTIBODIES
	A61K 39/395 (2006.01)		
	A61P 3/06 (2006.01)		

Podnosilac evropske prijave patenta (71)	MKP (51)	Broj objave evropske prijave patenta (97)	Naziv pronalaska (54)		
Servicenow, Inc.	C07K 16/40 (2006.01)	3640816	IDENTIFYING APPLICATIONS WITH MACHINE LEARNING		
	G06F 8/60 (2018.01)				
	G06F 16/28 (2019.01)	3641221	IDENTIFYING COMPUTING DEVICES IN A MANAGED NETWORK THAT ARE INVOLVED IN BLOCKCHAIN-BASED MINING		
	H04L 12/24 (2006.01)				
	A61K 9/51 (2006.01)	3650047	PEPTIDE CONJUGATED PARTICLES		
	A61K 39/00 (2006.01)				
	A61K 47/69 (2017.01)				
	A61P 1/00 (2006.01)				
	A61P 11/06 (2006.01)				
	A61P 13/12 (2006.01)				
A61P 19/06 (2006.01)					
A61P 25/00 (2006.01)					
Aragon Pharmaceuticals, Inc.	A61K 31/00 (2006.01)			3653733	METHODS AND COMPOSITIONS FOR DETERMINING RESISTANCE TO ANDROGEN RECEPTOR THERAPY
	C07K 14/72 (2006.01)				
	C07K 16/28 (2006.01)	3626267	TREATMENT FOR BONE DISEASES		
	C12Q 1/6886 (2018.01)				
	A61K 39/395 (2006.01)	3626185	SURGICAL INSTRUMENT WITH FUNCTION SELECTOR		
	C07K 16/22 (2006.01)				
	A61B 17/32 (2006.01)	3628335	LIPIDIC NANOPARTICLES FOR MRNA DELIVERY IN THE LUNGS		
	A61B 18/14 (2006.01)				
	A61K 48/00 (2006.01)	3657566	PLUG DEVICE FOR BATTERY, BATTERY AND MOTOR VEHICLE		
	H01M 2/02 (2006.01)				
H01M 2/20 (2006.01)	3632442	USE OF PYRAZOLOPYRIMIDINE DERIVATIVES FOR THE TREATMENT OF PI3K RELATED DISORDERS			
H01M 2/30 (2006.01)					
Hephaistos Solar GmbH	A61K 31/519 (2006.01)	3656384	COMBINATIONS COMPRISING 5-PHENOXY-3H-PYRIMIDIN-4-ONE DERIVATIVES AND THEIR USE FOR THE PROPHYLAXIS OR TREATMENT OF INFECTION BY HIV		
	A61K 31/5377 (2006.01)				
	A61P 35/00 (2006.01)	3660381	FITTING FOR LIQUEFIED GAS BOTTLES AND FILLING METHOD		
	A61K 31/513 (2006.01)				
	A61P 31/18 (2006.01)	3661050	SUBSTRUCTURE FOR SOLAR MODULES IN FRAMES AND MODULE CLAMP FOR MOUNTING SOLAR MODULES IN FRAMES ON A MODULE SUPPORT		
	F17C 13/04 (2006.01)				
	H02S 20/00 (2014.01)	3656396	RECOMBINANT MODIFIED VACCINIA VIRUS ANKARA (MVA) RESPIRATORY SYNCYTIAL VIRUS (RSV) VACCINE		
	A61K 39/155 (2006.01)				
	A01K 67/027 (2006.01)	3636073	HUMANIZED C5 AND C3 ANIMALS		
	A61K 49/00				

Podnosilac evropske prijave patenta (71)	MKP (51)	Broj objave evropske prijave patenta (97)	Naziv pronalaska (54)
	(2006.01) A61P 35/02 (2006.01) C07K 16/28 (2006.01) C07K 1/22 (2006.01)	3728288	METHODS FOR ENHANCED REMOVAL OF IMPURITIES DURING PROTEIN A CHROMATOGRAPHY
	C12N 9/22 (2006.01) C12N 15/113 (2010.01) C12N 15/90 (2006.01)	3724342	MATERIALS AND METHODS FOR TREATMENT OF AUTOSOMAL DOMINANT CONE-ROD DYSTROPHY
	A61P 27/02 (2006.01) C12N 15/113 (2010.01)	3728594	MATERIALS AND METHODS FOR TREATMENT OF USHER SYNDROME TYPE 2A
Bayer HealthCare LLC	A61P 27/02 (2006.01) C12N 15/113 (2010.01) A61K 38/17 (2006.01) A61P 29/00 (2006.01) C07K 14/47 (2006.01)	3728595 3733196	MATERIALS AND METHODS FOR TREATMENT OF USHER SYNDROME TYPE 2A AND/OR NON-SYNDROMIC AUTOSOMAL RECESSIVE RETINITIS PIGMENTOSA (ARRP) PHARMACEUTICAL COMPOSITION COMPRISING AN APL PEPTIDE
	A61K 39/245 (2006.01) A61K 39/295 (2006.01) C07K 14/05 (2006.01)	3728291	EPSTEIN-BARR VIRUS ANTIGEN CONSTRUCTS
Nearmedic International Limited	A61K 31/11 (2006.01) A61P 31/12 (2006.01) C07C 43/20 (2006.01) C07C 47/57 (2006.01) C07C 69/736 (2006.01) C07C 243/18 (2006.01) C07C 245/12 (2006.01) C07C 251/24 (2006.01) C07C 309/13 (2006.01) C07D 207/14 (2006.01) C07D 211/60 (2006.01) C07D 213/74 (2006.01) C07D 215/38 (2006.01)	3731933	ASYMMETRIC DERIVATIVES OF POLYPHENOLS OF THE DINAPHTHALINE SERIES, PROCESS OF PREPARING AND USE THEREOF
	A61K 39/00 (2006.01) C12N 5/0783 (2010.01)	3720480	PHENOTYPIC MARKERS FOR CELL THERAPY AND RELATED METHODS
Mocevic, Vojin	C25B 1/08 (2006.01) C25B 9/18 (2006.01) C25B 9/20 (2006.01)	3732316	MODULAR DEVICE AND PROCEDURE FOR PRODUCING REPRODUCIBLE QUALITY HYDROGEN AND OXYGEN GASES

Podnosilac evropske prijave patenta (71)	MKP (51)	Broj objave evropske prijave patenta (97)	Naziv pronalaska (54)
Compugen Ltd.	C25B 15/02 (2006.01)	3717025	IMAGING AGENTS
	A61K 51/04 (2006.01)		
	A61K 101/00 (2006.01)		
	A61K 101/02 (2006.01)		
	C07B 59/00 (2006.01)		
	C07D 491/048 (2006.01)		
	A61K 31/185 (2006.01)	3720428	OPHTHALMIC TOPICAL COMPOSITION COMPRISING DOBESILIC ACID FOR TREATING DISEASES OF THE POSTERIOR SEGMENT OF THE EYE
	A61P 27/02 (2006.01)		
	A61K 31/433 (2006.01)	3724198	2-OXO-1-PYRROLIDINYL IMIDAZOTHIADIAZOLE DERIVATIVES
	A61P 25/08 (2006.01)		
	C07D 513/04 (2006.01)	3720851	1,2,4-OXADIAZOLE DERIVATIVES AS HISTONE DEACETYLASE 6 INHIBITORS
	A61K 31/4245 (2006.01)		
	A61P 9/00 (2006.01)		
	A61P 25/00 (2006.01)		
	A61P 31/00 (2006.01)		
	C07D 413/14 (2006.01)		
	A61K 9/00 (2006.01)		
	A61K 9/06 (2006.01)		
	A61K 31/192 (2006.01)	3716944	STABLE LIQUID COMPOSITION OF KETOPROFEN, SALTS AND ENANTIOMERS THEREOF
	A61K 47/40 (2006.01)		
	A61K 31/337 (2006.01)	3717007	ILDR2 ANTAGONISTS AND COMBINATIONS THEREOF
	A61K 39/395 (2006.01)		
	A61P 35/00 (2006.01)		
	A61P 37/04 (2006.01)		
	C07K 16/28 (2006.01)		
	A61K 31/437 (2006.01)	3720440	TREATMENT OF RSV WITH COMBINATION PRODUCT
A61K 31/519 (2006.01)			
A61P 11/00 (2006.01)			
A61P 31/14 (2006.01)	3717471	NOVEL COMPOUNDS AND PHARMACEUTICAL COMPOSITIONS THEREOF FOR THE TREATMENT OF DISEASES	
A61K 31/437 (2006.01)			
A61P 9/00 (2006.01)			
A61P 37/00 (2006.01)			
C07D 403/04 (2006.01)			
C07D 471/04 (2006.01)			
A01G 17/06 (2006.01)	3716755	A DEVICE FOR TENSIONING PLANT SUPPORT WIRES, SUPPORT SYSTEM OF SAID PLANTS	

Podnosilac evropske prijave patenta (71)	MKP (51)	Broj objave evropske prijave patenta (97)	Naziv pronalaska (54)
	A47K 10/32 (2006.01)	3727114	COMPRISING SUCH DEVICE AND THE METHOD OF SUPPORT THEREOF REFILL FOR A DISPENSER
	A47K 10/38 (2006.01)		
	A47K 10/40 (2006.01)		
	B65H 16/06 (2006.01)		
	B65H 75/24 (2006.01)		
	A61K 31/185 (2006.01)	3724165	NEW BENZAMIDE DERIVATIVES AS PPAR-GAMMA MODULATORS
	A61K 31/44 (2006.01)		
	A61K 31/444 (2006.01)		
	A61K 31/50 (2006.01)		
	A61P 35/00 (2006.01)		
	C07C 237/20 (2006.01)		
	C07C 255/50 (2006.01)		
	C07D 213/75 (2006.01)		
	C07D 237/20 (2006.01)		
	C07D 295/192 (2006.01)		
	C07D 401/04 (2006.01)		
	A61K 38/26 (2006.01)		
	A61P 3/10 (2006.01)		
	A61K 31/519 (2006.01)	3717482	NEW PIPERIDINYL DERIVATIVES AS INHIBITORS OF UBIQUITIN SPECIFIC PROTEASE 7
	A61K 31/52 (2006.01)		
	A61P 35/00 (2006.01)		
	A61P 37/00 (2006.01)		
	C07D 471/04 (2006.01)		
	C07D 473/30 (2006.01)		
	C07D 495/04 (2006.01)		
	A61K 9/16 (2006.01)		
	A61K 9/20 (2006.01)		
	A61K 9/28 (2006.01)		
	A61K 9/48 (2006.01)	3716952	DOSAGE FORMS COMPRISING A PLASMA KALLIKREIN INHIBITOR
	A61K 31/00 (2006.01)		
	A61K 31/473 (2006.01)		
	A61P 25/00 (2006.01)		
	C07D 405/12 (2006.01)		
	C07D 405/14 (2006.01)	3713933	NEW CATECHOLAMINE PRODRUGS FOR USE IN THE TREATMENT OF PARKINSON'S DISEASE

Podnosilac evropske prijave patenta (71)	MKP (51)	Broj objave evropske prijave patenta (97)	Naziv pronalaska (54)
	A61K 48/00 (2006.01) A61P 3/00 (2006.01) C12N 9/02 (2006.01) C12N 15/67 (2006.01)	3714047	POLYNUCLEOTIDES ENCODING PHENYLALANINE HYDROXYLASE FOR THE TREATMENT OF PHENYLKETONURIA
	A61K 48/00 (2006.01) A61P 3/00 (2006.01) C12N 9/00 (2006.01) C12N 15/67 (2006.01)	3714045	POLYNUCLEOTIDES ENCODING PROPIONYL-COA CARBOXYLASE ALPHA AND BETA SUBUNITS FOR THE TREATMENT OF PROPIONIC ACIDEMIA
	A23G 9/42 (2006.01) A23L 9/20 (2016.01) A23L 33/185 (2016.01) A61K 36/48 (2006.01)	3716791	CREAM SUBSTITUTE COMPRISING PULSE PROTEIN
	A61K 31/505 (2006.01) A61P 35/00 (2006.01) C07D 307/94 (2006.01) C07D 317/44 (2006.01) C07D 471/04 (2006.01) C07H 19/14 (2006.01)	3720865	NOVEL SPIROBICYCLIC ANALOGUES
	A61K 48/00 (2006.01) A61P 3/00 (2006.01) C12N 9/10 (2006.01) C12N 15/67 (2006.01)	3714048	POLYNUCLEOTIDES ENCODING ORNITHINE TRANSCARBAMYLASE FOR THE TREATMENT OF UREA CYCLE DISORDERS
	C07B 59/00 (2006.01) C07C 33/18 (2006.01) C07C 69/96 (2006.01) C07D 215/56 (2006.01)	3717455	PROCESSES FOR MAKING MODULATORS OF CYSTIC FIBROSIS TRANSMEMBRANE CONDUCTANCE REGULATOR
Pharvaris Netherlands B.V.	A61K 31/4709 (2006.01) A61K 31/5377 (2006.01) A61P 11/06 (2006.01) A61P 25/28 (2006.01) A61P 29/00 (2006.01) C07D 401/04 (2006.01) C07D 401/14 (2006.01) C07D 405/14 (2006.01) C07D 413/14 (2006.01)	3713928	NOVEL BRADYKININ B2 RECEPTOR ANTAGONISTS

Podnosilac evropske prijave patenta (71)	MKP (51)	Broj objave evropske prijave patenta (97)	Naziv pronalaska (54)
	C07D 417/14 (2006.01)		
	A61K 39/00 (2006.01)	3717514	ANTI-TRKB MONOCLONAL ANTIBODIES AND METHODS OF USE
	C07K 16/28 (2006.01)		
	A61K 31/7052 (2006.01)	3720864	SALTS OF DIPHOSPHATE PHOSPHORAMIDATE OF NUCLEOSIDES AS ANTICANCER COMPOUNDS
	A61P 35/00 (2006.01)		
	C07H 19/10 (2006.01)		
	C07H 19/20 (2006.01)		
	A61K 8/81 (2006.01)	3720416	ORAL CARE COMPOSITION
	A61Q 11/00 (2006.01)		
	A61K 8/81 (2006.01)	3720563	ORAL CARE COMPOSITIONS
	A61Q 11/00 (2006.01)		
	A61K 8/02 (2006.01)	3720564	HIGH-THROUGHPUT METHOD FOR DETECTING TOOTH STAIN PREVENTION AND REMOVAL
	A61K 8/24 (2006.01)		
	A61Q 11/00 (2006.01)		
	G01N 1/30 (2006.01)		
	G01N 21/17 (2006.01)		
	G01N 33/15 (2006.01)		
	A61K 31/4709 (2006.01)	3713919	CRYSTALLINE FORMS OF N-(4-(4-(CYCLOPROPYLMETHYL) PIPERAZINE-1-CARBONYL)PHENYL)QUINOLINE-8-SULFONAMIDE
	A61P 7/06 (2006.01)		
	C07D 215/36 (2006.01)		
	A61M 5/24 (2006.01)	3720526	MEDICAL DELIVERY DEVICE WITH AXIALLY EXPANDABLE DRIVE RIBBON
	A61M 5/315 (2006.01)		
	A61K 31/573 (2006.01)	3716980	METHODS FOR DOSING AND FOR MODULATION OF GENETICALLY ENGINEERED CELLS
	A61P 43/00 (2006.01)		
	C07K 16/28 (2006.01)		
	G01N 33/68 (2006.01)		
	A01K 67/027 (2006.01)	3720279	NON-HUMAN ANIMALS HAVING AN ENGINEERED IMMUNOGLOBULIN LAMBDA LIGHT CHAIN AND USES THEREOF
	C07K 16/00 (2006.01)		
	C07K 16/46 (2006.01)		
	C12N 9/12 (2006.01)		
	A61K 31/437 (2006.01)	3713940	SUBSTITUTED AZACYCLES AS MUSCARINIC M1 RECEPTOR POSITIVE ALLOSTERIC MODULATORS
	A61P 25/00 (2006.01)		
	C07D 471/04 (2006.01)		
	A61K 31/4525 (2006.01)	3720858	MODULATORS OF THE BETA-3 ADRENERGIC RECEPTOR USEFUL FOR THE TREATMENT OR PREVENTION OF HEART FAILURE AND DISORDERS RELATED THERETO
	A61P 9/04 (2006.01)		

Podnosilac evropske prijave patenta (71)	MKP (51)	Broj objave evropske prijave patenta (97)	Naziv pronalaska (54)		
LO.LI. Pharma International S.r.l.	C07D 491/10 (2006.01)	3727359	TREATMENT OF FIBROSIS WITH INOSITOL		
	A61K 31/047 (2006.01)				
Boloro Global Limited	A61P 43/00 (2006.01)	3752972	SYSTEM AND METHOD FOR AUTHENTICATED SHARIA LAW COMPLIANT LOTTERY, SPORTS BETTING AND GAMING		
	G06Q 40/00 (2012.01)				
Shanghai Blueray Biopharma Co., Ltd.	A61K 39/395 (2006.01)	3752191	NON-VIRAL DNA VECTORS AND USES THEREOF FOR ANTIBODY AND FUSION PROTEIN PRODUCTION		
	C07K 14/47 (2006.01)				
	C12N 15/864 (2006.01)				
	A61K 39/395 (2006.01)	3752193	METHODS FOR TREATING CANCER WITH ANTI PD-1 ANTIBODIES AND ANTI CTLA4 ANTIBODIES		
	C07K 16/28 (2006.01)				
	C07K 16/30 (2006.01)				
	B07C 3/00 (2006.01)	3752440	GROUPING STATION FOR LOADING PALLETS		
	B07C 5/00 (2006.01)				
	B65G 15/22 (2006.01)				
	B65G 17/26 (2006.01)				
Nuvation Bio Inc.	B65G 47/08 (2006.01)	3753941	PYRIMIDINE-FUSED CYCLIC COMPOUND, PREPARATION METHOD THEREFOR AND APPLICATION THEREOF		
	A61K 31/519 (2006.01)				
	A61K 31/55 (2006.01)				
	A61K 45/06 (2006.01)				
	A61P 35/00 (2006.01)				
	A61P 35/02 (2006.01)				
	C07D 487/04 (2006.01)				
	C07D 519/00 (2006.01)				
	A61K 31/538 (2006.01)			3752491	HETEROCYCLIC COMPOUNDS AS KINASE INHIBITORS
	C07D 265/36 (2006.01)				
C07D 413/14 (2006.01)					
Rutgers, The State University of New Jersey	A61M 1/36 (2006.01)	3752216	USING THERMOCHROMIC INK FOR BLOOD SIMULATION IN MEDICAL TRAINING		
	C09D 11/50 (2014.01)				
	F28D 9/00 (2006.01)	3752142	ANTIBACTERIAL AGENTS: SOLUBLE SALTS AND AQUEOUS FORMULATIONS OF PYRONINS		
	A61K 31/366 (2006.01)				
	A61K 31/381 (2006.01)				
	A61K 31/4025 (2006.01)				
Rutgers, The State University of New Jersey	A61K 31/366 (2006.01)	3752143	ANTIBACTERIAL AGENTS: O-ALKYL-DEUTERATED PYRONINS		
	A61K 31/381 (2006.01)				
	A61K 31/4025 (2006.01)				

Podnosilac evropske prijave patenta (71)	MKP (51)	Broj objave evropske prijave patenta (97)	Naziv pronalaska (54)
Markey, Dillon	B60R 11/02 (2006.01)	3755613	ERGONOMIC CONTROL SYSTEM FOR BICYCLES AND ELECTRONIC DEVICES
	B62D 1/04 (2006.01)		
	B62K 11/14 (2006.01)	3614208	OPTICAL SENSOR AND IMAGE FORMING APPARATUS
	G03G 15/00 (2006.01)		
	G03G 15/00 (2006.01)	3614209	IMAGE FORMING APPARATUS
	A61K 39/395 (2006.01)	3656398	ANTI-B7-H1 ANTIBODIES FOR TREATING TUMORS
	A61P 35/00 (2006.01)		
	C07K 16/28 (2006.01)	3623385	BINDING MOLECULES FOR BCMA AND CD3
	C07K 16/30 (2006.01)		
	A61K 39/395 (2006.01)	3628373	METHODS FOR TREATING OR PREVENTING OPHTHALMOLOGICAL CONDITIONS
	A61P 35/02 (2006.01)		
	A61P 37/00 (2006.01)	3636279	METHODS FOR INCREASING EFFICACY OF FOLR1 CANCER THERAPY
	C07K 16/28 (2006.01)		
	A61K 39/39 (2006.01)	3622956	SUBSTITUTED 2-AZABICYCLES AND THEIR USE AS OREXIN RECEPTOR MODULATORS
A61P 27/02 (2006.01)			
A61K 39/395 (2006.01)	3656758	INTERMEDIATES FOR THE PREPARATION OF C-TERMINAL HSP90 INHIBITORS	
A61K 31/506 (2006.01)			
A61P 25/00 (2006.01)	3636251	PHARMACEUTICAL COMPOSITION OF S-KETAMINE HYDROCHLORIDE	
C07C 233/18 (2006.01)			
C07D 213/30 (2006.01)	3626717	SELECTIVELY SUBSTITUTED QUINOLINE COMPOUNDS	
C07D 319/08 (2006.01)			
A61K 9/00 (2006.01)	3626717	SELECTIVELY SUBSTITUTED QUINOLINE COMPOUNDS	
A61K 31/137 (2006.01)			
A61K 47/02 (2006.01)	3626717	SELECTIVELY SUBSTITUTED QUINOLINE COMPOUNDS	
A61K 47/28 (2006.01)			
A61K 31/47 (2006.01)	3626717	SELECTIVELY SUBSTITUTED QUINOLINE COMPOUNDS	
A61K 31/535 (2006.01)			
A61P 37/00 (2006.01)	3626717	SELECTIVELY SUBSTITUTED QUINOLINE COMPOUNDS	
C07D 215/48 (2006.01)			
C07D 401/10 (2006.01)	3626717	SELECTIVELY SUBSTITUTED QUINOLINE COMPOUNDS	
C07D 401/14 (2006.01)			
C07D 403/14 (2006.01)	3626717	SELECTIVELY SUBSTITUTED QUINOLINE COMPOUNDS	
C07D 413/04 (2006.01)			
C07D 413/14 (2006.01)	3626717	SELECTIVELY SUBSTITUTED QUINOLINE COMPOUNDS	
C07D 417/14 (2006.01)			
IVERIC bio, Inc.	A61K 39/39 (2006.01)	3628373	METHODS FOR TREATING OR PREVENTING OPHTHALMOLOGICAL CONDITIONS
	A61P 27/02 (2006.01)		
	A61K 39/395 (2006.01)	3636279	METHODS FOR INCREASING EFFICACY OF FOLR1 CANCER THERAPY
	A61K 31/506 (2006.01)		
	A61P 25/00 (2006.01)	3622956	SUBSTITUTED 2-AZABICYCLES AND THEIR USE AS OREXIN RECEPTOR MODULATORS
	C07C 233/18 (2006.01)		
	C07D 213/30 (2006.01)	3656758	INTERMEDIATES FOR THE PREPARATION OF C-TERMINAL HSP90 INHIBITORS
	C07D 319/08 (2006.01)		
	A61K 9/00 (2006.01)	3636251	PHARMACEUTICAL COMPOSITION OF S-KETAMINE HYDROCHLORIDE
	A61K 31/137 (2006.01)		
	A61K 47/02 (2006.01)	3626717	SELECTIVELY SUBSTITUTED QUINOLINE COMPOUNDS
	A61K 47/28 (2006.01)		
	A61K 31/47 (2006.01)	3626717	SELECTIVELY SUBSTITUTED QUINOLINE COMPOUNDS
	A61K 31/535 (2006.01)		
A61P 37/00 (2006.01)	3626717	SELECTIVELY SUBSTITUTED QUINOLINE COMPOUNDS	
C07D 215/48 (2006.01)			
C07D 401/10 (2006.01)	3626717	SELECTIVELY SUBSTITUTED QUINOLINE COMPOUNDS	
C07D 401/14 (2006.01)			
C07D 403/14 (2006.01)	3626717	SELECTIVELY SUBSTITUTED QUINOLINE COMPOUNDS	
C07D 413/04 (2006.01)			
C07D 413/14 (2006.01)	3626717	SELECTIVELY SUBSTITUTED QUINOLINE COMPOUNDS	
C07D 417/14 (2006.01)			

Podnosilac evropske prijave patenta (71)	MKP (51)	Broj objave evropske prijave patenta (97)	Naziv pronalaska (54)
	C07D 451/04 (2006.01)		
	C07D 471/04 (2006.01)		
	C07D 471/10 (2006.01)		
	C07D 487/04 (2006.01)		
	C07D 487/10 (2006.01)		
	C07D 493/10 (2006.01)		
	A61K 31/7088 (2006.01)	3633035	EXON SKIPPING COMPOSITIONS FOR TREATING MUSCULAR DYSTROPHY
	A61P 21/00 (2006.01)		
	C12N 15/11 (2006.01)		
	C12N 15/113 (2010.01)		
	A61K 8/34 (2006.01)	3616678	TOPICAL COMPOSITION CONTAINING GLYCERIN AND YEAST EXTRACT
	A61K 8/9728 (2017.01)		
	A61Q 19/00 (2006.01)		
	A61K 31/4375 (2006.01)	3617206	INTEGRIN INHIBITORS
	A61P 11/00 (2006.01)		
	C07D 471/04 (2006.01)		
	A61K 8/67 (2006.01)	3616681	TOPICAL COMPOSITIONS COMPRISING PICHIA ANOMALA AND RETINOL
	A61K 8/9728 (2017.01)		
	A61Q 19/00 (2006.01)		
	A61K 8/60 (2006.01)	3616684	TOPICAL COMPOSITIONS COMPRISING PICHIA ANOMALA AND N-ACETYL GLUCOSAMINE
	A61K 8/9728 (2017.01)		
	A61Q 17/00 (2006.01)		
	A61Q 19/00 (2006.01)		
	A01N 63/00 (2020.01)	3628161	SYNERGISTIC BACTERIAL COMPOSITIONS AND METHODS OF PRODUCTION AND USE THEREOF
	A01N 65/00 (2009.01)		
	A61K 35/742 (2015.01)		
	A61K 35/744 (2015.01)		
	A61K 35/745 (2015.01)		
	A61K 35/747 (2015.01)		
	A61P 1/12 (2006.01)		
	A61P 31/04 (2006.01)		
	C07D 471/04 (2006.01)	3656771	PROCESS FOR THE PREPARATION OF A SYNTHETIC INTERMEDIATE FOR APOPTOSIS-INDUCING AGENTS
Austrian Audio GmbH	G10K 11/178 (2006.01)	3624112	IN-EAR ANC EARPHONE
	H04R 1/10 (2006.01)		

Podnosilac evropske prijave patenta (71)	MKP (51)	Broj objave evropske prijave patenta (97)	Naziv pronalaska (54)
	A61K 8/31 (2006.01) A61K 8/37 (2006.01) A61K 8/39 (2006.01) A61K 8/67 (2006.01) A61K 8/86 (2006.01) A61P 17/00 (2006.01) A61P 17/10 (2006.01) A61Q 19/00 (2006.01) A61Q 19/06 (2006.01) A61Q 19/08 (2006.01)	3620213	RETINOL OIL COMPOSITION
Rolanfer Materiel ferroviaire	B61D 7/20 (2006.01) B61D 7/28 (2006.01) B61D 7/32 (2006.01) E01B 27/02 (2006.01) E05F 11/48 (2006.01) E05F 15/689 (2015.01)	3623245	DEVICE FOR UNLOADING BALLAST, AND RAILWAY VEHICLE FOR BALLASTING EQUIPPED WITH SUCH A DEVICE
	B60P 1/16 (2006.01) B60P 1/64 (2006.01)	3636867	DEVICE AND METHOD FOR CONNECTING TWO COMPONENTS, ESPECIALLY A MOTOR VEHICLE WINDOW REGULATOR
	B60P 1/64 (2006.01)	3623215	TRANSPORT VEHICLE FOR ROLLING CONTAINERS
Hüffermann Transportsysteme GmbH	A23L 3/00 (2006.01) A23L 3/04 (2006.01) B65B 55/02 (2006.01) B65B 55/04 (2006.01) B65B 55/10 (2006.01)	3623218	CARRIAGE FOR A TRANSPORT VEHICLE FOR TRANSPORTING ROLLING CONTAINERS
	A23L 3/00 (2006.01) A23L 3/04 (2006.01) B65B 55/02 (2006.01) B65B 55/04 (2006.01) B65B 55/10 (2006.01)	3650363	FOOD PROCESSING SYSTEM WITH SEVERAL CLOSED AREAS, BETWEEN WHICH A CONTAINER CONVEYOR IS ARRANGED
	A61K 31/4985 (2006.01) A61P 35/00 (2006.01) C07D 487/04 (2006.01)	3613745	SOLID FORMS AND FORMULATIONS OF (S)-4-(8-AMINO-3-(1-(BUT-2-YNOYL)PYRROLIDIN-2-YL)IMIDAZO[1,5-A]PYRAZIN-1-YL)-N-(PYRIDIN-2-YL)BENZAMIDE
	C07K 16/24 (2006.01) G01N 33/53 (2006.01)	3653645	INTERLEUKIN-31 MONOCLONAL ANTIBODY
	C12N 5/0781 (2010.01) C12N 5/0783 (2010.01)	3647412	METHODS FOR ISOLATING, CULTURING, AND GENETICALLY ENGINEERING IMMUNE CELL POPULATIONS FOR ADOPTIVE THERAPY
G1 Therapeutics, Inc.	A61K 31/44 (2006.01) A61K 31/519 (2006.01) A61K 31/527 (2006.01) A61P 35/00 (2006.01)	3653209	TRANSIENT PROTECTION OF NORMAL CELLS DURING CHEMOTHERAPY

Podnosilac evropske prijave patenta (71)	MKP (51)	Broj objave evropske prijave patenta (97)	Naziv pronalaska (54)		
Renner AG	C07D 491/14 (2006.01)	3627024	INSERTABLE TUBE CLAMP WITH FRAME AND CLAMP		
	F16B 21/02 (2006.01)				
	F16L 1/024 (2006.01)				
	F16L 3/10 (2006.01)				
	F16L 3/24 (2006.01)				
	H02G 3/30 (2006.01)				
	H02G 3/32 (2006.01)				
	F16B 21/02 (2006.01)			3627025	INSERTABLE TUBE CLAMP WITH FLOOR PLATE
	F16L 1/024 (2006.01)				
	F16L 3/10 (2006.01)				
	F16L 3/24 (2006.01)				
	H02G 3/30 (2006.01)				
	H02G 3/32 (2006.01)				
	A61K 47/68 (2017.01)				
A61P 35/00 (2006.01)					
C07K 16/28 (2006.01)					
A61K 31/337 (2006.01)	3620159	THERAPEUTIC TREATMENT			
A61K 31/519 (2006.01)					
A61P 35/00 (2006.01)					
A61K 39/00 (2006.01)	3660029	USE OF CHIMERIC ANTIGEN RECEPTOR-MODIFIED T CELLS TO TREAT CANCER			
C07H 21/04 (2006.01)					
A61K 31/225 (2006.01)			3650042	DIMETHYL FUMARATE AND VACCINATION REGIMENS	
A61K 39/05 (2006.01)					
A61K 39/09 (2006.01)					
A61P 25/28 (2006.01)					
A61P 31/00 (2006.01)					
C07D 487/04 (2006.01)	3653628	METHODS OF PREPARING CYTOTOXIC BENZODIAZEPINE DERIVATIVES METHOD AND DEVICE FOR RAISING JUVENILE FARM ANIMALS			
A01K 29/00 (2006.01)	3745850				
A01K 31/18 (2006.01)					
A01K 31/19 (2006.01)					
A01K 31/22 (2006.01)					
B61C 17/00 (2006.01)	3725635	ACTIVATION CONTROL METHOD AND DEVICE FOR RAIL TRAIN DISPENSING CONTAINER WITH INTERIOR ACCESS			
B65D 23/00 (2006.01)	3717371				
B65D 43/16 (2006.01)					
B65D 81/32 (2006.01)					

Podnosilac evropske prijave patenta (71)	MKP (51)	Broj objave evropske prijave patenta (97)	Naziv pronalaska (54)
CRRG QINGDAO SIFANG CO., LTD.	B65D 81/38 (2006.01)	3725638	COLLISION ENERGY ABSORPTION STRUCTURE AND RAIL VEHICLE HAVING SAME
	B65D 85/80 (2006.01)		
	B61D 17/00 (2006.01)		
	B61F 1/00 (2006.01)		
Tianjin University	B61F 19/04 (2006.01)	3756606	SURGICAL ROBOT MECHANISM WITH SINGLE-PORT AND MULTI-PORT MINIMALLY INVASIVE OPERATION FUNCTIONS
	A61B 17/00 (2006.01)		
	A61B 34/30 (2016.01)		
Tencent Technology (Shenzhen) Company Limited	G06F 3/048 (2013.01)	3742269	VIEWING ANGLE ADJUSTMENT METHOD AND APPARATUS, STORAGE MEDIUM, AND ELECTRONIC APPARATUS
Hefei Institutes of Physical Science, Chinese Academy of Sciences	A61N 2/00 (2006.01)	3744392	METHOD FOR CARTILAGE REGENERATION, MAGNETIC PULSE DEVICE, AND COIL APPLIED TO MAGNETIC PULSE DEVICE
Elkom Trade Spółka Akcyjna	B08B 3/02 (2006.01)	3623064	A DEVICE AND METHOD FOR WASHING STORAGE CONTAINERS
	B08B 9/08 (2006.01)		
Dompé farmaceutici S.p.a.	A61K 31/437 (2006.01)	3735411	1, 3, 4, 5-TETRAHYDRO-2H-PYRIDO[4,3-B]INDOLE DERIVATIVES FOR THE TREATMENT, ALLEVIATION OR PREVENTION OF DISORDERS ASSOCIATED WITH TAU AGGREGATES LIKE ALZHEIMER'S DISEASE
	A61P 25/28 (2006.01)		
	C07D 471/04 (2006.01)		
	A61K 9/20 (2006.01)		
Dompé farmaceutici S.p.a.	A61K 31/192 (2006.01)	3735227	IMMEDIATE-RELEASE PHARMACEUTICAL COMPOSITIONS CONTAINING KETOPROFEN LYSINE SALT
	A61K 31/205 (2006.01)		
	B44C 1/22 (2006.01)		
Dompé farmaceutici S.p.a.	C23F 1/02 (2006.01)	3737780	PROCESS FOR MAKING ETCHED PATTERNS
	A61K 31/4184 (2006.01)	3740478	FUSED IMIDAZOLE DERIVATIVES AS IL-17 MODULATORS
	A61P 29/00 (2006.01)		
	C07D 403/12 (2006.01)		
	C07D 403/14 (2006.01)		
	C07D 405/14 (2006.01)		
	C07D 413/12 (2006.01)		
	C07D 413/14 (2006.01)		
	C07D 487/04 (2006.01)		
	A61K 31/519 (2006.01)	3740489	PI4KIIIBETA INHIBITORS
	A61P 31/16 (2006.01)		
	C07D 487/04 (2006.01)		
A61K 9/00 (2006.01)	3740191	OPHTHALMIC COMPOSITIONS COMPRISING BILASTINE, A BETA-CYCLODEXTRIN AND AT LEAST ONE GELLING AGENT	
A61K 31/454 (2006.01)			
A61K 47/40 (2006.01)			
A61P 27/14 (2006.01)			

Podnosilac evropske prijave patenta (71)	MKP (51)	Broj objave evropske prijave patenta (97)	Naziv pronalaska (54)		
HepaRegeniX GmbH	A61K 31/437 (2006.01)	3746437	PROTEIN KINASE MKK4 INHIBITORS FOR PROMOTING LIVER REGENERATION OR REDUCING OR PREVENTING HEPATOCYTE DEATH		
	A61P 1/16 (2006.01)				
	A61P 19/02 (2006.01)				
	A61P 25/00 (2006.01)				
	C07D 405/04 (2006.01)				
	C07D 471/04 (2006.01)				
	A61K 35/74 (2015.01)			3740218	COMBINATION THERAPY FOR TREATING OR PREVENTING CANCER
	A61K 39/395 (2006.01)				
	A61P 35/00 (2006.01)			3740492	1,2,3',5'-TETRAHYDRO-2'H-SPIRO[INDOLE-3,1'-PYRROLO[3,4-C]PYRROLE]-2,3'-DIONE COMPOUNDS AS THERAPEUTIC AGENTS ACTIVATING TP53
	A61K 31/407 (2006.01)				
	A61P 35/00 (2006.01)				
	A61P 37/00 (2006.01)				
	C07D 487/10 (2006.01)				
	A61K 9/00 (2006.01)				
A61K 31/7105 (2006.01)					
A61K 39/12 (2006.01)					
C12N 15/87 (2006.01)					
Genmab B.V.	C07K 16/00 (2006.01)	3743440	POLYPEPTIDE VARIANTS AND USES THEREOF		
	C07K 16/28 (2006.01)				
	C07K 16/30 (2006.01)	3746450	HETEROCYCLYL-SUBSTITUTED OXADIAZOLOPYRIDINE DERIVATIVES FOR USE AS GHRELIN O-ACYL TRANSFERASE (GOAT) INHIBITORS		
	A61K 31/437 (2006.01)				
	A61P 3/04 (2006.01)				
	A61P 3/10 (2006.01)				
	C07D 498/04 (2006.01)				
	A01N 25/04 (2006.01)			3737232	HERBICIDAL COMPOSITIONS COMPRISING A CAPSULE SUSPENSION FORMULATION OF PETHOXAMID
	A01N 25/28 (2006.01)				
	A01N 37/20 (2006.01)	3743160	SURFACE-REACTED CALCIUM CARBONATE FOR THE USE AS SKIN APPEARANCE MODIFIER		
	A61K 8/02 (2006.01)				
	A61K 8/19 (2006.01)				
A61Q 1/02 (2006.01)					
A61Q 1/06 (2006.01)					
A61Q 1/10 (2006.01)					
C01F 11/18 (2006.01)					
A61K 8/02 (2006.01)	3743164			SURFACE-REACTED CALCIUM CARBONATE FOR MODIFYING THE BIOMECHANICAL PROPERTIES OF THE SKIN	
A61K 8/19 (2006.01)					

Podnosilac evropske prijave patenta (71)	MKP (51)	Broj objave evropske prijave patenta (97)	Naziv pronalaska (54)
	A61Q 19/00 (2006.01)		
	A61Q 19/08 (2006.01)		
	A61K 31/437 (2006.01)	3746451	BENZYL-, (PYRIDIN-3-YL)METHYL- OR (PYRIDIN-4-YL)METHYL-SUBSTITUTED OXADIAZOLOPYRIDINE DERIVATIVES AS GHRELIN O-ACYL TRANSFERASE (GOAT) INHIBITORS
	A61K 31/444 (2006.01)		
	A61K 31/4545 (2006.01)		
	A61K 31/497 (2006.01)		
	A61K 31/501 (2006.01)		
	A61K 31/5377 (2006.01)		
	A61P 3/00 (2006.01)		
	A61P 3/10 (2006.01)		
	C07D 498/04 (2006.01)		
	C07D 519/00 (2006.01)		
	A61K 31/519 (2006.01)	3746443	TRIAZOLOPYRIMIDINE DERIVATIVES FOR USE AS GHRELIN O-ACYL TRANSFERASE (GOAT) INHIBITORS
	A61P 3/00 (2006.01)		
	C07D 487/04 (2006.01)		
Sixty AS	H04N 21/63 (2011.01)	3744106	A LIVE VIDEO RENDERING AND BROADCASTING SYSTEM
	A23L 33/16 (2016.01)	3746045	USE OF FUNCTIONALIZED CALCIUM CARBONATE AS ACTIVE INGREDIENT
	A61K 9/00 (2006.01)		
	A61K 33/10 (2006.01)		
	A61K 31/519 (2006.01)	3746444	CYCLOALKYL SUBSTITUTED PYRAZOLOPYRIMIDINES HAVING ACTIVITY AGAINST RSV
	A61P 31/14 (2006.01)		
	C07D 487/04 (2006.01)		
	B01J 19/00 (2006.01)	3749668	CONTINUOUS PROCESS FOR THE PREPARATION OF TRAZODONE
	C07D 471/04 (2006.01)		
Philogen S.p.A.	A61K 47/68 (2017.01)	3749372	EDB TARGETING IL-12 COMPOSITIONS
	A61P 35/00 (2006.01)		
	C07K 14/54 (2006.01)		
	C07K 16/18 (2006.01)		
INSTIL BIO (UK) LIMITED	A61K 35/17 (2015.01)	3743511	BIOMARKER PREDICTIVE OF TUMOUR INFILTRATING LYMPHOCYTE THERAPY AND USES THEREOF
	C12N 5/0783 (2010.01)		
	A61K 31/712 (2006.01)	3737387	ANTISENSE OLIGONUCLEOTIDES TARGETING ALPHA-SYNUCLEIN AND USES THEREOF
	C12N 15/113 (2010.01)		
Roche Innovation Center Copenhagen A/S	C07K 14/47 (2006.01)	3737761	ANTISENSE OLIGONUCLEOTIDES TARGETING ALPHA-SYNUCLEIN AND USES THEREOF
	C12N 15/113 (2010.01)		
Enterprise Therapeutics Limited	A61P 11/00 (2006.01)	3743406	COMPOUNDS

Podnosilac evropske prijave patenta (71)	MKP (51)	Broj objave evropske prijave patenta (97)	Naziv pronalaska (54)
Estetra SPRL	C07C 1/00 (2006.01)		
	C07D 213/72 (2006.01)		
	C07D 309/10 (2006.01)		
	C07D 401/12 (2006.01)		
	C07D 405/12 (2006.01)		
	C07D 413/12 (2006.01)		
	C07D 417/12 (2006.01)		
	A61K 31/565 (2006.01)	3749327	CONTRACEPTIVE COMPOSITION WITH REDUCED CARDIOVASCULAR EFFECTS
	A61P 15/18 (2006.01)		
	A61K 35/74 (2015.01)	3740219	COMBINATION THERAPY FOR TREATING OR PREVENTING CANCER
A61K 39/395 (2006.01)			
A61P 35/00 (2006.01)			
A61K 35/74 (2015.01)	3740220	COMBINATION THERAPY FOR TREATING OR PREVENTING CANCER	
A61K 39/395 (2006.01)			
A61P 35/00 (2006.01)			
Bohnen, Eileen	A41D 1/22 (2018.01)	3752018	ITEM OF CLOTHING HAVING A MODULAR STRUCTURE
	A61K 31/7105 (2006.01)	3752177	TREATMENT USING CYTOKINE ENCODING RNA
	A61K 31/713 (2006.01)		
	A61K 38/20 (2006.01)		
	A61K 39/21 (2006.01)		
	C07K 14/54 (2006.01)		
	C07K 14/55 (2006.01)		
	C07K 14/565 (2006.01)		
	C07K 14/765 (2006.01)		
	C12N 15/62 (2006.01)		
	C07C 237/06 (2006.01)	3737679	NOVEL PROCESSES AND INTERMEDIATES FOR THE PREPARATION OF SOLUBLE GUANYLATE CYCLASE STIMULATORS
	C07D 239/34 (2006.01)		
	C07D 263/06 (2006.01)		
	C07D 413/14 (2006.01)		
	A61K 47/54 (2017.01)	3737694	ANTI-PD-1 ANTIBODIES AND METHODS OF TREATMENT
	A61K 47/60 (2017.01)		
	C07K 14/54 (2006.01)		
	C07K 16/28 (2006.01)		
	A61K 31/506 (2006.01)	3740479	DNA-PK INHIBITORS
	A61K 31/5377 (2006.01)		

Podnosilac evropske prijave patenta (71)	MKP (51)	Broj objave evropske prijave patenta (97)	Naziv pronalaska (54)
Ferring B.V.	A61K 31/5386 (2006.01)	3740264	DRUG DELIVERY MECHANISM
	A61P 35/00 (2006.01)		
	C07D 403/12 (2006.01)		
	C07D 413/12 (2006.01)	3752648	BUILDING MATERIALS COMPRISING DIGESTATE
	C12N 15/10 (2006.01)		
	A61M 5/142 (2006.01)		
	A61M 5/145 (2006.01)	3735219	ORAL LIQUID PHARMACEUTICAL COMPOSITIONS OF AMINOSALICYLATES
	A61M 5/315 (2006.01)		
	B09B 3/00 (2006.01)		
	C04B 33/04 (2006.01)		
	C04B 33/132 (2006.01)		
	C04B 33/135 (2006.01)		
	C04B 33/30 (2006.01)		
	C04B 33/32 (2006.01)		
	C12R 1/00 (2006.01)		
	A61K 9/00 (2006.01)		
	A61K 9/10 (2006.01)		
	A61K 9/16 (2006.01)		
	A61K 9/50 (2006.01)	3735270	POLYNUCLEOTIDES ENCODING ANTI-CHIKUNGUNYA VIRUS ANTIBODIES
	A61J 1/14 (2006.01)		
	B08B 11/00 (2006.01)		
	C03C 23/00 (2006.01)		
	G01N 17/00 (2006.01)		
	G01N 21/90 (2006.01)		
	G01N 33/38 (2006.01)		
	A61K 39/395 (2006.01)		
	A61K 39/42 (2006.01)		
	A61P 31/14 (2006.01)		
	C07K 16/10 (2006.01)		
	A61K 35/17 (2015.01)	3737687	AZA-, OXA AND THIA-PREGNAN-20-ONE-3.ALPHA.-OL COMPOUNDS FOR USE IN TREATING CNS DISORDERS
	C12N 5/0783 (2010.01)		
	A61K 31/58 (2006.01)		
	A61P 25/00 (2006.01)		
C07J 73/00 (2006.01)			
C07J 75/00 (2006.01)			

Podnosilac evropske prijave patenta (71)	MKP (51)	Broj objave evropske prijave patenta (97)	Naziv pronalaska (54)		
RADIUS PHARMACEUTICALS, INC.	A61K 31/7115 (2006.01)	3740575	MODULATORS OF DNM2 EXPRESSION		
	A61K 31/712 (2006.01)				
	A61K 31/7125 (2006.01)				
	C12N 15/113 (2010.01)	3740480	DNA-PK INHIBITORS		
	A61P 35/00 (2006.01)				
	C07D 239/74 (2006.01)				
	C07D 239/86 (2006.01)				
	C07D 239/88 (2006.01)				
	C07D 239/94 (2006.01)				
	C07D 401/12 (2006.01)				
	C07D 403/12 (2006.01)				
	C07D 417/12 (2006.01)				
	C07D 491/048 (2006.01)				
	A61K 31/4196 (2006.01)			3740481	DIHYDROBENZOFURAN AND INDEN ANALOGS AS CARDIAC SARCOMERE INHIBITORS
	A61P 9/04 (2006.01)				
	C07D 231/14 (2006.01)				
	C07D 271/06 (2006.01)				
	C07D 401/12 (2006.01)				
	C07D 403/12 (2006.01)				
	C07D 413/04 (2006.01)				
	C07D 413/12 (2006.01)				
	C07D 413/14 (2006.01)				
	C07D 417/12 (2006.01)				
	A61K 39/395 (2006.01)	3749360	PHARMACEUTICAL COMPOSITIONS COMPRISING BISPECIFIC ANTIBODIES DIRECTED AGAINST CD3 AND CD20 AND THEIR USES		
	A61P 35/00 (2006.01)				
	C07K 16/28 (2006.01)				
	A61K 31/404 (2006.01)	3743413	ESTROGEN RECEPTOR-MODULATING COMPOUNDS		
	A61P 35/00 (2006.01)				
	C07C 215/48 (2006.01)				
	C07D 209/12 (2006.01)				
	C07D 209/30 (2006.01)				
	C07D 313/08 (2006.01)				
	C07D 333/64 (2006.01)				
	C07D 409/12 (2006.01)				
	C07D 487/04 (2006.01)				

Podnosilac evropske prijave patenta (71)	MKP (51)	Broj objave evropske prijave patenta (97)	Naziv pronalaska (54)	
Local Motors IP, LLC	B29C 64/245 (2017.01)	3743262	ADDITIVELY MANUFACTURED STRUCTURE AND METHOD FOR MAKING THE SAME	
	B29C 64/40 (2017.01)			
	B33Y 10/00 (2015.01)	3755708	PEPTIDES AND COMBINATION OF PEPTIDES OF NON-CANONICAL ORIGIN FOR USE IN IMMUNOTHERAPY AGAINST DIFFERENT TYPES OF CANCERS	
	B33Y 30/00 (2015.01)			
	A61K 38/08 (2019.01)			
	C07K 7/06 (2006.01)	3740221	COMBINATION THERAPY FOR TREATING OR PREVENTING CANCER	
	C07K 14/47 (2006.01)			
	Healthy Bees, LLC	A61K 35/74 (2015.01)	3740221	COMBINATION THERAPY FOR TREATING OR PREVENTING CANCER
		A61K 39/395 (2006.01)		
		A61P 35/00 (2006.01)	3737241	NUTRITIONAL SOLID COMPOSITIONS WITH ACARICIDE ACTIVITY FOR APICULTURE AND THEIR USE FOR THE PROPHYLAXIS AND TREATMENT OF VARROA INFESTATIONS
A23K 20/10 (2016.01)				
A23K 20/105 (2016.01)				
A23K 20/147 (2016.01)				
A23K 20/158 (2016.01)				
A23K 20/163 (2016.01)				
A23K 50/90 (2016.01)				
A61K 36/00 (2006.01)				
A61K 36/02 (2006.01)				
A61K 36/05 (2006.01)				
A61K 36/06 (2006.01)				
A61K 36/53 (2006.01)		3752487	USE OF 5-FLUORO-4-(4-FLUORO-2-METHOXYPHENYL)-N-[4-[(S-METHYLSULFONIMIDOYL)METHYL]PYRIDIN-2-YL]PYRIDIN-2-AMINE FOR TREATING DIFFUSE LARGE B-CELL LYMPHOMA	
A61K 36/886 (2006.01)				
A61K 31/4427 (2006.01)				
A61P 35/00 (2006.01)		3752151	THIOREDOXIN REDUCTASE INHIBITORS FOR USE IN THE TREATMENT OF CANCER	
C07D 213/72 (2006.01)				
A61K 31/166 (2006.01)				
A61K 31/282 (2006.01)				
A61K 31/337 (2006.01)				
A61K 31/436 (2006.01)				
A61K 31/439 (2006.01)				
A61K 31/44 (2006.01)				
A61K 31/4433 (2006.01)				
A61K 31/501 (2006.01)				
A61K 31/506 (2006.01)				
A61K 31/7135 (2006.01)				
Cinda Pharma AB				

Podnosilac evropske prijave patenta (71)	MKP (51)	Broj objave evropske prijave patenta (97)	Naziv pronalaska (54)
	A61K 39/395 (2006.01)		
	A61K 45/06 (2006.01)		
	A61P 35/00 (2006.01)		
	A61P 35/04 (2006.01)		
	A61K 31/4375 (2006.01)	3743068	COMPOUNDS FOR THE TREATMENT OF KINASE-DEPENDENT DISORDERS
	A61K 31/517 (2006.01)		
	A61P 35/00 (2006.01)		
	C07D 239/88 (2006.01)		
	C07D 471/04 (2006.01)		
	A61K 31/47 (2006.01)	3743070	COMPOUNDS FOR THE TREATMENT OF KINASE-DEPENDENT DISORDERS
	A61K 31/4709 (2006.01)		
	A61P 35/00 (2006.01)		
	C07D 215/22 (2006.01)		
	C07D 401/04 (2006.01)		
	C07D 401/06 (2006.01)		
	C07D 401/12 (2006.01)		
	C07D 405/04 (2006.01)		
	C07D 405/12 (2006.01)		
	C07D 413/04 (2006.01)		
	C07D 413/12 (2006.01)		
	C07D 213/61 (2006.01)	3746429	PROCESSES FOR PREPARING (1 -(3-FLUORO-2-(TRIFLUOROMETHYL)ISONICOTINYL)PIPERIDINE-4-ONE)
	C07D 401/04 (2006.01)		
	A61K 48/00 (2006.01)	3746136	USE OF LENTIVIRAL VECTORS EXPRESSING FACTOR VIII
	C07K 14/755 (2006.01)		
	C12N 15/867 (2006.01)		
Aelis Farma INSERM (Institut National de la Santé et de la Recherche Médicale) UNIVERSITE DE BORDEAUX Magenta Therapeutics, Inc.	A61K 31/57 (2006.01)	3755339	3BETA-(4-METHOXYBENZYLOXY)PREGN-5-EN-20-ONE FOR USE IN THE TREATMENT OF CANNABINOIDS-RELATED DISORDERS
	A61P 25/30 (2006.01)		
	A61K 35/12 (2015.01)	3735412	COMPOSITIONS AND METHODS FOR THE EXPANSION OF HEMATOPOIETIC STEM AND PROGENITOR CELLS AND TREATMENT OF INHERITED METABOLIC DISORDERS
	C07D 471/04 (2006.01)		
	C07D 487/04 (2006.01)		
	C07D 519/00 (2006.01)		
	C12N 5/0789 (2010.01)		
Cybrexa 1, Inc.	A61K 31/454 (2006.01)	3735297	COMPOUNDS, COMPOSITIONS, AND METHODS FOR TREATMENT OF DISEASES INVOLVING ACIDIC OR HYPOXIC DISEASED TISSUES
	A61K 38/16 (2006.01)		

Podnosilac evropske prijave patenta (71)	MKP (51)	Broj objave evropske prijave patenta (97)	Naziv pronalaska (54)
	A61P 9/00 (2006.01)		
	A61P 25/28 (2006.01)		
	A61P 35/00 (2006.01)		
	C07D 487/06 (2006.01)		
	A61K 47/68 (2017.01)	3737420	STEROIDS AND ANTIBODY-CONJUGATES THEREOF
	C07J 71/00 (2006.01)		
Selvaraj, Anand Smith, Peter	A61K 31/47 (2006.01)	3737377	COMBINATION THERAPIES FOR THE TREATMENT OF HEPATOCELLULAR CARCINOMA
	A61K 31/496 (2006.01)		
	A01G 17/06 (2006.01)	3742886	SUPPORTING DEVICE ON A SUPPORTING POLE, IN PARTICULAR FOR CONTAINMENT WIRES OF A ROW
Universität Zürich	A61P 37/06 (2006.01)	3755715	LIGANDS TO GM-CSF OR GM-CSF-RECEPTOR FOR USE IN TREATMENT OF A HAEMATOLOGIC MALIGNANCY IN A PATIENT HAVING UNDERGONE ALLO-HCT
	C07K 16/24 (2006.01)		
	A61K 39/00 (2006.01)	3737701	TRANSFERRIN RECEPTOR-BINDING POLYPEPTIDES AND USES THEREOF
	A61K 39/395 (2006.01)		
	A61P 25/00 (2006.01)		
	A61P 25/28 (2006.01)		
	A61P 35/02 (2006.01)		
	C07K 16/28 (2006.01)		
APNIMED, INC. (DELAWARE)	A61K 31/138 (2006.01)	3746126	METHODS AND COMPOSITIONS FOR TREATING SLEEP APNEA
	A61K 31/216 (2006.01)		
	A61K 45/06 (2006.01)		
	A61P 11/00 (2006.01)		
	A61P 25/00 (2006.01)		
	G01N 33/542 (2006.01)	3729088	ASSAY, METHOD AND TREATMENT OF ALPHA-SYNUCLEINOPATHIES
	G01N 33/58 (2006.01)		
	G01N 33/68 (2006.01)		
BIAL - PORTELA & C ^a , S.A.	A61K 31/4188 (2006.01)	3720856	DOPAMINE-& X392;-HYDROXYLASE INHIBITORS
	A61P 25/00 (2006.01)		
	C07D 487/14 (2006.01)		
	A61K 35/17 (2015.01)	3724225	ANTI-CCT5 BINDING MOLECULES AND METHODS OF USE THEREOF
	A61K 39/00 (2006.01)		
	A61P 35/00 (2006.01)		
	C07K 16/18 (2006.01)		
	C07K 16/46 (2006.01)		
Ribon Therapeutics Inc.	A61K 31/517 (2006.01)	3728207	QUINAZOLINONES AS PARP14 INHIBITORS
	A61P 29/00 (2006.01)		

Podnosilac evropske prijave patenta (71)	MKP (51)	Broj objave evropske prijave patenta (97)	Naziv pronalaska (54)
Agbiome, Inc.	A61P 35/00 (2006.01)		
	C07D 239/88 (2006.01)		
	C07D 401/12 (2006.01)		
	C07D 401/14 (2006.01)		
	C07D 405/12 (2006.01)		
	C07D 405/14 (2006.01)		
	C07D 413/14 (2006.01)		
	C07D 417/14 (2006.01)		
	C07K 14/705 (2006.01)	3717509	SynP61, A PRIMATE RETINAL PIGMENT EPITHELIUM CELL-SPECIFIC PROMOTER
	C12N 15/85 (2006.01)		
	C12N 15/85 (2006.01)	3717651	SYNPIII, A PROMOTER FOR THE SPECIFIC EXPRESSION OF GENES IN RETINAL PIGMENT EPITHELIUM
	H01G 9/04 (2006.01)	3729527	ACTIVE MATERIAL AND ELECTRIC POWER GENERATOR CONTAINING IT
	H01L 35/22 (2006.01)		
	A61K 31/506 (2006.01)	3727388	SGC STIMULATORS
	C07D 487/04 (2006.01)		
	C07F 9/09 (2006.01)		
	A01N 63/02 (2006.01)	3728606	PESTICIDAL GENES AND METHODS OF USE
	C07K 14/32 (2006.01)		
	C07K 14/325 (2006.01)		
	C12N 15/31 (2006.01)		
	C12N 15/32 (2006.01)		
	C12N 15/82 (2006.01)		
	A61K 38/45 (2006.01)	3727428	IMPROVED COMPOSITION AND METHODS FOR TREATMENT OF ORNITHINE TRANSCARBAMYLASE DEFICIENCY
	A61P 3/00 (2006.01)		
	A61K 9/127 (2006.01)	3735226	INJECTABLE COMPOSITIONS OF TRITERPENOID ANTIFUNGALS ENCAPSULATED IN LIPOSOMES
	A61K 31/4196 (2006.01)		
	A61K 31/44 (2006.01)	3732164	USE OF 1-PHENYL-2-PYRIDINYL ALKYL ALCOHOL DERIVATIVES FOR TREATING CYSTIC FIBROSIS
A61P 11/00 (2006.01)			
A61P 37/00 (2006.01)			
C07D 213/61 (2006.01)			
C07D 213/89 (2006.01)			
A61K 31/55 (2006.01)	3724192	TRIAZOLOBENZAZEPINES AS VASOPRESSIN V1A RECEPTOR ANTAGONISTS	
A61P 25/00 (2006.01)			
A61P 25/24 (2006.01)			
C07D 223/06			

Podnosilac evropske prijave patenta (71)	MKP (51)	Broj objave evropske prijave patenta (97)	Naziv pronalaska (54)		
Lupin Limited	(2006.01) C07D 223/10 (2006.01) C07D 487/04 (2006.01) C07D 487/14 (2006.01) A61K 31/519 (2006.01) A61K 31/53 (2006.01) A61P 35/00 (2006.01) C07D 471/04 (2006.01) C07D 487/04 (2006.01) A61K 31/501 (2006.01) A61P 29/00 (2006.01) A61P 37/00 (2006.01) C07D 401/12 (2006.01) C07D 401/14 (2006.01) C07D 487/04 (2006.01)	3724190	SUBSTITUTED BICYCLIC HETEROCYCLIC COMPOUNDS AS PRMT5 INHIBITORS		
	Memento S.r.L.	(2006.01) A61K 31/501 (2006.01) A61P 29/00 (2006.01) A61P 37/00 (2006.01) C07D 401/12 (2006.01) C07D 401/14 (2006.01) C07D 487/04 (2006.01) A63H 33/00 (2006.01) C08K 3/26 (2006.01) C07K 16/28 (2006.01) C12Q 1/6851 (2018.01) A61K 31/519 (2006.01) A61K 31/52 (2006.01) A61K 31/5377 (2006.01) A61K 31/675 (2006.01) A61K 38/05 (2006.01) A61K 38/13 (2006.01) A61K 38/47 (2006.01) A61K 39/395 (2006.01) A61P 3/00 (2006.01) A61P 21/00 (2006.01) G01N 33/50 (2006.01) G01N 33/68 (2006.01) C12N 9/10 (2006.01) C12N 9/18 (2006.01) C12N 15/113 (2010.01) A61K 31/5513 (2006.01) A61K 47/68		3713930	SULFONE PYRIDINE ALKYL AMIDE-SUBSTITUTED HETEROARYL COMPOUNDS
		(2006.01) A63H 33/00 (2006.01) C08K 3/26 (2006.01) C07K 16/28 (2006.01) C12Q 1/6851 (2018.01) A61K 31/519 (2006.01) A61K 31/52 (2006.01) A61K 31/5377 (2006.01) A61K 31/675 (2006.01) A61K 38/05 (2006.01) A61K 38/13 (2006.01) A61K 38/47 (2006.01) A61K 39/395 (2006.01) A61P 3/00 (2006.01) A61P 21/00 (2006.01) G01N 33/50 (2006.01) G01N 33/68 (2006.01) C12N 9/10 (2006.01) C12N 9/18 (2006.01) C12N 15/113 (2010.01) A61K 31/5513 (2006.01) A61K 47/68		3720582	KIT COMPRISING A MOULD FOR KIDS AND A POWDER WATER-SENSITIVE MIXTURE FOR MAKING A BIJOU THROUGH SAID MOULD
		(2006.01) A61K 31/519 (2006.01) A61K 31/52 (2006.01) A61K 31/5377 (2006.01) A61K 31/675 (2006.01) A61K 38/05 (2006.01) A61K 38/13 (2006.01) A61K 38/47 (2006.01) A61K 39/395 (2006.01) A61P 3/00 (2006.01) A61P 21/00 (2006.01) G01N 33/50 (2006.01) G01N 33/68 (2006.01) C12N 9/10 (2006.01) C12N 9/18 (2006.01) C12N 15/113 (2010.01) A61K 31/5513 (2006.01) A61K 47/68		3728318	ANTIBODIES FOR LILRB2
		(2006.01) A61K 31/519 (2006.01) A61K 31/52 (2006.01) A61K 31/5377 (2006.01) A61K 31/675 (2006.01) A61K 38/05 (2006.01) A61K 38/13 (2006.01) A61K 38/47 (2006.01) A61K 39/395 (2006.01) A61P 3/00 (2006.01) A61P 21/00 (2006.01) G01N 33/50 (2006.01) G01N 33/68 (2006.01) C12N 9/10 (2006.01) C12N 9/18 (2006.01) C12N 15/113 (2010.01) A61K 31/5513 (2006.01) A61K 47/68		3727392	BIOMARKERS OF METHOTREXATE-INDUCED IMMUNE TOLERANCE
		(2006.01) A61K 31/519 (2006.01) A61K 31/52 (2006.01) A61K 31/5377 (2006.01) A61K 31/675 (2006.01) A61K 38/05 (2006.01) A61K 38/13 (2006.01) A61K 38/47 (2006.01) A61K 39/395 (2006.01) A61P 3/00 (2006.01) A61P 21/00 (2006.01) G01N 33/50 (2006.01) G01N 33/68 (2006.01) C12N 9/10 (2006.01) C12N 9/18 (2006.01) C12N 15/113 (2010.01) A61K 31/5513 (2006.01) A61K 47/68		3729085	QUANTITATIVE CELLULAR METHOD FOR DETERMINING THE BIOLOGICAL ACTIVITY OF AN ANTI-CD26 LIGAND
		(2006.01) A61K 31/519 (2006.01) A61K 31/52 (2006.01) A61K 31/5377 (2006.01) A61K 31/675 (2006.01) A61K 38/05 (2006.01) A61K 38/13 (2006.01) A61K 38/47 (2006.01) A61K 39/395 (2006.01) A61P 3/00 (2006.01) A61P 21/00 (2006.01) G01N 33/50 (2006.01) G01N 33/68 (2006.01) C12N 9/10 (2006.01) C12N 9/18 (2006.01) C12N 15/113 (2010.01) A61K 31/5513 (2006.01) A61K 47/68		3724337	RNAI CONSTRUCTS FOR INHIBITING PNPLA3 EXPRESSION
		(2006.01) A61K 31/519 (2006.01) A61K 31/52 (2006.01) A61K 31/5377 (2006.01) A61K 31/675 (2006.01) A61K 38/05 (2006.01) A61K 38/13 (2006.01) A61K 38/47 (2006.01) A61K 39/395 (2006.01) A61P 3/00 (2006.01) A61P 21/00 (2006.01) G01N 33/50 (2006.01) G01N 33/68 (2006.01) C12N 9/10 (2006.01) C12N 9/18 (2006.01) C12N 15/113 (2010.01) A61K 31/5513 (2006.01) A61K 47/68		3732178	BENZODIAZEPINE DERIVATIVES

Podnosilac evropske prijave patenta (71)	MKP (51)	Broj objave evropske prijave patenta (97)	Naziv pronalaska (54)
	(2017.01) A61P 35/00 (2006.01) C07D 471/04 (2006.01) C07D 487/04 (2006.01) A61P 35/00 (2006.01) C07K 16/28 (2006.01) C07K 16/30 (2006.01) C07K 16/46 (2006.01) A61K 39/29 (2006.01) A61K 39/295 (2006.01) A61P 31/20 (2006.01) G06F 21/62 (2013.01)	3732200	BISPECIFIC ANTIBODY CONSTRUCT DIRECTED TO MUC17 AND CD3
	A61K 39/29 (2006.01) C07K 14/02 (2006.01) C12N 7/00 (2006.01)	3727445	HEPATITIS B VIRUS (HBV) VACCINES AND USES THEREOF
	A61K 39/29 (2006.01) C07K 14/02 (2006.01) C12N 7/00 (2006.01)	3735648	METHOD AND SYSTEM FOR DATA SECURITY, VALIDATION, VERIFICATION AND PROVENANCE WITHIN INDEPENDENT COMPUTER SYSTEMS AND DIGITAL NETWORKS
	A61K 39/29 (2006.01) C07K 14/02 (2006.01) C12N 7/00 (2006.01)	3727446	METHODS AND COMPOSITIONS FOR INDUCING AN IMMUNE RESPONSE AGAINST HEPATITIS B VIRUS (HBV)
Oceans of Energy B.V.	B63B 35/34 (2006.01) A61K 31/56 (2006.01) A61K 31/57 (2006.01) A61K 31/575 (2006.01) A61K 31/58 (2006.01) A61P 25/00 (2006.01) C07J 1/00 (2006.01) C07J 3/00 (2006.01) C07J 5/00 (2006.01) C07J 7/00 (2006.01) C07J 9/00 (2006.01) C07J 13/00 (2006.01) C07J 17/00 (2006.01) C07J 21/00 (2006.01) C07J 41/00 (2006.01) C07J 43/00 (2006.01) C07J 51/00 (2006.01) C07J 71/00 (2006.01) A61K 31/57 (2006.01) A61P 25/00	3713837 3728284	ARRAY OF PONTOONS FOR SOLAR PANEL AND CONNECTION MODULES THEREFOR COMPOSITIONS AND METHODS FOR TREATING CNS DISORDERS
	A61K 31/57 (2006.01) A61P 25/00	3728285	COMPOSITIONS AND METHODS FOR TREATING CNS DISORDERS

Podnosilac evropske prijave patenta (71)	MKP (51)	Broj objave evropske prijave patenta (97)	Naziv pronalaska (54)
Immatics US, Inc.	(2006.01) A61K 31/7068	3740216	METHODS OF ASSESSING TRANSDUCTION POTENCY OF VIRAL VECTORS
	(2006.01) A61K 33/24		
	(2019.01) A61P 35/00		
	(2006.01) A61K 35/17	3749667	COMPOUNDS FOR THE TREATMENT OF PAIN
	(2015.01) A61P 35/00		
	(2006.01) C12N 5/10		
	(2006.01) C12N 15/867	3749301	PHARMACEUTICAL COMPOSITIONS FOR TREATING CYSTIC FIBROSIS
	(2006.01) A61K 31/439		
	(2006.01) A61P 25/04		
	(2006.01) A61P 29/00	3749352	PEDIATRIC NIRAPARIB FORMULATIONS AND PEDIATRIC TREATMENT METHODS
	(2006.01) C07D 453/02		
	(2006.01) A61K 31/404		
	(2006.01) A61K 31/443	3752148	PHARMACEUTICAL COMPOSITIONS COMPRISING TEIXOBACTIN
	(2006.01) A61K 31/4439		
	(2006.01) A61K 31/47		
(2006.01) A61P 11/00	3755688	INDOLE AND BENZIMIDAZOLE DERIVATIVES AS DUAL 5-HT2A AND 5-HT6 RECEPTOR ANTAGONISTS	
(2006.01) A61K 31/454			
(2006.01) A61K 39/00			
(2006.01) A61K 39/395	3752183	IMMUNOGENIC COMPOSITION COMPRISING STAPHYLOCOCCAL ANTIGENS	
(2006.01) A61K 45/06			
(2006.01) A61P 35/00			
(2006.01) A61K 31/4168			
(2006.01) A61K 31/685			
(2006.01) A61P 31/04			
(2006.01) A61P 31/06			
(2006.01) A61K 31/496			
(2006.01) A61P 25/00			
(2006.01) A61P 25/16			
(2006.01) A61P 25/18			
(2006.01) A61P 25/24			
(2006.01) A61P 25/28			
(2006.01) C07D 209/10			
(2006.01) C07D 235/10			
(2006.01) A61K 39/085			
(2006.01)			

Podnosilac evropske prijave patenta (71)	MKP (51)	Broj objave evropske prijave patenta (97)	Naziv pronalaska (54)		
Dolby Laboratories Licensing Corporation	A61P 31/04 (2006.01)	3756253	DISCHARGING DEVICE, ELECTRICAL UNIT AND DISCHARGING METHOD		
	H02H 9/00 (2006.01)				
	H02K 1/27 (2006.01)	3759800	ELECTRIC MOTOR		
	H02K 7/14 (2006.01)	3737762	COMPOSITIONS AND METHODS FOR GENE EDITING BY TARGETING TRANSFERRIN		
	H02K 21/22 (2006.01)				
	A61K 48/00 (2006.01)				
	C12N 15/113 (2010.01)				
	C12N 15/90 (2006.01)				
	C07D 241/44 (2006.01)	3740483	QUINOXALINONE COMPOUNDS, COMPOSITIONS, METHODS, AND KITS FOR INCREASING GENOME EDITING EFFICIENCY		
	C07D 403/12 (2006.01)	3752488	METHOD FOR PREPARING TERT-BUTYL N-((1R,2S,5S)-2-((2-((5-CHLOROPYRIDIN-2-YL)AMINO)-2-OXOACETYL)AMINO)-5-(DIMETHYLCARBAMOYL)CYCLOHEXYL)CARBAMATE		
	C07D 405/14 (2006.01)				
	C07D 491/048 (2006.01)				
	C07D 498/08 (2006.01)				
	C12N 15/00 (2006.01)				
	C07D 213/75 (2006.01)				
	C07D 513/04 (2006.01)				
	A61K 35/12 (2015.01)			3749752	PANCREATIC CELLS FOR TREATING DIABETES AND METHODS OF GENERATING THE SAME
	C12N 5/071 (2010.01)			3743159	METHODS OF TREATING CANCERS WITH ANTAGONISTIC ANTI-PD-1 ANTIBODIES
	C12N 5/074 (2010.01)				
	G01N 33/50 (2006.01)				
	A61K 39/00 (2006.01)				
	A61P 35/00 (2006.01)				
	C07K 16/28 (2006.01)	3743728	METHODS OF TREATING SPINAL MUSCULAR ATROPHY		
	G01N 33/68 (2006.01)	3749753	METHODS FOR MANUFACTURING T CELLS		
	C12N 5/0783 (2010.01)	3753253	IMAGE RESHAPING IN VIDEO CODING USING RATE DISTORTION OPTIMIZATION		
	H04N 19/107 (2014.01)				
	H04N 19/117 (2014.01)				
	H04N 19/147 (2014.01)				
H04N 19/159 (2014.01)					
H04N 19/176 (2014.01)					
H04N 19/46 (2014.01)					
H04N 19/503 (2014.01)					
H04N 19/82 (2014.01)					
H04N 19/85 (2014.01)					
A61K 31/437 (2006.01)	3752510	MACROCYCLES AS MODULATORS OF CYSTIC FIBROSIS TRANSMEMBRANE CONDUCTANCE			

Podnosilac evropske prijave patenta (71)	MKP (51)	Broj objave evropske prijave patenta (97)	Naziv pronalaska (54)	
GENENTECH, INC. CELGENE CORPORATION	A61P 11/00 (2006.01) C07D 513/22 (2006.01) C07D 515/22 (2006.01)	3752146	REGULATOR, PHARMACEUTICAL COMPOSITIONS THEREOF, THEIR USE IN THE TREATMENT OF CYCSTIC FIBROSIS, AND PROCESS FOR MAKING THEM	
	A61K 31/4155 (2006.01) A61K 31/437 (2006.01) A61K 31/519 (2006.01) A61P 37/00 (2006.01)		JAK1 PATHWAY INHIBITORS FOR THE TREATMENT OF CYTOKINE-RELATED DISORDERS	
	A61K 31/496 (2006.01) A61K 39/395 (2006.01) A61P 35/00 (2006.01) A61K 31/4192 (2006.01)		3752189	SELECTIVE BCL-2 INHIBITORS IN COMBINATION WITH AN ANTI-PD-1 OR AN ANTI-PD-L1 ANTIBODY FOR THE TREATMENT OF CANCERS
	H01L 35/28 (2006.01) H01L 35/34 (2006.01) H01L 37/02 (2006.01)		3750194	METHODS OF USE FOR TRISUBSTITUTED BENZOTRIAZOLE DERIVATIVES ACTIVE MATERIAL AND ELECTRIC POWER GENERATOR CONTAINING IT
	H01M 10/36 (2010.01)		3750208	A SEMI-SOLID BATTERY WITH RECHARGING CAPABILITY
	C12Q 1/6883 (2018.01)		3728638	DIAGNOSTIC AND THERAPEUTIC METHODS FOR THE TREATMENT OF RHEUMATOID ARTHRITIS (RA)
	A61K 39/00 (2006.01) A61K 39/395 (2006.01) A61P 35/02 (2006.01) C07K 16/28 (2006.01) C07K 16/30 (2006.01)		3746117	COMBINATION THERAPY USING ADOPTIVE CELL THERAPY AND CHECKPOINT INHIBITOR
	A61K 9/00 (2006.01) A61K 39/395 (2006.01) C07K 16/28 (2006.01) C07K 16/40 (2006.01)		3749363	LOW PH PHARMACEUTICAL ANTIBODY FORMULATION
	A61K 9/14 (2006.01) A61K 9/19 (2006.01) A61K 31/195 (2006.01) A61K 31/198 (2006.01) A61K 47/10 (2017.01) A61K 47/12 (2006.01) A61K 47/26 (2006.01) A61K 47/32 (2006.01) A61K 47/38 (2006.01)		3758754	A PHARMACEUTICAL FORMULATION FOR INTRADUODENAL ADMINISTRATION COMPRISING MELEVODOPA AND CARBIDOPA

Podnosilac evropske prijave patenta (71)	MKP (51)	Broj objave evropske prijave patenta (97)	Naziv pronalaska (54)		
Societa' per Azioni Curti - Costruzioni Meccaniche	B01D 29/35 (2006.01)	3752267	DEVICE AND METHOD FOR FILTERING A FLUID CIRCULATING IN A PLUMBING AND HEATING SYSTEM		
	B01D 29/90 (2006.01)				
	B01D 29/92 (2006.01)				
	B01D 35/06 (2006.01)	3749734	GASIFICATION PLANT		
	C10B 3/00 (2006.01)				
	C10B 43/14 (2006.01)				
	C10B 49/00 (2006.01)				
	C10J 3/26 (2006.01)				
	C10J 3/42 (2006.01)				
	C10J 3/72 (2006.01)				
	A61K 8/49 (2006.01)			3752253	COMPOSITION FOR PREVENTION AND TREATMENT OF HAIR GROWTH DISORDERS
	A61K 31/4155 (2006.01)				
	A61P 17/14 (2006.01)				
	A61Q 7/00 (2006.01)				
	C07D 277/54 (2006.01)				
	C07D 417/12 (2006.01)				
	A61L 2/00 (2006.01)	3755455	MODIFIED FILTER MEMBRANE AND METHOD		
	B01D 61/14 (2006.01)				
	B01D 61/16 (2006.01)				
	B01D 67/00 (2006.01)				
	B01D 69/02 (2006.01)				
	B01D 69/08 (2006.01)				
	B01D 71/10 (2006.01)				
	B01D 71/12 (2006.01)				
	B01D 71/16 (2006.01)				
	B01D 71/20 (2006.01)			3755703	N-(PHENYL)-2-(PHENYL)PYRIMIDINE-4-CARBOXAMIDE DERIVATIVES AND RELATED COMPOUNDS AS HPK1 INHIBITORS FOR TREATING CANCER
	C12N 7/02 (2006.01)				
	A61K 31/444 (2006.01)				
	A61K 31/506 (2006.01)				
	A61P 35/00 (2006.01)				
	C07D 239/28 (2006.01)				
	C07D 401/14 (2006.01)				
	C07D 403/12 (2006.01)				
C07D 403/14 (2006.01)					
C07D 487/04 (2006.01)					

Podnosilac evropske prijave patenta (71)	MKP (51)	Broj objave evropske prijave patenta (97)	Naziv pronalaska (54)
Granic, Mateo	C07D 487/08 (2006.01)	3759083	2,4-DIAMINOQUINAZOLINE DERIVATIVES AND MEDICAL USES THEREOF
	A61K 31/517 (2006.01)		
	A61P 1/16 (2006.01)		
	A61P 31/12 (2006.01)		
	A61P 35/00 (2006.01)		
	A61P 37/06 (2006.01)		
	C07D 239/95 (2006.01)		
	G10G 5/00 (2006.01)		
	A61K 31/4375 (2006.01)		
	A61K 31/4427 (2006.01)		
Newave Pharmaceutical Inc.	A61P 35/00 (2006.01)	3755702	INHIBITORS OF BTK AND MUTANTS THEREOF
	C07D 401/12 (2006.01)		
	C07D 401/14 (2006.01)		
	C07D 413/14 (2006.01)		
	C07D 471/04 (2006.01)		
	C07D 491/147 (2006.01)		
	A61K 31/4985 (2006.01)		
	A61P 35/00 (2006.01)		
	A61P 37/00 (2006.01)		
	C07D 487/04 (2006.01)		
Newave Pharmaceutical Inc.	A61M 5/315 (2006.01)	3755403	MEDICATION DELIVERY DEVICE WITH A SENSED ELEMENT
	A61M 5/315 (2006.01)	3755404	DOSE DETECTION SYSTEM MODULE FOR MEDICATION DELIVERY DEVICE
Newave Pharmaceutical Inc.	B23Q 17/20 (2006.01)	3755499	METHOD AND APPARATUS FOR ADDITIVE MANUFACTURING
	B23Q 17/22 (2006.01)		
Newave Pharmaceutical Inc.	B23Q 17/24 (2006.01)	3759096	CD73 INHIBITORS
	B29C 64/188 (2017.01)		
Newave Pharmaceutical Inc.	G06T 7/33 (2017.01)	3759139	PD-1 AGONIST ANTIBODIES AND USES THEREOF
	A61K 31/513 (2006.01)		
Newave Pharmaceutical Inc.	A61P 35/00 (2006.01)	3759098	PYRIDINE-SULFONAMIDE COMPOUNDS AND THEIR USE AGAINST PAIN AND RELATED CONDITIONS
	C07D 403/04 (2006.01)		
Newave Pharmaceutical Inc.	A61K 39/00 (2006.01)	3759139	PD-1 AGONIST ANTIBODIES AND USES THEREOF
	A61P 37/06 (2006.01)		
Newave Pharmaceutical Inc.	C07K 16/28 (2006.01)	3759098	PYRIDINE-SULFONAMIDE COMPOUNDS AND THEIR USE AGAINST PAIN AND RELATED CONDITIONS
	A61K 31/505 (2006.01)		
Newave Pharmaceutical Inc.	A61K 31/506 (2006.01)	3759098	PYRIDINE-SULFONAMIDE COMPOUNDS AND THEIR USE AGAINST PAIN AND RELATED CONDITIONS
	A61K 31/506 (2006.01)		

Podnosilac evropske prijave patenta (71)	MKP (51)	Broj objave evropske prijave patenta (97)	Naziv pronalaska (54)
Alzecure Pharma AB	C07B 59/00 (2006.01)	3759088	TRIAZINE DERIVATIVES FOR TREATING DISEASES RELATING TO NEUROTROPHINS
	C07D 239/69 (2006.01)		
	C07D 401/12 (2006.01)		
	C07D 401/14 (2006.01)		
	C07D 403/12 (2006.01)		
	C07D 413/12 (2006.01)		
	A61K 31/53 (2006.01)		
	A61P 25/00 (2006.01)		
	A61P 25/16 (2006.01)		
	A61P 25/24 (2006.01)		
	A61P 25/28 (2006.01)		
	C07D 251/34 (2006.01)		
	C07D 401/04 (2006.01)		
	C07D 403/04 (2006.01)		
C07D 405/04 (2006.01)			
C07D 409/04 (2006.01)			
C07D 417/04 (2006.01)			
IntraBio Ltd	A61K 31/198 (2006.01)	3752141	THERAPEUTIC AGENTS FOR TREATING RESTLESS LEGS SYNDROME
AstraZeneca AB	A61P 25/00 (2006.01)	3752251	ARGINASE INHIBITORS AND METHODS OF USE THEREOF
	A61K 31/69 (2006.01)		
	A61P 29/00 (2006.01)		
	A61P 35/00 (2006.01)	3752600	EXPANSION OF TUMOR INFILTRATING LYMPHOCYTES (TILS) WITH ADENOSINE A2A RECEPTOR ANTAGONISTS AND THERAPEUTIC COMBINATIONS OF TILS AND ADENOSINE A2A RECEPTOR ANTAGONISTS
	C07F 5/02 (2006.01)		
	A61K 35/17 (2015.01)		
	A61K 39/00 (2006.01)		
	A61P 35/00 (2006.01)	3758722	MACRO-ENCAPSULATED THERAPEUTIC CELLS, DEVICES, AND METHODS OF USING THE SAME
	C12N 5/0783 (2010.01)		
	A61K 9/50 (2006.01)		
	A61K 35/00 (2006.01)		
	A61K 35/39 (2015.01)		
	A61L 27/38 (2006.01)		
	A61L 27/54 (2006.01)		
	A61P 5/48 (2006.01)		
A61P 5/50 (2006.01)			

Podnosilac evropske prijave patenta (71)	MKP (51)	Broj objave evropske prijave patenta (97)	Naziv pronalaska (54)
	A61K 31/416 (2006.01) A61P 17/06 (2006.01) A61P 19/04 (2006.01) A61P 35/00 (2006.01) C07D 401/14 (2006.01) C07D 403/04 (2006.01) C07D 403/14 (2006.01) C07D 405/14 (2006.01) C07D 487/04 (2006.01)	3755696	5-HETEROARYL SUBSTITUTED INDAZOLE-3-CARBOXAMIDES AND PREPARATION AND USE THEREOF
	A61K 48/00 (2006.01) C12N 15/113 (2010.01) C12N 15/90 (2006.01)	3752616	COMPOSITIONS AND METHODS FOR GENE EDITING BY TARGETING FIBRINOGEN-ALPHA
BERIDZE, Enriko IORAMASHVILI, Solomon KOCHLADZE, Shalva	F01K 7/16 (2006.01) F01K 11/02 (2006.01) F01K 19/08 (2006.01) F22B 1/16 (2006.01) F22B 3/04 (2006.01)	3737839	GEOTHERMAL ENERGY DEVICE
	A61K 31/712 (2006.01) A61K 31/7125 (2006.01) A61P 7/06 (2006.01) C12N 15/113 (2010.01)	3749767	MATERIALS AND METHODS FOR TREATMENT OF HEMOGLOBINOPATHIES
Otsuka Pharmaceutical Co., Ltd.	A61K 31/4985 (2006.01) A61P 35/00 (2006.01) C07D 487/04 (2006.01)	3759111	PHARMACEUTICAL COMPOUNDS
	A61K 31/519 (2006.01) A61P 9/00 (2006.01) A61P 25/00 (2006.01) A61P 29/00 (2006.01) A61P 35/00 (2006.01) C07D 487/04 (2006.01) C07D 519/00 (2006.01)	3759112	IMIDAZOPYRIMIDINES AND TRIAZOLOPYRIMIDINES AS A2A / A2B INHIBITORS
	G01N 15/00 (2006.01) G01N 33/543 (2006.01)	3759490	METHODS FOR DETECTING PARTICLES PRESENT IN A CELL COMPOSITION
	E05B 5/00 (2006.01) E05B 5/02 (2006.01)	3728766	DOOR HANDLE ASSEMBLY WITH SAFETY FUNCTION

Podnosilac evropske prijave patenta (71)	MKP (51)	Broj objave evropske prijave patenta (97)	Naziv pronalaska (54)	
Diabetes-Free, Inc.	E05B 47/00 (2006.01)	3752532	IMPROVED ANTAGONISTIC ANTI-HUMAN CD40 MONOCLONAL ANTIBODIES MULTIVARIATE SPECTRAL ANALYSIS AND MONITORING OF BIOMANUFACTURING	
	C07K 16/28 (2006.01)			
	B01D 15/18 (2006.01)	3759467		
	G01N 21/35 (2014.01)			
	G01N 21/3577 (2014.01)			
	G01N 21/552 (2014.01)			
	G01N 21/84 (2006.01)			
	G01N 30/46 (2006.01)			
	G01N 30/78 (2006.01)			
	G01N 30/86 (2006.01)			
AstraZeneca AB	G01N 30/88 (2006.01)	3758708		
	A61K 31/553 (2006.01)			
ABN Pipe Systems, S.L.U.	A61P 11/06 (2006.01)	3736479	PHARMACEUTICAL COMPOSITIONS COMPRISING (2S)-{(1S)-1-CYANO-2-[4-(3-METHYL-2-OXO-2,3-DIHYDRO-1,3-BENZOXAZOL-5-YL)PHENYL]ETHYL}-1,4-OXAZEPANE-2-CARBOXAMIDE EXPANSION-COMPENSATING ELEMENT	
	F16L 27/08 (2006.01)			
	F16L 27/12 (2006.01)			
	F16L 51/00 (2006.01)			
	F16L 51/02 (2006.01)			
	A61K 31/712 (2006.01)			3749768
	A61K 31/7125 (2006.01)			
	A61P 7/06 (2006.01)			
	C12N 15/113 (2010.01)			
	A61P 31/16 (2006.01)			3743442
	C07K 16/10 (2006.01)			
	E03C 1/042 (2006.01)			3735548
	F16L 5/10 (2006.01)			
	A23L 33/135 (2016.01)			3743086
A61K 35/74 (2015.01)				
A61K 39/02 (2006.01)				
A61P 1/00 (2006.01)				
A61P 3/10 (2006.01)				
A61P 11/06 (2006.01)				
A61P 17/06 (2006.01)				
A61P 19/02 (2006.01)				
A61P 35/00 (2006.01)				
A61P 37/00 (2006.01)				

Podnosilac evropske prijave patenta (71)	MKP (51)	Broj objave evropske prijave patenta (97)	Naziv pronalaska (54)
The Regents of the University of California	A61P 43/00 (2006.01)	3720442	INHIBITING MUTANT IDH-1
	A61K 31/4704 (2006.01)		
	A61K 31/4709 (2006.01)		
	A61P 35/00 (2006.01)	3746047	INJECTABLE COMPOSITION
	A61P 35/02 (2006.01)		
	A61K 9/00 (2006.01)		
	A61K 31/4196 (2006.01)	3737367	METHODS OF TREATING SOLID TUMORS WITH CCR2 ANTAGONISTS
	A61K 47/34 (2017.01)		
	A61K 31/351 (2006.01)		
	A61K 31/40 (2006.01)	3735252	HETERODUPLEX NUCLEIC ACID MOLECULES AND USES THEREOF
	A61K 31/4025 (2006.01)		
	C07D 405/00 (2006.01)		
	C07D 405/02 (2006.01)	3737366	METHODS OF TREATING GENERALIZED PUSTULAR PSORIASIS WITH AN ANTAGONIST OF CCR6 OR CXCR2
	C07D 405/04 (2006.01)		
	A61K 31/712 (2006.01)		
	A61K 31/7125 (2006.01)	3737748	BISULFITE-FREE, BASE-RESOLUTION IDENTIFICATION OF CYTOSINE MODIFICATIONS
	A61K 31/713 (2006.01)		
	C07H 21/02 (2006.01)		
	C12N 15/113 (2010.01)	3736568	DETECTION METHOD FOR ANALOG DERIVED FROM TRIFLURIDINE
	A61K 31/341 (2006.01)		
	A61K 31/395 (2006.01)		
	A61K 31/4035 (2006.01)	3736568	DETECTION METHOD FOR ANALOG DERIVED FROM TRIFLURIDINE
	C07D 209/44 (2006.01)		
	C07D 209/46 (2006.01)		
	C07D 307/52 (2006.01)	3736568	DETECTION METHOD FOR ANALOG DERIVED FROM TRIFLURIDINE
	C12N 9/02 (2006.01)		
	C12P 19/18 (2006.01)		
	C12Q 1/26 (2006.01)	3736568	DETECTION METHOD FOR ANALOG DERIVED FROM TRIFLURIDINE
	C12Q 1/6806 (2018.01)		
	C12Q 1/6827 (2018.01)		
	C12Q 1/6869 (2018.01)	3736568	DETECTION METHOD FOR ANALOG DERIVED FROM TRIFLURIDINE
	C07D 239/557 (2006.01)		
	C07H 19/073 (2006.01)		
G01N 30/26 (2006.01)	3736568	DETECTION METHOD FOR ANALOG DERIVED FROM TRIFLURIDINE	
G01N 30/34 (2006.01)			

Podnosilac evropske prijave patenta (71)	MKP (51)	Broj objave evropske prijave patenta (97)	Naziv pronalaska (54)		
Collidion, Inc.	G01N 30/88 (2006.01)	3737421	METHODS FOR ANTIBODY DRUG CONJUGATION, PURIFICATION, AND FORMULATION		
	A61K 47/68 (2017.01)				
	C07K 16/28 (2006.01)				
	A61L 2/18 (2006.01)	3737425	COMPOSITIONS, KITS, METHODS AND USES FOR CLEANING, DISINFECTING, STERILIZING AND/OR TREATING		
	A61L 2/238 (2006.01)	3740475	PROCESS OF MAKING SOMATOSTATIN MODULATORS		
	C01B 11/04 (2006.01)				
	C07D 401/04 (2006.01)				
	C07D 498/04 (2006.01)				
	C07F 5/02 (2006.01)	3740571	CLOSED-ENDED DNA VECTORS OBTAINABLE FROM CELL-FREE SYNTHESIS AND PROCESS FOR OBTAINING CEDNA VECTORS		
	C12N 15/09 (2006.01)				
C12N 15/63 (2006.01)					
C12N 15/64 (2006.01)					
C12N 15/66 (2006.01)					
C12N 15/86 (2006.01)					
C12N 15/86 (2006.01)					
CTC Global Corporation	B32B 15/04 (2006.01)	3743273	TERMINATION ARRANGEMENT FOR AN OVERHEAD ELECTRICAL CABLE		
	B32B 27/04 (2006.01)				
	H01B 5/10 (2006.01)				
	H01B 7/17 (2006.01)				
	H02G 1/02 (2006.01)				
	H02G 1/04 (2006.01)				
	H02G 7/02 (2006.01)				
	H02G 7/04 (2006.01)				
	H02G 7/05 (2006.01)				
	H02G 15/18 (2006.01)				
	A61K 39/12 (2006.01)			3746462	STABILIZED RSV F PROTEINS AND USES THEREOF
	A61K 39/155 (2006.01)				
	C07K 14/005 (2006.01)				
	C07K 14/135 (2006.01)				
	C12N 15/45 (2006.01)	3746090	RSV RNA VACCINES		
	A61K 31/7105 (2006.01)				
	A61K 31/7115 (2006.01)				
	A61K 39/155 (2006.01)				
	A61P 31/14 (2006.01)				
	A61K 31/403 (2006.01)	3743065	SULFONAMIDE DERIVATIVES FOR PROTEIN DEGRADATION		
A61K 31/404 (2006.01)					

Podnosilac evropske prijave patenta (71)	MKP (51)	Broj objave evropske prijave patenta (97)	Naziv pronalaska (54)
	A61K 31/4439 (2006.01)	3743916	BACKWARD-COMPATIBLE INTEGRATION OF HIGH FREQUENCY RECONSTRUCTION TECHNIQUES FOR AUDIO SIGNALS
	C07D 209/42 (2006.01)		
	C07D 403/12 (2006.01)		
	G10L 19/00 (2013.01)		
	G10L 19/02 (2013.01)		
	G10L 19/16 (2013.01)		
Pharmascience Inc.	H04N 19/00 (2014.01)	3746091	CHOLESTYRAMINE FORMULATIONS AND METHODS OF USE
	A61K 9/52 (2006.01)		
	A61K 31/785 (2006.01)		
	A61P 1/12 (2006.01)		
	C08F 212/14 (2006.01)		
MyoKardia, Inc.	C08F 212/36 (2006.01)	3746434	PYRAZOLE COMPOUNDS AND PREPARATION THEREOF
	A61K 31/435 (2006.01)		
	A61P 9/04 (2006.01)		
	C07D 403/04 (2006.01)		
Kyoto University Astellas Pharma Inc.	A61K 35/76 (2015.01)	3746100	GENE THERAPY FOR LIMB-GIRDLE MUSCULAR DYSTROPHY TYPE 2C
	A61K 38/17 (2006.01)		
	A61K 48/00 (2006.01)		
	A61M 1/36 (2006.01)	3747471	MEDICINE FOR PREVENTING OR TREATING OPHTHALMIC DISEASE ASSOCIATED WITH ENHANCED INTRAOCULAR NEOVASCULARIZATION AND/OR INTRAOCULAR VASCULAR PERMEABILITY
	A61M 5/14 (2006.01)		
	A61K 31/135 (2006.01)		
	A61K 31/397 (2006.01)		
	A61K 31/403 (2006.01)		
	A61K 31/4245 (2006.01)		
	A61K 31/426 (2006.01)		
	A61K 31/496 (2006.01)		
	A61K 45/00 (2006.01)		
	A61P 9/10 (2006.01)		
A61P 27/02 (2006.01)			
Japan Tobacco Inc.	A61K 31/437 (2006.01)	3747888	NITROGENATED HETEROCYCLIC AMIDE COMPOUND, AND USE THEREOF FOR MEDICAL PURPOSES
	A61K 31/4985 (2006.01)		
	A61K 31/506 (2006.01)		
	A61P 3/10 (2006.01)		
	A61P 9/04 (2006.01)		
	A61P 9/12 (2006.01)		

Podnosilac evropske prijave patenta (71)	MKP (51)	Broj objave evropske prijave patenta (97)	Naziv pronalaska (54)
IONOGEN INC.	A61P 43/00 (2006.01)	3745935	WIPE DISPENSING
	C07D 487/04 (2006.01)		
	C07D 498/04 (2006.01)		
	C07D 519/00 (2006.01)		
	A47K 10/32 (2006.01)		
Audentes Therapeutics, Inc.	A47K 10/34 (2006.01)	3749756	TRANSCRIPTION REGULATORY ELEMENTS AND USES THEREOF
	A47K 10/38 (2006.01)		
	C12N 7/00 (2006.01)		
President and Fellows of Harvard College	C12N 15/86 (2006.01)	3749745	TISSUE ENGINEERED SCAFFOLDS, INSTRUMENTED BIOREACTORS AND METHODS OF USE THEREOF
	C12Q 1/70 (2006.01)		
	C12M 1/00 (2006.01)		
	C12M 3/00 (2006.01)		
	C12N 5/071 (2010.01)		
Vital Tech LLC	C07D 401/14 (2006.01)	3752498	SOMATOSTATIN MODULATORS AND USES THEREOF
	C07D 471/04 (2006.01)	3750196	ELECTRICAL AMPLIFICATION SYSTEMS THROUGH RESONANCE
	H01L 41/02 (2006.01)		
	H01L 41/04 (2006.01)		
	H01L 41/08 (2006.01)		
H02K 7/14 (2006.01)			
Nippon Shinyaku Co., Ltd.	H02N 2/10 (2006.01)	3723777	COMPOSITIONS COMPRISING BACTERIAL STRAINS
	H02N 2/14 (2006.01)		
	A61K 9/19 (2006.01)		
	A61K 35/74 (2015.01)		
	A61K 35/741 (2015.01)		
	A61P 1/00 (2006.01)		
	A61P 43/00 (2006.01)		
	A61K 9/14 (2006.01)		
	A61K 9/16 (2006.01)		
	A61K 9/20 (2006.01)		
A61K 9/48 (2006.01)	3756670	GRANULAR COMPOSITION, METHOD FOR PRODUCING GRANULAR COMPOSITION, AND METHOD FOR IMPROVING ELUTION PROPERTY OF GRANULAR COMPOSITION	
A61K 31/4965 (2006.01)			
A61K 47/26 (2006.01)			
A61K 47/36 (2006.01)			
A61P 7/00 (2006.01)			
A61P 7/02 (2006.01)			

Podnosilac evropske prijave patenta (71)	MKP (51)	Broj objave evropske prijave patenta (97)	Naziv pronalaska (54)
Axsome Therapeutics, Inc.	A61P 9/08 (2006.01)	3758710	STABLE LYOPHILIZED COMPOSITION OF CYCLOPHOSPHAMIDE
	A61P 11/08 (2006.01)		
	A61P 43/00 (2006.01)		
	A61K 9/14 (2006.01)		
	A61K 9/19 (2006.01)		
	A61K 31/675 (2006.01)		
	A61K 31/137 (2006.01)		
	A61K 31/485 (2006.01)		
	A61P 25/00 (2006.01)		
	A61P 25/18 (2006.01)		
	A61P 25/24 (2006.01)		
	A61P 25/28 (2006.01)		
	A61P 25/30 (2006.01)		
	C07K 16/28 (2006.01)		
C07K 16/32 (2006.01)	3755311	INDANE-AMINES AS PD-L1 ANTAGONISTS	
A61K 31/015 (2006.01)			
A61K 31/03 (2006.01)	3755803	CONTROLLED EXPRESSION OF TRANSGENES USING CLOSE-ENDED DNA (CEDNA) VECTORS	
C07C 211/38 (2006.01)			
C12N 15/86 (2006.01)			
C12N 15/864 (2006.01)			
C12N 15/87 (2006.01)	3755348	ANTIBODY VARIABLE DOMAINS TARGETING CD33, AND USE THEREOF	
A61K 35/17 (2015.01)			
A61K 39/395 (2006.01)			
A61K 48/00 (2006.01)	3755148	NANOSUSPENSIONS OF SALSALATE AND METHODS OF USING THE SAME	
A01N 37/10 (2006.01)			
A61K 31/235 (2006.01)	3755805	COMPOSITIONS AND METHODS FOR TREATING NON-AGE-ASSOCIATED HEARING IMPAIRMENT IN A HUMAN SUBJECT	
A61K 9/00 (2006.01)			
A61K 38/17 (2006.01)			
A61K 48/00 (2006.01)			
A61P 25/00 (2006.01)			
A61P 27/16 (2006.01)			
C07K 14/435 (2006.01)			
C12N 15/65 (2006.01)			
C12N 15/86 (2006.01)			
A61K 38/00 (2006.01)			3758729

Podnosilac evropske prijave patenta (71)	MKP (51)	Broj objave evropske prijave patenta (97)	Naziv pronalaska (54)
	A61K 38/20 (2006.01)		
	C07K 14/54 (2006.01)		
	C12N 15/24 (2006.01)		
	A61K 31/513 (2006.01)	3760616	4-METHYLDIHYDROPYRIMIDINONE COMPOUND AND MEDICINAL USE THEREOF
	A61P 3/00 (2006.01)		
	A61P 27/04 (2006.01)		
	A61P 35/00 (2006.01)		
	A61P 37/02 (2006.01)		
	A61P 37/08 (2006.01)		
	C07D 239/22 (2006.01)		
	A61K 31/4155 (2006.01)	3760624	METHYLLACTAM RING COMPOUND AND MEDICINAL USE THEREOF
	A61P 3/10 (2006.01)		
	A61P 43/00 (2006.01)		
	C07D 403/12 (2006.01)		
	A61K 38/17 (2006.01)	3759125	METHODS FOR TREATING CANCER USING COMBINATIONS OF ANTI-BTNL2 AND IMMUNE CHECKPOINT BLOCKADE AGENTS
	A61K 39/395 (2006.01)		
	C07K 14/43 (2006.01)		
	C07K 14/435 (2006.01)		
	C07K 14/705 (2006.01)		
	G01M 11/00 (2006.01)	3759454	SYSTEMS, METHODS AND TOOLS FOR THE INTERROGATION OF COMPOSITE STRENGTH MEMBERS
January Therapeutics, Inc.	A01N 57/12 (2006.01)	3758495	NANOPARTICLE COMPOSITIONS
	A01N 57/20 (2006.01)		
	A61K 31/661 (2006.01)		
CYBER DEFENCE QCD CORPORATION	G06F 3/0481 (2013.01)	3759633	METHODS AND SYSTEMS FOR CYBER-MONITORING AND VISUALLY DEPICTING CYBER-ACTIVITIES
	G06F 21/50 (2013.01)		
	H04L 12/22 (2006.01)		
	H04L 12/24 (2006.01)		
	H04L 29/06 (2006.01)		
	H04L 29/08 (2006.01)		
	C12N 9/14 (2006.01)	3759217	CLOSED-ENDED DNA (CEDNA) VECTORS FOR INSERTION OF TRANSGENES AT GENOMIC SAFE HARBORS (GSH) IN HUMANS AND MURINE GENOMES
	C12N 9/22 (2006.01)		
	C12N 15/00 (2006.01)		
	C12N 15/62 (2006.01)		
	C12N 15/63 (2006.01)		

Podnosilac evropske prijave patenta (71)	MKP (51)	Broj objave evropske prijave patenta (97)	Naziv pronalaska (54)
University of Massachusetts	C07C 253/34 (2006.01)	3760612	METHOD FOR PURIFYING NITRILE SOLVENT
	C07C 255/03 (2006.01)		
University of Massachusetts	C12N 15/90 (2006.01)	3759226	IDENTIFYING AND CHARACTERIZING GENOMIC SAFE HARBORS (GSH) IN HUMANS AND MURINE GENOMES, AND VIRAL AND NON-VIRAL VECTOR COMPOSITIONS FOR TARGETED INTEGRATION AT AN IDENTIFIED GSH LOCI
	B01D 1/22 (2006.01)		
University of Massachusetts	B01D 9/02 (2006.01)	3760582	METHOD FOR PRODUCING BIS(FUOROSULFONYL)AMIDE ALKALI METAL SALT POWDER
	C01B 21/086 (2006.01)		
University of Massachusetts	C01B 21/096 (2006.01)	3760615	HETEROARYL SULFONAMIDE COMPOUND AND PEST CONTROL AGENT
	C07C 311/48 (2006.01)		
University of Massachusetts	A01N 47/02 (2006.01)	3760615	HETEROARYL SULFONAMIDE COMPOUND AND PEST CONTROL AGENT
	A01P 5/00 (2006.01)		
University of Massachusetts	A01P 7/04 (2006.01)	3760615	HETEROARYL SULFONAMIDE COMPOUND AND PEST CONTROL AGENT
	A61K 31/4155 (2006.01)		
University of Massachusetts	A61K 31/455 (2006.01)	3760615	HETEROARYL SULFONAMIDE COMPOUND AND PEST CONTROL AGENT
	A61P 33/10 (2006.01)		
University of Massachusetts	A61P 33/14 (2006.01)	3760619	SATURATED RING-CONDENSED DIHYDROPYRIMIDINONE OR DIHYDROTRIAZINONE COMPOUND, AND PHARMACEUTICAL USE THEREOF
	C07D 213/81 (2006.01)		
University of Massachusetts	C07D 213/82 (2006.01)	3760619	SATURATED RING-CONDENSED DIHYDROPYRIMIDINONE OR DIHYDROTRIAZINONE COMPOUND, AND PHARMACEUTICAL USE THEREOF
	C07D 409/12 (2006.01)		
University of Massachusetts	A61K 31/517 (2006.01)	3760619	SATURATED RING-CONDENSED DIHYDROPYRIMIDINONE OR DIHYDROTRIAZINONE COMPOUND, AND PHARMACEUTICAL USE THEREOF
	A61K 31/519 (2006.01)		
University of Massachusetts	A61K 31/53 (2006.01)	3760619	SATURATED RING-CONDENSED DIHYDROPYRIMIDINONE OR DIHYDROTRIAZINONE COMPOUND, AND PHARMACEUTICAL USE THEREOF
	A61P 3/00 (2006.01)		
University of Massachusetts	A61P 27/02 (2006.01)	3760619	SATURATED RING-CONDENSED DIHYDROPYRIMIDINONE OR DIHYDROTRIAZINONE COMPOUND, AND PHARMACEUTICAL USE THEREOF
	A61P 35/00 (2006.01)		
University of Massachusetts	A61P 37/06 (2006.01)	3760619	SATURATED RING-CONDENSED DIHYDROPYRIMIDINONE OR DIHYDROTRIAZINONE COMPOUND, AND PHARMACEUTICAL USE THEREOF
	A61P 37/08 (2006.01)		
University of Massachusetts	C07D 239/70 (2006.01)	3760619	SATURATED RING-CONDENSED DIHYDROPYRIMIDINONE OR DIHYDROTRIAZINONE COMPOUND, AND PHARMACEUTICAL USE THEREOF
	C07D 239/80 (2006.01)		
University of Massachusetts	C07D 253/10 (2006.01)	3760619	SATURATED RING-CONDENSED DIHYDROPYRIMIDINONE OR DIHYDROTRIAZINONE COMPOUND, AND PHARMACEUTICAL USE THEREOF
	C07D 487/04 (2006.01)		
University of Massachusetts	C07D 491/048 (2006.01)	3760619	SATURATED RING-CONDENSED DIHYDROPYRIMIDINONE OR DIHYDROTRIAZINONE COMPOUND, AND PHARMACEUTICAL USE THEREOF
	C07D 491/052 (2006.01)		
Elicio Therapeutics, Inc.	A61K 31/70 (2006.01)	3758712	CPG AMPHIPHILES AND USES THEREOF
Elicio Therapeutics, Inc.	A61K 31/7088		

Podnosilac evropske prijave patenta (71)	MKP (51)	Broj objave evropske prijave patenta (97)	Naziv pronalaska (54)
	(2018.01) H04L 29/08 (2006.01) H04N 7/15 (2006.01) A61K 31/00 (2006.01) A61K 39/395 (2006.01) A61K 45/06 (2006.01) A61K 47/68 (2017.01) A61P 35/00 (2006.01) C07K 16/28 (2006.01) C07K 16/30 (2006.01) A61K 47/68 (2017.01) A61P 35/00 (2006.01) C07K 16/28 (2006.01)	3689910	METHOD OF USING ANTI-CD79B IMMUNOCONJUGATES
	A61K 47/68 (2017.01) A61P 35/00 (2006.01) C07K 16/28 (2006.01)	3730520	AXL-SPECIFIC ANTIBODY-DRUG CONJUGATES FOR CANCER TREATMENT
KU Europe GmbH	A45D 1/00 (2006.01) A45D 1/04 (2006.01) A45D 1/10 (2006.01) A45D 1/18 (2006.01) A45D 1/28 (2006.01) A45D 2/00 (2006.01) A45D 6/04 (2006.01) C07D 249/08 (2006.01) C07D 403/12 (2006.01) C07D 413/12 (2006.01)	3695743	HAIR STYLING DEVICE
	A61K 9/00 (2006.01) A61M 5/28 (2006.01) A61M 5/31 (2006.01) A61M 5/315 (2006.01) A61P 27/02 (2006.01) A61P 43/00 (2006.01)	3679922	SYRINGE
LOVEJOY CONTROLS CORPORATION	G01H 1/00 (2006.01) G01H 9/00 (2006.01) A61K 35/76 (2015.01) C12N 5/10 (2006.01) C12N 15/85 (2006.01) C12N 15/86 (2006.01)	3696520	ULTRASONIC ROTOR DEFLECTION MONITORING SYSTEM
		3701959	RNA REPLICON FOR VERSATILE AND EFFICIENT GENE EXPRESSION

Podnosilac evropske prijave patenta (71)	MKP (51)	Broj objave evropske prijave patenta (97)	Naziv pronalaska (54)
	A61K 9/00 (2006.01) A61K 9/14 (2006.01) A61K 9/16 (2006.01) A61K 31/00 (2006.01) A61K 31/167 (2006.01) A61K 31/194 (2006.01) A61K 31/40 (2006.01) A61K 31/573 (2006.01) A61K 45/06 (2006.01) A61K 47/12 (2006.01) A61K 47/26 (2006.01) A61P 11/00 (2006.01) A61P 11/06 (2006.01) A61P 11/08 (2006.01) A61P 29/00 (2006.01) A61P 43/00 (2006.01) A61J 1/10 (2006.01) A61J 1/14 (2006.01) A61J 1/20 (2006.01) F28D 1/053 (2006.01) F28F 9/26 (2006.01) F28F 21/08 (2006.01) B01D 3/10 (2006.01) B01D 3/14 (2006.01) B01D 3/34 (2006.01) B01D 11/04 (2006.01) C07D 311/82 (2006.01) A61K 45/06 (2006.01) A61K 47/54 (2017.01) A61P 9/00 (2006.01) C12N 15/113 (2010.01) C07K 16/00 (2006.01) C07K 16/10 (2006.01) C07K 16/28 (2006.01) C07K 16/32 (2006.01)	3689379	A PROCESS FOR PREPARING A DRY POWDER FORMULATION COMPRISING AN ANTICHOLINERGIC, A CORTICOSTEROID AND A BETA-ADRENERGIC
	A61J 1/10 (2006.01) A61J 1/14 (2006.01) A61J 1/20 (2006.01) F28D 1/053 (2006.01) F28F 9/26 (2006.01) F28F 21/08 (2006.01) B01D 3/10 (2006.01) B01D 3/14 (2006.01) B01D 3/34 (2006.01) B01D 11/04 (2006.01) C07D 311/82 (2006.01) A61K 45/06 (2006.01) A61K 47/54 (2017.01) A61P 9/00 (2006.01) C12N 15/113 (2010.01) C07K 16/00 (2006.01) C07K 16/10 (2006.01) C07K 16/28 (2006.01) C07K 16/32 (2006.01)	3701928	STERILE OR STERILIZED PACKAGE FOR ADMINISTRATION OF MEDICINAL OR NUTRITIONAL SUBSTANCES
	F28D 1/053 (2006.01) F28F 9/26 (2006.01) F28F 21/08 (2006.01) B01D 3/10 (2006.01) B01D 3/14 (2006.01) B01D 3/34 (2006.01) B01D 11/04 (2006.01) C07D 311/82 (2006.01) A61K 45/06 (2006.01) A61K 47/54 (2017.01) A61P 9/00 (2006.01) C12N 15/113 (2010.01) C07K 16/00 (2006.01) C07K 16/10 (2006.01) C07K 16/28 (2006.01) C07K 16/32 (2006.01)	3702717	HEAD FOR THERMAL RADIATORS AND METHOD FOR MAKING THE HEAD
	B01D 3/10 (2006.01) B01D 3/14 (2006.01) B01D 3/34 (2006.01) B01D 11/04 (2006.01) C07D 311/82 (2006.01) A61K 45/06 (2006.01) A61K 47/54 (2017.01) A61P 9/00 (2006.01) C12N 15/113 (2010.01) C07K 16/00 (2006.01) C07K 16/10 (2006.01) C07K 16/28 (2006.01) C07K 16/32 (2006.01)	3738957	METHOD FOR ACETYLATION OF CANNABINOIDS
	A61K 45/06 (2006.01) A61K 47/54 (2017.01) A61P 9/00 (2006.01) C12N 15/113 (2010.01) C07K 16/00 (2006.01) C07K 16/10 (2006.01) C07K 16/28 (2006.01) C07K 16/32 (2006.01)	3739048	ANGIOTENSINOGEN (AGT) IRNA COMPOSITIONS AND METHODS OF USE THEREOF
	C07K 16/00 (2006.01) C07K 16/10 (2006.01) C07K 16/28 (2006.01) C07K 16/32 (2006.01)	3738979	INERT FORMAT

Podnosilac evropske prijave patenta (71)	MKP (51)	Broj objave evropske prijave patenta (97)	Naziv pronalaska (54)
Acceleron Pharma Inc.	A61K 31/7068 (2006.01)	3738595	COMBINATION THERAPY
	A61P 35/00 (2006.01)		
	A61P 25/28 (2006.01)	3721942	ANTIBODIES TO AMYLOID BETA
	C07K 16/18 (2006.01)		
	A61K 38/00 (2006.01)	3721892	METHODS AND COMPOSITIONS FOR TREATMENT OF DISORDERS WITH FOLLISTATIN POLYPEPTIDES
	A61K 38/16 (2006.01)		
	A61K 38/17 (2006.01)		
	A61P 21/00 (2006.01)		
	A61P 21/04 (2006.01)		
	A61P 21/06 (2006.01)		
	C07K 14/47 (2006.01)		
	C07K 19/00 (2006.01)		
	C12N 15/62 (2006.01)		
	C12M 1/04 (2006.01)	3730608	PROCESSES FOR PRODUCTION OF TUMOR INFILTRATING LYMPHOCYTES AND USES OF SAME IN IMMUNOTHERAPY
	C12N 5/0783 (2010.01)		
C12M 1/04 (2006.01)	3722415	PROCESSES FOR PRODUCTION OF TUMOR INFILTRATING LYMPHOCYTES AND USES OF SAME IN IMMUNOTHERAPY	
C12N 5/0783 (2010.01)			
F41A 3/44 (2006.01)	3686541	HANDGUN WITH A LOCKING DEVICE	
F41A 5/02 (2006.01)			
A61K 31/517 (2006.01)	3719014	SOLID FORMS OF AN AKT INHIBITING PYRIMIDINYL-CYCLOPENTANE COMPOUND, COMPOSITIONS AND METHODS THEREOF	
C07D 403/04 (2006.01)			
InoVA Solutions GmbH	B66B 5/00 (2006.01)	3733582	SHAFT SEPARATION ELEMENT
	A61K 31/7125 (2006.01)	3730618	RNAI AGENTS, COMPOSITIONS AND METHODS OF USE THEREOF FOR TREATING TRANSTHYRETIN (TTR) ASSOCIATED DISEASES
	C12N 15/113 (2010.01)		
	A61K 31/519 (2006.01)	3722297	TOLL-LIKE RECEPTOR MODULATING 4,6-DIAMINO-PYRIDO[3,2-D]PYRIMIDINE COMPOUNDS
	A61P 31/18 (2006.01)		
	A61P 31/20 (2006.01)		
	A61P 35/00 (2006.01)		
	C07D 471/04 (2006.01)		
	A01K 67/027 (2006.01)	3733701	A NOVEL IL33 FORM, MUTATED FORMS OF IL33, ANTIBODIES, ASSAYS AND METHODS OF USING THE SAME
	A61K 39/00 (2006.01)		
	A61K 39/395 (2006.01)		
	A61P 11/06 (2006.01)		
C07K 14/54 (2006.01)			
C07K 14/715 (2006.01)			

Podnosilac evropske prijave patenta (71)	MKP (51)	Broj objave evropske prijave patenta (97)	Naziv pronalaska (54)
	C07K 16/24 (2006.01)	3733664	ANTIPARISITIC AND PESTICIDAL ISOXAZOLINE COMPOUNDS
	A01N 43/50 (2006.01)		
	A01N 43/54 (2006.01)		
	A01N 43/60 (2006.01)		
	A61P 33/00 (2006.01)		
	C07D 413/10 (2006.01)	3712165	NOVEL PEPTIDES AND COMBINATION OF PEPTIDES FOR USE IN IMMUNOTHERAPY AGAINST OVARIAN CANCER AND OTHER CANCERS
	C07D 413/12 (2006.01)		
	A61K 38/00 (2006.01)		
	C07K 14/47 (2006.01)		
	A61K 39/00 (2006.01)		
	A61P 35/02 (2006.01)	3708185	NOVEL IMMUNOTHERAPY AGAINST SEVERAL TUMORS OF THE BLOOD, IN PARTICULAR CHRONIC LYMPHOID LEUKEMIA (CLL)
	A61K 35/39 (2015.01)		
	A61K 35/74 (2015.01)	3747450	PHARMACEUTICAL COMPOSITION CONSISTING OF BLAUTIA, FOR ORAL ADMINISTRATION
	A61K 38/46 (2006.01)		
	A61K 38/04 (2006.01)	3715357	NOVEL PEPTIDES AND COMBINATION OF PEPTIDES FOR USE IN IMMUNOTHERAPY AGAINST HEPATOCELLULAR CARCINOMA (HCC) AND OTHER CANCERS
	A61K 39/00 (2006.01)		
	A61P 35/00 (2006.01)		
	C07K 7/08 (2006.01)		
	C12Q 1/6886 (2018.01)		
	A01N 51/00 (2006.01)	3744861	A METHYLATION CLASSIFIER FOR DETECTION OF HPV-INDUCED INVASIVE CANCERS, NONHPV-INDUCED GYNAECOLOGICAL AND ANOGENITAL CANCERS AND THEIR HIGH-GRADE PRECURSOR LESIONS
	A61P 25/00 (2006.01)		
	C07D 231/14 (2006.01)	3753927	COMPOSITIONS AND METHODS FOR TREATING CNS DISORDERS
	C07D 295/033 (2006.01)		
	C12N 15/85 (2006.01)	3722433	PROMOTER AND REGULATORY ELEMENTS FOR IMPROVED EXPRESSION OF HETEROLOGOUS GENES IN HOST CELLS
	A61K 39/00 (2006.01)		
	A61P 35/00 (2006.01)	3725327	PEPTIDES AND COMBINATION THEREOF FOR USE IN THE IMMUNOTHERAPY AGAINST CANCERS
	C07K 14/47 (2006.01)		
	G01N 33/50 (2006.01)	3736283	NOVEL PEPTIDES AND COMBINATION OF PEPTIDES FOR USE IN IMMUNOTHERAPY AGAINST ESOPHAGEAL CANCER AND OTHER CANCERS
	A61K 39/00 (2006.01)		
	C07K 14/47 (2006.01)		
	C07K 14/635 (2006.01)		
	A61K 31/415 (2006.01)		
	A61P 29/00 (2006.01)	3722281	A SODIUM SALT OF N-((1,2,3,5,6,7-HEXAHYDRO-S-INDACEN-4-YL)CARBAMOYL)-1-ISOPROPYL-1H-PYRAZOLE-3-SULFONAMIDE

Podnosilac evropske prijave patenta (71)	MKP (51)	Broj objave evropske prijave patenta (97)	Naziv pronalaska (54)
Viela Bio, Inc.	C07D 231/18 (2006.01)	3744840	PROHEMOSTATIC PROTEINS FOR THE TREATMENT OF BLEEDING
	A61K 38/48 (2006.01)		
	A61P 7/02 (2006.01)		
	A61P 7/04 (2006.01)		
	A61P 43/00 (2006.01)		
	C07K 14/46 (2006.01)		
	C12N 9/64 (2006.01)		
	A61K 38/05 (2006.01)		
	A61P 1/04 (2006.01)		
	A61P 3/10 (2006.01)		
	A61P 5/14 (2006.01)		
	A61P 5/38 (2006.01)		
	A61P 7/00 (2006.01)		
	A61P 7/06 (2006.01)		
	A61P 9/00 (2006.01)		
	A61P 9/10 (2006.01)		
	A61P 11/00 (2006.01)		
	A61P 13/12 (2006.01)		
	A61P 15/00 (2006.01)		
	A61P 17/00 (2006.01)		
A61P 17/06 (2006.01)			
A61P 17/14 (2006.01)			
A61P 19/00 (2006.01)			
A61P 19/02 (2006.01)			
A61P 21/02 (2006.01)			
A61P 21/04 (2006.01)			
C07K 14/78 (2006.01)			
C07K 16/28 (2006.01)			
Medivation Prostate Therapeutics LLC	A61K 9/16 (2006.01)	3725778	FORMULATIONS OF ENZALUTAMIDE
	A61K 31/4164 (2006.01)		
	A61K 31/4166 (2006.01)		
	A61P 13/08 (2006.01)		
	A61P 15/00 (2006.01)		
	A61P 15/08 (2006.01)		
	A61P 15/14 (2006.01)		

Podnosilac evropske prijave patenta (71)	MKP (51)	Broj objave evropske prijave patenta (97)	Naziv pronalaska (54)
Carlsberg Breweries A/S	A61P 35/00 (2006.01)	3736321	REFINED CEREAL-BASED BEVERAGES
	A61P 43/00 (2006.01)		
	C07D 233/86 (2006.01)		
	C12C 1/02 (2006.01)		
	C12C 1/027 (2006.01)		
	C12C 1/047 (2006.01)		
	C12C 7/047 (2006.01)		
Laboratorios Agrochem, S.L.	A01K 7/06 (2006.01)	3747265	LIQUID SELF-DISPENSING DEVICE FOR SMALL ANIMALS
	A01M 25/00 (2006.01)	3725785	GLUTARIMIDE DERIVATIVES, USE THEREOF, PHARMACEUTICAL COMPOSITION BASED THEREON AND METHODS FOR PRODUCING GLUTARIMIDE DERIVATIVES
	A61K 31/45 (2006.01)		
	A61P 11/02 (2006.01)		
	A61P 31/16 (2006.01)	3722290	GLUTARIMIDE DERIVATIVES, USE THEREOF, PHARMACEUTICAL COMPOSITION BASED THEREON AND METHODS FOR PRODUCING GLUTARIMIDE DERIVATIVES
	C07D 401/06 (2006.01)		
	A61K 31/45 (2006.01)		
	A61P 11/02 (2006.01)	3753570	NOVEL IMMUNOTHERAPY AGAINST SEVERAL TUMORS INCLUDING GASTROINTESTINAL AND GASTRIC CANCER
	A61P 31/16 (2006.01)		
	C07D 401/06 (2006.01)		
	A61K 38/48 (2006.01)	3760225	NOVEL PEPTIDES AND COMBINATION OF PEPTIDES FOR USE IN IMMUNOTHERAPY AGAINST LUNG CANCER, INCLUDING NSCLC AND OTHER CANCERS
	A61K 39/00 (2006.01)		
	A61P 35/00 (2006.01)		
	C07K 7/06 (2006.01)	3750557	NOVEL PEPTIDES AND COMBINATION OF PEPTIDES FOR USE IN IMMUNOTHERAPY AGAINST LUNG CANCER, INCLUDING NSCLC AND OTHER CANCERS
	C07K 7/08 (2006.01)		
G01N 33/50 (2006.01)			
A61K 39/00 (2006.01)	3750558	NOVEL PEPTIDES AND COMBINATION OF PEPTIDES FOR USE IN IMMUNOTHERAPY AGAINST LUNG CANCER, INCLUDING NSCLC AND OTHER CANCERS	
A61P 35/00 (2006.01)			
C07K 14/47 (2006.01)			
C07K 16/00 (2006.01)	3750559	NOVEL PEPTIDES AND COMBINATION OF PEPTIDES FOR USE IN IMMUNOTHERAPY AGAINST LUNG CANCER, INCLUDING NSCLC AND OTHER CANCERS	
A61K 39/00 (2006.01)			
A61P 35/00 (2006.01)			

Podnosilac evropske prijave patenta (71)	MKP (51)	Broj objave evropske prijave patenta (97)	Naziv pronalaska (54)		
Ethicon LLC	C07K 14/47 (2006.01)	3738606	NOVEL IMMUNOTHERAPY AGAINST SEVERAL TUMORS INCLUDING GASTROINTESTINAL AND GASTRIC CANCER		
	A61K 38/17 (2006.01)				
	A61K 38/39 (2006.01)				
	A61K 39/00 (2006.01)				
	A61P 35/00 (2006.01)				
	C07K 7/06 (2006.01)				
	C07K 7/08 (2006.01)				
	G01N 33/50 (2006.01)				
	A61B 17/00 (2006.01)			3738531	ULTRASONICALLY POWERED SURGICAL INSTRUMENTS WITH ROTATING CUTTING IMPLEMENT
	A61B 17/32 (2006.01)				
	A61B 17/3207 (2006.01)	3736270	MODULATORS OF THE CYSTIC FIBROSIS TRANSMEMBRANE CONDUCTANCE REGULATOR PROTEIN AND METHODS OF USE		
	A61K 31/4709 (2006.01)				
	A61P 11/00 (2006.01)				
	C07C 311/45 (2006.01)				
	C07D 213/64 (2006.01)				
	C07D 213/71 (2006.01)				
	C07D 215/36 (2006.01)				
	C07D 231/56 (2006.01)				
	C07D 235/28 (2006.01)				
	C07D 401/12 (2006.01)				
	C07D 471/04 (2006.01)				
	A61K 31/4709 (2006.01)			3736267	MODULATORS OF THE CYSTIC FIBROSIS TRANSMEMBRANE CONDUCTANCE REGULATOR PROTEIN AND METHODS OF USE
	A61P 11/00 (2006.01)				
	C07C 311/45 (2006.01)				
	C07D 213/64 (2006.01)				
	C07D 213/71 (2006.01)				
	C07D 215/36 (2006.01)				
	C07D 231/56 (2006.01)				
C07D 235/28 (2006.01)					
C07D 401/12 (2006.01)					
C07D 471/04 (2006.01)					
C07K 14/705 (2006.01)	3747898	USE OF ICOS-BASED CARs TO ENHANCE ANTITUMOR ACTIVITY AND CAR PERSISTENCE			
A61K 31/437 (2006.01)	3757104	SOLID FORMS OF A COMPOUND MODULATING KINASES			
A61P 35/00 (2006.01)					
C07D 471/04 (2006.01)					

Podnosilac evropske prijave patenta (71)	MKP (51)	Broj objave evropske prijave patenta (97)	Naziv pronalaska (54)
	A61K 31/519 (2006.01)	3757126	METHODS OF TREATING PSORIATIC ARTHRITIS USING IL-17 ANTAGONISTS
	A61K 39/395 (2006.01)		
	C07K 16/24 (2006.01)		
	A61K 31/223 (2006.01)	3750534	MELFLUFEN DOSAGE REGIMENS FOR CANCER
	A61K 31/573 (2006.01)		
	A61K 31/56 (2006.01)	3750910	TRITERPENOIDS WITH HIV MATURATION INHIBITORY ACTIVITY
	A61K 31/58 (2006.01)		
	A61P 31/18 (2006.01)		
	C07C 309/65 (2006.01)		
	C07F 5/02 (2006.01)		
	C07J 63/00 (2006.01)		
	A61K 9/00 (2006.01)	3757112	GEMCITABINE PRODRUGS
	A61K 9/08 (2006.01)		
	A61K 31/7068 (2006.01)		
	A61K 47/16 (2006.01)		
	A61K 47/20 (2006.01)		
	A61K 47/22 (2006.01)		
	A61P 35/00 (2006.01)		
	C07H 19/10 (2006.01)		
	A61K 31/232 (2006.01)	3750535	METHODS OF REDUCING THE RISK OF CARDIOVASCULAR EVENTS IN A SUBJECT
	A61K 31/366 (2006.01)		
	A61K 31/40 (2006.01)		
	A61K 31/505 (2006.01)		
	A61K 45/06 (2006.01)		
	A61P 9/10 (2006.01)		
	A61K 31/232 (2006.01)	3750536	METHODS OF REDUCING THE RISK OF CARDIOVASCULAR EVENTS IN A SUBJECT
	A61K 31/366 (2006.01)		
	A61K 31/40 (2006.01)		
	A61K 31/505 (2006.01)		
	A61K 45/06 (2006.01)		
	A61P 9/10 (2006.01)		
	A61K 31/4745 (2006.01)	3760202	INHIBITORS OF (ALPHA-V)(BETA-6) INTEGRIN
	A61P 35/00 (2006.01)		
	C07D 401/12 (2006.01)		
	C07D 471/04 (2006.01)		



ŽIGOVI **TRADEMARKS**

MEĐUNARODNI KODOVI ZA IDENTIFIKACIJU BIBLIOGRAFSKIH PODATAKA O ŽIGOVIMA PREMA WIPO ST 60

Reccommendation concerning bibliographic data relating to trademarks- WIPO- ST 60

CRNOGORSKI	MDK	ENGLESKI
REGISTRARSKI BROJ	111	NUMBER OF THE REGISTRATION
DATUM REGISTRACIJE	151	DATE OF THE REGISTRATION
OČEKIVANI DATUM PRESTANKA VAŽENJA ŽIGA	181	EXPECTED EXPIRATION DATE OF THE REGISTRATION
BROJ PRIJAVE	210	NUMBER OF THE APPLICATION
DATUM PODNOŠENJA PRIJAVE	220	DATE OF FILING OF THE APPLICATION
PODACI O IZLOŽBENOM PRAVU PRVENSTVA	230	DATA CONCERNING EXHIBITIONS
PODACI O PRAVU PRVENSTVA NA OSNOVU PARISKE KONVENCIJE	300	DATA RELATING TO PRIORITY UNDER THE PARIS CONVENTION
DATUM OBJAVLJIVANJA PRIJAVE	442	DATA OF PUBLICATION OF APPLICATION
SPISAK ROBA I USLUGA PREMA NIČANSKOJ KLASIFIKACIJI ROBA I USLUGA	511	LIST OF GOODS AND SERVICES ACCORDING THE NICE CLASSIFICATION OF GOODS AND SERVICE
IZJAVA PODNOSIOCA PRIJAVE DA NE TRAŽE EKSKLUZIVNO PRAVO ZA POJEDINE NEDINSTIKTIVNE ELEMENTE ZNAKA	526	DISCLAIMER
IZGLED ZNAKA	540	REPRODUCTION OF THE MARK
NAZNAKA O PRIRODI ILI VRSTI ZNAKA	550	INDICATION RELATING TO THE NATURE OR KIND OF MARK
INFORMACIJA O ZATRAŽENIM BOJAMA NA ZNAKU	591	INFORMATION CONCERNING THE COLORS CLAIMED
PODACI O PODNOSIOCU PRIJAVE	731	NAME AND ADRES OF THE APPLICANT
IME I ADRESA NOSIOCA ŽIGA	732	NAME AND ADDRESS OF THE

		HOLDER OF THE REGISTRATION
INFORMACIJA O ZATRAŽENIM BOJAMA NA ZNAKU	591	INFORMATION CONCERNING THE COLORS CLAIMED
PODACI O PODNOSIOCU PRIJAVE	731	NAME AND ADDRESS OF THE APPLICANT
IME I ADRESA NOSIOCA ŽIGA	732	NAME AND ADDRESS OF THE HOLDER OF THE REGISTRATION
IME I ADRESA PUNOMOĆNIKA	740	NAME AND ADDRESS OF THE REPRESENTATIVE

OBJAVA PRIJAVA ŽIGOVA
Publication of trademark applications

(210) **Ž-2018-245**

(220) 16.07.2018.

(731) DAIMLER AG, Mercedesstrasse 137, 70327, Stuttgart, DE

(540)

ASSYST

(550) I

(511) Klasa 9: Električni i / ili elektronski uređaji za određivanje i označavanje intervala održavanja u motornim i motornim vozilima

(210) **Ž-2019-181**

(220) 08.05.2019.

(731) Hard Rock Limited, 13-14 Esplanade, St.Helier, Jersey JE1 1EE, Channel Islands, GB

(540)

24-KARAT GOLD LEAF STEAK BURGER

(550) I

(740) Jasna Jusić, Dalmatinska 2, 81000, Podgorica

(511) Klasa 30: Kafa, čaj, kakao, vještačka kafa; pirinač; tapioca i sago; brašno i proizvodi od žitarica; hljeb; peciva i poslastice; jestivi led; šećer, med mesala; kvasac, prašak za pecivo, so; senf; sirće, sosevi (kao dodaci jelima); začini; led; hamburger sendviči.

(210) **Ž-2019-182**

(220) 08.05.2019.

(731) Hard Rock Limited, 13-14 Esplanade, St.Helier, Jersey JE1 1EE, Channel Islands, GB

(540)

24-KARAT GOLD LEAF BURGER SLIDERS

(550) I

(740) Jasna Jusić, Dalmatinska 2, 81000, Podgorica

(511) Klasa 30: Kafa, čaj, kakao, vještačka kafa; pirinač; tapioca i sago; brašno i proizvodi od žitarica; hljeb; peciva i poslastice; jestivi led; šećer, med mesala; kvasac, prašak za pecivo, so; senf; sirće, sosevi (kao dodaci jelima); začini; led; hamburger sendviči.

(210) **Ž-2019-184**

(220) 09.05.2019.

(731) DOO "HOUSE ESTATE", SVETI STEFAN, POŠTANSKI FAH BR.7, 85310, Budva, ME

(540)

VILLA GEBÄ

(550) I

(511) Klasa 35: Agencije za komercijalne oglase ; agencije za uvoz-izvoz ; analiza proizvodne cijene ; aukcionarstvo (prodaja na aukciji) ; automati (iznajmljivanje automata) ; cijene (poređenje cijena) ; daktilografske usluge ; ekonomska predviđanja [prognoze] ; fakturisanje ; fotokopiranje (usluge fotokopiranja) ; hoteli (administrativno upravljanje hotelima) ; informacije (kancelarije za komercijalne informacije) ; informacije (poslovne informacije) ; informatičke kartoteke (vođenje informatičkih kartoteka) ; informatički podaci (pretraživanje podataka u informatičkoj kartoteci za treće lice) ; isporuka [distribucija] uzoraka ; isporuka reklamnih materijala [letaka, prospekata, uzoraka] ; isporuka reklamnih oglasa ; isprave (umnožavanje isprava) ; istraživanja za poslove ; istraživanje javnog mišljenja ; istraživanje za poslove ; izlozi (uređivanje izloga) ; izložbe (organizovanje izložbi) u komercijalne ili reklamne svrhe ; iznajmljivanje automata za prodaju sitne robe ; iznajmljivanje fotokopirnih uređaja ; iznajmljivanje kancelarijskih mašina i aparata ; iznajmljivanje reklamnih prostora ; iznajmljivanje reklamnog materijala ; iznajmljivanje vremena za reklamiranje na svim komunikacionim sredstvima ; izvodi iz računa (davanje izvoda sa računa) ; izvoz-uvoz (agencije za izvoz-uvoz) ; javno mnijenje (istraživanje javnog mnjenja) [anketiranje] ; javnost (odnosi s javnošću) [propaganda] ; kancelarije za reklamiranje ; kancelarije za zapošljavanje ; kancelarijski mašine i aparati (iznajmljivanje kancelarijskih mašina i aparata) ; kartoteka (prikupljanje podataka u središnju kartoteku) ; kartoteka (sistemizovanje podataka za središnju kartoteku) ; knjige (vođenje knjiga) ; komercijalna administracija u vezi licenci proizvoda i usluga trećih lica ; komercijalna ili industrijska preduzeća (pomoć u vođenju komercijalnih ili industrijskih preduzeća) ; konsultacije u vezi vođenje poslova ; lociranje teretnih vagona pomoću kompjutera ; manekeni (usluge manekena) za reklamiranje ili podsticaj prodaje ; marketing ; modne revije za promotivne svrhe (organizovanje) ; nabava za treće (usluge nabave za treće) [kupovina proizvoda i usluga za druga preduzeća] ; nabava za treće osobe (usluge kupovine proizvoda i usluga za druga preduzeća) ; narudžbine (administrativna obrada narudžbina za kupovinu) ; novine (usluge pretplate novina) za treće osobe ; objavljivanje reklamnih tekstova ; odabir osoblja psihotehničkim postupkom ; odnosi s javnošću [propaganda] ; oglašavanje [reklamiranje] ; oglašavanje putem pošte ; organizovanje izložbi u komercijalne ili reklamne svrhe ; organizovanje poslova (savjetovanje o organiziranju poslova) ; osoblje (biranje osoblja psihotehničkim postupkom) ; osoblje (savjetovanje o osoblju) ; osoblje (zapošljavanje osoblja) ; plakatiranje [oglašavanje] ; platni listovi (izrada platnih listova) ; podsticaj prodaje za treće osobe ; podugovaranje (usluge podugovaranja) [komercijalna pomoć] ; pomoć u upravljanju industrijskim ili trgovačkim preduzećima ; pomoć u vođenju poslova ; porezne prijave (izrada poreznih prijava) ; poslovi (istraživanja za poslove) ; poslovi (istraživanje za poslove) ; poslovi (konsultacije za vođenja poslova) ; poslovi (obavještenja o poslovima) ; poslovi (pomoć u vođenju poslova) ; poslovi (savjetovanje o organizaciji i vođenju poslova) ; poslovi (vještačenje poslova) [ekspertize] ; poslovne informacije ; potrošači (pružanje komercijalnih savjeta i informacija potrošačima) ; predstavljanje proizvoda [demonstracija] ; preduzeća (pomoć u vođenju komercijalnih ili industrijskih preduzeća) ; preduzeća (usluge preseljenja za preduzeća) ; prelamanje stranica u reklamne svrhe [stavljanje u štampu u reklamne svrhe] ; prepis saopštenja ; preseljavanje preduzeća (usluge preseljavanja preduzeća) ; pretplata na novine (usluge pretplate na novine) [za treće osobe] ; pretplata na telekomunikacione usluge za treća lica ; prezentacija proizvoda na svim komunikacionim sredstvima u svrhu prodaje na malo ; procjene komercijalnih poslova ; prodaja (podsticaj prodaje) za treće osobe ; prodaja na aukciji ; proizvodne cijene (analiza proizvodnih cijena) ; proučavanje tržišta [marketing] ; provjera računa ; psihotehnički odabir osoblja ; računovodstveni poslovi ; radio (reklamiranje putem radija) ; reklamiranje (iznajmljivanje prostora za potrebe reklamiranja) ; reklamiranje dopisnim putem ; reklamiranje on-line na informatičkoj mreži ; reklamiranje putem radija ; reklamiranje putem televizije ; reklamna dokumentacija (uređenje reklamne dokumentacije) ; reklamna pošta ; U reklamni filmovi (proizvodnja reklamnih filmova) ; reklamni materijal (iznajmljivanje reklamnog materijala) ; reklamni materijal (razdioba reklamnog materijala) ; reklamni materijal (raznošenje reklamnog materijala) ; reklamni oglasi (širenje reklamnih oglasa) ; reklamni tekstovi (objavljivanje reklamnih tekstova) ; reklamni tekstovi (uređenje reklamnih tekstova) ; sajmovi (organizovanje sajmova u komercijalne ili reklamne svrhe) ; saopštenja (prepisi,

saopštenja) ; savjeti o organizaciji i vođenju poslova ; savjetovanje (stručno savjetovanje o poslovima) ; savjetovanje o osoblju ; sekretarske usluge (sekretarske usluge) ; sistematizovanje podataka za središnju kartoteku ; sponzori (traženje sponzora) ; statistički podaci (izrada statističkih podataka) ; stenografske usluge ; stručne poslovne konsultacije ; štampa (praćenje štampe) ; štampa (usluge pregleda štampe) ; tekst (obrada teksta) ; telefonski odgovori (usluge telefonskih odgovora) za odsutne pretplatnike ; telekomunikacione usluge za treće lice (pretplata na telekomunikacione usluge za treće lice) ; telemarketing (usluge telemarketinga) ; televizijsko reklamiranje ; teretni vagoni (lociranje teretnih vagona pomoću kompjutera) ; trgovački poslovi (procjene trgovačkih poslova) ; tržište (proučavanje tržišta) ; tržište (traženje tržišta) ; umjetnički poslovi (profesionalno upravljanje umjetničkim poslovima) ; umnožavanje isprava ; uređenje izloga ; uvoz-izvoz (agencije za uvoz-izvoz) ; uzorci (isporuka uzoraka) ; vođenje informatičkih kartoteka ; vođenje knjiga ; vođenje poslova (pomoć u vođenju poslova) ; vođenje poslova (savjetovanje o vođenju poslova) ; vođenje poslova (usluge savjetovanja u vezi vođenja poslova) ; vođenje poslova poslovni za sportiste [poslovni menadžment] ; zapošljavanje (usluge kancelarije za zapošljavanje) ; zapošljavanje lica.

Klasa 36: Agencije za kredite ; agencije za nekretnine ; agencije za stanove [nepokretna imovina] ; agencije za utjerivanje potraživanja ; bankarske usluge, kućne ; bankarski poslovi [transakcije] ; bankovne transakcije (obavljanje bankovnih transakcija, kućne) [homebanking] ; bolesničko osiguranje ; carinske kancelarije [carinarski punktovi] ; čekovi (ovjera čekova) ; depoziti dragocjenosti ; dobrotvorne svrhe (skupljanje za dobrotvorne svrhe) ; dugovanje (službe za kartice dugovanja [debit kartice]) ; efektna berza [službeno bilježenje kurseva ugovorenih vrijednosti na tržištu] ; financije (savjetovanje u vezi financija) ; finansijska analiza ; finansijske procjene [osiguranje, banke, nekretnine] ; finansijski [bankarski] poslovi ; finansijski oglasi ; finansijski poslovi [transakcije] ; finansiranje (usluge finansiranja) ; fiskalne procjene ; fondovi (osnivanje fondova) ; garancije [garancije] ; građevinski objekti (upravljanje građevinskim objektima) ; imovina (upravljanje imovinom) ; informacije (finansijska obavještenja) ; informacije o osiguranju ; izdavanje putnih čekova ; izdavanje vrijednosnih bonova ; iznajmljivanje kancelarija [nekretnine] ; iznajmljivanje poljoprivrednih imanja ; iznajmljivanje stanova ; kapital (ulaganje kapitala) ; kompenzacijski poslovi [mijenjanje] ; krediti ; kreditne kartice (izdavanje kreditnih kartica) ; kreditne kartice (službe za kreditne kartice) ; likvidacija preduzeća (usluge likvidacije preduzeća) ; marke (procjena poštanskih maraka) ; mijenjanje novca (usluge mjenjačnica) ; monetarni poslovi ; nakit (procjena nakita) ; naknada štete (finansijska procjena naknade štete) ; nekretnine (agencije za nekretnine) ; nekretnine (davanje u zakup nekretnina) [lizing] ; nekretnine (procjena nekretnina) ; nekretnine (upravljanje nekretninama) ; nezgode (osiguranje od nezgoda) ; novčana sredstva (elektronski prijenos novčanih sredstava) ; numizmatička procjena ; osiguranja ; osiguranje (informacije o osiguranju) ; osiguranje (savjetovanje o osiguranju) ; osiguranje (usluge matematičkih stručnjaka [aktuara] za životno osiguranje) ; osnivanje kapitala ; otplata na rate ; ovjeravanje čekova ; penzije (usluge blagajni za plaćanje penzija) ; pokroviteljstvo (finansijsko pokroviteljstvo) ; poljoprivredna imanja (iznajmljivanje poljoprivrednih imanja) ; pomorsko osiguranje ; posredovanje [mešetarenje] ; posredovanje [mešetarenje] u trgovini nekretninama ; posredovanje na berzi ; posredovanje na berzi [mešetarenje] ; posredovanje u nekretninama ; posredovanje u osiguranju ; potraživanja (utjerivanje potraživanja jednog preduzeća posredstvom spoljnog nagodbenog tijela) [faktoring] ; povjereničke službe ; pozajmljivanje na temelju zaloga ; požar (osiguranje od požara) ; prijenos elektronskim putem novčanih sredstava ; procjena maraka ; procjena nakita ; procjena nekretnina ; procjena stabala u šumi ; procjena starina [antikviteta] ; procjena umjetnina ; procjena vune [finansijska procjena vune] ; procjene (fiskalne procjene) ; procjene (numizmatičke procjene) ; procjene finansijske procjene [osiguranje, bankarski promet, imovina] ; putni čekovi (izdavanje putnih čekova) ; savjetovanje o finansijskim pitanjima ; savjetovanje o osiguranju ; sigurnosne blagajne [sefovi] (odlaganje u sigurnosne blagajne) ; skupljanje priloga ; skupljanje za dobrotvorne svrhe ; sredstva (stvaranje zajedničkih sredstava) ; stabla u šumi (procjena stabala u šumi) ; stanarine (naplata stanarina) ; stanovi (iznajmljivanje stanova) ; starine (procjena starina) ; štedionice [usluge štedionica] ; transakcije (financijske transakcije) ; ulaganje sredstava ; umjetnička djela (procjena umjetničkih djela) ; upravljanje građevinskim objektima ; upravljanje imovinom ; upravljanje nekretninama ;

usluge depozita u sefovima ; usluge fondova uzajamne pomoći ; utjerivanje dugovanja (agencije za utjerivanje dugovanja) ; vrijednosni bonovi (izdavanje vrijednosnih bonova) ; vrijednosti (depoziti vrijednosti) ; zajam na temelju zalogu ; zajmovi ; zakup [vrsta iznajmljivanja dobara za profesionalne potrebe, koja temeljem ugovora mogu postati vlasništvo iznajmitelja] [lizing] ; zakup nekretnina (davanje u zakup nekretnina) [lizing] ; zalog (davanje zajma uz zalog) ; životno osiguranje (potpisivanje polisa za osiguranje života).

Klasa 37: Asfaltiranje ; automobili (održavanje i popravak automobila) ;U automobili (pranje automobila) ; avioni (održavanje i popravak aviona) ; bageri (iznajmljivanje bagera) ; bazeni (održavanje bazena) ; bijeljenje rublja ; blagajne (održavanje i popravak blagajni) ; bojleri (čišćenje i popravak bojlera) ; brave (popravak brava) ; brodogradnja ; buldožeri (iznajmljivanje buldožera) ; bunari (kopanje bunara) ; bušenje bunara ; centralno grijanje (postavljanje i popravak instalacija centralnog grijanja) ; čišćenje dimnjaka ; čišćenje odjeće ; čišćenje posteljine ; čišćenje puteva ; čišćenje unutrašnjosti zgrada [domaćinstvo] ; čišćenje vozila ; čišćenje zgrada [spoljnih površina] ; deratizacija ; dezinfekcija ; dimnjaci (čišćenje dimnjaka) ; domaćinstvo (obnavljanje namještaja) [restauriranje] ; domaćinstvo (održavanje namještaja) ; domaćinstvo (presvlačenje namještaja [tapeciranje]) ; električni aparati (postavljanje i popravak električnih aparata) ; fabrike (gradnja fabrika) ; fotografski aparati (popravak fotografskih aparata) ; gorionici (održavanje i popravak plamenika) ; građevinski radovi (nadzor građevinskih radova) ; gume (zamjena guma) ; gume za točkove (vulkanizacija guma za točkove) [popravak] ; informacije o graditeljstvu ; informacije o popravcima ; iskorištavanje kamenoloma ; izgradnja (oglasni o izgradnji) ; izgradnja ; izgradnja štandova i prodavaonica ; iznajmljivanje bagera ; iznajmljivanje buldožera ; iznajmljivanje dizalica [mašine za gradilišta] ; iznajmljivanje mašina za čišćenje ; iznajmljivanje mašina za gradilišta ; iznajmljivanje mašina za metenje ; iznajmljivanje uređaja za čišćenje ulica ; izolovanje (usluge izolovanja) [građevinski radovi] ; kalisanje [popravke] ; kamenolomi (vađenje kamena) ; kancelarijski aparati (postavljanje, popravak i održavanje kancelarijskih aparata) ; kinoprojektori (popravak i održavanje kino-projektora) ; kišobrani (popravak kišobrana) ;U klimatizacija vazduha (postavljanje i popravak uređaja za klimatizaciju) ; kompjuteri (postavljanje održavanje i popravak kompjutera) ; kotlovi (čišćenje i popravak kotlova) ; koža (održavanje, čišćenje i popravak kože) ; krađa (postavljanje i popravak alarmnih uređaja protiv krađe) ; krovopokrivači (usluge krovopokrivača) ; krzno (održavanje, čišćenje i popravak krzna) ; kuhinje (opremanje kuhinja) ; kvar na automobilu (pomoć pri kvaru na automobilu) [popravak] ; lakiranje ; liftovi (postavljanje i popravak liftova) ; luke (izgradnja luka) ; malterisanje ; mašine (obnavljanje istrošenih ili djelimično oštećenih mašina) ; mašine (postavljanje, održavanje i popravak mašina) ; molerske usluge, unutrašnje i spoljašnje [bojanje] ; motori (obnavljanje istrošenih ili djelimično oštećenih motora) ; muzički instrumenti (restauriranje muzičkih instrumenata) ; nadzor građevinskih radova [vođenje] ; naftovodi (postavljanje i održavanje naftovoda) ; natpisi [firme] (bojanje ili opravka natpisa) ; navodnjavanje (postavljanje i popravak uređaja za navodnjavanje) ; obavljanje podvodnih popravki ; obnavljanje [prekrajanje] odjeće ; obnavljanje namještaja [restauriranje] ; obrada protiv rđe ; obuća (popravak obuće) ; obućarski radovi ; odijela (popravak odijela) ; odjeća (čišćenje odjeće) ; odjeća (obnavljanje odjeće) ; odjeća (peglanje odjeće) ; održavanje vozila ; oštrenje noževa ; peći (postavljanje i popravak peći) ; peglanje odjeće parom ; peglanje rublja ; pjeskarenje [brušenje pješčanom puvalicom] ; plavi kamen (glačanje plavim kamenom) ; podmazivanje vozila ; podmorska izgradnja ; podmorske popravke ; poliranje vozila ; pomoć pri kvaru vozila [popravak] ; popravak i održavanje kinoprojektora ; popravci (informacije o popravcima) ; postavljanje papirnih tapeta ; postavljanje skela ; posteljno rublje (čišćenje postelnog rublja) ; požar (postavljanje i popravak uređaja za dojavu požara) ; pranje ; pranje automobila ; pranje prozora ; pranje vozila ; presvlačenje namještaja [tapeciranje] ; pristaništa (izgradnja pristaništa) ; prozori (pranje prozora) ; prozori i vrata (postavljanje prozora i vrata) ; pumpe (popravak pumpi) ; putevi (postavljanje slojeva za pokrivanje na ceste) ; radilište (iznajmljivanje mašina za gradilište) ; rashladni uređaji (postavljanje i popravak rashladnih uređaja) ; rđa (obrada protiv rđe) ; rđa (preventivna obrada protiv rđe) za vozila ; restauracija muzičkih instrumenata ; restauracija umjetničkih djela ; riznice (održavanje i popravak riznica) ; rublje (bijeljenje rublja) ; rublje (peglanje rublja) ; rublje (pranje rublja) ; rušenje građevinskih

objekata ; servisne stanice ; skele (postavljanje skela) ; skladišta (postavljanje i popravak skladišta) ; smetnje (uklanjanje smetnji električnih instalacija) ; snijeg (proizvodnja vještačkog snijega) ; stanice (servisne stanice) ; stilski namještaj (popravka stilskog namještaja) ; suncobrani (popravljanje suncobrana) ; suvo čišćenje ; šivenje ; štetočine (uništavanje štetočina osim u poljoprivredi) ; tapaciranje (popravke) ; tapete (postavljanje tapeta) ; telefoni (postavljanje i popravak telefona) ; ulošci s tonerom za štampače (usluge zamjene uložaka s tonerom za štampače) ; uništavanje štetočina [osim u poljoprivredi] ; urarstvo, časovničarstvo (održavanje i popravak svih vrsta satova) ; vađenje rude ; vodoinstalaterski radovi ; vozila (čišćenje vozila) ; vozila (održavanje vozila) ; vozila (podmazivanje vozila) ; vozila (poliranje vozila) ; vozila (pomoć pri kvaru vozila) [popravak] ; vozila (pranje vozila) ; vozila (zaštita vozila od rđe) ; vulkaniziranje gumenih točkova [popravka] ; zakivačke usluge ; zamjena guma ; zaštite građevina od vlage [izgradnja] ; zgrade (čišćenje zgrada) [spoljnih površina] ; zgrade (unutrašnje čišćenje zgrada) ; zidanje ciglom ; zidarski radovi.

Klasa 38: Agencije za novosti ; baze podataka (omogućavanje pristupa bazama podataka) ; bežična radiodifuzija ; elektronska pošta (omogućavanje elektronske pošte) ; elektronske poruke ; emitiranje televizijskih programa ; forumi za vođenje debata (omogućavanje održavanja foruma za vođenje debata) ; govorna pošta (omogućavanje govorne pošte) ; informacije o telekomunikacijama ; informativne agencije [novosti] ; iznajmljivanje aparata za prijenos poruka ; iznajmljivanje modema ; U iznajmljivanje telefaks-uređaja ; iznajmljivanje telefona ; iznajmljivanje telekomunikacijskih uređaja ; iznajmljivanje vremena pristupa svjetskim informatičkim mrežama ; kompjuter (prijenos poruka i slika uz pomoć kompjutera) ; kompjuterski prijenos poruka i slika ; kompjuterski terminali (komunikacije putem kompjuterskih terminala) ; komuniciranje posredstvom mreža optičkih kablova ; komunikacije (radiotelefonske komunikacije) ; komunikacije (telefonske komunikacije) ; komunikacije (telegrafске komunikacije) ; komunikacije pomoću kompjuterskih terminala ; konferencije na daljinu (omogućavanje vođenja konferencija na daljinu) ; kupovina putem telefona (pribavljanje komunikacionih kanala za kupovinu putem telefona) ; otprema pošiljki ; plakatanje (usluge elektronskog plakatanja) [telekomunikacije] ; pokretna radiotelefoniya ; poruke (prijenos poruka) ; prijenos čestitki putem interneta ; prijenos digitalnih datoteka ; prijenos poruka ; prijenos poruka (iznajmljivanje uređaja za prijenos poruka) ; prijenos poruka i slika kompjuterom ; prijenos putem satelita ; prijenos telegrama [telegrama] ; prijenos televizijskih emisija pretplatnicima putem kabla [kablovska televizija] ; pristup svjetskim informatičkim mrežama (iznajmljivanje vremena pristupa svjetskim informatičkim mrežama) ; pristup svjetskim informatičkim mrežama (omogućavanje pristupa svjetskim informatičkim mrežama) ; radio programi (emitovanje radio programa) ; radiodifuzija ; radioelektronsko pozivanje (usluge radioelektronskog pozivanja) [radio, telefon ili ostala elektronska komunikaciona sredstva] ; radiotelefonski prijenosi ; sateliti (prijenos putem satelita) ; telefaks (prijenos poruka telefaksom) ; telefonske komunikacije ; telefonske usluge ; telegrafске komunikacije ; telegrafске usluge ; telegrami (pošiljka telegrama) ; telegrami (prijenos telegrama) ; telekomunikacije (informacije o telekomunikacijama) ; telekomunikacije (usluge telekomunikacionog rutera) ; telekomunikaciono priključenje na svjetsku informatičku mrežu ; teleks (usluge teleksa) ; televizija (emitiranje televizijskih programa) ; televizijski programi (emitiranje televizijskih programa) ; vijesti (agencije za vijesti).

Klasa 39: Agencije (usluge turističkih agencija) [osim rezervisanja hotela, pansiona] ; ambalažiranje proizvoda ; autobuski prevoz ; brane (pokretanje vrata brana) ; brod (prevoz brodom) ; brodovi (iznajmljivanje brodova) ; brodovi (odsukavanje nasukanih brodova) ; brodovi (pretovar brodova pomoću plitkih barki) ; brodovi (skladištenje brodova) ; brodovi (spašavanje brodova) ; brodovi za razonodu (usluge brodova za razonodu) ; cjevovodi (prevoz cjevovodom) ; cvijeće (isporuka cvijeća) ; distribucija [isporuka] električne energije ; distribucija [isporuka] vode ; distribucija energije ; domaćinstvo (prevoz namještaja) ; dovod vode ; električna energija (isporuka električne energije) ; frankiranje pošte ; garaže (iznajmljivanje garaža) ; hitna pomoć (prevoz kolima hitne pomoći) ; hladnjaci (iznajmljivanje hladnjaka) ; informacije u vezi saobraćaja ; informacije u vezi skladištenja ; isporuka [distribucija] proizvoda ; isporuka [distribucija] robe ; isporuka cvijeća ; isporuka novina ; isporuka paketa ; isporuka proizvoda naručenih putem pošte ; istovar (usluge istovara) ; izleti

(turistički izleti) ; iznajmljivanje autobusa ; iznajmljivanje automobila ; iznajmljivanje aviona ; iznajmljivanje brodova ; iznajmljivanje frižidera ; iznajmljivanje garaža ; iznajmljivanje hladnjača ; iznajmljivanje invalidskih kolica ; iznajmljivanje konja ; iznajmljivanje nosača gepeka za automobile ; iznajmljivanje parkirališta ; iznajmljivanje putničkih vagona ; iznajmljivanje ronilačkih zvona ; iznajmljivanje skafandera [teških] ; iznajmljivanje skladišnih kontejnera ; iznajmljivanje skladišta ; iznajmljivanje teretnih vagona ; iznajmljivanje trkaćih vozila ; iznajmljivanje vozila ; kolica (prevoz kolicima) ; kontejneri za skladištenje (iznajmljivanje kontejnera za skladištenje) ; konji (iznajmljivanje konja) ; krstarenje (organizovanje krstarenja) ; kvarovi vozila (tegljenje vozila u kvaru) ; lansiranje satelita za druge ; ledolomci (usluge ledolomaca) ; lična vozila (iznajmljivanje vozila) ; lična vozila (prevoz ličnim vozilima) ; logističke usluge u vezi prevoza ; navigacijske usluge ; nošenje [prtljaga] ; novine (distribucija novina) ; odlaganje robe ; odsukavanje brodova ; organizovanje izleta ; organizovanje krstarenja ; organizovanje putovanja ; paketi (isporuka paketa) ; pakovanje proizvoda [umotavanje] ; parkirališta (iznajmljivanje parkirališta) ; parkirališta (usluge parkirališta) ; pilotiranje ; pokretna imovina (preseljenje pokretne imovine) ; pomoć (pružanje pomoći) [prevoz] ; pomoć pri kvaru na vozilima [vuča] ; pomorski prevoz ; pomorsko posredovanje [mešetarenje] ; posredovanje u prevozu ; posredovanje u zakupu broskog prostora ; pošiljka (usluge pošiljki) ; pošta (razdjela pošte) ; poštanske pošiljke [usluge prevoza poštanskih pošiljki ili robe] ; pratnja putnika ; pretovarivači (usluge pomorskih pretovarivača) ; prevoz (informacije o prevozu) ; prevoz (posredovanje u prevozu) ; prevoz (rezervacije za prevoz) ; prevoz (riječni prevoz) ; prevoz brodom ; prevoz dragocijenosti ; prevoz i istovar smeća ; prevoz kamionima ; prevoz kolicima ; prevoz robe ; prevoz skelom (usluge prevoza skelom) ; prevoz tegljačima ; prevoz, željeznicom ; prevozničke [špediterske] usluge ; prtljažni nosači za vozila (iznajmljivanje prtljažnih nosača za vozila) ; punjenje boca (usluge punjenja boca) ; putnici (pratnja putnicima) ; putnici (prevoz putnika) ; putovanja (organizovanje putovanja) ; putovanja (rezervacije za putovanja) ; rasonoda na brodu (usluge brodova za rasonodu) ; rezervisanje mjesta za putovanje ; riječni transport ; ronilačka zvona (iznajmljivanje ronilačkih zvona) ; sateliti (lansiranje satelita za druge) ; selidba (usluge preseljenja) ; skafanderi [teški] (iznajmljivanje skafandera) ; skela (prevoz skelom) ; skladišta (iznajmljivanje skladišta) ; skladištenje ; skladištenje (fizičko) elektronski sačuvanih podataka i dokumenata ; skladištenje (informacije u vezi skladištenja) ; skladištenje brodova ; spašavanje (službe za spašavanje) ; spašavanje (usluge spašavanja brodova) ; spašavanje u podmorju ; taksi-usluge ; trajektni prevoz ; tramvajske usluge ; turističke agencije (usluge turističkih agencija) [osim rezervisanja hotela i pansiona] ; turističke posjete ; umotavanje robe ; uputstva [informacije] o prevozu ; vagoni (iznajmljivanje teretnih vagona) ; vazdušni prevoz ; voda (dovod vode) ; voda (isporuka vode) ; vozači (usluge vozača) ; vozila (iznajmljivanje vozila) ; vozila hitne pomoći (prevoz vozilima hitne pomoći) ; vozila u kvaru (vuča vozila u kvaru) ; vrijednosti (prevoz vrijednosti) ; vuča [tegljenje] ; zakup broda za prevoz tereta i putnika ; željeznica (prevoz željeznicom).

Klasa 40: Apertura papira ; apertura tekstila (usluge aperture tekstila) ; bojanje stakla obradom površine ; bojanje tekstila ; boje (postupak odvajanja boja) ; brušenje ; čišćenje metala [dekapiranje-završna obrada ljuštenjem] ; dekontaminiranje opasnih materijala ; dezodorisanje vazduha [uklanjanje neugodnih mirisa] ; dimljenje namirnica ; drvo (radovi u drvetu) ; elektroliza (oblaganje postupkom elektrolize) ; energija (proizvodnja energije) ; fotografije (štampanje fotografija) ; fotografski filmovi (razvijanje fotografskih filmova) ; fotografure (izrada fotografura) ; fotokompozicija ; fotokompozicija [seriografija] (usluge fotokompozicije) ; galvanizacija ; hromiranje ; informacije o obradi materijala ; izbjeljivanje tkanina ; iznajmljivanje generatora ; iznajmljivanje pletećih mašina ; iznajmljivanje rezervnih uređaja za grijanje ; iznajmljivanje uređaja za klimatizaciju ; kadmij (oblaganje kadmijem) ; kalisanje ; kazandžijske usluge ; keramika (pečenje keramičkih proizvoda) ; kinematografski filmovi (obrada kinematografskih filmova) ; klanje životinja ; klimatizacija (iznajmljivanje uređaja za klimatizaciju) ; ključevi (usluge izrade kopija ključeva) ; knjigovezački radovi ; konzervisanje namirnica i pića ; kovački radovi ; koža (bojenje kože) ; koža (obrada kože) ; kožarstvo (obrada kože) ; krojačke usluge ; krzno (bojanje krzna) ; krzno (davanje sjaja krznu) ; krzno (izrada krznenih predmeta) ; krzno (oblikovanje krzna) ; krzno (obrada krzna protiv moljaca) ; krzno (satiranje krzna) ; lasersko trasiranje ; lijevanje metala ; litografsko štampanje ; magnetiziranje ;

metali (kaljenje metala) ; metali (oblaganje metalima) ; metali (obrada metala) ; mljevenje [frezanje] ; mljevenje brašna ; moljci (obrada krzna protiv moljaca) ; moljci (obrada tkanina protiv moljaca) ; nafta (obrada nafte) ; namirnice (zamrzavanje namirnica) ; nepromočivost tkanina (obrada tkanina za nepromočivost) ; niklovanje ; obaranje i rezanje drveta ; oblaganje kadmijumom ; obrada materijala (informacije o obradi materijala) ; obrada tkanina protiv gužvanja ; obuća (bojanje obuće) ; odjeća (prepravljavanje odjeće) ; ofset-štampanje ; opšivanje tkanine ; optička stakla (brušenje optičkih stakala) ; osvježavanja vazduha ; otpaci (obrada otpadaka) ; otpaci (razvrstavanje otpadaka i sirovina za recikliranje) [trijaža] ; papir (dorada papira) ; papir (obrada papira) ; peglanje tkanina ; piljenje (usluge piljenja) ; pletenje (iznajmljivanje mašina za pletenje) ; poliranje [struganje] ; posrebrivanje ; pozlaćivanje ; prepariranje životinja [taksidermija] ; prošivanje tkanine ; rafiniranje ; razvijanje fotografskih filmova ; recikliranje smeća i otpadaka ; rezanje tkanine ; rezbarenje [graviranje] ; sastavljanje materijala po narudžbini [za treće osobe] ; satiniranje krzna ; sedlarski radovi ; smeće (spaljivanje smeća) ; smeće (uništavanje smeća) ; smeće i otpaci (recikliranje smeća i otpadaka) ; spaljivanje smeća ; staklo (duvanje stakla) ; struganje [poliranje] ; šivenje ; štampanje (ofset-štampanje) ; štampanje na svili [seriografija] ; štamparstvo ; štavljenje kože ; tekstil (obrada tekstila) ; tkačke usluge [tkanje] ; tkanina (skupljanje tkanine pranjem) ; tkanine (bojanje tkanina) ; tkanine (obrada tkanina protiv gužvanja) ; tkanine (obrada tkanina protiv moljaca) ; tkanine (valjanje tkanina) ; tkanine (vatrostalna obrada tkanina) ; uokviravanje umjetničkih djela ; uređaji za grijanje (iznajmljivanje rezervnih uređaja za grijanje) ; usluge farbanja ; usluge pilana, strugarske usluge ; uzorci (štampanje uzoraka) ; valjanje metala ; valjanje tkanina ; vazduh (osvježavanje vazduha) ; vazduh (pročišćavanje vazduha) ; vazduh (uklanjanje mirisa iz vazduha [dezodoriranje]) ; vezanje ; voće (gnječenje voća) ; voda (obrada vode) ; vulkanizacija [obrada materijala] ; vuna (obrada vune) ; zamrzavanje namirnica ; zavarivanje ; zlato (oblaganje zlatom) ; zubar-protetičar (usluge zubara protetičara).

Klasa 41: Agencije za modele za slikare i vajare ; akademije [obuka] ; cirkusi ; cirkusi [zabavni parkovi] ; dekor za priredbe (iznajmljivanje dekora za priredbe) ; digitalne slike (usluge digitalnog snimanja) ; disk džokeji (usluge disk džokeja) usluge ; diskoteke (usluge diskoteka) ; dopisivanje (obuka putem dopisivanja) ; elektronske publikacije (iskorištavanje elektronskih publikacija koje se ne mogu prenositi on-line) ; filmovi (prikazivanje igranih filmova) ; filmovi (proizvodnja filmova) ; fitnes časovi (vođenje fitnes časova) ; fizičke vježbe [fizička kultura] ; fotografisanje ; fotografske reportaže ; gimnastičarska obuka ; golf (stavljanje na raspolaganje igrališta za golf) ; govor pokreta (tumačenje govora pokreta) ; govor pokretima (tumačenje govora pokretima) ; igre (usluge hala i dvorana za igre) ; igre (usluge igara) pružene on-line [s jedne informatičke mreže] ; igre za novac ; informacije o obrazovanju ; informacije o rasonodi ; informacije u vezi rekreacije ; izdavanje knjiga ; izložbe (organizovanje izložbi) u kulturne ili obrazovne svrhe ; iznajmljivanje audio uređaja ; iznajmljivanje dekora za priredbe ; iznajmljivanje igrački ; iznajmljivanje kinematografskih filmova ; iznajmljivanje kinoaparature i pribora ; iznajmljivanje magnetoskopa ; iznajmljivanje opreme za igranje ; iznajmljivanje radio i televizijskih aparata ; iznajmljivanje rasvjetnih uređaja za pozorišnu dekoraciju i za televizijske Studije ; iznajmljivanje ronilačke opreme ; iznajmljivanje sportske opreme [osim vozila] ; iznajmljivanje sportskih terena ; iznajmljivanje stadiona ; iznajmljivanje teniskih igrališta ; iznajmljivanje videokamera ; iznajmljivanje videotraka ; iznajmljivanje zvučnih snimaka ; javni konkursi (organizovanje javnih konkursa) [obuka ili zabava] ; kaligrafija (usluge kaligrafije) ; kampovi za ljetovanje (usluge kampova za ljetovanje) [zabava] ; kampovi za sportsko usavršavanje ; karaoke (stavljanje na raspolaganje opreme za karaoke) ; kinematografski filmovi (iznajmljivanje kinematografskih filmova) ; kino sale (iskorištavanje kinodvorana) ; kino studiji ; kinoaparatura (iznajmljivanje kinoaparature i pribora) ; klubovi (usluge klubova) [zabava ili obrazovanje] ; knjige (izdavanje knjiga) ; knjige (posuđivanje knjiga) ; kockarnice [igre] (usluge kockarnica) ; komponovanje muzike ; komponovanje muzike (usluge komponovanja muzike) ; koncerti (organizovanje i vođenje koncerata) ; konferencije (organizovanje i vođenje konferencija) ; kongresi (organizovanje i vođenje kongresa) ; kroćenje životinja [dresiranje] ; lični treneri (usluge ličnih trenera) [fitnes] ; lutrija (organizovanje lutrije) ; ljetovanje (usluge kampova za ljetovanje) [rasonoda] ; magnetoskopi (iznajmljivanje magnetoskopa) ; mikrofilmovi (snimanje na mikrofilmove) ;

mikroizdavaštvo ; mjerenje vremena na sportskim takmičenjima ; modne revije za zabavne svrhe (organizovanje) ; montaža radio i televizijskih programa ; muzejske usluge [predstavljanje, izložbe] ; muzičke sale ; noćni klubovi ; objavljivanje knjiga i časopisa, elektronski on line ; objavljivanje tekstova [osim u reklamne svrhe] ; obrazovanje (informacije o obrazovanju) ; obrazovanje [obuka] ; obrazovni zavodi [internati] ; obuka ; obuka [predavanje] ; obuka putem dopisivanja ; obuka za predškolski uzrast ; organizovanje i vođenje koncerata ; organizovanje i vođenje konferencija ; organizovanje i vođenje kongresa ; organizovanje i vođenje radionica za stručno osposobljavanje ; organizovanje i vođenje razgovora ; organizovanje i vođenje seminara ; organizovanje izložba u kulturne i obrazovne svrhe ; organizovanje javnih konkursa [obrazovanje ili razonoda] ; organizovanje konkursa ljepote ; organizovanje plesova ; organizovanje spektakla [usluge impresarija] ; organizovanje sportskih takmičenja ; orkestri (usluge orkestra) ; pedagoški eksperimenti ; pisanje tekstova [ne u reklamne svrhe] ; planiranje prijema [razonoda] ; posuđivanje knjiga ; pozorišne predstave ; pozorišni dekor (iznajmljivanje pozorišnog dekora) ; pozorišni glumci (usluge pozorišnih glumaca) ; pozorišni preduzetnici [impresariji] (usluge pozorišnih preduzetnika) ; praktična obuka [demonstriranje] ; predškolska obuka ; prekvalifikacija (usluge prekvalifikacije) ; prelamanje slogova [ne u reklamne svrhe] ; prevodilačke usluge ; prevodioci (usluge prevođenja) ; prijemi (planiranje prijema) [razonoda] ; priredbe (iznajmljivanje dekora za priredbe) ; priredbe (održavanje priredbi) ; priredbe (organizovanje priredbi) [usluge impresarija] ; priredbe (proizvodnja priredbi) ; profesionalna orijentacija [savjeti u vezi obrazovanja ili osposobljavanja] ; proizvodnja filmova ; proizvodnja filmova na video-trakama ; proizvodnja muzike ; putujuće biblioteke (usluge putujućih biblioteka) ; radio televizijski programi (montaža radio televizijskih programa) ; radioaparati i televizori (iznajmljivanje radioaparata i televizora) ; radiofonija (razonoda putem radiofonije) ; razgovori (organizovanje i vođenje razgovora) ; razonoda ; razonoda (informacije u vezi razonode) ; razonoda posredstvom radija ; razonoda posredstvom televizije ; rekreacija (obavještenja u vezi rekreacije) ; religiozno obrazovanje ; reportaže (fotografske reportaže) ; reporterske usluge ; rezervisanje mjesta za priredbe ; ronjenje (iznajmljivanje ronilačke opreme) ; scenarijumi (izrada scenarijuma) ; seminari (organizovanje i vođenje seminara) ; simpozijumi (organizacija i vođenje simpozijuma) ; simpozijumi (organizovanje i vođenje simpozijuma) ; sinhronizacija ; slobodno vrijeme (usluge za ispunjavanje slobodnog vremena) ; snimanje na videotrake ; sportska oprema (stavljanje na raspolaganje sportske opreme) ; sportska takmičenja (mjerenje vremena na sportskim takmičenjima) ; sportska takmičenja (organizovanje sportskih takmičenja) ; sportska usavršavanja (sportski kampovi za usavršavanje u sportu) ; sportske oprema (iznajmljivanje sportske opreme osim vozila) ; stadioni (iznajmljivanje stadiona) ; studio za snimanje (usluge studija za snimanje) ; tekstovi (objavljivanje tekstova) [osim u reklamne svrhe] ; tekstovi (sastavljanje tekstova) [ne u reklamne svrhe] ; televizija (razonoda na televiziji) ; televizijski programi (montaža radio i televizijskih programa) ; televizori (iznajmljivanje televizora i radioaparata) ; titlovanje filmova ; treniranje [fizička vježba] ; tumačenje govora pokreta ; ulaznice za priredbe (agencije za ulaznice za priredbe) [razonoda] ; videotrake (iznajmljivanje videotraka) ; videotrake (montaža videotraka) ; videotrake (proizvodnja filmova na videotrakama) ; videotrake (snimanje na videotrake) ; zabavni parkovi [cirkusi] ; zdravstveni klubovi (usluge zdravstvenih klubova) [održavanje zdravlja i fizičke forme] ; zoološki vrtovi [usluge zooloških vrtova] ; zvučni snimci (iznajmljivanje zvučnih snimaka) ; životinje (kročenje životinja) [dresiranje].

Klasa 42: Ambalaža (usluge dizajniranja ambalaže) ; analiza kompjuterskih sastava ; analiza rukopisa ; analiza u svrhu iskorištavanja naftnih izvora ; analiza vode ; analize (hemijske analize) ; arhitektura ; autorska prava (regulisanje autorskih prava) ; bakteriološka istraživanja ; baze podataka (obnavljanje baza podataka) ; biološka istraživanja ; daljinski nadzor kompjuterskih sistema ; digitalizacija dokumenata [skeniranje] ; dizajneri (usluga modnih dizajnera) ; dizajniranje ambalaže (usluge dizajniranja ambalaže) ; dizajniranje grafičke umjetnosti (usluge dizajniranja grafičke umjetnosti) ; dupliciranje informatičkih programa ; emisija ugljenika (pružanje naučnih informacija i savjeta u vezi smanjenja emisije ugljenika) ; fizika (istraživanja u fizici) ; geološka istraživanja ; geološka izviđanja terena ; geološka vještačenja [ekspertize] ; gradnja (savjeti o gradnji) ; grafička umjetnost (usluge dizajniranja grafičke umjetnosti) ; hemija (istraživanja u hemiji) ; hemijske analize

; hemijske usluge ; industrijski dizajn ; industrijsko oblikovanje ; informatičke stranice (ugošćavanje informatičkih stranica) ; informatički programi (dupliciranje informatičkih programa) ; informatički programi (iznajmljivanje informatičkih programa) ; informatički sistemi (osmišljavanje informatičkih sistema) ; informatički virusi (zaštita od informatičkih virusa) ; instaliranje kompjuterskih programa ; internet (pružanje alata za pretraživanje na internetu) ; inženjering ; ispitivanje materijala ; istraživanja (bakteriološka istraživanja) ; istraživanja morskih dubina ; istraživanja u kozmetici ; istraživanja u mehanici ; istraživanja u oblasti geologije ; istraživanja u tehnici ; istraživanja u vezi zaštite okoline ; istraživanje i razvoj novih proizvoda [za treće lice] ; istraživanje u hemiji ; izgradnja (izrada građevinskih planova) ; iznajmljivanje informatičkih programa ; iznajmljivanje informatičkih programa ; iznajmljivanje kompjutera ; iznajmljivanje veb servera ; izrada [koncipiranje] kompjuterskih programa ; izviđanja (geološka izviđanja) ; izvornost vještačkih djela (utvrđivanje izvornosti vještačkih djela) ; kalibracija [mjerenje] ; kiša (stvaranje vještačke kiše) ; kompjuteri (iznajmljivanje kompjutera) ; kompjuteri (programiranje za kompjutere) ; kompjuterski hardver (savjetovanje u vezi dizajna i razvoja kompjuterskog hardvera) ; kompjuterski programi (instaliranje kompjuterskih programa) ; kompjuterski programi (održavanje kompjuterskih programa) ; kompjuterski programi [softver] (izrada kompjuterskih programa) ; kompjuterski programi [softver] (osavremenjivanje kompjuterskih programa) ; konsultacije u vezi kompjuterskih programa [softvera] ; kontrola kvaliteta ; kontrola naftnih bušotina ; kontrola vozila (tehnička kontrola vozila i automobila) ; konverzija informatičkih podataka i programa [nije fizička konverzija] ; konverzija podataka ili dokumenata s jednog fizičkog na elektronski disk ; kozmetička djelatnost (istraživanja u kozmetičkoj djelatnosti) ; laboratorijske, naučne usluge ; licence za intelektualnu svojinu (ustupanje licenci za intelektualnu svojinu) ; materijali (istraživanje materijala) ; mehanika (istraživanja u mehanici) ; meteorološki izvještaji (usluge davanja meteoroloških izvještaja) ; mjerenje zemljišta ; modni dizajneri (usluge modnih dizajnera) ; nafta (traženje nafte) ; naftne bušotine (kontrola naftnih bušotina) ; naftni izvori (analiza u svrhu iskorištavanja naftnih izvora) ; naftni izvori (vještačenja naftnih izvora) [ekspertize] ; oblaci (sijanje oblaka, vještačka kiša) ; planovi (izrada građevinskih planova) ; procjena drvne mase stabala u šumi ; procjena kvalitete vune ; programiranje za kompjuteri ; razrada tehničkih projekata ; regulisanje autorskih prava ; savjeti o gradnji ; savjeti o intelektualnoj svojini ; savjeti u vezi štednje energije ; savjetovanje o kompjuterima ; savjetovanje u vezi zaštite okoline ; štednja energije (savjeti u vezi štednje energije) ; tehnička kontrola automobila ; tehnički projekti (razrada tehničkih projekata) ; tekstil (ispitivanje tekstila) ; traženje nafte ; umjetnička djela (utvrđivanje izvornosti umjetničkih djela) ; unutrašnje uređenje [dekoracija] ; urbanističko planiranje ; vještačenja (geološka vještačenja [ekspertize]) ; vještačenja [ekspertize] naftnih izvora ; vještačenja [inženjerske usluge] ; vuna (procjena kvalitete vune) ; web serveri (iznajmljivanje web servera) ; web stranice (kreiranje i održavanja web stranica za druge) ; zaštita od informatičkih virusa ; zaštita okoline (istraživanja u vezi zaštite okoline) ; zaštita okoline (savjetovanje u vezi zaštite okoline) ; zemljište (mjerenje zemljišta).

Klasa 43: Agencije za smještaj [hotelski, pansioni] ; aparati za kuvanje (iznajmljivanje) ; barovi (usluge barova) ; hotelske rezervacije (usluge rezervisanja hotela) ; hotelske usluge ; iznajmljivanje aparata za kuvanje ; iznajmljivanje prenosivih građevinskih objekata ; iznajmljivanje prenosivih građevinskih objekata ; iznajmljivanje privremenog smještaja ; iznajmljivanje sala, dvorana za sastanke ; iznajmljivanje stolova, stolnog rublja i staklenog posuđa ; iznajmljivanje šatora ; iznajmljivanje uređaja za pitku vodu ; jaslice [dječije ustanove] ; kafane [kafeterije] ; kafane-restorani ; kampovanje (stavljanje na raspolaganje terena za kampovanje) ; kampovi (iskorištavanje terena za kampiranje) ; kampovi za ljetovanje (usluge kampova za ljetovanje) [smještaj] ; kantine ; ljetovališta ; ljetovanje (usluge kampova za ljetovanje) ; moteli (usluge motela) ; pansion za životinje ; pansioni ; pansioni (rezervisanje pansiona) ; prenosivi građevinski objekti (iznajmljivanje prenosivih građevinskih objekata) ; privremeni smještaj (rezervisanje privremenog smještaja) ; restorani ; restorani sa samoposluživanjem ; restorani za brzo i stalno posluživanje [snek-barovi] ; rezervisanje hotela ; rezervisanje pansiona ; rezervisanje privremenog smještaja ; smještaj (agencije za izdavanje smještaja) [hoteli, pansioni] ; smještaj (iznajmljivanje privremenog smještaja) ; starije osobe

(ustanove za smještaj starijih osoba) [starački domovi] ; ugostitelji (usluge keteringa) ; ustanove za smještaj starijih osoba [starački domovi] ; životinje (pansioni za životinje).

Klasa 44: Akvakultura (usluge akvakulture) ; aromoterapija (usluge aromoterapije) ; banke krvi (usluge banaka krvi) ; bašte (usluge uređivača bašta) ; bašte (uređenje bašta) ; baštovani-pejzažisti (usluge baštovana-pejzažista) ; bolničke usluge ; cvijetni aranžmani (pravljenje cvijetnih aranžmana) ; dezintoksikacija toksikomana ; drveće (obrezivanje drveća) ; drveće (sadnja drveća radi smanjenja emisije ugljenika) ; estetska hirurgija ; farmaceuti (usluge farmaceuta) [pripremanje lijekova prema receptu] ; farmacija (savjetovanje o farmaciji) ; fizioterapija ; frizerski saloni ; gnojivo i ostali hemijski proizvodi namijenjeni za poljoprivredu (vazdušno ili drugačije razbacivanje [posipanje] gnojiva i ostalih hemijskih proizvoda za poljoprivredu) ; hirurgija (estetska hirurgija) ; iznajmljivanje medicinske opreme ; iznajmljivanje opreme za poljoprivredu ; iznajmljivanje sanitarnih uređaja ; javna kupališta za higijenske potrebe ; kiropraktika ; klinike ; korov (uništavanje korova) ; kosa (presađivanje kose) ; kupke (turske kupke) ; ljepota (usluge salona za uljepšavanje) ; manikirske usluge ; masaža ; medicinska pomoć ; medicinske klinike (usluge medicinskih klinika) ; njega životinja [timarenje] ; negovatelji bolesnika (usluge negovatelja bolesnika) ; obrezivanje drveća ; održavanje travnjaka ; oplodnja "in vitro" (usluge vještačke oplodnje) ; oporavak (ustanove za oporavak) ; optičarske usluge ; osjemenjivanje (usluge vještačkog osjemenjivanja) [inseminacije] ; pejzažna uređenja (koncepcija uređenja pejzaža) ; poljoprivredna oprema (iznajmljivanje opreme za poljoprivredna imanja) ; pomoć pri porođaju ; porođaj (pomoć pri porođaju) ; povrtlarstvo ; psiholog (usluge psihologa) ; rasadničari (usluge rasadničara) ; razbacivanje, vazdušnog ili drugog gnojiva, i ostalih hemijskih proizvoda u poljoprivredi ; saloni (frizerski saloni) ; saloni za uljepšavanje ; sanatoriji (usluge sanatorija) ; saune (usluge sauna) ; savjetovanje o farmaciji ; solarijumi (usluge solarijuma) ; štetočine (uništavanje životinjskih štetočina u poljoprivredi) ; telemedicina (usluge telemedicine) ; terapijske usluge ; tetoviranje ; timarenje životinja [pranje i negovanje] ; toplice (usluge toplica) ; travnjaci (održavanje travnjaka) ; turske kupke ; uništavanje korova ; ustanove za oporavak ; uzgoj životinja ; veterinarske usluge ; vijenci od cvijeća (izrada vijenaca od cvijeća) ; vizažisti (usluge vizažista) ; zbrinjavanje siromašnih [ustanove za prihvrat siromašnih] ; zdravstvene usluge ; zdravstveni centri ; zubarstvo ; životinje (pranje i negovanje životinja) ; životinje (timarenje životinja) [pranje i negovanje] ; životinje (uzgoj životinja).

Klasa 45: Agencije (bračne agencije) ; agencije (detektivske agencije) ; agencije za noćno čuvanje ; agencije za usvajanje ; arbitraža (usluge arbitraže) ; autorska prava (vođenje autorskih prava) ; bračne agencije ; brave (otvaranje brava) ; čuvanje djece kod kuće ; čuvanje kućnih ljubimaca kod kuće ; čuvanje stanova (usluge čuvanja stanova u odsustvu vlasnika) ; detektivske agencije ; djeca (čuvanje djece kod kuće) ; dojava požara (iznajmljivanje uređaja za dojavu požara) ; društvo (pratnja radi društva) [pratioci] ; gašenje vatre (usluge gašenja vatre) ; genealoška istraživanja ; građanska zaštita ; horoskopi (izrada horoskopa) ; imena domena (registrowanje imena domena) [pravne usluge] ; intelektualna svojina (usluge kontrole u vezi sa intelektualnom svojinom) ; intelektualna svojina (usluge, savjeti o intelektualnoj svojini) ; istraživanja (pravna istraživanja) ; iznajmljivanje odjeće ; iznajmljivanje sefova ; iznajmljivanje svećane odjeće ; iznajmljivanje uređaja za gašenje požara ; klubovi za susrete ; kontrola [nadzor] fabrika u vezi sigurnosti ; kontrola prtljaga radi sigurnosti ; kontrola u vezi intelektualnog vlasništva ; kremiranje (spaljivanje) ; kućni ljubimci (čuvanje kućnih ljubimaca kod kuće) ; licence za intelektualnu svojinu (ustupanje licenci za intelektualnu svojinu) ; licence za softvere (ustupanje licenci za softvere) [pravne usluge] ; nestale osobe (traženje nestalih osoba) ; noćno čuvanje (agencije za noćno čuvanje) ; odjeća (iznajmljivanje odjeće) ; organizovanje religioznih sastanaka ; parnice [nagodbene] kancelarije (usluge nagodbenih kancelarija) ; pogrebne usluge ; pratnja [usluge tjelohranitelja] ; pratnja za društvo (usluge pratnje u društvu) ; pravna istraživanja ; preci (istraživanje predaka) ; pronađene stvari (usluge kancelarije za pronađene stvari) ; protivprovalni uređaji (nadziranje protivprovalnih uređaja) ; prtljag (kontrola prtljaga radi sigurnosti) ; registrowanje imena domena ; religiozni sastanci (organizovanje religioznih sastanaka) ; savjeti u vezi intelektualne svojine ; savjetovanje o sigurnosti ; sefovi (iznajmljivanje sefova) ; sigurnost (savjetovanje o sigurnosti) ; sporovi (usluge alternativnog rješavanja sporova) ;

stanovi (usluge čuvanja stanova u odsutnosti vlasnika); sudske istrage ; svečana odjeća (iznajmljivanje svečane odjeće) ; traženje nestalih osoba; ukop mrtvacu ; ustupanje licenci za softvere [pravne usluge] ; usvajanje (agencije za usvajanje); vjenčanja (planiranje i organizovanje vjenčanja) ; zaštita građana; posredovanja [nisu pravna].

(210) **Ž-2019-186**

(220) 09.05.2019.

(731) DOO "HOUSE ESTATE", SVETI STEFAN, POŠTANSKI FAH BR.7, 85310, Budva, ME

(540)



(550) I

(511) Klasa 35: Agencije za komercijalne oglase ; agencije za uvoz-izvoz ; analiza proizvodne cijene ; aukcionarstvo (prodaja na aukciji) ; automati (iznajmljivanje automata) ; cijene (poređenje cijena) ; daktilografske usluge ; ekonomska predviđanja [prognoze] ; fakturisanje ; fotokopiranje (usluge fotokopiranja) ; hoteli (administrativno upravljanje hotelima) ; informacije (kancelarije za komercijalne informacije) ; informacije (poslovne informacije) ; informatičke kartoteke (vođenje informatičkih kartoteka) ; informatički podaci (pretraživanje podataka u informatičkoj kartoteci za treće lice) ; isporuka [distribucija] uzoraka ; isporuka reklamnih materijala [letaka, prospekata, uzoraka] ; isporuka reklamnih oglasa ; isprave (umnožavanje isprava) ; istraživanja za poslove ; istraživanje javnog mišljenja ; istraživanje za poslove ; izlozi (uređivanje izloga) ; izložbe (organizovanje izložbi) u komercijalne ili reklamne svrhe ; iznajmljivanje automata za prodaju sitne robe ; iznajmljivanje fotokopirnih uređaja ; iznajmljivanje kancelarijskih mašina i aparata ; iznajmljivanje reklamnih prostora ; iznajmljivanje reklamnog materijala ; iznajmljivanje vremena za reklamiranje na svim komunikacionim sredstvima ; izvodi iz računa (davanje izvoda sa računa) ; izvoz-uvoz (agencije za izvoz-uvoz) ; javno mnijenje (istraživanje javnog mnjenja) [anketiranje] ; javnost (odnosi s javnošću) [propaganda] ; kancelarije za reklamiranje ; kancelarije za zapošljavanje ; kancelarijski mašine i aparati (iznajmljivanje kancelarijskih mašina i aparata) ; kartoteka (prikupljanje podataka u središnju kartoteku) ; kartoteka (sistemizovanje podataka za središnju kartoteku) ; knjige (vođenje knjiga) ; komercijalna administracija u vezi licenci proizvoda i usluga trećih lica ; komercijalna ili industrijska preduzeća (pomoć u vođenju komercijalnih ili industrijskih preduzeća) ; konsultacije u vezi vođenje poslova ; lociranje teretnih vagona pomoću kompjutera ; manekeni (usluge manekena) za reklamiranje ili podsticaj prodaje ; marketing ; modne revije za promotivne svrhe (organizovanje) ; nabava za treće (usluge nabave za treće) [kupovina proizvoda i usluga za druga preduzeća] ; nabava za treće osobe (usluge kupovine proizvoda i usluga za druga preduzeća) ; narudžbine (administrativna obrada narudžbina za kupovinu) ; novine (usluge pretplate novina) za treće osobe ; objavljivanje reklamnih tekstova ; odabir osoblja psihotehničkim postupkom ; odnosi s javnošću [propaganda] ; oglašavanje [reklamiranje] ; oglašavanje putem pošte ; organizovanje izložbi u komercijalne ili reklamne svrhe ; organizovanje poslova (savjetovanje o organiziranju poslova) ; osoblje (biranje osoblja psihotehničkim postupkom) ; osoblje (savjetovanje o osoblju) ; osoblje (zapošljavanje osoblja) ; plakatiranje [oglašavanje] ; platni listovi (izrada platnih listova) ; podsticaj prodaje za treće osobe ; podugovaranje (usluge podugovaranja) [komercijalna pomoć] ; pomoć u

upravljanju industrijskim ili trgovačkim preduzećima ; pomoć u vođenju poslova ; porezne prijave (izrada poreznih prijava) ; poslovi (istraživanja za poslove) ; poslovi (istraživanje za poslove) ; poslovi (konsultacije za vođenja poslova) ; poslovi (obavještenja o poslovima) ; poslovi (pomoć u vođenju poslova) ; poslovi (savjetovanje o organizaciji i vođenju poslova) ; poslovi (vještačenje poslova) [ekspertize] ; poslovne informacije ; potrošači (pružanje komercijalnih savjeta i informacija potrošačima) ; predstavljanje proizvoda [demonstracija] ; preduzeća (pomoć u vođenju komercijalnih ili industrijskih preduzeća) ; preduzeća (usluge preseljenja za preduzeća) ; prelamanje stranica u reklamne svrhe [stavljanje u štampu u reklamne svrhe] ; prepis saopštenja ; preseljavanje preduzeća (usluge preseljavanja preduzeća) ; pretplata na novine (usluge pretplate na novine) [za treće osobe] ; pretplata na telekomunikacione usluge za treća lica ; prezentacija proizvoda na svim komunikacionim sredstvima u svrhu prodaje na malo ; procjene komercijalnih poslova ; prodaja (podsticaj prodaje) za treće osobe ; prodaja na aukciji ; proizvodne cijene (analiza proizvodnih cijena) ; proučavanje tržišta [marketing] ; provjera računa ; psihotehnički odabir osoblja ; računovodstveni poslovi ; radio (reklamiranje putem radija) ; reklamiranje (iznajmljivanje prostora za potrebe reklamiranja) ; reklamiranje dopisnim putem ; reklamiranje on-line na informatičkoj mreži ; reklamiranje putem radija ; reklamiranje putem televizije ; reklamna dokumentacija (uređenje reklamne dokumentacije) ; reklamna pošta ; U reklamni filmovi (proizvodnja reklamnih filmova) ; reklamni materijal (iznajmljivanje reklamnog materijala) ; reklamni materijal (razdioba reklamnog materijala) ; reklamni materijal (raznošenje reklamnog materijala) ; reklamni oglasi (širenje reklamnih oglasa) ; reklamni tekstovi (objavljivanje reklamnih tekstova) ; reklamni tekstovi (uređenje reklamnih tekstova) ; sajmovi (organizovanje sajmova u komercijalne ili reklamne svrhe) ; saopštenja (prepisi, saopštenja) ; savjeti o organizaciji i vođenju poslova ; savjetovanje (stručno savjetovanje o poslovima) ; savjetovanje o osoblju ; sekretarske usluge (sekretarske usluge) ; sistematizovanje podataka za središnju kartoteku ; sponzori (traženje sponzora) ; statistički podaci (izrada statističkih podataka) ; stenografske usluge ; stručne poslovne konsultacije ; štampa (praćenje štampe) ; štampa (usluge pregleda štampe) ; tekst (obrada teksta) ; telefonski odgovori (usluge telefonskih odgovora) za odsutne pretplatnike ; telekomunikacione usluge za treće lica (pretplata na telekomunikacione usluge za treće lica) ; telemarketing (usluge telemarketinga) ; televizijsko reklamiranje ; teretni vagoni (lociranje teretnih vagona pomoću kompjutera) ; trgovački poslovi (procjene trgovačkih poslova) ; tržište (proučavanje tržišta) ; tržište (traženje tržišta) ; umjetnički poslovi (profesionalno upravljanje umjetničkim poslovima) ; umnožavanje isprava ; uređenje izloga ; uvoz-izvoz (agencije za uvoz-izvoz) ; uzorci (isporuka uzoraka) ; vođenje informatičkih kartoteka ; vođenje knjiga ; vođenje poslova (pomoć u vođenju poslova) ; vođenje poslova (savjetovanje o vođenju poslova) ; vođenje poslova (usluge savjetovanja u vezi vođenja poslova) ; vođenje poslova poslovni za sportiste [poslovni menadžment] ; zapošljavanje (usluge kancelarije za zapošljavanje) ; zapošljavanje lica.

Klasa 36: Agencije za kredite ; agencije za nekretnine ; agencije za stanove [nepokretna imovina] ; agencije za utjerivanje potraživanja ; bankarske usluge, kućne ; bankarski poslovi [transakcije] ; bankovne transakcije (obavljanje bankovnih transakcija, kućne) [homebanking] ; bolesničko osiguranje ; carinske kancelarije [carinarski punktovi] ; čekovi (ovjera čekova) ; depoziti dragocjenosti ; dobrotvorne svrhe (skupljanje za dobrotvorne svrhe) ; dugovanje (službe za kartice dugovanja [debit kartice]) ; efektna berza [službeno bilježenje kurseva ugovorenih vrijednosti na tržištu] ; financije (savjetovanje u vezi financija) ; finansijska analiza ; finansijske procjene [osiguranje, banke, nekretnine] ; finansijski [bankarski] poslovi ; finansijski oglasi ; finansijski poslovi [transakcije] ; finansiranje (usluge finansiranja) ; fiskalne procjene ; fondovi (osnivanje fondova) ; garancije [garancije] ; građevinski objekti (upravljanje građevinskim objektima) ; imovina (upravljanje imovinom) ; informacije (finansijska obavještenja) ; informacije o osiguranju ; izdavanje putnih čekova ; izdavanje vrijednosnih bonova ; iznajmljivanje kancelarija [nekretnine] ; iznajmljivanje poljoprivrednih imanja ; iznajmljivanje stanova ; kapital (ulaganje kapitala) ; kompenzacijski poslovi [mijenjanje] ; krediti ; kreditne kartice (izdavanje kreditnih kartica) ; kreditne kartice (službe za kreditne kartice) ; likvidacija preduzeća (usluge likvidacije preduzeća) ; marke (procjena poštanskih maraka) ; mijenjanje novca (usluge mjenjačnica) ; monetarni poslovi ; nakit (procjena nakita) ; naknada štete (finansijska procjena naknade štete) ; nekretnine (agencije za nekretnine) ; nekretnine

(davanje u zakup nekretnina) [lizing] ; nekretnine (procjena nekretnina) ; nekretnine (upravljanje nekretninama) ; nezgode (osiguranje od nezgoda) ; novčana sredstva (elektronski prijenos novčanih sredstava) ; numizmatička procjena ; osiguranja ; osiguranje (informacije o osiguranju) ; osiguranje (savjetovanje o osiguranju) ; osiguranje (usluge matematičkih stručnjaka [aktuara] za životno osiguranje) ; osnivanje kapitala ; otplata na rate ; ovjeravanje čekova ; penzije (usluge blagajni za plaćanje penzija) ; pokroviteljstvo (finansijsko pokroviteljstvo) ; poljoprivredna imanja (iznajmljivanje poljoprivrednih imanja) ; pomorsko osiguranje ; posredovanje [mešetarenje] ; posredovanje [mešetarenje] u trgovini nekretninama ; posredovanje na berzi ; posredovanje na berzi [mešetarenje] ; posredovanje u nekretninama ; posredovanje u osiguranju ; potraživanja (utjerivanje potraživanja jednog preduzeća posredstvom spoljnog nagodbenog tijela) [faktoring] ; povjereničke službe ; pozajmljivanje na temelju zalogu ; požar (osiguranje od požara) ; prijenos elektronskim putem novčanih sredstava ; procjena maraka ; procjena nakita ; procjena nekretnina ; procjena stabala u šumi ; procjena starina [antikviteta] ; procjena umjetnina ; procjena vune [finansijska procjena vune] ; procjene (fiskalne procjene) ; procjene (numizmatičke procjene) ; procjene finansijske procjene [osiguranje, bankarski promet, imovina] ; putni čekovi (izdavanje putnih čekova) ; savjetovanje o finansijskim pitanjima ; savjetovanje o osiguranju ; sigurnosne blagajne [sefovi] (odlaganje u sigurnosne blagajne) ; skupljanje priloga ; skupljanje za dobrotvorne svrhe ; sredstva (stvaranje zajedničkih sredstava) ; stabla u šumi (procjena stabala u šumi) ; stanarine (naplata stanarina) ; stanovi (iznajmljivanje stanova) ; starine (procjena starina) ; štedionice [usluge štedionica] ; transakcije (financijske transakcije) ; ulaganje sredstava ; umjetnička djela (procjena umjetničkih djela) ; upravljanje građevinskim objektima ; upravljanje imovinom ; upravljanje nekretninama ; usluge depozita u sefovima ; usluge fondova uzajamne pomoći ; utjerivanje dugovanja (agencije za utjerivanje dugovanja) ; vrijednosni bonovi (izdavanje vrijednosnih bonova) ; vrijednosti (depoziti vrijednosti) ; zajam na temelju zalogu ; zajmovi ; zakup [vrsta iznajmljivanja dobara za profesionalne potrebe, koja temeljem ugovora mogu postati vlasništvo iznajmitelja] [lizing] ; zakup nekretnina (davanje u zakup nekretnina) [lizing] ; zalog (davanje zajma uz zalog) ; životno osiguranje (potpisivanje polisa za osiguranje života).

Klasa 37: Asfaltiranje ; automobili (održavanje i popravak automobila) ;U automobili (pranje automobila) ; avioni (održavanje i popravak aviona) ; bageri (iznajmljivanje bagera) ; bazeni (održavanje bazena) ; bijeljenje rublja ; blagajne (održavanje i popravak blagajni) ; bojleri (čišćenje i popravak bojlera) ; brave (popravak brava) ; brodogradnja ; buldožeri (iznajmljivanje buldožera) ; bunari (kopanje bunara) ; bušenje bunara ; centralno grijanje (postavljanje i popravak instalacija centralnog grijanja) ; čišćenje dimnjaka ; čišćenje odjeće ; čišćenje posteljine ; čišćenje puteva ; čišćenje unutrašnjosti zgrada [domaćinstvo] ; čišćenje vozila ; čišćenje zgrada [spoljnih površina] ; deratizacija ; dezinfekcija ; dimnjaci (čišćenje dimnjaka) ; domaćinstvo (obnavljanje namještaja) [restauriranje] ; domaćinstvo (održavanje namještaja) ; domaćinstvo (presvlačenje namještaja [tapeciranje]) ; električni aparati (postavljanje i popravak električnih aparata) ; fabrike (gradnja fabrika) ; fotografski aparati (popravak fotografskih aparata) ; gorionici (održavanje i popravak plamenika) ; građevinski radovi (nadzor građevinskih radova) ; gume (zamjena guma) ; gume za točkove (vulkanizacija guma za točkove) [popravak] ; informacije o graditeljstvu ; informacije o popravcima ; iskorištavanje kamenoloma ; izgradnja (oglasi o izgradnji) ; izgradnja ; izgradnja štandova i prodavaonica ; iznajmljivanje bagera ; iznajmljivanje buldožera ; iznajmljivanje dizalica [mašine za gradilišta] ; iznajmljivanje mašina za čišćenje ; iznajmljivanje mašina za gradilišta ; iznajmljivanje mašina za metenje ; iznajmljivanje uređaja za čišćenje ulica ; izolovanje (usluge izolovanja) [građevinski radovi] ; kalaisanje [popravke] ; kamenolomi (vađenje kamena) ; kancelarijski aparati (postavljanje, popravak i održavanje kancelarijskih aparata) ; kinoprojektori (popravak i održavanje kino-projektora) ; kišobrani (popravak kišobrana) ;U klimatizacija vazduha (postavljanje i popravak uređaja za klimatizaciju) ; kompjuteri (postavljanje održavanje i popravak kompjutera) ; kotlovi (čišćenje i popravak kotlova) ; koža (održavanje, čišćenje i popravak kože) ; krađa (postavljanje i popravak alarmnih uređaja protiv krađe) ; krovopokrivači (usluge krovopokrivača) ; krzno (održavanje, čišćenje i popravak krzna) ; kuhinje (opremanje kuhinja) ; kvar na automobilu (pomoć pri kvaru na automobilu) [popravak] ; lakiranje ; liftovi (postavljanje i popravak

liftova) ; luke (izgradnja luka) ; malterisanje ; mašine (obnavljanje istrošenih ili djelimično oštećenih mašina) ; mašine (postavljanje, održavanje i popravak mašina) ; molerske usluge, unutrašnje i spoljašnje [bojanje] ; motori (obnavljanje istrošenih ili djelimično oštećenih motora) ; muzički instrumenti (restauriranje muzičkih instrumenata) ; nadzor građevinskih radova [vođenje] ; naftovodi (postavljanje i održavanje naftovoda) ; natpisi [firme] (bojanje ili opravka natpisa) ; navodnjavanje (postavljanje i popravak uređaja za navodnjavanje) ; obavljanje podvodnih popravki ; obnavljanje [prekrajnje] odjeće ; obnavljanje namještaja [restauriranje] ; obrada protiv rđe ; obuća (popravak obuće) ; obućarski radovi ; odijela (popravak odijela) ; odjeća (čišćenje odjeće) ; odjeća (obnavljanje odjeće) ; odjeća (peglanje odjeće) ; održavanje vozila ; oštrenje noževa ; peći (postavljanje i popravak peći) ; peglanje odjeće parom ; peglanje rublja ; pjeskarenje [brušenje pješčanom puvalicom] ; plavi kamen (glačanje plavim kamenom) ; podmazivanje vozila ; podmorska izgradnja ; podmorske popravke ; poliranje vozila ; pomoć pri kvaru vozila [popravak] ; popravak i održavanje kinoprojektora ; popravci (informacije o popravcima) ; postavljanje papirnih tapeta ; postavljanje skela ; posteljno rublje (čišćenje postelnog rublja) ; požar (postavljanje i popravak uređaja za dojavu požara) ; pranje ; pranje automobila ; pranje prozora ; pranje vozila ; presvlačenje namještaja [tapeciranje] ; pristaništa (izgradnja pristaništa) ; prozori (pranje prozora) ; prozori i vrata (postavljanje prozora i vrata) ; pumpe (popravak pumpi) ; putevi (postavljanje slojeva za pokrivanje na ceste) ; radilište (iznajmljivanje mašina za gradilište) ; rashladni uređaji (postavljanje i popravak rashladnih uređaja) ; rđa (obrada protiv rđe) ; rđa (preventivna obrada protiv rđe) za vozila ; restauracija muzičkih instrumenata ; restauracija umjetničkih djela ; riznice (održavanje i popravak riznica) ; rublje (bijeljenje rublja) ; rublje (peglanje rublja) ; rublje (pranje rublja) ; rušenje građevinskih objekata ; servisne stanice ; skele (postavljanje skela) ; skladišta (postavljanje i popravak skladišta) ; smetnje (uklanjanje smetnji električnih instalacija) ; snijeg (proizvodnja vještačkog snijega) ; stanice (servisne stanice) ; stilski namještaj (popravka stilskog namještaja) ; suncobrani (popravljanje suncobrana) ; suvo čišćenje ; šivenje ; štetočine (uništavanje štetočina osim u poljoprivredi) ; tapaciranje (popravke) ; tapete (postavljanje tapeta) ; telefoni (postavljanje i popravak telefona) ; ulošci s tonerom za štampače (usluge zamjene uložaka s tonerom za štampače) ; uništavanje štetočina [osim u poljoprivredi] ; urarstvo, časovničarstvo (održavanje i popravak svih vrsta satova) ; vađenje rude ; vodoinstalaterski radovi ; vozila (čišćenje vozila) ; vozila (održavanje vozila) ; vozila (podmazivanje vozila) ; vozila (poliranje vozila) ; vozila (pomoć pri kvaru vozila) [popravak] ; vozila (pranje vozila) ; vozila (zaštita vozila od rđe) ; vulkaniziranje gumenih točkova [popravka] ; zakivačke usluge ; zamjena guma ; zaštite građevina od vlage [izgradnja] ; zgrade (čišćenje zgrada) [spoljnih površina] ; zgrade (unutrašnje čišćenje zgrada) ; zidanje ciglom ; zidarski radovi.

Klasa 38: Agencije za novosti ; baze podataka (omogućavanje pristupa bazama podataka) ; bežična radiodifuzija ; elektronska pošta (omogućavanje elektronske pošte) ; elektronske poruke ; emitiranje televizijskih programa ; forumi za vođenje debata (omogućavanje održavanja foruma za vođenje debata) ; govorna pošta (omogućavanje govorne pošte) ; informacije o telekomunikacijama ; informativne agencije [novosti] ; iznajmljivanje aparata za prijenos poruka ; iznajmljivanje modema ; U iznajmljivanje telefaks-uređaja ; iznajmljivanje telefona ; iznajmljivanje telekomunikacijskih uređaja ; iznajmljivanje vremena pristupa svjetskim informatičkim mrežama ; kompjuter (prijenos poruka i slika uz pomoć kompjutera) ; kompjuterski prijenos poruka i slika ; kompjuterski terminali (komunikacije putem kompjuterskih terminala) ; komuniciranje posredstvom mreža optičkih kablova ; komunikacije (radiotelefonske komunikacije) ; komunikacije (telefonske komunikacije) ; komunikacije (telegrafske komunikacije) ; komunikacije pomoću kompjuterskih terminala ; konferencije na daljinu (omogućavanje vođenja konferencija na daljinu) ; kupovina putem telefona (pribavljanje komunikacionih kanala za kupovinu putem telefona) ; otprema pošiljki ; plakatiranje (usluge elektronskog plakatiranja) [telekomunikacije] ; pokretna radiotelefoniya ; poruke (prijenos poruka) ; prijenos čestitki putem interneta ; prijenos digitalnih datoteka ; prijenos poruka ; prijenos poruka (iznajmljivanje uređaja za prijenos poruka) ; prijenos poruka i slika kompjuterom ; prijenos putem satelita ; prijenos telegrama [telegrama] ; prijenos televizijskih emisija pretplatnicima putem kabla [kablovska televizija] ; pristup svjetskim informatičkim mrežama (iznajmljivanje vremena pristupa svjetskim informatičkim mrežama) ; pristup svjetskim informatičkim mrežama

(omogućavanje pristupa svjetskim informatičkim mrežama) ; radio programi (emitovanje radio programa) ; radiodifuzija ; radioelektronsko pozivanje (usluge radioelektronskog pozivanja) [radio, telefon ili ostala elektronska komunikaciona sredstva] ; radiotelefonski prijenosi ; sateliti (prijenos putem satelita) ; telefaks (prijenos poruka telefaksom) ; telefonske komunikacije ; telefonske usluge ; telegrafске komunikacije ; telegrafске usluge ; telegrami (pošiljka telegrama) ; telegrami (prijenos telegrama) ; telekomunikacije (informacije o telekomunikacijama) ; telekomunikacije (usluge telekomunikacionog rutera) ; telekomunikaciono priključenje na svjetsku informatičku mrežu ; teleks (usluge teleksa) ; televizija (emitiranje televizijskih programa) ; televizijski programi (emitiranje televizijskih programa) ; vijesti (agencije za vijesti).

Klasa 39: Agencije (usluge turističkih agencija) [osim rezervisanja hotela, pansiona] ; ambalažiranje proizvoda ; autobuski prevoz ; brane (pokretanje vrata brana) ; brod (prevoz brodom) ; brodovi (iznajmljivanje brodova) ; brodovi (odsukavanje nasukanih brodova) ; brodovi (pretovar brodova pomoću plitkih barki) ; brodovi (skladištenje brodova) ; brodovi (spašavanje brodova) ; brodovi za razonodu (usluge brodova za razonodu) ; cjevovodi (prevoz cjevovodom) ; cvijeće (isporuka cvijeća) ; distribucija [isporuka] električne energije ; distribucija [isporuka] vode ; distribucija energije ; domaćinstvo (prevoz namještaja) ; dovod vode ; električna energija (isporuka električne energije) ; frankiranje pošte ; garaže (iznajmljivanje garaža) ; hitna pomoć (prevoz kolima hitne pomoći) ; hladnjaci (iznajmljivanje hladnjaka) ; informacije u vezi saobraćaja ; informacije u vezi skladištenja ; isporuka [distribucija] proizvoda ; isporuka [distribucija] robe ; isporuka cvijeća ; isporuka novina ; isporuka paketa ; isporuka proizvoda naručenih putem pošte ; istovar (usluge istovara) ; izleti (turistički izleti) ; iznajmljivanje autobusa ; iznajmljivanje automobila ; iznajmljivanje aviona ; iznajmljivanje brodova ; iznajmljivanje frižidera ; iznajmljivanje garaža ; iznajmljivanje hladnjača ; iznajmljivanje invalidskih kolica ; iznajmljivanje konja ; iznajmljivanje nosača gepeka za automobile ; iznajmljivanje parkirališta ; iznajmljivanje putničkih vagona ; iznajmljivanje ronilačkih zvona ; iznajmljivanje skafandera [teških] ; iznajmljivanje skladišnih kontejnera ; iznajmljivanje skladišta ; iznajmljivanje teretnih vagona ; iznajmljivanje trkaćih vozila ; iznajmljivanje vozila ; kolica (prevoz kolicima) ; kontejneri za skladištenje (iznajmljivanje kontejnera za skladištenje) ; konji (iznajmljivanje konja) ; krstarenje (organizovanje krstarenja) ; kvarovi vozila (tegljenje vozila u kvaru) ; lansiranje satelita za druge ; ledolomci (usluge ledolomaca) ; lična vozila (iznajmljivanje vozila) ; lična vozila (prevoz ličnim vozilima) ; logističke usluge u vezi prevoza ; navigacijske usluge ; nošenje [prtljaga] ; novine (distribucija novina) ; odlaganje robe ; odsukavanje brodova ; organizovanje izleta ; organizovanje krstarenja ; organizovanje putovanja ; paketi (isporuka paketa) ; pakovanje proizvoda [umotavanje] ; parkirališta (iznajmljivanje parkirališta) ; parkirališta (usluge parkirališta) ; pilotiranje ; pokretna imovina (preseljenje pokretne imovine) ; pomoć (pružanje pomoći) [prevoz] ; pomoć pri kvaru na vozilima [vuča] ; pomorski prevoz ; pomorsko posredovanje [mešetarenje] ; posredovanje u prevozu ; posredovanje u zakupu broskog prostora ; pošiljka (usluge pošiljki) ; pošta (razdjela pošte) ; poštanske pošiljke [usluge prevoza poštanskih pošiljki ili robe] ; pratnja putnika ; pretovarivači (usluge pomorskih pretovarivača) ; prevoz (informacije o prevozu) ; prevoz (posredovanje u prevozu) ; prevoz (rezervacije za prevoz) ; prevoz (riječni prevoz) ; prevoz brodom ; prevoz dragocijenosti ; prevoz i istovar smeća ; prevoz kamionima ; prevoz kolicima ; prevoz robe ; prevoz skelom (usluge prevoza skelom) ; prevoz tegljačima ; prevoz, željeznicom ; prevozničke [špediterske] usluge ; prtljažni nosači za vozila (iznajmljivanje prtljažnih nosača za vozila) ; punjenje boca (usluge punjenja boca) ; putnici (pratnja putnicima) ; putnici (prevoz putnika) ; putovanja (organizovanje putovanja) ; putovanja (rezervacije za putovanja) ; razonoda na brodu (usluge brodova za razonodu) ; rezervisanje mjesta za putovanje ; riječni transport ; ronilačka zvona (iznajmljivanje ronilačkih zvona) ; sateliti (lansiranje satelita za druge) ; selidba (usluge preseljenja) ; skafanderi [teški] (iznajmljivanje skafandera) ; skela (prevoz skelom) ; skladišta (iznajmljivanje skladišta) ; skladištenje ; skladištenje (fizičko) elektronski sačuvanih podataka i dokumenata ; skladištenje (informacije u vezi skladištenja) ; skladištenje brodova ; spašavanje (službe za spašavanje) ; spašavanje (usluge spašavanja brodova) ; spašavanje u podmorju ; taksi-usluge ; trajektni prevoz ; tramvajske usluge ; turističke agencije (usluge turističkih agencija) [osim rezervisanja hotela i pansiona] ; turističke posjete ; umotavanje robe ; uputstva [informacije] o

prevozu ; vagoni (iznajmljivanje teretnih vagona) ; vazdušni prevoz ; voda (dovod vode) ; voda (isporuka vode) ; vozači (usluge vozača) ; vozila (iznajmljivanje vozila) ; vozila hitne pomoći (prevoz vozilima hitne pomoći) ; vozila u kvaru (vuča vozila u kvaru) ; vrijednosti (prevoz vrijednosti) ; vuča [tegljenje] ; zakup broda za prevoz tereta i putnika ; željeznica (prevoz željeznicom).

Klasa 40: Apretura papira ; apretura tekstila (usluge apreture tekstila) ; bojanje stakla obradom površine ; bojanje tekstila ; boje (postupak odvajanja boja) ; brušenje ; čišćenje metala [dekapiranje-završna obrada ljuštenjem] ; dekontaminiranje opasnih materijala ; dezodorisanje vazduha [uklanjanje neugodnih mirisa] ; dimljenje namirnica ; drvo (radovi u drvetu) ; elektroliza (oblaganje postupkom elektrolize) ; energija (proizvodnja energije) ; fotografije (štampanje fotografija) ; fotografski filmovi (razvijanje fotografskih filmova) ; fotografske (izrada fotografske) ; fotokompozicija ; fotokompozicija [seriografija] (usluge fotokompozicije) ; galvanizacija ; hromiranje ; informacije o obradi materijala ; izbjeljivanje tkanina ; iznajmljivanje generatora ; iznajmljivanje pletećih mašina ; iznajmljivanje rezervnih uređaja za grijanje ; iznajmljivanje uređaja za klimatizaciju ; kadmij (oblaganje kadmijem) ; kalisanje ; kazandžijske usluge ; keramika (pečenje keramičkih proizvoda) ; kinematografski filmovi (obrada kinematografskih filmova) ; klanje životinja ; klimatizacija (iznajmljivanje uređaja za klimatizaciju) ; ključevi (usluge izrade kopija ključeva) ; knjigovezački radovi ; konzervisanje namirnica i pića ; kovački radovi ; koža (bojenje kože) ; koža (obrada kože) ; kožarstvo (obrada kože) ; krojačke usluge ; krzno (bojanje krzna) ; krzno (davanje sjaja krznu) ; krzno (izrada krznenih predmeta) ; krzno (oblikovanje krzna) ; krzno (obrada krzna protiv moljaca) ; krzno (satiniranje krzna) ; lasersko trasiranje ; lijevanje metala ; litografsko štampanje ; magnetiziranje ; metali (kaljenje metala) ; metali (oblaganje metalima) ; metali (obrada metala) ; mljevenje [freziranje] ; mljevenje brašna ; moljci (obrada krzna protiv moljaca) ; moljci (obrada tkanina protiv moljaca) ; nafta (obrada nafte) ; namirnice (zamrzavanje namirnica) ; nepromoćivost tkanina (obrada tkanina za nepromoćivost) ; niklovanje ; obaranje i rezanje drveta ; oblaganje kadmijumom ; obrada materijala (informacije o obradi materijala) ; obrada tkanina protiv gužvanja ; obuća (bojanje obuće) ; odjeća (prepravljivanje odjeće) ; ofset-štampanje ; opšivanje tkanine ; optička stakla (brušenje optičkih stakala) ; osvježavanje vazduha ; otpaci (obrada otpadaka) ; otpaci (razvrstavanje otpadaka i sirovina za recikliranje) [trijaža] ; papir (dorada papira) ; papir (obrada papira) ; peglanje tkanina ; piljenje (usluge piljenja) ; pletenje (iznajmljivanje mašina za pletenje) ; poliranje [struganje] ; posrebrivanje ; pozlaćivanje ; prepariranje životinja [taksidermija] ; prošivanje tkanine ; rafiniranje ; razvijanje fotografskih filmova ; recikliranje smeća i otpadaka ; rezanje tkanine ; rezbarenje [graviranje] ; sastavljanje materijala po narudžbini [za treće osobe] ; satiniranje krzna ; sedlarski radovi ; smeće (spaljivanje smeća) ; smeće (uništavanje smeća) ; smeće i otpaci (recikliranje smeća i otpadaka) ; spaljivanje smeća ; staklo (duvanje stakla) ; struganje [poliranje] ; šivenje ; štampanje (ofset-štampanje) ; štampanje na svili [seriografija] ; štamparstvo ; štavljenje kože ; tekstil (obrada tekstila) ; tkačke usluge [tkanje] ; tkanina (skupljanje tkanine pranjem) ; tkanine (bojanje tkanina) ; tkanine (obrada tkanina protiv gužvanja) ; tkanine (obrada tkanina protiv moljaca) ; tkanine (valjanje tkanina) ; tkanine (vatrostalna obrada tkanina) ; uokviravanje umjetničkih djela ; uređaji za grijanje (iznajmljivanje rezervnih uređaja za grijanje) ; usluge farbanja ; usluge pilana, strugarske usluge ; uzorci (štampanje uzoraka) ; valjanje metala ; valjanje tkanina ; vazduh (osvježavanje vazduha) ; vazduh (pročišćavanje vazduha) ; vazduh (uklanjanje mirisa iz vazduha [dezodoriranje]) ; vezanje ; voće (gnječenje voća) ; voda (obrada vode) ; vulkanizacija [obrada materijala] ; vuna (obrada vune) ; zamrzavanje namirnica ; zavarivanje ; zlato (oblaganje zlatom) ; zubar-protetičar (usluge zubara protetičara).

Klasa 41: Agencije za modele za slikare i vajarke ; akademije [obuka] ; cirkusi ; cirkusi [zabavni parkovi] ; dekor za priredbe (iznajmljivanje dekora za priredbe) ; digitalne slike (usluge digitalnog snimanja) ; disk džokeji (usluge disk džokeja) usluge ; diskoteke (usluge diskoteka) ; dopisivanje (obuka putem dopisivanja) ; elektronske publikacije (iskorištavanje elektronskih publikacija koje se ne mogu prenositi on-line) ; filmovi (prikazivanje igranih filmova) ; filmovi (proizvodnja filmova) ; fitness časovi (vođenje fitness časova) ; fizičke vježbe [fizička kultura] ; fotografisanje ; fotografske reportaže ; gimnastičarska obuka ; golf (stavljivanje na raspolaganje igrališta za golf) ; govor pokreta (tumačenje

govora pokreta) ; govor pokretima (tumačenje govora pokretima) ; igre (usluge hala i dvorana za igre) ; igre (usluge igara) pružene on-line [s jedne informatičke mreže] ; igre za novac ; informacije o obrazovanju ; informacije o razonodi ; informacije u vezi rekreacije ; izdavanje knjiga ; izložbe (organizovanje izložbi) u kulturne ili obrazovne svrhe ; iznajmljivanje audio uređaja ; iznajmljivanje dekora za priredbe ; iznajmljivanje igrački ; iznajmljivanje kinematografskih filmova ; iznajmljivanje kinoaparature i pribora ; iznajmljivanje magnetoskopa ; iznajmljivanje opreme za igranje ; iznajmljivanje radio i televizijskih aparata ; iznajmljivanje rasvjetnih uređaja za pozorišnu dekoraciju i za televizijske Studije ; iznajmljivanje ronilačke opreme ; iznajmljivanje sportske opreme [osim vozila] ; iznajmljivanje sportskih terena ; iznajmljivanje stadiona ; iznajmljivanje teniskih igrališta ; iznajmljivanje videokamera ; iznajmljivanje videotraka ; iznajmljivanje zvučnih snimaka ; javni konkursi (organizovanje javnih konkursa) [obuka ili zabava] ; kaligrafija (usluge kaligrafije) ; kampovi za ljetovanje (usluge kampova za ljetovanje) [zabava] ; kampovi za sportsko usavršavanje ; karaoke (stavljanje na raspolaganje opreme za karaoke) ; kinematografski filmovi (iznajmljivanje kinematografskih filmova) ; kino sale (iskorištavanje kinodvorana) ; kino studiji ; kinoaparatura (iznajmljivanje kinoaparature i pribora) ; klubovi (usluge klubova) [zabava ili obrazovanje] ; knjige (izdavanje knjiga) ; knjige (posuđivanje knjiga) ; kockarnice [igre] (usluge kockarnica) ; komponovanje muzike ; komponovanje muzike (usluge komponovanja muzike) ; koncerti (organizovanje i vođenje koncerata) ; konferencije (organizovanje i vođenje konferencija) ; kongresi (organizovanje i vođenje kongresa) ; kroćenje životinja [dresiranje] ; lični treneri (usluge ličnih trenera) [fitnes] ; lutrija (organizovanje lutrije) ; ljetovanje (usluge kampova za ljetovanje) [razonoda] ; magnetoskopi (iznajmljivanje magnetoskopa) ; mikrofilmovi (snimanje na mikrofilmove) ; mikroizdavaštvo ; mjerenje vremena na sportskim takmičenjima ; modne revije za zabavne svrhe (organizovanje) ; montaža radio i televizijskih programa ; muzejske usluge [predstavljanje, izložbe] ; muzičke sale ; noćni klubovi ; objavljivanje knjiga i časopisa, elektronski on line ; objavljivanje tekstova [osim u reklamne svrhe] ; obrazovanje (informacije o obrazovanju) ; obrazovanje [obuka] ; obrazovni zavodi [internati] ; obuka ; obuka [predavanje] ; obuka putem dopisivanja ; obuka za predškolski uzrast ; organizovanje i vođenje koncerata ; organizovanje i vođenje konferencija ; organizovanje i vođenje kongresa ; organizovanje i vođenje radionica za stručno osposobljavanje ; organizovanje i vođenje razgovora ; organizovanje i vođenje seminara ; organizovanje izložba u kulturne i obrazovne svrhe ; organizovanje javnih konkursa [obrazovanje ili razonoda] ; organizovanje konkursa ljepote ; organizovanje plesova ; organizovanje spektakla [usluge impresarija] ; organizovanje sportskih takmičenja ; orkestri (usluge orkestra) ; pedagoški eksperimenti ; pisanje tekstova [ne u reklamne svrhe] ; planiranje prijema [razonoda] ; posuđivanje knjiga ; pozorišne predstave ; pozorišni dekor (iznajmljivanje pozorišnog dekora) ; pozorišni glumci (usluge pozorišnih glumaca) ; pozorišni preduzetnici [impresariji] (usluge pozorišnih preduzetnika) ; praktična obuka [demonstriranje] ; predškolska obuka ; prekvalifikacija (usluge prekvalifikacije) ; prelamanje slogova [ne u reklamne svrhe] ; prevodilačke usluge ; prevodioci (usluge prevođenja) ; prijemi (planiranje prijema) [razonoda] ; priredbe (iznajmljivanje dekora za priredbe) ; priredbe (održavanje priredbi) ; priredbe (organizovanje priredbi) [usluge impresarija] ; priredbe (proizvodnja priredbi) ; profesionalna orijentacija [savjeti u vezi obrazovanja ili osposobljavanja] ; proizvodnja filmova ; proizvodnja filmova na video-trakama ; proizvodnja muzike ; putujuće biblioteke (usluge putujućih biblioteka) ; radio televizijski programi (montaža radio televizijskih programa) ; radioaparati i televizori (iznajmljivanje radioaparata i televizora) ; radiofonija (razonoda putem radiofonije) ; razgovori (organizovanje i vođenje razgovora) ; razonoda ; razonoda (informacije u vezi razonode) ; razonoda posredstvom radija ; razonoda posredstvom televizije ; rekreacija (obavještenja u vezi rekreacije) ; religiozno obrazovanje ; reportaže (fotografske reportaže) ; reporterske usluge ; rezervisanje mjesta za priredbe ; ronjenje (iznajmljivanje ronilačke opreme) ; scenarijumi (izrada scenarijuma) ; seminari (organizovanje i vođenje seminara) ; simpozijumi (organizacija i vođenje simpozijuma) ; simpozijumi (organizovanje i vođenje simpozijuma) ; sinhronizacija ; slobodno vrijeme (usluge za ispunjavanje slobodnog vremena) ; snimanje na videotrake ; sportska oprema (stavljanje na raspolaganje sportske opreme) ; sportska takmičenja (mjerenje vremena na sportskim takmičenjima) ; sportska takmičenja (organizovanje sportskih takmičenja) ; sportska usavršavanja (sportski kampovi za usavršavanje u sportu) ; sportske oprema (iznajmljivanje sportske opreme osim

vozila) ; stadioni (iznajmljivanje stadiona) ; studio za snimanje (usluge studija za snimanje) ; tekstovi (objavljivanje tekstova) [osim u reklamne svrhe] ; tekstovi (sastavljanje tekstova) [ne u reklamne svrhe] ; televizija (razonoda na televiziji) ; televizijski programi (montaža radio i televizijskih programa) ; televizori (iznajmljivanje televizora i radioaparata) ; titlovanje filmova ; treniranje [fizička vježba] ; tumačenje govora pokreta ; ulaznice za priredbe (agencije za ulaznice za priredbe) [razonoda] ; videotrake (iznajmljivanje videotraka) ; videotrake (montaža videotraka) ; videotrake (proizvodnja filmova na videotrakama) ; videotrake (snimanje na videotrake) ; zabavni parkovi [cirkusi] ; zdravstveni klubovi (usluge zdravstvenih klubova) [održavanje zdravlja i fizičke forme] ; zoološki vrtovi [usluge zooloških vrtova] ; zvučni snimci (iznajmljivanje zvučnih snimaka) ; životinje (kroćenje životinja) [dresiranje].

Klasa 42: Ambalaža (usluge dizajniranja ambalaže) ; analiza kompjuterskih sastava ; analiza rukopisa ; analiza u svrhu iskorištavanja naftnih izvora ; analiza vode ; analize (hemijske analize) ; arhitektura ; autorska prava (regulisanje autorskih prava) ; bakteriološka istraživanja ; baze podataka (obnavljanje baza podataka) ; biološka istraživanja ; daljinski nadzor kompjuterskih sistema ; digitalizacija dokumenata [skeniranje] ; dizajneri (usluga modnih dizajnera) ; dizajniranje ambalaže (usluge dizajniranja ambalaže) ; dizajniranje grafičke umjetnosti (usluge dizajniranja grafičke umjetnosti) ; dupliciranje informatičkih programa ; emisija ugljenika (pružanje naučnih informacija i savjeta u vezi smanjenja emisije ugljenika) ; fizika (istraživanja u fizici) ; geološka istraživanja ; geološka izviđanja terena ; geološka vještačenja [ekspertize] ; gradnja (savjeti o gradnji) ; grafička umjetnost (usluge dizajniranja grafičke umjetnosti) ; hemija (istraživanja u hemiji) ; hemijske analize ; hemijske usluge ; industrijski dizajn ; industrijsko oblikovanje ; informatičke stranice (ugošćavanje informatičkih stranica) ; informatički programi (dupliciranje informatičkih programa) ; informatički programi (iznajmljivanje informatičkih programa) ; informatički sistemi (osmišljavanje informatičkih sistema) ; informatički virusi (zaštita od informatičkih virusa) ; instaliranje kompjuterskih programa ; internet (pružanje alata za pretraživanje na internetu) ; inženjering ; ispitivanje materijala ; istraživanja (bakteriološka istraživanja) ; istraživanja morskih dubina ; istraživanja u kozmetici ; istraživanja u mehanici ; istraživanja u oblasti geologije ; istraživanja u tehnici ; istraživanja u vezi zaštite okoline ; istraživanje i razvoj novih proizvoda [za treće lice] ; istraživanje u hemiji ; izgradnja (izrada građevinskih planova) ; iznajmljivanje informatičkih programa ; iznajmljivanje informatičkih programa ; iznajmljivanje kompjutera ; iznajmljivanje veb servera ; izrada [koncipiranje] kompjuterskih programa ; izviđanja (geološka izviđanja) ; izvornost vještačkih djela (utvrđivanje izvornosti vještačkih djela) ; kalibracija [mjerjenje] ; kiša (stvaranje vještačke kiše) ; kompjuteri (iznajmljivanje kompjutera) ; kompjuteri (programiranje za kompjutere) ; kompjuterski hardver (savjetovanje u vezi dizajna i razvoja kompjuterskog hardvera) ; kompjuterski programi (instaliranje kompjuterskih programa) ; kompjuterski programi (održavanje kompjuterskih programa) ; kompjuterski programi [softver] (izrada kompjuterskih programa) ; kompjuterski programi [softver] (osavremenjivanje kompjuterskih programa) ; konsultacije u vezi kompjuterskih programa [softvera] ; kontrola kvaliteta ; kontrola naftnih bušotina ; kontrola vozila (tehnička kontrola vozila i automobila) ; konverzija informatičkih podataka i programa [nije fizička konverzija] ; konverzija podataka ili dokumenata s jednog fizičkog na elektronski disk ; kozmetička djelatnost (istraživanja u kozmetičkoj djelatnosti) ; laboratorijske, naučne usluge ; licence za intelektualnu svojinu (ustupanje licenci za intelektualnu svojinu) ; materijali (istraživanje materijala) ; mehanika (istraživanja u mehanici) ; meteorološki izvještaji (usluge davanja meteoroloških izvještaja) ; mjerenje zemljišta ; modni dizajneri (usluge modnih dizajnera) ; nafta (traženje nafte) ; naftne bušotine (kontrola naftnih bušotina) ; naftni izvori (analiza u svrhu iskorištavanja naftnih izvora) ; naftni izvori (vještačenja naftnih izvora) [ekspertize] ; oblaci (sijanje oblaka, vještačka kiša) ; planovi (izrada građevinskih planova) ; procjena drvne mase stabala u šumi ; procjena kvalitete vune ; programiranje za kompjuteri ; razrada tehničkih projekata ; regulisanje autorskih prava ; savjeti o gradnji ; savjeti o intelektualnoj svojini ; savjeti u vezi štednje energije ; savjetovanje o kompjuterima ; savjetovanje u vezi zaštite okoline ; štednja energije (savjeti u vezi štednje energije) ; tehnička kontrola automobila ; tehnički projekti (razrada tehničkih projekata) ; tekstil (ispitivanje tekstila) ; traženje nafte ; umjetnička djela (utvrđivanje izvornosti umjetničkih djela) ; unutrašnje uređenje [dekoracija] ;

urbanističko planiranje ; vještačenja (geološka vještačenja [ekspertize]) ; vještačenja [ekspertize] naftnih izvora ; vještačenja [inženjerske usluge] ; vuna (procjena kvalitete vune) ; web serveri (iznajmljivanje web servera) ; web stranice (kreiranje i održavanje web stranica za druge) ; zaštita od informatičkih virusa ; zaštita okoline (istraživanja u vezi zaštite okoline) ; zaštita okoline (savjetovanje u vezi zaštite okoline) ; zemljište (mjerjenje zemljišta).

Klasa 43: Agencije za smještaj [hotelski, pansionski] ; aparati za kuvanje (iznajmljivanje) ; barovi (usluge barova) ; hotelske rezervacije (usluge rezerviranja hotela) ; hotelske usluge ; iznajmljivanje aparata za kuvanje ; iznajmljivanje prenosivih građevinskih objekata ; iznajmljivanje prenosivih građevinskih objekata ; iznajmljivanje privremenog smještaja ; iznajmljivanje sala, dvorana za sastanke ; iznajmljivanje stolaca, stolova, stolnog rublja i staklenog posuđa ; iznajmljivanje šatora ; iznajmljivanje uređaja za pitku vodu ; jaslice [dječije ustanove] ; kafane [kafeterije] ; kafane-restorani ; kampovanje (stavljanje na raspolaganje terena za kampovanja) ; kampovi (iskorištavanje terena za kampiranje) ; kampovi za ljetovanje (usluge kampova za ljetovanje) [smještaj] ; kantine ; ljetovališta ; ljetovanje (usluge kampova za ljetovanje) ; moteli (usluge motela) ; pansion za životinje ; pansioni ; pansioni (rezerviranje pansiona) ; prenosivi građevinski objekti (iznajmljivanje prenosivih građevinskih objekata) ; privremeni smještaj (rezerviranje privremenog smještaja) ; restorani ; restorani sa samoposluživanjem ; restorani za brzo i stalno posluživanje [snek-barovi] ; rezerviranje hotela ; rezerviranje pansiona ; rezerviranje privremenog smještaja ; smještaj (agencije za izdavanje smještaja) [hoteli, pansioni] ; smještaj (iznajmljivanje privremenog smještaja) ; starije osobe (ustanove za smještaj starijih osoba) [starački domovi] ; ugostitelji (usluge keteringa) ; ustanove za smještaj starijih osoba [starački domovi] ; životinje (pansioni za životinje).

Klasa 44: Akvakultura (usluge akvakulture) ; aromoterapija (usluge aromoterapije) ; banke krvi (usluge banaka krvi) ; bašte (usluge uređivača bašta) ; bašte (uređenje bašta) ; baštovani-pejzažisti (usluge baštovana-pejzažista) ; bolničke usluge ; cvijetni aranžmani (pravljenje cvijetnih aranžmana) ; dezintoksikacija toksikomana ; drveće (obrezivanje drveća) ; drveće (sadnja drveća radi smanjenja emisije ugljenika) ; estetska hirurgija ; farmaceuti (usluge farmaceuta) [pripremanje lijekova prema receptu] ; farmacija (savjetovanje o farmaciji) ; fizioterapija ; frizerski saloni ; gnojivo i ostali hemijski proizvodi namijenjeni za poljoprivredu (vazdušno ili drugačije razbacivanje [posipanje] gnojiva i ostalih hemijskih proizvoda za poljoprivredu) ; hirurgija (estetska hirurgija) ; iznajmljivanje medicinske opreme ; iznajmljivanje opreme za poljoprivredu ; iznajmljivanje sanitarnih uređaja ; javna kupališta za higijenske potrebe ; kiropraktika ; klinike ; korov (uništavanje korova) ; kosa (presađivanje kose) ; kupke (turske kupke) ; ljepota (usluge salona za uljepšavanje) ; manikirske usluge ; masaža ; medicinska pomoć ; medicinske klinike (usluge medicinskih klinika) ; njega životinja [timarenje] ; njegovatelj bolesnika (usluge njegovatelja bolesnika) ; obrezivanje drveća ; održavanje travnjaka ; oplodnja "in vitro" (usluge vještačke oplodnje) ; oporavak (ustanove za oporavak) ; optičarske usluge ; osjemenjivanje (usluge vještačkog osjemenjivanja) [inseminacije] ; pejzažna uređenja (koncepcija uređenja pejzaža) ; poljoprivredna oprema (iznajmljivanje opreme za poljoprivredna imanja) ; pomoć pri porođaju ; porođaj (pomoć pri porođaju) ; povrtlarstvo ; psiholog (usluge psihologa) ; rasadničari (usluge rasadničara) ; razbacivanje, vazdušnog ili drugog gnojiva, i ostalih hemijskih proizvoda u poljoprivredi ; saloni (frizerski saloni) ; saloni za uljepšavanje ; sanatoriji (usluge sanatorija) ; saune (usluge sauna) ; savjetovanje o farmaciji ; solarijumi (usluge solarijuma) ; štetočine (uništavanje životinjskih štetočina u poljoprivredi) ; telemedicina (usluge telemedicine) ; terapijske usluge ; tetoviranje ; timarenje životinja [pranje i njegovanje] ; toplice (usluge toplica) ; travnjaci (održavanje travnjaka) ; turske kupke ; uništavanje korova ; ustanove za oporavak ; uzgoj životinja ; veterinarske usluge ; vijenci od cvijeća (izrada vijenaca od cvijeća) ; vizažisti (usluge vizažista) ; zbrinjavanje siromašnih [ustanove za prihvatanje siromašnih] ; zdravstvene usluge ; zdravstveni centri ; zubarstvo ; životinje (pranje i njegovanje životinja) ; životinje (timarenje životinja) [pranje i njegovanje] ; životinje (uzgoj životinja).

Klasa 45: Agencije (bračne agencije) ; agencije (detektivske agencije) ; agencije za noćno čuvanje ; agencije za usvajanje ; arbitraža (usluge arbitraže) ; autorska prava (vođenje autorskih prava) ;

bračne agencije ; brave (otvaranje brava) ; čuvanje djece kod kuće ; čuvanje kućnih ljubimaca kod kuće ; čuvanje stanova (usluge čuvanja stanova u odsustvu vlasnika) ; detektivske agencije ; djeca (čuvanje djece kod kuće) ; dojava požara (iznajmljivanje uređaja za dojavu požara) ; društvo (pratnja radi društva) [praticij] ; gašenje vatre (usluge gašenja vatre) ; genealoška istraživanja ; građanska zaštita ; horoskopi (izrada horoskopa) ; imena domena (registrowanje imena domena) [pravne usluge] ; intelektualna svojina (usluge kontrole u vezi sa intelektualnom svojinom) ; intelektualna svojina (usluge, savjeti o intelektualnoj svojini) ; istraživanja (pravna istraživanja) ; iznajmljivanje odjeće ; iznajmljivanje sefova ; iznajmljivanje svečane odjeće ; iznajmljivanje uređaja za gašenje požara ; klubovi za susrete ; kontrola [nadzor] fabrika u vezi sigurnosti ; kontrola prtljaga radi sigurnosti ; kontrola u vezi intelektualnog vlasništva ; kremiranje (spaljivanje) ; kućni ljubimci (čuvanje kućnih ljubimaca kod kuće) ; licence za intelektualnu svojinu (ustupanje licenci za intelektualnu svojinu) ; licence za softvere (ustupanje licenci za softvere) [pravne usluge] ; nestale osobe (traženje nestalih osoba) ; noćno čuvanje (agencije za noćno čuvanje) ; odjeća (iznajmljivanje odjeće) ; organizovanje religioznih sastanaka ; parnice [nagodbene] kancelarije (usluge nagodbenih kancelarija) ; pogrebne usluge ; pratnja [usluge tjelohranitelja] ; pratnja za društvo (usluge pratnje u društvu) ; pravna istraživanja ; preci (istraživanje predaka) ; pronađene stvari (usluge kancelarije za pronađene stvari) ; protivprovalni uređaji (nadziranje protivprovalnih uređaja) ; prtljag (kontrola prtljaga radi sigurnosti) ; registrowanje imena domena ; religiozni sastanci (organizovanje religioznih sastanaka) ; savjeti u vezi intelektualne svojine ; savjetovanje o sigurnosti ; sefovi (iznajmljivanje sefova) ; sigurnost (savjetovanje o sigurnosti) ; sporovi (usluge alternativnog rješavanja sporova) ; stanovi (usluge čuvanja stanova u odsutnosti vlasnika) ; sudske istrage ; svečana odjeća (iznajmljivanje svečane odjeće) ; traženje nestalih osoba ; ukop mrtvacu ; ustupanje licenci za softvere [pravne usluge] ; usvajanje (agencije za usvajanje) ; vjenčanja (planiranje i organizovanje vjenčanja) ; zaštita građana; posredovanja [nisu pravna].

(210) **Ž-2019-242**

(220) 27.06.2019.

(731) Adriatic Marinas d.o.o. Tivat, Obala bb, 85320, Tivat, ME

(540)

Strada Navale

(550) I

(511) Klasa 36: (Osiguranje i finansije) osiguranje; finansijski poslovi; novčani (monetarni) poslovi; upravljanje nekretninama.

Klasa 39: (Prevoz i skladištenje) transportne usluge; pakovanje i skladištenje proizvoda; organizovanje putovanja.

Klasa 41: (Obuka i razonoda) obuka; stručno osposobljavanje; razonoda; sportske i kulturne djelatnosti.

Klasa 43: (Hoteli i restorani) usluge obezbjeđivanja hrane i pića; privremeni smještaj.

Klasa 44: (Medicinske usluge, ljepota i poljoprivreda) medicinske usluge; veterinarske usluge; higijenska njega i njega ljepote za ljude ili za životinje; usluge poljoprivrede, povrtlarstva i šumarstva.

(210) **Ž-2019-249**

(220) 27.06.2019.

(731) Adriatic Marinas d.o.o. Tivat, Obala bb, 85320, Tivat, ME

(540)

Ambulanta Club

(550) I

(511) Klasa 36: (Osiguranje i finansije) osiguranje; finansijski poslovi; novčani (monetarni) poslovi; upravljanje nekretninama.

Klasa 39: (Prevoz i skladištenje) transportne usluge; pakovanje i skladištenje proizvoda; organizovanje putovanja.

Klasa 41: (Obuka i razonoda) obuka; stručno osposobljavanje; razonoda; sportske i kulturne djelatnosti.

Klasa 43: (Hoteli i restorani) usluge obezbjeđivanja hrane i pića; privremeni smještaj.

Klasa 44: (Medicinske usluge, ljepota i poljoprivreda) medicinske usluge; veterinarske usluge; higijenska njega i njega ljepote za ljude ili za životinje; usluge poljoprivrede, povrtlarstva i šumarstva.

(210) **Ž-2019-250**

(220) 27.06.2019.

(731) Adriatic Marinas d.o.o. Tivat, Obala bb, 85320, Tivat, ME

(540)

Arsenal Gate

(550) I

(511) Klasa 36: (Osiguranje i finansije) osiguranje; finansijski poslovi; novčani (monetarni) poslovi; upravljanje nekretninama.

Klasa 39: (Prevoz i skladištenje) transportne usluge; pakovanje i skladištenje proizvoda; organizovanje putovanja.

Klasa 41: (Obuka i razonoda) obuka; stručno osposobljavanje; razonoda; sportske i kulturne djelatnosti.

Klasa 43: (Hoteli i restorani) usluge obezbjeđivanja hrane i pića; privremeni smještaj.

Klasa 44: (Medicinske usluge, ljepota i poljoprivreda) medicinske usluge; veterinarske usluge; higijenska njega i njega ljepote za ljude ili za životinje; usluge poljoprivrede, povrtlarstva i šumarstva.

(210) **Ž-2019-251**

(220) 27.06.2019.

(731) Adriatic Marinas d.o.o. Tivat, Obala bb, 85320, Tivat, ME

(540)

Park Gardens

(550) I

(511) Klasa 36: (Osiguranje i finansije) osiguranje; finansijski poslovi; novčani (monetarni) poslovi; upravljanje nekretninama.

Klasa 39: (Prevoz i skladištenje) transportne usluge; pakovanje i skladištenje proizvoda; organizovanje putovanja.

Klasa 41: (Obuka i razonoda) obuka; stručno osposobljavanje; razonoda; sportske i kulturne djelatnosti.

Klasa 43: (Hoteli i restorani) usluge obezbjeđivanja hrane i pića; privremeni smještaj.

Klasa 44: (Medicinske usluge, ljepota i poljoprivreda) medicinske usluge; veterinarske usluge; higijenska njega i njega ljepote za ljude ili za životinje; usluge poljoprivrede, povrtlarstva i šumarstva.

(210) **Ž-2019-252**

(220) 27.06.2019.

(731) Adriatic Marinas d.o.o. Tivat, Obala bb, 85320, Tivat, ME

(540)

Park Gate Gardens

(550) I

(511) Klasa 36: (Osiguranje i finansije) osiguranje; finansijski poslovi; novčani (monetarni) poslovi; upravljanje nekretninama.

Klasa 39: (Prevoz i skladištenje) transportne usluge; pakovanje i skladištenje proizvoda; organizovanje putovanja.

Klasa 41: (Obuka i razonoda) obuka; stručno osposobljavanje; razonoda; sportske i kulturne djelatnosti.

Klasa 43: (Hoteli i restorani) usluge obezbjeđivanja hrane i pića; privremeni smještaj.

Klasa 44: (Medicinske usluge, ljepota i poljoprivreda) medicinske usluge; veterinarske usluge; higijenska njega i njega ljepote za ljude ili za životinje; usluge poljoprivrede, povrtlarstva i šumarstva.

(210) **Ž-2019-253**

(220) 27.06.2019.

(731) Adriatic Marinas d.o.o. Tivat, Obala bb, 85320, Tivat, ME

(540)

Arsenal Place

(550) I

(511) Klasa 36: (Osiguranje i finansije) osiguranje; finansijski poslovi; novčani (monetarni) poslovi; upravljanje nekretninama.

Klasa 39: (Prevoz i skladištenje) transportne usluge; pakovanje i skladištenje proizvoda; organizovanje putovanja.

Klasa 41: (Obuka i razonoda) obuka; stručno osposobljavanje; razonoda; sportske i kulturne djelatnosti.

Klasa 43: (Hoteli i restorani) usluge obezbjeđivanja hrane i pića; privremeni smještaj.

Klasa 44: (Medicinske usluge, ljepota i poljoprivreda) medicinske usluge; veterinarske usluge; higijenska njega i njega ljepote za ljude ili za životinje; usluge poljoprivrede, povrtlarstva i šumarstva.

(210) **Ž-2019-268**

(220) 09.07.2019.

(731) DRUŠTVO SA OGRANIČENOM ODGOVORNOŠĆU "INTER SPIRITS" D.O.O.
PODGORICA, DONJI KRAJ BB, CETINJE, ME

(540)



(550) I

(511) Klasa 32: Bezalkoholna pića.
Klasa 33: Alkoholna pića (osim piva).
Klasa 43: Usluge obezbjeđivanja hrane i pića.

(210) **Ž-2019-317**

(220) 27.08.2019.

(731) NOBEL ILAC SANAYII VE TICARET ANONIM SIRKETI, Saray Mah., Dr. Adnan Buyukdeniz Cad., No:14, Umraniye, 34768, Istanbul, TR

(540)

Zeno

(550) I

(740) ADVOKATSKA KANCELARIJA VMB-ADVOKAT VESKO M.BOZOVIĆ, Moskovska 99/11, Podgorica

(511) Klasa 5: Farmaceutski proizvodi.

(210) **Ž-2019-318**

(220) 27.08.2019.

(731) NOBEL ILAC SANAYII VE TICARET ANONIM SIRKETI, Saray Mah., Dr. Adnan Buyukdeniz Cad., No:14, Umraniye, 34768, Istanbul, TR

(540)

Maprofen

(550) I

(740) ADVOKATSKA KANCELARIJA VMB-ADVOKAT VESKO M.BOZOVIĆ, Moskovska 99/11, Podgorica

(511) Klasa 5: Farmaceutski proizvodi.

(210) **Ž-2020-103**

(220) 11.03.2020.

(731) "AGROCENTAR" D.O.O. Podgorica, Ulica Vojislavljevića br.39, 81000, Podgorica, ME

(540)



(550) I

(740) Radosav S. Mandić, Bulevar Svetog Petra Cetinjskog 112, stan 4, 81000, Podgorica

(511) Klasa 1:

(210) **Ž-2020-176**

(220) 29.05.2020.

(731) Colgate-Palmolive Company (a Delaware Corporation), 300 Park Avenue, 10022, New York, New York, US
(540)

RECY CLEAN

(550) I

(740) Jasna Jusić, Dalmatinska 2, 81000, Podgorica
(511) Klasa 21: Četkice za zube.

(210) **Ž-2020-186**

(220) 01.04.2020.

(731) Jetex FZE , Dubai Airport Free Zone 6EA - Office No. 807, Dubai, AE

(540)

The logo for JETEX, featuring the word "JETEX" in a bold, orange, sans-serif font.

(550) I

(740) Dejan Ćosović, 13. jula br. 1/5, 85310, Budva

(511) Klasa 35: Usluge oglašavanja; poslovnog upravljanja; poslovne administracije; usluge kancelarijskog poslovanja

Klasa 36: Usluge osiguranja; finansijskog poslovanja; monetarnih poslova; usluge poslova u vezi sa nekretninama.

Klasa 37: Usluge izgradnje zgrada; popravke; instalacijske usluge.

Klasa 39: Usluge prevoza; pakovanja i skladištenja robe; putni aranžmani.

Klasa 43: Usluge obezbjedjenja hrane i pića; privremenog smještaja.

Klasa 45: Pravne usluge; usluge obezbjedjenja lica i imovine; lične i društvene usluge koje se obavljaju da bi se obezbijedile individualne potrebe.

(210) **Ž-2020-187**

(220) 10.06.2020.

(731) MILBOURG d.o.o. Beograd-Novi Beograd, Bulevar Zorana Đinđića 64a, III sprat, 11070, Beograd-Novi Beograd, RS

(540)

Tonzilette

(550) I

(740) Miladin Popović, Đoka Miraševića 21/III, 81000, Podgorica

(511) Klasa 5: Farmaceutski i medicinski preparati; dijetetska hrana i supstance prilagođene za upotrebu u medicini ili veterinarsku upotrebu, hrane za bebe; dijetetski dodaci (dodaci ishrani) za ljude i životinje.

(210) **Ž-2020-203**

(220) 09.06.2020.

(731) Koncern za proizvodnju i promet konditorskih proizvoda Bambi a.d. Požarevac, Đure Đakovića bb, 12000, Požarevac, RS
(540)

ICONIC

(550) I

(740) dr Ivan Todorović, Gospodar Jevremova 23/8, 11000, Beograd

(511) Klasa 29: Čips od krompira, listići od krompira, sušeno povrće, kikiriki, pripremljen, voćni čips, pahuljice od krompira, suncokretove semenke, pripremljene, semenke, pripremljene, niskokalorični čips od krompira, niskokalorični hrskavi krompir, začinjeno koštunjavo voće, začinjeni orasi, namazi na bazi orašastih plodova.

Klasa 30: Keks, biskviti, suvi kolačići, vafel proizvodi, kafa, žvakaća guma, čokolada, slatkiši, kokice, sladoled, pića od kafe sa mlekom, pića od čokolade sa mlekom, pastile [bombone], praline, sosovi [dodaci hrani], pića na bazi kafe, pića na bazi kakaoa, pića na bazi čokolade, tako, tortilje, ledeni čaj, koštunjavo voće sa čokoladnim prelivom, palačinke na bazi krompira, mentol bombone za osvežavanje daha, žvakaće gume za osvežavanje daha.

(210) **Ž-2020-216**

(220) 23.06.2020.

(731) HELLENIC FUELS AND LUBRICANTS SINGLE MEMBER INDUSTRIAL AND COMMERCIAL SOCIETE ANONYME, also trading as "EKO ABEE", 8A Cheimarras street, 15125, Marousi, GR

(540)



(550) I

(740) Jasna Jusić, Dalmatinska 2, 81000, Podgorica

(511) Klasa 4: Višenamjenska maziva; gorivo za avione; biodizel; biodizel gorivo; biogoriva; karburanti; zapaljiva aglomerirana goriva; zapaljivi materijali; zapaljivi proizvodi; zapaljive materije za upotrebu u aparatima za grijanje; pojačivači sagorijevanja (proizvodi od petroleja); proizvodi od sirove nafte dobijeni preradom sirovina; sirova nafta; dizel gorivo; dizel ulje; ulje za motore; ekstra fina ulja za motore; fosilna goriva; gorivo; aditivi za gorivo koji sprečavaju taloženje pepela u aparatima za sagorevanje fosilnih goriva; gorivo za vazduhoplove; gorivo za brodove; goriva koja se koriste za roštilj; gorivo dobijene od sirove nafte; mješavine goriva; mješavine goriva dobijene procesom isparenja; lož ulje; goriva i iluminanti; goriva dobijena preradom sirove nafte; goriva dobijena preradom ulja; goriva koja se koriste za roštilj; goriva iz bioloških izvora; tečna goriva; goriva (uključujući benzin); plinsko ulje; plinsko ulje za grijanje u domaćinstvima; plinsko ulje za grijanje u industriji; ulje za grijanje; visokootanski benzin; ugljovodonične smjese; goriva na bazi ugljovodonika; industrijska ulja i masti; maziva; industrijski parafini; laka lož ulja; tečna goriva;

ulja koja se koriste u pomorstvu; mineralna goriva; mineralna motorna goriva; nehemijska motorna goriva kao aditivi; motorna ulja; motorni benzini; petrolej; naftni derivati; sirovi ili rafinisani petrolej.

(210) **Ž-2020-217**

(220) 23.06.2020.

(731) HELLENIC FUELS AND LUBRICANTS SINGLE MEMBER INDUSTRIAL AND COMMERCIAL SOCIETE ANONYME, also trading as "EKO ABEE", 8A Cheimarras street, 15125, Marousi, GR

(540)



(550) I

(740) Jasna Jusić, Dalmatinska 2, 81000, Podgorica

(511) Klasa 4: Višenamjenska maziva; gorivo za avione; biodizel; biodizel gorivo; biogoriva; karburanti; zapaljiva aglomerirana goriva; zapaljivi materijali; zapaljivi proizvodi; zapaljive materije za upotrebu u aparatima za grijanje; pojačivači sagorijevanja (proizvodi od petroleja); proizvodi od sirove nafte dobijeni preradom sirovina; sirova nafta; dizel gorivo; dizel ulje; ulje za motore; ekstra fina ulja za motore; fosilna goriva; gorivo; aditivi za gorivo koji sprečavaju taloženje pepela u aparatima za sagorevanje fosilnih goriva; gorivo za vazduhoplove; gorivo za brodove; goriva koja se koriste za roštilj; gorivo dobijene od sirove nafte; mješavine goriva; mješavine goriva dobijene procesom isparenja; lož ulje; goriva i iluminanti; goriva dobijena preradom sirove nafte; goriva dobijena preradom ulja; goriva koja se koriste za roštilj; goriva iz bioloških izvora; tečna goriva; goriva (uključujući benzin); plinsko ulje; plinsko ulje za grijanje u domaćinstvima; plinsko ulje za grijanje u industriji; ulje za grijanje; visokooktanski benzin; ugljovodonične smjese; goriva na bazi ugljovodonika; industrijska ulja i masti; maziva; industrijski parafini; laka lož ulja; tečna goriva; ulja koja se koriste u pomorstvu; mineralna goriva; mineralna motorna goriva; nehemijska motorna goriva kao aditivi; motorna ulja; motorni benzini; petrolej; naftni derivati; sirovi ili rafinisani petrolej.

(210) **Ž-2020-218**

(220) 23.06.2020.

(731) HELLENIC FUELS AND LUBRICANTS SINGLE MEMBER INDUSTRIAL AND COMMERCIAL SOCIETE ANONYME, also trading as "EKO ABEE", 8A Cheimarras street, 15125, Marousi, GR

(540)



(550) I

(740) Jasna Jusić, Dalmatinska 2, 81000, Podgorica

(511) Klasa 4: Višenamjenska maziva; gorivo za avione; biodizel; biodizel gorivo; biogoriva; karburanti; zapaljiva aglomerirana goriva; zapaljivi materijali; zapaljivi proizvodi; zapaljive materije za upotrebu u aparatima za grijanje; pojačivači sagorijevanja (proizvodi od petroleja); proizvodi od sirove nafte dobijeni preradom sirovina; sirova nafta; dizel gorivo; dizel ulje; ulje za motore; ekstra fina ulja za motore; fosilna goriva; gorivo; aditivi za gorivo koji sprečavaju taloženje pepela u aparatima za sagorevanje fosilnih goriva; gorivo za vazduhoplove; gorivo za brodove; goriva koja se koriste za roštilj; gorivo dobijene od sirove nafte; mješavine goriva; mješavine goriva dobijene procesom isparenja; lož ulje; goriva i iluminanti; goriva dobijena preradom sirove nafte; goriva dobijena preradom ulja; goriva koja se koriste za roštilj; goriva iz bioloških izvora; tečna goriva; goriva (uključujući benzin); plinsko ulje; plinsko ulje za grijanje u domaćinstvima; plinsko ulje za grijanje u industriji; ulje za grijanje; visokooktanski benzin; ugljovodonične smjese; goriva na bazi ugljovodonika; industrijska ulja i masti; maziva; industrijski parafini; laka lož ulja; tečna goriva; ulja koja se koriste u pomorstvu; mineralna goriva; mineralna motorna goriva; nehemijska motorna goriva kao aditivi; motorna ulja; motorni benzini; petrolej; naftni derivati; sirovi ili rafinirani petrolej.

(210) **Ž-2020-232**

(220) 02.07.2020.

(731) TAVUKCUOGLU BERK, STARI GRAD 440, KOTOR, ME

(540)

H  US

(550) I

(511) Klasa 37: Izgradnja; popravke; usluge postavljanja (instaliranja).

(210) **Ž-2020-265**

(220) 28.07.2020.

(300) ZA 2020/04770 i 2020/04771 26/02/2020

(731) Intercontinental Great Brands LLC, 100 Deforest Avenue, 07936, East Hanover, New Jersey, US

(540)



(550) I

(740) Miladin Popović, Đoka Miraševića 21/III, 81000, Podgorica

(511) Klasa 5: Medicinske poslastice.

Klasa 30: Nemedicinske poslastice, čokolada, poslastice od čokolade, poslastice od šećera, smrznute poslastice, sladoled, led, smrznuti deserti, deserti, rashlađeni deserti, kolači, biskviti, pekarski proizvodi, čizkejk, krofne, vafle, bonbone, slatkiši, gume za žvakanje; kolačići; kolači od čokolade; oblande; namazi od čokolade; smrznuti jogurt; rashlađeni deserti; proizvodi od tijesta; preparati od žitarica; žitarice za doručak; kokice; šerbeti; med; pudinzi; proizvodi za užinu u obliku

kokica i listića od kukuruza; proizvodi za užinu od kukuruza, pirinča, ječma, raži ili poslastica.

(210) **Ž-2020-266**

(220) 30.07.2020.

(731) Milan Golović, Radoja Dakića 5/17 stan 24, Podgorica, ME

(540)

#MünchenFamilija

(550) I

(740) Dragan S. Nikolić, Veliše Mugoše I/9, Podgorica

(511) Klasa 16: Ambalaža (kartonska ili papirnata za boce) boce (kartonska ili papirna ambalaža za boce) boce (kartonski ili papirni omoti za boce) boce (papirni podmetači za boce); brošure; časopisi [periodični]; časopisi (revije) čestitke fascikle [kancelarijski pribor] fascikle [papirni proizvodi] fascikle za papir fotografije [štampane] kalendari kalendari [godišnjaci] kalendari kojima se listovi trgaju katalogi knjige (oznake za stranice u knjigama) knjige sa pjesmama letci, flajeri; naljepnice, štamparski blokovi; novine; novine sa stripovima; olovke; omotači za boce, papirnati ili kartonski; pakovanje hrane (folije od papira ili plastike za održavanje vlage, za pakovanje hrane); pivske čaše (podmetači za pivske čaše); plakati (papirnate ili kartonske podloge za plakate); plakati [poster]; plakati, papirni ili kartonski; salvete od papira za stolove; slikarska platna; slikarske četkice; slikarski stalci; slike; stripovi (novine sa stripovima); sveske za pisanje i crtanje; vrećice [omotnice, džepovi], od papira ili plastike za ambalažu.

Klasa 41: Dekor za priredbe (iznajmljivanje dekora za priredbe); digitalne slike (usluge digitalnog snimanja); disk džokeji (usluge disk džokeja) usluge; diskoteke (usluge diskoteka); elektronske publikacije (iskorištavanje elektronskih publikacija koje se ne mogu prenositi on-line); filmovi (prikazivanje igranih filmova); filmovi (proizvodnja filmova); fotografisanje; fotografske reportaže; igre za novac; informacije o obrazovanju; informacije o razonodi; informacije u vezi rekreacije; izdavanje knjiga; izložbe (organizovanje izložbi) u kulturne ili obrazovne svrhe; iznajmljivanje audio uređaja; iznajmljivanje dekora za priredbe; iznajmljivanje igrački; iznajmljivanje kinematografskih filmova; iznajmljivanje videokamera; iznajmljivanje videotraka; iznajmljivanje zvučnih snimaka; klubovi (usluge klubova [zabava ili obrazovanje]; knjige (izdavanje knjiga); knjige (posuđivanje knjiga); komponovanje muzike; komponovanje muzike (usluge komponovanja muzike); koncerti (organizovanje i vođenje koncerata); konferencije (organizovanje i vođenje konferencija); kongresi (organizovanje i vođenje kongresa); modne revije za zabavne svrhe (organizovanje); montaža radio i televizijskih programa; muzejske usluge [predstavljanje, izložbe]; muzičke sale; noćni klubovi; objavljivanje knjiga i časopisa, elektronski on line- objavljivanje tekstova [osim u reklamne svrhe]; obrazovanje (informacije o obrazovanju); obrazovanje [obuka]; obuka; obuka [predavanje]; obuka putem dopisiva nja; organizovanje i vođenje koncerata; organizovanje i vođenje konferencija; organizovanje i vođenje kongresa; organizovanje i vođenje radionica za stručno osposobljavanje; organizovanje i vođenje razgovora; organizovanje i vođenje seminara; organizovanje izložba u kulturne i obrazovne svrhe; organizovanje javnih konkursa [obrazovanje ili razonoda]; organizovanje konkursa ljepote; organizovanje plesova; organizovanje spektakla [usluge impresarija]; organizovanje sportskih takmičenja; orkestri (usluge orkestra); pisanje tekstova [ne u reklamne svrhe]; planiranje prijema (razonoda); posuđivanje knjiga; pozorišne predstave; pozorišni dekor (iznajmljivanje pozorišnog dekora); pozorišni glumci (usluge pozorišnih glumaca); pozorišni preduzetnici [impresariji] (usluge pozorišnih preduzetnika); prijemi (planiranje prijema) (razonoda);

priredbe (iznajmljivanje dekora za priredbe); priredbe (održavanje priredbi); priredbe (organizovanje priredbi) [usuge impresarija]; priredbe (proizvodnja priredbi); proizvodnja filmova; proizvodnja filmova na videotrakama; proizvodnja muzike; putujuće biblioteke (usuge putujućih biblioteka); radio televizijski programi (montaža radio televizijskih programa); radioaparati i televizori (iznajmljivanje radioaparata i televizora); razgovori (organizovanje i vođenje razgovora); razonoda; razonoda (informacije u vezi razonode); razonoda posredstvom radija; razonoda posredstvom televizije; rekreacija (obavještenja u vezi rekreacije); reportaže (fotografske reportaže); reporterske usluge; rezervisanje mjesta za priredbe; scenarijumi (izrada scenarijuma); seminari (organizovanje i vođenje seminara); simpozijumi (organizacija i vođenje simpozijuma); simpozijumi (organizovanje i vođenje simpozijuma); slobodno vrijeme (usuge za ispunjavanje slobodnog vremena); snimanje na videotrake; sportska takmičenja (organizovanje sportskih takmičenja); sportska usavršavanja (sportski kampovi za usavršavanje u sportu); sportske oprema (iznajmljivanje sportske opreme osim vozila); studio za snimanje (usuge studija za snimanje); tekstovi (objavljivanje tekstova) [osim u reklamne svrhe]; tekstovi (sastavljanje tekstova) [ne u reklamne svrhe]; televizija (razonoda na televiziji); televizijski programi (montaža radio i televizijskih programa); televizori (iznajmljivanje televizora i radioaparata); titlovanje filmova; ulaznice za priredbe (agencije za ulaznice za priredbe) [razonoda]; videotrake (iznajmljivanje videotraka); videotrake (montaža videotraka); videotrake (proizvodnja filmova na videotrakama); videotrake (snimanje na videotrake); zabavni parkovi [cirkusi], zdravstveni klubovi (usuge zdravstvenih klubova) [održavanje zdravlja i fizičke forme]; zvučni snimci (iznajmljivanje zvučnih snimaka).

Klasa 43: Agencije za smještaj [hotelski, pansioniski]; barovi (usuge barova); hotelske rezervacije (usuge rezervisanja hotela); hotelske usluge; iznajmljivanje aparata za kuvanje; iznajmljivanje privremenog smještaja; iznajmljivanje sala, dvorana za sastanke; iznajmljivanje stolaca, stolova, stolnog rublja i staklenog posuđa; kafane [kafeterije]; kafane; restorani; kantine; ljetovališta; ljetovanje (usuge kampova za ljetovanje); moteli (usuge motela); pansion za životinje; pansioni; pansioni (rezervisanje pansiona); privremeni smještaj (rezervisanje privremenog smještaja); restorani; restorani sa samoposluživanjem; restorani za brzo i stalno posluživanje [snek-barovi]; rezervisanje hotela; rezervisanje pansiona; rezervisanje privremenog smještaja; smještaj (agencije za izdavanje smještaja) [hoteli, pansioni]; smještaj (iznajmljivanje privremenog smještaja); ugostitelji (usuge kateringa).

(210) **Ž-2020-271**

(220) 31.07.2020.

(300) GB 00003497528 05/06/2020

(731) The Coca-Cola Company, One Coca-Cola Plaza, 30313, Atlanta, Georgia, US

(540)

TOPO CHICO

(550) I

(740) Miladin Popović, Đoka Miraševića 21/III, 81000, Podgorica

(511) Klasa 33: Alkoholna gazirana pića; alkoholna pića izuzev vina.

(210) **Ž-2020-278**

(220) 06.08.2020.

(300) CL 1361050 25/06/2020

(731) The Coca-Cola Company, One Coca-Cola Plaza, 30313, Atlanta, Georgia, US

(540)

The logo for 'TopoChico' features the brand name in a stylized, rounded font. 'Topo' is in a dark blue color, and 'Chico' is in a lighter blue color. The letters are thick and have a slight shadow effect.

(550) I

(740) Miladin Popović, Đoka Miraševića 21/III, 81000, Podgorica

(511) Klasa 33: Alkoholna pića, osim piva; alkoholni preparati za pravljenje pića; alkoholna gazirana pića.

(210) **Ž-2020-279**

(220) 06.08.2020.

(731) Money d.o.o., Buda Tomovića F7, 81000, Podgorica, ME

(540)



(550) I

(511) Klasa 29: Meso, riba, živina i divljač; mesni ekstrakti; konzervirano, sušeno i kuvano voće i povrće; želei, džemovi, kompoti; jaja, mlijeko i mliječni proizvodi; jestiva ulja i masti *ajvar (konzervirana paprika), bademi, baštenska zelen, jabuke (kompot od jabuka), gljive konzervisane; haring, jaja, voćna kaša, kefir, kisjelo mlijeko, kokosov puter, kokosova mast, kokosovo ulje, kompot od brusnice, kompot od jabuke, konzerve od povrća, konzerve mesne, konzerve riblje, konzerve voćne, krastavci ukiseljeni, krompirici (prženi, čips), laneno ulje za upotrebu u kulinarstvu, loj za prehranu; margarin, maslinovo ulje jestivo, mast od kokosa, mesne ciste supe, meso, svinjsko meso, paradajz (pire od paradajza), paradajz (sok od paradajza), pavlaka (mliječni proizvodi), pekmez, pire od paradajza, polen pripremljen za prehranu, povrće (salate od povrća), povrće kuvano, povrće sušeno, mliječni frapei, mliječni napitci u kojima mlijeko preovladava, mliječni proizvodi, mlijeko-kakao sa mlijekom, mlijeko proteinsko mlijeko, mlijeko-surutka od mlijeka, mlijeko od soje- zamjena za mlijeko, palmino ulje prehrambena namirnica, puter, puter od kakaoa, puter od kokosa, puter od kikirikija, riba, salate od povrća, salate od voća, sezamovo ulje, sirevi, slanina, sokovi biljni za kuhinju, suncokret-ulje jestivo; suncokret sjemenke jestive, supe od mesnih koncentrata, supe od povrća, supe od zeleniša, supe ciste mesne, sushi, tofi, urme, voće konzervisano, voće kuvano, voćna kaša pulpa, voćne kriške, voćne salate, voćni kolači, zelayn, zelei za prehranu.

Klasa 30: Kafa, čaj, kakao, šećer, riža, tapioka, sago, zamjene za kafu; brašno i proizvodi od žitarica, hleb, kolači, poslastice i bomboni, sladoled; med, sirup od melase; kvasac, prašak za pecivo; so, senf; sirće, prelive; začini; razni začini; led za hlađenje; * Biskviti- suvi kolači, alge-začini, alva, anis, bademi slatkiši od badema, beskvasni hljeb, bomboni, brašno-jela od brašna, cikorija-zamjena za kafu, cimet, čaj, čajni kolutići, čokoladni musevi, dezertni musevi, dvopek prepečenac, djumbir, hljeb, hljebne mrvice, jogurt, smrznuti proizvodi- sladoled, kafa-pića od kafe, karamele-bomboni, kari začin, kašice mliječne za prehranu, kečap- umak od paradajza, keks petit beure, kikiriki- slatkiši od kikirikija, kolači- tijesto za kolače, kolači- vafli, krekeri; kukuruzne kokice, kukuruzne pahuljice, kukuruzno brašno, kus kus, laneno sjeme za ljudsku potrošnju, ledeni čaj, majonez, macaroni vrsta tjestenine, marinada, mesne pite, mesni sokovi umaci, paprika

začin, paradajz- umak od paradajza, pastille bomboni, pecivo-fino sitno pecivo, peppermint bomboni, pesto umak, pića od kafe, pića od kaka, mirodjija začin, mlijeko čokoladni napitak, musli, oraščići, pahuljice od sušenih žitarica, pahuljice kukuruzne, pahuljice zobene, palačinke, praline, prašak za kolače, prehrambena tjestenina, riža, salata- umaci u salatu, salate od voća, sendviči od sira, senf, sladila prirodno, sladoled, prašak za sladoled, slastičarski proizvodi, slatkiši, soja, soda bikarbona za kuvanje, soja- umak od soje, sojino brašno, sojino mlijeko, sushi, suvi kolačići, šećer, šećerni proizvodi, tijesto za kolače, žitarice-pahulje od sušenih žitarica.

Klasa 35: Oglašavanje i reklamiranje - poslova na malo, prodaja robe na malo; vođenje komercijalnih poslova; komercijalna administracija; kancelarijski poslovi.

Klasa 40: Obrada materijala- proizvodnja peciva, gotova jela, pice, pite, štrudle, hlebovi, jela od mesa, makarone, kolači, kolači u čaši, cijedjeni sokovi, musevi, salate, sladoledi, sjeckano voće i povrće.

Klasa 43: Pravne usluge; sigurnosne usluge za zaštitu imovine i lica; lične i društvene usluge koje pružaju drugi, namijenjene za zadovoljenje ljudskih potreba - katering.

(210) **Ž-2020-282**

(220) 11.08.2020.

(731) Bojan Petrić, Vojvode Maša Đurovića 13a, 81000, Podgorica, ME

(540)

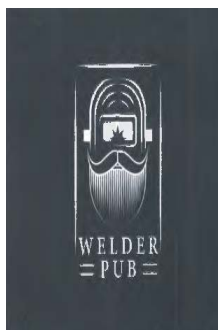

(550) I

(740) Olja Mihailović, Ulica serdara Jola Piletića 1/g, 81000, Podgorica

(511) Klasa 32: Pivo; mineralne i gazirane vode i ostala bezalkoholna pića; pića od voća i voćni sokovi; sirupi i ostali preparati za pripremanje napitaka.

Klasa 33: Alkoholna pića (osim piva).

Klasa 34: Duvan; pribor za pušače; šibice.

Klasa 43: Usluge obezbjeđivanja hrane i pića; privremeno primanje na stan.

(210) **Ž-2020-292**

(220) 17.08.2020.

(731) DANEX.ME D.O.O., TRG NIKOLE KOVAČEVIĆA BROJ 8, 81000, PODGORICA, ME

(540)



(550) I

(511) Klasa 35: Oglašavanje; vođenje poslova; poslovno upravljanje; kancelarijski poslovi; usluge koje pružaju lica ili organizacije uglavnom radi: (1) pomoći u radu ili upravljanju preduzećima, (2) pomoći u upravljanju poslovnim ili komercijalnom delatnošću u industrijskim ili komercijalnim privrednim društvima; usluge koje pružaju preduzeća koja se bave oglašavanjem (reklamiranjem), tako što, za račun drugih lica, komuniciraju sa javnošću (reklama) putem prenosa bilo kakvih informacija o svim vrstama proizvoda proizvodima i uslugama; sakupljanje u korist drugih, čitavog niza roba (uključujući i njihov transport) omogućavajući klijentima da zgodno razgledaju i kupuju ovu robu; takve usluge mogu se pružati u prodavnicama na malo, rasprodajama, porudžbinama poštom preko kataloga ili putem elektronskih medija, na primer preko web site-a ili televizijskih programa za kupovinu; usluge koje se sastoje od registracije, transkripcije, kompozicije, kompilacije ili sistematizacije pisanih saopštenja i registracija i takođe kompilacije matematičkih ili statističkih podataka; usluge reklamnih agencija i usluge kao što je deljenje prospekata direktno ili poštom ili distribucija uzoraka; reklamiranje u vezi sa drugim uslugama, kao što su one u vezi sa bankarskim zajmovima ili reklamiranje putem radija.

Klasa 36: Osiguranje; finansijski poslovi; novčani (monetarni) poslovi; poslovi vezani za nepokretnosti; sve vrste finansijskih, novčanih i osiguravajućih poslova (usluga); sve vrste finansijskih i novčanih poslova (usluga): (1) usluge koje pružaju sve vrste bankarskih institucija ili menjačke, (2) kreditne usluge svih vrsta; (3) investicione usluge holding kompanija; (4) usluge koje se odnose na berze, akcije (deonice) i svojinu; (5) davanje garancija dužnicima u monetarnim poslovima; (6) izdavanje putničkih čekova i kreditnih pisama; usluge upravljanja nepokretnostima (administriranje zgradama), tj. usluge izdavanja ili procene ili finansiranja; usluge koje se bave osiguranjem kao što su usluge koje pružaju agenti ili brokeri uključeni u osiguranje, usluge koje se pružaju osiguranim licima i usluge koje podrazumevaju osiguranje.

Klasa 37: Građevinsko konstruisanje; popravljanje; usluge instaliranja (instalacione usluge); usluge koje pružaju izvođači ili podizvođači radova pri konstruisanju i izgradnji stalnih građevina; usluge koje pružaju lica ili organizacije koje se bave restauracijom prema originalnom projektu ili konzervacijom predmeta bez menjanja njihovih fizičkih ili hemijskih osobina; usluge konstruisanja građevina, puteva, mostova, brana ili; usluge preduzimača specijalizovanih u građevinarstvu kao što su usluge molera, vodoinstalatera, instalatera grejanja, krovopokrivača; usluge inspekcije konstrukcionih planova; usluge brodogradnje, iznajmljivanje alata i građevinskog materijala; usluge popravki, tj. usluge koje se preduzimaju da se dovede objekat u dobro stanje, posle štete, oštećenja, propadanja ili delimične destrukcije (restauracija postojeće zgrade ili drugog objekta koje je postao oštećen da se dovede u svoje prvobitno stanje); različite usluge popravki kao što su one u oblasti električne struje, nameštaja, instrumenata, oruđa, itd; usluge održavanja za očuvanje objekta u njegovom prvobitnom stanju bez promene bilo kojih svojstava.

(210) **Ž-2020-307**

(220) 02.09.2020.

(731) Maginus doo, Kneza Višeslava 3, 11030, Beograd, RS
(540)

LOVAC

(550) I

(740) Ana Stanković Mugoša, Trg Nezavisnosti br.13, 81000, Podgorica

(511) Klasa 3: Bjelila za veš; deterdženti za veš; plavilo za veš; preparati za bijeljenje veša; preparati za bijeljenje i druga sredstva za pranje veša; preparati za pranje i bijeljenje veša; proizvodi za pranje veša; sapuni za veš; sapuni za pranje veša; sredstva za pranje veša; hemikalije za osvježavanje boja za upotrebu u domaćinstvu [pranje veša]; vlažne maramice impregnirane sredstvima za čišćenje; maramice za sprečavanje bojenja veša; preparati za pranje i izbjeljivanje; sapun za izbjeljivanje tekstila; preparati za uklanjanje kamenca za upotrebu u domaćinstvu; oplemenjivači rublja za upotrebu u perionicama; deterdženti za upotrebu u domaćinstvu; deterdženti, koji nisu za upotrebu u proizvodnim procesima i za medicinsku upotrebu; platnene maramice impregnirane sredstvima za čišćenje kože; preparati za čišćenje za upotrebu u domaćinstvu; preparati i supstance za čišćenje i pranje; rastvarači za čišćenje, za upotrebe koje se ne odnose na procese proizvodnje; sredstva za čišćenje za domaćinstvo; sredstva za čišćenje za primenu u domaćinstvu; sredstva za čišćenje za upotrebu u domaćinstvu; sredstva i preparati za čišćenje; hemijski preparati za čišćenje za upotrebu u domaćinstvu; preparati za bijeljenje [uklanjanje boja] za upotrebu u domaćinstvu; preparati za uklanjanje boja; sredstva za skidanje boja; preparati za uklanjanje boje; krpice natopljene preparatima za čišćenje; natopljene krpice za čišćenje.

(210) **Ž-2020-308**

(220) 02.09.2020.

(731) Maginus doo, Kneza Višeslava 3, 11030, Beograd, RS

(540)

LOVAC NA BOJE

(550) I

(740) Ana Stanković Mugoša, Trg Nezavisnosti br.13, 81000, Podgorica

(511) Klasa 3: Bjelila za veš; deterdženti za veš; plavilo za veš; preparati za bijeljenje veša; preparati za bijeljenje i druga sredstva za pranje veša; preparati za pranje i bijeljenje veša; proizvodi za pranje veša; sapuni za veš; sapuni za pranje veša; sredstva za pranje veša; hemikalije za osvježavanje boja za upotrebu u domaćinstvu [pranje veša]; vlažne maramice impregnirane sredstvima za čišćenje; maramice za sprečavanje bojenja veša; preparati za pranje i izbjeljivanje; sapun za izbjeljivanje tekstila; preparati za uklanjanje kamenca za upotrebu u domaćinstvu; oplemenjivači rublja za upotrebu u perionicama; deterdženti za upotrebu u domaćinstvu; deterdženti, koji nisu za upotrebu u proizvodnim procesima i za medicinsku upotrebu; platnene maramice impregnirane sredstvima za čišćenje kože; preparati za čišćenje za upotrebu u domaćinstvu; preparati i supstance za čišćenje i pranje; rastvarači za čišćenje, za upotrebe koje se ne odnose na procese proizvodnje; sredstva za čišćenje za domaćinstvo; sredstva za čišćenje za primenu u domaćinstvu; sredstva za čišćenje za upotrebu u domaćinstvu; sredstva i preparati za čišćenje; hemijski preparati za čišćenje za upotrebu u domaćinstvu; preparati za bijeljenje [uklanjanje boja] za upotrebu u domaćinstvu; preparati za uklanjanje boja; sredstva za skidanje boja; preparati za uklanjanje boje; krpice natopljene preparatima za čišćenje; natopljene krpice za čišćenje.

(210) **Ž-2020-309**

(220) 02.09.2020.

(731) Maginus doo, Kneza Višeslava 3, 11030, Beograd, RS

(540)

LAVA SEPT

(550) I

(740) Ana Stanković Mugoša, Trg Nezavisnosti br.13, 81000, Podgorica, ME

(511) Klasa 3: Višenamjenski preparati za čišćenje; kozmetički proizvodi i preparati za ličnu njegu; nemedicinski preparati za ličnu higijenu; nemedicinski preparati za pranje ruku; nemedicinski preparati za čišćenje kože; nemedicinski higijenski preparati kao toaletna sredstva; preparati za natapanje u perionicama; preparati za uklanjanje kamenca za upotrebu u domaćinstvu; preparati za čišćenje; preparati za čišćenje za ličnu upotrebu; preparati za čišćenje za upotrebu u domaćinstvu; preparati za čišćenje na bazi rastvarača; preparati za čišćenje podova; preparati za čišćenje, poliranje i ribanje; preparati za čišćenje, pranje i poliranje; preparati za čišćenje ruku; preparati za čišćenje tepiha; preparati za čišćenje tkanina; preparati i supstance za čišćenje i pranje; preparati i supstance za čišćenje, ribanje i poliranje; sredstva i preparati za čišćenje; hemijski preparati za čišćenje za upotrebu u domaćinstvu; higijenski preparati kao toaletni proizvodi; sredstva za čišćenje za domaćinstvo; deterdženti za upotrebu u domaćinstvu; deterdženti, koji nisu za upotrebu u proizvodnim procesima i za medicinsku upotrebu; sapuni i deterdženti; rastvori za čišćenje; toaletni proizvodi [sredstva za ličnu higijenu]*; toaletni sapuni; nemedicinski sapuni; parfimisani sapuni; sapuni za kožu; sapuni za kupanje u tečnom, čvrstom ili u obliku gela; sapuni za ličnu upotrebu; sapuni za ruke; sapuni za upotrebu u domaćinstvu; tečni sapuni; neklizajuće tečnosti za podove.

Klasa 5: Antibakterijska sredstva za pranje ruku; antimikrobna sredstva za pranje ruku; preparati za dezinfekciju ruku; sredstva za dezinfekciju za pranje ruku; sredstva za hirurško pranje ruku; sredstva za dezinfekciju za WC-šolje; sredstva za dezinfekciju za sanitarne potrebe; hemijski preparati za sanitarne potrebe; antibakterijski gelovi na bazi alkohola za dezinfekciju kože; parfimisani sapun za dezinfekciju; sredstva za dezinfekciju za upotrebu u domaćinstvu; sredstva za dezinfekciju za čišćenje kupatila; univerzalni preparati za dezinfekciju i otklanjanje neprijatnih mirisa; dezinfekciona sredstva; dezinfekciona sredstva za higijenske svrhe; univerzalna dezinfekciona sredstva.

(210) **Ž-2020-310**

(220) 02.09.2020.

(731) Maginus doo, Kneza Višeslava 3, 11030, Beograd, RS

(540)



(550) I

(740) Ana Stanković Mugoša, Trg Nezavisnosti br.13, 81000, Podgorica

(511) Klasa 3: Višenamjenski preparati za čišćenje; preparati za čišćenje; preparati za čišćenje za

automobile; preparati za čišćenje za ličnu upotrebu; preparati za čišćenje za upotrebu u domaćinstvu; preparati za čišćenje na bazi rastvarača; preparati za čišćenje podova; preparati za čišćenje, poliranje i ribanje; preparati za čišćenje, poliranje, odmašćivanje i struganje; preparati za čišćenje, poliranje, ribanje i abrazivni preparati; preparati za čišćenje, poliranje, ribanje i struganje; preparati za čišćenje, pranje i poliranje; preparati za čišćenje, ribanje i struganje; preparati za čišćenje tapeta; preparati za čišćenje tepiha; preparati za čišćenje tkanina; preparati za čišćenje u obliku pjene; preparati i supstance za čišćenje i pranje; preparati i supstance za čišćenje, ribanje i poliranje; rastvarači za čišćenje, za upotrebe koje se ne odnose na procese proizvodnje; rastvori za čišćenje; sredstva za čišćenje za domaćinstvo; sredstva za čišćenje za primjenu u domaćinstvu; sredstva za čišćenje za upotrebu u domaćinstvu; sredstva za čišćenje rerne; sredstva za čišćenje tkanine za namještaj; sredstva za čišćenje u obliku pjene za ličnu upotrebu; sredstva za čišćenje u spreju; sredstva za čišćenje u spreju za primjenu u domaćinstvu; sredstva za čišćenje u spreju za upotrebu na tekstilu; sredstva za čišćenje u spreju za upotrebu u domaćinstvu; sredstva i preparati za čišćenje; tečnosti za hemijsko čišćenje; hemijski preparati za čišćenje za upotrebu u domaćinstvu; sredstva za čišćenje i dezodorisanje tepiha; preparati za odmašćivanje za upotrebu u domaćinstvu; preparati za odmašćivanje na bazi rastvarača; preparati za poliranje, odmašćivanje i struganje; proizvodi za odmašćivanje, koji nisu za upotrebu u procesu proizvodnje; rastvarači za odmašćivanje, za upotrebe koje se ne odnose na procese proizvodnje; sredstva za pranje we šolja; preparati za uklanjanje kamenca za upotrebu u domaćinstvu; tečnosti za ribanje.

Klasa 5: Antibakterijska sredstva za čišćenje; sredstva za dezinfekciju za čišćenje kupatila; sredstva za dezinfekciju za WC-šolje; sredstva za dezinfekciju za sanitarne potrebe; sredstva za dezinfekciju za upotrebu u domaćinstvu; univerzalna dezinfekciona sredstva; univerzalni preparati za dezinfekciju i otklanjanje neprijatnih mirisa.sredstva protiv buđi; hemijski preparati za tretiranje buđi; fungicidi; germicidi; germicidni deterdženti.

(210) **Ž-2020-311**

(220) 02.09.2020.

(731) Maginus doo, Kneza Višeslava 3, 11030, Beograd, RS

(540)



(550) I

(740) Ana Stanković Mugoša, Trg Nezavisnosti br.13, 81000, Podgorica

(511) Klasa 3: Vlažne kozmetičke maramice; vlažne maramice impregnirane sredstvima za čišćenje; vlažne toaletne maramice natopljene deterdžentom za pranje posuđa; vlažne toaletne maramice natopljene deterdžentom za čišćenje; vlažni ili impregnirani jastučići, ubrusi ili maramice; ženske higijenske maramice za čišćenje; kozmetičke krpice ili maramice natopljene sredstvima za čišćenje kože; maramice za bebe natopljene preparatima za čišćenje; maramice za jednokratnu upotrebu natopljene sredstvima za čišćenje lica; maramice za jednokratnu upotrebu natopljene hemikalijama ili sredstvima za čišćenje za industrijsku i komercijalnu upotrebu; maramice za jednokratnu upotrebu natopljene hemikalijama ili sredstvima za čišćenje za ličnu higijenu; maramice natopljene kozmetičkim sredstvima; maramice natopljene sa kozmetičkim losionima; platnene maramice impregnirane sredstvima za čišćenje kože; krpice za brisanje naočara impregnirane deterdžentom; krpice za brisanje naočara natopljene deterdžentom; krpice natopljene deterdžentom za čišćenje naočara; krpice natopljene preparatima za čišćenje; natopljene krpice za brisanje prašine; natopljene

krpice za poliranje; natopljene krpice za čišćenje; natopljene krpice za čišćenje, brisanje prašine ili poliranje.

Klasa 5: Dezinfekcijske maramice za jednokratnu upotrebu; maramice za dezinfekciju; maramice i ubrusi natopljeni farmaceutskim losionima kremama; maramice natopljene antibakterijskim preparatima; maramice natopljene farmaceutskim losionima.

Klasa 22: Vreće za pranje platnene odjeće; vreće za prljav veš; vreće od poliuretanske smole za prljav veš; vreće od tkanine za veš; mrežaste vrećice za pranje veša; platnene vreće za veš.

(210) **Ž-2020-312**

(220) 02.09.2020.

(731) Maginus doo, Kneza Višeslava 3, 11030, Beograd, RS

(540)



(550) I

(740) Ana Stanković Mugoša, Trg Nezavisnosti br.13, 81000, Podgorica

(511) Klasa 1: Hemijski preparati za sprečavanje nastanka buđi.

Klasa 3: Preparati za čišćenje, poliranje; preparati za poliranje; poliri za namještaj i podove; preparati za uklanjanje mrlja; preparati za uklanjanje kamenca za upotrebu u domaćinstvu; preparati za uklanjanje rđe; sapun; rastvori za čišćenje.

Klasa 5: Sredstva za čišćenje; dezinfekciona sredstva za higijenske svrhe; hemijski preparati za tretiranje buđi; biocidi; preparati za uklanjanje buđi.

(210) **Ž-2020-313**

(220) 02.09.2020.

(731) Carlsberg Srbija d.o.o., Proleterska 17, 21413, Čelarevo, RS

(540)



(550) I

(740) AOD MSA IP - Milojević Sekulić Advokati, Karađorđeva 65, 11000, Beograd, RS
(511) Klasa 32: Piva; mineralne i sodne vode i druga bezalkoholna pića; voćni napici i voćni sokovi; sirupi i drugi preparati za pravljenje napitaka.

(210) **Ž-2020-314**

(220) 03.09.2020.

(731) Klipsch Group, Inc., 3502 Woodview Trace, Suite 200, 46268, Indianapolis, Indiana, US

(540)

Klipsch[®]

(550) I

(740) AOD "Ćupić", Bulevar Džordža Vašingtona 79, 81000, Podgorica
(511) Klasa 9: Zvučnici (lični i profesionalni), zvučne trake (soundbars), slušalice, nisko frekventni zvučnici (subvuferi), pojačala, i djelovi i oprema za iste.

(210) **Ž-2020-315**

(220) 04.09.2020.

(731) Dow AgroSciences LLC, 9330 Zionsville Road, 46268, Indianapolis, Indiana, US

(540)

TADESTA

(550) I

(740) Božidar S.Radulović, Baku 30/5, 81000, Podgorica
(511) Klasa 5: Pesticidi, preparati za uništavanje štetočina, fungicidi, herbicidi i insekticidi.

(210) **Ž-2020-316**

(220) 04.09.2020.

(731) Dow AgroSciences LLC, 9330 Zionsville Road, 46268, Indianapolis, Indiana, US

(540)

LORTAMA

(550) I

(740) Božidar S.Radulović, Baku 30/5, 81000, Podgorica
(511) Klasa 5: Pesticidi, preparati za uništavanje štetočina, fungicidi, herbicidi i insekticidi.

(210) **Ž-2020-317**

(220) 04.09.2020.

(731) May Cheong Toy Products Factory Limited, Unit 901-2, 9/F, East Ocean Centre, 98 Granville Road, Tsimshatsui East, Kowloon, HK

(540)

The logo for 'Maisto' features the brand name in a bold, black, sans-serif font. A dynamic, black, brush-stroke-like element sweeps across the top of the letters, starting from the left and ending under the 'o'.

(550) I

(740) AOD "Ćupić", Bulevar Džordža Vašingtona 79, 81000, Podgorica

(511) Klasa 16: Hartija, karton i proizvodi od ovih materijala, koji nisu uključeni u druge klase; štampane stvari; knjigovezački materijal; fotografije; kancelarijski materijal; ljepila za kancelarijske i kućne potrebe; umjetnički materijali; kičice; pisaće mašine i kancelarijski rekviziti (izuzev namještaja); materijali za obuku i nastavu (izuzev aparata); plastični materijali za pakovanje (koji nisu uključeni u druge klase); štamparska slova; klišei.

Klasa 28: Igračke, igre, igrice i društvene igre; automobili igračke; vozila igračke; umanjeni modeli (minijature) automobila, umanjeni modeli (minijature) vozila; kompleti za sklapanje umanjenih modela (minijatura) automobila i vozila; Božićne igračke; obrazovne igračke: predškolske igračke; elektronske igračke.

Klasa 35: Oglašavanje; vođenje poslova; poslovno upravljanje; kancelarijski poslovi; maloprodaja, veleprodaja i "onlajn" maloprodaja igračaka, igara, igrica i društvenih igara.

(210) **Ž-2020-318**

(220) 07.09.2020.

(731) AQGT IMPORT&EXPORT DOO, Trg Božane Vučinić 10/1, 81000, Podgorica, ME

(540)

The logo for 'GOLDEN360' features a circular emblem with a stylized 'G' inside, set against a gold and brown gradient. Below the emblem, the brand name 'GOLDEN360' is written in a bold, black, sans-serif font.

(550) I

(511) Klasa 9: Softver koji se može preuzeti za smart telefone i mobilne uređaje za detekciju korisnikove lokacije i prikazivanje relevantnih informacija o kuponima, ponudama, popustima, komentarima potrošača, linkovima za veb sajtove maloprodaje lokalnih trgovaca.

Klasa 35: Promovisanje robe i usluga za druge putem softvera koji se može preuzeti za smart telefone i mobilne uređaje i koji sadrži podatke o kuponima, ponudama, popustima, komentarima potrošača, linkovima za veb sajtove maloprodaje drugih lica, onlajn kataloga sa izdvojenom paletom robe široke potrošnje drugih lica, i podacima o popustima; pružanje komercijalne pomoći oglašivačima u kreiranju, upravljanju i organizovanju onlajn oglašavanja i onlajn spiskova proizvoda.

Klasa 38: Omogućavanje nelične komunikacije klijenata i njihovih kupaca, posredovanje u prenosu poruka između kupaca i prodavaca putem softvera koji se može preuzeti za smart telefone i mobilne uređaje; usluge direktnog pristupa informacijama (online); električni prenos podataka preko svjetske mreže za obradu podataka, uključujući Internet; usluge prenošenja, obezbjeđenja ili prikazivanja podataka o ugostiteljskim objektima putem smart telefona i mobilnih uređaja.

Klasa 42: Pružanje softvera koji se ne može preuzeti za praćenje aktivnosti korisnika softvera koji se može preuzeti za smart telefone i mobilne uređaje; usluge tehničke podrške, u smislu rješavanja problema u softveru za praćenje aktivnosti korisnika softvera koji se može preuzeti za mobilne

telefone i mobilne uređaje.

(210) **Ž-2020-320**

(220) 06.05.2020.

(731) Hemofarm A.D. farmaceutsko-hemijska industrija Vršac, Beogradski put bb, 26300, Vršac, RS

(540)

HEMOSMEKT

(550) I

(740) AOD MSA IP - Milojević Sekulić Advokati, Karađorđeva 65, 11000, Beograd

(511) Klasa 5: Farmaceutski proizvodi.

(210) **Ž-2020-323**

(220) 11.09.2020.

(731) Khayrat Al-Manafa for General Trade and Public Transport Limited Liability company, 27, Saborni str., Varna, BG

(540)



(550) I

(740) Božidar S.Radulović, Baku 30/5, 81000, Podgorica

(511) Klasa 34: Duvan; duvan za zamotavanje; zamjena za duvan; proizvodi od duvana; aromatizovani duvan; filteri za duvan; lule za duvan; sirovi duvan; duvan za žvakanje; šibice; sigurnosne šibice; cigarete; proizvodi za pušače; pribor za pušenje; upaljači za pušače; pepeljare za pušače.

(210) **Ž-2020-324**

(220) 08.06.2020.

(731) KIA MOTORS CORPORATION, 12, Heolleung-ro, Seocho-gu, Seoul, KR

(540)

XCEED

(550) I

(740) AOD MSA IP - Milojević Sekulić Advokati, Karađorđeva 65, 11000, Beograd
(511) Klasa 12: Automobili; sportska kola; dostavna vozila; kamioni; autobusi; električna vozila.

(210) **Ž-2020-325**

(220) 18.06.2020.

(731) Hemofarm A.D. farmaceutsko-hemijska industrija Vršac, Beogradski put bb, 26300, Vršac, RS

(540)

VAGILACT

(550) I

(740) AOD MSA IP - Milojević Sekulić Advokati, Karađorđeva 65, 11000, Beograd

(511) Klasa 5: Farmaceutski proizvodi, naročito medicinska sredstva.

(210) **Ž-2020-326**

(220) 16.09.2020.

(731) Goodyear Tyres UK Limited, 2920 Trident Court, Solihull Parkway Birmingham Business Park, B37 7YN, Birmingham, GB

(540)

TRAILMAX RAID

(550) I

(740) Jasna Jusić, Dalmatinska 2, 81000, Podgorica

(511) Klasa 12: Gume.

(210) **Ž-2020-327**

(220) 18.09.2020.

(731) DAUTI KOMERC Društvo za proizvodstvo, promet i usluge uvoz-izvoz AD s. Bojane Opština Saraj, Naseleno mesto bez uličen sistem s. Bojane, Saraj, Skopje, MK

(540)



(550) I

(740) Božidar S.Radulović, Baku 30/5, 81000, Podgorica

(511) Klasa 3: Nemedicinska kozmetika i toaletni preparati; nemedicinske zubne paste; parfimerija, esencijalna ulja; sredstva za bijeljenje i druge supstance za pranje; preparati za čišćenje, poliranje, ribanje i abrazivna sredstva.

Klasa 29: Meso, riba, živina i divljač; prerada mesa; konzervirano, smrznuto, sušeno i kuvano voće i povrće; želei, džemovi, kompoti; jaja; mlijeko i mliječni proizvodi; jestiva ulja i masti.

Klasa 30: Kafa, čaj, kakao i zamjene za kafu; pirinač; tapioka i sago; brašno i proizvodi od brašna i žitarica; hljeb, peciva i slatkiši; sladoled; šećer, med, melasa; kvasac, prašak za pecivo; so; sirće, sosovi [kao začini]; led [smrznuta voda).

Klasa 35: Vođenje trgovačkog preduzeća, posredovanje u prodaji oglašavanje; poslovanje; poslovni menadžment; kancelarijski poslovi; trgovina na malo i trgovina na veliko svim pro izvodima, a naročito: higijenskim i kozmetičkim proizvodima; medicinskim i veterinarskim preparatima; uređajima za osvjetljenje i grijanje; papirom i kartonom; prehrambenim proizvodima; alkoholnim i bezalkoholnim pićima; aparatima i posuđem za domaćinstvo; tekstilnim proizvodima; odjećom i obućom; proizvodima za vozila i za njihovo održavanje; građevinskim materijalima i alatima.

Klasa 39: Pakovanje i skladištenje robe.

(210) **Ž-2020-332**

(220) 21.09.2020.

(731) Intel Corporation, 2200 Mission College Boulevard, 95052, Santa Clara, California, US

(540)

The Intel logo is displayed in a bold, lowercase, sans-serif font. The letters are black and have a slight shadow effect, giving it a three-dimensional appearance. The logo is centered horizontally on the page.

(550) I

(740) Jasna Jusić, Dalmatinska 2, 81000, Podgorica

(511) Klasa 9: Računari; ručni računari; memorijske ploče; računarski hardver; integrisana kola; integrisana memorijska kola; čipovi sa integrisanim kolima; čip setovi; poluprovodični procesori; čipovi poluprovodičnih procesora; poluprovodični čipovi; mikroprocesori; štampane ploče; elektronske ploče; računarske matične ploče; memorije za računare; računarski operativni sistemi; mikrokontrolori; procesori podataka; centralne procesne jedinice; poluprovodnički memorijski uređaji; mikroprocesori koje je moguće programirati pomoću softvera; digitalni i optički mikroprocesori; digitalni i optički procesori podataka i signala; sklopovske pločice za video reprodukciju; sklopovske pločice za audio reprodukciju; sklopovske pločice za pločice za zvuk i sliku; video grafički akceleratori; multimedijalni akceleratori; video procesori; integrisani sklopovi video procesora; ambalaža matrice i kućišta za procesore; kartice, diskovi, trake, žice, ploče, mikročipovi i elektronska kola, sve za snimanje i prenos podataka; modemi; uređaji i instrumenti, svi za obradu, pohranu, povrat, prenos, prikaz, unos, izlaz, kompresovanje, dekompresovanje, izmjenu, emitovanje i štampanje podataka; računarski uređaji za unos i izlaz; radne stanice; memorije podataka; uređaji za pohranu; sigurnosni sistemi za računalni hardver i softver; setovi elektroničkih čipova; komponente za računare i štampane ploče; akceleratori glasa; akceleratori glasa, podataka, slika i videa; memorijski sistemi za računare; kablovi i adapteri; računarski terminali i štampači za upotrebu s navedenim; uređaji za video prikaz; telekomunikacijski uređaji i instrumenti; fotoaparati; računalni hardver za računarstvo; računarski hardver za računarstvo putem globalne i lokalne mreže; računarski hardver za računarstvo u oblaku; računarski hardver za širokopojasno računarstvo niske latencije; računalni hardver koji se koristi za pružanje bezbjednog okruženja za računarstvo; računarski mrežni hardver; serveri za komunikaciju računara; računarski hardver koji se koristi za pružanje bezbjedne mreže za računarstvo u oblaku; računarski softver za računarstvo; računarski softver za računarstvo u oblaku; računarski softver za računarstvo putem globalne i lokalne mreže; računarski softver za širokopojasno i računarstvo niske latencije; hardver za računarsku memoriju; računarski softver za pružanje bezbjedne mreže za računarstvo; računarski softver koji se koristi za pružanje bezbjedne mreže za računarstvo u oblaku; softver za računarski operativni sistem; ekstenzije, alati i uslužni programi za računarske sisteme na području aplikacijskog softvera za

povezivanje ličnih računara, mreža, telekomunikacijskih uređaja i aplikacija za globalnu računarsku mrežu; računarski hardver i softver za poboljšanje i pružanje transfera, prenosa, prijema, obrade i digitalizacije podataka u stvarnom vremenu; adapteri za računarske mreže; upravljači za računarske mreže; uređaji za računarske mrežne interfejs; čvorista, prekidači i ruteri za računarske mreže; mikroupravljači za uređaje koji mogu da koriste Internet stvari (IoT); računarski softver koji se može preuzimati za povezivanje, rukovanje i upravljanje uređajima koji mogu da koriste Internet stvari (IoT); računarski softver koji se može preuzimati za povezivanje, rukovanje i upravljanje mobilnim uređajima koji mogu da koriste mobilni

Internet stvari (IoT); računarski hardver i softver za razvoj, održavanje i upotrebu lokalnih i računarskih mreža širokog raspona; računarski hardver i softver za razvoj, održavanje i upotrebu interaktivnih audio-video računarskih konferencijskih sistema; računarski hardver i softver za prijem, prikaz i upotrebu emitovanih video, audio i digitalnih podatkovnih signala; uređaji za elektronsku kontrolu interfejsa i kontrolu računara i globalnih računarskih i telekomunikacijskih mreža s televizijskim i kablovskim prenosima i opremom; ruteri; čvorišta; serveri; prekidači; uređaji za testiranje i programiranje integrisanih kola; periferni memorijski aparati i uređaji; poluprovodnički uređaji; računarski hardver i softver za kreiranje, omogućavanje i upravljanje daljinskim pristupom prema i komunikaciju s lokalnim mrežama (LAN), virtualnim privatnim mrežama (VPN), mrežama širokog raspona (WANs) i globalnim računarskim mrežama; operativni softver za rutere, prekidače, mrežna čvorišta i servere; računarski softverski alati za lakše korištenje softverskih aplikacija trećih strana; računarski hardver i softver za bežične mrežne komunikacije; elektronske publikacije koje se mogu preuzimati na polju elektronike, poluprovodnika i integrisanih elektronskih aparata i uređaja, računara, telekomunikacija, zabave, telefonije i žične i bežične telekomunikacije; računarski hardver za upotrebu za mašinski vid, mašinsko učenje, dubinsko učenje, vještačku inteligenciju, obradu prirodnog jezika, algoritme učenja i analizu podataka; računarski softver za mašinsko učenje, ispitivanje podataka i analizu podataka; računarski softver za kognitivno računarstvo, dubinsko učenje, vještačku inteligenciju; platforma računarskog softvera za kognitivno računarstvo; računarski softver za grafičko prikazivanje podataka; računarski softver za prepoznavanje uzoraka; računarski softver za rudarenje podataka (data mining); softver za računarski vid za prikupljanje, obradu, analizu i razumijevanje digitalnih slika i izvlačenje vizualnih podataka; kompleti za razvoj računarskog softvera; kompleti za razvoj računarskog softvera za računarski vid, mašinsko učenje, dubinsko učenje, vještačku inteligenciju, obradu prirodnog jezika,

algoritme učenja i analizu podataka; softver za vid koji se može preuzimati i koji je unaprijed snimljen koji koristi vještačku inteligenciju za pregled i tumačenje podataka, povezivanje s hardverom i pohranu, upravljanje i obradu podataka u oblaku; računarski hardver i softver za snimanje, obradu, primanje, reprodukciju, prenošenje, izmjenu, komprimiranje, dekomprimiranje, emitovanje, spajanje i poboljšanje zvuka, slika, grafike i podataka; programi algoritamskog softvera za rad i upravljanje računarima; računarski hardver i softver za poboljšanje i pružanje slanja, prenosa, prijema, obrade i digitalizacije audio i video grafičkih informacija u stvarnom vremenu;

računarski softver koji se može preuzimati i koji je unaprijed snimljen za prikupljanje, kompiliranje, obradu, prenos i distribuciju podataka sistema globalnog pozicioniranja (GPS) za upotrebu sa fiksnim, mobilnim i uređajima koji se drže u ruci; elektronska baza podataka koja sadrži informacije o putnoj mreži, topografiji, mapama, linijama javnog prevoza, rutama javnog prevoza, planu i rasporedu vožnje javnog prevoza i druge informacije o javnom prevozu koje su snimljene na računarskim medijima; softver za navigaciju za izračunavanje i prikazivanje ruta; sistem za navigaciju za javni prevoz koji sadrži prikaze interaktivnih digitalnih mapa, interaktivne instrukcije i korisnički generisane informacije; interaktivni društveni računarski softver za povrat i prikaz informacija o javnom prevozu, navigaciji, topografiji, mapama i putovanjima; interaktivni društveni računarski softver koji omogućava prenos informacija o javnom prevozu, mapiranju, navigaciji, saobraćaju, rutama i tačkama interesa na telekomunikacijske mreže, mobilne telefone, navigacijske uređaje i ostale mobilne i uređaje koje se drže u ruci; interaktivni društveni računarski softver koji omogućava razmjenu informacija između korisnika; računari i računarsko upravljani sistemi za autonomnu vožnju, vožnju uz pomoć vozača, povezana vozila, vazdušne uređaje bez pilota i dronove; platforme računarskog hardvera i softvera koje sadrže interaktivne displeje,

sisteme za kontrolu i uređaje za kontrolu, sisteme upozorenja, povezivanje, putne računare i GPS za vozila, povezana vozila, autonomna vozila i vozila bez vozača; sistemi s više kamera za upotrebu u vozilima; GPS navigacija i navođenje, GPS praćenje lokacije, GPS uređaji za prikazivanje mapa i izračunavanje ruta, video snimanje i bežični komunikacijski mrežni uređaji za prenos podataka ili slike za vozila; aplikacije za računarske softvere za digitalne virtualne agente, sisteme za predviđanje, mašinska učenje, automatizaciju kognitivnih procesa, prepazivanje uzaraka, prepazivanje znakava, aplikacije za vizualna računarstva, virtualizaciju znanja, robotiku, dronave i bespilotna vozila; aplikacije za računarski softver i hardver za kontrolu autonomnog upravljanja vozilima; aplikacije za računarski softver i hardver za kontrolu autonomnog upravljanja vozilima, autonomnu kontrolu, navigaciju, potpomognutu vožnju vozilima i samostalnu vožnju vozilima; uređaji za praćenje vozila koji se sastoje od računarskog softvera i računarskog hardvera, senzora, predajnika, prijemnika i satelitskih prijemnika za globalna pozicioniranje, sve za upotrebu u vezi sa praćenjem i nadgledanjem vozila.

Klasa 42: Pružanje privremene upotrebe onlajn softvera koji se ne može preuzimati za mašinsko učenje, rudarenje podataka, istraživanje podataka i analizu podataka; pružanje privremene upotrebe onlajn softvera koji se ne može preuzimati za kognitivno računarstvo, dubinsko učenje, vještačku inteligenciju; pružanje privremene upotrebe softvera koji se ne može preuzimati za istraživanje podataka i analizu podataka; pružanje privremene upotrebe softvera koji se ne može preuzimati za rudarenje podataka; pružanje privremene upotrebe softvera koji se ne može preuzimati za kognitivno računarstvo, dubinsko učenje, vještačku inteligenciju; pretraživanje i pribavljanje informacija na računarskim mrežama za druge; računarske usluge, a naročito, pružanje privremene upotrebe onlajn softvera koji se ne može preuzimati, interfejsa za programiranje softverskih aplikacija (API) i softverski widget za mašinsko učenje, rudarenje podataka, istraživanje podataka i analizu podataka; pružanje onlajn softvera za računarski vid koji se ne može preuzimati za prikupljanje, obradu, analizu i razumijevanje digitalnih slika i izvlačenje vizualnih podataka; pružanje onlajn kompleta za razvoj računarskog softvera koji se ne mogu preuzimati; pružanje onlajn kompleta za razvoj računarskog softvera koji se ne mogu preuzimati za računarski vid, mašinsko učenje, dubinsko učenje, vještačku inteligenciju, prirodnu obradu jezika, algoritme učenja i analizu podataka; pružanje onlajn vizualnog softvera koji se ne može preuzimati koji koristi vještačku inteligenciju za pregled i tumačenje podataka, koji se povezuje s hardverom i pohranjuje, upravlja i obrađuje podatke u oblaku; usluge softvera u vidu servisa (SAAS) koji sadrži softver za upotrebu i omogućavanje računarstva u oblaku i usluge informacionih tehnologija (IT), računarstva i računarstva u oblaku; usluge softvera u vidu servisa (SAAS) koji sadrži softver koji se koristi u računarstvu putem globalne i lokalne mreže; usluge softvera u vidu servisa (SAAS) koji sadrži platformu za razvoj softvera za korištenje u povezivanju aplikacija s poslovnim sistemima i uređajima; savjetovanje u vezi sa softverom i pružanje informacija o softveru kao usluge; usluge softvera u vidu servisa (SAAS) koji sadrži softver za korištenje u pružanju računarstva sa minimalnim kašnjenjem i visokim propusnim opsegom; usluge računarskog softvera za pružanje računarskih mogućnosti za programere aplikacija i pružatelje sadržaja; računarstvo u oblaku koje sadrži softver za upotrebu u pružanju računarstva sa minimalnim kašnjenjem i visokim propusnim opsegom, usluge informacionih tehnologija (IT) i računarstva putem globalne i lokalne mreže; usluge računarskog softvera za pružanje mogućnosti računarstva u oblaku za programere aplikacija i pružatelje sadržaja; usluge koje omogućavaju da se aplikacije pokreću preko onlajn mreže; usluge za pružanje analitike, keširanja, računarstva i usmjeravanja protoka; usluge za pružanje sigurne i pouzdane računarske mreže; usluge pružanja konsultacija u vezi sa računarskim hardverom i softverom na polju razvoja okruženja baziranog na oblaku sa integracijom aplikacija preko različitih platformi i povezanih uređaja; računarske usluge, a naročito, kreiranje računarskih indeksa informacija koji su bazirani na mreži, web stranica i resursa; pružanje privremene upotrebe računarskog softvera koji se ne može preuzimati za povezivanje, upravljanje, i rukovođenje umreženim uređajima na Internetu stvari (IoT); pružanje onlajn računarskog softvera koji se ne može preuzimati za povezivanje, upravljanje, i rukovođenje umreženim uređajima na Internetu stvari (IoT); softver kao usluga (SAAS); usluge konsultacija na polju računara i bežičnog računarstva; usluge upravljanja računarskom mrežom, a naročito,

nadgledanje mrežnih sistema za tehničke svrhe; hosting digitalnog sadržaja na Internetu; usluge nadgledanja računarske mreže, a naročito, pružanje informacija o radu računarskih mreža; usluge prilagođavanja web softvera i dizajna računarskog korisničkog interfejsa za druge; usluge razvoja, dizajna i konsultacija za računare; usluge dizajniranja i razvoja standarda za druge u oblasti dizajna i primjenjivanja računarskog softvera, računarskog hardvera i telekomunikacijske opreme; pružanje informacija kupcima i tehničarima u vezi sa računarskim upravljanjem projektima; pružanje onlajn softvera kao usluge za prikupljanje, kompiliranje, obradu, prenos i dijeljenje podataka globalnog sistema za pozicioniranje (GPS); pružanje onlajn softvera koji se ne može preuzimati koji sadrži informacije o putnoj mreži, topografiji, mapama, linijama javnog prevoza, rutama javnog prevoza, planu i rasporedu vožnje javnog prevoza i druge informacije o javnom prevozu; pružanje onlajn softvera za navigaciju koji se ne može preuzimati za izračunavanje i prikazivanje ruta i dijeljenje navigacijskog sistema javnog prevoza, mapa i informacija o putovanju; pružanje onlajn računarskog softvera koji se ne može preuzimati radi omogućavanja dijeljenja informacija o javnom prevozu, mapiranju, navigaciji, saobraćaju, rutama i o tačkama od interesa; interaktivni društveni računarski softver koji omogućava razmjenu informacija među korisnicima; pružanje onlajn softvera u vidu usluge za kontrolu autonomnog upravljanja vozilom, autonomnu kontrolu, navigaciju, potpomognutu vožnju vozilima i samostalnu vožnju vozilima.

(210) **Ž-2020-333**

(220) 22.09.2020.

(731) Price Costco International, Inc., a corporation organized under the laws of the state of Nevada, 999 Lake Drive, 98027, Issaquah, Washington, US

(540)

COSTCO

(550) I

(740) Jasna Jusić, Dalmatinska 2, 81000, Podgorica

(511) Klasa 35: Usluge maloprodaje i veleprodaje i onlajn usluge maloprodaje i veleprodaje u oblastima svježeg mesa, voća, povrća i unaprijed pripremljene hrane, kafe, čaja, suve upakovane hrane, mliječnih proizvoda, pekarskih proizvoda, konditora, alkoholnih i bezalkoholnih pića, duvanskih proizvoda, odjeće i obuće, igračaka, sportske robe, kuhinjskog pribora i opreme, posteljine za domaćinstvo, vještačkog bilja i drveća, staklenih proizvoda, porcelana i grnčarije, proizvoda od papira za kućnu upotrebu, preparata za veš, sapuna i proizvoda za čišćenje, kozmetike, proizvoda za ličnu njegu, farmaceutskih preparata, vitamina, dodataka ishrani, proizvoda i opreme za baštovanstvo, hrane za kućne ljubimce i proizvoda za njegu kućnih ljubimaca, električnih i ručnih alata, automobilske robe i benzina, namještaja za domaćinstvo i spoljašnju upotrebu, kancelarijskog namještaja i opreme, računara i računarske periferne opreme, računarskog softvera i hardvera, malih i većih uređaja, kompakt diskova i DVD-a, potrošačke elektronike, višenamjenskih baterija, prtljaga, nakita, satova, ulaznica za zabavu, prazničnih ukrasa i dekoracija; širenje reklamnog materijala putem štampanih publikacija, displeja proizvoda i onlajn elektronskih komunikacija ili drugih medija; distribucija uzoraka; usluge uvoza i izvoza; savjetodavne usluge u vezi sa uslugama uvoza i izvoza; usluge naručivanja i prodaje lijekova na recept putem onlajn elektronskih komunikacija ili drugih medija; uslugefotokopiranja.

(210) **Ž-2020-334**

(220) 23.09.2020.

(731) PPG ARCHITECTURAL FINISHES, INC. a corporation organized and existing under the laws of the State of Delaware, One PPG Place, 15272, Pittsburgh, Pennsylvania, US
(540)



(550) I

(740) Miladin Popović, Đoka Miraševića 21/III, 81000, Podgorica

(511) Klasa 2: Boje i lakovi; premazi u obliku boje.

(210) **Ž-2020-335**

(220) 23.09.2020.

(731) MARBO PRODUCT d.o.o., Đorđa Stanojevića 14, 11000, Beograd, RS

(540)



(550) I

(740) Jasna Jusić, Dalmatinska 2, 81000, Podgorica

(511) Klasa 29: Grickalice na bazi krompira; čips od krompira; listići od krompira.

(210) **Ž-2020-336**

(220) 23.09.2020.

(731) MARBO PRODUCT d.o.o., Đorđa Stanojevića 14, 11000, Beograd, RS

(540)



(550) I

(740) Jasna Jusić, Dalmatinska 2, 81000, Podgorica

(511) Klasa 29: Grickalice na bazi krompira; čips od krompira; listići od krompira.

(210) **Ž-2020-337**

(220) 23.09.2020.

(731) MARBO PRODUCT d.o.o., Đorđa Stanojevića 14, 11000, Beograd, RS

(540)



(550) I

(740) Jasna Jusić, Dalmatinska 2, 81000, Podgorica

(511) Klasa 29: Grickalice na bazi krompira; čips od krompira; listići od krompira.

(210) **Ž-2020-339**

(220) 16.09.2020.

(300) AD 35047 16/06/2020 ; CH 11179/2020 11/08/2020

(731) Philip Morris Products S.A., Quai Jeanrenaud 3, 2000, Neuchâtel, CH

(540)



(550) I

(740) Milena Pejović, Cetinjski put 11, The Capital Plaza IV floor, 81000, Podgorica

(511) Klasa 34: Žičani vaporizatori za elektronske cigarete i elektronske uređaje za pušenje; duvan , sirov ili prerađen; duvanski proizvodi uključujući cigare, cigarete, cigarilose, duvan za uvijanje cigareta, duvan za lule, duvan za žvakanje, duvan za šmrkanje, kretek; snus (duvan u prahu); zamjena za duvan (za nemedicinsku upotrebu); artikli za pušače, uključujući papir za cigarete, tube za cigarete, filtere za cigarete, kutije za duvan, kutije za cigarete, tabakere i pepeljare, lule, džepne mašine za uvijanje cigareta, upaljače; šibice; duvanski štapici, duvanski proizvodi za zagrijavanje, elektronski uređaji i njihovi djelovi koji se koriste za zagrijavanje cigareta ili duvana u cilju

oslobađanja aerosola koji sadrži nikotin za inhalaciju; tečni nikotinski rastvori za upotrebu u elektronskim cigaretama; elektronski uređaji za pušenje; elektronske cigarete; elektronske cigarete kao zamjena za tradicionalne cigarete; elektronski uređaji koji sadrže aerosol za inhalaciju nikotina; oralni vaporizatori za pušače, duvanski proizvodi i zamjene za duvan; artikli za pušače elektronskih cigareta; djelovi i oprema za navedene proizvode iz klase 34; uređaji za gašenje cigareta i cigara koje se zagrijevaju i duvanskih štapića koji se zagrijevaju; punjive elektronske kutije za cigarete; zaštitne kutije, ukrasne navlake i kutije za nošenje elektronskih cigareta, uređaja za zagrijavanje duvana i elektronskih uređaja za pušenje; automobilski držači i nosači elektronskih cigareta, uređaja za zagrijavanje duvana i elektronskih uređaja za pušenje; posude za odlaganje upotrijebljenih duvanskih štapića koji se zagrijevaju; čistači, preparati za čišćenje, pribor za čišćenje i četkice za čišćenje elektronskih cigareta, uređaja za zagrijavanje duvana i elektronskih uređaja za pušenje. A preciznije, zatraženo pravo prvenstva iz spiska roba i usluga: Andora, 16.6.2020. Broj prijave: 35047: Žičani vaporizatori za elektronske cigarete i elektronske uređaje za pušenje; duvan , sirov ili prerađen; duvanski proizvodi uključujući cigare, cigarete, cigarilose, duvan za uvijanje cigareta, duvan za lule, duvan za žvakanje, duvan za šmrkanje, kretek; snus (duvan u prahu); zamjena za duvan (za nemedicinsku upotrebu); artikli za pušače, uključujući papir za cigarete, tube za cigarete, filtere za cigarete, kutije za duvan, kutije za cigarete, tabakere i pepeljare, lule, džepne mašine za uvijanje cigareta, upaljače; šibice; duvanski štapići, duvanski proizvodi za zagrijavanje, elektronski uređaji i njihovi djelovi koji se koriste za zagrijavanje cigareta ili duvana u cilju oslobađanja aerosola koji sadrži nikotin za inhalaciju; tečni nikotinski rastvori za upotrebu u elektronskim cigaretama; elektronski uređaji za pušenje; elektronske cigarete; elektronske cigarete kao zamjena za tradicionalne cigarete; elektronski uređaji koji sadrže aerosol za inhalaciju nikotina; oralni vaporizatori za pušače, duvanski proizvodi i zamjene za duvan; artikli za pušače elektronskih cigareta; djelovi i oprema za navedene proizvode iz klase 34; uređaji za gašenje cigareta i cigara koje se zagrijevaju i duvanskih štapića koji se zagrijevaju; punjive elektronske kutije za cigarete; Švajcarska, 11.8.2020. Broj prijave: 11179/2020: zaštitne kutije, ukrasne navlake i kutije za nošenje elektronskih cigareta, uređaja za zagrijavanje duvana i elektronskih uređaja za pušenje; automobilski držači i nosači elektronskih cigareta, uređaja za zagrijavanje duvana i elektronskih uređaja za pušenje; posude za odlaganje upotrijebljenih duvanskih štapića koji se zagrijevaju; čistači, preparati za čišćenje, pribor za čišćenje i četkice za čišćenje elektronskih cigareta, uređaja za zagrijavanje duvana i elektronskih uređaja za pušenje.

(210) **Ž-2020-341**

(220) 25.09.2020.

(731) S.C. Johnson & Son, Inc., 1525 Howe Street, 53403-2236, Racine, Wisconsin, US

(540)

OUST

(550) I

(740) Božidar S.Radulović, Baku 30/5, 81000, Podgorica

(511) Klasa 3: Mirisni preparati za vazduh; preparati za parfimisanje vazduha.

Klasa 5: Preparati za prečišćavanje vazduha; preparati za dezinfekciju vazduha; preparati za neutralisanje mirisa; dezodoransi koji nisu za ličnu upotrebu; dezodoransi za prostorije ili ambijentalni dezodoransi; dezinfekciona sredstva za površine.

(210) **Ž-2020-342**

(220) 25.09.2020.

(731) TOYOTA JIDOSHA KABUSHIKI KAISHA (also trading as TOYOTA MOTOR CORPORATION), 1, Toyota-cho, Toyota-shi, Aichi-ken, JP
(540)

GR 010

(550) I

(740) Jasna Jusić, Dalmatinska 2, 81000, Podgorica
(511) Klasa 12: Automobili i njihovi strukturalni djelovi.

(210) **Ž-2020-343**

(220) 28.09.2020.

(731) MLADEGS PAK d.o.o., Vijaka bb, 78430, Prnjavor, BA
(540)



(550) I

(740) Božidar S.Radulović, Baku 30/5, 81000, Podgorica
(511) Klasa 29: Čiste supe, goveđe supe, supe od povrća, supe od zelenja, koncentraci za supe; pavlake (mliječni proizvodi); čokoladno mlijeko; konzervirano voće; sušeno povrće.
Klasa 30: Kakao; kečap; prašak za kolače, tijesto za kolače, majoneza; mirođije; šećer, ekstrakt slada za prehranu, vanilija; tjestenine za prehranu; pića od čokolade; zobene pahuljice; pudinzi; kakao sa mlijekom.
Klasa 32: Voćni sokovi, voćni koncentraci bez alkohola, voćni napici bez alkohola.

(210) **Ž-2020-344**

(220) 28.09.2020.

(731) TOYOTA JIDOSHA KABUSHIKI KAISHA (also trading as TOYOTA MOTOR CORPORATION), 1, Toyota-cho, Toyota-shi, Aichi-ken, JP
(540)

TOYOTA BZ1

(550) I

(740) Jasna Jusić, Dalmatinska 2, 81000, Podgorica
(511) Klasa 12: Automobili i njihovi strukturalni djelovi.

(210) **Ž-2020-345**

(220) 28.09.2020.

(731) Mylan Healthcare GmbH, Lütticher Straße 5, 53842, Troisdorf, DE
(540)

LIXDERA

(550) I

(740) Miladin Popović, Đoka Miraševića 21/III, 81000, Podgorica
(511) Klasa 5: Medikamenti; farmaceutski preparati; lijekovi; biljni lijekovi; ekspektoransi; antitusici; biljni lijekovi za liječenje bolesti respiratornog trakta i bronhija.

(210) **Ž-2020-346**

(220) 29.09.2020.

(731) TOYOTA JIDOSHA KABUSHIKI KAISHA (also trading as TOYOTA MOTOR CORPORATION), 1, Toyota-cho, Toyota-shi, Aichi-ken, JP

(540)

TOYOTA BZ3

(550) I

(740) Jasna Jusić, Dalmatinska 2, 81000, Podgorica
(511) Klasa 12: Automobili i njihovi strukturalni djelovi.

(210) **Ž-2020-349**

(220) 30.09.2020.

(731) Merck Sharp & Dohme Corp., One Merck Drive, 08889, Whitehouse Station, New Jersey, US

(540)

LYFNUA

(550) I

(740) AOD "ĆUPIĆ", Bulevar Džordža Vašingtona 79, 81000, Podgorica
(511) Klasa 5: Farmaceutski preparati.

(210) **Ž-2020-350**

(220) 30.09.2020.

(731) Merck Sharp & Dohme Corp., One Merck Drive, 08889, Whitehouse Station, New Jersey, US

(540)

LYFDURA

(550) I

(740) AOD "ĆUPIĆ", Bulevar Džordža Vašingtona 79, 81000, Podgorica
(511) Klasa 5: Farmaceutski preparati.

(210) **Ž-2020-351**

(220) 30.09.2020.

(731) Merck Sharp & Dohme Corp., One Merck Drive, 08889, Whitehouse Station, New Jersey,
US

(540)

GEFZURIS

(550) I

(740) AOD "ĆUPIĆ", Bulevar Džordža Vašingtona 79, 81000, Podgorica
(511) Klasa 5: Farmaceutski preparati.

(210) **Ž-2020-352**

(220) 30.09.2020.

(731) Merck Sharp & Dohme Corp., One Merck Drive, 08889, Whitehouse Station, New Jersey,
US

(540)

VIFNUEL

(550) I

(740) AOD "ĆUPIĆ", Bulevar Džordža Vašingtona 79, 81000, Podgorica
(511) Klasa 5: Farmaceutski preparati.

(210) **Ž-2020-353**

(220) 30.09.2020.

(731) TOYOTA JIDOSHA KABUSHIKI KAISHA (also trading as TOYOTA MOTOR
CORPORATION), 1, Toyota-cho, Toyota-shi, Aichi-ken, JP

(540)

BZ1X

(550) I

(740) Jasna Jusić, Dalmatinska 2, 81000, Podgorica
(511) Klasa 12: Automobili i njihovi strukturalni djelovi.

(210) **Ž-2020-354**

(220) 01.10.2020.

(731) TOYOTA JIDOSHA KABUSHIKI KAISHA (also trading as TOYOTA MOTOR
CORPORATION), 1, Toyota-cho, Toyota-shi, Aichi-ken, JP

(540)

TOYOTA BZ4

(550) I

(740) Jasna Jusić, Dalmatinska 2, 81000, Podgorica
(511) Klasa 12: Automobili i njihovi strukturalni djelovi.

(210) **Ž-2020-355**

(220) 01.10.2020.

(731) TOYOTA JIDOSHA KABUSHIKI KAISHA (also trading as TOYOTA MOTOR CORPORATION), 1, Toyota-cho, Toyota-shi, Aichi-ken, JP

(540)

BZ2X

(550) I

(740) Jasna Jusić, Dalmatinska 2, 81000, Podgorica
(511) Klasa 12: Automobili i njihovi strukturalni djelovi.

(210) **Ž-2020-356**

(220) 02.10.2020.

(731) TOYOTA JIDOSHA KABUSHIKI KAISHA (also trading as TOYOTA MOTOR CORPORATION), 1, Toyota-cho, Toyota-shi, Aichi-ken, JP

(540)

TOYOTA BY2

(550) I

(740) Jasna Jusić, Dalmatinska 2, 81000, Podgorica
(511) Klasa 12: Automobili i njihovi strukturalni djelovi.

(210) **Ž-2020-357**

(220) 05.10.2020.

(731) Pfizer Inc., 235 East 42nd Street, 10017, New York, New York, US

(540)

CIBINQO

(550) I

(740) Jasna Jusić, Dalmatinska 2, 81000, Podgorica

(511) Klasa 5: Farmaceutski i veterinarski preparati; sanitarni preparati za medicinske svrhe; dijetetska hrana i supstance za medicinsku ili veterinarsku upotrebu, hrana za bebe; dijetetski suplementi za ljude i životinje; flasteri, materijali za zavijanje; materijal za plombiranje zuba, zubarska smola; dezinfekciona sredstva; preparati za uništavanje štetočina; fungicidi, herbicidi.

(210) **Ž-2020-358**

(220) 05.10.2020.

(731) TOYOTA JIDOSHA KABUSHIKI KAISHA (also trading as TOYOTA MOTOR CORPORATION), 1, Toyota-cho, Toyota-shi, Aichi-ken, JP

(540)

BZ3X

(550) I

(740) Jasna Jusić, Dalmatinska 2, 81000, Podgorica

(511) Klasa 12: Automobili i njihovi strukturalni djelovi.

(210) **Ž-2020-359**

(220) 05.10.2020.

(731) TOYOTA JIDOSHA KABUSHIKI KAISHA (also trading as TOYOTA MOTOR CORPORATION), 1, Toyota-cho, Toyota-shi, Aichi-ken, JP

(540)

BZ5X

(550) I

(740) Jasna Jusić, Dalmatinska 2, 81000, Podgorica

(511) Klasa 12: Automobili i njihovi strukturalni djelovi.

(210) **Ž-2020-360**

(220) 06.10.2020.

(731) TOYOTA JIDOSHA KABUSHIKI KAISHA (also trading as TOYOTA MOTOR CORPORATION), 1, Toyota-cho, Toyota-shi, Aichi-ken, JP

(540)

TOYOTA BZ5

(550) I

(740) Jasna Jusić, Dalmatinska 2, 81000, Podgorica

(511) Klasa 12: Automobili i njihovi strukturalni djelovi.

(210) **Ž-2020-362**

(220) 07.10.2020.

(731) Hemofarm A.D. farmaceutsko-hemijska industrija Vršac, Beogradski put bb, 26300, Vršac, RS

(540)

BELIMON

(550) I

(740) AOD MSA IP - Milojević Sekulić Advokati, Karađorđeva 65, 11000, Beograd

(511) Klasa 5: Farmaceutski proizvodi.

(210) **Ž-2020-363**

(220) 07.10.2020.

(731) Hemofarm A.D. farmaceutsko-hemijska industrija Vršac, Beogradski put bb, 26300, Vršac, RS

(540)

LOTREKA

(550) I

(740) AOD MSA IP - Milojević Sekulić Advokati, Karađorđeva 65, 11000, Beograd

(511) Klasa 5: Farmaceutski proizvodi.

(210) **Ž-2020-365**

(220) 08.10.2020.

(731) British American Tobacco (Brands) Inc., 251 Little Falls Drive, Suite 100, DE 19808-1674, Wilmington, US

(540)

LUCKY STRIKE COMPACT

(550) I

(740) Miladin Popović, Đoka Miraševića 21/III, 81000, Podgorica

(511) Klasa 34: Cigarete; duvan, sirov ili prerađen; duvan za samostalno zamotavanje; duvan za lule; duvanski proizvodi; zamjene za duvan (koje nijesu za upotrebu u medicini); cigare; cigarilosi; upaljači za cigarete; upaljači za cigare; šibice; artikli za pušače; cigaret papir; cigaret tube; filteri za cigarete; džepni aparati za zamotavanje cigareta; ručne mašine za ubrizgavanje duvana u papirne tube; elektronske cigarete; tečnosti za elektronske cigarete; duvanski proizvodi namijenjeni za zagrijavanje.

(210) **Ž-2020-370**

(220) 20.10.2020.

(731) Novartis AG, Basel, 4002, CH

(540)

AIRTIYO

(550) I

(740) AOD MSA IP - Milojević Sekulić Advokati, Karađorđeva 65, 11000, Beograd

(511) Klasa 5: Farmaceutski preparati za ljudsku upotrebu.

(210) **Ž-2020-371**

(220) 20.10.2020.

(300) CH 120672020 30/08/2020

(731) The Procter & Gamble Company, One Procter & Gamble Plaza, 45202, Cincinnati, Ohio, US

(540)

MENO BALANCE

(550) I

(740) AOD "Lutovac & partneri", Bulevar Ivana Crnojevića 93, 81000, Podgorica

(511) Klasa 3: Sapuni; parfimerija; eterična ulja; kozmetika; losioni za kosu; sredstva za njegu zuba; preparati za čišćenje, njegu i uljepšavanje kože, vlasišta i kose; preparati za oblikovanje frizure; preparati za nijansiranje, bijeljenje, farbanje i bojenje kose.

(210) **Ž-2020-373**

(220) 21.10.2020.

(731) "PANONKA" D.O.O., ulica Nikšički put broj 7, 81000, Podgorica, ME

(540)



(550) I

(740) AOD "ĆUPIĆ", Bulevar Džordža Vašingtona 79, 81000, Podgorica

(511) Klasa 1: Emulgatori, aditivi za prehrambenu industriju, konzervansi, đubriva za zemlju, hemijski proizvodi za industriju, nauku, fotografsku djelatnost, hortikulturu, poljoprivredu i šumarstvo.

Klasa 5: Razni higijenski proizvodi za upotrebu u veterini, razna dezinfekciona sredstva kako prostora tako i samih životinja, proizvodi za uništavanje životinjskih štetočina, fungicidi, herbicidi.

Klasa 7: Mašine i alatne mašine, inkubatori za jaja, automatske mašine u poljoprivredi, razne poljoprivredne sprave i uređaji.

Klasa 22: Konopci i kanapi od prirodnog ili vještačkog vlakna, od papira ili od plastike (rafije, PP veziva itd ..).

Klasa 31: Poljoprivredni, povrtlarski, šumski proizvodi i bobice, koji nisu obuhvaćeni drugim klasama; žive životinje; svježe voće i povrće; sjeme, prirodne biljke i cvijeće; hrana za životinje; slad.

Klasa 44: Veterinarske usluge; higijenska njega i njega ljepote za ljude ili za životinje; usluge poljoprivrede, povrtlarstva i šumarstva.

(210) **Ž-2020-374**

(220) 22.10.2020.

(731) Japan Tobacco Inc., 1-1, Toranomom 4-chome, Minato-ku, Tokyo, JP

(540)



(550) I

(740) Jasna Jusić, Dalmatinska 2, 81000, Podgorica

(511) Klasa 34: Duvan, prerađen ili neprerađen; duvan za pušenje, duvan za lule, duvan za ručno uvijanje, duvan za žvakanje, snus duvan; cigarete, elektronske cigarete, cigare, cigarilosi; duvan za ušmrkavanje; artikli za pušače uključeni u klasu 34; papir za cigarete, tube za cigarete i šibice.

(210) **Ž-2020-375**

(220) 23.10.2020.

(731) D.O.O. "Obuća Minja", ul.Mojsija Zečevića br.7, 84300, Berane, ME

(540)

The logo for Molly Shoes features the brand name 'Molly Shoes' in a large, elegant serif font. Below it, the tagline 'designed in Italy' is written in a smaller, italicized serif font. The logo is centered within a light gray rectangular frame.

(550) I

(511) Klasa 25: Obuća.

Klasa 35: Maloprodaja i veleprodaja.

(210) **Ž-2020-376**

(220) 23.10.2020.

(731) INVESTICIONO DRUŠTVO SASA CAPITAL AD PODGORICA, , 81000, Podgorica, ME

(540)

The logo for SASA MARKETS features a stylized 'S' symbol on the left, composed of two overlapping blue and white shapes. To the right of the symbol, the words 'SASA' and 'MARKETS' are stacked vertically in a bold, sans-serif font.

(550) I

(511) Klasa 36: Elektronski prenos virtualnih valuta; finansijska razmjena virtualnih valuta; pružanje informacija o finansijama putem web-stranice; trgovina akcijama i hartijama od vrijednosti; usluge berzanskog posredovanja.

(210) **Ž-2020-377**

(220) 23.10.2020.

(731) INVESTICIONO DRUŠTVO SASA CAPITAL AD PODGORICA, 81000, Podgorica, ME

(540)



(550) I

(511) Klasa 36: Elektronski prenos virtualnih valuta; finansijska razmjena virtualnih valuta; pružanje informacija o finansijama putem web-stranice; trgovina akcijama i hartijama od vrijednosti; usluge berzanskog posredovanja.

(210) **Ž-2020-378**

(220) 23.10.2020.

(731) Industrija piva i sokova „Trebjesa“ d.o.o. Nikšić, Ul. Njegoševa br.18, 81400, Nikšić, ME

(540)

NIKSICKO AMBER

(550) I

(740) Pavle Tripković, City kvart - Cetinjski put 40, L5-1, stan 10, Podgorica

(511) Klasa 32: Piva, stout, lager (piva sa donjom fermentacijom ili piva donjeg vrenja), tamna piva (porter) i svetla piva, ale piva (piva sa gornjom fermentacijom ili piva gornjeg vrenja); mineralne i gazirane vode i druga bezalkoholna pića; voćni napici i voćni sokovi; sirupi i drugi preparati za pripremanje pića.

(210) **Ž-2020-379**

(220) 23.10.2020.

(731) Industrija piva i sokova „Trebjesa“ d.o.o. Nikšić, Ul. Njegoševa br.18, 81400, Nikšić, ME

(540)

NIKSICKO EASY

(550) I

(740) Pavle Tripković, City kvart - Cetinjski put 40, L5-1, stan 10, Podgorica

(511) Klasa 32: Piva, stout, lager (piva sa donjom fermentacijom ili piva donjeg vrenja), tamna piva (porter) i svetla piva, ale piva (piva sa gornjom fermentacijom ili piva gornjeg vrenja); mineralne i gazirane vode i druga bezalkoholna pića; voćni napici i voćni sokovi; sirupi i drugi preparati za pripremanje pića.

(210) **Ž-2020-380**

(220) 23.10.2020.

(731) Industrija piva i sokova „Trebjesa“ d.o.o. Nikšić, Ul. Njegoševa br.18, 81400, Nikšić, ME

(540)

NIKSICKO REZANO

(550) I

(740) Pavle Tripković, City kvart - Cetinjski put 40, L5-1, stan 10, Podgorica

(511) Klasa 32: Piva, stout, lager (piva sa donjom fermentacijom ili piva donjeg vrenja), tamna piva (porter) i svetla piva, ale piva (piva sa gornjom fermentacijom ili piva gornjeg vrenja); mineralne i gazirane vode i druga bezalkoholna pića; voćni napici i voćni sokovi; sirupi i drugi preparati za pripremanje pića.

(210) **Ž-2020-381**

(220) 26.10.2020.

(731) Zhengzhou Yutong Group Co., Ltd., No.8 Changchun Road, Hi-tech Industrial Park, Zhengzhou, CN

(540)

YUTONG

(550) I

(740) Božidar S. Radulović, Baku 30/5, 81000, Podgorica

(511) Klasa 7: Mašine za bušenje, mešači, valjci [mašine], parni valjci, mašine za mešanje, mašine za izbeljivanje, mašine za mešanje, mašine za mešanje betona, mašine za pravljenje bitumena, buldožeri, kopači, mehanički, bageri, mašine za katranisanje, mašine za postavljanje šina, mašine za pravljenje puteva, mašine za izradu šina, kopači [mašine], hidraulični klipovi [mašine], mašine za pomeranje zemlje, plugovi za kopanje rovova, lopate, mehaničke, mašine i mašinerija koje se koriste u zemljanim radovima u oblasti građevinarstva, mostova i puteva, vibratori za beton, mašine za utovar i istovar, teretne dizalice, kranovi [aparati za podizanje], starteri za motore, klipovi prigušivača [delovi mašina], amortizeri za mašine, mašine za čišćenje puteva, samohodne, pulverizatori otpadnih voda, aparati za pranje, instalacije za pranje vozila, mašine i aparati za čišćenje, električni, drobilice otpada [mašine], drobilice i prese za otpad, drobilice i prese za đubre, mašine za presovanje đubreta, mašine za presovanje otpada, bageri za vodu.

(210) **Ž-2020-383**

(220) 26.10.2020.

(731) Western Union Holdings, Inc., 7001 East Belleview Avenue, 80237, Denver, Colorado, US

(540)



(550) I

(740) Miladin Popović, Đoka Miraševića 21/III, 81000, Podgorica

(511) Klasa 9: Računarski softver; operativni računarski programi, snimljeni; računarski programi, koji se mogu preuzimati; računarski programi, snimljeni; aplikacije za računarske softvere koje se mogu preuzimati; računarske softverske platforme, snimljene ili preuzete; računarski softver, snimljeni; kriptografski ključevi za primanje i trošenje kriptovalute, koji se mogu preuzimati; elektronski novčanici koji se mogu preuzimati; elektronske i magnetne identifikacione kartice za upotrebu prilikom plaćanja usluga; magnetne kodirane kartice za transakcije koje se vrše debitnim i poklon karticama; računarski softver, naime, elektronska finansijska platforma pomoću koje je moguće vršiti više vrsta platnih i debitnih transakcija u integrisanom mobilnom telefonu, ličnom digitalnom asistentu i veb okruženju; računarski softver za omogućavanje pretrage podataka; računarski softver za upravljanje bazom podataka; računarski softver za omogućavanje pružanja bankarskih usluga; računarski program za ispitivanje kreditne sposobnosti; računarski softver za šifrovanje; aplikacijski softver; računarski aplikativni softver za mobilne telefone; računarski programi i računarski softver za elektronsku trgovinu hartijama od vrijednosti; računarski softver za elektronsku trgovinu koji omogućava korisnicima da vrše elektronske poslovne transakcije preko globalne računarske mreže; računarski firmver; kuponi za mušterije u elektronskoj formi; elektronske publikacije koje se mogu preuzimati; računari; smartfoni [pametni telefoni]; pametni satovi.

Klasa 36: Osiguranje; osiguranje; finansijski poslovi; finansijske usluge; novčani (monetarni) poslovi; bankarske usluge; poslovi vezani za nepokretnosti; usluge prenosa novca; usluge plaćanja računa; usluge plaćanja doznakom; usluge unovčavanja čekova; usluge naplate dugova; elektronski prenos sredstava; prenos novca kupaca elektronskim putem; prenos sredstava (plaćanja) za potrošače; usluge kreditnih kartica; obrada elektronskih plaćanja izvršenih pripejd karticama; izdavanje poklon vaučera koji potom mogu da budu zamijenjeni za proizvode i usluge; usluge bankomata; usluge vezane za debitne kartice; izdavanje poklon kartica; direktna uplata sredstava na tekuće račune kupaca; automatizovane usluge depozita kod finansijskih klirinških kuća i usluge aukcijskog onlajn plaćanja i poravnanja; usluge mjenjačnice; usluge agencija za promet nekretnina; upravljanje nepokretnostima; upravljanje ulaganjima; ugovaranje zajmova; bankarske hipoteke; investicioni fondovi; trgovanje akcijama i obveznicama; fiducijarni poslovi; kućno bankarstvo; izdavanje nekretnina; usluge jemstva; posredovanje na berzi; investiranje kapitala; provjera čekova; klirinški poslovi [finansijske]; usluge kreditnih agencija; grupno finansiranje; usluge savjetovanja u vezi sa zaduživanjem; usluge agencija za naplatu dugova; depoziti dragocjenosti; usluge plaćanja elektronskim novčanikom; elektronski prenos virtualnih valuta; usluge mjenjačnica; finansijske analize; usluge finansijske procjene; finansijske konsultacije; finansijske usluge pri carinskom posredovanju; finansijske evaluacije; finansijska razmjena virtualnih valuta; finansijsko upravljanje; finansijsko upravljanje isplatama nadoknada za druge; finansijska istraživanja; finansijsko sponzorisanje; finansijska procjena intelektualne svojine; pružanje finansijskih informacija; pružanje informacija o finansijama putem internet stranice; usluge finansiranja; fiskalno procjenjivanje; finansiranje lizinga; finansiranje lizinga; zajmovi na rate; posredovanje u osiguranju; konsultacije o osiguranju; usluge osiguranja; pružanje informacija o osiguranju; investiranje sredstava; pozajmljivanje uz založno obezbeđenje; finansiranje zajmova; organizovanje novčanih prikupljanja; onlajn bankarstvo; obrada plaćanja izvršenih kreditnim karticama; obrada plaćanja izvršenih platnim karticama; usluge fondova uzajamne pomoći; procjena nekretnina; posredovanje u prometu

nekretnina; davanje popusta trećim licima u objektima kroz upotrebu članskih karti; ubiranje najamnine [stanarine]; usluge isplate penzija; usluge čuvanja u sefovima; usluge štedionica; posredovanje u prometu sa hartijama od vrednosti; usluge berzanskog posredovanja; notiranje cijena na berzi; usluge davanja garancije; izdavanje vrednosnih bonova; izdavanje putničkih čekova; fiducijarni poslovi; pružanje usluga u vezi sa provjerama usklađenosti sa propisima.

Klasa 42: Usluge kontrole kvaliteta i autentifikacije; projektovanje i razvoj računarskog hardvera i softvera; računarsko programiranje; iznajmljivanje računara; savjetovanje o sigurnosti računara; savjetovanje u oblasti računarskog softvera; dizajniranje računarskog softvera; analize računarskih sistema; dizajniranje računarskih sistema; savjetodavne usluge iz oblasti kompjuterske tehnologije; iznajmljivanje računarskog softvera; konvertovanje računarskih podataka i programa, osim fizičkog konvertovanja; konvertovanje podataka ili dokumenata sa fizičkih na elektronske nosače; usluge kodiranja podatka; konsultacije o sigurnosti podataka; razvoj računarskih platformi; umnožavanje računarskih programa; elektronsko pohranjivanje podataka; elektronsko nadgledanje korišćenja kreditnih kartica radi otkrivanja internet prevare; elektronsko nadgledanje podataka o zaštiti ličnosti radi otkrivanja krađe identiteta putem interneta; savetovanje u vezi informacionih tehnologija; pružanje informacija u vezi sa računarskim tehnologijama i programiranjem putem veb-sajta; instaliranje računarskog softvera; konsultacije o bezbednosti interneta; održavanje računarskog softvera; praćenje računarskih sistema daljinskim pristupom; nadgledanje računarskih sistema radi otkrivanja neovlašćenog pristupa ili povrede podataka; nadgledanje računarskih sistema radi otkrivanja kvarova; platforma kao usluga [PaaS]; softver u vidu servisa [SaaS]; ažuriranje računarskog softvera; pružanje korisničkih usluga autentifikacije korišćenjem tehnologije jedinstvene prijave za mrežne softverske aplikacije; usluge provjere autentičnosti korisnika tehnologijom za transakcije e-trgovanja; hostovan softver za provjeru usklađenosti sa propisima.

(210) **Ž-2020-385**

(220) 26.10.2020.

(300) GB 00003512838 16/07/2020

(731) Sportsdirect.com Retail Limited, Unit A, Brook Park East, NG20 8RY, Shirebrook, GB

(540)



(550) I

(740) Miladin Popović, Đoka Miraševića 21/III, 81000, Podgorica

(511) Klasa 25: Odjeća; obuća; pokrivala za glavu; sportske jakne s kapuljačom [parke]; trake za oko ruke [odjeća]; fantomke; kaiševi [odjeća]; kaiševi od imitacije kože; kožni pojasevi; čizme; jakne otporne na vjetar; kape (za tuširanje); kape; svešteničko odijelo za bogoslužnja; kaputi; haljine; odjeća za vježbanje; modna odjeća; jakne, čizme i prsluci za pecanje; kombinezoni za pecanje; fudbalske cipele, kopačke; fudbalski dresovi; kamašne, dokoljenice i nazuvci; rukavice; šeširi; čarape i pletena trikotaža; jakne; farmerice; odjeća za slobodno vreme; ležerna odjeća; lagana odjeća; naručnici, sveštenička odjeća; kravate zaštitna odjeća za surf; džemperi; replike komplet fudbalskih dresova; zaštitna odjeća, rukavice, pokrivala za glavu i obuća (izuzev za zaštitu od nezgoda ili povreda); kombinezoni za skijanje; ešarpe kao odjeća; marama, šalovi; bluze, košulje; cipele; skijaška odjeća; maske za spavanje; odjeća za spavanje; radni kombinezon, odijelo; kratke čarape; sportska oprema (odjeća) za jahanje; sportska odjeća; sportska garderoba; sportska pokrivala za glavu (izuzev kaciga); sportske cipele, čizme za planinarenje; sportski dresovi; sportska odjeća; kramponi za fudbalske kopačke [cipele]; šorcevi za surf; odjeća za kupanje; termo odjeća;

sportska obuća; pantalone; majice; donji veš; prsluci; čizme za planinarenje; nepromočiva odjeća i odjeća otporna na razne vremenske uslove; vodootporna odjeća; nepromočiva odjeća; gumirana odjeća; monaški velovi; manžetne; sve naprijed navedeno izuzev odjeće za bicikliste; djelovi, pribor i oprema za svu naprijed navedenu robu.

Klasa 35: Oglašavanje; vođenje poslova; poslovno upravljanje; kancelarijski poslovi; računovodstvo, vođenje poslovnih knjiga i revizija; računovodstvo; izrada izvoda sa računa; komercijalna administracija za licence roba i usluga drugih, upravljanje programom popusta za omogućavanje učesnicima da dobiju popuste na robu i usluge upotrebom članske kartice za ostvarivanje popusta, administracija takmičenja u reklamne svrhe, upravljanje programima za lojalnost potrošača, upravljanje šemama za lojalnost potrošača i nagrađivanje, upravljanje programima za lojalnost koji uključuju popuste ili podsticaje, upravljanje programom nagrađivanja lojalnosti, upravljanje programima za članarine, upravljanje pretplatama na novine [za druge], upravljanje šemama podsticanja prodaje i promocije, upravljanje podsticajnim programima za podsticanje prodaje, upravljanje poslovnim aktivnostima franšiznih objekata, upravljanje poslovnim aktivnostima maloprodajnih objekata; administracija koja se odnosi na metode marketinga i prodaje; administrativne usluge u vezi sa karticama lojalnosti; administrativno obrađivanje naloga; usluge administrativne podrške i obrade podataka; reklamne, marketinške i promotivne usluge; reklamiranje za druge na internetu; reklamne i marketinške usluge koje se pružaju putem društvenih medija; reklamiranje slanjem narudžbenica; reklamiranje proizvoda drugih prodavaca, radi omogućavanja potrošačima da robu tih prodavaca lakše razgledaju i uporede; reklamiranje, naročito usluge promocije robe; usluge reklamiranja radi promocije elektronske trgovine; reklamiranje preko svih javnih sredstava komunikacije; savjetodavne usluge u poslovnom upravljanju fitnes klubova; savjetodavne usluge u poslovnom upravljanju zdravstvenih klubova; savjetodavne usluge u vezi sa poslovanjem fitnes klubova; savjetodavne usluge u vezi sa poslovanjem zdravstvenih klubova; organizovanje i vođenje reklamnih događaja, sajмова i izložbi za poslovne i reklamne potrebe; organizovanje poslovnih transakcija, za druge, preko internet prodavnica; usluge pretplate na novine za druge; organizovanje postavki za komercijalne potrebe, postavki za trgovinske potrebe, izložbi za reklamne potrebe, izložbi za komercijalne potrebe, prezentacija za reklamne potrebe, prezentacija za komercijalne potrebe; organizovanje pretplate na internet publikacije za druge, na elektronske novine, na informativne medije, na medijske pakete, na telekomunikacione usluge za druge; usluge maloprodaje putem licitacije; revizorske usluge; reklamiranje preko plakata; usluge kreiranja, procjene, pozicioniranja, strategije i testiranja brenda; usluge poslovne administracije za obradu prodaje preko interneta; poslovni savjeti i konsultantske usluge u vezi sa franšizama; usluge davanja poslovnih savjeta; pružanje usluga analiza poslovanja i poslovnih informacija kao i usluga istraživanja tržišta; poslovne procjene; usluge poslovne pomoći, upravljanja i administracije; poslovno savjetovanje i savjetodavne usluge; usluge poslovnog savjetovanja u vezi sa upravljanjem, marketingom i promocijom kampanja za prikupljanje sredstava; analiziranje poslovnih podataka; pružanje poslovnih informacija; obavještenja o poslovima; usluge poslovnog izvještavanja; poslovna ispitivanja; poslovno upravljanje i organizaciono savjetovanje; poslovno upravljanje trgovinama, zabavnim objektima, hotelima, izvođačkim umjetnicima, sportskim ličnostima, maloprodajnim objektima, sportskim klubovima, sportskim objektima, sportskim ustanovama, sportistima, kompleksima za bazenima, veleprodajnim i maloprodajnim objektima; poslovno upravljanje; usluge praćenja poslovanja i poslovne savjetodavne usluge, naime, praćenje korisnika i reklamiranje drugih radi kreiranja strategije, sticanja razumjevanja, i pružanja marketinških smjernica i radi analize, razumevanja i predviđanja ponašanja i motivacije potrošača i tržišnih trendova; poslovno umrežavanje; poslovno upravljanje tržišnim centrima i tržnicama; poslovno upravljanje i organizaciono savjetovanje; poslovno planiranje; usluge unapređenja poslovanja; poslovna istraživanja; poslovno strateško planiranje; kancelarijski poslovi preuzimanja naloga za prodaju; prikupljanje poslovne statistike; komercijalna administracija za licence roba i usluga trećih lica; usluge komercijalnog savjetovanja; pružanje komercijalnih informacija; pružanje komercijalnih informacija i savjeta potrošačima; pomoć u poslovnom ili industrijskom upravljanju; upravljanje preduzećima [za druge]; usluge upoređivanja prilikom kupovine; sastavljanje reklama za upotrebu na internet veb stranicama; prikupljanje podataka o poslovanju; prikupljanje informacija u kompjuterske baze podataka;

prikupljanje statističkih podataka; sastavljanje, proizvodnja i distribucija reklamnog materijala; sastavljanje i održavanje onlajn imenika; usluge snimanja računarskih podataka; kompjutersko upravljanje podacima; konsultantske usluge koje se odnose na tehnike prodaje i prodajne programe; savjetodavne usluge u vezi sa marketingom; konsultantske usluge koje se odnose na oglašavanje; korporativno planiranje; analize cijena i troškova; usluge klubova za potrošače i usluge programa za lojalnost potrošača, za komercijalne, promotivne i/ili reklamne svrhe; obrada podataka, sistematizacija i upravljanje podacima; prezentacija robe; usluge digitalnog oglašavanja; digitalni marketing; neposredno oglašavanje putem pošte; distribucija reklamnog materijala; distribucija reklamnog, marketinškog i promotivnog materijala; distribucija uzoraka; reprodukcija dokumenata; ekonomske prognoze; stručnjaci za efikasnost; agencije za zapošljavanje; usluga marketinga događaja; usluge agencija za uvoz i izvoz; organizovanje modnih revija u komercijalne svrhe; organizovanje modnih revija u promotivne svrhe; usluge poslovnog savjetovanja koje se odnosi na franšize; usluge upravljanja ljudskim resursima i pronalaženja osoblja; usluge agencija za uvoz i izvoz; informacije o metodama prodaje; informativne usluge u vezi sa reklamiranjem; fakturisanje; usluge grafičke obrade materijala za reklamne svrhe; usluge programa lojalnosti, podsticaja i bonusa; oglašavanje u časopisima; usluge maloprodaje odjeće putem narudžbenice; reklamiranje slanjem narudžbenica; savjetodavne usluge u poslovnom upravljanju; pomoć u upravljanju; analiziranje i istraživanje tržišta; marketing; marketinška istraživanja; marketing; reklamiranje roba i usluga drugih dodelom vaučera; manekenske usluge u cilju reklamiranja ili prodajnih promocija; usluge praćenja štampe; iznajmljivanje kancelarijskih mašina i opreme; reklamiranje preko interneta; onlajn reklamiranje na računarskoj mreži; onlajn reklamiranje i reklamiranje putem elektronske pošte, uključujući razvoj i proizvodnju kampanja na društvenim mrežama i tehnika viralnog marketinga; onlajn marketing; usluge naručivanja preko interneta; ispitivanje javnog mnjenja; organizovanje programa lojalnosti potrošača u komercijalne, promotivne i reklamne svrhe; organizovanje izložbi i događaja za komercijalne ili reklamne potrebe; organizovanje izvlačenja nagrade za marketinške usluge; organizovanje promocija pomoću audio-vizuelnih medija; organizovanje sajмова za komercijalne ili reklamne potrebe; organizovanje, upravljanje i nadzor programa lojalnosti, podsticajnih programa, prodaje i promotivnih podsticajnih programa; organizovanje izložbi, događaja, postavki, sajмова i skupova za komercijalne ili reklamne potrebe; usluge podugovaranja, outsorsing [pomoć u poslovanju]; priprema platnih listi; konsultacije u vezi sa izborom osoblja; pronalaženje osoblja; usluge fotokopiranja; postavljanje reklama i promotivnih displeja na elektronske stranice kojima se pristupa putem računarskih mreža; planiranje reklamnih i marketinških strategija; prezentacija roba i usluga; prezentacija proizvoda putem sredstava komunikacije, u svrhu prodaje na malo; usluge poređenja cijena; usluge nabavke za druge [kupovina proizvoda i usluga za druge poslovne subjekte]; prezentacija robe i usluge prikazivanja proizvoda; pružanje informacija u vezi sa prodajom proizvoda; sastavljanje reklamnog sadržaja i reklama; promovisanje roba i usluga za druge; promovisanje robe i usluga drugih dijeljenjem vaučera, putem šeme nagrađivanja lojalnosti, putem programa kartica za popust, putem sprovođenja prodaje i promotivnih podsticajnih šema koje uključuju akcizne markice, dodjeljivanjem poena za upotrebu kreditne kartice pri kupovini, na promotivnim događajima, distribucijom štampanog materijala i putem promotivnih takmičenja; promovisanje prodaje usluga [u ime drugih] organizovanjem oglasa; promovisanje takmičenja i događaja, roba i usluga za druge, roba i usluga putem sponzorstva, posebnih događaja, sportskih takmičenja i događaja; promotivne usluge u vezi sa elektronskim sportskim (e-sports) događajima; promotivni menadžment za sportske ličnosti; promotivne usluge; omogućavanje pristupa onlajn reklamnom vodiču koji se može pretraživati a koji sadrži robu i usluge onlajn dobavljača; pružanje prostora za oglašavanje na veb sajtu; pružanje poslovnih informacija putem Interneta; pružanje komercijalnih informacija kupcima; pružanje informacija o proizvodima široke potrošnje preko interneta; pružanje informacija u vezi sa organizovanjem i sprovođenjem volonterskih programa i projekata kojima se rješavaju problemi zajednica; pružanje informacija o tržištu u vezi sa potrošačkim proizvodima; pružanje informacija o kupovini; pružanje i širenje poslovnih informacija, reklamnog materijala i materijala za oglašavanje koji se odnosi na izložbe, sajmove i postavke za poslovne potrebe; pružanje i širenje poslovnih informacija, pomoći i saveta učesnicima, posjetiocima i izlagačima na izložbama; pružanje i iznajmljivanje prostora, vremena i

medija za oglašavanje; obezbeđivanje onlajn tržišta za kupce i prodavce roba i usluga; pružanje informacija i saveta kupcima u vezi sa odabirom proizvoda i predmeta koji se kupuju; pružanje informacija i savjetodavnih usluga koje se odnose na elektronsku trgovinu; pružanje usluga poređenja cijena onlajn; usluge odnosa sa javnošću; objavljivanje reklamnih tekstova; oglašavanje; usluge za preseljenje poslovanja preduzeća; iznajmljivanje prostora za oglašavanje, vremena za oglašavanje na komunikacionim medijima, kancelarijskih mašina i opreme, mašina za fotokopiranje, automatskih mašina za prodaju; istraživanje za poslovne potrebe; usluge istraživanja koje se odnose na reklamiranje i marketing; usluge maloprodaje odjeće; usluge maloprodaje pripejd kartica drugih za upotrebu prilikom kupovine odjeće; usluge maloprodaje pripejd kartica drugih za upotrebu prilikom plaćanja usluga iz oblasti razonode; usluge uređenja izloga maloprodajnih prodavnica; promocija prodaje; reklamiranje prodaje za druge putem korisničkih kartica sa pogodnostima; promovisanje maloprodaje putem programa lojalnosti potrošača; usluge promotivne prodaje na terminalima za prodaju, za druge; sekretarske usluge; uređivanje izloga; traženje sponzorstva; pretplata na informativni medijski paket; sistematizacija informacija u kompjuterske baze podataka; usluge agencije za talente; obračun poreza; dogovaranje pretplate za usluge telekomunikacija za druge; usluge telemarketinga; usluge telefonskog odgovaranja za odsutne pretplatnike; reklamiranje preko televizije; usluge sajмова i izložbi za komercijalne potrebe; transkripcija; daktilografske usluge; ažuriranje oglasnih materijala; obrada teksta; pisanje reklamnih tekstova; usluge maloprodaje, onlajn maloprodaje, veleprodaje i maloprodaje putem pošte hemijskih proizvoda koji se upotrebljavaju u industriji, nauci, fotografiji, kao i u poljoprivredi, hortikulturi i šumarstvu, neprerađene veštačke smole, neprerađenih plastičnih materija, smješa za gašenje požara i za sprječavanje požara, preparata za kaljenje i zavarivanje, materija za štavljenje životinjske kože, ljepljivih supstanci koje se upotrebljavaju u industriji, gitova i drugih materija za punjenja u obliku paste, komposta, prirodnih đubriva, veštačkih đubriva, bioloških preparata za upotrebu u industriji i nauci; usluge maloprodaje, onlajn maloprodaje, veleprodaje i maloprodaje putem pošte boja, firnajza, lakova, sredstava za zaštitu od rđe i truljenja drveta, materija za bojenje, boja, mastila za štampanje, obilježavanje i graviranje, sirove prirodne smole, metala u obliku listova i prahova za slikanje, dekorisanje, štampanje i umjetnost, nagrizajućih sredstava, farbi, materija za bojenje, pigmenta i mastila, supstanci za bojenje, boje za hranu, farbe za hranu, tonera, napunjenih, za štampače i kopir aparate; usluge maloprodaje, onlajn maloprodaje, veleprodaje i maloprodaje putem pošte nemedicinske kozmetike i toaletnih preparata, nemedicinskih sredstava za čišćenje zuba, parfimerijskih proizvoda, etarskih ulja, sredstava za bjeljenje i drugih supstanci za upotrebu u perionicama, preparata za čišćenje, poliranje, ribanje i abrazivnih preparata, preparata za čišćenje tijela i njegu ljepote, kozmetike, toaletnih proizvoda, preparata za oralnu higijenu, parfimerije i mirisa, preparata za njegu životinja, aromatičnih ekstrakta; usluge maloprodaje, usluge onlajn maloprodaje, usluge veleprodaje i maloprodaje putem pošte u vezi sa prodajom mirisa za domaćinstvo, preparata za pranje, preparata za čišćenje i poliranje kože i cipela, preparata za čišćenje vozila, sapuna protiv znojenja, preparata protiv znojenja, preparata za veštačko tamnjenje kože, losiona za kupanje, soli za kupanje koje nijesu u medicinske svrhe, omekšivača brade, proizvoda za njegu ljepote, kozmetičkih maski; usluge maloprodaje, usluge onlajn maloprodaje, usluge veleprodaje i maloprodaje putem pošte u vezi sa prodajom preparata za izbjeljivanje i drugih supstanci za upotrebu u perionicama, preparata za čišćenje, poliranje, ribanje i abrazivnih preparata, proizvoda za njegu tela, pudera za tijelo, krema za čizme, preparata za poliranje čizama, sredstva za čišćenje ruku, preparata za čišćenje, sredstava za čišćenje, mleka za čišćenje za toaletnu upotrebu, sredstava za bojenje, kozmetičkih setova, kozmetičkih preparata za potamnjenje kože, kozmetike, krema; usluge maloprodaje, usluge onlajn maloprodaje, usluge veleprodaje i maloprodaje putem pošte u vezi sa prodajom sredstava za čišćenje zuba, dezodorantnih sapuna, dezodoransa, preparata za depilaciju, deterđženata, sapuna za dezinfekciju, boja (kozmetičkih), boja za bradu, kolonjskih voda, kartonskih turpija za nokte, šmirgl platna, šmirgl platna za srediavanje noktiju, šmirgl papira, eteričnih ulja, šminke za oči, kozmetike za obrve, olovaka za obrve, gelova za kosu, preparata za izbjeljivanje kose, proizvoda za njegu kose, boja za kosu; usluge maloprodaje, usluge onlajn maloprodaje, usluge veleprodaje i maloprodaje putem pošte u vezi sa prodajom boja za kosu, losiona za kosu, preparata za namještanje kose, sprejeva za kosu, preparata za kovrdžanje kose, preparata za njegu ruku, nemedicinskih balzama

za usne, losiona za kozmetičku upotrebu, šminke, pudera za šminkanje, preparata za šminkanje, preparata za uklanjanje šminke, medicinskih sapuna, preparata za hidrataciju, sredstava za ispiranje usta, preparata za njegu noktiju, laka za nokte, preparata za uklanjanje laka za nokte, sredstava za odstranjivanje laka za nokte; usluge maloprodaje, usluge onlajn maloprodaje, usluge veleprodaje i maloprodaje putem pošte u vezi sa prodajom nemedicinskih preparata za upotrebu poslije brijanja, nemedicinskih toaletnih preparata, ulja za tijelu, ulja za kozmetičku upotrebu, ulja za parfeme i mirise, parfimerije, parfema, preparata za njegu tijela, nemedicinskih preparata za osvježavanje daha, losiona za upotrebu prije brijanja i poslije brijanja, šampona, preparata za brijanje, sapuna za brijanje, kreme za cipele, sredstava za čišćenje obuće, voska za cipele; usluge maloprodaje, usluge onlajn maloprodaje, usluge veleprodaje i maloprodaje putem pošte u vezi sa prodajom preparata za tuširanje, proizvoda za njegu kože, preparata za njegu kože, sapuna, sredstava za uklanjanje fleka, preparata za tamnjenje kože, talk pudera, boja i losiona za kosu i bradu, maramica natopljenih kozmetičkim losionima, toaletnih artikala, toaletnih voda, toaletnih proizvoda, peškira koji sadrže nemedicinske toaletne preparate, preparata za pranje i kupatilo; usluge maloprodaje, usluge onlajn maloprodaje, usluge veleprodaje i maloprodaje putem pošte u vezi sa prodajom industrijskih ulja i masti, voska, maziva, jedinjenja za skupljanje, vlaženje i vezivanje prašine, goriva i materija za osvjetljavanje, svijeća i fitilja za osvjetljavanje, nehemijskih dodataka za goriva, vune kao goriva, svijeća za jelke, električne energije, masti za čizme, cipele i kožu, voska za osvjetljavanje, ulja za boje; usluge maloprodaje, usluge onlajn maloprodaje, usluge veleprodaje i maloprodaje putem pošte parfemisanih i mirisnih svijeća, preparata za vezivanje prašine za čišćenje, proširivača za uši, ulja za tekstil, farmaceutskih, medicinskih i veterinarskih preparata, sanitarnih preparata za upotrebu u medicini, dijetetske hrane i supstanci prilagođenih za upotrebu u medicini ili veterinarsku upotrebu, hrane za bebe, dijetetskih dodataka za ljude i životinje, flasteri, materijala za zavijanje, materijala za plombiranje zuba, zubarska smola; usluge maloprodaje, usluge onlajn maloprodaje, usluge veleprodaje i maloprodaje putem pošte dezinfekcionih sredstava, preparata za uništavanje životinjskih štetočina, fungicida, herbicida, flastera, ljepkova za proteze, preparata za osvježavanje vazduha, analgetika, antiseptik preparata, podloga za bakteriološke kulture, zavoja za previjanje, pojaseva za higijenske uloške, osvježivača vazduha za kola, ugljenih hidrata u tečnom obliku; usluge maloprodaje, usluge onlajn maloprodaje, usluge veleprodaje i maloprodaje putem pošte hemijskih provodnika za elektrokardiografske elektrode, hladnih krema za liječenje sportskih povreda, preparata za čišćenje kontaktnih sočiva, dijetetskih dodataka za ljude i životinje, dijetetskih napitaka prilagođenih za medicinsku upotrebu, dijetetske hrane i supstanci prilagođenih za medicinsku ili veterinarsku upotrebu, hrane za bebe, dijetetske hrane sa niskim sadržajem masti [prilagođenih za medicinsku upotrebu]; usluge maloprodaje, usluge onlajn maloprodaje, usluge veleprodaje i maloprodaje putem pošte dijetetske hrane prilagođene ljudima sa složenim metaboličkim bolestima za medicinsku upotrebu, dijetetskih supstanci prilagođenih za medicinsku potrebu, dijetetskih supstanci za medicinsku upotrebu u kontroli težine, sredstava za dezinfekciju za higijenske svrhe, kupki za pse, napitaka koji se uglavnom sastoje od minerala ili vitamina, lijekova za medicinsku upotrebu, napunjenih kutija i setova za prvu pomoć, dodataka ishrani; usluge maloprodaje, usluge onlajn maloprodaje, usluge veleprodaje i maloprodaje putem pošte hrane za ljude sa složenim metaboličkim bolestima, gaze za previjanje, preparata za dezinfekciju ruku, setova sa medicinskim preparatima, materijala za previjanje, napitaka koji zamjenjuju obroke i dijetetskih napitaka, obroka u prahu, medicinske hrane za sportiste, medicinske hrane za sportske tipove [vitamini ili minerali], medicinskih preparata i supstanci; usluge maloprodaje, usluge onlajn maloprodaje, usluge veleprodaje i maloprodaje putem pošte mineralnih i proteinskih preparata i supstanci, mineralnih napitaka [medicinskih], preparata za opuštanje mišića, naturopatskih i homeopatskih preparata i supstanci, hranljivih materija i sastojaka, dodataka ishrani i dijetetskih dodataka, kiseonika za medicinsku upotrebu, pesticida, farmaceutskih preparata i supstanci, biljnih jedinjenja i ekstrakta za upotrebu u vidu dijetetskih dodataka, gipsa; usluge maloprodaje, usluge onlajn maloprodaje, usluge veleprodaje i maloprodaje putem pošte koncentrata dijetetske hrane u prahu i dijetetskih supstanci za upotrebu u programima skidanja kilaže u medicinske svrhe, preparata za dijetetsku upotrebu, proteinske hrane za ljudsku ishranu [prilagođene za medicinske svrhe], proteinskih dodataka, radijuma za medicinsku upotrebu, preparata za sterilizaciju, vitaminskih stimulatora; usluge

maloprodaje, usluge onlajn maloprodaje, usluge veleprodaje i maloprodaje putem pošte traka za zavoje, vitamina, dijetetskih i mineralnih dodataka, vitaminskih napitaka, vitaminskih preparata, vitamina, voda [pića] za medicinsku upotrebu, običnih metala i njihovih legura, ruda, metalnih materijala za građevinarstvo i konstruisanje, metalnih prenosivih konstrukcija, neelektričnih kablova i žica od običnog metala, malih metalnih gvoždarskih proizvoda, metalnih kontejnera za skladištenje ili transport; usluge maloprodaje, usluge onlajn maloprodaje, usluge veleprodaje i maloprodaje putem pošte sefova, malih metalnih predmeta, neprerađenih ili polupreradenih običnih metala uključujući jednostavne proizvode koji se od njih prave, metalnih amblema za vozila, metalnih bedževa, prstenova za ključeve i privjesaka za ključeve, brava, ključeva, ukrasa, metalnih kanti, ključeva, praznih ključeva za obradu, znakova, statua, statueta i figura, umjetničkih djela od bronz, metalnih trofeja, kutija za novac; usluge maloprodaje, usluge onlajn maloprodaje, usluge veleprodaje i maloprodaje putem pošte kutija, trofeja, maketa od plemenitih metala, svi naprijed navedeni napravljeni od u potpunosti ili uglavnom od običnih metala, mašina, mašinskih alata, električnih alata, motora, osim za suvozemna vozila, mašinskih spojnice i transmisionih elemenata, osim za suvozemna vozila, poljoprivrednih sprava, osim ručnih alata koji se pokreću ručno, inkubatora za jaja, automatskih mašina za prodaju; usluge maloprodaje, usluge onlajn maloprodaje, usluge veleprodaje i maloprodaje putem pošte ručnih alata i sprava, kojima se ručno upravlja, pribora za jelo, hladnog oružja, brijaća, higijenskih sprava i sprava za njegu lepote za ljude i životinje, kojima se ručno upravlja, alata za podizanje, ručnih alata za hitne slučajeve i spasavanje, baštenskog alata kojim se ručno upravlja, makaza, gvozdrenih savijača, ručnih sprava za uvijanje kose, uvijača trepavica, pribora za manikiranje, spravica za sječenje noktiju, turpija za nokte, pribora za pedikiranje, makaza za orezivanje, pinceta, kliješta, sjekača pice; usluge maloprodaje, usluge onlajn maloprodaje, usluge veleprodaje i maloprodaje putem aparata i instrumenata naučnih, istraživačkih, pomorskih, geodetskih, fotografskih, kinematografskih, audio-vizuelnih, optičkih, za vaganje, mjerenje, signalizaciju, detekciju, testiranje, kontrolu (inspekciju), spasavanje i nastavu, aparata i instrumenata za provođenje, prekid, transformaciju, akumulaciju, regulisanje ili kontrolu distribucije ili upotrebe električne energije; usluge maloprodaje, usluge onlajn maloprodaje, usluge veleprodaje i maloprodaje putem pošte aparata i instrumenata za snimanje, prenos, reprodukovanje i obradu zvuka, slike ili podataka, snimljenih medija i onih koji se mogu preuzimati, računarskog softvera, praznih digitalnih ili analognih nosača podataka za snimanje i čuvanje podataka, mehanizama za aparate koji se pokreću novcem, registar kasa, računskih mašina, računara i računarskih perifernih uređaja, ronilačkih odijela, maski za ronjenje, čepova za uši za ronioce; usluge maloprodaje, usluge onlajn maloprodaje, usluge veleprodaje i maloprodaje putem pošte nosnih čepova za ronioce i plivače, rukavica za ronioce, aparata za disanje za podvodno plivanje, aparata za gašenje požara, štitnika za abdomen (za zaštitu od povrede ili nesreće), alarma, pojačala, antena, aparata i instrumenata za snimanje, prenos i reprodukovanje podataka i /ili slike, aparata za snimanje, prenos i reprodukovanje zvuka ili slike; usluge maloprodaje, usluge onlajn maloprodaje, usluge veleprodaje i maloprodaje putem pošte aparata za korišćenje uz kompjutere, audio i video traka i diskova, unaprijed snimljenih, audio aparata, audio snimaka, audio zvučnika, audio sistema, mašina sa automatskom reprodukcijom, torbi i futrola posebno prilagođenih za držanje ili nošenje portabl, mobilnih, ručnih kao i tablet uređaja i opreme i pribora za te uređaje, baterija, akumulatora, električnih, kutija za akumulator; usluge maloprodaje, usluge onlajn maloprodaje, usluge veleprodaje i maloprodaje putem pošte punjača za baterije, dvogleda, praznih i snimljenih kompakt diskova, diskova, ploča, traka i kaset, praznih kaset za snimanje audio i video sadržaja, zaštitnika za telo, knjiga snimljenih na disku, zaštitnika za grudi, kutija i stalaka prilagođenih za audio, video i televizijske aparate i instrumente, električnih kablova, računarskih mašina, kalkulatora, kamkordera, filmova za fotoaparate, objektivna za fotoaparate; usluge maloprodaje, usluge onlajn maloprodaje, usluge veleprodaje i maloprodaje putem pošte fotoaparata, kartica sa čipom sa integrisanim kolom, kartica sa kodiranim bezbednosnim karakteristikama u svrhu provjere autentičnosti, kartica koje koriste magnetnu memoriju i memoriju integrisanog kola, nosača mobilnih telefona, futrola za naočare za sunce, futrola za dvoglede, futrola za mobilne telefone, futrola za naočare i naočare za sunce, kaset dekova, cd plejera, cd radio kasetofona; usluge maloprodaje, usluge onlajn maloprodaje, usluge veleprodaje i maloprodaje putem pošte cd romova, celularnih telefona, lančića

i uzica za naočare i naočare za sunce, kinematografskih filmova, osvijetljenih, aparata za čišćenje diskova za snimanje zvuka, satova (aparata za beleženje vremena) i štoperica, odjeće za zaštitu od nesreća, radijacije i požara, mehanizama za aparate koji se pokreću novcem, kombinovanih video televizora, kompakt diskova, kompanijskih časopisa koji se preuzimaju putem interneta; usluge maloprodaje, usluge onlajn maloprodaje, usluge veleprodaje i maloprodaje putem pošte računarskog softvera, računarskog softvera za prenosive, mobilne, ručne i tablet uređaje, računarskog softvera koji se odnosi na ili koji sadrži igre, kazino igre, igre s kartama, kockanje ili klađenje, programa računarskih i video igara, softvera računarskih igara, računarskih igrice, hardvera za računarske igre, računarskog hardvera, računarskih perifernih uređaja, računarskih programa; usluge maloprodaje, usluge onlajn maloprodaje, usluge veleprodaje i maloprodaje putem pošte računarskog softvera, računarskih softver i hardver aparata sa multimedijalnim i interaktivnim funkcijama, računarskog softvera i računarskih programa koji se mogu preuzimati sa interneta ili koji se obezbjeđuju putem interneta, računarskog softvera i računarskih programa koji se odnose na ili koji sadrže igre, igre zasnovane na vještinama, kazino igre, igre s kartama, kockanje ili klađenje; usluge maloprodaje, usluge onlajn maloprodaje, usluge veleprodaje i maloprodaje putem pošte računarskog softvera za telekomunikaciju i komunikaciju putem lokalnih ili globalnih komunikacionih mreža, uključujući bežični internet, internet, intranet, ekstranet, televiziju, mobilne komunikacije, mobilne i satelitske mreže, računarske terminale, računare, kompjutere, laptop i prenosive računare, računare za igrice, električne provodnike, kutije za mikroskopska stakla; usluge maloprodaje, usluge onlajn maloprodaje, usluge veleprodaje i maloprodaje putem pošte upravljača i tastatura za grijanje, ventilaciju, klimatizaciju, osvjetljavanje i bezbjednost, brojača, nosača podataka sa integrisanim elektronskim čipovima, nosača podataka sa integrisanim mikroprocesorima, digitalnih audio traka, DVD diskova, diskova i traka za video igre, disk drajvera, diskova i traka za video igre, diskova sa video snimcima, aparata za ronioce; usluge maloprodaje, usluge onlajn maloprodaje, usluge veleprodaje i maloprodaje putem pošte softvera i programa za računare i video igrice koji se mogu preuzimati, softvera i programa za računarske i video igre koji se mogu preuzimati, elektronskih publikacija koje se mogu preuzimati, softvera i programa za interaktivne računarske i video igre, koji se mogu preuzimati, publikacija koje se mogu preuzimati, naime, kompanijskih časopisa koji se mogu preuzimati sa interneta; usluge maloprodaje, usluge onlajn maloprodaje, usluge veleprodaje i maloprodaje putem pošte softvera i programa za računarske i video igre virtualne stvarnosti, koji se mogu preuzimati sa interneta, čepova za uši, štitnika za laktove, štitova i štitnika, električnih aparata za čišćenje, električnih aparata za kovrdžanje kose, električnih instalacija za daljinsko upravljanje industrijskim procesima, električnih pegli, elektro-energetskih kablova, električnih mašina za poliranje cipela, električnih pribora za parno uvijanje kose; usluge maloprodaje, usluge onlajn maloprodaje, usluge veleprodaje i maloprodaje putem pošte crijeva za električne usisivače, električnih aparata i instrumenata, sve za kancelarijsku upotrebu, električnih kućnih aparata, elektrolizatora, aparata za elektrolizu za ličnu upotrebu za galvanostegiju, elektronskih biltena, elektronskih programa za računarske i video igre, elektronskog softvera za računarske i video igre, elektronskih igara; usluge maloprodaje, usluge onlajn maloprodaje, usluge veleprodaje i maloprodaje putem pošte elektronskih tabli sa porukama i elektronskih tabli sa informacijama, elektronskih publikacija koje se distribuiraju elektronskom poštom, kodiranih kartica i magnetnih dekodera, kodiranih kartica sa čipom na kojima su programi koji se koriste u finansijskim aplikacijama, programa lojalnosti, programa nagrađivanja i preferencija vlasnika kartica, produžnih kablova, produžnih gajtana, kutija za naočare, naočara; usluge maloprodaje, usluge onlajn maloprodaje, usluge veleprodaje i maloprodaje putem pošte optičarskih proizvoda, naočara sa dioptrijom, naočara za sunce, sportskih naočara i optičarskih proizvoda, naočara za plivanje, štitnika za lice, faksimil aparata i instrumenata, električnih ograda, filtera za respiratorne maske, fleksibilnih navlaka za kontrole električnih aparata, šlaufova za kupanje i plivanje, fluorescentnih ekrana, ramova i stakala za naočare i naočare za sunce, ramova za naočare; usluge maloprodaje, onlajn maloprodaje, veleprodaje i maloprodaje putem pošte uređaja za igrice koji su prilagođeni korišćenju sa televizijskim prijemnicima, softvera za igrice, naočara za skijanje, sportskih naočara, grafičkih ekvilajzera, uređaja za oblikovanje kose, uređaja za uvijanje kose, traka za čišćenje glava, slušalica, slušalica sa mikrofonom, kaciga (izuzev biciklističkih), držača prilagođenih za upotrebu sa mobilnim

telefonima, kartica sa hologramom, holograma; usluge maloprodaje, onlajn maloprodaje, veleprodaje i maloprodaje putem pošte programa za interaktivne računarske igre i video igre, softvera za interaktivne računarske igre i video igre, softvera za interaktivne elektronske računarske igre i video igre, programa i softvera za interaktivne multimedijalne računarske igre i video igre, komandnih ručica (džojstika) za upotrebu sa računarom, muzičkih automata koji se pokreću kovanicama (džuboksova), mašina za karaoke, jastučića, štitnika i steznika za koljeno, torbi za nošenje laptopova; usluge maloprodaje, onlajn maloprodaje, veleprodaje i maloprodaje putem pošte nalepnica za laptop, stakla za naočare, naočare za vid i naočare za sunce, pojaseva, prsluka i plutača za spasavanje, optičkih vlakna, vagica za prtljag, magnetnih nosioca podataka, diskova za snimanje, magnetna, uveličavajućih stakla [optička]; mjerača, mjernih instrumenata, mjernih traka, memorijskih kartica i USB flash memorija, mobilnih aplikacija koje sadrže softver i igrice za virtuelnu realnost; usluge maloprodaje, onlajn maloprodaje, veleprodaje i maloprodaje putem pošte navlaka za mobilne telefone, vrpce za mobilne telefone, mobilnih telefona, bežičnih telefona, mašina za brojanje i sortiranje novca, električnih aparata za praćenje, podloga za miš, štitnika za usta i desni, mp3 plejera i prenosivih i ručnih digitalnih elektronskih uređaja za snimanje, organizovanje, prenos, manipulaciju i pregled teksta, podataka, audio i video datoteka; usluge maloprodaje, onlajn maloprodaje, veleprodaje i maloprodaje putem pošte navigacionih aparata za vozila [putnih računara], štitnika za zube, kancelarijskih mašina, optičkih aparata i instrumenata, radio pejdžera, brojača koraka, periskopa, diskmena, vokmena, telefonskih uređaja, navlaka za telefone [posebno prilagođenih] i navlaka za prenosive i ručne digitalne elektronske uređaje, ploča, kasete i diskova za snimanje zvuka; usluge maloprodaje, onlajn maloprodaje, veleprodaje i maloprodaje putem pošte aparata i instrumenata za fotokopiranje, fotografskih aparata i instrumenata, štampanih kartica koje su obložene plastikom [kodiranih], utikača, utičnica i ostalih električnih priključaka, ručnih kalkulatora, prenosivih audio aparata i instrumenata, pripejd magnetnih kartica, tajmera koji se mogu programirati, zaštitnih uređaja za ličnu upotrebu u slučaju nesreće, zaštitne odjeće i opreme; usluge maloprodaje, onlajn maloprodaje, veleprodaje i maloprodaje putem pošte zaštitne odjeće za ronjenje, zaštitne odeće za učesnike u moto sportovima [za sprečavanje nezgoda], zaštitne odjeće, pokrivala za glavu i obuće za sport, zaštitnih naočara, naočara za sunce i zaštitnih naočara sa elastičnom trakom, zaštitnih kaciga, mašina za bušenje karata za kancelarije, radio kasetofona, radio prijemnika, radio aparata, radio aparata sa satom, gramofona, uređaja za daljinsko upravljanje; usluge maloprodaje, onlajn maloprodaje, veleprodaje i maloprodaje putem pošte zaštitnih odijela za preživljavanje, satelitskih navigacionih aparata, satelitskih tanjira i dekodera, vaga, sigurnosno kodiranih kartica, poluprovodnika, oblikovanih navlaka za kontrolne table od električnih aparata, zviždaljki za signalizaciju, kaciga za skejtbord, pametnih kartica, kodiranih magnetnih kartica, elektronskih kartica za podatke, kartica za naplatu, bankarskih kartica, kreditnih kartica, debitnih kartica, čipovanih kartica, poklon kartica, platnih kartica; usluge maloprodaje, onlajn maloprodaje, veleprodaje i maloprodaje putem pošte pripejd kartica, električno grijanih čarapa, zvučnih zapisa, zvučnika, multimedijalnih zvučnika, zvučnika za slušalice, kablova za zvučnike, stalka za naočare, sportskih naočara, sportskih optičarskih proizvoda, sportskih naočara sa elastičnom trakom, sportskih kaciga i vizira, aparata za provjeru poštanskih maraka, traka i futrola za optičarske proizvode i naočare za sunce, traka za naočare za sunce, naočara za sunce, odvodnika, naočara za plivanje, uređaja za reprodukciju audio traka; usluge maloprodaje, onlajn maloprodaje, veleprodaje i maloprodaje putem pošte magnetofona, kasete, diskova i disketa, snimljenih putem računarskih programa, telekom aparata (uključujući pripejd telefonskih i elektronskih vaučera za međunarodne pozive), telekomunikacijskih instalacija, aparata i instrumenata, telekomunikacijskih aparata (uključujući pripejd telefonskih i elektronskih vaučera za međunarodne pozive), telefonskih sekretarica, telefonskih aparata; usluge maloprodaje, onlajn maloprodaje, veleprodaje i maloprodaje putem pošte telefona, mobilnih telefona, bežičnih telefona, televizijskih antena, televizijskih aparata i instrumenata, televizora, televizora za prijem satelitskog emitovanja, tokena za aktiviranje električnih, elektronskih i telekomunikacionih aparata i instrumenata, transformatora, tjunera, gramofona, aparata i instrumenata za pisaće mašine, uređaja za digitalno skladištenje; usluge maloprodaje, onlajn maloprodaje, veleprodaje i maloprodaje putem pošte video aparata i instrumenata, video kamera, video disk plejera, softvera za video igre, video igara, mašina za

snimanje videa, programa za kompjuterske i video igrice sa virtuelnom stvarnošću, softvera za kompjuterske i video igrice sa virtuelnom stvarnošću, slušalica i kaciga za virtuelnu stvarnost, jedinica za video displeje, mašina za glasanje, prenosivih monitora za video prikazivanje, aparata i instrumenata za obradu teksta; usluge maloprodaje, onlajn maloprodaje, veleprodaje i maloprodaje putem pošte hirurških, medicinskih, stomatoloških i veterinarskih aparata i instrumenata, vještačkih udova, očiju i zuba, ortopedskih proizvoda, materijala za zašivanje, terapijskih i pomoćnih uređaja prilagođenih osobama sa hendikepom, aparata za masažu, aparata, uređaja i proizvoda za dojilje, zavoja, toplih i hladnih obloga za medicinske potrebe, stomatoloških maski za lice i stomatoloških rukavica; usluge maloprodaje, onlajn maloprodaje, veleprodaje i maloprodaje putem pošte elastičnih zavoja za udove i zglobove za medicinske potrebe, maski za lice za medicinsku upotrebu, štitinika za uši, neoprenskih proteza za udove i zglobove u medicinske svrhe, ortodontskih mašina i instrumenata za upotrebu u stomatologiji, protetskih instrumenata za upotrebu u stomatologiji, steznika za sport, suspenzionih zavoja za upotrebu u sportu; usluge maloprodaje, onlajn maloprodaje, veleprodaje i maloprodaje putem pošte aparata i instalacija za osvijetljavanje, zagrijavanje, proizvodnju pare, kuvanje, rashlađivanje, sušenje, ventilaciju, snadbijevanje vodom, sanitarnu upotrebu, aparata i instalacija za rashlađivanje, kamena lave za roštiljanje, instalacija za klimatizaciju, lampi za uvijanje kose, vrećica za sterilizaciju za jednokratnu upotrebu; usluge maloprodaje, onlajn maloprodaje, veleprodaje i maloprodaje putem pošte filtera za pijaću vodu, upaljača na gas, štapića za osvetljavanje, aparata i uređaja za sušenje kose, aparata za zagrijavanje, boca za toplu vodu, hidranata, lampi, instalacija za obradu nuklearnog goriva i nuklearnog omekšanog materijala, električnih radijatora, frižidera, proizvođača scenskog dima, WC daski, baklji za osvijetljavanje, lampi sa UV zracima, koje nisu za medicinsku upotrebu, instalacija za automatsko zalivanje; usluge maloprodaje, onlajn maloprodaje, veleprodaje i maloprodaje putem pošte vozila, aparata za kretanje po zemlji, vazduhu ili vodi, štitinika za automobilsko staklo i štitinika za sunce, proizvoda za sređivanje automobila, navlaka za automobilska sedišta, električnih vozila, drezina, opreme za popravku unutrašnjih guma, kolica za kupovinu, saonica, dodataka, komponenti i djelova za vozila koji su uključeni u ovu klasu, guma za točkove vozila [gume], dodataka, komponenti i delova za gume za točkove vozila; usluge maloprodaje, onlajn maloprodaje, veleprodaje i maloprodaje putem pošte vetrobrana, vatrenog oružja, municije i projektila, eksploziva, vatrometa, plemenitih metala i njihovih legura, nakita, dragog i polu-dragog kamenja, horoloških i hronometrijskih instrumenata, budilnika, znački od plemenitog metala, kutija, kutija od plemenitog metala, narukvica, kutija za satove i časovnike, kutija za izradu satova, lanaca od plemenitog metala, futrola za satove, kazaljki za satove, satova; usluge maloprodaje, onlajn maloprodaje, veleprodaje i maloprodaje putem pošte manžetni, kopči za kravate, igli za kravate, imitacije zlata, kutija za dragulje od plemenitog metala, nakita i zamjene za nakit, kutija za nakit, privjezaka za ključeve, kuhinjskih posuda od plemenitog metala, medalja, znački od plemenitih metala, prstenova za svijeće od plemenitog metala, klâtna za satove i časovnike, ukrasa od plemenitih metala, prstenova kao nakita, sportskih satova, instrumenata za mjerenje vremena; usluge maloprodaje, onlajn maloprodaje, veleprodaje i maloprodaje putem pošte bižuterije, trofeja, kopči za kaiševe, sve navedeno od plemenitog metala ili presvučeno njime, kaiševa za satove, traka za satove, satova, ručnih satova, muzičkih instrumenata, muzičkih postolja i postolja za muzičke instrumente, dirigentskih palica, papira i kartona, štampanih stvari, knjigovezačkog materijala, fotografija, kancelarijskog materijala i rekvizita, izuzev namještaja; usluge maloprodaje, onlajn maloprodaje, veleprodaje i maloprodaje putem pošte lepka za kancelarijsku ili upotrebu u domaćinstvu, materijala za crtanje i materijala za umjetnike, slikarskih četkica, materijala za obuku i obrazovnog materijala, plastičnih tabaka, folije i vrećica za umotavanje i pakovanje, klišea, štamparskih blokova, lijepka za kancelarijsku upotrebu, nosača ljepljivih traka [kancelarijskih], ljepkova za kancelarijsku upotrebu i upotrebu u domaćinstvu, agendi, albuma; usluge maloprodaje, onlajn maloprodaje, veleprodaje i maloprodaje putem pošte arhitektonskih modela, materijala za umetnike, torbi [kovrte, kese] od papira ili plastike za pakovanje, blok bilježnica, knjigovezačkog materijala, knjiga, magazina [periodičnih], brošura, letaka i drugih štampanih publikacija, brošura, kalendara, karata od plastike [izuzev kodiranih ili magnetnih], futrola za pera, futrola za kancelarijski pribor, kataloga, brojanica, kompasu; usluge maloprodaje, onlajn maloprodaje, veleprodaje i maloprodaje putem pošte sprava

za prenos dizajna sa papira na staklo ili porcelan, stonih bilježnica, dnevnika, dokumentacije [kancelarijske], tabli za crtanje, instrumenata za crtanje, gumica za brisanje, programa za događaje, flomastera, poklon kartica, poklon vaučera, lijepka u tubama, razglednica, papirnih maramica, markera, indeksnih knjiga za evidentiranje informacija u vezi sa fitnes treninzima, penkala, mastila za hemijske olovke; usluge maloprodaje, onlajn maloprodaje, veleprodaje i maloprodaje putem pošte materijala za obuku i obrazovnog materijala (izuzev aparata), oznaka za prtljag koje nijesu od kože, magazina, markera (pisaći pribor), biltena, bilježnica, blokova za bilješke, zvaničnih programa [štampani materijal], slikarskih četkica, papira, kartona i proizvoda od ovih materijala, koji nisu uključeni u druge klase, pastela [kreda u boji], futrola za olovke, rezača za olovke, olovaka, hemijskih olovaka; usluge maloprodaje, onlajn maloprodaje, veleprodaje i maloprodaje putem pošte periodičnih publikacija [štampani materijal], fotografija, plastičnih folije za umotavanje, plastičnih materijala za pakovanje (koji nisu uključeni u druge klase), postera, štampanih agendi, štampanog materijala, štampanih publikacija, štampanih ulaznica, klišeja, štampanih blokova, stikera, tetovaža koje se mogu uklanjati, lenjira, torbi za kupovinu od plastike, suvenirskog programa, marki [pečati], heftalica; usluge maloprodaje, onlajn maloprodaje, veleprodaje i maloprodaje putem pošte spajalica, kancelarijskog pribora, matrica, maramica, pisaaćih mašina i kancelarijskog pribora (izuzev nameštaja), zidnih karti koje se koriste kao dnevnicima, zidnih tabli koje se koriste kao dnevnicima, bijelih tabli, neprerađenih i polu-prerađenih guma, gutaperki, smole, azbesta, liskuna i zamjena za sve ove materijale, plastike i smole u ekstrudiranom obliku za upotrebu u proizvodnji; usluge maloprodaje, onlajn maloprodaje, veleprodaje i maloprodaje putem pošte ambalaže, materijala za zatvaranje i izolaciju, fleksibilnih cijevi, vodova i crijeva, koji nijesu od metala, kože i zamjene za kožu, životinjske kože i krzna, prtljaga i torbi za nošenje, kišobrana i suncobrana, štapova za hodanje, bičeva, saračke i sedlarske opreme, ogrlica, povodaca i odjeće za životinje, umjetničkih portfelja [futrola], dodataka za prtljag, atletskih torbi, akten tašni; usluge maloprodaje, onlajn maloprodaje, veleprodaje i maloprodaje putem pošte nosiljki za bebe i djecu, ranaca, prtljaga, torbi, torbi za putnički pribor, torbi za plažu, torbi za kaiševe, kaiševa, kaiševa napravljenih od zamjene za kožu, kaiševa napravljenih od kože, novčanika, torbi za čizme, aktovki, futrola za vizit karte, vreća za kampovanje, štapova od trske, futrola za kartice, držača za kartice, držača za čekovne knjižice, ručnog prtljaga, kutija, futrola za mobilne telefone; usluge maloprodaje, onlajn maloprodaje, veleprodaje i maloprodaje putem pošte futrola, malih ručnih torbi, torbi za kozmetiku, futrola za kreditne kartice, držača za kreditne kartice, torbi za pelene, futrola za dokumenta, velikih torbi, torbi za noćni izlazak, kopči i traka od kože, proizvoda u obliku ruksaka za nošenje beba, ramova za ručne torbe, ramova za kišobrane, putnih torbi za odjeću, sjedala za kišobrane za golf, kišobrana za golf, torbi za teretanu, ručnih torbi, saračke robe, ranaca; usluge maloprodaje, onlajn maloprodaje, veleprodaje i maloprodaje putem pošte kožnog krzna, torbica koje se nose na kukovima, velikih putnih torbi, prekrivača za konje, uzdi za konje, užadi za konje i konjičke opreme, futrola za ključeve, privjezaka za ključeve napravljenih od kože sa prstenovima za ključeve, privjezaka za ključeve napravljenih od kože koji se sastoje od prstenova za ključeve, držača za ključeve, vrećica za ključeve, naprtnjača, kožnih pertli, povodaca (od kože), proizvoda od kože koji uključuju užad za konje i konjičku opremu, kožne galanterije [navlake], prtljaga, oznaka za prtljag; usluge maloprodaje, onlajn maloprodaje, veleprodaje i maloprodaje putem pošte remenja za prtljag, torbi za noćenje, prtljaga za noćenje, torbi od sepeta, suncobrana, džepnih knjiga, džepnih novčanika, galanterije, vrećica, tašni, torbi, torbi za snimanje, sedla za jahanje, jahaćkih sedala, ruksaka, sedlarske robe, školskih tašni, školskih torbi, ruksaka za decu školskog uzrasta, torbi za obuču, torbi za kupovinu, kolica za kupovinu [torbe za kupovinu na točkovima], torbi za nošenje o ramenu, kože i krzna, torbi za sport, sportskih torbi; usluge maloprodaje, onlajn maloprodaje, veleprodaje i maloprodaje putem pošte kaiševa za klizaljke, kofera, nesesera za toaletne proizvode, cegera, torbi za putovanja, kutija za putovanja, sanduka za putovanja, sanduka, kišobrana sa sedištem, kišobrana, torbi za nošenje oko struka, ruksaka za nošenje oko struka, vrećica za torbe koje se nose oko struka, vrećica za rančeve koji se nose oko struka, štapova za hodanje, novčanika, novčanika kao dodataka kaiševima, bičeva, tabli za upotrebu u vidu dnevnika, bijelih tabli; usluge maloprodaje, onlajn maloprodaje, veleprodaje i maloprodaje putem pošte materijala za građenje i konstruisanje, koji nijesu od metala, krutih građevinskih cevi, koje nijesu od metala, asfalta, smole, katrana i bitumena, prenosivih građevina, koje nijesu od

metala, spomenika, koji nijesu od metala, namještaja, ogledala, ramova za slike, kontejnera, koji nijesu od metala, za skladištenje ili transport, neprerađene ili polupreradene kosti, roga, kitove kosti ili sedefa; usluge maloprodaje, onlajn maloprodaje, veleprodaje i maloprodaje putem pošte školjki, morske pjene, žutog ćilibara, posteljine [izuzev pokrivača], ležajeva za kućne ljubimce, narukvica za upotrebu u bolnici, koje nijesu od metala (za identifikaciju), spona za cijevi ili kablove od plastike, namještaja za kampovanje, čiviluka za odjeću, alki za zavjese, dekoracija od plastike za namirnice, oglasnih tabli, dušeka od pjene za kampovanje, opreme za namještaj, koja nije od metala; usluge maloprodaje, onlajn maloprodaje, veleprodaje i maloprodaje putem pošte korpi za rublje sa poklopcem [korpe], naduvanih jastuka za oko vrata [koji nisu za medicinsku upotrebu], krojačkih lutki, jastuka, vreća za spavanje, pribora i posuđa za upotrebu u domaćinstvu ili kuhinji, posuđa i stonog posuđa, izuzev viljuški, noževa i kašika, češljeva i sunđera, četki, izuzev četkica za slikanje, materijala za pravljenje četki, proizvoda za čišćenje; usluge maloprodaje, onlajn maloprodaje, veleprodaje i maloprodaje putem pošte neprerađenog ili polupreradjenog stakla, izuzev građevinskog stakla, staklarije, porcelana i grnčarije, korpi za domaćinstvo, krigli za pivo, zdjela i posuđa, četkarske robe, gorionika, držača za svijeće, prstenova za svijeće od plemenitog metala, svjećnjaka, ornamenata od porcelana, instrumenata za čišćenje [ručni], miksera za koktele, ne-električnih džezvi, posuda za domaćinstvo; usluge maloprodaje, onlajn maloprodaje, veleprodaje i maloprodaje putem pošte kutija za domaćinstvo sve od plemenitog metala, posuda za hranu, kutija za čuvanje za upotrebu u domaćinstvu, posuda za kuvanje, torbi za rashlađivanje, rashladnih torbi za mamce za ribolov, kozmetičkih kutija, manjih posuda, dekorativnih proizvoda od stakla, dekorativnog porcelana, posuđa od porcelana, grnčarije i porcelana, boca za piće, slamki za piće, posuda za piće, figurina, stalaka za pegle, vazi za cvijeće, sklopivih boca za piće; usluge maloprodaje, onlajn maloprodaje, veleprodaje i maloprodaje putem pošte aparata za ekstrakciju voćnog soka (ručni), poklon proizvoda i umetničkih dela napravljenih od kosti, porcelana, porcelanskog kristala, grnčarije, stakla, porcelana ili terakote, neprerađenog ili polu-prerađenog stakla [izuzev građevinskog stakla], posuda i kutija za upotrebu u domaćinstvu ili kuhinji, kofa za led, zamki za insekte, krčaga i posuda za piće, lonaca, pribora i posuda za upotrebu u domaćinstvu i kuhinji, kutija za hranu; usluge maloprodaje, onlajn maloprodaje, veleprodaje i maloprodaje putem pošte malih figura, neelektričnih miksera za miješanje pića, ručnih miksera [za koktele], krigli, neelektričnih instrumenata i materijala za čišćenje, ukrasa, izletničkih korpi zajedno sa posuđem, uključujući sudove, tanjire, posuđe od porcelana, višekratne slamke za piće, višekratne slamke, tacne od plemenitog metala, boce za miješanje, boce za sport, čeličnu vunu za čišćenje, posude za čuvanje hrane; usluge maloprodaje, onlajn maloprodaje, veleprodaje i maloprodaje putem pošte posuda za čuvanje hrane za upotrebu u domaćinstvu, slamki, vrčeva i krigli, toplotno izolovanih torbi za upotrebu u domaćinstvu ili kuhinji ili za upotrebu u transportu i za čuvanje hrane i pića, termalno izolovanih posuda za čuvanje hrane, termalno izolovanih čutura za upotrebu u domaćinstvu, četkica za zube, čačkalica za zube, poslužavnika za domaćinstvo, kutija za bižuteriju, vaza i urni, boca za vodu, kanti za zalivanje, proizvoda za baštovanstvo, umetničkih djela; usluge maloprodaje, onlajn maloprodaje, veleprodaje i maloprodaje putem pošte užadi i traka, mreža, šatora i cirada, nadstrešnica od tekstila ili sintetičkih materijala, jedara, džakova za transport i skladištenje materijala bez ambalaže (u rinfuzi), materijala za postavljanje, tapaciranje i punjenje, izuzev papira, kartona, gume ili plastike, prekrivača na meru, sirovih vlaknastih tekstilnih materijala i njihovih zamena, uvoštenog platna, prekrivača za kamuflažu; usluge maloprodaje, onlajn maloprodaje, veleprodaje i maloprodaje putem pošte prediva i konca za tekstilnu upotrebu, prediva i konca od pamuka, prediva i konca za šivenje, prediva i konca od svile, prediva i konca od vune, predenog pamuka, svile i vune, tekstila i zamene za tekstil, tkanina za domaćinstvo, zavjesa od tekstila ili plastike, zastava, platna za kupatilo, kreveta i stolnjaka, presvlaka za krevete, navlaka za krevete, posteljine, pokrivača za krevet, zastora, podmetača, presvlaka za toaletne daske od tkanine; usluge maloprodaje, onlajn maloprodaje, veleprodaje i maloprodaje putem pošte prekrivača za jastuke, držača za zavese, zavesa, pokrivača za jastuke, navlaka za jorgane, jorgana, prekrivača za krevete od perja, peškira za lice, flanela, prekrivača za nameštaj, maramica, peškira za kuhinju, materijala za platna i tapaciranje, marabe [tkanina], salveta, tekstilnog materijala koji nije od vune, jastučnica, navlaka za jastuke, tekstilnih prekrivača za štampače, prekrivača za kiltove, kiltova, prostirki, čaršava; usluge maloprodaje, onlajn maloprodaje,

veleprodaje i maloprodaje putem pošte zavjesa za tuširanje, zastora, vreća za spavanje, stolnjaka, prekrivača za stolove, navlaka za stolove, tkanina za stolove, podmetača za stolove, salveta za stolove, kuhinjskih krpa, zastora za zavjese od tekstila, proizvoda od tekstila, materijala od tekstila, tekstila za izradu odeće, peškira, peškira od tekstila, prekrivača za putovanja, prekrivača za putovanja (za krilo), vlakana za tapaciranje, tapiserija (zidnih) od tekstila, rukavica za pranje bez prstiju, traka od bijelog platna; usluge maloprodaje, onlajn maloprodaje, veleprodaje i maloprodaje putem pošte odeće, obuće, pokrivala za glavu, sportskih jakni s kapuljačom [parke], traka za oko ruke [odeća], fantomki, kaiševa [odeća], kaiševa od zamjene za kožu, kaiševa od kože, čizama, kapuljača, kapa (za tuširanje), kapa [pokrivala za glavu], sveštenečkih odijela za bogoslužjenja, kaputa, haljina, odjeće za vežbanje, modne odjeće, jakni, čizama i prsluka za ribolov, radnih bluza, fudbalskih čizama, fudbalskih majica, dokoljenica, rukavica, šešira, čarapa i pletene trikotaže; usluge maloprodaje, onlajn maloprodaje, veleprodaje i maloprodaje putem pošte jakni, odjeće od teksas platna, ležerne odjeće, odjeće za slobodno vreme, lagane odjeće, naručnika (sveštenečka odjeća), kravata, zaštitne odjeće za surfovanje, džempera, replika fudbalskih kompleta, zaštitne odjeće, rukavica, pokrivala za glavu i obuće (izuzev za zaštitu od nesreća i povreda), kombinezona, ešarpi za nošenje, šalova i marama, košulja, cipela, odeće za skijanje, maski za spavanje, odjeće za spavanje, radnih bluza i odela, čarapa; usluge maloprodaje, onlajn maloprodaje, veleprodaje i maloprodaje putem pošte u vezi sa prodajom sportske robe (odjeće) za konjički sport, sportske konjičke opreme [odjeća], sportske odjeće, odjeće za sport, sportskih pokrivala za glavu (izuzev šlemova), sportske obuće, čizama za šetanju, sportskih uniformi, sportske odjeće, krampona za fudbalske kopačke, čizme [obuća], šorceva za surfovanje, kupaćih kostima, termo odjeće, patika, pantalona, majica, donjeg veša; usluge maloprodaje, onlajn maloprodaje, veleprodaje i maloprodaje putem pošte prsluka, čizama za šetanje, odjeće otporne na vodu i vremenske uslove, vodootporne odjeće, odjeće otporne na vremenske uslove, gumirane odjeće, kaluđeričkih velova, manžetni košulja [odjeća], čipke, vrpce i veza, traka i mašni za galanteriju, dugmadi, kopči i zakački, špenadli i igala, veštačkog cvijeća, ukrasa za kosu, veštačke kose, kutija za igle, broševa (djelovi odjeće), kopči (za odjevne predmete); usluge maloprodaje, onlajn maloprodaje, veleprodaje i maloprodaje putem pošte kopči za odeću, kopči za kosu, ukrasa za kosu, traka za kosu, igala za pletenje, jastučića za igle i špenadle, ukrasnih noviteta, znački, kopči i broševa, pertli za cipele, takmičarskih brojeva, rajsfeslusa, dodataka za odeću, proizvoda za šivenje i dekorativnih tekstilnih proizvoda, tepiha, prostirki, otirača i asura, linoleuma i drugih materijala za prekrivanje postojećih podova; usluge maloprodaje, onlajn maloprodaje, veleprodaje i maloprodaje putem pošte zidnih tapiserija, koje nisu od tekstila, veštačke trske, tapeta, prostirki za automobile, prostirki, veštačkih prekrivača terena, prekrivača za zidove i plafone, prostirki za jogu, igri, igrački i predmeta za igru, aparata za video igrice, gimnastičkih i sportskih proizvoda, ukrasa za božićnu jelku, aparata za boks, aparata za igranje igara sposobnosti, aparata za igranje sportskih igara, aparata za skijanje; usluge maloprodaje, onlajn maloprodaje, veleprodaje i maloprodaje putem pošte aparata za fudbalske igrice, streličarskog pribora, veštačkih božićnih jelki i postolja za božićnu jelku, triktrak igri - dama igri, torbi prilagođenih za nošenje sportskih artikala, torbi specijalno dizajniranih za skije i daske za skijanje, torbi specijalno prilagođenih sportskoj opremi, balona, lopti, lopti kao sportskih artikala, lopti za igru; usluge maloprodaje, onlajn maloprodaje, veleprodaje i maloprodaje putem pošte lopti za upotrebu u sportu, lopti posebno lopti za tenis, reketa za tenis, reketa za skvoš i njima srodne robe i dodataka iz ove klase, maski za bejzbol, štapova za navijački tim, štapova, sportskih štapova, palica za sport, igri na tablama, štitnika za telo, aparata (oprema) za bodi bilding, bodi bilding aparata, sportskih proizvoda za upotrebu u igrama sa reketima; usluge maloprodaje, onlajn maloprodaje, veleprodaje i maloprodaje putem pošte aparata za bodi bilding/aparata za vježbanje tela/aparata za rehabilitaciju tela, štitnika za grudi, kamuflaža ekrana [sportski artikli], igara sa kartama, torbi prilagođenih sportskim aparatima, igara dame, šaha, božićnih dekoracija, postolja za božićnu jelku, božićnih jelki od sintetičkih materijala, opreme za igrice na sreću, koje se pokreću metalnim novcem, kompjuterskih igrica, konfeta; usluge maloprodaje, onlajn maloprodaje, veleprodaje i maloprodaje putem pošte torbi za kriket, strelica za pikado, pikada, štitnika za zglobove (sportski artikli), elektronskih igara, opreme za vježbanje, jahaonica / sajamskih aparata za vožnju, udica za ribolov, aparata i opreme za ribolov, pribora za pecanje, štitnika za pesnicu [sportski artikli], opreme za fitness,

mašina za fitnes, rukavica za fudbal, golova za fudbal i američki fudbal, žetona za igre, igara; usluge maloprodaje, onlajn maloprodaje, veleprodaje i maloprodaje putem pošte igara prilagođenih za upotrebu s televizijskim prijemnicima, aparata za igre, igara povezanih s veštinama, igara povezanih sa sportom, rukavica za sportsku upotrebu [specijalno prilagođenim], mreža za gol, stativa, torbi za golf sa ili bez točkova, prostirki za golf, artikala i aparata za gimnastiku i sport, sprava za vežbanje ruku, sprava za ručno vežbanje [izuzev za terapeutske svrhe]; usluge maloprodaje, onlajn maloprodaje, veleprodaje i maloprodaje putem pošte ručnih elektronskih igrice, štitnika za ruke prilagođenih za upotrebu u sportu, ručnih i prenosivih uređaja za igranje igrice, štitnika za kukove specijalno napravljenih za sport [djelovi sportskih odela], robe koja se naduvava u obliku lopti za američki fudbal, fudbal, košarku, odbojku, lopti za naduvavanje za sport, koturaljki sa točkicama u nizu, puzli, kaleidoskopa, štitnika za kolena [sportski artikli]; usluge maloprodaje, onlajn maloprodaje, veleprodaje i maloprodaje putem pošte štitnika za kolena prilagođenih za upotrebu prilikom igranja sporta, štitnika za kolena prilagođenih za upotrebu prilikom učestvovanja u sportu, štitnika za noge prilagođenim za igranje sporta, štitnika za noge za sport, štitnika za potkolenicu [sportski artikli], vojnih figurica [igračke], noviteta, noviteta za zabave, plesove [poklončići], bazena za decu, papirnih šešira za zabavu, djelova i opreme za skijaške aparate; usluge maloprodaje, onlajn maloprodaje, veleprodaje i maloprodaje putem pošte djelova i opreme za igre i predmete za igranje, djelova i opreme za gore navedenu robu, mašina za fizičke vježbe, plastičnih gusenica, šatora za igranje, opreme za igralište, karata za igranje, predmeta za igranje, rolera, daski za jedrenje, kartica za grebanje za igre na sreću, štitnika za potkoljenicu za upotrebu u atletici, štitnika za potkoljenicu [sportski artikli], skejtbordova, daski za surfovanje, daski za skijanje, skija, klizaljki; usluge maloprodaje, onlajn maloprodaje, veleprodaje i maloprodaje putem pošte igara sposobnosti, žetona za igre sposobnosti, opreme za igrice sposobnosti, loptica i štapova za snuker, stolova za snuker, lopti, golova, mreže za američki fudbal, plišanah igračaka, suvenira, sportskih artikala; usluge maloprodaje, onlajn maloprodaje, veleprodaje i maloprodaje putem pošte sportskih artikala za boks, gimnastiku, atletiku u dvoranama i na otvorenom, i za igranje badmintona, skvoša, hokeja, hokeja na ledu, fudbala, lakrosa, petica, stonog tenisa, netbola, kuglanja, tenisa na travi, kriketa, kroketa, golfa koji se igra na terenu u obliku časovnika (clock golf), golfa, igara nabacivanja alki, disk golfa i mini golfa, vaterpola, kuglanja, odbojke, sportova sličnih hokeju, sportova koji uključuju upotrebu lopte; usluge maloprodaje, onlajn maloprodaje, veleprodaje i maloprodaje putem pošte štapova za golf i polo, sportskih artikala za igranje fudbala [izuzev odeće ili artikala za zaštitu], golova za fudbal i američki fudbal, sportskih artikala za upotrebu u igrama sa reketima, sportskih dodataka za odijela prilagođena posebnim sportovima; usluge maloprodaje, onlajn maloprodaje, veleprodaje i maloprodaje putem pošte sportskih artikala posebno artikala i opreme za igru tenisa, skvoša, stonog tenisa, softbola, golfa, badmintona, odbojke, košarke, bejzbola, hokeja na ledu i hokeja, sportskih torbi, sportske opreme i dodataka, sportskih rukavica, statičnog bicikla za vežbanje, štitnika za stomak [prilagođeni za upotrebu u specifičnom sportu], žica za sportske rekete; usluge maloprodaje, onlajn maloprodaje, veleprodaje i maloprodaje putem pošte znojnica za rekete, bazena za plivanje [artikli za igranje], mreža i stubova za tenis, termo izolovanih torbi za tenis, bicikala igrački, štapića sa sjajem za igranje, minijturnih igračaka, vještačkih božićnih jelki i postolja za božićne jelke, kamiona igračaka, igračaka i igri, mašina za obuku fudbala, pištaljki, štitnika za ručni zglob za upotrebu u atletici; usluge maloprodaje, onlajn maloprodaje, veleprodaje i maloprodaje putem pošte mesa, ribe, živine i divljači, ekstrakta od mesa, konzerviranog, zaleđenog, sušenog i kuvanog voća i povrća, želea, džemova, kompota, jaja, mlijeka, sira, maslaca, jogurta i drugih mliječnih proizvoda, ulja i masti za hranu, listića od krompira, gotovih jela, proteinskih preparata u obliku štanglica za ljudsku upotrebu, štanglica za užinu [prehrambeni proizvodi]; usluge maloprodaje, onlajn maloprodaje, veleprodaje i maloprodaje putem pošte kafe, čaja, kakaa i zamjene za kafu, pirinča, testenine i knedli, tapioke i saga, brašna i preparata napravljenih od žitarica, hleba, kolača i poslastica, čokolade, sladoleda, sorbea i drugog jestivog leda, šećera, meda, melase, kvasca, praška za pecivo, soli, dodataka za jelo, začina, konzerviranog bilja, sirćeta, soseva i drugih umaka, leđa (zaleđena voda); usluge maloprodaje, onlajn maloprodaje, veleprodaje i maloprodaje putem pošte napitaka napravljenih od žitarica, biskvita, hleba, kolača i poslastica, kolačića, preparata od žitarica, napitaka na bazi čokolade, čokoladnih napitaka sa mlijekom, napitaka od kafe sa mlijekom,

aroma kafe, konditorskih proizvoda za ukrašavanje božićne jelke, kolačića, derivata kukuruznog skroba u obliku praha za pravljenje pića, jestivih ukrasa za kolače; usluge maloprodaje, onlajn maloprodaje, veleprodaje i maloprodaje putem pošte jestivog leda, energetskih štanglica, aroma za napitke [uzuzev eteričnih ulja], fondana, ledenih šerbeta, ledenog sorbea, leda, instant praška za pravljenje aromatičnih pića, kečapa, pita od mesa, senfa, nemedicinskih dodataka napicima, gaziranih napitaka na bazi kafe, kakaa ili čokolade, kolača, pita, pica, kokica, praška za pravljenje napitaka; usluge maloprodaje, onlajn maloprodaje, veleprodaje i maloprodaje putem pošte preparata za upotrebu kao dijetetskih aditiva za sportiste, preparata za ishranu napravljenih od žitarica, proteinskih štanglica od žitarica, proteinskih štanglica za užinu, pudinga, sendviča, umaka, štanglica za užinu (konditorski proizvodi), zalogajčića, tartova, napitaka na bazi čaja, čaja, vafila, izbjeljivača napitaka (koji nisu mlečni); usluge maloprodaje, onlajn maloprodaje, veleprodaje i maloprodaje putem pošte sirovih i neprerađenih poljoprivrednih, akvakulturalnih, hortikulturalnih i šumskih proizvoda, sirovog i neprerađenog zrnevlja i sjemenja, svežeg voća i povrća, svežeg bilja, prirodnog bilja i cvijeća, lukovica, mladica i sjemenja za sadnju, živih životinja, hrane i pića za životinje, slada, piva, bezalkoholnih napitaka, mineralnih i gaziranih voda, voćnih napitaka i voćnih sokova; usluge maloprodaje, onlajn maloprodaje, veleprodaje i maloprodaje putem pošte sirupa i drugih bezalkoholnih preparata za pravljenje napitaka, piva, napitaka kao pomoć mršavljenju [ne za medicinsku upotrebu], slatkih alkoholnih pića, energetskih pića, energetskih pića koja sadrže kofein, energetskih pića za sportiste i takmičare, aromatičnih gaziranih napitaka, voćnih pića i voćnih sokova, izotoničnih napitaka [ne za medicinsku upotrebu]; usluge maloprodaje, onlajn maloprodaje, veleprodaje i maloprodaje putem pošte mineralnih i gaziranih voda i drugih bezalkoholnih pića, preparata za pravljenje bezalkoholnih pića, alkoholnih gaziranih pića [piće], piva sa ukusom limuna ili limete, sorbea [piće], sportskih napitaka, sirupa i drugih preparata za pravljenje napitaka, biljnih napitaka [nemedicinski napici i drugi koji nisu na bazi čaja], vode, alkoholnih pića, osim piva, alkoholnih preparata za pravljenje napitaka; usluge maloprodaje, onlajn maloprodaje, veleprodaje i maloprodaje putem pošte duvana i zamena za duvan, cigareta i cigara, elektronskih cigareta i oralnih sprejeva za pušače, artikala za pušače, šibica; informativne, savjetodavne i konsultantske usluge u vezi sa gore navedenim.

(210) **Ž-2020-386**

(220) 29.10.2020.

(731) Zhengzhou Yutong Group Co., Ltd., No.8 Changchun Road, Hi-tech Industrial Park, Zhengzhou, CN

(540)

宇通

(550) I

(740) Božidar S.Radulović, Baku 30/5, 81000, Podgorica

(511) Klasa 7: Mašine za bušenje, mešači, valjci [mašine], parni valjci, mašine za mešanje, mašine za izbeljivanje, mašine za mešanje, mašine za mešanje betona, mašine za pravljenje bitumena, buldožeri, kopači, mehanički, bageri, mašine za katranisanje, mašine za postavljanje šina, mašine za pravljenje puteva, mašine za izradu šina, kopači [mašine], hidraulični klipovi [mašine], mašine za pomeranje zemlje, plugovi za kopanje rovova, lopate, mehaničke, mašine i mašinerija koje se koriste u zemljanim radovima u oblasti građevinarstva, mostova i puteva, vibratori za beton, mašine za utovar i istovar, teretne dizalice, kranovi [aparati za podizanje], starteri za motore, klipovi prigušivača [delovi mašina], amortizeri za mašine, mašine za čišćenje puteva, samohodne, pulverizatori

otpadnih voda, aparati za pranje, instalacije za pranje vozila, mašine i aparati za čišćenje, električni, drobilice otpada [mašine], drobilice i prese za otpad, drobilice i prese za đubre, mašine za presovanje đubreta, mašine za presovanje otpada, bageri za vodu; mašine za sortiranje za industriju.

(210) **Ž-2020-387**

(220) 29.10.2020.

(731) DOO "BOŽUR" EKSPORT - IMPORT PODGORICA , Ul. Mitra Bakića 14, Podgorica, ME

(540)



(550) I

(511) Klasa 39: Prevoz; organiziranje putovanja; uglavnom usluge prevoza putnika s jednog mjesta na drugo u drumskom, linijskom ili slobodnom, saobraćaju i usluge koje su nepohodno vezane za taj prevoz; usluge prevoza putnika u međunarodnom i domaćem drumskom saobraćaju; usluge obavještanja o putovanjima, cijene prevoza, redovima vožnje i o načinu prevoza; usluge iznajmivanja prevoznih sredstava-autobusa.

(210) **Ž-2020-393**

(220) 03.11.2020.

(300) AD 35243 28/08/2020

(731) Philip Morris Products S.A., Quai Jeanrenaud 3, 2000, Neuchâtel, CH

(540)



(550) I

(740) Milena Pejović, Cetinjski put 11, The Capital Plaza IV floor, 81000, Podgorica

(511) Klasa 34: Žičani vaporizatori za elektronske cigarete i elektronske uređaje za pušenje; duvan , sirov ili prerađen; duvanski proizvodi uključujući cigare, cigarete, cigarilose, duvan za uvijanje cigareta, duvan za lule, duvan za žvakanje, duvan za šmrkanje, kretek; snus (duvan u prahu); zamjena za duvan (za nemedicinsku upotrebu); artikli za pušače, uključujući papir za cigarete, tube za cigarete, filtere za cigarete, kutije za duvan, kutije za cigarete, tabakere i pepeljare, lule, džepne mašinicice za uvijanje cigareta, upaljače; šibice; duvanski štapići, duvanski proizvodi za zagrijavanje, elektronski uređaji i njihovi djelovi koji se koriste za zagrijavanje cigareta ili duvana u cilju oslobađanja aerosola koji sadrži nikotin za inhalaciju; tečni nikotinski rastvori za upotrebu u elektronskim cigaretama; elektronski uređaji za pušenje; elektronske cigarete; elektronske cigarete kao zamjena za tradicionalne cigarete; elektronski uređaji koji sadrže aerosol za inhalaciju nikotina;

oralni vaporizatori za pušače, duvanski proizvodi i zamjene za duvan; artikli za pušače elektronskih cigareta; djelovi i oprema za navedene proizvode iz klase 34; uređaji za gašenje cigareta i cigara koje se zagrijevaju i duvanskih štapića koji se zagrijevaju; punjive elektronske kutije za cigarete; zaštitne kutije, ukrasne navlake i kutije za nošenje elektronskih cigareta, uređaja za zagrijevanje duvana i elektronskih uređaja za pušenje; automobilski držači i nosači elektronskih cigareta, uređaja za zagrijevanje duvana i elektronskih uređaja za pušenje; posude za odlaganje upotrijebljenih duvanskih štapića koji se zagrijevaju; čistači, preparati za čišćenje, pribor za čišćenje i četkice za čišćenje elektronskih cigareta, uređaja za zagrijevanje duvana i elektronskih uređaja za pušenje.

(210) **Ž-2020-394**

(220) 03.11.2020.

(300) AD 35242 28/08/2020

(731) Philip Morris Products S.A., Quai Jeanrenaud 3, 2000, Neuchâtel, CH

(540)

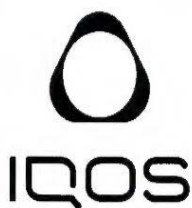

(550) I

(740) Milena Pejović, Cetinjski put 11, The Capital Plaza IV floor, 81000, Podgorica

(511) Klasa 9: Baterije za elektronske cigarete; baterije za elektronske uređaje koji se koriste za zagrijevanje duvana, punjači za elektronske uređaje koji se koriste za zagrijevanje duvana; USB punjači za elektronske uređaje koji se koriste za zagrijevanje duvana; punjači za elektronske cigarete koji se koriste u kolima; punjači koji se koriste u kolima za uređaje za zagrijevanje duvana; punjači za baterije za elektronske cigarete.

Klasa 18: Koža i imitacija kože; životinjske kože i krzna; višenamenske torbe od kože ili imitacije kože, aktovke, torbe za nošenje, džepni novčanici, novčanici, futrole, vrećice, ženske tašne, futrole za ključeve, futrole za kreditne kartice, oznake za prtljag, ručne torbice; sanduci, koferi, putne torbe, putne torbe za odeću, ruksaci, rančevi, kozmetičke torbice; kišobrani, suncobrani i štapovi za hodanje.

Klasa 34: Žičani vaporizatori za elektronske cigarete i elektronske uređaje za pušenje; duvan, sirov ili prerađen; duvanski proizvodi uključujući cigare, cigarete, cigarilose, duvan za uvijanje cigareta, duvan za lule, duvan za žvakanje, duvan za šmrkanje, kretek; snus (duvan u prahu); zamjena za duvan (za nemedicinsku upotrebu); artikli za pušače, uključujući papir za cigarete, tube za cigarete, filtere za cigarete, kutije za duvan, kutije za cigarete, tabakere i pepeljare, lule, džepne mašine za uvijanje cigareta, upaljače; šibice; duvanski štapići, duvanski proizvodi za zagrijevanje, elektronski uređaji i njihovi djelovi koji se koriste za zagrijevanje cigareta ili duvana u cilju oslobađanja aerosola koji sadrži nikotin za inhalaciju; tečni nikotinski rastvori za upotrebu u elektronskim cigaretama; elektronski uređaji za pušenje; elektronske cigarete; elektronske cigarete kao zamjena za tradicionalne cigarete; elektronski uređaji koji sadrže aerosol za inhalaciju nikotina; oralni vaporizatori za pušače, duvanski proizvodi i zamjene za duvan; artikli za pušače elektronskih cigareta; djelovi i oprema za navedene proizvode iz klase 34; uređaji za gašenje cigareta i cigara koje se zagrijevaju i duvanskih štapića koji se zagrijevaju; punjive elektronske kutije za cigarete; zaštitne kutije, ukrasne navlake i kutije za nošenje elektronskih cigareta, uređaja za zagrijevanje duvana i elektronskih uređaja za pušenje; automobilski držači i nosači elektronskih cigareta, uređaja za zagrijevanje duvana i elektronskih uređaja za pušenje; posude za odlaganje upotrijebljenih

duvanskih štipica koji se zagrijevaju; čistači, preparati za čišćenje, pribor za čišćenje i četkice za čišćenje elektronskih cigareta, uređaja za zagrijavanje duvana i elektronskih uređaja za pušenje.

Klasa 35: Usluge maloprodaje i usluge onlajn maloprodaje koje se odnose na proizvode za zagrijavanje duvana, elektronske cigarete, elektronske uređaje za pušenje, elektronske uređaje za zagrijavanje cigareta ili duvana i njihove dijelove, uređaje za oralnu vaporizaciju, raspršivače za elektronske cigarete i uređaje za pušenje, punjive elektronske kutije za cigarete, punjače i platforme za napajanje za navedene proizvode, sprave za gašenje cigareta koje se zagrijevaju i duvanske štipice koji se zagrijevaju, dijelove i opremu za navedene proizvode, tečne nikotinske rastvore za elektronske cigarete, zamjene za duvan (koje nisu za medicinsku upotrebu), artikle za pušače, zaštitne kutije, dekorativne navlake i torbe za nošenje elektronskih cigareta i elektronskih uređaja za pušenje, pribor za čišćenje, proizvode za domaćinstvo; usluge marketinškog istraživanja, istraživanja tržišta, praćenja tržišta, ispitivanje javnog mnjenja; upravljanje odnosima sa klijentima; upravljanje korisničkim uslugama; usluge lojalnosti klijenata; sve ove usluge su isključivo povezane sa elektronskim cigaretama, uređajima za zagrijavanje duvana, elektronskim uređajima za pušenje i baterijama i punjačima za baterije za elektronske cigarete, uređajima za zagrijavanje duvana i elektronskim uređajima za pušenje.

Klasa 37: Održavanje i popravka elektronskih cigareta, uređaja za zagrijavanje duvana i elektronskih uređaja za pušenje; održavanje i popravka baterija i punjača za baterije za elektronske cigarete, uređaja za zagrijavanje duvana i elektronskih uređaja za pušenje; sve ove usluge su isključivo povezane sa elektronskim cigaretama, uređajima za zagrijavanje duvana, elektronskim uređajima za pušenje i baterijama i punjačima za baterije za elektronske cigarete, uređajima za zagrijavanje duvana i elektronskim uređajima za pušenje.

Klasa 41: Usluge razonode; organizovanje događaja u kulturne i zabavne svrhe; organizovanje kulturnih aktivnosti.

(210) **Ž-2020-395**

(220) 03.11.2020.

(300) AD 35046 16/06/2020

(731) Philip Morris Products S.A., Quai Jeanrenaud 3, 2000, Neuchâtel, CH

(540)

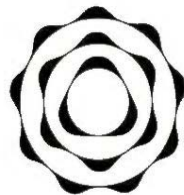

(550) I

(740) Milena Pejović, Cetinjski put 11, The Capital Plaza IV floor, 81000, Podgorica

(511) Klasa 34: Žičani vaporizatori za elektronske cigarete i elektronske uređaje za pušenje; duvan , sirov ili prerađen; duvanski proizvodi uključujući cigare, cigarete, cigarilose, duvan za uvijanje cigareta, duvan za lule, duvan za žvakanje, duvan za šmrkanje, kretek; snus (duvan u prahu); zamjena za duvan (za nemedicinsku upotrebu); artikli za pušače, uključujući papir za cigarete, tube za cigarete, filtere za cigarete, kutije za duvan, kutije za cigarete, tabakere i pepeljare, lule, džepne mašine za uvijanje cigareta, upaljače; šibice; duvanski štipići, duvanski proizvodi za zagrijavanje, elektronski uređaji i njihovi djelovi koji se koriste za zagrijavanje cigareta ili duvana u cilju oslobađanja aerosola koji sadrži nikotin za inhalaciju; tečni nikotinski rastvori za upotrebu u elektronskim cigaretama; elektronski uređaji za pušenje; elektronske cigarete; elektronske cigarete kao zamjena za tradicionalne cigarete; elektronski uređaji koji sadrže aerosol za inhalaciju nikotina;

oralni vaporizatori za pušače, duvanski proizvodi i zamjene za duvan; artikli za pušače elektronskih cigareta; djelovi i oprema za navedene proizvode iz klase 34; uređaji za gašenje cigareta i cigara koje se zagrijevaju i duvanskih štapića koji se zagrijevaju; punjive elektronske kutije za cigarete.

(210) **Ž-2020-396**

(220) 03.11.2020.

(300) AD 35230 25/08/2020

(731) Philip Morris Products S.A., Quai Jeanrenaud 3, 2000, Neuchâtel, CH

(540)

SILU

(550) I

(740) Milena Pejović, Cetinjski put 11, The Capital Plaza IV floor, 81000, Podgorica

(511) Klasa 34: Žičani vaporizatori za elektronske cigarete i elektronske uređaje za pušenje; duvan , sirov ili prerađen; duvanski proizvodi uključujući cigare, cigarete, cigarilose, duvan za uvijanje cigareta, duvan za lule, duvan za žvakanje, duvan za šmrkanje, kretek; snus (duvan u prahu); zamjena za duvan (za nemedicinsku upotrebu); artikli za pušače, uključujući papir za cigarete, tube za cigarete, filtere za cigarete, kutije za duvan, kutije za cigarete, tabakere i pepeljare, lule, džepne mašine za uvijanje cigareta, upaljače; šibice; duvanski štapići, duvanski proizvodi za zagrijavanje, elektronski uređaji i njihovi djelovi koji se koriste za zagrijavanje cigareta ili duvana u cilju oslobađanja aerosola koji sadrži nikotin za inhalaciju; tečni nikotinski rastvori za upotrebu u elektronskim cigaretama; elektronski uređaji za pušenje; elektronske cigarete; elektronske cigarete kao zamjena za tradicionalne cigarete; elektronski uređaji koji sadrže aerosol za inhalaciju nikotina; oralni vaporizatori za pušače, duvanski proizvodi i zamjene za duvan; artikli za pušače elektronskih cigareta; djelovi i oprema za navedene proizvode iz klase 34; uređaji za gašenje cigareta i cigara koje se zagrijevaju i duvanskih štapića koji se zagrijevaju; punjive elektronske kutije za cigarete.

(210) **Ž-2020-397**

(220) 03.11.2020.

(300) AD 35239 25/08/2020

(731) Philip Morris Products S.A., Quai Jeanrenaud 3, 2000, Neuchâtel, CH

(540)

NENA

(550) I

(740) Milena Pejović, Cetinjski put 11, The Capital Plaza IV floor, 81000, Podgorica

(511) Klasa 34: Žičani vaporizatori za elektronske cigarete i elektronske uređaje za pušenje; duvan , sirov ili prerađen; duvanski proizvodi uključujući cigare, cigarete, cigarilose, duvan za uvijanje cigareta, duvan za lule, duvan za žvakanje, duvan za šmrkanje, kretek; snus (duvan u prahu); zamjena za duvan (za nemedicinsku upotrebu); artikli za pušače, uključujući papir za cigarete, tube za cigarete, filtere za cigarete, kutije za duvan, kutije za cigarete, tabakere i pepeljare, lule, džepne mašine za uvijanje cigareta, upaljače; šibice; duvanski štapići, duvanski proizvodi za zagrijavanje, elektronski uređaji i njihovi djelovi koji se koriste za zagrijavanje cigareta ili duvana u cilju oslobađanja aerosola koji sadrži nikotin za inhalaciju; tečni nikotinski rastvori za upotrebu u elektronskim cigaretama; elektronski uređaji za pušenje; elektronske cigarete; elektronske cigarete kao zamjena za tradicionalne cigarete; elektronski uređaji koji sadrže aerosol za inhalaciju nikotina;

oralni vaporizatori za pušače, duvanski proizvodi i zamjene za duvan; artikli za pušače elektronskih cigareta; djelovi i oprema za navedene proizvode iz klase 34; uređaji za gašenje cigareta i cigara koje se zagrijevaju i duvanskih štapića koji se zagrijevaju; punjive elektronske kutije za cigarete.

(210) **Ž-2020-401**

(220) 05.11.2020.

(731) CHINA TOBACCO HUNAN INDUSTRIAL CO., LTD., NO.188, SECTION 3, WANJIALI MIDDLE ROAD, YUHUA DISTRICT, CHANGSHA, HUNAN, CN

(540)

AXILE

(550) I

(740) AOD "ĆUPIĆ", Bulevar Džordža Vašingtona 79, 81000, Podgorica

(511) Klasa 34: Duvan; bezdimni duvan; duvan za žvakanje; cigare; cigarete koje sadrže zamjene za duvan, ne u medicinske svrhe; cigarete; cigarilos; biljke za pušenje, ne u medicinske svrhe; duvan za ušmrkavanje; vrhovi za cigarete; futrole za cigarete/tabakere; elektronske lule za duvan; držači cigareta; tegle za duvan; pepeljare za pušače; humidor za duvan; oralni isparivači za pušače; isparivači za bezdimne cigarete; elektronski uređaji koji se koriste za zagrijavanje cigareta ili duvana u svrhu oslobađanja aerosola koji sadrži nikotin za inhalaciju; šibice; upaljači za pušače; rezervoari za gas za upaljače; filteri za cigarete; vrhovi .žutog ćilibara za držače cigara i cigareta; papir za cigarete; arome, osim esencijalnih ulja, za duvan; arome, osim esencijalnih ulja, za upotrebu u elektronskim cigaretama; elektronske cigarete; tečni rastvori za upotrebu u elektronskim cigaretama; futrole za elektronske cigarete.

(210) **Ž-2020-402**

(220) 05.11.2020.

(731) KANDIT d.o.o., Vukovarska cesta 239, 31000, Osijek, HR

(540)

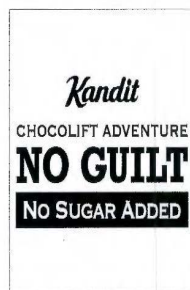

(550) I

(740) Božidar S.Radulović, Baku 30/5, 81000, Podgorica

(511) Klasa 30: Čokolade; orašasti plodovi ovijeni čokoladom.

(210) **Ž-2020-403**

(220) 05.11.2020.

(731) KANDIT d.o.o., Vukovarska cesta 239, 31000, Osijek, HR

(540)

NO GUILT

(550) I

(740) Božidar S.Radulović, Baku 30/5, 81000, Podgorica
(511) Klasa 30: Čokolade; orašasti plodovi ovijeni čokoladom.

(210) **Ž-2020-405**

(220) 06.11.2020.

(731) AstraZeneca AB, SE-151 85, Södertälje, SE

(540)

QTERN

(550) I

(740) AOD "Lutovac & partneri", Bulevar Ivana Crnojevića 93, 81000, Podgorica
(511) Klasa 5: Farmaceutski preparati i supstance.

(210) **Ž-2020-406**

(220) 06.11.2020.

(731) Lidl Stiftung & Co. KG , Stiftsbergstrasse 1, 74172, Neckarsulm, DE

(540)



(550) I

(740) AOD "Lutovac & partneri", Bulevar Ivana Crnojevića 93, 81000, Podgorica
(511) Klasa 3: Deterdženti i preparati za čišćenje, naročito praškovi za pranje veša, praškovi za ribanje, abrazivne tečnosti za ribanje, tečnosti za pranje, višenamjenska sredstva za čišćenje; sredstva za čišćenje toaleta, naročito kamen za čišćenje toaleta, sredstva za čišćenje toaleta u spreju.
Klasa 5: Sredstva za prečišćavanje vazduha, naročito sprej za prostorije.

(210) **Ž-2020-407**

(220) 06.11.2020.

(731) TASCAL ENGINEERING D.O.O. Podgorica, Bul. Džordža Vašingtona, A 16/I, "The Capital Plaza", 81000, Podgorica, ME

(540)



(550) I

(511) Klasa 9: Aparati i instrumenti za provođenje, prekid, transformaciju, akumulaciju, regulisanje ili kontrolu distribucije ili upotrebe električne energije; podaci koji su snimljeni i koji se mogu preuzeti, računarski softver, prazni nosači podataka za digitalno ili analogno snimanje i skladištenje.

Klasa 11: Aparati i instalacije za osvetljavanje, grejanje, hlađenje, proizvodnju pare, kuvanje, sušenje, ventilaciju, snabdevanje vodom i za sanitarne svrhe; uređaje i instalacije za klimatizaciju; solarne termalne kolektore; aparate i instalacije za osvetljenje, svetleće cevi za osvetljenje, reflektore, trepćuća svetla za bezbednost, svetleće kućne brojeve, reflektore za vozila, svetla za vozila; lampe, električne lampe, gas lampe, laboratorijske lampe, uljane lampe, ulične lampe, sigurnosne lampe; instalacije za kupatila, opremu za kupatila, vodovodne instalacije za kupatila; električno grejane podloge, jastuke i čebad, koji nisu za medicinsku upotrebu.

Klasa 37: Građevinske usluge; usluge instaliranja i popravljanja; usluge u oblasti građevinarstva, kao i usluge u vezi sa restauracijom objekata do njihovog izvornog stanja ili očuvanjem objekata bez menjanja njihovih fizičkih ili hemijskih svojstava; izgradnju i rušenje zgrada, kao i usluge u oblasti građevinarstva, na primer unutrašnje i spoljno farbanje, malterisanje, vodoinstalaterske usluge, uvođenje grejne opreme i pokrivanje krovova; različite usluge popravki, na primer: u oblasti električne energije, računara, nameštaja, instrumenata, alata; različite usluge restauracije, na primer: restauracije zgrada; usluge održavanja radi očuvanja objekta u njegovom prvobitnom stanju bez promene bilo kog njegovog svojstva.

Klasa 38: Usluge telekomunikacija; usluge koje omogućavaju najmanje jednom licu da komunicira sa drugim, kao i usluge emitovanja i prenosa podataka; prenos video sadržaja na zahtev; prenos digitalnih fajlova i elektronske pošte; obezbeđenje korisničkog pristupa globalnoj računarskoj mreži; pružanje usluga pričaonica i foruma na internetu; usluge telefonske i glasovne pošte; usluge telekonferencija i videokonferencija.

Klasa 39: Transportne usluge; pakovanje i skladištenje robe; usluge transporta robe sa jednog mesta na drugo železnicom, putem, vodenim putem, vazduhom i usluge nužno povezane sa takvim transportom, kao što je skladištenje robe u svim tipovima objekata za skladištenje, magacinima ili drugim vrstama zgrada radi njihovog čuvanja ili obezbeđenja; iznajmljivanje transportnih vozila i najam njihovih operatera, na primer sofera, usluge iznajmljivanja koje se odnose na transport, skladištenje i putovanja, na primer; iznajmljivanje parking mesta, iznajmljivanje garaža, iznajmljivanje kontejnera za skladištenje; pakovanje, flaširanje, umotavanje i isporučivanje robe; pregled vozila ili robe za potrebe transporta; distribuciju energije i električne energije.

Klasa 42: Naučne i tehnološke usluge, kao i usluge istraživanja i projektovanja u vezi sa njima; usluge industrijskih analiza, industrijskog istraživanja i industrijskog dizajna; usluge kontrole kvaliteta i autentifikacije; projektovanje i razvoj računarskog hardvera i softvera; usluge koje pružaju lica u vezi sa teorijskim i praktičnim aspektima složenog polja aktivnosti inženjerstva, kompjuterskog programiranja, arhitektonske i usluge unutrašnjeg dizajna; usluge inženjera i naučnika koji se bave procenama, predviđanjima, istraživanjem i izradom izveštaja u oblasti nauke i tehnologije, uključujući savetovanje u oblasti tehnologije; računarske i tehnološke usluge za obezbeđivanje računarskih podataka i informacija o ličnosti i finansijama i za otkrivanje neovlašćenog pristupa podacima i informacijama, na primer, usluge zaštite od računarskih virusa, elektronskog nadgledanja podataka o zaštiti ličnosti radi otkrivanja krađe identiteta putem interneta; softver kao uslugu; platforma kao uslugu; određene dizajnerske usluge, na primer, industrijskog dizajna, dizajna

računarskog softvera i sistema, dizajna enterijera, dizajna ambalaže, grafičkog dizajna, dizajna odeće.

(210) **Ž-2020-408**

(220) 06.11.2020.

(731) TASCAL ENGINEERING D.O.O. Podgorica, Bul. Džordža Vašingtona, A 16/I, "The Capital Plaza", 81000, Podgorica, ME

(540)



(550) I

(511) Klasa 9: Aparati i instrumenti za provođenje, prekid, transformaciju, akumulaciju, regulisanje ili kontrolu distribucije ili upotrebe električne energije; podaci koji su snimljeni i koji se mogu preuzeti, računarski softver, prazni nosači podataka za digitalno ili analogno snimanje i skladištenje.

Klasa 11: Aparati i instalacije za osvetljavanje, grejanje, hlađenje, proizvodnju pare, kuvanje, sušenje, ventilaciju, snabdevanje vodom i za sanitarne svrhe; uređaje i instalacije za klimatizaciju; solarne termalne kolektore; aparate i instalacije za osvetljenje, svetleće cevi za osvetljenje, reflektore, trepćuća svetla za bezbednost, svetleće kućne brojeve, reflektore za vozila, svetla za vozila; lampe, električne lampe, gas lampe, laboratorijske lampe, uljane lampe, ulične lampe, sigurnosne lampe; instalacije za kupatila, opremu za kupatila, vodovodne instalacije za kupatila; električno grejane podloge, jastuke i čebad, koji nisu za medicinsku upotrebu.

Klasa 37: Građevinske usluge; usluge instaliranja i popravljavanja; usluge u oblasti građevinarstva, kao i usluge u vezi sa restauracijom objekata do njihovog izvornog stanja ili očuvanjem objekata bez menjanja njihovih fizičkih ili hemijskih svojstava; izgradnju i rušenje zgrada, kao i usluge u oblasti građevinarstva, na primer unutrašnje i spoljno farbanje, malterisanje, vodoinstalaterske usluge, uvođenje grejne opreme i pokrivanje krovova; različite usluge popravki, na primer: u oblasti električne energije, računara, nameštaja, instrumenata, alata; različite usluge restauracije, na primer: restauracije zgrada; usluge održavanja radi očuvanja objekta u njegovom prvobitnom stanju bez promene bilo kog njegovog svojstva.

Klasa 38: Usluge telekomunikacija; usluge koje omogućavaju najmanje jednom licu da komunicira sa drugim, kao i usluge emitovanja i prenosa podataka; prenos video sadržaja na zahtev; prenos digitalnih fajlova i elektronske pošte; obezbeđenje korisničkog pristupa globalnoj računarskoj mreži; pružanje usluga pričaonica i foruma na internetu; usluge telefonske i glasovne pošte; usluge telekonferencija i videokonferencija.

Klasa 39: Transportne usluge; pakovanje i skladištenje robe; usluge transporta robe sa jednog mesta na drugo železnicom, putem, vodenim putem, vazduhom i usluge nužno povezane sa takvim transportom, kao što je skladištenje robe u svim tipovima objekata za skladištenje, magacinima ili drugim vrstama zgrada radi njihovog čuvanja ili obezbeđenja; iznajmljivanje transportnih vozila i najam njihovih operatera, na primer sofera, usluge iznajmljivanja koje se odnose na transport, skladištenje i putovanja, na primer; iznajmljivanje parking mesta, iznajmljivanje garaža, iznajmljivanje kontejnera za skladištenje; pakovanje, flaširanje, umotavanje i isporučivanje robe; pregled vozila ili robe za potrebe transporta; distribuciju energije i električne energije.

Klasa 42: Naučne i tehnološke usluge, kao i usluge istraživanja i projektovanja u vezi sa njima; usluge industrijskih analiza, industrijskog istraživanja i industrijskog dizajna; usluge kontrole kvaliteta i autentifikacije; projektovanje i razvoj računarskog hardvera i softvera; usluge koje pružaju lica u

vezi sa teorijskim i praktičnim aspektima složenog polja aktivnosti inženjerstva, kompjuterskog programiranja, arhitektonske i usluge unutrašnjeg dizajna; usluge inženjera i naučnika koji se bave procenama, predviđanjima, istraživanjem i izradom izveštaja u oblasti nauke i tehnologije, uključujući savetovanje u oblasti tehnologije; računarske i tehnološke usluge za obezbeđivanje računarskih podataka i informacija o ličnosti i finansijama i za otkrivanje neovlašćenog pristupa podacima i informacijama, na primer, usluge zaštite od računarskih virusa, elektronskog nadgledanja podataka o zaštiti ličnosti radi otkrivanja krađe identiteta putem interneta; softver kao uslugu; platforma kao uslugu; određene dizajnerske usluge, na primer, industrijskog dizajna, dizajna računarskog softvera i sistema, dizajna enterijera, dizajna ambalaže, grafičkog dizajna, dizajna odeće.

(210) **Ž-2020-409**

(220) 06.11.2020.

(731) Japan Tobacco Inc., 1-1, Toranomon 4-chome, Minato-ku, Tokyo, JP

(540)

WINSTON XSLIMS PLATINUM

(550) I

(740) Jasna Jusić, Dalmatinska 2, 81000, Podgorica

(511) Klasa 34: Duvan, prerađen ili neprerađen; duvan za pušenje, duvan za lule, duvan za ručno uvijanje, duvan za žvakanje, snus duvan; cigarete, elektronske cigarete, cigare, cigarilos; duvan za ušmrkavanje; artikli za pušače uključeni u klasu 34; papir za cigarete, tube za cigarete i šibice.

(210) **Ž-2020-410**

(220) 05.11.2020.

(731) Golden Group d.o.o., PC Škaljari bb, 85330, Kotor, ME

(540)

MONTIS

(550) I

(740) AOD MSA IP - Milojević Sekulić Advokati, Karađorđeva 65, 11000, Beograd

(511) Klasa 39: Transport; organizacija i rezervacija putovanja, izleta i krstarenja; pratnja putnika; vazdušni prevoz; prevoz automobilom i autobusom; organizacija putovanja, odmora i obilazaka; usluge turističkih agencija, posebno savetovanje i usluge rezervacije putovanja, pružanje informacija o putovanjima; prevoz izletničkim brodovima; iznajmljivanje čamaca; usluge prevoza za turistička razgledanja; rečni prevoz; trajektni prevoz; prevoz brodom; iznajmljivanje prostora za parkiranje; organizovanje prevoza za turistička putovanja; prevoz putnika; prevoz turista; rezervacija prevoza; putničke rezervacije; ugovaranje usluga putničkog prevoza za druge korišćenjem mrežne aplikacije. Klasa 43: Usluge hotela; rezervisanje pansiona; usluge rezervisanja hotela; usluge agencija za smeštaj (hotelski, pansionski); iznajmljivanje privremenog smeštaja; pansionske usluge; usluge iznajmljivanja kuća za odmor; rezervisanje privremenog smeštaja; usluge motela; usluge kampova za odmor (smeštaj); usluge priprema za privremeni smeštaj (organizovanje dolazaka i odlazaka); katering hrane i pića; usluge kafea; usluge kafeterija; usluge kantina; usluge restorana za samoposluživanje; usluge restorana; usluge snekbarova; usluge barova; iznajmljivanje stolova, stolica, stolnjaka i staklenog posuđa; iznajmljivanje prostorija za sastanke; usluge vašoku restorana; usluge udon i soba restorana; dekorisanje hrane i kolača;

informacije i saveti u vezi sa pripremom obroka.

(210) **Ž-2020-411**

(220) 10.11.2020.

(300) AD 35178 11/08/2020

(731) Philip Morris Products S.A., Quai Jeanrenaud 3, 2000, Neuchâtel, CH

(540)

TOGETHER.FORWARD.

(550) I

(740) Milena Pejović, Cetinjski put 11, The Capital Plaza IV floor, 81000, Podgorica

(511) Klasa 34: Žičani vaporizatori za elektronske cigarete i elektronske uređaje za pušenje; duvan , sirov ili prerađen; duvanski proizvodi uključujući cigare, cigarete, cigarilose, duvan za uvijanje cigareta, duvan za lule, duvan za žvakanje, duvan za šmrkanje, kretek; snus (duvan u prahu); zamjena za duvan (za nemedicinsku upotrebu); artikli za pušače, uključujući papir za cigarete, tube za cigarete, filtere za cigarete, kutije za duvan, kutije za cigarete, tabakere i pepeljare, lule, džepne mašine za uvijanje cigareta, upaljače; šibice; duvanski štapići, duvanski proizvodi za zagrijavanje, elektronski uređaji i njihovi djelovi koji se koriste za zagrijavanje cigareta ili duvana u cilju oslobađanja aerosola koji sadrži nikotin za inhalaciju; tečni nikotinski rastvori za upotrebu u elektronskim cigaretama; elektronski uređaji za pušenje; elektronske cigarete; elektronske cigarete kao zamjena za tradicionalne cigarete; elektronski uređaji koji sadrže aerosol za inhalaciju nikotina; oralni vaporizatori za pušače, duvanski proizvodi i zamjene za duvan; artikli za pušače elektronskih cigareta; djelovi i oprema za navedene proizvode iz klase 34; uređaji za gašenje cigareta i cigara koji se zagrijevaju i duvanskih štapića koji se zagrijevaju; punjive elektronske kutije za cigarete.

(210) **Ž-2020-412**

(220) 04.11.2020.

(300) AD 34996 15/05/2020

(731) Philip Morris Products S.A., Quai Jeanrenaud 3, 2000, Neuchâtel, CH

(540)

SMARTCORE INDUCTION SYSTEM

(550) I

(740) Milena Pejović, Cetinjski put 11, The Capital Plaza IV floor, 81000, Podgorica

(511) Klasa 34: Žičani vaporizatori za elektronske cigarete i elektronske uređaje za pušenje; duvan , sirov ili prerađen; duvanski proizvodi uključujući cigare, cigarete, cigarilose, duvan za uvijanje cigareta, duvan za lule, duvan za žvakanje, duvan za šmrkanje, kretek; snus (duvan u prahu); zamjena za duvan (za nemedicinsku upotrebu); artikli za pušače, uključujući papir za cigarete, tube za cigarete, filtere za cigarete, kutije za duvan, kutije za cigarete, tabakere i pepeljare, lule, džepne mašine za uvijanje cigareta, upaljače; šibice; duvanski štapići, duvanski proizvodi za zagrijavanje, elektronski uređaji i njihovi djelovi koji se koriste za zagrijavanje cigareta ili duvana u cilju oslobađanja aerosola koji sadrži nikotin za inhalaciju; tečni nikotinski rastvori za upotrebu u elektronskim cigaretama; elektronski uređaji za pušenje; elektronske cigarete; elektronske cigarete kao zamjena za tradicionalne cigarete; elektronski uređaji koji sadrže aerosol za inhalaciju nikotina; oralni vaporizatori za pušače, duvanski proizvodi i zamjene za duvan; artikli za pušače elektronskih

cigareta; djelovi i oprema za navedene proizvode iz klase 34; uređaji za gašenje cigareta i cigara koji se zagrijevaju i duvanskih štapića koji se zagrijevaju; punjive elektronske kutije za cigarete.

(210) **Ž-2020-413**

(220) 04.11.2020.

(300) AD 34994 15/05/2020

(731) Philip Morris Products S.A., Quai Jeanrenaud 3, 2000, Neuchâtel, CH

(540)

SMARTCORE STICKS

(550) I

(740) Milena Pejović, Cetinjski put 11, The Capital Plaza IV floor, 81000, Podgorica

(511) Klasa 34: Žičani vaporizatori za elektronske cigarete i elektronske uređaje za pušenje; duvan , sirov ili prerađen; duvanski proizvodi uključujući cigare, cigarete, cigarilose, duvan za uvijanje cigareta, duvan za lule, duvan za žvakanje, duvan za šmrkanje, kretek; snus (duvan u prahu); zamjena za duvan (za nemedicinsku upotrebu); artikli za pušače, uključujući papir za cigarete, tube za cigarete, filtere za cigarete, kutije za duvan, kutije za cigarete, tabakere i pepeljare, lule, džepne mašine za uvijanje cigareta, upaljače; šibice; duvanski štapići, duvanski proizvodi za zagrijavanje, elektronski uređaji i njihovi djelovi koji se koriste za zagrijavanje cigareta ili duvana u cilju oslobađanja aerosola koji sadrži nikotin za inhalaciju; tečni nikotinski rastvori za upotrebu u elektronskim cigaretama; elektronski uređaji za pušenje; elektronske cigarete; elektronske cigarete kao zamjena za tradicionalne cigarete; elektronski uređaji koji sadrže aerosol za inhalaciju nikotina; oralni vaporizatori za pušače, duvanski proizvodi i zamjene za duvan; artikli za pušače elektronskih cigareta; djelovi i oprema za navedene proizvode iz klase 34; uređaji za gašenje cigareta i cigara koji se zagrijevaju i duvanskih štapića koji se zagrijevaju; punjive elektronske kutije za cigarete.

(210) **Ž-2020-415**

(220) 16.11.2020.

(731) Golden Group d.o.o., PC Škaljari bb, 85330, Kotor, ME

(540)



(550) I

(740) ZAK Vujinović & Đokić, Kosovska 39, Beograd

(511) Klasa 36: Agencije za kredite; agencije za nekretnine; agencije za stanove (nepokretna imovina); agencije za utjerivanje potraživanja; finansijske procjene nekretnina; građevinski objekti (upravljanje građevinskim objektima); imovina (upravljanje imovinom); upravljanje nekretninama; iznajmljivanje nekretnina; iznajmljivanje stanova; monetarni poslovi; naknada štete (finansijska procjena naknade štete); nekretnine (agencije za nekretnine); davanje u zakup nekretnina; procjena nekretnina; upravljanje nekretninama; osiguranje nekretnina; posredovanje u trgovini nekretninama;

posredovanje u nekretninama.

Klasa 43: Usluge hotela; rezervisanje pansiona; hotelske rezervacije (usluge rezervisanja hotela); usluge agencija za smještaj (hotelski, pansionski); iznajmljivanje privremenog smještaja; pansionske usluge; usluge iznajmljivanja kuća za odmor; ljetovališta; rezervisanje privremenog smještaja; usluge motela; usluge kampova za odmor i ljetovanje (smještaj); usluge priprema za privremeni smještaj (organizovanje dolazaka i odlazaka); katering hrane i pića; usluge kafea; usluge kafiterija; usluge kantina; usluge restorana za samoposluživanje; usluge restorana; usluge snek-barova; usluge barova; iznajmljivanje stolaca, stolova, stolnog rublja i staklenog posuđa; iznajmljivanje prostorija za sastanke; usluge vašoku restorana; usluge udon i soba restorana; dekorisanje hrane i kolača; informacije i savjeti u vezi sa pripremom obroka.

(210) **Ž-2020-416**

(220) 17.11.2020.

(731) Dentek Oral Care, Inc., 660 White Plains Road, Suite 250, 10591, Tarrytown, New York, US

(540)

DENTEK

(550) I

(740) Jasna Jusić, Dalmatinska 2, 81000, Podgorica

(511) Klasa 3: Medicinska pasta za zube; medicinska pasta za zube u tubama; medicinska pasta za zube u dispenzerima: formulacije za izbjeljivanje zuba, koje su dio kompleta protiv zubobolje; sredstva za ispiranje usta, kao dio kompleta protiv zubobolje; sprej za jezik, nemedicinski, koji je dio kompleta protiv zubobolje; lijekovi u obliku paste za zube; lijekovi u obliku paste za zube u tubama; lijekovi u obliku paste za zube u dispenzerima.

Klasa 5: Ljekovi za liječenje afti; stomatološki preparati i proizvodi; zubarski anestetici; zubarski cement; zubarski lijepkovi; zubarska smola; zubne zaptivne mase; zubarske mastike; zubarski amalgami; materijali za zubne plombe; farmaceutski preparati za stomatološku upotrebu; zubarski materijali za plombiranje zuba; materijali za popravku zubnih mostova; materijali za popravku zubnih krunica; materijali za popravljivanje zuba i zubnih proteza; preparati za ublažavanje bolova; farmaceutski preparati za ublažavanje zubnih bolova; medicinske vodice za ispiranje usta; materijal za poliranje zuba; medicinski preparati za vlaženje usta; ovlaživači za usta, naime, preparati za povećanje vlage u ustima ili za povećanje proizvodnje vlage u ustima, za ublažavanje stanja suvih usta; ovlaživači za usta, naime, preparati koji se privremeno isporučuju u obliku impregniranog flastera za pričvršćivanje na unutrašnjost usta, pri čemu je preparat za povećanje vlage u ustima ili za povećanje proizvodnje vlage u ustima, za ublažavanje stanja suvih usta; sredstva za dezinfekciju četkica za zube; proizvodi za njegu zuba za potrošačku upotrebu, naime zubarska smola za zubne fiksne proteze; proizvodi za hitnu stomatološku njegu, naime kompleti za popravljivanje izgubljenih plombi i kapica koje se sastoje uglavnom od zubnog cementa u obliku kapica i krunskog cementa; lijekovi za ublažavanje bolova, koji su dio kompleta protiv zubobolje; sredstva za dezinfekciju četkica za zube, koja su dio kompleta protiv zubobolje; ovlaživači za usta, naime flasteri za privremeno pričvršćivanje na unutrašnjost usta, takvi flasteri se impregniraju preparatima koji će povećati vlagu u ustima ili koji će povećati proizvodnju vlage u ustima i na taj način olakšati stanje suvih usta.

Klasa 10: Stomatološka oprema; zubarski alati; zubarski aparati; stomatološki instrumenti; uređaji za upotrebu u popravci zuba; zubarski nasadnici (dental handpieces); zubarska ogledala; aparati za uklanjanje kamenca sa zuba; instrumenti za nanošenje zubnih ispuna; uređaji za upotrebu od strane stomatoloških higijeničara; zubni implantati; medicinski aparati za ublažavanje bolova; zubarski aparati za ublažavanje bolova; štيتnici za zube u stomatološke svrhe; uređaji za poliranje zuba; proizvodi za njegu zuba za potrošačku upotrebu, naime zubna ogledala, zubni noćni štيتnici, zubne čačkalice i zubni eskavatori; sredstva za čišćenje jezika, koja su dio kompleta protiv zubobolje;

instrumenti i uređaji za vlaženje usta, naime, stomatološki instrumenti i zubni aparati za upotrebu u isporuci vlage u usta ili u isporuci preparata u usta koji će povećati proizvodnju vlage u ustima i na taj način olakšati stanje suvih usta; instrumenti i uređaji za vlaženje usta, naime stomatološki instrumenti za potrošačke potrebe i stomatološki aparati za potrošače, za upotrebu u isporuci vlage u usta ili u isporuci preparata u usta koji će povećati proizvodnju vlage u ustima, a time i ublažiti stanje suvih usta.

Klasa 21: Artikli za čišćenje zuba; spravice na koje se stavlja zubni konac (dental flossers); konac za zube; trzalice za zubni konac; trzalice sa koncem za zube; dispencer za zubni konac; niti za zubni konac; četkice za zube; posude za četkice za zube; poklopci za četkice za zube; kompleti za oralnu njegu koji sadrže četkice za zube i konac; dispenceri za zubne paste; poklopci za zubnu pastu; sprave za poliranje zuba; proizvodi za njegu zuba za potrošačke potrebe, naime, trzalice za zubni konac, niti za zubni konac i zubni konac; ručke za držanje flosera (spravica na koje se stavlja zubni konac) za jednokratnu upotrebu kao dio kompleta protiv zubobolje; ručke za držanje interdentalnih četkica koje su dio kompleta protiv zubobolje; interdentalne četkice, kao dio kompleta protiv zubobolje; oralni irigatori, koji su dio kompleta protiv zubobolje; mekane stomatološke čačkalice, koje su dio kompleta protiv zubobolje; četkice za zube, kao dio kompleta protiv zubobolje.

(210) **Ž-2020-418**

(220) 18.11.2020.

(731) Vujović Moreta, Ul. Studentska L1/15, Podgorica, ME

(540)



(550) I

(511) Klasa 41: Razonoda,zabava:pružanje usluga igara na sreću,posebno klađenje,sportsko klađenje,uluga kockanja,pružanje usluga onlajn klađenja i kockanja.

(210) **Ž-2020-419**

(220) 09.11.2020.

(731) Rado Arsić, Donja Lastva, Tivat, ME

(540)



(550) I

(511) Klasa 30: Kafa, kafa(arome za kafu),kafa(zamjena za kafu), pića od kafe.

Klasa 35: Komercijalna ili industrijska preduzeća (pomoć u vođenju komercijalnih ili industrijskih preduzeća); sortiranje za račun drugih osoba, raznih proizvoda (ne uključuje njihov prevoz) radi omogućavanja potrošaču njihovog lakšeg razgledanja i kupovine; ove usluge se mogu pružati u okviru prodavnica na malo, trgovina na veliko, posredstvom prodajnih kataloga, dopisno ili elektronskim putem, na primjer posredstvom weba ili putem telefona.

Klasa 43: Usluge obezbjeđivanja hrane i pića; usluge koje pružaju lica ili preduzeća čiji cilj je priprema jela ili pića za potrošnju; kafane [kafeterije]; kafane-restorani; ugostitelji (usluge kateringa).

(210) **Ž-2020-420**

(220) 06.11.2020.

(731) 2 MAJ DOO NOVI PAZAR, Avnoj-a 2, 36300, Novi Pazar, RS

(540)



(550) I

(740) Dalibor Roćen, ulica 13. Jula, br.3, 81000, Podgorica

(511) Klasa 6: Metalni materijali za građevinsko konstruisanje; metalne prenosive konstrukcije; mali metalni gvoždarski proizvodi;blindirana metalna vrata; metalni graničnici za vrata; metalne šarke za vrata; ploče; reze.

Klasa 10: Namještaj posebno napravljen u medicinske svrhe.

Klasa 19: Vrata nemetalna;paneli za vrata, nemetalna;ramovi za vrata;kućišta za vrata;blindirana nemetalna vrata;harmonika vrata;parketne podne daske;podne drvene daske;podne pločice, nemetalne;drvene letvice za oblaganje;preklopna vrata, koja nisu metalna;drvo polupreradeno;drvena građa;preradeno drvo;drvo za izradu kućnih potrepština;drvene podloge za popločavanje;furnirano drvo;drveni paneli;krovni pokrivači, nemetalni;prozori nemetalni;podovi nemetalni;ramovi za prozore, nemetalni; ramovi za vrata, nemetalni;pločice, nemetalne za građevine;stepeništa nemetalna.

Klasa 20: Namještaj, ogledala, okviri za slike.

Klasa 27: Tepisi, asure, prostirke i otirači, linoleum i drugi materijali za pokrivanje podova;prekrivači za zidove, netekstilni.

Klasa 35: Oglašavanje;vođenje poslova;poslovno upravljanje;maloprodaja, veleprodaja, izvoz i uvoz namještaja napravljenog u medicinske svrhe, namještaja, ogledala i okvira za slike.

(210) **Ž-2020-424**

(220) 25.11.2020.

(731) DOO FARMONT MP, Kosić bb, Danilovgrad, ME

(540)



(550) I

(511) Klasa 29: Meso, riba, živina i divljač; mesni ekstrakti; konzervirano, sušeno i kuvano voće i povrće; želei, džemovi, kompoti; jaja, mlijeko i mliječni proizvodi; jestiva ulja i masti.

Klasa 32: Pivo; mineralne i gazirane vode i ostala bezalkoholna pića; pića od voća i voćni sokovi; sirupi i ostali preparati za pripremanje napitaka.

Klasa 35: Oglašavanje, reklamiranje, uvoz, izvoz, distribucija, online prodaja, maloprodaja i veleprodaja sledećih proizvoda: džemovi, kompoti, voćni sokovi, konzervirano, zamrznuto, sušeno i kuvano voće i povrće; komercijalna administracija.

Klasa 39: Prevoz, ambalažiranje i skladištenje proizvoda nabrojanih u klasi 35.

Klasa 41: Obuka; stručno osposobljavanje; razonoda; sportske i kulturne djelatnosti.

(210) **Ž-2020-425**

(220) 19.11.2020.

(731) Otani Tire Co., Ltd ., No. 55 Mu 7 Petchkasem K.M. 37 Road, Klongmai, Sampran, 73110, Nakhonpathom, TH

(540)



(550) I

(740) Jelena Brajković, Cetinjska 11, The Capital plaza, 81000, Podgorica

(511) Klasa 12: Gume za točkove vozila.

(210) **Ž-2020-426**

(220) 26.11.2020.

(731) Dow AgroSciences LLC, 9330 Zionville Road, 46268, Indianapolis, Indiana, US

(540)

ENRAPTA

(550) I

(740) Božidar S. Radulović, Baku 30/5, 81000, Podgorica

(511) Klasa 1: Proizvodi za biokontrolu, naime feromoni; poljoprivredne hemikalije koje se koriste kao stimulansi insekata za privlačenje ili odbijanje štetočina.

(210) **Ž-2020-427**

(220) 02.12.2020.

(731) Via Paradizo doo, Oktobarske revolucije 5, Podgorica, ME

(540)



(550) I

(511) Klasa 18: Koža i imitacija kože, proizvodi izrađeni od ovih materijala koji nisu uključeni u druge klase, životinjska koža, krzno; koferii putne torbe; kišobrani, suncobrani i štapovi za hodanje; bičevi, saračka i sedlarska oprema.

Klasa 25: Odjeća, obuća, pokrivala za glavu

(210) **Ž-2020-429**

(220) 02.12.2020.

(731) Lidl Stiftung & Co. KG, Stiftsbergstrasse 1, 74172, Neckarsulm, DE

(540)



(550) I

(740) AOD "Lutovac & partneri", Bulevar Ivana Crnojevića 93, 81000, Podgorica

(511) Klasa 29: Konzervirano, sušeno i kuvano voće i povrće; džemovi; marmelade; konzervirano voće i povrće; prerađeno koštunjavo voće, zrna i sjemenke, kao i njihove mešavine, posebno pržene, oljuštene, soljene, začinjene, sušene; jestivo sjeme suncokreta; jestivo sjeme bundeve; pinjoli; pistaći.

Klasa 30: Kokice; koštunjavo voće (slatkiši).

Klasa 31: Svježe voće i povrće; svježe i neprerađeno koštunjavo voće, zrna i sjemenke, kao i njihove mješavine.

(210) **Ž-2020-430**

(220) 02.12.2020.

(731) Lidl Stiftung & Co. KG , Stiftsbergstrasse 1, 74172, Neckarsulm, DE

(540)



(550) I

(740) AOD "Lutovac & partneri", Bulevar Ivana Crnojevića 93, 81000, Podgorica

(511) Klasa 32: Piva; mineralne i gazirane vade i druga bezalkoholna pića; voćni napici i voćni sokovi.

Klasa 33: Alkoholna pića (osim piva), posebno viski, žestoka pića, likeri, vina.

(210) **Ž-2020-431**

(220) 03.12.2020.

(731) Dow AgroSciences LLC, 9330 Zionsville Road, 46268, Indianapolis, Indiana, US

(540)

UTRISHA

(550) I

(740) Božidar S. Radulović, Baku 30/5, 81000, Podgorica

(511) Klasa 1: Hemikalije koje se koriste u poljoprivredi, naime stimulantni rasta biljaka; preparati za ishranu biljaka; mikroorganizmi ili spore za zaštitu biljaka; regulatori rasta biljaka, uključujući biostimulante, feromone i hemikalije za upotrebu u poljoprivredi, hortikulturi i šumarstvu, đubrivo.

(210) **Ž-2020-432**

(220) 04.12.2020.

(731) DOO "PICCOLETO" - Nikšić, ul. Baja Pivljanina bb, Nikšić, ME

(540)



(550) I

(740) Nebojša Lalatović, ul. Nikole Tesle 115/II, Nikšić
(511) Klasa 43: Usluga pripremanja hrane i usluživanja hrane i pića za potrošnju u objektu obavljanja djelatnosti, dostavljanje hrane i pića, catering, usluge pripremanja, usluživanja i dostavljanje brze hrane.

(210) **Ž-2020-433**

(220) 04.12.2020.

(731) DOO "PICCOLETO" - Nikšić, ul. Baja Pivljanina bb, Nikšić, ME

(540)



(550) I

(740) Nebojša Lalatović, ul. Nikole Tesle 115/II, Nikšić
(511) Klasa 43: Usluga pripremanja hrane i usluživanja hrane i pića za potrošnju u objektu obavljanja djelatnosti, dostavljanje hrane i pića, catering, usluge pripremanja, usluživanja i dostavljanje brze hrane.

(210) **Ž-2020-434**

(220) 07.12.2020.

(731) Apatinska Pivara Apatin d.o.o., Trg oslobođenja br.5, 25260, Apatin, RS

(540)

APA KVASTER

(550) I

(740) Pavle Tripković, City kvart - Cetinjski put 40, L5-1, stan 10, Podgorica
(511) Klasa 32: Bezalkohona pića na bazi slada, bezalkoholna pića.

(210) **Ž-2020-436**

(220) 10.12.2020.

(731) Lazar Živanović, Vranići b.b., 81000, Podgorica, ME

(540)



(550) I

(511) Klasa 9: Aparati i instrumenti naučni, fotografski, kinematografski, optički; aparati za snimanje, prenos i reprodukovanje zvuka ili slike; magnetni nosioci podataka, diskovi za snimanje; registar kase, računске mašine, oprema za obradu podataka i kompjuteri; aparati za razonodu koji koriste spoljni ekran ili monitor; svi kompjuterski programi i softveri bez obzira na medijum na koji su snimljeni ili način diseminacije tj. softver snimljen na magnetnim nosačima podataka ili učitani sa udaljene kompjuterske mreže.

Klasa 15: Muzički instrumenti, mehaničke klavire i njihove delove; muzičke kutije; sve električne i elektronske muzičke instrumente.

Klasa 41: Obrazovne usluge; pripremanje obuke; razonoda; sportske i kulturne aktivnosti; usluge koje pružaju lica ili institucije u razvijanju mentalnih sposobnosti drugih lica (obrazovanje), kao i usluge kojima je cilj zabavljanje drugih lica ili privlačenje pažnje; usluge koje pružaju sve vrste edukacije lica (obrazovanje); usluge kojima je osnovni cilj zabavljanje drugih lica, rekreacija; organizovanje (priredivanje) i vođenje seminara, konferencija, kongresa, koncerata, muzičkih i drugih nastupa; organizovanje izložbi ili prezentacije knjiga (književne večeri) u kulturne i obrazovne svrhe, sportskih takmičenja; izdavanje tekstova i knjiga; izdavanje muzičkih numera i spotova; pisanje tekstova, komponovanje i produkcija.

(210) **Ž-2020-437**

(220) 11.12.2020.

(731) Fleka doo, 4.Jul S/28 /4/12, 81250, Cetinje, ME

(540)



(550) I

(511) Klasa 35: Oglašavanje i reklamiranje; vođenje komercijalnih poslova; komercijalna administracija; kancelarijski poslovi.

Klasa 36: Osiguranje; finansijski poslovi; monetarni poslovi; upravljanje nekretninama.

Klasa 42: Naučne i tehnološke usluge kao i pripadajuće usluge istraživanja i koncepcije; usluge industrijskih analiza i istraživanja; koncepcija i razvoj računara i računarskih programa /hardvera i softvera.

OBJAVA ŽIGOVA
Publication of trademarks

(111) **14550**

(151) 17.12.2020.

(210) Ž-2019-113

(220) 21.03.2019.

(732) KT & G Corporation, 71, Beotkkot-gil, Daedeok-gu, Daejeon, KR

(540)

ESSE CHANGE

(550) I

(740) Miladin Popović, Đoka Miraševića 21/III, 81000, Podgorica

(511) Klasa 34: Duvan; Cigarete; Cigare; Burmut; Papiri za cigarete; Lule za duvan, ne od plemenitih metala; Filteri za cigarete; Kutije za cigarete, ne od plemenitih metala; Kesice za duvan; Upaljači za cigarete, ne od plemenitih metala; Šibice; Sredstva za čišćenje lula za duvan; Pepeljare za pušaće, ne od plemenitih metala; Rezači za cigare.

(111) **14660**

(151) 12.10.2020.

(210) Ž-2016-505

(220) 13.12.2016.

(732) SHELL BRANDS INTERNATIONAL AG, Baarermatte, 6340, Baar, CH

(540)



(550) I

(740) Branislav V. Lutovac, Bulevar Ivana Crnojevića 93, 81000, Podgorica

(511) Klasa 4: Industrijska ulja; industrijske masti; maziva; goriva.

Klasa 35: Dovođenje goriva, maziva i drugih auto-proizvoda na lokacije auto servisa i pumpi, da bi se omogućilo kupcima da na pogodan način pregledaju i kupe takve proizvode; usluge prodaje na malo koje se pružaju u auto servisima i pumpama, a koje obuhvataju sledeću robu: gotovu i pakovanu hranu i piće; rezervne delove i pribor za vozila; auto proizvode; proizvode za održavanje vozila; proizvode za održavanje motora; poklon čestitke; promotivne poklone; svježe i sječeno cveće; kartice za dopunu mobilnih telefona; alate za kućnu upotrebu i za vozila; sportske artikle; proizvode i pribor za putovanja; mape; kancelarijski pribor; knjige; časopise; novine; lijekovi; duvan i pušački pribor.

Klasa 37: Usluge auto servisa i pumpi (dopuna goriva i odražavanje); popravke, podmazivanje, čišćenje, poliranje i farbanje vozila; protektiranje i namiještanje guma; usluge auto pranja.

(111) **14822**

(151) 22.10.2020.

(210) Ž-2018-352

(220) 10.09.2018.

(732) AMPLITUDO D.O.O., Bulevar Svetog Petra Cetinjskog 56, 81000, Podgorica, ME

(540)



(550) I

(740) AMPLITUDO D.O.O., Bulevar Svetog Petra Cetinjskog 56, 81000, Podgorica

(511) Klasa 31: Drveće; neobrađeno sirovo drvo; sadnice; sjeme za sadnju; sjemenje; sirova kora drveta; stabla drveća; stabla palme.

Klasa 35: Administrativna obrada narudbenica za kupovinu ; aministrativna pomoć pri odgovaranju na pozive za podnošenje ponuda; ažuriranje i održavanje informacija u registrima; ažuriranje i održavanje podataka u računarskim bazama podataka; ažuriranje oglasnih materijala ; analize cijena i troškova ; angažovanje spoljnih firmi za adminitrativno upravljanje kompanijama; distribucija reklamnog materijala; dizajniranje reklamnog materijala; distribucija uzoraka ; iznajmljivanje oglasnih materijala; iznajmljivanje oglasnog prostora; indeksiranje internet sajtova za komercijalne namjene ili namjene oglašavanja; ispitivanje javnog mjenja; istraživanje tržišta; komercijalna administracija za licence roba i ugleda trećih lica; kompjutersko upravljanje podacima ; konsultacija o strategiji komunikacije u odnosima sa javnošću ; konsultacije u vezi sa izborom osoblja ; konsultacije u vezi sa poslovnim organizovanjem;konsultacije u poslovnom upravljanju ; marketing; marketing u okviru izdavanja softvera; marketinška istraživanja; obaveštenja o poslovima ; obezbeđivanje online tržišta za kupce i prodavce roba i usluga; obrada teksta; objavljivanje reklamnih tekstova; oglašavanje; oglašavanje na otvorenom ; oglašavanje plaćanjem po kliku (pay per click oglašavanje) ; optimizacija pretraživača za promociju prodaje; optimizacija saobraćaja sa Internet stranice ; organizovanje izložbi za privredne ili reklamne potrebe; organizovanje sajmova u komercijalne ili reklamne svrhe; pisanje reklamnih tekstova ; pisanje tekstova za reklamne namjene; pomoć u poslovnom ili industrijskom upravljanju; pomoć u poslovnom u pravljanju; poslovna ispitivanja ; poslovna istraživanja ; poslovne informacije; poslovne procjene; poslovno upravljanje za nezavisne pružaoce usluga; poslovno upravljanje I organizaciono savjetovanje ; pregovaranje o

poslovnim ugovorima za druge ; prezentacija proizvoda putem sredstava komunikacije, u svrhu podaje na malo ; prezentacija robe ; prepisivanje korsepodencije (kancelarijske usluge); pretraživanje podataka u računarskim datotekama za druge ; privremeno poslovno upravljanje ; prikupljanje informacija u kompjuterske baze podataka ; prikupljanje statističkih podataka; produkcija emisija televizijske prodaje; proizvodnja reklamnih filmova ; promocija prodaje za druge ; promocija robe i usluga kroz sponzorisanje sportskih događaja ; profesionalne poslovne konsultacije ; pružanje komercijalnih savjeta i informacija potrošačima pri izboru roba i usluga ; pružanje poslovnih informacija putem internet stranice; registrovanje pisane komunikacije i podataka; reklamiranje ; reklamiranje na radiju; reklamiranje na računarskoj mreži; reklamiranje preko plakata; reklamiranje preko televizije ; reklamiranje slanjem narudžbenica; savjetodavne usluge u poslovnom upravljanju; sastavljanje popisa informacija za komercijalne i reklamne svrhe; sistemacija informacija u kompjuterskim bazama podataka ; stručne usluge o poslovnoj efikasnosti; umnožavanje dokumenata ; upravljanje programima lojalnosti potrošača; uređivanje izloga ; usluge agencija za pružanje poslovnih informacija ; usluge grafičke obrade materijala za reklamne svrhe ; usluge maloprodaje umjetničkih djela od strane umjetničkih galerija; usluge maloprodaje farmaceutskih, veterinarskih i higijenskih preparata i medicinskog materijala; usluge nabavke za treća lica (kupovina proizvoda i usluga za druge poslovne subjekte); usluge odnosa sa javnošću; usluge podutovaranja, outsorsing (pomoć u poslovanju); usluge poslovnog posredovanja koje se odnose na povezivanje potencijalnih privatnih ulagača sa preduzetnicima kojima su potrebna finansijska sredstva ; usluge posredovanja u trgovini ; usluge praćenja korupcije; usluge praćenja tržišta; usluge reklamnih agencija ; ciljni marketing; fakturisanje .

Klasa 38: Obezbeđenje korisničkog pristupa globalnoj računarskoj mreži; omogućavanje pristupa računarskim bazama podataka; prenos video sadržaja na zahtjev; pejdžing usluge, radiom, telefonom ili drugim vidom elektronskog komuniciranja ; prenos digitalnih datoteka; prenos elektronske pošte; prenos poruka i slika posredstvom računara ; prenos čestitki putem internet; pružanje usluga online foruma; slanje poruka; forumi (pričaonice) na društvenim mrežama.

Klasa 42: Ažuriranje računarskog softvera; analize računarskih sistema; grafički dizajn; digitalizacija dokumenata (skeniranje); dizajniranje računarskih sistema; dizajniranje računarskog softvera; elektronsko nadgledanje korišćenja kreditnih kartica radi otkrivanja internet prevare; elektronsko nadgledanje podataka o zaštiti ličnosti radi krađe identiteta putem interneta; elektronsko pohranjivanje podataka; zaštita od računarskih virusa ; iznajmljivanje veb servera; iznajmljivanje računara; iznajmljivanje računarskog softvera; istraživanje u oblasti zaštite životne sredine; konsultacije o bezbjednosti interneta; konsultacije o sigurnosti podataka; kontrola kvaliteta; kreiranje i dizajniranje za druge indeksa informacija zasnovanih na internetu (usluge informacione tehnologije) ; nadgledanje računarskih sistema radi otkrivanja kvarova; naučna istraživanja ; obezbjeđivanje alata za pretraživanje (pretraživača) na internetu; održavanje računarskog softvera ; platforma kao usluga (PaaS); pisanje tekstova o tehnici; ponovno uspostavljanje računarskih podataka ; praćenje računarskih sistema daljinskim pristupom; pružanje informacija o računarskim tehnologijama i programiranju putem internet stranice; pružanje naučnih informacija, savjeta i konsultacija u vezi smanjenja emisije ugljenika; razvoj softvera u okviru izdavanja softvera; računarstvo u oblaku ; računarsko programiranje; savjetovanje o izradi Veb sajtova; savjetovanje o sigurnosti računara; savjetovanje u vezi informacionih tehnologija; savjetovanje u oblasti dizajna i razvoja računarskog hardvera; savjetovanje u oblasti računarskog softvera; savjetodavne usluge iz oblasti tehnologije; savjetodavne

usluge iz oblasti kompjuterske tehnologije; server hosting; softver u vidu servisa (SaaS); stilizacija (industrijski dizajn); umnožavanje računarskih programa ; urbanističko planiranje; unutrašnji dizajn ; usluge kodiranja + N4078 podataka ; usluge spoljnih firmi u oblasti informacionih tehnologija; hosting računarskih sajtova (veb sajtova); čuvanje rezervne kopije podataka van mreže; analize računarskih sistema; biološka istraživanja; geološka ispitivanja terena ; geološka istraživanja ; geološke ekspertize; energetska revizija; istraživanje u oblasti zaštite životne sredine; mjerenje zemljišta; naučna istraživanja; ocjenjivanje kvaliteta neposječenog drveta.

Klasa 44: Uređivanje vrtova; uništavanje korova ; uređivanje travnjaka ; usluge pošumljavanja;usuge rasadnika;usluge suzbijanja štetočina u poljoprivredi,akvakulturi,hortikulturi i šumarstvu.

(111) **14823**

(151) 07.10.2020.

(210) Ž-2018-389

(220) 19.10.2018.

(732) Auberge Resorts LLC, 33 Reed Blvd, 94941-2306, Mill Valley, California, US

(540)

AUBERGE RESORTS COLLECTION

(550) I

(740) Jasna Jusić, Dalmatinska 2, 81000, Podgorica

(511) Klasa 35: Oglašavanje; poslovni menadžment; poslovna administracija; kancelarijske funkcije ; upravljanje hotelima, odmaralištima, spa centrima i restoranima za druge; hotelska administracija; obezbjeđivanje objekata za izložbe; obezbjeđivanje usluga poslovnog centra; organizacija konvencija i izložbi u poslovne i komercijalne svrhe; administriranje programa lojalnosti kupaca; poslovno upravljanje hotelima, spa centrima, rezidencijama , prodajnim mjestima za hranu, prodajnim mjestima za piće, kancelarijama, poslovnim centrima i maloprodajnim objektima; konsalting za hotelijerstvo; poslovne savjetodavne usluge u vezi sa franšizom ; obezbjeđivanje programa za klijente u vidu članstva, lojalnosti, podsticaja, nagrada i otkupnih programa za komercijalne, promotivne i I ili reklamne svrhe. Klasa 36: Osiguranje; finansijski poslovi; monetarni poslovi; poslovi s nekretninama; usluge upravljanja nekretninama; zakup stanova; usluge u vezi sa nekretninama, naime, zakup, lizing i upravljanje stambenom imovinom; usluge u vezi sa nekretninama, naime usluge upravljanja kondominijumima; usluge u vezi sa nekretninama sa vremenski limitiranim vlasništvom; razvoj, kupovina, prodaja, finansiranje, upravljanje, operacija, iznajmljivanje, promocija i posredovanje za stanove, kondominijume, nekretnine sa vremenski limitiranim vlasništvom, komercijalne nekretnine, nekretnine svih vrsta i objekata i pogodnosti koje se odnose na njih; razmjena ugovora za nepokretnosti, uključujući nepokretnosti sa vremenski limitiranim vlasništvom i druge nepokretnosti sa periodičnim vlasništvom.

Klasa 39: Transport; pakovanje i skladištenje robe; putnički aganžman; putne i turističke usluge; uređivanje tura, pratnja putnika, prevoz putnika; rad garaža, iznajmljivanje parkirališta, parking za automobile, iznajmljivanje automobila; rezervacija mjesta za putnike

i rezervaciju putovanja.

Klasa 41: Obrazovanje; pružanje obuke; zabava; sportske i kulturne aktivnosti; obezbjeđivanje rekreacionih i sportskih objekata i informacija; organizacija rekreativnih aktivnosti; obezbjeđivanje prostora za rekreaciju; organizovanje rekreativnih događaja; zabavne usluge; pružanje informacija iz oblasti zabave; obezbjeđivanje usluga zdravstvenog kluba i gimnastičarskih dvorana; usluge zabavnog kluba; usluge umjetničke galerije; obezbjeđivanje kazina i igara; organizovanje sastanaka, konferencija i izložbi.

Klasa 43: Usluge za obezbjeđivanje hrane i pića; privremeni smještaj; hotelske i usluge odmarališta, usluge rezervacije hotela; usluge restorana, kateringa i banketa; rezervisanje dugoročnog i kratkoročnog boravka u apartmanima i kondominijima; rezervacija privremenih smještaja.

Klasa 44: Higijenska zaštita i njega ljepote za ljude; spa usluge; zdravstvene spa usluge, naime, kozmetičke usluge za njegu tijela; usluge kozmetičkih salona; obezbjeđivanje sauna; usluge aromaterapije; usluge masaže.

(111) **14824**

(151) 08.10.2020.

(210) Ž-2018-390

(220) 19.10.2018.

(300) USA 87/883,582 podnijetoj 19.04.2018. godine

(732) Auberger Resorts LLC, 33 Reed Blvd, 94941-2306, Mill Valley, California, US

(540)

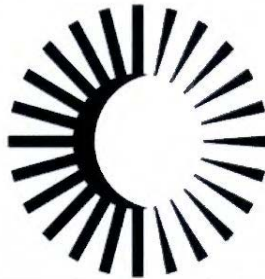

(550) I

(740) Jasna Jusić, Dalmatinska 2, 81000, Podgorica

(511) Klasa 35: Upravljanje hotelskim kompleksima i restoranima za druge.

Klasa 36: Usluge upravljanja nekretninama; iznajmljivanje stanova; usluge poslovanja s nekretninama, odnosno, izdavanje, iznajmljivanje i upravljanje nekretninama za stanovanje; usluge poslovanja s nekretninama, odnosno, usluge upravljanja kondominijumima; usluge upravljanja nekretnina koje se daju na upotrebu u vremenski ograničenom periodu.

Klasa 37: Izgradnja nepokretnosti.

Klasa 43: Hotelske usluge; hotelske usluge u turističkim kompleksima; usluge smještaja u turističkim kompleksima; obezbjeđivanje privremenog smještaja; rezervacije privremenog smještaja.

Klasa 44: Spa usluge, odnosno, kozmetičke usluge njege tijela, usluge salona za ljepotu.

(111) **14825**

(151) 06.10.2020.

(210) Ž-2019-101

(220) 13.03.2019.

(732) Al-Furat For Tobacco and Cigarettes Industry Co., Al-Basrah Street, Jabal Amman, 5th Circle, P.O.Box 941936, 11194, Amman, JO

(540)

ESCAPE

(550) I

(511) Klasa 34: Duvan, sirov ili prerađen; duvanski proizvodi uključujući cigarete, cigare, cigarilosi, duvan za motanje, duvan za lule, duvan za žvakanje, cigarete koje sadrže zamjenu duvana, koje nisu za medicinsku upotrebu; aromatizovani duvan; melasa (zamjena za duvan); burmut; elektronske cigarete; elektronske nargile; glava za elektronske nargile; upaljači za cigarete; artikli za pušače uključujući upijajući papir za duvanske lule, kutije za cigarete (tabakere), sekači za cigare, držači cigara, rezervoari gasa za upaljače, filteri za cigarete, muštikle, usnici za mustikle, papir za cigarete, usnici za cigarete, džepne mašine za uvijanje cigareta, kremeni, humidori (kutije za čuvanje cigara), čistači za duvanske lule, stalci za lule, kese za duvan, kutije za burmut, pljuvaonice za pušače, usnici od žutog ćilibara za muštikle, posude za duvan, pepeljare za pušače, tube za cigarete; bilje za pušenje; šibice; kutije za šibice; držači za šibice; duvan za nargile; duvan melasa; supstance za pušenje (koje nisu za medicinsku ili lekovitu upotrebu); aromatizovane mješavine duvana i melase za upotrebu u nargilama; aromatizovane tečnosti i rastvorljivi praškovi za upotrebu u nargilama; elektronske lule; tečnost za elektronsku nargilu sadržana od aroma u tečnom obliku za punjenje električnih nargila ili kertridža za elektronsku nargilu; nargile (šiša); pribor ili djelovi za nargile (uključujući ugalj za nargilu, činije i glave od nargile, cijevi za nargilu, podloge za nargilu, usnici i filteri za nargilu, drške od nargile, torbe i kutije za nargilu, posude od nargile).

(111) **14826**

(151) 08.10.2020.

(210) Ž-2018-508

(220) 24.12.2018.

(732) SUNNY RESORT DOO, Jadranski put bb, Budva, ME

(540)



(550) I

(511) Klasa 36: Upravljanje nekretninama; usluge posrednika za poslove s vrijednosnim papirima i dobrima; usluge administriranja zgradama, to jest usluge iznajmljivanja, procjene nekretnina ili usluge finansiranja.

Klasa 37: Izgradnja; popravke; usluge izgradnje zgrada, puteva, mostova, brana, dalekovoda kao i usluge specijalizovanih preduzeća u području izgradnje, kao što su moleri, limari, postavljači centralnog grijanja i pokrivači krovova; dodatne građevinske usluge kao što je nadziranje građevinskih projekata; popravke, to jest usluge obnavljanja bilo kojeg dotrajalog, oštećenog ili djelimično razrušenog objekta (prenamjena ili obnavljanje zgrada ili nekog drugog objekta čije prvobitno stanje ne zadovoljava); razne vrste popravaka u području elektrike, pokretnina, mašina, alata itd.; usluge održavanja kojima je cilj dovođenje objekta u njegovo prvobitno stanje bez promjene bilo kojeg njegovog svojstva (radi razlikovanja ove klase od klase 40).

Klasa 39: Prevoz; usluge iznajmljivanja prevoznih sredstava.

Klasa 43: Usluge obezbjeđivanja hrane i pića; privremeno primanje na stan; usluge rezervisanja smještaja za putnike, koje pružaju putničke agencije ili posrednici.

Klasa 45: Pravne usluge; sigurnosne usluge za zaštitu imovine i lica; usluge koje pružaju pravnicima pojedincima ili grupama pojedinaca, organizacijama ili preduzećima.

(111) **14827**

(151) 08.10.2020.

(210) Ž-2018-313

(220) 16.08.2018.

(732) SMYK SPÓLKA AKCYJNA, Domaniewska 48, 02-672, Warsaw, PL

(540)



(550) I

(511) Klasa 25: Ešarpe [šalovi]; beretke; prsluci; žensko donje rublje; donje rublje; donje rublje koje upija znoj; grudnjaci; bluže; bluže [radničke bluže]; radna odijela; boe [odjeća za oko vrata]; pantalone sa stražnjicom; cipele; čizme za skijanje; sportska obuća; čizme na

vezice; marama; kravate; šeširi za glavu; kape [za glavu]; kape za tuširanje; klompe; pletena odjeća [odjevni predmeti]; džemperi [odjevni predmeti]; espadrile; krznene stole; pregače [odjevni predmeti]; svilene kravate; gabarden tkanina; odijela; grijači za noge; korseti [donje rublje]; kombinezoni [donje rublje]; donje suknje; podsuknje; kaljače [obuća]; dokoljenice [gamaše]; prsluci; pokrivala za glavu; šeširi od papira [odjeća]; kapuljače [odjeća]; kupaće gaće; džepovi za odjeću; naramenice; okovratnici na odjeći; okovratnici koji se skidaju; kombinezoni [odjeća]; kombinezoni za skijanje na vodi; kupaći kostimi; košulje; potkošulje; kravate; jakne [odjeća]; postavljene jakne s kapuljačom (parke); helanke [pantalone]; slip gaćice; bebi gaćice; svilene marama; maske za spavanje; mufovi [odjevni predmeti]; odore [uniforme]; kape; kapice; pokrivala za glavu; zaštite za uši [odjevni predmeti]; obuća; gimnastička obuća; obuća za fudbal; obuća za plažu; sportska obuća; zaštita za okovratnike; odjeća; odjeća za bicikliste; gimnastička odjeća; konfekcijska odjeća; papirnata odjeća; vodootprna odjeća; mufovi za noge koji se ne zagrijavaju električnom energijom; odjeća za napolje; viziri za sunce; sjenila za kape; ogrtači; papuče; papuče za kupatilo; pojasevi [odjeća]; kožni rubovi za čizme i cipele; pojasevi za nošenje novca [odjevni predmeti]; pelerine; bunde; pelene za djecu od tekstilnih materijala (gaćice-pelene); obuća za fudbal; pidžame; kaputi; kupaći ogrtači; majice bez rukava (top); unutrašnji ulošci za obuću; postave, konfekcijske [dijelovi odjeće]; tregeri; tregeri [držači] za muške čarape; podvezice za čarape; čarape; čarape koje apsorbuju znoj; znojnice za pazuh; polučizmice; ogrtači za zaštitu od prašine; džemperi; hulahopke; rukavice [odjeća]; rukavice bez prstiju; sandale; sandale za kupanje; sari [ženski odjevni predmeti]; kratke čarape; odjeća od imitacije kože; kožna odjeća; gaćice; pantalone; suknje; grudnjaci; kupaći kostimi; kostimi za maskenbal; odjeća za plažu; haljine; džemperi; šalovi; marama; ešarpe za odijevanje; naramenice; kućni ogrtači; portikle, ne od papira; toge; trikoi; majice kratkih rukava; turbani; velovi [odjeća]; kompleti dječjeg rublja [odjeća]; artikli iz grupe čarapa; punjene jakne (odjeća).

Klasa 26: Brojke za označavanje posteljine; kopče za bluze; patent zatvarači; šljokice za odjeću (dodaci za odjeću); lažne brade; broševi [odjevni dodaci]; zakrpe za ukrašavanje tekstilnih artikala koje se nanose uz pomoć topiote; elastične trake; značke, od neplemenitih metala; ukrasne značke; nabori [čipkani rad]; nabori za odjeću; volani na suknjama; rese; pletenice; vijenci od vještačkog cvijeća; dugmad; vez; dodaci za šešire; rajfovi za kosu; potporni umeci za održavanje oblika okovratnika; vunene vezice; čipkani dodaci [pozamanterijska roba]; ukosnice za kovrdžanje; vještačko cvijeće; šljokice za odjeću [dodaci za odjeću]; obrubi za odjeću [bordure]; Slova za označavanje posteljine; brojke za označavanje posteljine; lažni rubovi; narukvice za pridržavanje podignutih rukava; vještačko voće; vezeni vijenci [vez]; ukrasi za cipele; ukrasni predmeti za kosu; papirići za kovrdžanje; galanterija, osim konca; perike; pikot čipka; perje [odjevni dodaci]; kićanke (pomponi); ptičje perje [odjevni dodaci]; rozete [galanterija]; mreže za kosu; nojevo perje [odjevni dodaci]; patent zatvarači; vezice za obuću; lažni brkovi; lažna kosa; trake za nabiranje zavjesa; pletenice od kose; ekstenzije; umeci za kosu; uvijači za kosu [osim ručnih alata], neelektrični; pletenice od kose; vijenci od vještačkog cvijeća; ukosnice za kosu; vrpce za kosu; šnale; vrpce [galanterija]; nagradne trake.

Klasa 35: Usluge maloprodaje i veleprodaje, takođe putem pošte, putem interneta ili na bilo koji način na daljinu u vezi sa sljedećim proizvodima: odjećom, obućom, pokrivalima za glavu, dodacima za odjeću, predmetima za šivenje, ukrasnim tekstilnim predmetima, ukrasima za kosu, valjcima za kosu, predmetima za učvršćivanje kose, perikama, lažnom kosom, vještačkim voćem, povrćem i cvijećem; agencije za uvoz-izvoz; agencije za komercijalne informacije; reklamne agencije; analize cijene koštanja; tržište (pretraživanje

tržišta); proučavanja tržišta; ispitivanje javnog mnjenja; poslovna ispitivanja; poslovno istraživanje; uređenje izloga; ponuda roba putem komunikacionih medija, u maloprodajne svrhe; odabir osoblja postupkom psihološkog testiranja; stručne poslovne konsultacije; konsultantske usluge vezane za poslovnu organizaciju i upravljanje; savjetovanje o osobiju; pomoć u vođenju poslova; raspodjela reklamnog materijala; usluge ekspertiza za poslovnu efikasnost; fakturisanje; usluge fotokopiranja; potrošači (pružanje komercijalnih savjeta i informacija potrošačima) [prodavnica za savetovanje potrošača]; poslovna procjena; poslovne informacije; distribucija uzoraka; sakupljanje informacija u kompjuterskim bazama podataka; sistematizacija informacija u kompjuterskim bazama podataka; kompjutersko upravljanje podacima; marketing; usluge modeliranja u svrhu reklamiranja ili promocije prodaje; obrada teksta; organizovanje izložbi u komercijalne ili reklamne svrhe; usluge podugovaranja [poslovna pomoć]; postavljanje plakata; modne revije za promotivne svrhe (organizovanje); demonstracija proizvoda; pomoć u upravljanju industrijskim ili trgovačkim preduzećima; pomoć u vođenju poslova; prezentacija robe putem komunikacijskih medija, u maloprodajne svrhe; promovisanje prodaje za druge; odnosi s javnošću; oglašavanje; plakatiranje; reklamiranje on-line na kompjuterskoj mreži; pisanje publicističkih tekstova; reklamiranje putem poštanske porudžbenice; pripremanje publicističkih kolumni; radijsko reklamiranje; televizijsko reklamiranje; selekcija osoblja; reklamiranje putem pošte; distribucija reklamnih oglasa; sistematizacija informacija u kompjuterske baze podataka; organizovanje trgovačkih sajmova u komercijalne ili reklamne svrhe; izdavanje tekstova; usluge telemarketinga; ažuriranje reklamnog materijala; iznajmljivanje vremena za reklamiranje na komunikacijskim medijima; iznajmljivanje reklamnog materijala; iznajmljivanje reklamnih prostora; pretraživanja podataka u kompjuterskim datotekama za druge; prikupljanje informacija u kompjuterske baze podataka; nabavka za druge [pribavljanje proizvoda i usluga za druga preduzeća]; komercijalna administracija u vezi sa licenciranjem roba i usluga za druge; savjetodavne usluge za upravljanje preduzećima; pomoć u upravljanju poslovnim aktivnostima; administrativna obrada narudžbi; vođenje kompjuterizovanih datoteka.

(111) **14828**

(151) 08.10.2020.

(210) Ž-2018-319

(300) Evropska registracija žiga broj 017888257 od 16.04.2018. godine

(220) 23.08.2018.

(732) British American Tobacco (Brands) Inc., 251 Little Falls Drive, Suite 100, DE 19808-1674, Wilmington, Delaware, US

(540)

PALL MAL EXPERIENCE

(550) I

(511) Klasa 34: Cigarete; duvan, sirov ili prerađen; proizvodi od duvana; zamjene za duvan (ne u medicinske svrhe); cigare; cigarilosi; upaljači; šibice; artikli za pušaće; cigaret papir, cigaret tube, filteri za cigarete; džepni aparati za zamotavanje cigareta; ručne mašine za

ubrizgavanje duvana u papirne tube; elektronske cigarete; tečnosti za elektronske cigarete; duvanski proizvodi namijenjeni za zagrijavanje.

(111) **14829**

(151) 08.10.2020.

(210) Ž-2019-162

(220) 12.04.2019.

(732) ADDIKO BANK AG, Wipplingerstrasse 34/4 OG, 1010, Bec, AT

(540)

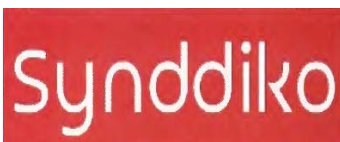

(550) I

(740) Lana Vukmirović Mišić, Bulevar Džordža Vašingtona, br. 102, A-18, 81000, Podgorica

(511) Klasa 35: Oglašavanje i reklamiranje; vođenje komercijalnih poslova; komercijalna administracija; kancelarijski poslovi.

Klasa 36: Osiguranje; finansijski poslovi; monetarni poslovi; upravljanje nekretninama.

(111) **14830**

(151) 08.10.2020.

(210) Ž-2019-62

(220) 20.02.2019.

(732) CRIB & BEER D.O.O. PODGORICA, Njegoševa br.34, 81000, Podgorica, ME

(540)



(550) I

(740) Dragan S. Nikolić, Veliše Mugoše I/9, Podgorica

(511) Klasa 16: Ambalaža (kartonska ili papirnata za boce); boce (kartonska ili papirna)

ambalaža za boce); boce (kartonski ili papirni omoti za boce); boce (papirni podmetači za boce); brošure; časopisi (periodični); časopisi (revije); čestitke fascikle (kancelarijski pribor); fascikle (papirni proizvodi); fascikle za papir fotografije (štampane); kalendari (godišnjaci); kalendari kojima se listovi trgaju; katalozi knjige (oznake za stranice u knjigama); knjige sa pjesmama letci, flajeri; naljepnice, štamparski blokovi; novine; novine sa stripovima; olovke; omotači za boce, papirnati ili kartonski; pakovanje hrane (folije od papira ili plastike za održavanje vlage, za pakovanje hrane); pivske čaše (podmetači za pivske čaše); plakati (papirnat ili kartonske podloge za plakate); plakati (poster); plakati, papirni ili kartonski; salvete od papira za stolove; slikarska platna; slikarske četkice; slikarski stalci; slike; stripovi (novine sa stripovima); sveske za pisanje i crtanje; vrećice (omotnice, džepovi) od papira ili plastike za ambalažu.

Klasa 41: Dekor za priredbe (iznajmljivanje dekora za priredbe); digitalne slike (usluge digitalnog snimanja); disk džokeji (usluge disk džokeja) usluge; diskoteke (usluge diskoteka); elektronske publikacije (iskorištavanje elektronskih publikacija koje se ne mogu prenositi on-line); filmovi (prikazivanje igranih filmova); filmovi (proizvodnja filmova); fotografisanje; fotografske reportaže; igre za novac; informacije o obrazovanju; informacije o razonodi; informacije u vezi rekreacije; izdavanje knjiga; izložbe (organizovanje izložbi) u kulturne ili obrazovne svrhe; iznajmljivanje audio uređaja; iznajmljivanje dekora za priredbe; iznajmljivanje igrački; iznajmljivanje kinematografskih filmova; iznajmljivanje videokamera; iznajmljivanje videotraka; iznajmljivanje zvučnih snimaka; klubovi (usluge klubova) [zabava ili obrazovanje]; knjige (izdavanje knjiga); knjige (posuđivanje knjiga); komponovanje muzike; komponovanje muzike (usluge komponovanja muzike); koncerti (organizovanje i vođenje koncerata); konferencije (organizovanje i vođenje konferencija); kongresi (organizovanje i vođenje kongresa); modne revije za zabavne svrhe (organizovanje); montaža radio i televizijskih programa; muzejske usluge [predstavljanje, izložbe]; muzičke sale; noćni klubovi; objavljivanje knjiga i časopisa, elektronski on line; objavljivanje tekstova [osim u reklamne svrhe]; obrazovanje (informacije o obrazovanju); obrazovanje [obuka]; obuka; obuka [predavanje]; obuka putem dopisivanja; organizovanje i vođenje koncerata; organizovanje i vođenje konferencija; organizovanje i vođenje kongresa; organizovanje i vođenje radionica za stručno osposobljavanje; organizovanje i vođenje razgovora; organizovanje i vođenje seminara; organizovanje izložba u kulturne i obrazovne svrhe; organizovanje javnih konkursa [obrazovanje ili rasonoda]; organizovanje konkursa ljepote; organizovanje plesova; organizovanje spektakla [usluge impresarija]; organizovanje sportskih takmičenja; orkestri (usluge orkestra); pisanje tekstova [ne u reklamne svrhe]; planiranje prijema [razonoda]; posuđivanje knjiga; pozorišne predstave; pozorišni dekor (iznajmljivanje pozorišnog dekora); pozorišni glumci (usluge pozorišnih glumaca); pozorišni preduzetnici [impresariji] (usluge pozorišnih preduzetnika); prijemi (planiranje prijema) [razonoda]; priredbe (iznajmljivanje dekora za priredbe); priredbe (održavanje priredbi); priredbe (organizovanje priredbi) [usluge impresarija]; priredbe (proizvodnja priredbi); proizvodnja filmova; proizvodnja filmova na videotrakama; proizvodnja muzike; putujuće biblioteke (usluge putujućih biblioteka); radio televizijski programi (montaža radio televizijskih programa); radioaparati i televizori (iznajmljivanje radioaparata i televizora); razgovori (organizovanje i vođenje razgovora); rasonoda; rasonoda (informacije u vezi rasonode); rasonoda posredstvom radija; rasonoda posredstvom televizije; rekreacija (obavještenja u vezi rekreacije); reportaže (fotografske reportaže); reporterske usluge; rezervisanje mjesta za priredbe; scenarijumi (izrada scenarijuma); seminari (organizovanje i vođenje seminara); simpozijumi (organizacija i vođenje simpozijuma); simpozijumi (organizovanje i vođenje simpozijuma); slobodno vrijeme (usluge za ispunjavanje slobodnog

vremena); snimanje na videotrake; sportska takmičenja (organizovanje sportskih takmičenja); sportska usavršavanja (sportski kampovi za usavršavanje u sportu); sportska oprema (iznajmljivanje sportske opreme osim vozila); studio za snimanje (usluge studija za snimanje); tekstovi (objavljivanje tekstova) [osim u reklamne svrhe]; tekstovi (sastavljanje tekstova) [ne u reklamne svrhe]; televizija (razonoda na televiziji); televizijski programi (montaža radio i televizijskih programa); televizori (iznajmljivanje televizora i radioaparata); titlovanje filmova; ulaznice za priredbe (agencije za ulaznice za priredbe) [razonoda]; videotrake (iznajmljivanje videotraka); videotrake (montaža videotraka); videotrake (produkcija filmova na videotrakama); videotrake (snimanje na videotrake); zabavni parkovi [cirkusi]; zdravstveni klubovi (usluge zdravstvenih klubova) [održavanje zdravlja i fizičke forme]; zvučni snimci (iznajmljivanje zvučnih snimaka).

Klasa 43: Agencije za smještaj [hotelski, pansioni]; barovi (usluge barova); hotelske rezervacije (usluge rezervisanja hotela); hotelske usluge; iznajmljivanje aparata za kuvanje iznajmljivanje privremenog smještaja; iznajmljivanje sala, dvorana za sastanke; iznajmljivanje stolaca, stolova, stolnog rublja i staklenog posuđa; kafane [kafeterije]; kafane; restorani; kantine; ljetovališta; ljetovanje (usluge kampova za ljetovanje); moteli (usluge motela); pansion za životinje; pansioni; pansioni (rezervisanje pansiona); privremeni smještaj (rezervisanje privremenog smještaja); restorani; restorani sa samoposluživanjem; restorani za brzo i stalno posluživanje [snek-barovi]; rezervisanje hotela; rezervisanje pansiona; rezervisanje privremenog smještaja; smještaj (agencije za izdavanje smještaja) [hoteli, pansioni]; smještaj (iznajmljivanje privremenog smještaja); ugostitelji (usluge kateringa).

(111) **14831**

(151) 09.10.2020.

(210) Ž-2019-269

(220) 09.07.2019.

(732) MILAN GOLOVIĆ, Radoja Dakića 5/17 stan 24, ME

(540)



(550) I

(740) Dragan S. Nikolić, Ul. Veliše Mugoše I/9, 81000, Podgorica

(511) Klasa 16: ambalaža (kartonska ili papirnata za boce) boce (kartonska ili papirna ambalaža za boce) boce (kartonski ili papirni omoti za boce) boce (papirni podmetači za boce) – brošure – časopisi [periodični] – časopisi [revije] čestitke fascikle [kancelarijski pribor] fascikle [papirni proizvodi] fascikle za papir fotografije [štampane] kalendari kalendari [godišnjaci] kalendari kojima se listovi trgaju katalogi knjige (oznake za stranice u knjigama)

knjige sa pjesmama letci, flajeri – naljepnice, štamparski blokovi – novine – novine sa stripovima – olovke – omotači za boce, papirnati ili kartonski – pakovanje hrane (folije od papira ili plastike za održavanje vlage, za pakovanje hrane) – pivske čaše (podmetači za pivske čaše) – plakati (papirnate ili kartonske podloge za plakate) – plakati [posterij] – plakati, papirni ili kartonski –salvete od papira za stolove – slikarska platna – slikarske četkice – slikarski stalci – slike –stripovi (novine sa stripovima) – sveske za pisanje i crtanje – vrećice [omotnice, dzepovi], od papira ili plastike za ambalažu.

Klasa 41: dekor za priredbe (iznajmljivanje dekora za priredbe) - digitalne slike (usluge digitalnog snimanja) - disk džokeji (usluge disk dzokeja) usluge- diskoteke (usluge diskoteka) - elektronske publikacije (iskorištavanje elektronskih publikacija koje se ne mogu prenositi on-line) - filmovi (prikazivanje igranih filmova) - filmovi (proizvodnja filmova) - fotografije sanje - fotografske reportaže – igre za novac - informacije o obrazovanju - informacije o razonodi - informacije u vezi rekreacije - izdavanje knjiga - izložbe (organizovanje izložbi) u kulturne ili obrazovne svrhe - iznajmljivanje audio uređaja - iznajmljivanje dekora za priredbe - iznajmljivanje igrački - iznajmljivanje kinematografskih filmova - iznajmljivanje videokamera - iznajmljivanje videotraka - iznajmljivanje zvučnih snimaka - klubovi (usluge klubova) [zabava ili obrazovanje] - knjige (izdavanje knjiga) - knjige (posuđivanje knjiga) - komponovanje muzike - komponovanje muzike (usluge komponovanja muzike) - koncerti (organizovanje i vođenje koncerata) - konferencije (organizovanje i vođenje konferencija) - kongresi (organizovanje i vođenje kongresa) - modne revije za zabavne svrhe (organizovanje) – montaža radio i televizijskih programa - muzejske usluge [predstavljanje, izložbe] - muzičke sale - noćni klubovi - objavljivanje knjiga i časopisa, elektronski on line - objavljivanje tekstova [osim u reklamne svrhe] - obrazovanje (informacije o obrazovanju) – obrazovanje [obuka] - obuka - obuka [predavanje] - obuka putem dopisivanja - organizovanje i vođenje koncerata - organizovanje i vođenje konferencija - organizovanje i vođenje kongresa - organizovanje i vođenje radionica za stručno osposobljavanje - organizovanje i vođenje razgovora - organizovanje i vođenje seminara - organizovanje izložba u kulturne i obrazovne svrhe - organizovanje javnih konkursa [obrazovanje ili rasonoda] - organizovanje konkursa ljepote - organizovanje plesova - organizovanje spektakla [usluge impresarija] - organizovanje sportskih takmičenja - orkestri (usluge orkestra) - pisanje tekstova [ne u reklamne svrhe] - planiranje prijema [razonoda] - posuđivanje knjiga - pozorišne predstave - pozorišni dekor (iznajmljivanje pozorišnog dekora) - pozorišni glumci (usluge pozorišnih glumaca) - pozorišni preduzetnici [impresariji] (usluge pozorišnih preduzetnika) - prijemi (planiranje prijema) [razonoda] - priredbe (iznajmljivanje dekora za priredbe) - priredbe (održavanje priredbi) – priredbe (organizovanje priredbi) [usluge impresarijaja] - priredbe (proizvodnja priredbi) - proizvodnja filmova - proizvodnja filmova na video-trakama - proizvodnja muzike - putujuće biblioteke (usluge putujućih biblioteka) - radio televizijski programi (montaža radio televizijskih programa) - radioaparati i televizori (iznajmljivanje radioaparata i televizora) - razgovori (organizovanje i vođenje razgovora) • -razonoda - rasonoda (informacije u vezi rasonode) - rasonoda posredstvom radija - rasonoda posredstvom televizije - rekreacija (obavještenja u vezi rekreacije) - reportaže (fotografske reportaže) - reporterske usluge - rezervisanje mjesta za priredbe – scenarijumi (izrada scenarijuma) - seminari (organizovanje i vođenje seminara) - simpozijumi (organizacija i vođenje simpozijuma) – simpozijumi (organizovanje i vođenje simpozijuma) - slobodno vrijeme (usluge za ispunjavanje slobodnog vremena) - snimanje na videotrake - sportska takmičenja organizovanje sportskih takmičenja) - sportska usavršavanja (sportski kampovi za usavršavanje u sportu) - sportske opreme (iznajmljivanje sportske opreme osim vozila) - studio za snimanje (usluge studija za snimanje) - tekstovi

(objavljivanje tekstova) [osim u reklamne svrhe] - tekstovi (sastavljanje tekstova) [ne u reklamne svrhe] - televizija (razonoda na televiziji) - televizijski programi (montaža radio i televizijskih programa) - televizori (iznajmljivanje televizora i radioaparata) - titlovanje filmova - ulaznice za priredbe (agencije za ulaznice za priredbe) [razonoda] - videotrake (iznajmljivanje videotraka) - videotrake (montaža videotraka) - videotrake (proizvodnja filmova na videotrakama) - videotrake (snimanje na videotrake) – zabavni parkovi [cirkusi]- zdravstveni klubovi (usluge zdravstvenih klubova) [održavanje zdravlja i fizičke forme] - zvučni snimci (iznajmljivanje zvučnih

Klasa 43: agencije za smještaj [hotelski, pansionski] - barovi (usluge barova) - hotelske rezervacije (usluge rezervisanja hotela) - hotelske usluge - iznajmljivanje aparata za kuvanje - iznajmljivanje privremenog smještaja - iznajmljivanje sala, dvorana za sastanke - iznajmljivanje stolaca, stolova, stolnog rublja i staklenog posuđa - kafane [kafeterije] - kafane - restorani -kantine – ljetovališta - ljetovanje (usluge kampova za ljetovanje) - moteli (usluge motela) - pansion za životinje - pansioni - pansioni (rezervisanje pansiona) - privremeni smještaj (rezervisanje privremenog smještaja) -restorani – restorani sa samoposluživanjem - restorani za brzo i stalno posluživanje [snek-barovi] - rezervisanje hotela - rezervisanje pansioria - rezervisanje privremenog smještaja – smještaj (agencije za izdavanje smještaja) [hoteli, pansioni] - smještaj (iznajmljivanje privremenog smještaja) - ugostitelji (usluge keteringa).

(111) **14832**

(151) 09.10.2020.

(210) Ž-2019-290

(220) 02.08.2019.

(732) "Plan B" d.o.o., Ul. Mitra Bakića br.40, 81000, Podgorica, ME

(540)



(550) I

(511) Klasa 43: kafane,restorani

(111) **14833**

(151) 09.10.2020.

(210) Ž-2019-147

(220) 03.04.2019.

(732) Fidanian Olga,(Helga Twinkle-fox), Majnski put, 57, st.4, Budva, ME
(540)

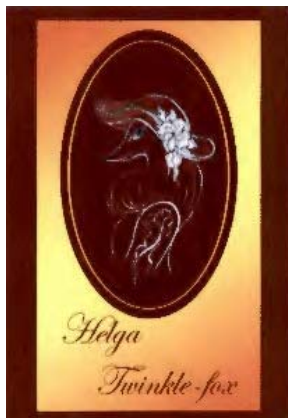

(550) I

(740) Milovan Orović, Filipa Kovačevića 23, Budva

(511) Klasa 14: Dragoceni metali i njihove legure i proizvodi od dragocenih metala ili sa prevlakom od njih, koji nisu uključeni u druge klase; nakit, drago kamenje, časovničarski i hronometrijski instrumenti; dragocene metale, proizvode od dragocenih metala koji nisu uključeni u druge klase, uopšteno nakit, časovnike i satove; nakit (imitacije nakita i nakit od plemenitih metala i dragulje); dugmad za manžetne, igle za kravate; specijalizovana dizajnerska djelatnost.

Klasa 25: Odjeća, obuća, pokrivala za glavu.

Klasa 28: Igre i igračke; gimnastički i sportski predmeti koji nisu obuhvaćeni drugim klasama; ukrasi za božićne jelke; aparate za razonodu ili za igranje koncipirane za upotrebu s nezavisnim ekranom za prikazivanje ili s monitorom; pribor za pecanje; sprave za sport i zimske igre.

(111) **14834**

(151) 08.10.2020.

(210) Ž-2018-350

(220) 10.09.2018.

(732) State Power Investment Corporation Limited, Building 3, No. 28, Financial Street, Xicheng District, Beijing, CN

(540)

SPIC

(550) I

(740) Božidar S. Radulović, Baku 30/5, 81000, Podgorica
(511) Klasa 4: Goriva; plinsko gorivo; kerozin; plinsko ulje; ugalj; ugljena prašina [gorivo]; električna energija; struja; mineralna goriva.

(111) **14835**
(151) 12.10.2020.
(210) Ž-2019-517
(220) 27.12.2019.
(732) Miljan Babić, Borovica bb, Pljevlja, ME
(540)



(550) I

(511) Klasa 20: Plastični proizvodi koji nijesu obuhvaćeni drugim klasama, zatvarači za boce i nemetalni.

Klasa 21: Stakleni proizvod, staklene posude, staklene posude oble, staklo i obojeno.

Klasa 33: Alkoholna pića(izuzev piva) i vina.

Klasa 35: Maloprodaja, veleprodaja, izvoz, uvoz, oglašavanje, reklamiranje, distribucija, marketing, oglašavanje [reklamiranje], plakatiranje [oglašavanje], prezentacija proizvoda na svim komunikacionim sredstvima u svrhu prodaje na malo, reklamiranje (iznajmljivanje prostora za potrebe reklamiranja), reklamiranje on-line na informatičkoj mreži, reklamiranje putem televizije i sajmovi (organizovanje sajmova u komercijalne ili reklamne svrhe).

Klasa 39: Ambalažiranje i skladištenje proizvoda, brod (prevoz brodom), skladištenje, željeznica (prevoz željeznicom) i informacije u vezi skladištenja.

Klasa 41: Stručno osposobljavanje prikazivanja javnosti umjetničkih djela u kulturne i obrazovne svrhe, organizovanje i vođenje seminara.

(111) **14836**
(151) 13.10.2020.
(210) Ž-2019-393
(220) 15.10.2019.
(732) Aktiebolaget Electrolux, 105 45, Stockholm, SE

(540)

ARTHUR MARTIN

(550) I

(740) AOD "Ćupić", Bulevar Džordža Vašingtona 79, 81000, Podgorica

(511) Klasa 8: Pribor za jelo; kuhinjski noževi; oštrači za noževe.

Klasa 11: Električne posude za kuvanje na pari.

Klasa 21: Posuđe i posude za domaćinstvo ili kuhinju; posuđe; posuđe za pečenje i stolno posuđe osim viljuški, noževa i kašika; posude za kuvanje na pari; pribor za posluživanje.

(111) **14837**

(151) 13.10.2020.

(210) Ž-2019-174

(220) 30.04.2019.

(732) Best Western International, Inc., 6201 North 24th Parkway, 85016, Phoenix, Arizona, US

(540)



(550) I

(740) AOD "Lutovac & partneri", Bulevar Ivana Crnojevića 93, 81000, Podgorica

(511) Klasa 43: Hotelske usluge.

(111) **14838**

(151) 13.10.2020.

(210) Ž-2019-214

(220) 04.06.2019.

(732) Shamdath Ragoebier, Dr. Sophi Redmondstraat 176 B, Paramaribo, SR

(540)



(550) I

(740) Luka Stijepović, Bulevar Svetog Petra Cetinjskog 130/VII, 81000, Podgorica

(511) Klasa 34: Duvan; cigarete; predmeti za pušaće; šibice.

(111) **14839**

(151) 13.10.2020.

(210) Ž-2019-340

(220) 06.09.2019.

(732) The Procter & Gamble Company, One Procter & Gamble Plaza, 45202, Cincinnati, Ohio, US

(540)

VIGANTOLVIT

(550) I

(740) AOD "Lutovac & partneri", Bulevar Ivana Crnojevića 93, 81000, Podgorica

(511) Klasa 5: Farmaceutski preparati i lijekovi; dijetalna hrana i supstance za medicinsku upotrebu; dodaci prehrani za ljude i bebe; medicinski gips i medicinski flasteri; vitamini i vitaminski preparati; mineralni dodaci prehrani za medicinske svrhe; preparati sa probiotskim bakterijama za medicinske svrhe.

(111) **14840**

(151) 13.10.2020.

(210) Ž-2019-341

(220) 06.09.2019.

(732) The Procter & Gamble Company, One Procter & Gamble Plaza, 45202, Cincinnati, Ohio, US

(540)

VIGANTOLETTEN

(550) I

(740) AOD "Lutovac & partneri", Bulevar Ivana Crnojevića 93, 81000, Podgorica
(511) Klasa 5: Farmaceutski preparati i lijekovi; dijetalna hrana i supstance za medicinsku upotrebu; dodaci prehrani za ljude i bebe; medicinski gips i medicinski flasteri; vitamini i vitaminski preparati; mineralni dodaci prehrani za medicinske svrhe; preparati sa probiotskim bakterijama za medicinske svrhe.

(111) **14841**

(151) 13.10.2020.

(210) Ž-2019-339

(220) 06.09.2019.

(732) DRUŠTVO SA OGRANIČENOM ODGOVORNOŠĆU "SAVA CAR" PODGORICA,
Ul. Vukašina Markovića br.184, 81000, Podgorica, ME

(540)

Za svaki slučaj

(550) I

(511) Klasa 42: Naučne i tehnološke usluge kao i pripadajuće usluge istraživanja i koncepcije; usluge industrijskih analiza i istaživanja; koncepcija i razvoj računara i računarskih programa/hardvera i softvera/.

(111) **14842**

(151) 13.10.2020.

(210) Ž-2019-424

(220) 04.11.2019.

(732) Boris Rašković, ul.Jovana Tomaševića br.9, Podgorica, ME

(540)

MAČAK

(550) I

(740) AOD "Ćupić", Bulevar Džordža Vašingtona 79, 81000, Podgorica
(511) Klasa 29: Meso, riba, živina i divljač; mesni ekstrakti; konzervirano, sušeno i kuvano voće i povrće; želei, džemovi, kompoti; jaja, mlijeko i mliječni proizvodi; jestiva ulja i masti.
Klasa 31: Poljoprivredni, povrtlarski, šumski proizvodi i bobice, koji nisu obuhvaćeni drugim klasama; žive životinje; svježe voće i povrće; sjeme, prirodne biljke i cvijeće; hrana za životinje; slad.

Klasa 33: Alkoholna pića (osim piva).

(111) **14843**

(151) 13.10.2020.

(210) Ž-2019-300

(220) 29.07.2019.

(732) Kerzner International Limited, Atlantis Paradise Island, Coral Towers Executive Office, P.O. Box N4777, Nassau, BS

(540)

ONLY HERE

(550) I

(740) Jasna Jusić, Dalmatinska 2, 81000, Podgorica

(511) Klasa 43: Pružanje usluga odmarališta i smještaja; pružanje privremenog smještaja; obezbjeđivanje hotelskog smještaja; hotelske usluge; usluge hotela rizorta u vidu organizovanja smještaja u odmaralištima; restoranske i barske usluge; obezbjeđivanje kongresnih objekata, pružanje objekata (smještaja) za priredbe i sastanke; usluge putničkih agencija, naime rezervisanje i bukiranje za privremeni smještaj, rezervisanje i bukiranje za objedovanje.

(111) **14844**

(151) 13.10.2020.

(210) Ž-2019-327

(220) 04.09.2019.

(732) Merck Sharp & Dohme Corp., One Merck Drive, 08889, Whitehouse Station, New Jersey, US

(540)

RECARBRIO

(550) I

(740) Jasna Jusić, Dalmatinska 2, 81000, Podgorica

(511) Klasa 5: Farmaceutski preparati.

(111) **14845**

(151) 13.10.2020.

(210) Ž-2019-329

(220) 04.09.2019.

(732) Merck Sharp & Dohme Corp., One Merck Drive, 08889, Whitehouse Station, New Jersey, US

(540)

PREVYMIS

(550) I

(740) Jasna Jusić, Dalmatinska 2, 81000, Podgorica

(511) Klasa 5: Farmaceutski preparati.

(111) **14846**

(151) 13.10.2020.

(210) Ž-2019-330

(220) 04.09.2019.

(732) Merck Sharp & Dohme Corp., One Merck Drive, 08889, Whitehouse Station, New Jersey, US

(540)

PEXETINEM

(550) I

(740) Jasna Jusić, Dalmatinska 2, 81000, Podgorica

(511) Klasa 5: Farmaceutski preparati.

(111) **14847**

(151) 13.10.2020.

(210) Ž-2019-331

(220) 04.09.2019.

(732) Merck Sharp & Dohme Corp., One Merck Drive, 08889, Whitehouse Station, New Jersey, US
(540)

ZEMVETIS

(550) I

(740) Jasna Jusić, Dalmatinska 2, 81000, Podgorica

(511) Klasa 5: Farmaceutski preparati.

(111) **14848**

(151) 14.10.2020.

(210) Ž-2019-378

(220) 24.09.2019.

(732) Turistička organizacija Opštine Budva, Mediteranska 8/6, TQ Plaza, 85310, Budva, ME

(540)



(550) I

(511) Klasa 35: Oglašavanje i reklamiranje; vođenje komercijalnih poslova; komercijalna administracija; kancelarijski poslovi; isporuka reklamnog materijala (letaka, prospekata, uzoraka), reklamnih oglasa, marketing, svi vidovi reklamnog oglašavanja, sajmovi, saopštenja za javnost, informacije (poslovne informacije), isporuka (distribucija) uzoraka, istraživanje javnog mnjenja (anketiranje); izdavanje propagandnog materijala javnosti (odnosi s javnošću) (propaganda), objavljivanje reklamnih tekstova, prelamanje stranica u reklamne svrhe (stavljanje u štampu u reklamne svrhe), radio (reklamiranje putem radia, predstavljanje proizvoda, plakatiranje (oglašavanje).

Klasa 39: Prevoz; ambalažiranje i skladištenje proizvoda; organizovanje putovanja; isporuka (distribucija) proizvoda, isporuka uzoraka, izleti, organizovanje putovanje, paketi (isporuka), prevoz (informacije o prevozu), turističke posjete.

Klasa 41: Obuka; stručno osposobljavanje; razonoda; sportske i kulturne djelatnosti; dekor za priredbe, dopisivanje (obuka putem dopisa), elektronske publikacije, filmovi (proizvodnja filmova), fotografisanje, fotografske reportaže, izdavanje knjiga, javni konkursi, objavljivanje knjiga i časopisa elektronski on line, elektronske publikacije, informacije o razonodi, koncerti (organizovanje i vođenje konferencija).

(111) **14849**

(151) 14.10.2020.

(210) Ž-2019-206

(220) 24.05.2019.

(732) NVU Žene Bara, Bulevar Dinastije Petrović, H 24, 85000, Bar, ME

(540)



(550) I

(511) Klasa 3: Preparati za bijeljenje i ostale materije za pranje rublja; preparati za čišćenje, poliranje, odmaščivanje i struganje; sapuni; parfimerijski proizvodi, eterična ulja, kozmetički proizvodi, losioni za kosu; proizvodi za njegu zuba; proizvode za čišćenje i toaletne proizvode; dezodoranse (parfimerija); proizvode za osvježavanje (parfemisanje) prostorija.

Klasa 14: Plemeniti metali i njihove legure i proizvodi od tih metala ili obloženi tim metalima, koji nisu obuhvaćeni drugim klasama; pravi i lažni nakit, drago kamenje; časovničarski proizvodi i hronometrijski instrumenti; plemenite metale, proizvode načinjene od tih metala koji nisu obuhvaćeni drugim klasama i, uopšteno, draguljarske proizvode, nakit i časovničarske proizvode; pravi i lažni nakit; dugmad za manžetne, igle za kravate.

Klasa 15: Muzički instrumenti; mehanički klaviri i njihov pribor; muzičke kutije; električni i elektronski muzički instrumenti.

Klasa 16: Papir, karton i proizvodi od tih materijala koji nisu obuhvaćeni drugim klasama; štamparski proizvodi; proizvodi za uvezivanje knjiga; fotografije; pribor za pisanje; ljepila (ljepljive materije za papirnate proizvode ili za kućne potrebe); slikarski pribor; kistovi; pisaće mašine i kancelarijski pribor (osim namještaja); oprema za nastavu i obuku (osim aparata); plastični materijali za ambalažu (koji nisu obuhvaćeni drugim klasama); štamparska slova; klišeji; papir, papirnati proizvodi i kancelarijski pribor; noževi za papir; aparati za umnožavanje; plastične folije, torbe i vrećice od plastičnog materijala, za ambalažu.

Klasa 17: Guma, gutaperka, biljna smola, azbest, liskun i proizvodi od tih materijala koji nisu obuhvaćeni drugim klasama; proizvodi od polu obrađene plastike; materijali za nepropusno zatvaranje, za zaptivanje i za izolaciju; nemetalne savitljive cijevi; električna, termička ili akustična izolacijska sredstva te polu obrađena plastika u listovima, pločama ili štapićima; guma za popravak zračnica; gumene ili plastične materije za punjenje (nabijanje); ploveće barijere protiv zagađenja.

Klasa 18: Koža, imitacije kože, proizvodi od tih materijala koji nisu obuhvaćeni drugim klasama; životinjske kože; koferi i torbe; kišobrani, suncobrani i štapovi za hodanje; bičevi i sedlarsko remenarski proizvodi; koža i kožne imitacije, predmeti za putovanja koji nisu obuhvaćeni drugim klasama i sedlarsko remenarski proizvodi.

Klasa 19: Nemetalni građevinski materijali; čvrste nemetalne cijevi za gradnju; asfalt, katran i bitumen (smola); nemetalne prenosive konstrukcije; nemetalni spomenici; nemetalni

građevinski materijali; polu obrađeno drvo (na primjer: grede, daske, ploče); šperploču, furnir; građevinsko staklo (na primjer: pločice, stakleni crijep); granulate stakla za obilježavanje puteva; zidane sandučice za pisma.

Klasa 20: Namještaj, ogledala, okviri; proizvodi koji nijesu obuhvaćeni drugim klasama, od drveta, plute, trske, šiblja, roga, kosti, slonovače, kitove kosti, školjki, ćilibara, sedefa, morske pjene (stive); zamjena svih tih materijala ili plastični proizvodi; namještaj i njegove dijelovi kao i plastični proizvodi koji nijesu obuhvaćeni drugim klasama; metalni namještaj i namještaj za kampove; oprema za krevete (na primjer: strunjače, dušeci, jastuci); ogledala, ukrasna ogledala, toaletna ogledala; nemetalne registarske tablice; sandučici za pisma koji nijesu od metala ili zidani.

Klasa 21: Pribor i posuđe za domaćinstvo ili za kuhinju; češljevi i sunđeri; četke (osim kičica); materijali za četke; pribor za čišćenje; žica za struganje parketa; sirovo ili polu obrađeno staklo (osim građevinskog stakla); stakleni proizvodi, porculansko i keramičko posuđe koje nije obuhvaćeno drugim klasama; sitni pribor i aparati za domaćinstvo i za kuhinju, koji se pokreću ručno, kao i toaletni pribor, stakleni i porculanski proizvodi; pribor i posude za domaćinstvo i za kuhinju, kao na primjer: kuhinjsko metalno posuđe, kante, kotlići limeni, aluminijske, plastične ili od nekog drugog materijala, mali, ručno pokretani aparati za sjeckanje, mljevenje, presovanje i sl.; električni češljevi; električne četkice za zube; podmetači za posude i podmetači za boce (posuđe).

Klasa 22: Konopci, užad, mreže, šatori, cerade, jedra, vreće (koje nisu obuhvaćene drugim klasama); materijali za punjenje madraca (nabijanje) (osim gume i plastike); sirovi vlaknasti, tekstilni, materijali; užad i proizvodi za jedrenje, materijali za punjenje (nabijanje) madraca kao i vlaknasti neobrađeni tekstilni materijali; konopci i kanapi od prirodnog ili vještačkog vlakna, od papira ili od plastike.

Klasa 23: Konac za tekstilnu upotrebu.

Klasa 24: Tkanine i tekstilni proizvodi koji nijesu obuhvaćeni drugim klasama; pokrivači za krevete i stolove; tkanine i pokrivači; papirnata posteljina.

Klasa 25: Odjeća, obuća, pokrivala za glavu.

Klasa 26: Čipka, vez, vrpce i gajtane; dugmad, kopče i petlje, špenadle (duple igle) i igle; vještačko cvijeće; krojački pribor i krojački predmeti; predmeti koji se koriste u krojačke svrhe.

Klasa 27: Tepisi, prostirači, strunjače, linoleumi i ostali pokrivači za podove; zidne tapete koje nijesu od tekstila; proizvodi za pokrivanje ili za oblaganje, u svrhu uređenja već izgrađenih podova i zidova.

Klasa 28: Igre i igračke; gimnastički i sportski predmeti koji nisu obuhvaćeni drugim klasama; ukrasi za božićne jelke; aparati za razonodu ili za igranje koncipirane za upotrebu s nezavisnim ekranom

za prikazivanje ili s monitorom; pribor za pecanje; sprave za sport i zimske igre.

Klasa 29: Meso, riba, živina i divljač; mesni ekstrakti; konzervirano, sušeno i kuvano voće i povrće; želei, džemovi, kompoti; jaja, mlijeko i mliječni proizvodi; jestiva ulja i masti, prehrambene namirnice životinjskog porijekla, kao i povrće i ostale jestive poljoprivredne proizvode pripremljene za potrošnju ili za konzerviranje; mliječni napitci u kojima mlijeko prevladava.

Klasa 30: Kafa, čaj, kakao, šećer, riža, tapioka, sago, zamjene za kafu; brašno i proizvodi od žitarica, hleb, kolači, poslastice, bomboni, sladoled; med, sirup od melase; kvasac, prašak za pecivo; so, senf; sirće, prelive, začini, razni začini, led za hlađenje; prehrambene namirnice biljnog porijekla pripremljene za potrošnju ili za konzerviranje, kao i dodatke za poboljšanje ukusa hrane; napitci od kave, kakao ili čokolade ili čaja; žitarice pripremljene

za ljudsku prehranu (na primjer: ovsene pahuljice ili pahuljice od drugih žitarica).

Klasa 31: Poljoprivredni, povrtlarski, šumski proizvodi i bobice, koji nisu obuhvaćeni drugim klasama; žive životinje; svježe voće i povrće; sjeme, prirodne biljke i cvijeće; hrana za životinje; slad; plodovi zemlje koji nisu pretrpjeli nikakvu pripremu radi potrošnje, žive životinje i sirove biljke kao i hranu za životinje; neobrađeno drvo; neobrađene žitarice; jaja za plantaže; žive mekušce i rakove.

Klasa 32: Pivo; mineralne i gazirane vode i ostala bezalkoholna pića; pića od voća i voćni sokovi; sirupi i ostali preparati za pripremanje napitaka; bezalkoholna pića, kao i pivo; bezalkoholna pića.

Klasa 33: Alkoholna pića (osim piva).

Klasa 35: Oglašavanje i reklamiranje; vođenje komercijalnih poslova; komercijalna administracija; celarijski poslovi; usluge koje pružaju lica ili organizacije, čija je glavna svrha: pomoć u radu i upravljanju privrednim društvima, ili pomoć u vođenju poslova ili komercijalnih funkcija industrijskog ili trgovačkog preduzeća, kao i usluge reklamnih ustanova koje se bave uglavnom reklamiranjem proizvoda i usluga putem svih vrsta medija; usluge koje se odnose na registraciju, prijepis, sastavljanje, kompilaciju ili sistematizaciju pisanih saopštenja i zapisa kao i obradu ili kompilaciju matematičkih ili statističkih podataka; usluge agencija za oglašavanje kao i usluge distribuiranja prospekata direktno ili poštom ili distribuiranje uzoraka; oglašavanja u vezi s drugim uslugama kao što su usluge u vezi bankarskih zajmova i oglašavanja putem radija; sortiranje za račun drugih osoba, raznih proizvoda (ne uključuje njihov prevoz) radi omogućavanja potrošaču njihovog lakšeg razgledanja i kupovine; ove usluge se mogu pružati u okviru prodavnica na malo, trgovina na veliko, posredstvom prodajnih kataloga, dopisno ili elektronskim putem, na primjer posredstvom weba ili putem telefona.

Klasa 36: Osiguranje; finansijski poslovi; monetarni poslovi; upravljanje nekretninama; usluge u vezi sa finansijskim i monetarnim poslovima kao i usluge u vezi ugovora o osiguranju svake vrste; usluge u vezi sa finansijskim i monetarnim poslovima, to jest: usluge svih bankarskih zavoda ili institucija vezanih za njih, kao što su mjenjačnice ili službe za naknade; usluge kreditnih zavoda koji nijesu banke, kao što su kooperativne kreditne zadruge, individualna finansijska društva, zajmodavci itd.; usluge "holding" kompanija; usluge posrednika za poslove s vrijednosnim papirima i dobrima; usluge u vezi monetarnih poslova, koje se obavljaju posredstvom povjerenika; usluge u vezi izdavanja putnih čekova i kreditnih pisama; usluge lizinga [vrsta kreditiranja]; usluge administriranja zgradama, to jest usluge iznajmljivanja, procjene nekretnina ili usluge finansiranja; usluge osiguranja koje obavljaju agenti ili posrednici koji se bave osiguranjem, usluge pružene osiguranicima kao i usluge potpisivanja osiguranja.

Klasa 40: Obrada materijala; usluge koje nijesu navedene u drugim klasama, a obuhvataju mehaničku ili hemijsku obradu ili prenamjenu neorganskih ili organskih materijala ili predmeta; usluge prenamjene proizvoda ili materijala te svaku drugu obradu pri kojoj se mijenjaju njihova bitna svojstva (na primjer bojenje odjeće); usluga održavanja (na primjer hromiranje branika kod automobila); usluge obrade materijala koje se obavljaju tokom proizvodnje bilo kojeg materijala ili predmeta koji nije građevina, na primjer, usluge rezanja, oblikovanja, poliranja struganjem ili usluge oblaganja metalom.

Klasa 41: Obuka; stručno osposobljavanje; razonoda; sportske i kulturne djelatnosti; usluge osoba ili ustanova koje se bave razvojem mentalnih sposobnosti lica ili životinja, kao i usluge razonode i zaokupljanja pažnje; usluge obučavanja osoba ili uvježbavanja životinja, u svim njihovim vidovima; usluge čiji je osnovni cilj razbibriga, zabava ili rekreacija lica; usluge prikazivanja javnosti umjetničkih i literarnih djela u kulturne

i obrazovne svrhe.

Klasa 43: Usluge obezbjeđivanja hrane i pića; privremeno primanje na stan; usluge koje pružaju lica ili preduzeća čiji cilj je priprema jela ili pića za potrošnju kao i usluge ishrane i smještaja, koje pružaju hoteli, pansioni ili druga preduzeća koja osiguravaju privremeni smještaj; usluge rezervisanja smještaja za putnike, koje pružaju putničke agencije ili posrednici; usluge pansiona za životinje.

Klasa 44: Medicinske usluge; veterinarske usluge; higijenska njega i njega ljepote za ljude ili za životinje; usluge poljoprivrede, povrtlarstva i šumarstva; usluge medicinske njege, njege higijene tijela i njege ljepote, koje pružaju osobe ili ustanove ljudima i životinjama; takođe obuhvata usluge koje se tiču područja poljoprivrede, povrtlarstva i šumarstva; usluge medicinske analize koja se odnose na medicinsku obradu osoba (kao što su radiografska ispitivanja i vađenje krvi); usluge vještačke oplodnje; konsultacije u vezi farmacije; uzgajanje životinja; usluge u vezi uzgoja biljaka kao što je povrtlarstvo; usluge u vezi cvjetnog umijeća kao što je pravljenje cvjetnih aranžmana, kao i usluge koje pružaju baštovani pejzažisti.

Klasa 45: Pravne usluge; sigurnosne usluge za zaštitu imovine i lica; lične i društvene usluge koje pružaju drugi, namijenjene za zadovoljenje ljudskih potreba; usluge koje pružaju pravnici pojedincima ili grupama pojedinaca, organizacijama ili preduzećima; usluge sprovođenja anketa i nadzora u vezi sigurnosti osoba i zajednica; usluge koje pružaju osobe u svezi društvenih događanja kao što su usluge pratnje u društvu, usluge bračnih agencija, pogrebne usluge.

(111) **14850**

(151) 17.12.2020.

(210) Ž-2019-294

(220) 26.07.2019.

(732) Apivita S.A., Industrial Park of Markopoulo, 19003 , Markopoulo Mesogaias, GR

(540)

APIVITA

(550) I

(740) Božidar S. Radulović, Studentska bb, Lamela 3/18, 81000, Podgorica

(511) Klasa 3: Kozmetički preparati za mršavljenje, kozmetika, kozmetika za životinje, kozmetičke kreme, kreme za izbjeljivanje kože, ljepila za kozmetičke svrhe, preparati aloe vere za kozmetičke svrhe, alum kamenčići (astringenti), geraniol, terpeni (eterična ulja), ulja za kozmetičke potrebe, ulja za parfeme i mirise, ulja ruže, eterična ulja, masti za kozmetičke potrebe bergamot ulje, ulje lavande, voda lavande, losioni za kozmetičke svrhe, balzami osim za medicinske svrhe, ulje jasmína, esencija mente (eterično ulje), eterična ulja kedra, aromatična eterična ulja, eterična ulja limuna, eterična ulja citróna, maramice impregnirane kozmetičkim losionima, kozmetički preparati za kupanje i tuširanje, soli za kupanje koje nisu za medicinske potrebe, losioni nakon brijanja, sredstva za izbjeljivanje (dekoloranti) za kozmetičke svrhe, vodonik peroksid za kozmetičke svrhe, pomade za kozmetičke svrhe, bademovo mlijeko za kozmetičke svrhe, bademovo ulje, bademov sapun, eterične esencije,

eterična ulja, ekstrakti cvijeća (parfemi) kolonjska voda, parfimerija, baze za cvjetne parfeme, potpuriji (mirisi), preparati za odušivanje zraka, kozmetika za obrve, olovke za obrve, kozmetički proizvodi, sredstva za zaštitu od sunca, preparati za sunčanje (kozmetika), kreme za zaštitu od sunca; kozmetički preparati za zaštitu kože od sunčevih zraka; preparati za zaštitu od sunca; losioni nakon sunčanja; proizvodi nakon sunčanja, uključujući kreme i losione; preparati za njegu kože, preparati za šminkanje, preparati za uklanjanje šminke, mlijeko za skidanje šminke, maskare, maske za ljepotu, temelji, prahovi (kompaktni prašci, praškovi za prašinu), praškovi za lice, kozmetika za oči, kozmetički preparati za trepavice, liiepkovi za pričvršćivanje lažnih trepavica, sjajila za usne, ruževe za usne, olovke za oči i usne, ajlajneri i ruževi za usne, rumenila, olovke za oči, prah za obrve, kozmetičke olovke, neutralizatori za trajno uvijanje, vosak za nausnice, paste za britve, preparati za njegu noktiju, lak za nokte, sjaj za nokte, preparati za uklanjanje laka, kozmetički proizvodi za uklanjanje šminke kao što su kreme, losioni i impregnirana tkanina za kozmetičku upotrebu; adstringensi za kozmetičke svrhe, antiperspirantni sapuni, sprejevi za osvježivanje daha, trake za osvježivanje daha, gelovi za izbjeljivanje zuba, gelovi za masažu, osim za medicinske svrhe, sredstva za ispiranje usta za medicinske potrebe, paste za zube, sredstva za čišćenje zubnih proteza, mlijeko za čišćenje za svrhe lične higijene, talk puder za svrhu lične higijene, sredstva za čišćenje, preparati za brijanje, preparati za suvo čišćenje, preparati za pranje za ličnu higijenu ili dezodorans (toaletne potrepštine), toaletna voda, toaletne potrepštine, antiperspiranti (toaletne potrepštine), ulja za toaletne potrebe, boje za toaletne potrebe, mirisna voda, kozmetički kompleti, pamučni štapići i vata za kozmetičke svrhe, sapun, „kolači od sapuna”, sapun za dezodorans, tečni sapun, sapun za brijanje, sapun za znojenje stopala, šampon, suvi šampon, šampon za kućne ljubimce, dezodorans za osobnu upotrebu, dezodoransi za ljude ili za životinje i kućne ljubimce, depilatori, preparate za depilaciju, depilatorni vosak, kozmetičke boje, puder, proizvodi za zaštitu usana, preparati za uvijanje kose, sredstva za tretiranje kose, boje za kosu, koloranti za kosu, lak za kosu, preparati za uvijanje kose, boje za bradu.

Klasa 5: Medicinski preparati za rast kose, stomatološki mastici, medicinske infuzije, medicinska ulja, medicinski korijeni, medicinski čaj, mlijeko badema za farmaceutske svrhe, sirupi za farmaceutske svrhe, sredstva za vaginalno ispiranje, termalna voda, morska voda za ljekovito kupanje, mineralne vode za medicinske potrebe, sredstva za ispiranje usta za medicinske svrhe, masti za farmaceutske svrhe, pastile za farmaceutske potrebe, blato za kupanje, ljekovito blato, medicinski sediment, prehrambeni dodaci, dijetetski dodaci propolisa, propolis za farmaceutske svrhe, proteinski dijetetski dodaci, dodaci ishrani od matične mliječi, matična mliječ u farmaceutske svrhe, soli za medicinske svrhe, farmaceutski i veterinarski preparati; dodaci prehrani od polena, sanitarni proizvodi za medicinske potrebe; preparati za žuljeve, biljni čajevi za medicinske svrhe, biološki pripravci za medicinske svrhe, albuminski prehrambeni proizvodi za medicinske svrhe, losioni za farmaceutske potrebe, dijetetske tvari prilagođene za medicinsku upotrebu, farmaceutski pripravci za njegu kože, medicinski pripravci za mršavljenje, masti za opekotine od sunca, preparati za opekotine od sunca za farmaceutske svrhe, balzami za medicinske svrhe, balzamski preparati za medicinske svrhe, pomade za medicinske potrebe, soli za kupanje u medicinske svrhe, preparati od aloe vere za farmaceutske svrhe, pripravci za kupanje s medicinskom terapijom, terapijski pripravci za kupanje, soli mineralne vode, soli za kupke od mineralne vode, slatkiši za medicinske potrebe, žvakaće gume za medicinske potrebe, hrana za bebe; ubrusi za bebe, pelene za bebe, flasteri, materijali za zavoje; dezinficijensi; bakterijski otrovi, bakterijski pripravci za medicinsku i veterinarsku upotrebu, biocidi, preparati za uništavanje štetočina; fungicidi, herbicidi, repelenti za insekte, preparati za

ozeblina, preparati za čišćenje kontaktnih sočiva, farmaceutski pripravci za liječenje peruti, pripravci od kuvanih trava za farmaceutske svrhe, sapun za dezinfekciju, sapun za medicinsku njegu, medicinski šampon.

Klasa 35: Maloprodajne usluge, veleprodajne usluge, kataloške maloprodajne usluge i online maloprodajne usluge u odnosu na gore navedene proizvode klase 3 i klase 5.

(111) **14851**

(151) 17.12.2020.

(210) Ž-2019-295

(220) 26.07.2019.

(732) Apivita S.A., Industrial Park of Markopoulo, 19003 , Markopoulo Mesogaias, GR

(540)

APIVITA



(550) I

(740) Božidar S. Radulović, Studentska bb, Lamela 3/18, 81000, Podgorica

(511) Klasa 3: Kozmetički preparati za mršavljenje, kozmetika, kozmetika za životinje, kozmetičke kreme, kreme za izbjeljivanje kože, ljepila za kozmetičke svrhe, preparati aloe vere za kozmetičke svrhe, alum kamenčići (astringenti), geraniol, terpeni (eterična ulja), ulja za kozmetičke potrebe, ulja za parfeme i mirise, ulja ruže, eterična ulja, masti za kozmetičke potrebe bergamot ulje, ulje lavande, voda lavande, losioni za kozmetičke svrhe, balzami osim za medicinske svrhe, ulje jasmína, esencija mente (eterično ulje), eterična ulja kedra, aromatična eterična ulja, eterična ulja limuna, eterična ulja citróna, maramice impregnirane kozmetičkim losionima, kozmetički preparati za kupanje i tuširanje, soli za kupanje koje nisu za medicinske potrebe, losioni nakon brijanja, sredstva za izbjeljivanje (dekoloranti) za kozmetičke svrhe, vodonik peroksid za kozmetičke svrhe, pomade za kozmetičke svrhe, bademovo mlijeko za kozmetičke svrhe, bademovo ulje, bademov sapun, eterične esencije, eterična ulja, ekstrakti cvijeća (parfemi) kolonjska voda, parfimerija, baze za cvjetne parfeme, potpuriji (mirisi), preparati za odušivanje zraka, kozmetika za obrve, olovke za obrve, kozmetički proizvodi, sredstva za zaštitu od sunca, preparati za sunčanje (kozmetika), kreme za zaštitu od sunca; kozmetički preparati za zaštitu kože od sunčevih zraka; preparati za zaštitu od sunca; losioni nakon sunčanja; proizvodi nakon sunčanja, uključujući kreme i losione; preparati za njegu kože, preparati za šminkanje, preparati za uklanjanje šminke, mlijeko za skidanje šminke, maskare, maske za ljepotu, temelji, prahovi (kompaktni prašci, praškovi za prašinu), praškovi za lice, kozmetika za oči, kozmetički preparati za trepavice, liiepkovi za pričvršćivanje lažnih trepavica, sjajila za usne, ruževe za usne, olovke za oči i usne, ajlajneri i ruževi za usne, rumenila, olovke za oči, prah za obrve,

kozmetičke olovke, neutralizatori za trajno uvijanje, vosak za nausnice, paste za britve, preparati za njegu noktiju, lak za nokte, sjaj za nokte, preparati za uklanjanje laka, kozmetički proizvodi za uklanjanje šminke kao što su kreme, losioni i impregnirana tkanina za kozmetičku upotrebu; adstringensi za kozmetičke svrhe, antiperspirantni sapuni, sprejevi za osvježivanje daha, trake za osvježivanje daha, gelovi za izbjeljivanje zuba, gelovi za masažu, osim za medicinske svrhe, sredstva za ispiranje usta za medicinske potrebe, paste za zube, sredstva za čišćenje zubnih proteza, mlijeko za čišćenje za svrhe lične higijene, talk puder za svrhu lične higijene, sredstva za čišćenje, preparati za brijanje, preparati za suvo čišćenje, preparati za pranje za ličnu higijenu ili dezodorans (toaletne potrepštine), toaletna voda, toaletne potrepštine, antiperspiranti (toaletne potrepštine), ulja za toaletne potrebe, boje za toaletne potrebe, mirisna voda, kozmetički kompleti, pamučni štapići i vata za kozmetičke svrhe, sapun, „kolači od sapuna”, sapun za dezodorans, tečni sapun, sapun za brijanje, sapun za znojenje stopala, šampon, suvi šampon, šampon za kućne ljubimce, dezodorans za osobnu upotrebu, dezodoransi za ljude ili za životinje i kućne ljubimce, depilatori, preparate za depilaciju, depilatorni vosak, kozmetičke boje, puder, proizvodi za zaštitu usana, preparati za uvijanje kose, sredstva za tretiranje kose, boje za kosu, koloranti za kosu, lak za kosu, preparati za uvijanje kose, boje za bradu.

Klasa 5: Medicinski preparati za rast kose, stomatološki mastici, medicinske infuzije, medicinska ulja, medicinski korijeni, medicinski čaj, mlijeko badema za farmaceutske svrhe, sirupi za farmaceutske svrhe, sredstva za vaginalno ispiranje, termalna voda, morska voda za ljekovito kupanje, mineralne vode za medicinske potrebe, sredstva za ispiranje usta za medicinske svrhe, masti za farmaceutske svrhe, pastile za farmaceutske potrebe, blato za kupanje, ljekovito blato, medicinski sediment, prehrambeni dodaci, dijetetski dodaci propolisa, propolis za farmaceutske svrhe, proteinski dijetetski dodaci, dodaci ishrani od matične mliječi, matična mliječ u farmaceutske svrhe, soli za medicinske svrhe, farmaceutski i veterinarski preparati; dodaci prehrani od polena, sanitarni proizvodi za medicinske potrebe; preparati za žuljeve, biljni čajevi za medicinske svrhe, biološki pripravci za medicinske svrhe, albuminski prehrambeni proizvodi za medicinske svrhe, losioni za farmaceutske potrebe, dijetetske tvari prilagođene za medicinsku upotrebu, farmaceutski pripravci za njegu kože, medicinski pripravci za mršavljenje, masti za opekotine od sunca, preparati za opekotine od sunca za farmaceutske svrhe, balzami za medicinske svrhe, balzamski preparati za medicinske svrhe, pomade za medicinske potrebe, soli za kupanje u medicinske svrhe, preparati od aloe vere za farmaceutske svrhe, pripravci za kupanje s medicinskom terapijom, terapijski pripravci za kupanje, soli mineralne vode, soli za kupke od mineralne vode, slatkiši za medicinske potrebe, žvakaće gume za medicinske potrebe, hrana za bebe; ubrusi za bebe, pelene za bebe, flasteri, materijali za zavoje; dezinficijensi; bakterijski otrovi, bakterijski pripravci za medicinsku i veterinarsku upotrebu, biocidi, preparati za uništavanje štetočina; fungicidi, herbicidi, repelenti za insekte, preparati za ozeblina, preparati za čišćenje kontaktnih sočiva, farmaceutski pripravci za liječenje peruti, pripravci od kuvanih trava za farmaceutske svrhe, sapun za dezinfekciju, sapun za medicinsku njegu, medicinski šampon.

Klasa 35: Maloprodajne usluge, veleprodajne usluge, kataloške maloprodajne usluge i online maloprodajne usluge u odnosu na gore navedene proizvode klase 3 i klase 5.

(111) **14852**

(151) 14.10.2020.

(210) Ž-2019-131

(220) 26.03.2019.

(732) PFIZER INC., 235 East 42nd Street, 10017, New York, New York, US

(540)

LORVIQUA

(550) I

(740) Jasna Jusić, Dalmatinska 2, 81000, Podgorica

(511) Klasa 5: Farmaceutski, medicinski i veterinarski preparati; sanitarni preparati za medicinske svrhe; dijetetska hrana i supstance za medicinsku ili veterinarsku upotrebu, hrana za bebe; dijetetski suplementi za ljude i životinje; flasteri, materijali za zavijanje; materijal za plombiranje zuba, zubarska smola; dezinfekciona sredstva; preparati za uništavanje štetočina; fungicidi, herbicidi.

(111) **14853**

(151) 14.10.2020.

(210) Ž-2019-132

(220) 26.03.2019.

(732) PFIZER INC., 235 East 42nd Street, 10017, New York, New York, US

(540)

LORBRENA

(550) I

(740) Jasna Jusić, Dalmatinska 2, 81000, Podgorica

(511) Klasa 5: Farmaceutski, medicinski i veterinarski preparati; sanitarni preparati za medicinske svrhe; dijetetska hrana i supstance za medicinsku ili veterinarsku upotrebu, hrana za bebe; dijetetski suplementi za ljude i životinje; flasteri, materijali za zavijanje; materijal za plombiranje zuba, zubarska smola; dezinfekciona sredstva; preparati za uništavanje štetočina; fungicidi, herbicidi.

(111) **14854**

(151) 14.10.2020.

(210) Ž-2019-159

(220) 11.04.2019.

(732) Colgate-Palmolive Company (a Delaware corporation), 300 Park Avenue, 10022, New York, New York, US

(540)

COLGATE SENSITIVE PRO-RELIEF

(550) I

(740) Jasna Jusić, Dalmatinska 2, 81000, Podgorica

(511) Klasa 3: Nemedicinska pasta za zube, nemedicinska tečnost za ispiranje usta.

Klasa 5: Medicinska pasta za zube, medicinska tečnost za ispiranje usta.

Klasa 21: Četkice za zube.

(111) **14855**

(151) 14.10.2020.

(210) Ž-2019-176

(220) 06.05.2019.

(732) R & A Bailey & Co, Nangor House, Western Estate, 12, Dublin, IE

(540)

BAILEYS

(550) I

(740) Jasna Jusić, Dalmatinska 2, 81000, Podgorica

(511) Klasa 30: Kafa, čaj, kakao, vještačka kafa; pirinač; tapioca i sago; brašno i proizvodi od žitarica; hljeb; peciva i poslastice; jestivi led; šećer, med mesala; kvasac, prašak za pecivo, so; senf; sirće, sosevi (kao dodaci jelima); začini; led (smrznuta voda).

(111) **14856**

(151) 14.10.2020.

(210) Ž-2019-202

(220) 23.05.2019.

(732) ISHIHARA SANGYO KAISHA,LTD., 3-15, Edobori, 1-chome, Nishi-ku, Osaka, JP

(540)

ZENBY

(550) I

(740) Miladin Popović, ul. Capital Plaza, ulica šeika Zajeda 13-IV/68, 81000, Podgorica
(511) Klasa 5: Fungicidi kao poljoprivredne hemikalije; insekticidi; nematicidi; herbicidi; pesticidi.

(111) **14857**

(151) 14.10.2020.

(210) Ž-2019-210

(220) 29.05.2019.

(732) Pharmaceutical chemical cosmetic industry ALKALOID AD Skopje, Blvd. Aleksandar Makedonski 12, 1000, Skopje, MK

(540)



(550) I

(740) Miladin Popović, ul. Capital Plaza, ulica šeika Zajeda 13-IV/68, 81000, Podgorica
(511) Klasa 3: Sapuni; šamponi; parfimerija; kozmetički preparati za njegu kože; kozmetički preparati za kupanje; dječje maramice impregnirane sredstvima za čišćenje; maramice impregnirane kozmetičkim losionima; vlažne maramice za kozmetičke svrhe; kozmetika za djecu; vatirani štapići za kozmetičke svrhe; kozmetičke kreme; losioni za kozmetičke svrhe.
Klasa 5: Upijajuće pelene za bebe; pelene za bebe; pelene za inkontinenciju; menstrualni ulošci; maramice impregnirane farmaceutskim losionima; hrana za bebe; sredstva za dezinfekciju; flasteri; medicinski šamponi; farmaceutski preparati za njegu kože.
Upijajuće pelene za bebe; pelene za bebe; pelene za inkontinenciju; menstrualni ulošci; maramice impregnirane farmaceutskim losionima; hrana za bebe; sredstva za dezinfekciju; flasteri; medicinski šamponi; farmaceutski preparati za njegu kože.
Klasa 16: Papirne podloge za mijenjanje pelena; podloge za mijenjanje pelena za jednokratnu upotrebu; plastične vrećice za pelene za jednokratnu upotrebu.

(111) **14858**

(151) 14.10.2020.

(210) Ž-2019-211

(220) 03.06.2019.

(732) Colgate-Palmolive Company (a Delaware corporation), 300 Park Avenue, 10022, New York, New York, US

(540)

PALMOLIVE PURE & DELIGHT

(550) I

(740) Jasna Jusić, Dalmatinska 2, 81000, Podgorica

(511) Klasa 3: Proizvodi za ličnu higijenu, odnosno, preparati za čišćenje kože i tijela; sapun; tečni sapun za ruke; gelovi i kreme za tuširanje; kupke; preparati za njegu kose; dezodoransi, preparati protiv znojenja i sprejevi za ispod pazuha za ličnu upotrebu; preparati za hidrataciju tijela i kože, losioni i kreme; puder u prahu; preparati za brijanje; preparati za kozmetičko potamnjenje i preparati za zaštitu kože od uticaja sunca; maramice natopljene rastvorom za čišćenje.

(111) **14859**

(151) 14.10.2020.

(210) Ž-2019-309

(220) 12.08.2019.

(732) International Foodstuffs Co LLC, P.O Box No. 4115, Sharjah, AE

(540)

MUSA

(550) I

(740) Miladin Popović, Đoka Miraševića 21/III, 81000, Podgorica

(511) Klasa 29: Jestivo ulje.

(111) **14860**

(151) 14.10.2020.

(210) Ž-2019-404

(220) 22.10.2019.

(732) Intercontinental Great Brands LLC, 100 Deforest Avenue, 07936, East Hanover, New Jersey, US

(540)



(550) I

(740) Miladin Popović, Đoka Miraševića 21/III, 81000, Podgorica

(511) Klasa 29: Mliječni proizvodi, posebno mliječni deserti i ohlađeni deserti, uključujući museve, proizvode od pavlake i jogurta.

Klasa 30: Sladoledi, smrznute poslastice; deserti, ohlađeni deserti; mješavine za pečenje; preparati napravljeni od žitarica, žitarice za doručak.

(111) **14861**

(151) 14.10.2020.

(210) Ž-2019-417

(220) 31.10.2019.

(732) ETI GIDA SANAYI VE TICARET ANONIM SIRKETI, Organize Sanayi Bolgesi 11., Cadde Eskisehir, TR

(540)



(550) I

(740) Miladin Popović, Đoka Miraševića 21/III, 81000, Podgorica

(511) Klasa 30: Kafa, kakao, napici na bazi kafe ili kakaa, napici na bazi čokolade, makaroni, mesne pite, vermičeli, poslastičarski i pekarski proizvodi, hljebovi, deserti, med, pčelinji vosak, propolis, arome za hranu, kvasac, prašak za pecivo, prirodni preparati za poboljšanje oblika i boje proizvoda od brašna i njihovo konzerviranje, bilo koje vrste brašna, griz, skrob, šećer, šećer u kocke, šećer u prahu, čaj, ledeni čajevi, konditorski proizvodi, čokolade, keksi, peciva, krekeri, vafli, kolači, tartovi, žvakaće gume, sladoledi, jestivi led, so, žitarice i njihovi proizvodi.

(111) **14862**

(151) 15.10.2020.

(210) Ž-2019-298

(220) 26.07.2019.

(732) 7-Eleven, Inc., 3200 Hackberry Road, 75063, Irving, Texas, US

(540)



(550) I

(740) Božidar S. Radulović, Baku 30/5, 81000, Podgorica

(511) Klasa 30: Kafa; čaj; kakao; šećer; pirinač; tapioka; sago; testenina; zamene za kafu; brašno i proizvodi od žitarica; hleb; peciva; poslastice; ledene poslastice; kolači, biskviti, suvi kolačići; med, melasa; kvasac; prašak za pecivo; so, senf; sirće; začini; led; pekarske poslastice, tart (slatka pita bez gornje kore) i pite; salate od makarona, pirinča i testenina; začinski dodaci, naročito kečap (sos), reliš (dodatak jelu), kiseli krastavac, reliš od kiselog krastavca, roštiljski sos, ljuti sos, čili sos, sos od sira i majonez; punjene rolnice i sendviči; sendviči sa viršlama; smrznuti, gotovi ili spakovani obroci koji se prvenstveno sastoje od pirinča, rezanaca i/ili testenine; pirinčane kuglice; zemičke kuvane na pari; takito (mala pržena rolavana punjena tortilja) i sendvič vrapovi; pica; pekarski proizvodi, naime gibanice, fokača, keks, braunis, mafini i krofne; čokolada; koštunjavo voće, grickalice i proizvodi od hleba sa čokoladnim prelivom; slatkiši, čokoladice i zvakaće gume; napici na bazi kafe i čaja; topla čokolada; pločice sa jogurtom; čips i krekeri napravljeni od kukuruza, pšenice i žita; salsa sos; sladoled; pikantne grickalice; pločice od žitarica i energetske pročiće; mešavina grickalice koja se prvenstveno sastoji od kreker, pereca, i/ili gotovih kokica; mešavina grickalice koja se prvenstveno sastoji od koštunjavog voća sa prelivom (poslastica); žitarice, grickalice na bazi žitarica, zrna kukuruza, granole, pirinča i pšenice.

Klasa 35: Oglašavanje; vođenje poslova; poslovno upravljanje; kancelarijski poslovi; usluge maloprodaje u supermarketima u oblasti robe široke potrošnje.

Klasa 43: Usluge obezbeđivanja hrane i pića; privremeni smeštaj; obezbeđivanje privremenog boravka i/ili pansionskog boravka u hotelima, hostelima, pansionima, kampovima, smeštajima za odmor i turističkim smeštajima; usluge rezervisanja privremenog smeštaja za boravak i/ili pansionski boravak u hotelima, hostelima, pansionima, kampovima, smeštajima za odmor i turističkim smeštajima; pružanje usluga restorana, barova, samouslužnih restorana, kantina, kafića, kafeterija i snek barova; usluge rezervisanja restorana, barova, samouslužnih restorana, kantina, kafića, kafeterija i snek barova.

(111) **14863**

(151) 15.10.2020.

(210) Ž-2019-301

(220) 31.07.2019.

(732) Kite Pharma, Inc., (Delaware corporation), 2400 Broadway, 90404, Santa Monica, California, US

(540)



(550) I

(740) Božidar S. Radulović, Baku 30/5, 81000, Podgorica

(511) Klasa 5: Farmaceutski preparati za upotrebu u lečenju kancera; farmaceutski preparati za imunoterapiju, uključujući ćelijsku terapiju i gensku terapiju; biološki preparati za lečenje kancera.

Klasa 44: Obezbeđivanje medicinskih i zdravstvenih informacija; obezbeđivanje medicinskih informacija u oblasti farmaceutskih sredstava i ćelijske terapije.

(111) **14864**

(151) 15.10.2020.

(210) Ž-2019-306

(220) 09.08.2019.

(732) Bosnalijek, farmaceutska i hemijska industrija, dionicko drustvo, Jukićeva 53, 71000, Sarajevo, BA

(540)

MEMENTO

(550) I

(740) Božidar S. Radulović, Baku 30/5, 81000, Podgorica

(511) Klasa 5: farmaceutske proizvodi.

(111) **14865**

(151) 15.10.2020.

(210) Ž-2019-307

(220) 09.08.2019.

(732) Kite Pharma, Inc. (Delaware corporation), 2400 Broadway, 90404, Santa Monica, California, US

(540)

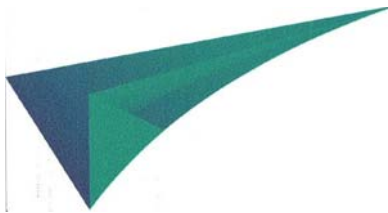

(550) I

(740) Božidar S. Radulović, Baku 30/5, 81000, Podgorica

(511) Klasa 5: Farmaceutski preparati za upotrebu u lečenju kancera; farmaceutski preparati za imunoterapiju, uključujući ćelijsku terapiju i gensku terapiju; biološki preparati za lečenje kancera.

(111) **14866**

(151) 15.10.2020.

(210) Ž-2019-391

(220) 15.10.2019.

(732) BROADFAR (SHANGHAI) MANAGEMENT CONSULTING CO., LTD., Room 2453, No. 1420 South Zhongshan rd. Huangpu, District, Shanghai, CN

(540)

NUSO

(550) I

(740) Božidar Radulović, Baku 30/5, 81000, Podgorica

(511) Klasa 34: Duvan za uvijanje; papir za cigarete; upaljači za pušače; duvan za žvakanje; šibice; usitnjen duvan; pepeljare za pušače; duvan; listovi duvana; elektronske cijevi za pušenje; elektronske cigare; elektronske cigarete; arome za duvan, osim esencijalnih ulja; cigare; rezači za cigare; držači za cigare; cigarete; držači za cigarete; filteri za cigarete; kutije za cigarete.

(111) **14867**

(151) 15.10.2020.

(210) Ž-2019-319

(220) 27.08.2019.

(732) BELUPO lijekovi i kozmetika, d.d., Danica 5, 48000, Koprivnica, HR

(540)

SILAPEN

(550) I

(740) Miladin Popović, Đoka Miraševića 21/III, 81000, Podgorica

(511) Klasa 5: Farmaceutski proizvodi.

(111) **14868**

(151) 15.10.2020.

(210) Ž-2019-320

(220) 27.08.2019.

(732) BELUPO lijekovi i kozmetika, d.d., Danica 5, 48000, Koprivnica, HR

(540)

AMORA

(550) I

(740) Miladin Popović, Đoka Miraševića 21/III, 81000, Podgorica

(511) Klasa 5: Farmaceutski proizvodi.

(111) **14869**

(151) 15.10.2020.

(210) Ž-2019-137

(220) 01.04.2019.

(732) ADP, LLC, One ADP Boulevard, 07068, Roseland, New Jersey, US

(540)

ADP

(550) I

(740) Jasna Jusić, Dalmatinska 2, 81000, Podgorica

(511) Klasa 9: Kompjuterski softver, uključujući kompjuterski softver za korištenje u poslovnom menadžmentu, računovodstvu, obračunu plata, upravljanju naknadama za nezaposlene, vođenju evidencije o radnom vremenu i vremenu koje zaposleni provedu na radnom mjestu, ustupanju zaposlenih, elektronskoj trgovini, upravljanju ljudskim resursima i talentima, administriranju primanja zaposlenih i penzionim planom, zdravstvenom

osiguranju i osiguranju radnika, u finansijskom upravljanju i upravljanju podacima; kompjuterski hardver, uključujući kompjuterski hardver za zaposlene da ga koriste u poslovnom menadžmentu, računovodstvu, obračunu plata, upravljanju naknadama za nezaposlene, vođenju evidencije o radnom vremenu i vremenu koje zaposleni provedu na radnom mjestu, ustupanju zaposlenih, elektronskoj trgovini, upravljanju ljudskim resursima i talentima, administriranju primanja zaposlenih i penzionim planom, zdravstvenom osiguranju i osiguranju radnika, u finansijskom upravljanju i upravljanju podacima; elektronske publikacije, podkasti, video i multimedijalno programiranje, koji se mogu preuzimati, u oblasti poslovnog menadžmenta, računovodstva, obračuna plata, upravljanja naknadama za nezaposlene, vođenja evidencije o radnom vremenu i vremenu koje zaposleni provedu na radnom mjestu, ustupanja zaposlenih, elektronskoj trgovini, upravljanja ljudskim resursima i talentima, administriranja primanja zaposlenih i penzionog plana, zdravstvenog osiguranja i osiguranja radnika, finansijskog upravljanja i upravljanja podacima.

Klasa 35: Biznis i analiza ljudskih resursa, konsultacije, informacije, upravljanje, planiranje i istraživanje; usluge konsaltinga u oblasti zapošljavanja, angažovanja, provjere radnog iskustva, upravljanja učinkom, upravljanja naknadama i upravljanja sukcesijom; usluge konsaltinga i evidencije u oblasti raspoređivanja zaposlenih, radnog vremena zaposlenih, prisutnosti zaposlenih na radnom mjestu, odmora i bolovanja zaposlenih; usluge evidencije platnih spiskova, obrade, isplate, administriranja i upravljanja; usluge obrade podataka; usluge anketiranja, istraživanja i revizije u vezi sa ljudskim resursima i osobljem; usluge evidencije, administriranja i upravljanja primanjima zaposlenih i naknadama za nezaposlene; obezbjeđivanje vebsajta, onlajn baze podataka i internet portala u oblasti biznisa, ljudskih resursa, platnih spiskova, primanja zaposlenih, naknada za nezaposlene, zapošljavanja, angažovanja, upravljanja učinkom, naknada i sukcesije i u oblasti raspoređivanja zaposlenih, radnog vremena zaposlenih, prisutnosti zaposlenih na radnom mjestu, odmora i bolovanja zaposlenih; usluge davanja informacija i savjeta u vezi sa gorenavedenim uslugama.

Klasa 36: Usluge konsaltinga u vezi osiguranja, istraživanja, informisanja, planiranja, upravljanja i administriranja; usluge finansijskog konsaltinga, istraživanja, informisanja, planiranja, upravljanja, administriranja i izvještavanja; pružanje konsultantskih, računarskih i usluga davanja podataka zaposlenima u oblasti naplate i poštovanja poreskih obaveza na dohodak, administriranja finansijskih naknada, administriranja zahtjeva radnika za isplatu naknada; administriranja penzionih fondova zaposlenih; obezbjeđivanje vebsajta, onlajn baze podataka i internet portala u oblasti osiguranja, finansijskih poslova i penzionih fondova.

Klasa 41: Usluge obrazovanja i usavršavanja, uključujući usluge obrazovanja i usavršavanja u oblasti poslovnog menadžmenta, računovodstva, obračuna plata, upravljanja naknadama za nezaposlene, vođenja evidencije o radnom vremenu i vremenu koje zaposleni provedu na radnom mjestu, ustupanja zaposlenih, elektronske trgovine, upravljanja ljudskim resursima i talentima, administriranja primanja zaposlenih i penzionog plana, zdravstvenog osiguranja i osiguranja radnika, finansijskog upravljanja i upravljanja podacima, administriranja platnim spiskovima, postovanja poreskih obaveza, vođenja evidencije o radnom vremenu i vremenu provedenom na radnom mjestu, administriranja naknada, ustupanja radnika i usavršavanja radnika; ugovaranje, organizovanje, sprovođenje i prezentacija seminara, radionica, časova, vebinara, konferencija, onlajn instrukcija i programa učenja na daljinu; objavljivanje knjiga i časopisa; obezbjeđivanje onlajn elektronskih publikacija, podkasta koji se ne mogu preuzimati i multimedijalnog

programiranja u oblasti poslovnog menadžmenta, računovodstva, obračuna plata, upravljanja naknadama za nezaposlene, vođenja evidencije o radnom vremenu i vremenu koje zaposleni provedu na radnom mjestu, ustupanja zaposlenih, elektronske trgovine, upravljanja ljudskim resursima i talentima, administriranja primanja i penzionog plana zaposlenih, zdravstvenog osiguranja i osiguranja radnika, finansijskog upravljanja i upravljanja podacima, administriranja platnih spiskova, poštovanja poreskih obaveza, vođenja evidencije o radnom vremenu i vremenu provedenom na radnom mjestu, administriranja naknada, ustupanja radnika i usavršavanja radnika.

Klasa 42: Dizajn i izrada kompjuterskog hardvera i softvera; ažuriranje, iznajmljivanje, održavanje i implementacija kompjuterskog softvera; usluge podrške kompjuterskom softveru; obezbjeđivanje privremenog korištenja kompjuterskog softvera koji se ne može preuzimati, uključujući kompjuterski softver za korištenje u poslovnom menadžmentu, računovodstvu, obračunu plata, upravljanju naknadama za nezaposlene, vođenju evidencije o radnom vremenu i vremenu koje zaposleni provedu na radnom mjestu, ustupanju zaposlenih, elektronskoj trgovini, upravljanju ljudskim resursima i talentima, administriranju primanja i penzionog plana zaposlenih, zdravstvenom osiguranju i osiguranju radnika, u finansijskom upravljanju i upravljanju podacima; obezbjeđivanje veb sajta sa tehnologijom za ljudske resurse, finansijsko upravljanje, zapošljavanje, upravljanje podacima, platne spiskove i naknade, pogodnosti i penzione planove i osiguranje; računarstvo u oblaku i onlajn usluge softvera koji se ne može preuzimati a koji se može koristiti za potrebe ljudskih resursa, finansijskog upravljanja, zapošljavanja, upravljanja podacima, platnih spiskova i naknada, pogodnosti i penzionih planova i osiguranja.

(111) **14870**

(151) 15.10.2020.

(210) Ž-2019-138

(220) 01.04.2019.

(732) ADP, LLC, One ADP Boulevard, 07068, Roseland, New Jersey, US

(540)



(550) I

(740) Jasna Jusić, Dalmatinska 2, 81000, Podgorica

(511) Klasa 9: Kompjuterski softver, uključujući kompjuterski softver za korištenje u poslovnom menadžmentu, računovodstvu, obračunu plata, upravljanju naknadama za nezaposlene, vođenju evidencije o radnom vremenu i vremenu koje zaposleni provedu na radnom mjestu, ustupanju zaposlenih, elektronskoj trgovini, upravljanju ljudskim resursima i talentima, administriranju primanja zaposlenih i penzionim planom, zdravstvenom osiguranju i osiguranju radnika, u finansijskom upravljanju i upravljanju podacima;

kompjuterski hardver, uključujući kompjuterski hardver za zaposlene da ga koriste u poslovnom menadžmentu, računovodstvu, obračunu plata, upravljanju naknadama za nezaposlene, vođenju evidencije o radnom vremenu i vremenu koje zaposleni provedu na radnom mjestu, ustupanju zaposlenih, elektronskoj trgovini, upravljanju ljudskim resursima i talentima, administriranju primanja zaposlenih i penzionim planom, zdravstvenom osiguranju i osiguranju radnika, u finansijskom upravljanju i upravljanju podacima; elektronske publikacije, podkasti, video i multimedijalno programiranje, koji se mogu preuzimati, u oblasti poslovnog menadžmenta, računovodstva, obračuna plata, upravljanja naknadama za nezaposlene, vođenja evidencije o radnom vremenu i vremenu koje zaposleni provedu na radnom mjestu, ustupanja zaposlenih, elektronskoj trgovini, upravljanja ljudskim resursima i talentima, administriranja primanja zaposlenih i penzionog plana, zdravstvenog osiguranja i osiguranja radnika, finansijskog upravljanja i upravljanja podacima.

Klasa 35: Biznis i analiza ljudskih resursa, konsultacije, informacije, upravljanje, planiranje i istraživanje; usluge konsaltinga u oblasti zapošljavanja, angažovanja, provjere radnog iskustva, upravljanja učinkom, upravljanja naknadama i upravljanja sukcesijom; usluge konsaltinga i evidencije u oblasti raspoređivanja zaposlenih, radnog vremena zaposlenih, prisutnosti zaposlenih na radnom mjestu, odmora i bolovanja zaposlenih; usluge evidencije platnih spiskova, obrade, isplate, administriranja i upravljanja; usluge obrade podataka; usluge anketiranja, istraživanja i revizije u vezi sa ljudskim resursima i osobljem; usluge evidencije, administriranja i upravljanja primanjima zaposlenih i naknadama za nezaposlene; obezbjeđivanje vebajta, onlajn baze podataka i internet portala u oblasti biznisa, ljudskih resursa, platnih spiskova, primanja zaposlenih, naknada za nezaposlene, zapošljavanja, angažovanja, upravljanja učinkom, naknada i sukcesije i u oblasti raspoređivanja zaposlenih, radnog vremena zaposlenih, prisutnosti zaposlenih na radnom mjestu, odmora i bolovanja zaposlenih; usluge davanja informacija i savjeta u vezi sa gorenavedenim uslugama.

Klasa 36: Usluge konsaltinga u vezi osiguranja, istraživanja, informisanja, planiranja, upravljanja i administriranja; usluge finansijskog konsaltinga, istraživanja, informisanja, planiranja, upravljanja, administriranja i izvještavanja; pružanje konsultantskih, računarskih i usluga davanja podataka zaposlenima u oblasti naplate i poštovanja poreskih obaveza na dohodak, administriranja finansijskih naknada, administriranja zahtjeva radnika za isplatu naknada; administriranja penzionih fondova zaposlenih; obezbjeđivanje vebajta, onlajn baze podataka i internet portala u oblasti osiguranja, finansijskih poslova i penzionih fondova.

Klasa 41: Usluge obrazovanja i usavršavanja, uključujući usluge obrazovanja i usavršavanja u oblasti poslovnog menadžmenta, računovodstva, obračuna plata, upravljanja naknadama za nezaposlene, vođenja evidencije o radnom vremenu i vremenu koje zaposleni provedu na radnom mjestu, ustupanja zaposlenih, elektronske trgovine, upravljanja ljudskim resursima i talentima, administriranja primanja zaposlenih i penzionog plana, zdravstvenog osiguranja i osiguranja radnika, finansijskog upravljanja i upravljanja podacima, administriranja platnim spiskovima, postovanja poreskih obaveza, vođenja evidencije o radnom vremenu i vremenu provedenom na radnom mjestu, administriranja naknada, ustupanja radnika i usavršavanja radnika; ugovaranje, organizovanje, sprovođenje i prezentacija seminara, radionica, časova, vebinara, konferencija, onlajn instrukcija i programa učenja na daljinu; objavljivanje knjiga i časopisa; obezbjeđivanje onlajn elektronskih publikacija, podkasta koji se ne mogu preuzimati i multimedijalnog programiranja u oblasti poslovnog menadžmenta, računovodstva, obračuna plata,

upravljanja naknadama za nezaposlene, vođenja evidencije o radnom vremenu i vremenu koje zaposleni provedu na radnom mjestu, ustupanja zaposlenih, elektronske trgovine, upravljanja ljudskim resursima i talentima, administriranja primanja i penzionog plana zaposlenih, zdravstvenog osiguranja i osiguranja radnika, finansijskog upravljanja i upravljanja podacima, administriranja platnih spiskova, poštovanja poreskih obaveza, vođenja evidencije o radnom vremenu i vremenu provedenom na radnom mjestu, administriranja naknada, ustupanja radnika i usavršavanja radnika.

Klasa 42: Dizajn i izrada kompjuterskog hardvera i softvera; ažuriranje, iznajmljivanje, održavanje i implementacija kompjuterskog softvera; usluge podrške kompjuterskom softveru; obezbjeđivanje privremenog korištenja kompjuterskog softvera koji se ne može preuzimati, uključujući kompjuterski softver za korištenje u poslovnom menadžmentu, računovodstvu, obračunu plata, upravljanju naknadama za nezaposlene, vođenju evidencije o radnom vremenu i vremenu koje zaposleni provedu na radnom mjestu, ustupanju zaposlenih, elektronskoj trgovini, upravljanju ljudskim resursima i talentima, administriranju primanja i penzionog plana zaposlenih, zdravstvenom osiguranju i osiguranju radnika, u finansijskom upravljanju i upravljanju podacima; obezbjeđivanje veb-sajta sa tehnologijom za ljudske resurse, finansijsko upravljanje, zapošljavanje, upravljanje podacima, platne spiskove i naknade, pogodnosti i penzione planove i osiguranje; računarstvo u oblaku i onlajn usluge softvera koji se ne može preuzimati a koji se može koristiti za potrebe ljudskih resursa, finansijskog upravljanja, zapošljavanja, upravljanja podacima, platnih spiskova i naknada, pogodnosti i penzionih planova i osiguranja.

(111) **14871**

(151) 15.10.2020.

(210) Ž-2019-139

(220) 01.04.2019.

(300) JM br. 076033 od 04.10.2018.godine

(732) ADP, LLC, One ADP Boulevard, 07068, Roseland, New Jersey, US

(540)

ALWAYS DESIGNING FOR PEOPLE

(550) I

(740) Jasna Jusić, Dalmatinska 2, 81000, Podgorica

(511) Klasa 9: Kompjuterski softver, uključujući kompjuterski softver za korištenje u poslovnom menadžmentu, računovodstvu, obračunu plata, upravljanju naknadama za nezaposlene, vođenju evidencije o radnom vremenu i vremenu koje zaposleni provedu na radnom mjestu, ustupanju zaposlenih, elektronskoj trgovini, upravljanju ljudskim resursima i talentima, administriranju primanja zaposlenih i penzionim planom, zdravstvenom osiguranju i osiguranju radnika, u finansijskom upravljanju i upravljanju podacima; kompjuterski hardver, uključujući kompjuterski hardver za zaposlene da ga koriste u poslovnom menadžmentu, računovodstvu, obračunu plata, upravljanju naknadama za nezaposlene, vođenju evidencije o radnom vremenu i vremenu koje zaposleni provedu na radnom mjestu, ustupanju zaposlenih, elektronskoj trgovini, upravljanju ljudskim resursima

i talentima, administriranju primanja zaposlenih i penzionim planom, zdravstvenom osiguranju i osiguranju radnika, u finansijskom upravljanju i upravljanju podacima; elektronske publikacije, podcasti, video i multimedijalno programiranje, koji se mogu preuzimati, u oblasti poslovnog menadžmenta, računovodstva, obračuna plata, upravljanja naknadama za nezaposlene, vođenja evidencije o radnom vremenu i vremenu koje zaposleni provedu na radnom mjestu, ustupanja zaposlenih, elektronskoj trgovini, upravljanja ljudskim resursima i talentima, administriranja primanja zaposlenih i penzionog plana, zdravstvenog osiguranja i osiguranja radnika, finansijskog upravljanja i upravljanja podacima.

Klasa 35: Biznis i analiza ljudskih resursa, konsultacije, informacije, upravljanje, planiranje i istraživanje; usluge konsaltinga u oblasti zapošljavanja, angažovanja, provjere radnog iskustva, upravljanja učinkom, upravljanja naknadama i upravljanja sukcesijom; usluge konsaltinga i evidencije u oblasti raspoređivanja zaposlenih, radnog vremena zaposlenih, prisutnosti zaposlenih na radnom mjestu, odmora i bolovanja zaposlenih; usluge evidencije platnih spiskova, obrade, isplate, administriranja i upravljanja; usluge obrade podataka; usluge anketiranja, istraživanja i revizije u vezi sa ljudskim resursima i osobljem; usluge evidencije, administriranja i upravljanja primanjima zaposlenih i naknadama za nezaposlene; obezbjeđivanje vebsajta, onlajn baze podataka i internet portala u oblasti biznisa, ljudskih resursa, platnih spiskova, primanja zaposlenih, naknada za nezaposlene, zapošljavanja, angažovanja, upravljanja učinkom, naknada i sukcesije i u oblasti raspoređivanja zaposlenih, radnog vremena zaposlenih, prisutnosti zaposlenih na radnom mjestu, odmora i bolovanja zaposlenih; usluge davanja informacija i savjeta u vezi sa gorenavedenim uslugama.

Klasa 36: Usluge konsaltinga u vezi osiguranja, istraživanja, informisanja, planiranja, upravljanja i administriranja; usluge finansijskog konsaltinga, istraživanja, informisanja, planiranja, upravljanja, administriranja i izvještavanja; pružanje konsultantskih, računarskih i usluga davanja podataka zaposlenima u oblasti naplate i poštovanja poreskih obaveza na dohodak, administriranja finansijskih naknada, administriranja zahtjeva radnika za isplatu naknada; administriranja penzionih fondova zaposlenih; obezbjeđivanje vebsajta, onlajn baze podataka i internet portala u oblasti osiguranja, finansijskih poslova i penzionih fondova.

Klasa 41: Usluge obrazovanja i usavršavanja, uključujući usluge obrazovanja i usavršavanja u oblasti poslovnog menadžmenta, računovodstva, obračuna plata, upravljanja naknadama za nezaposlene, vođenja evidencije o radnom vremenu i vremenu koje zaposleni provedu na radnom mjestu, ustupanja zaposlenih, elektronske trgovine, upravljanja ljudskim resursima i talentima, administriranja primanja zaposlenih i penzionog plana, zdravstvenog osiguranja i osiguranja radnika, finansijskog upravljanja i upravljanja podacima, administriranja platnim spiskovima, postovanja poreskih obaveza, vođenja evidencije o radnom vremenu i vremenu provedenom na radnom mjestu, administriranja naknada, ustupanja radnika i usavršavanja radnika; ugovaranje, organizovanje, sprovođenje i prezentacija seminara, radionica, časova, vebinara, konferencija, onlajn instrukcija i programa učenja na daljinu; objavljivanje knjiga i časopisa; obezbjeđivanje onlajn elektronskih publikacija, podcasta koji se ne mogu preuzimati i multimedijalnog programiranja u oblasti poslovnog menadžmenta, računovodstva, obračuna plata, upravljanja naknadama za nezaposlene, vođenja evidencije o radnom vremenu i vremenu koje zaposleni provedu na radnom mjestu, ustupanja zaposlenih, elektronske trgovine, upravljanja ljudskim resursima i talentima, administriranja primanja i penzionog plana

zaposlenih, zdravstvenog osiguranja i osiguranja radnika, finansijskog upravljanja i upravljanja podacima, administriranja platnih spiskova, poštovanja poreskih obaveza, vođenja evidencije o radnom vremenu i vremenu provedenom na radnom mjestu, administriranja naknada, ustupanja radnika i usavršavanja radnika.

Klasa 42: Dizajn i izrada kompjuterskog hardvera i softvera; ažuriranje, iznajmljivanje, održavanje i implementacija kompjuterskog softvera; usluge podrške kompjuterskom softveru; obezbjeđivanje privremenog korištenja kompjuterskog softvera koji se ne može preuzimati, uključujući kompjuterski softver za korištenje u poslovnom menadžmentu, računovodstvu, obračunu plata, upravljanju naknadama za nezaposlene, vođenju evidencije o radnom vremenu i vremenu koje zaposleni provedu na radnom mjestu, ustupanju zaposlenih, elektronskoj trgovini, upravljanju ljudskim resursima i talentima, administriranju primanja i penzionog plana zaposlenih, zdravstvenom osiguranju i osiguranju radnika, u finansijskom upravljanju i upravljanju podacima; obezbjeđivanje veb sajta sa tehnologijom za ljudske resurse, finansijsko upravljanje, zapošljavanje, upravljanje podacima, platne spiskove i naknade, pogodnosti i penzione planove i osiguranje; računarstvo u oblaku i onlajn usluge softvera koji se ne može preuzimati a koji se može koristiti za potrebe ljudskih resursa, finansijskog upravljanja, zapošljavanja, upravljanja podacima, platnih spiskova i naknada, pogodnosti i penzionih planova i osiguranja.

(111) **14872**

(151) 15.10.2020.

(210) Ž-2019-140

(220) 01.04.2019.

(300) US br. 88/202,672 od 21.11.2018.godine

(732) ADP, LLC, One ADP Boulevard, 07068, Roseland, New Jersey, US

(540)



Always Designing
for People

(550) I

(740) Jasna Jusić, Dalmatinska 2, 81000, Podgorica

(511) Klasa 9: Kompjuterski softver, uključujući kompjuterski softver za korištenje u poslovnom menadžmentu, računovodstvu, obračunu plata, upravljanju naknadama za nezaposlene, vođenju evidencije o radnom vremenu i vremenu koje zaposleni provedu na radnom mjestu, ustupanju zaposlenih, elektronskoj trgovini, upravljanju ljudskim resursima i talentima, administriranju primanja zaposlenih i penzionim planom, zdravstvenom osiguranju i osiguranju radnika, u finansijskom upravljanju i upravljanju podacima;

kompjuterski hardver, uključujući kompjuterski hardver za zaposlene da ga koriste u poslovnom menadžmentu, računovodstvu, obračunu plata, upravljanju naknadama za nezaposlene, vođenju evidencije o radnom vremenu i vremenu koje zaposleni provedu na radnom mjestu, ustupanju zaposlenih, elektronskoj trgovini, upravljanju ljudskim resursima i talentima, administriranju primanja zaposlenih i penzionim planom, zdravstvenom osiguranju i osiguranju radnika, u finansijskom upravljanju i upravljanju podacima; elektronske publikacije, podkasti, video i multimedijalno programiranje, koji se mogu preuzimati, u oblasti poslovnog menadžmenta, računovodstva, obračuna plata, upravljanja naknadama za nezaposlene, vođenja evidencije o radnom vremenu i vremenu koje zaposleni provedu na radnom mjestu, ustupanja zaposlenih, elektronskoj trgovini, upravljanja ljudskim resursima i talentima, administriranja primanja zaposlenih i penzionog plana, zdravstvenog osiguranja i osiguranja radnika, finansijskog upravljanja i upravljanja podacima.

Klasa 35: Usluge konsaltinga u oblasti zapošljavanja, angažovanja, provjere radnog iskustva, upravljanja učinkom, upravljanja naknadama i upravljanja sukcesijom; usluge konsaltinga i evidencije u oblasti raspoređivanja zaposlenih, radnog vremena zaposlenih, prisutnosti zaposlenih na radnom mjestu, odmora i bolovanja zaposlenih; usluge evidencije platnih spiskova, obrade, isplate, administriranja i upravljanja; usluge obrade podataka; usluge anketiranja, istraživanja i revizije u vezi sa ljudskim resursima i osobljem; usluge evidencije, administriranja i upravljanja primanjima zaposlenih i naknadama za nezaposlene; obezbjeđivanje veb sajta, onlajn baze podataka i internet portala u oblasti biznisa, ljudskih resursa, platnih spiskova, primanja zaposlenih, naknada za nezaposlene, zapošljavanja, angažovanja, upravljanja učinkom, naknada i sukcesije i u oblasti raspoređivanja zaposlenih, radnog vremena zaposlenih, prisutnosti zaposlenih na radnom mjestu, odmora i bolovanja zaposlenih; usluge davanja informacija i savjeta u vezi sa gorenavedenim uslugama.

Klasa 36: Usluge konsaltinga u vezi osiguranja, istraživanja, informisanja, planiranja, upravljanja i administriranja; usluge finansijskog konsaltinga, istraživanja, informisanja, planiranja, upravljanja, administriranja i izvještavanja; pružanje konsultantskih, računarskih i usluga davanja podataka zaposlenima u oblasti naplate i poštovanja poreskih obaveza na dohodak, administriranja finansijskih naknada, administriranja zahtjeva radnika za isplatu naknada; administriranja penzionih fondova zaposlenih; obezbjeđivanje veb sajta, onlajn baze podataka i internet portala u oblasti osiguranja, finansijskih poslova i penzionih fondova.

Klasa 41: Usluge obrazovanja i usavršavanja, uključujući usluge obrazovanja i usavršavanja u oblasti poslovnog menadžmenta, računovodstva, obračuna plata, upravljanja naknadama za nezaposlene, vođenja evidencije o radnom vremenu i vremenu koje zaposleni provedu na radnom mjestu, ustupanja zaposlenih, elektronske trgovine, upravljanja ljudskim resursima i talentima, administriranja primanja zaposlenih i penzionog plana, zdravstvenog osiguranja i osiguranja radnika, finansijskog upravljanja i upravljanja podacima, administriranja platnim spiskovima, postovanja poreskih obaveza, vođenja evidencije o radnom vremenu i vremenu provedenom na radnom mjestu, administriranja naknada, ustupanja radnika i usavršavanja radnika; ugovaranje, organizovanje, sprovođenje i prezentacija seminara, radionica, časova, vebinara, konferencija, onlajn instrukcija i programa učenja na daljinu; objavljivanje knjiga i časopisa; obezbjeđivanje onlajn elektronskih publikacija, podkasta koji se ne mogu preuzimati i multimedijalnog programiranja u oblasti poslovnog menadžmenta, računovodstva, obračuna plata, upravljanja naknadama za nezaposlene, vođenja evidencije o radnom vremenu i vremenu

koje zaposleni provedu na radnom mjestu, ustupanja zaposlenih, elektronske trgovine, upravljanja ljudskim resursima i talentima, administriranja primanja i penzionog plana zaposlenih, zdravstvenog osiguranja i osiguranja radnika, finansijskog upravljanja i upravljanja podacima, administriranja platnih spiskova, poštovanja poreskih obaveza, vođenja evidencije o radnom vremenu i vremenu provedenom na radnom mjestu, administriranja naknada, ustupanja radnika i usavršavanja radnika.

Klasa 42: Dizajn i izrada kompjuterskog hardvera i softvera; ažuriranje, iznajmljivanje, održavanje i implementacija kompjuterskog softvera; usluge podrške kompjuterskom softveru; obezbjeđivanje privremenog korištenja kompjuterskog softvera koji se ne može preuzimati, uključujući kompjuterski softver za korištenje u poslovnom menadžmentu, računovodstvu, obračunu plata, upravljanju naknadama za nezaposlene, vođenju evidencije o radnom vremenu i vremenu koje zaposleni provedu na radnom mjestu, ustupanju zaposlenih, elektronskoj trgovini, upravljanju ljudskim resursima i talentima, administriranju primanja i penzionog plana zaposlenih, zdravstvenom osiguranju i osiguranju radnika, u finansijskom upravljanju i upravljanju podacima; obezbjeđivanje veb sajta sa tehnologijom za ljudske resurse, finansijsko upravljanje, zapošljavanje, upravljanje podacima, platne spiskove i naknade, pogodnosti i penzione planove i osiguranje; računarstvo u oblaku i onlajn usluge softvera koji se ne može preuzimati a koji se može koristiti za potrebe ljudskih resursa, finansijskog upravljanja, zapošljavanja, upravljanja podacima, platnih spiskova i naknada, pogodnosti i penzionih planova i osiguranja.

(111) **14873**

(151) 16.10.2020.

(210) Ž-2019-141

(220) 01.04.2019.

(300) US br. 88/270,222 od 21.11.2018.godine.

(732) AMVAC C.V., 4695 MacArthur Court, Suite 1200, CA 92660, Newport Beach, US

(540)



(550) I

(740) Jasna Jusić, Dalmatinska 2, 81000, Podgorica

(511) Klasa 1: Regulatori rasta biljke i hormoni za korišćenje u poljoprivredi.

Klasa 5: Poljoprivredne hemikalije, naime, insekticidi, pesticidi, herbicidi, fungicidi, nematocidi i moluscidi za korišćenje u komercijalne svrhe, u poljoprivredi i hortikulturi.

Klasa 7: Djelovi za mehaničke poljoprivredne sisteme za raspršivanje hemikalija, naime, plastični kontejneri koji se koriste za skladištenje poljoprivredne hemikalije koja se nanosi pomoću ovog sistema; nemetalni konejneri za pesticide bez mjernog uređaja, koji se koristi

sa mehaničkim raspršivačima za doziranje materijala iz kontejnera za korištenje u poljoprivredi, koji se prodaju prazni.

Klasa 9: Sistem za doziranje tečnosti koji se sastoji od nemetalnog kontejnera za pesticide sa mjernim uređajem za doziranje materijala koji se nalazi u kontejneru, za korištenje u poljoprivredi, a prodaje se prazan; kontrolni uređaj za kontrolu doziranja materijala iz sistema za doziranje pesticida i za prikaz podataka koji se odnose na to doziranje, za korištenje u poljoprivredi; elektronski sistem za doziranje pesticida koji se sastoji od jednog ili dva kontejnera i mjernog uređaja za doziranje materijala iz jednog kontejnera, jednog kontejnera koji je prethodno napunjen pesticidom, za korištenje u poljoprivredi; elektronski sistem za doziranje za korištenje u poljoprivredi koji se sastoji od jednog ili dva kontejnera, jednog kontejnera koji je prethodno napunjen pesticidom, mjernog uređaja za doziranje materijala koji se nalazi u kontejneru, jednog ili više senzora i/ili monitora za praćenje eksternih uslova i rada sistema, kontrolnog uređaja za prikazivanje podataka i kontrolu doziranja i jednog ili više memorijskih uređaja za kalibraciju i snimanje podataka o tretmanu

(111) **14875**

(151) 16.10.2020.

(210) Ž-2019-230

(220) 19.06.2019.

(300) JM 076850 od 04.02.2019. godine

(732) Alcon Inc., Rue Louis-d'Affry 6, CH-1701, Fribourg, CH

(540)

See Brilliantly

(550) I

(740) AOD "Ćupić", Bulevar Džordža Vašingtona 79, 81000, Podgorica

(511) Klasa 5: Farmaceutski, medicinski i veterinarski proizvodi; higijenski proizvodi za upotrebu u medicini; dijetetska hrana i supstance za medicinske i veterinarske potrebe, hrana za odojcad; dodaci ishrani za ljude i životinje; flasteri, materijal za previjanje; materijali za plombiranje zuba, i za zubne otiske; dezinfekcijska sredstva; proizvodi za uništavanje životinjskih štetocina; fungicidi, herbicidi.

Klasa 9: Naučni, istraživački, navigacijski, geodetski, fotografski, kinematografski, audiovizuelni i optički aparati i instrumenti kao i aparati i instrumenti za vaganje, mjerenje, signalizaciju, detekciju (otkrivanje), testiranje (kontrolu), inspekciju, za pomoć (spašavanje) i za obuku; aparati i instrumenti za vođenje, distribuiranje, transformisanje, akumuliranje, podešavanje ili upravljanje distribucije i upotrebe električne struje; aparati i instrumenti za snimanje, prenos, reprodukciju ili obradu zvuka, slika ili podataka; snimljeni mediji i mediji koji se mogu preuzimati, računarski softver, prazni digitalni ili analogni mediji za snimanje i pohranjivanje podataka; mehanizmi za uređaje koji se pokreću uz prethodno ubacivanje kovanica; registarske blagajne, računari; kompjuteri i

njihovi periferni uređaji; ronilačka odijela, ronilačke maske, čepići za uši za ronioce, štikaljke za nos za ronioce i plivače, rukavice za ronioce, aparati za disanje za podvodno plivanje; aparati za gašenje požara.

Klasa 10: Hirurški, medicinski, zubarski i veterinarski aparati i instrumenti; vještački udovi, oči i zubi; ortopedski proizvodi; pribor za šivanje rana; terapijske i pomoćne naprave prilagođene osobama s invaliditetom; aparati za masažu; aparati, uređaji i artikli za odojčad; aparati, uređaji i artikli vezani za polne aktivnosti.

Klasa 35: Oglašavanje i reklamiranje, vođenje komercijalnih poslova, komercijalna administracija; kancelarijski poslovi.

Klasa 37: Građevinsko konstruisanje; usluge instalacije i popravke (održavanja) oftalmoloških aparata i instrumenata.

Klasa 41: Obuka, stručno osposobljavanje; razonoda; sportske i kulturne djelatnosti.

(111) **14874**

(151) 16.10.2020.

(210) Ž-2019-142

(220) 01.04.2019.

(300) US br. 88/270,205 od 21.01.2019.godine

(732) AMVAC C.V., 4695 MacArthur Court, Suite 1200, CA 92660, Newport Beach, US

(540)



(550) I

(740) Jasna Jusić, Dalmatinska 2, 81000, Podgorica

(511) Klasa 1: Regulatori rasta biljke i hormoni za korišćenje u poljoprivredi.

Klasa 5: Poljoprivredne hemikalije, naime, insekticidi, pesticidi, herbicidi, fungicidi, nematocidi i moluscidi za korišćenje u komercijalne svrhe, u poljoprivredi i hortikulturi.

(111) **14876**

(151) 19.10.2020.

(210) Ž-2019-216

(220) 06.06.2019.

(732) NBA Properties, Inc., Olympic Tower- 645 Fifth Avenue, 10022, New York, New York, US

(540)



(550) I

(740) Miladin Popović, ul. Capital Plaza, ulica šeika Zajeda 13-IV/68, 81000, Podgorica
(511) Klasa 25: Odjeća, naime čarape, obuća, cipele za košarku, patike za košarku, majice, košulje, polo majice, dukserice, donji djelovi trenerke, pantalone, majice na bretele, dresovi, kratke pantalone, pižame, sportske majice, ragbi majice, džemperi, kaiševi, spavaćice, šeširi, kape, vizir kačketi, trenerke za zagrijavanje, donji djelovi trenerki za zagrijavanje, dresovi za zagrijavanje, majice za vježbanje ubacaja, jakne, blejzeri, kravate (odeća), džepne maramice, maramice, vjetrovke, jakne sa kapuljačom, kaputi, portikle za bebe koje nijesu od papira, oprema za bebe (odjeća), trake za glavu, ručne trake (odjeća), kecelje, donje rublje, bokserice, uske bokserice, široke pantalone, štitnici za uši, rukavice, rukavice samo sa palcem, šalovi, pletene i štrikane majice, haljine od žerseja, haljine, dresovi i uniforme za navijačice, odjeća za plivanje, odijela za plivanje, kupaći kostimi, bikini, tankini kupaći kostimi, gaćice za plivanje, gaćice za kupanje, šorcevi za surfovanje, gumirana odeća za vodu, marama za plažu, pokrivala za kupaći kostim, ogrtači za kupaći kostim, sandale, sandale za plažu, šeširi za plažu, štitnici za sunce sa viziorom, kape za plivanje, kape za kupanje, nova pokrivala za glavu sa prikačenim umecima.

Klasa 28: Igračke, igre i sportske stvari, naime košarkaške lopte, loptice za golf, lopte za igralište, sportske lopte, gumene lopte i pjenaste lopte, plišane lopte za igru, plastične lopte za igru, mrežice za košarku, table za košarku, minijaturne table za košarku, pumpe i igle za naduvavanje košarkaških lopti; štapovi za golf, torbe za golf, podmetači za golf, oprema za golf, naime, alat za popravku golf terena, kupice na koje se stavlja lopta, markeri lopti, pokrivala za torbe za golf, pokrivala za glave golf štapova, rukavice za golf, kutije za golf lopte, posebna zelena staza za golf; držači za bilijarske štapove, kugle za bilijar, trouglovi za bilijar, pikado ormari, elektronske košarkaške igrice na tabli, table za košarkaške igrice, košarkaške igrice, akcione igrice, društvene igrice za odrasle i djecu, trivia informacione igrice i elektronski video arkadni uređaji, košarkaški setovi koji se sastoje od mrežice i zviždaljke, lutke, dekorativne lutke, lutke za kolekciju, akcione figure za igru, akcione figure karikature, punjene igračke, plišane igračke, slagalice, montažni blokovi za igre, ukrasi za božićnu jelku i božićne čarape; vozila za igru u obliku automobila, kamiona, vozova i kombija, svi sa temom košarke, nove pjenaste igračke u obliku prsta ili trofeja, igračke trofeji, karte za igru, igre sa kartama, igračke koje prave zvuk, igračke za kućne ljubimce; igračke za plažu, naime lopte za plažu, lopte na naduvavanje, kantice za igru, lopatice za igru, igračke za pijesak, igračke za bazen sa pijeskom, gumene igračke za vodu; oprema za bazen, naime plivačka oprema za plutanje, oprema za plutanje u bazenu, igračke za splavarenje na vodi, pjenasta oprema za plutanje, kolutovi za plivanje, kolutovi za plivanje u bazenu, pjenasti kolutovi, daske za plivanje, daske za surfovanje, peraja za plivanje, peraja za surfovanje, narukvice za plutanje i narukvice za pomoć pri plivanju, sva navedena

roba za rekreaciju; odbojkaški setovi za igru koji se sastoje od lopte, mrežice, traka koje označavaju teren i zviždaljke, i vaterpolo setovi za igru koji se sastoje od lopte, mrežice i zviždaljke; dekorativne igračke od tkanine koje se puštaju da lete na vjetru; minijaturne reprodukcije stadiona, naime, mali plastični modeli stadiona za igru; staklene kugle sa snijegom; džojstici za video igre; džojstici za računarske igre; mašine za video igre za upotrebu sa televizorom i ručni kontroleri za konzole za video igre; trake za trčanje; banke igračke; fidžet spinneri; skejtbordovi.

Klasa 41: Razonoda i obrazovne usluge u vidu televizijskih i radio programa iz oblasti košarke i prikazivanja uživo košarkaških igara i košarkaskih priredbi; usluge produkcije i distribucije radio i televizijskih šou programa sa košarkaškim utakmicama, košarkaškim događajima i programima iz oblasti košarke; usluge vođenja i organizovanja košarkaških klinika i kampova, klinika i kampova za trenere, klinika i kampova za plesne timove i košarkaške igre; usluge razonode u vidu ličnog pojavljivanja kostimiziranih maskota ili plesnih timova na košarkaškim utakmicama i priredbama, klinikama, kampovima, promocijama i drugim događajima u vezi sa košarkom, specijalnim događajima i žurkama; usluge kluba obožavalaca; usluge razonode, naime pružanje veb-sajta sa multimedijским sadržajem koji se ne može preuzimati u vidu najvažnijih televizijskih događaja, interaktivnih najvažnijih televizijskih događaja, video snimaka, video strim snimaka, interaktivnih video izbora najvažnijih događaja, radio programa, najvažnijih radijskih događaja i audio snimaka iz oblasti košarke; pružanje vijesti i informacija u vidu statistika i drugih tema iz oblasti košarke; omogućavanje pristupa on-lajn igricama koje se ne mogu preuzimati, naime računarskim igricama, video igricama, interaktivnim video igricama i trivia igricama; usluge razonode u vidu imaginarnih košarkaskih liga; pružanje onlajn računarske baze podataka iz oblasti košarke.

(111) **14877**

(151) 20.10.2020.

(210) Ž-2019-217

(220) 07.06.2019.

(732) Novartis AG, Basel, 4002, CH

(540)

ACIPAN

(550) I

(740) AOD MSA IP - Milojević Sekulić Advokati, Karađorđeva 65, 11000, Beograd

(511) Klasa 5: Farmaceutski preparati, naime gastrointestinalni preparati.

(111) **14879**

(151) 20.10.2020.

(210) Ž-2019-220

(220) 10.06.2019.

(300) JM 76838 od 01.02.2019. godine

(732) The Ritz-Carlton Hotel Company, L.L.C., 10400 Fernwood Road, 20817, Bethesda, Maryland, US

(540)

EVIRIMA

(550) I

(740) Jasna Jusić, Dalmatinska 2, 81000, Podgorica

(511) Klasa 39: Prevoz putnika i roba čamcem; pakovanje i skladištenje roba; usluge prevoza putnika kruzerima; usluge kruzera; usluge putničkih agencija, naime, organizovanje, pravljenje i primanje rezervacija za prevoz putnika i roba, usluge krstarenja i kruzera, ekskurzije u vidu prevoza na ture sa vodičem, prevoz za ture sa razgledanjem znamenitosti, godišnji odmori u vidu krstarenja i putničkog prevoza; organizovanje i izvođenje ekskurzija u vidu pružanja prevoza za ekskurzije, ture u vidu obezbjeđivanja prevoza za ture sa razgledanjem znamenitosti, godišnji odmori u vidu krstarenja i organizovanja krstarenja; usluge turističkog vodiča i turističkih informacija; usluge planiranja događaja i rukovođenja, naime, ugovaranje, organizacija, planiranje i osmišljavanje godišnjih odmora u vidu organizovanja putovanja; pružanje informacija i savjeta u vezi sa gorepomenutim uslugama.

Klasa 43: Obezbeđivanje hrane i pića i privremenog smještaja na kruzeru; pružanje usluga rezervacija za druge za privremeni smještaj na kruzeru.

(111) **14880**

(151) 20.10.2020.

(210) Ž-2019-223

(220) 14.06.2019.

(732) Four Seasons Hotels (Barbados) Ltd. a Barbados Company, Chancery House, High Street, Bridgetown, BB

(540)



FOUR SEASONS

(550) I

(740) Jasna Jusić, Dalmatinska 2, 81000, Podgorica

(511) Klasa 39: Usluge transporta; putnički izleti; krstarenja; usluge vezane za iznajmljivanje brodova; rad marina; rad turističkih kancelarija i turističkih agencija; organizovanje izleta; organizovanje i sprovođenje krstarenja; organizacija izleta; organizacija krstarenja; upravljanje izletima; upravljanje krstarenjima; pratnja putnika; transport putnika; prevoz putnika; upravljanje garažama; iznajmljivanje parking mjesta; parking za automobile; iznajmljivanje automobila; rezervisanje mjesta za putnike i rezervacije putovanja; usluge turističkih agencija za organizovanje izleta; putnički aranžman; vazdušni saobraćaj; vazdušni transport; usluge prijave prtljaga za avione i kruzere; usluge prijave putnika na aerodromima i kruzerima; pružanje informacija o dolasku i odlasku letova i kruzera; usluge aerodroma; organizacija putovanja; usluge kruzera; pružanje informacija o turističkim putovanjima; pomorski transport; isporuka robe; isporuka tovara; pakovanje i skladištenje robe; putničke usluge; usluge turističkih vodiča; razgledanje (turizam); iznajmljivanje ronilačkih odijela; putne rezervacije; krstarenja brodovima; upravljanje krstarenjima; usluge putničkih agencija; rezervacije i bukiranje krstarenja; organizovanje prevoza za putovanja; uključujući sve gore navedene usluge koje se pružaju elektronski ili onlajn iz kompjuterske baze podataka ili putem interneta; informacione, savjetodavne i konsalting usluge u vezi sa gore pomenutim uslugama; sve uključene u klasu 39.

(111) **14881**

(151) 20.10.2020.

(210) Ž-2019-229

(220) 19.06.2019.

(732) Actavis Group PTC ehf., Reykjavikurvegi 76-78, 220, Hafnarfjordur, IS

(540)

GILESTRA DUO

(550) I

(740) Miladin Popović, Đoka Miraševića 21/III, 81000, Podgorica

(511) Klasa 5: Farmaceutski preparati i supstance.

(111) **14882**

(151) 21.10.2020.

(210) Ž-2019-143

(220) 02.04.2019.

(732) Farmaceutsko hemijska industrija "ZDRAVLJE", akcionarsko društvo, Vlajkova 199, 16000, Leskovac, RS

(540)

ATACOR

(550) I

(740) Miladin Popović, Đoka Miraševića 21/III, 81000, Podgorica

(511) Klasa 5: Farmaceutski preparati za tretman i liječenje dislipidemije, hipolipemik.

(111) **14883**

(151) 21.10.2020.

(210) Ž-2019-292

(220) 25.07.2019.

(732) Merryvale Limited, 1 Mapp Street, Belize City, BZ

(540)



(550) I

(740) Jasna Jusić, Dalmatinska 2, 81000, Podgorica

(511) Klasa 9: Računarski programi i računarski softveri, uključujući softvere koji se mogu preuzeti s interneta; mobilne aplikacije za mobilne telefone, tablete i druge uređaje koji se mogu držati u ruci; interaktivni računarski sistemi koji su povezani sa kockanjem i klađenjem ili ih sadrže, usluge zabave i razonode, igre, igre sa kartama, bingo, kazino igre i sportsko klađenje.

Klasa 41: Zabava; sportske i kulturne aktivnosti; usluge onlajn igara, kockanja i klađenja; kockanje i usluge igara za rad elektronskog binga, mreža sajtova za igranje binga onlajn, virtuelne slot mašine i druge instant igre; sportsko klađenje i lutrije i usluge onlajn kladionice; pružanje usluga kazino igara uključujući rulet igre, slot mašine, bingo igre, blekdžek, keno, bakara, grebalice, poker i sportsko klađenje; obezbjeđivanje usluga poker igre kojoj korisnici na mreži mogu pristupiti širom mreže; obezbjeđivanje igranja karata za više igrača kojima korisnici na mreži mogu pristupiti širom mreže; organizacija, produkcija i prezentacija turnira, takmičenja, igara i događaja; zabava i usluge interaktivne zabave; organizacija zabave, razonode, takmičenja, igara, kockanja, klađenja, igara sa kartama, sportskog klađenja i lutrija; uključujući pružanje svih navedenih usluga pomoću raznovrsnih tehnoloških platformi, uključujući, bez ograničenja, i putem telefona, mobilnih ili drugih uređaja koji se mogu držati u ruci ili onlajn putem iz kompjuterske baze podataka ili preko interneta; usluge podrške i savjetodavne usluge i pružanje informacija u vezi sa svim prethodno navedenim uslugama.

(111) **14884**

(151) 21.10.2020.

(210) Ž-2019-215

(220) 05.06.2019.

(732) PHARMASCIENCE INC., , 6111 Royalmount Avenue Suite #100, Montreal Quebec H4P 2T 4, CA

(540)



(550) I

(740) Miladin Popović, Đoka Miraševića 21/III, 81000, Podgorica

(511) Klasa 5: Farmaceutski i veterinarski preparati; sanitarni preparati za upotrebu u medicini; dijetetska hrana i supstance prilagođene za upotrebu u medicini ili veterinarsku upotrebu, hrana za bebe; dijetetski dodaci za ljude i životinje; flasteri, materijali za zavijanje; materijali za plombiranje zuba, zubarska smola; dezinfekciona sredstva; preparati za uništavanje štetočina; fungicidi, herbicidi.

(111) **14885**

(151) 21.10.2020.

(210) Ž-2019-302

(220) 02.08.2019.

(732) International Foodstuffs Co LLC, P.O. Box No. 4115, Sharjah, AE

(540)

QUANTA

(550) I

(740) Miladin Popović, Đoka Miraševića 21/III, 81000, Podgorica

(511) Klasa 30: Čokolade, poslastice, bombone, biskviti (sve vrste), kolači, tjestenina, makaroni, rezanci, instant rezanci, špageti, rezanci za supu, kvasac, prašak za pecivo i drugi pekarski sastojci, prelive za salate, majonez, sirće, kečap i sosevi (začini), polugotovi proizvodi od tijesta, smiznuto tijesto, smrznuto beskvasno indijsko tijesto (parata), sladoledi, smrznuti nemliječni deserti, smrznuti voćni deserti, ledeni deserti, kafa, čaj, kakao, šećer,

pirinač, tapioka, sago, zamjene za kafu, hleb, pecivo, sirup, so, senf, brašno napravljeno od žitarica, začini., hranljivi napici (na bazi žitarica i bilja), umaci, biljni čaj, med.

(111) **14886**

(151) 21.10.2020.

(210) Ž-2019-303

(220) 02.08.2019.

(732) International Foodstuffs Co LLC, P.O. Box No. 4115, Sharjah, AE

(540)

TIFFANY BREAK

(550) I

(740) Miladin Popović, Đoka Miraševića 21/III, 81000, Podgorica

(511) Klasa 30: Čokolade, poslastice, bombone, biskviti (sve vrste), kolači, tjestenina, makaroni, rezanci, instant rezanci, špageti, rezanci za supu, kvasac, prašak za pecivo i drugi pekarski sastojci, prelive za salate, majonez, sirće, kečap i sosevi (začini), polugotovi proizvodi od tijesta, smiznuto tijesto, smrznuto beskvasno indijsko tijesto (parata), sladoledi, smrznuti nemliječni deserti, smrznuti voćni deserti, ledeni deserti, kafa, čaj, kakao, šećer, pirinač, tapioka, sago, zamjene za kafu, hleb, pecivo, sirup, so, senf, brašno napravljeno od žitarica, začini., hranljivi napici (na bazi žitarica i bilja), umaci, biljni čaj, med.

(111) **14887**

(151) 21.10.2020.

(210) Ž-2019-304

(220) 02.08.2019.

(732) THE CAPITAL MAHARAJA ORGANISATION LIMITED, No. 146, Dawson Street, 2, Colombo, LK

(540)



(550) I

(740) Miladin Popović, Đoka Miraševića 21/III, 81000, Podgorica

(511) Klasa 17: Guma, gutaperka, kaučuk, azbest, liskun i proizvodi od ovih materijala koji nijesu obuhvaćeni drugim klasama; polupreradeni plastični proizvodi koji se koriste u proizvodnji; materijali za nepropusno zatvaranje, zaptivanje i izolovanje; savitljive nemetalne cijevi; savitljive cijevi za šatorska platna; priključci za cijevi za vazduh pod pritiskom, nemetalni; cijevni omotači, nemetalni; spona za cijevi (nemetalne); dihtunzi za cijevi; cijevna izolacija, nemetalna; zaptivači za cijevi; mufovi za cijevi, nemetalni; ojačavajući materijali za cijevi, koji nijesu od metala.

Klasa 19: Građevinski materijali, nemetalni; krute cijevi, nemetalne, za građevinarstvo; asfalt, katran i bitumen (smola); prenosive građevine [konstrukcije], nemetalne; građevinski materijali, nemetalni / konstrukcijski materijali, nemetalni; spomenici, nemetalni; rezervoari za vodu pod pritiskom; cijevi za vodu, nemetalne; ventili za cjevovode, ne od metala ili plastike.

(111) **14888**

(151) 22.10.2020.

(210) Ž-2019-66

(220) 26.02.2019.

(732) POSLOVNI SISTEM MERCATOR d.d., Dunajska cesta 107, 1000, Ljubljana, SI

(540)



(550) I

(740) Božidar S. Radulović, Baku 30/5, 81000, Podgorica

(511) Klasa 16: Papir i karton, koji nijesu sadržani u drugim razredima; štampani proizvodi; knjigovezniški materijal; fotografije; kancelarijski materijal; ljepila za kancelarijski materijal ili za domaćinstvo; potrebne stvari za umjetnike; četke; kancelarijski pribor (osim namještaja); materijal za učenje ili podučavanje (osim aparata); materijal za zamotavanje od vještačkog materijala (koji nijesu obuhvaćeni u drugim razredima); albumi: almanasi; knjižice; kalendari; muzičke čestitke; sveske; bilježnice; knjige; kuvari; blokovi za crtanje; bojice; olovke; nalivpera; hemijske olovke

Klasa 21: Naprave i posuđe za domaćinstvo ili kuhinju; proizvodi od stakla; porculan; potrebne stvari za kuhinju; kuhinjsko posuđe; šoljice; lončići; krigle; čaše; zdjele; tanjiri; modeli za torte; lončevi; tiganji; posude za kekse; lopatice (kuhinjsko pomagalo).

Klasa 35: Oglasna i poslovna djelatnost; usluge sa područja reklama i ekonomske propagande; posredovanje na području izvoza i uvoza; poslovno posredovanje za treća lica;

vođenje komercijalne i poslovne administracije; kancelarijski poslovi; računovodstvene i knjigovodstvene usluge i profesionalno poslovno savjetovanje; istraživanje tržišta i studije trgovanja; izrada poslovnih studija, analiza i investicionih elaborata; posredovanje kod izbora kadrova; kucanje i fotokopiranje; iznajmljivanje kancelarijskih mašina i aparata; iznajmljivanje oglasnih tabli; aranžiranje izloga i sajamskih prostora; postavljanje klasičnih i elektronskih reklamnih panoa i transparenata i postavljanje reklamnih razglasnih sistema; kačenje reklamnih zastavica; usluge oglašavanja i trgovine preko blogova; organizacija nagradnih igara za promotivne namjene; usluge trgovine i prodaje kuhinskih potrebnih stvari, hrane, pića, tekstilnih proizvoda, kecelji, kuhinjskih krpa, odjeće, pokrivala, knjiga, revija, kalendara, CD-a, DVD-a, uključujući internet prodaja; usluge trgovine i prodaje u ovom spisku navedenih usluga iz razreda 38 i 41, uključujući internet prodaju.

Klasa 38: Telekomunikacione usluge; iznajmljivanje televizijskih programa; iznajmljivanje preko televizije, kablovske televizije i radia; komunikacija preko telegrama, preko računarskih terminala; elektronska pošta; iznajmljivanje telefaksa; slanje obavještenja; izdavanje u zakup aparata za predaju i primanje obavještenja; usluge sa područja paginga; slanje telegrama; usluge sa područja predaje i primanja teleksa; posredovanje (dostavljanje) informacija o telekomunikacijama : usluge sa područja telegrafisanja; distribucija novosti.

Klasa 41: Nastava i razonoda, usluge zabavnih parkova; organizovanje i izvođenje kolokvijuma, konferencija, kongresa, seminara i simpozijuma; usluge auto- biblioteka; izdavanje knjiga; usluge sportskih kampova, kazina; organizacija cirkusa i takmičenja; usluge diskoteka; obrazovne informacije; obrazovni ispiti; pozajmljivanje knjiga; muzejske izložbe; usluge muzičkih hala; organizacija zabava i sportskih priredbi, predstava; planiranje zabava; vođenje i organizacija igara na sreću; izdavanje u zakup radio i TV aparata, audio naprava za snimanje, kino projektora, filmova; pozajmljivanje sportske opreme; nastava; izvođenje nastave; usluge zooloških vrtova; novinarske usluge; usluge novinskih izvještača; organizacija takmičenja; organizacija kuvarskih takmičenja; produkcija televizijskih programa; produkcija televizijskih tematskih emisija; televizijski zabavni program; organizacija i vođenje kuvarskih kurseva i kurseva i predavanja o ishrani; objavljivanje tekstova (osim reklama); objavljivanje elektronskih knjiga i revija na računarskoj mreži; objavljivanje knjiga; objavljivanje kuvarskih knjiga; ponuda igara na računarskoj mreži; ponuda on-line publikacija (koje nije moguće objaviti preko računarske mreže); usluge pisanja blogova.

(111) **14889**

(151) 22.10.2020.

(210) Ž-2019-67

(220) 26.02.2019.

(732) POSLOVNI SISTEM MERCATOR d.d., Dunajska cesta 107, 1000, Ljubljana, SI

(540)

The logo for 'MALI ŠEF' features the word 'MALI' in a bold, sans-serif font, followed by a stylized fork icon that serves as the letter 'Š', and then the word 'ŠEF' in the same bold, sans-serif font.

(550) I

(740) Božidar S. Radulović, Baku 30/5, 81000, Podgorica

(511) Klasa 16: Papir i karton, koji nijesu sadržani u drugim razredima; štampani proizvodi; knjigovezniški materijal; fotografije; kancelarijski materijal; ljepila za kancelarijski materijal ili za domaćinstvo; potrebne stvari za umjetnike; četke; kancelarijski pribor (osim namještaja); materijal za učenje ili podučavanje (osim aparata); materijal za zamotavanje od vještačkog materijala (koji nijesu

obuhvaćeni u drugim razredima); albumi: almanasi; knjižice; kalendari; muzičke čestitke; sveske; bilježnice; knjige; kuvari; blokovi za crtanje; bojice; olovke; nalivpera; hemijske olovke.

Klasa 21: Naprave i posuđe za domaćinstvo ili kuhinju; proizvodi od stakla; porculan; potrebne stvari za kuhinju; kuhinjsko posuđe; šoljice; lončići; krigle; čaše; zdjele; tanjiri; modeli za torte; lončevi; tiganji; posude za kekse; lopatice (kuhinjsko pomagalo).

Klasa 35: Oglasna i poslovna djelatnost; usluge sa područja reklama i ekonomske propagande; posredovanje na području izvoza i uvoza; poslovno posredovanje za treća lica; vođenje komercijalne i poslovne administracije; kancelarijski poslovi; računovodstvene i knjigovodstvene usluge i profesionalno poslovno savjetovanje; istraživanje tržišta i studije trgovanja; izrada poslovnih studija, analiza i investicionih elaborata; posredovanje kod izbora kadrova; kucanje i fotokopiranje; iznajmljivanje kancelarijskih mašina i aparata; iznajmljivanje oglasnih tabli; aranžiranje izloga i sajamskih prostora; postavljanje klasičnih i elektronskih reklamnih panoa i transparentata i postavljanje reklamnih razglasnih sistema; kačenje reklamnih zastavica; usluge oglašavanja i trgovine preko blogova; organizacija nagradnih igara za promotivne namjene; usluge trgovine i prodaje kuhinjskih potrebnih stvari, hrane, pića, tekstilnih proizvoda, kecelji, kuhinjskih krpa, odjeće, pokrivala, knjiga, revija, kalendara, CD-a, DVD-a, uključujući internet prodaja; usluge trgovine i prodaje u ovom spisku navedenih usluga iz razreda 38 i 41, uključujući internet prodaju.

Klasa 38: Telekomunikacione usluge; iznajmljivanje televizijskih programa; iznajmljivanje preko televizije, kablovske televizije i radia; komunikacija preko telegrama, preko računarskih terminala; elektronska pošta; iznajmljivanje telefaksa; slanje obavještenja; izdavanje u zakup aparata za predaju i primanje obavještenja; usluge sa područja paginga; slanje telegrama; usluge sa područja predaje i primanja teleksa; posredovanje (dostavljanje) informacija o telekomunikacijama : usluge sa područja telegrafisanja; distribucija novosti.

Klasa 41: Nastava i razonoda, usluge zabavnih parkova; organizovanje i izvođenje kolokvijuma, konferencija, kongresa, seminara i simpozijuma; usluge auto- biblioteka; izdavanje knjiga; usluge sportskih kampova, kazina; organizacija cirkusa i takmičenja; usluge diskoteka; obrazovne informacije; obrazovni ispiti; pozajmljivanje knjiga; muzejske izložbe; usluge muzičkih hala; organizacija zabava i sportskih priredbi, predstava; planiranje zabava; vođenje i organizacija igara na sreću; izdavanje u zakup radio i TV aparata, audio naprava za snimanje, kino projektora, filmova; pozajmljivanje sportske opreme; nastava; izvođenje nastave; usluge zooških vrtova; novinarske usluge; usluge novinskih izvještača; organizacija takmičenja; organizacija kuvarskih takmičenja; produkcija televizijskih programa; produkcija televizijskih tematskih emisija; televizijski zabavni program; organizacija i vođenje kuvarskih kurseva i kurseva i predavanja o ishrani; objavljivanje tekstova (osim reklama); objavljivanje elektronskih knjiga i revija na računarskoj mreži; objavljivanje knjiga; objavljivanje kuvarskih knjiga; ponuda igara na računarskoj mreži;

ponuda on-line publikacija (koje nije moguće objaviti preko računarske mreže); usluge pisanja blogova.

(111) **14890**

(151) 22.10.2020.

(210) Ž-2019-68

(220) 26.02.2019.

(732) POSLOVNI SISTEM MERCATOR d.d., Dunajska cesta 107, 1000, Ljubljana, SI

(540)

MALI ŠEF

(550) I

(740) Božidar S. Radulović, Baku 30/5, 81000, Podgorica

(511) Klasa 16: Papir i karton, koji nijesu sadržani u drugim razredima; štampani proizvodi; knjigovezniški materijal; fotografije; kancelarijski materijal; ljepila za kancelarijski materijal ili za domaćinstvo; potrebne stvari za umjetnike; četke; kancelarijski pribor (osim namještaja); materijal za učenje ili podučavanje (osim aparata); materijal za zamotavanje od vještačkog materijala (koji nijesu obuhvaćeni u drugim razredima); albumi: almanasi; knjižice; kalendari; muzičke čestitke; sveske; bilježnice; knjige; kuvari; blokovi za crtanje; bojice; olovke; nalivpera; hemijske olovke.

Klasa 21: Naprave i posuđe za domaćinstvo ili kuhinju; proizvodi od stakla; porculan; potrebne stvari za kuhinju; kuhinjsko posuđe; šoljice; lončići; krigle; čaše; zdjele; tanjiri; modeli za torte; lončevi; tiganji; posude za kekse; lopatice (kuhinjsko pomagalo).

Klasa 35: Oglasna i poslovna djelatnost; usluge sa područja reklama i ekonomske propagande; posredovanje na području izvoza i uvoza; poslovno posredovanje za treća lica; vođenje komercijalne i poslovne administracije; kancelarijski poslovi; računovodstvene i knjigovodstvene usluge i profesionalno poslovno savjetovanje; istraživanje tržišta i studije trgovanja; izrada poslovnih studija, analiza i investicionih elaborata; posredovanje kod izbora kadrova; kucanje i fotokopiranje; iznajmljivanje kancelarijskih mašina i aparata; iznajmljivanje oglasnih tabli; aranžiranje izloga i sajamskih prostora; postavljanje klasičnih i elektronskih reklamnih panoa i transparentata i postavljanje reklamnih razglasnih sistema; kačenje reklamnih zastavica; usluge oglašavanja i trgovine preko blogova; organizacija nagradnih igara za promotivne namjene; usluge trgovine i prodaje kuhinjskih potrebnih stvari, hrane, pića, tekstilnih proizvoda, kecelji, kuhinjskih krpa, odjeće, pokrivala, knjiga, revija, kalendara, CD-a, DVD-a, uključujući internet prodaju; usluge trgovine i prodaje u ovom spisku navedenih usluga iz razreda 38 i 41, uključujući internet prodaju.

Klasa 38: Telekomunikacione usluge; iznajmljivanje televizijskih programa; iznajmljivanje preko televizije, kablovske televizije i radija; komunikacija preko telegrama, preko računarskih terminala; elektronska pošta; iznajmljivanje telefaksa; slanje obavještenja; izdavanje u zakup aparata za predaju i primanje obavještenja; usluge sa područja paginga;

slanje telegrama; usluge sa područja predaje i primanja teleksa; posredovanje (dostavljanje) informacija o telekomunikacijama : usluge sa područja telegrafisanja; distribucija novosti.

Klasa 41: Nastava i razonoda, usluge zabavnih parkova; organizovanje i izvođenje kolokvijuma, konferencija, kongresa, seminara i simpozijuma; usluge auto- biblioteka; izdavanje knjiga; usluge sportskih kampova, kazina; organizacija cirkusa i takmičenja; usluge diskoteka; obrazovne informacije; obrazovni ispiti; pozajmljivanje knjiga; muzejske izložbe; usluge muzičkih hala; organizacija zabava i sportskih priredbi, predstava; planiranje zabava; vođenje i organizacija igara na sreću; izdavanje u zakup radio i TV aparata, audio naprava za snimanje, kino projektora, filmova; pozajmljivanje sportske opreme; nastava; izvođenje nastave; usluge zooloških vrtova; novinarske usluge; usluge novinskih izvještača; organizacija takmičenja; organizacija kuvarskih takmičenja; produkcija televizijskih programa; produkcija televizijskih tematskih emisija; televizijski zabavni program; organizacija i vođenje kuvarskih kurseva i kurseva i predavanja o ishrani; objavljivanje tekstova (osim reklama); objavljivanje elektronskih knjiga i revija na računarskoj mreži; objavljivanje knjiga; objavljivanje kuvarskih knjiga; ponuda igara na računarskoj mreži; ponuda on-line publikacija (koje nije moguće objaviti preko računarske mreže); usluge pisanja blogova.

(111) **14891**

(151) 22.10.2020.

(210) Ž-2019-231

(220) 19.06.2019.

(732) Conair Corporation, One Cummings Point Road, CT 06902, Stamford, US

(540)

CONAIR

(550) I

(740) Jasna Jusić, Dalmatinska 2, 81000, Podgorica

(511) Klasa 8: Pegle za stilizovanje kose, mašine za šišanje i trimeri.

Klasa 11: Fenovi za kosu.

(111) **14892**

(151) 22.10.2020.

(210) Ž-2019-232

(220) 19.06.2019.

(732) Babylliss SARL, 99 Avenue Aristide Briand, 92120, Montrouge, FR

(540)

BABYLISS

(550) I

(740) Jasna Jusić, Dalmatinska 2, 81000, Podgorica

(511) Klasa 8: Pegle za stilizovanje kose, mašine za šišanje i trimeri.

Klasa 11: Fenovi za kosu.

(111) **14893**

(151) 22.10.2020.

(210) Ž-2019-235

(220) 24.06.2019.

(732) HONGYUNHONGHE TOBACCO (GROUP) CO., LTD, NO. 367 HONGJIN ROAD, WUHUA DISTRICT, KUNMING CITY, YUNNAN PROVINCE, CN

(540)

WIN

(550) I

(740) Božidar S. Radulović, Studentska bb, Lamela 3/18, 81000, Podgorica

(511) Klasa 34: Cigarete; upaljači za pušače; šibice; duvan; elektronske cigarete; tečnosti za električne cigarete (e-tečnosti); začini (arome) za duvan, izuzev eteričnih ulja; usnici za cigarete; filteri za cigarete.

(111) **14896**

(151) 22.10.2020.

(210) Ž-2019-321

(220) 28.08.2019.

(732) Reckitt Benckiser LLC, 399 Interpace Parkway, 07054, Parsippany, New Jersey, US

(540)

LYSOL

(550) I

(740) Miladin Popović, Đoka Miraševića 21/III, 81000, Podgorica

(511) Klasa 3: Višenamjenski preparati za čišćenje; preparati za čišćenje, poliranje, ribanje i abrazivni preparati; preparati za čišćenje koji spriječavaju nagomilavanje fleka i kamenca; preparati za dekalifikaciju i uklanjanje kamenca za upotrebu u domaćinstvu; preparati za čišćenje odvoda i sudopere; sredstva za čišćenje toaleta; preparati za čišćenje prozora; preparati za bijeljenje; krpe, vlažne maramice, maramice i sunđeri natopljeni preparatima za čišćenje; deterdženti; deterdženti za pranje veša; preparati za pranje sudova; sredstvo za čišćenje, osvežavanje i dezodorisanje mašina za sudove; sredstva za ispiranje za mašine za sudove; preparati za upotrebu u perionicama; sredstva za čišćenje veš mašina; sapuni; antibakterijski sapuni; sapuni za ličnu upotrebu; preparati za čišćenje ruku; sredstva za tuširanje; preparati za njegu kože; parfimisani preparati za atmosferu; parfimisani sprejevi za prostorije; esencijalna ulja; mirisni difuzori; potpuri; tamjan.

Klasa 5: Dezinfekcioni, antibakterijski preparati i preparati za dezodorisanje; dezinfekciona sredstva za kuhinje, toalete i kupatila; sanitarni preparati za upotrebu u domaćinstvu, komercijalnu, industrijsku i institucionalnu upotrebu; sredstva za dezinfekciju veša; preparati za dezinfekciju tvrdih površina za upotrebu u domaćinstvu; dezodoransi za upotrebu u domaćinstvu; krpe, vlažne maramice, maramice i sunđeri natopljeni dezinfekcionim sredstvima; krpe, vlažne maramice, maramice i sunđeri natopljeni antiseptičkim preparatima; krpe, vlažne maramice, maramice i sunđeri natopljeni antibakterijskim preparatima; insekticidi; miticidi; sredstva za zaštitu od insekata; fungicidi; germicidi; preparati za uništavanje i odbijanje štetočina; preparati za osvježavanje vazduha; preparati za neutralisanje mirisa za upotrebu na tekstilu, tepisima i u vazduhu; preparati za neutralisanje mirisa; preparati za prečišćavanje vazduha.

Klasa 21: Krpe i vlažne maramice za čišćenje ili upotrebu u domaćinstvu, naime, krpe i vlažne maramice za čišćenje; krpe za poliranje; krpe za čišćenje; pjalice i krpe za prašinu; sunđeri za pranje; držači za krpe, vlažne maramice, maramice i sunđere za čišćenje kuće; dozatori za sredstva za čišćenje domaćinstva; kućne ili kuhinjske sprave i posude; češljevi i sunđeri; četke (izuzev kičica); materijali za pravljenje četki; pribor za čišćenje; čelična vuna; staklo, neobrađeno ili poluobrađeno [osim stakla koje se koristi u građevini]; staklarija, porcelan i grnčarija koja nije obuhvaćena drugim klasama.

(111) **14894**

(151) 22.10.2020.

(210) Ž-2019-281

(220) 16.07.2019.

(732) DOO BUIL'D, Bečići bb, PF 70, Budva, ME

(540)



(550) I

(511) Klasa 43: agencije za smještaj [hotelski, pansioniski]; aparati za kuvanje (iznajmljivanje); barovi (usluge barova); hotelske rezervacije (usluge rezerviranja hotela); hotelske usluge; kafane-restorani; privremeni smještaj (rezerviranje privremenog smještaja); restorani; restorani sa samoposluživanjem; restorani za brzo i stalno posluživanje [snek-barovi]; rezerviranje hotela; rezerviranje pansiona; rezerviranje privremenog smještaja; smještaj (agencije za izdavanje smještaja) [hoteli, pansioni]; smještaj (iznajmljivanje privremenog smještaja).

(111) **14897**

(151) 22.10.2020.

(210) Ž-2019-322

(220) 28.08.2019.

(732) Reckitt Benckiser LLC, 399 Interpace Parkway, 07054, Parsippany, New Jersey, US

(540)



(550) I

(740) Miladin Popović, Đoka Miraševića 21/III, 81000, Podgorica

(511) Klasa 3: Višenamjenski preparati za čišćenje; preparati za čišćenje, poliranje, ribanje i abrazivni preparati; preparati za čišćenje koji spriječavaju nagomilavanje fleka i kamenca; preparati za dekalifikaciju i uklanjanje kamenca za upotrebu u domaćinstvu; preparati za čišćenje odvođa i sudopere; sredstva za čišćenje toaleta; preparati za čišćenje prozora; preparati za bijeljenje; krpe, vlažne maramice, maramice i sunđer natopljeni preparatima za čišćenje; deterdženti; deterdženti za pranje veša; preparati za pranje sudova; sredstvo za čišćenje, osvežavanje i dezodorisanje mašina za sudove; sredstva za ispiranje za mašine za sudove; preparati za upotrebu u perionicama; sredstva za čišćenje veš mašina; sapuni; antibakterijski sapuni; sapuni za ličnu upotrebu; preparati za čišćenje ruku; sredstva za tuširanje; preparati za njegu kože; parfimisani preparati za atmosferu; parfimisani sprejevi za prostorije; esencijalna ulja; mirisni difuzori; potpuri; tamjan.

Klasa 5: Dezinfekcioni, antibakterijski preparati i preparati za dezodorisanje; dezinfekciona sredstva za kuhinje, toalete i kupatila; sanitarni preparati za upotrebu u domaćinstvu, komercijalnu, industrijsku i institucionalnu upotrebu; sredstva za dezinfekciju veša; preparati za dezinfekciju tvrdih površina za upotrebu u domaćinstvu; dezodoransi za upotrebu u domaćinstvu; krpe, vlažne maramice, maramice i sunđer natopljeni dezinfekcionim sredstvima; krpe, vlažne maramice, maramice i sunđer natopljeni antiseptičkim preparatima; krpe, vlažne maramice, maramice i sunđer natopljeni antibakterijskim preparatima; insekticidi;

miticidi; sredstva za zaštitu od insekata; fungicidi; germicidi; preparati za uništavanje i odbijanje štetočina; preparati za osvježavanje vazduha; preparati za neutralisanje mirisa za upotrebu na tekstilu, tepisima i u vazduhu; preparati za neutralisanje mirisa; preparati za prečišćavanje vazduha.

Klasa 21: Krpe i vlažne maramice za čišćenje ili upotrebu u domaćinstvu, naime, krpe i vlažne maramice za čišćenje; krpe za poliranje; krpe za čišćenje; pjalice i krpe za prašinu; sunđeri za pranje; držači za krpe, vlažne maramice, maramice i sunđere za čišćenje kuće; dozatori za sredstva za čišćenje domaćinstva; kućne ili kuhinjske sprave i posude; češljevi i sunđeri; četke (izuzev kičica); materijali za pravljenje četki; pribor za čišćenje; čelična vuna; staklo, neobrađeno ili poluobrađeno [osim stakla koje se koristi u građevini]; staklarija, porcelan i grnčarija koja nije obuhvaćena drugim klasama.

(111) **14898**

(151) 22.10.2020.

(210) Ž-2019-25

(220) 29.01.2019.

(732) Caterpillar Inc., a corporation of Delaware, 100 NE Adams Street, 61629, Peoria, Illinois, US

(540)



(550) I

(740) AOD "Ćupić", Bulevar Džordža Vašingtona 79, 81000, Podgorica

(511) Klasa 7: Mašine i njihovi priključci za upotrebu u poljoprivredi, sabijanju, izgradnji, rušenju, pripremi zemljišta, oblikovanju zemljišta, pomjeranju zemlje, šumarstvu, uređenju zemljišta, podizanju tereta, brodarstvu, rukovanju materijalima, rukovanju otpadnim materijalima, rudarstvu, malčiranju, distribuciji, istraživanju i proizvodnji nafte i gasa, popločavanju, polaganju cijevi, proizvodnji struje, izgradnji i popravci puteva, pripremi i remedijaciji terena, upravljanju otpadom, vazduhoplovstvu i kosmonautici, kamenolomima, šljunkarama i cementarama, uređenju vegetacije, transportu, i za potrebe državne uprave i odbrane; alatne mašine i njihovi priključci, motori, pogonske mašine i generatori (koji nijesu za kopnena vozila); mašinske spojnice i transmisioni elementi (koji nijesu za kopnena vozila); i rezervni djelovi, djelovi za zamjenu i refabrikovani djelovi za sve navedene proizvode.

Klasa 12: Vozila, uređaji za kretanje po zemlji, vazduhu ili vodi; vozila i uređaji za kretanje po zemlji, vazduhu ili vodi za upotrebu u poljoprivredi, sabijanju, izgradnji, rušenju, pripremi zemljišta, oblikovanju zemljišta, pomjeranju zemlje, šumarstvu, uređenju zemljišta, podizanju tereta, brodarstvu, rukovanju materijalima, rukovanju otpadnim materijalima,

rudarstvu, malčiranju, distribuciji, istraživanju i proizvodnji nafte i gasa, popločavanju, polaganju cijevi, proizvodnji struje, izgradnji i popravci puteva, pripremi i remedijaciji terena, upravljanju otpadom, vazduhoplovstvu i kosmonautici, kamenolomima, šljunkarama i cementarama, uređenju vegetacije, transportu, i za potrebe državne uprave i odbrane; i rezervni djelovi, djelovi za zamjenu i refabrikovani djelovi za sve navedene proizvode.

(111) **14899**

(151) 22.10.2020.

(210) Ž-2019-47

(220) 06.02.2019.

(300) RS br. Ž-2018-1590 od 04.10.2018.godine

(732) MEGA CONCEPT DOO BEOGRAD - NOVI BEOGRAD, Omladinskih brigada
18/14, Beograd, RS

(540)



(550) I

(740) Miladin Popović, Đoka Miraševića 21/III, 81000, Podgorica

(511) Klasa 6: Bravarski proizvodi, mali metalni građevinski proizvodi, cjevčice i cijevi od metala, prenosive metalne konstrukcije, metalne cijevi za zavjese, metalne garnišne, aluminijumski profili, aluminijumski lančići, sitni djelovi od aluminijuma i drugih metala, aluminijumski poklopci, prozorske roletne od metala, roletne od čelika, roletne od čelika, metalni graničnici za zaustavljanje vrata, metalne šarke za velika vrata, šipke za metalne ograde, prozorske remenice, reze za prozorske okvire, okovi za prozore, zvekiri za vrata, metalni, kapci, zatvarači, od metala, krilni prozori od metala, ramovi za prozore od metala, ramovi za prozore od metala, ramovi, kućišta, za vrata od metala, okviri vrata od metala, djelovi od metala za namještaj, djelovi od metala za krevete, djelovi za vrata od metala, metalni rukohvati za kadu, metalni graničnici za prozorske okvire, metalni graničnici za vrata, metalni nosači za namještaj, metalni okviri kamina [police nad kaminom].

Klasa 16: Hartija i karton, štampane stvari, kancelarijski materijal, umjetnički materijali, štamparska slova, čelična slova [kliše], nosači ljepljivih traka, oglasni panoi od papira ili kartona, spajalice, heftalice, klipse za olovke, fascikle za spise, spajalice za papir, blokovi, žigovi [pečati], sveske, papir za mašine za snimanje, belježnice, fascikle, korice [kancelarijski materijal], letci, flajeri, natpisi od papira ili kartona, lijepkovi za kancelarijsku ili upotrebu u domaćinstvu.

Klasa 17: Unutrašnje prozorske roletne od PVC-a; garnišne od PVC-a; plastični sitni djelovi; plastični lančići; plastični poklopci, savitljiva crijeva nemetalna, cijevi od tekstilnih materijala, zaptivači za cijevi, spojnice za cijevi, cijevni priključci, nemetalni, gumeni zaustavljači vrata,

gumeni graničnici za prozore.

Klasa 20: Kancelarijski stolovi; kancelarijski namještaj; namještaj; pločaste unutrašnje roletne; šine za zavjese (garnišne); šipke za zavjese (garnišne); kukice za zavjese; alke za zavjese; šnale i trake za držanje zavjesa; unutrašnje prozorske roletne (namještaj); unutrašnji prozorski zastori (namještaj); tekstilne roletne za prozore (unutrašnje); držači zavjesa koji nisu od tekstila; prekrivači, jorgani, jastuci za krevete, osim posteljine; dekorativni jastučići; klizači za garnišne; dekorativne zavjese od pedi; zavjese od bambusa; pletene roletne od drva (pokućstvo); papirne roletne, zastori.

Klasa 22: Spoljne roletne od tekstila; nadstrešnice; trake za vezivanje i uvijanje koje nisu od metala; cirade.

Klasa 24: Tekstilni materijali; platno, štof; tkanine; nadstolnjaci koji nisu od papira; pamučne tkanine; jaka pamučna tkanina za zavjese; prekrivači za krevete; prostirke za krevete; zastirači (za krevete); prekrivači za stolove koji nisu od papira; čaršavi (tekstilni); štampane pamučne tkanine; posteljine; peškiri; jastučnice; zavjese od tekstila ili plastike; draperije; mrežaste zavjese; tkanine za tekstilnu upotrebu; pletene tkanine; svilene tkanine; podmetači od tekstila; salvete od tekstila; dekorativna platna za posteljinu; tkanine od vještačke svile; tekstilni prekrivači za namještaj (nepričvršćeni); držači zavjesa od tekstilnih materijala; tkanine koje se lijepe toplotom; platna, rublje za kupatilo, izuzev odjeće; somot, pliš; zastori; zavjese za vrata; zidna tapiserija od tekstila; materijal za baršunaste rese.

Klasa 26: Čipka i vez; trake (pantljike) i gajtani; rese; baršunaste rese; kukice; kopče; kićanke (galanterija); ukrasne kićanke (pomponi); nabori, ukrasi (čipkani); rozete (galanterija); elastične trake lastiši uzice i gajtani za obrublivanje; trake za pričvršćivanje; trake za zavjese; aplikacije; aplikacije za ukrašavanje tekstilnih proizvoda koje se lijepe toplotom; dekorativni privjesci (osirn za nakit, prstenove za ključeve ili priveske za ključeve).

Klasa 27: Tapete; tekstilne tapete; tepisi, ćilimi; prekrivači za podove; neklizajuće prostirke; podmetači za tepihe; ukrasne zidne dekoracije, netekstilne; podne prostirke; otirači.

Klasa 35: Usluge veleprodaje i maloprodaje bravarskih proizvoda, malih metalnih građevinskih proizvoda, cjevčica i cijevi od metala, metalnih cijevi za zavjese, metalnih garnišni, aluminijskih profila, aluminijskih lančića, sitnih djelova od aluminijuma i drugih metala, aluminijskih poklopaca, prozorskih roletni od metala, garnišni od PVC-a, plastičnih sitnih djelova, plastičnih lančića, plastičnih poklopaca, tekstilnih roletni za prozore, držača za zavjese od tekstila, mebl štofova, prekrivača za krevete, stolnjaka, posteljina, jastuka, zavjesa, tapeta, tepiha, kancelarijskih stolova, kancelarijskog namještaja, namještaja, pločastih unutrašnjih roletni, šina za zavjese (garnišni), šipki za zavjese, kukica za zavjese, alki za zavjese, šnala i traka za držanje zavjesa, unutrašnjih prozorskih roletni (namještaj), unutrašnjih prozorskih zastora (namještaj), držača zavjesa koji nisu od tekstila, jorgana, dekorativnih jastučića, klizača za garnišne, dekorativnih zavjesa od pedi, zavjesa od bambusa, pletenih roletni od drva (pokućstvo), papirnih roletni, zastora, spoljnih roletni od tekstila, nadstrešnica, traka za vezivanje i uvijanje koje nisu od metala, cirada, tekstilnih materijala, platna, štofova, tkanina, nadstolnjaka koji nisu od papira, pamučnih tkanina, jakih pamučnih tkanina za zavjese, prekrivača za krevete, prostirki za krevete, zastirača (za krevete), prekrivača za stolove koji nisu od papira, čaršava (tekstilnih), štampanih pamučnih tkanina, posteljina, peškira, jastučnica, zavjesa od tekstila ili plastike, draperija, mrežastih zavjesa, tkanina za tekstilnu upotrebu, pletenih tkanina, svilenih tkanina, podmetača od tekstila, salveta od tekstila, dekorativnih platna za posteljinu, tkanina od vještačke svile, tekstilnih prekrivača za namještaj

(nepričvršćenih), tkanina koje se lijepe toplotom, platna, rublja za kupatilo, izuzev odjeće, somota, pliša, zastora, zavjesa za vrata, zidnih tapiserija od tekstila, materijala za

baršunaste rese, čipke i veza, traka (pantljika) i gajtana, resa, baršunastih resa, kukica, kopči, kićanki (galanterija), ukrasnih kićanki (pomponi), nabora, ukrasa (čipkanih), rozeta (galanterija), elastičnih traka, lastiša, uzica i gajtana za obrublivanje, traka za pričvršćivanje, traka za zavjese, aplikacija, aplikacija za ukrašavanje tekstilnih proizvoda koje se lijepe toplotom, dekorativnih privezaka (osim za nakit, prstenove za ključeve ili priveske za ključeve), tekstilnih tapeta, ćilima, prekrivača za podove, neklizajućih prostirki, podmetača za tepihe, ukrasnih zidnih dekoracija, netekstilnih, podnih prostirki, otirača.

Klasa 42: Usluge opremanja i dizajna enterijera, naime usluge opremanja i uređenja stanova, kuća, restorana, kafića, hotela i drugih objekata.

(111) **14895**

(151) 22.10.2020.

(210) Ž-2019-282

(220) 16.07.2019.

(732) DOO BUIL'D, Bečići bb, PF 70, Budva, ME

(540)



(550) I

(511) Klasa 36: nekretnine (procjena nekretnina); nekretnine (upravljanje nekretninama); upravljanje imovinom; upravljanje nekretninama; stanarine (naplata stanarina); stanovi (iznajmljivanje stanova); starine (procjena starina); agencije za stanove [nepokretna imovina]; zakup [vrsta iznajmljivanja dobara za profesionalne potrebe, koja temeljem ugovora mogu postati vlasništvo iznajmitelja] [lizing]; zakup nekretnina (davanje u zakup nekretnina) [lizing]

Klasa 43: agencije za smještaj [hotelski, pansioniski]; aparati za kuvanje (iznajmljivanje); barovi (usluge barova); hotelske rezervacije (usluge rezervisanja hotela); hotelske usluge; kafane-restorani; privremeni smještaj (rezervisanje privremenog smještaja); restorani; restorani sa samoposluživanjem; restorani za brzo i stalno posluživanje [snek-barovi]; rezervisanje hotela; rezervisanje pansiona; rezervisanje privremenog smještaja; smještaj (agencije za izdavanje smještaja) [hoteli, pansioni]; smještaj (iznajmljivanje privremenog smještaja).

(111) **14900**

(151) 22.10.2020.

(210) Ž-2019-191

(220) 15.05.2019.

(732) Koncern za proizvodnju i promet konditorskih proizvoda Bambi a.d. Požarevac, Đure Đakovića bb, 12000, Požarevac, RS

(540)

Ne grizi savest zagrizi Wellness

(550) I

(740) dr Ivan Todorović, Gospodar Jevremova 23/8, 11000, Beograd

(511) Klasa 30: Integralni keks.

(111) **14902**

(151) 22.10.2020.

(210) Ž-2019-222

(220) 10.06.2019.

(732) Dow AgroSciences LLC, 9330 Zionsville Road, 46268, Indianapolis, Indiana, US

(540)

INSTINCT

(550) I

(740) Božidar S. Radulović, Studentska bb, Lamela 3/18, 81000, Podgorica

(511) Klasa 1: Hemijski proizvod koji se koristi u zemljištu za očuvanje biljnih hranjivih materija.

(111) **14903**

(151) 22.10.2020.

(210) Ž-2017-230

(220) 19.06.2017.

(732) AKTSIONERNO DROUJESTVO BULGARATABAC HOLDING, UI Graf Ignatiev No 62, 1000, Sofija, BG

(540)



(550) I

(511) Klasa 34: Sirovi duvan, obrađeni proizvodi od duvana i proizvodi od duvana podvgnuti na ročitom postupku, cigarete, filteri za cigarete, cigaret-papir, piskovi za cigarete (deo koji se stavlja u usta pušača), pribor za pušače, šibice, upalja či i pepeljare.

(111) **14904**

(151) 23.10.2020.

(210) Ž-2019-151

(220) 05.04.2019.

(300) US br. 88/188,844 od 09.11.2018.godine

(732) Reign Beverage Company LLC, a Delaware limited liability company, 1547 N. Knowles Ave., 90063, Los Angeles, California, US

(540)

REIGN TOTAL BODY FUEL

(550) I

(740) Božidar S. Radulović, Studentska bb, Lamela 3/18, 81000, Podgorica

(511) Klasa 32: Fitnes napici.

(111) **14901**

(151) 22.10.2020.

(210) Ž-2019-193

(220) 13.05.2019.

(732) Koncern za proizvodnju i promet konditorskih proizvoda Bambi a.d. Požarevac, Đure Đakovića bb, 12000, Požarevac, RS

(540)

Zlatni Pek - zlata vredan

(550) I

(740) dr Ivan Todorović, Gospodar Jevremova 23/8, 11000, Beograd

(511) Klasa 30: Keks, mleveni keks, posni keks, posni mleveni keks, posni keks sa kakaom.

(111) **14905**

(151) 23.10.2020.

(210) Ž-2019-154

(220) 09.04.2019.

(732) BMJ Industries FZ-LLC, P.O. Box: 31053, Al-Jazeera Al-Hamra, Ras Al Khaimah, AE

(540)

4K

(550) I

(740) Božidar S. Radulović, Studentska bb, Lamela 3/18, 81000, Podgorica

(511) Klasa 34: Duvan; artikli za pušače; šibice.

(111) **14906**

(151) 23.10.2020.

(210) Ž-2019-167

(220) 23.04.2019.

(300) EM br. 018052259 od 16.04.2019.godine.

(732) Reign Beverage Company LLC, a Delaware limited liability company, 1547 N. Knowles Ave., 90063, Los Angeles, California, US

(540)

REIGN

(550) I

(740) Božidar S. Radulović, Studentska bb, Lamela 3/18, 81000, Podgorica

(511) Klasa 32: Fitnes napici.

(111) **14907**

(151) 23.10.2020.

(210) Ž-2019-198

(220) 20.05.2019.

(300) US br. 88/389902 od 17.04.2019.godine

(732) Reign Beverage Company LLC, a Delaware limited liability company, 1547 N. Knowles Ave., 90063, Los Angeles, California, US

(540)

YOUR REIGN, YOUR RULES

(550) I

(740) Božidar S. Radulović, Studentska bb, Lamela 3/18, 81000, Podgorica

(511) Klasa 32: Bezalkoholna pića.

(111) **14909**

(151) 23.10.2020.

(210) Ž-2019-200

(220) 20.05.2019.

(300) US br. 88/207138 od 27.11.2018.godine

(732) Reign Beverage Company LLC, a Delaware limited liability company, 1547 N. Knowles Ave., 90063, Los Angeles, California, US

(540)



(550) I

(740) Božidar S. Radulović, Studentska bb, Lamela 3/18, 81000, Podgorica

(511) Klasa 32: Fitnes napici.

(111) **14910**
(151) 26.10.2020.
(210) Ž-2019-287

(220) 17.07.2019.
(732) Lidl Stiftung & Co. KG , Stiftsbergstrasse 1, 74172, Neckarsulm, DE
(540)



(550) I

(740) AOD "Lutovac & partneri", Bulevar Ivana Crnojevića 93, 81000, Podgorica
(511) Klasa 33: Alkoholna pića (osim piva), naročito vina.

(111) **14911**
(151) 26.10.2020.
(210) Ž-2019-288
(220) 17.07.2019.
(732) Lidl Stiftung & Co. KG , Stiftsbergstrasse 1, 74172, Neckarsulm, DE
(540)



(550) I

(740) AOD "Lutovac & partneri", Bulevar Ivana Crnojevića 93, 81000, Podgorica
(511) Klasa 33: Alkoholna pića (osim piva), naročito vina.

(111) **14912**

(151) 26.10.2020.

(210) Ž-2019-289

(220) 17.07.2019.

(732) Lidl Stiftung & Co. KG , Stiftsbergstrasse 1, 74172, Neckarsulm, DE

(540)

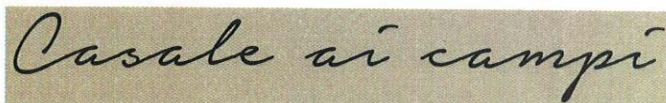

(550) I

(740) AOD "Lutovac & partneri", Bulevar Ivana Crnojevića 93, 81000, Podgorica

(511) Klasa 33: Alkoholna pića (osim piva), naročito vina.

(111) **14913**

(151) 26.10.2020.

(210) Ž-2019-257

(220) 28.06.2019.

(732) Lidl Stiftung & Co. KG, Stiftsbergstraße 1, 74172, Neckarsulm, DE

(540)



(550) I

(740) AOD MSA IP - Milojević Sekulić Advokati, Karađorđeva 65, 11000, Beograd

(511) Klasa 1: Natrijum bikarbonat.

Klasa 29: Konzervirano voće i povrće; pripremljeno voće i povrće; smrznuto voće, sušeno voće; kandirana kora pomorandže i kandirana kora limuna; mleveni bademi, prerađeni orašasti plodovi; rendani kokos (kokosovo brašno); deserti koji se uglavnom sastoje od voća; proizvodi od krompira, gotove smese koje sadrže proizvode od krompira; gotova punjenja za pečenje, koja se uglavnom sastoje od semena maka, orašastih plodova, badema, kokosovog brašna i/ili voća; želatin (za ishranu); deserti koji se uglavnom sastoje od želatina sa dodatkom šećera; mleveno seme maka; namirnice za aromatizovanje, naime, ekstrakti (sokovi), kora i/ili pulpa citrusa, uključujući u sušenom ili delimično osušenom obliku; ulje za kuvanje, ulja za kuvanje koja se koriste za aromatizovanje; želei.

Klasa 30: Kafa; čaj; šećer; šećer u prahu; tapioka; sago; zamena za kafu; brašno i proizvodi od žitarica, brašno za hleb, kukuruzno brašno, griz, hlebne mrvice; palenta; hleb, rezani

hleb, vekne hleba, kolači i poslastice, ražani proizvodi, torte, tart (slatka pita bez gornje kore), peciva, keks (kolači), krutoni; gotove mešavine za pečenje, mešavina za pravljenje kolača, mešavine za pravljenje hleba, gotova peciva, testo za kolače, prehrambena testenina, gotova prehrambena testenina; med, melasa; kvasac, prašak za pecivo, soda bikarbona (za pečenje); so; senf; sirće, sosovi (dodaci jelu); začini; začinski dodaci, dodaci za pića, začini za pečenje, arome i esencije za pečenje; skrob za ishranu, krompirovo brašno, kukuruzni skrob; vezivni agensi za sosove, sos u prahu; dodaci za zgušnjavanje hrane za kuvanje, preparati za učvršćivanje mućene pavlake, šlaga; glazure za torte, čokoladni preliv, fondan, šećerne mrvice, marcipan, bademovo testo, nugat, slatkiši od oraščastih plodova, oblada, vanila i vanillin šećer, štapići vanile, čokolada, proizvodi od čokolade, čokoladne mrvice, listići čokolade, granule i pahuljice od čokolade; čokoladni ukrasi za torte i slatkiše, naročito za ukrašavanje desertu; slatkiši; bombone; puding; puding u prahu, mešavine za pripremu pudinga; gotovi deserti od sladoleda; pripremljeni deserti (na bazi čokolade).

Klasa 31: Semenke od maka, orasasto voće, bademi.

Klasa 32: Piva.

(111) **14914**

(151) 26.10.2020.

(210) Ž-2019-374

(220) 27.09.2019.

(732) Lidl Stiftung & Co. KG, Stiftsbergstraße 1, 74172, Neckarsulm, DE

(540)

FREEWAY UP

(550) I

(740) AOD MSA IP - Milojević Sekulić Advokati, Karađorđeva 65, 11000, Beograd

(511) Klasa 32: Bezalkoholna pića, energetska pića.

(111) **14915**

(151) 26.10.2020.

(210) Ž-2019-276

(220) 11.07.2019.

(732) Lidl Stiftung & Co. KG, Stiftsbergstraße 1, 74172, Neckarsulm, DE

(540)



(550) I

(740) AOD MSA IP - Milojević Sekulić Advokati, Karađorđeva 65, 11000, Beograd

(511) Klasa 16: Kese za smeće i džakovi od papira ili plastike.

(111) **14916**

(151) 26.10.2020.

(210) Ž-2019-350

(220) 11.09.2019.

(732) KANEKA CORPORATION, a corporation organized and existing under the laws of Japan, Manufacturers and Merchants of, 2-3-18, Nakanoshima, Kita-ku, Osaka, JP

(540)

ED COIL

(550) I

(740) AOD MSA IP - Milojević Sekulić Advokati, Karađorđeva 65, 11000, Beograd

(511) Klasa 10: Uređaji za embolizaciju za lečenje vaskularnih anomalija.

(111) **14917**

(151) 26.10.2020.

(210) Ž-2019-472

(220) 02.12.2019.

(732) Cineplexx international GmbH, Siebensterngasse 37, 1070, Bec, AT

(540)

CINEPLEXX

(550) I

(740) Nataša Lalović Marić, Bulevar Mihajla Pupina 6, 11070, Beograd

(511) Klasa 35: Poslovno upravljanje vezano za poslovanje bioskopa.

Klasa 41: Razonoda; poslovanje bioskopa; bioskopska film i video produkcija; bioskopske prezentacije.

Klasa 43: Usluge koje se pružaju u kafeima, kafeterijama, restoranima, bar servisima, bifeima.

(111) **14918**

(151) 26.10.2020.

(210) Ž-2019-283

(220) 16.07.2019.

(732) DOO BUIL'D, Bečići bb, PF 70, Budva, ME

(540)



(550) I

(511) Klasa 43: agencije za smještaj [hotelski, pansionski]; aparati za kuvanje (iznajmljivanje); barovi (usluge barova); hotelske rezervacije (usluge rezervisanja hotela); hotelske usluge; kafane-restorani; privremeni smještaj (rezervisanje privremenog smještaja); restorani; restorani sa samoposluživanjem; restorani za brzo i stalno posluživanje [snek-barovi]; rezervisanje hotela; rezervisanje pansiona; rezervisanje privremenog smještaja; smještaj (agencije za izdavanje smještaja) [hoteli, pansioni]; smještaj (iznajmljivanje privremenog smještaja).

(111) **14919**

(151) 26.10.2020.

(210) Ž-2019-284
(220) 16.07.2019.
(732) DOO BUIL'D, Bečići bb, PF 70, Budva, ME
(540)



(550) I

(511) Klasa 43: agencije za smještaj [hotelski, pansionski]; aparati za kuvanje (iznajmljivanje); barovi (usluge barova); hotelske rezervacije (usluge rezervisanja hotela); hotelske usluge; kafane-restorani; privremeni smještaj (rezervisanje privremenog smještaja); restorani; restorani sa samoposluživanjem; restorani za brzo i stalno posluživanje [snek-barovi]; rezervisanje hotela; rezervisanje pansiona; rezervisanje privremenog smještaja; smještaj (agencije za izdavanje smještaja) [hoteli, pansioni]; smještaj (iznajmljivanje privremenog smještaja).

(111) **14920**
(151) 26.10.2020.
(210) Ž-2019-387
(220) 11.10.2019.
(732) VIA PARADISO DOO, UL.OKTOBARSKE REVOLUCIJE BR 5, PODGORICA, ME
(540)



(550) I

(511) Klasa 25: Odjeća, obuća, pokrivala za glavu.

(111) **14921**

(151) 26.10.2020.

(210) Ž-2019-201

(220) 20.05.2019.

(300) US br. 88/207168 od 27.11.2018.godine

(732) Reign Beverage Company LLC, a Delaware limited liability company, 1547 N. Knowles Ave., 90063, Los Angeles, California, US

(540)



(550) I

(740) Božidar S. Radulović, Studentska bb, Lamela 3/18, 81000, Podgorica

(511) Klasa 32: Fitnes napici.

(111) **14922**

(151) 26.10.2020.

(210) Ž-2019-205

(220) 24.05.2019.

(300) JP br. 2018-145370 od 26.11.2018.godine

(732) KIOXIA Corporation, 1-21, Shibaura 3-chome, Minato-ku, Tokyo, JP

(540)

KIOXIA

(550) I

(740) Božidar S. Radulović, Studentska bb, Lamela 3/18, 81000, Podgorica

(511) Klasa 7: Mašine za brušenje poluprovodničkih pločica; mašine za sečenje poluprovodničkih pločica; mašine za transportovanje poluprovodničkih pločica; mašine i sistemi za proizvodnju poluprovodnika.

Klasa 9: Mašine i instrumenti za analiziranje; mašine i instrumenti za merenje i testiranje; električni i magnetni metri i testeri; telekomunikacione mašine i aparati; SD memorijske kartice; kompjuterski mrežni adapteri; kompjuterski mrežni prekidači; kompjuterska mrežna čvorišta; kompjuterski mrežni ruteri; IC čipovi; memorijske kartice sa integrisani kolima; NAND fleš memorije; NAND fleš uređaji za skladištenje; NAND fleš memorijski kontroleri; NAND memorije; NVM memorije (memorije koje ne gube sadržaj nakon isključenja napajanja); NVM memorijski uređaji; USB fleš memorije; kertridži sa memorijom u čvrstom stanju; fleš memorije; fleš memorijske kartice; memorijske kartice; kućišta za memorijske

kartice; poluprovodnici; poluprovodničke memorije; poluprovodnički memorijski uređaji; kompjuterski mediji za skladištenje podataka; uređaji za skladištenje podataka; procesori podataka; kompjuterski memorijski uređaji; kompjuterski periferni uređaji; SSD diskovi; integrisana kola; štampane ploče; kompjuterski hardver; uređaji za praćenje bioloških informacija (koji nisu uključeni u klasu 10); kompjuterski program koji se može preuzeti sa interneta; kompjuterski programi; elektronske mašine, aparati i njihovi delovi; multimedijalne memorijske kartice i drugi mediji sa nasnimljenim podacima; elektronske publikacije.

Klasa 35: Usluge prodaje na malo i usluge prodaje na veliko u vezi sa električnim mašinama i aparatima; pružanje informacija koje se odnose na komercijalnu prodaju.

Klasa 41: Obezbeđivanje elektronskih publikacija; iznajmljivanje memorijskih medija sa nasnimljenim podacima.

Klasa 42: Projektovanje integrisanih kola; projektovanje kompjuterskog softvera, kompjutersko programiranje, i održavanje kompjuterskog softvera; tehničko savetovanje koje se odnosi na kompjutere, automobile i industrijske mašine; obezbeđivanje onlajn softvera koji se ne može preuzeti sa interneta; računarstvo u oblaku; obezbeđivanje kompjuterskih programa na mrežama podataka.

(111) **14923**

(151) 26.10.2020.

(210) Ž-2019-299

(220) 26.07.2019.

(732) 7-Eleven, Inc., 3200 Hackberry Road, 75063, Irving, Texas, US

(540)

7-ELEVEN

(550) I

(740) Božidar S. Radulović, Studentska bb, Lamela 3/18, 81000, Podgorica

(511) Klasa 30: Kafa; čaj; kakao; šećer; pirinač ; tapioka; sago; testenina; zamene za kafu; brašno i proizvodi od žitarica; hleb; peciva; poslastice; ledene poslastice; kolači, biskviti, suvi kolačići; med, melasa; kvasac; prašak za pecivo; so, senf; sirće; začini; led; pekarske poslastice, tart (slatka pita bez gornje kore) i pite; salate od makarona, pirinča i testenina; začinski dodaci, naročito kečap (sos), reliš (dodatak jelu), kiseli krastavac, reliš od kiselog krastavca, roštiljski sos, ljuti sos, čili sos, sos od sira i majonez; punjene rolnice i sendviči; sendviči sa viršlama; smrznuti, gotovi ili spakovani obroci koji se prvenstveno sastoje od pirinča, rezanaca i/ili testenine; pirinčane kuglice; zemičke kuvane na pari; takito (mala pržena rolavana punjena tortilja) i sendvič vrapovi; pica; pekarski proizvodi, naime gibanice, fokača, keks, braunis, mafini i krofne; čokolada; koštunjavo voće, grickalice i proizvodi od hleba sa čokoladnim prelivom; slatkiši, čokoladice i zvakaće gume; napici na bazi kafe i čaja; topla čokolada; pločice sa jogurtom; čips i krekeri napravljeni od kukuruza, pšenice i žita; salsa sos; sladoled; pikantne grickalice; pločice od žitarica i energetske pročiće; mešavina grickalice koja se prvenstveno sastoji od krekeri, pereca, i/ili gotovih kokica; mešavina grickalice koja se prvenstveno sastoji od koštunjavog voća sa prelivom (poslastica); žitarice,

grickalice na bazi žitarica, zrna kukuruza, granole, pirinča i pšenice.

Klasa 35: Oglašavanje; vođenje poslova; poslovno upravljanje; kancelarijski poslovi; usluge maloprodaje u supermarketima u oblasti robe široke potrošnje.

Klasa 43: Usluge obezbeđivanja hrane i pića; privremeni smeštaj; obezbeđivanje privremenog boravka i/ili pansionskog boravka u hotelima, hostelima, pansionima, kampovima, smeštajima za odmor i turističkim smeštajima; usluge rezervisanja privremenog smeštaja za boravak i/ili pansionski boravak u hotelima, hostelima, pansionima, kampovima, smeštajima za odmor i turističkim smeštajima; pružanje usluga restorana, barova, samouslužnih restorana, kantina, kafića, kafeterija i snek barova; usluge rezervisanja restorana, barova, samouslužnih restorana, kantina, kafića, kafeterija i snek barova.

(111) **14924**

(151) 26.10.2020.

(210) Ž-2019-197

(220) 20.05.2019.

(732) Omega Enterprises, Sarl, 6 Rue Eugene Ruppert, L-2453, Luxembourg, LU

(540)

NIKKI BEACH

(550) I

(740) Jasna Jusić, Dalmatinska 2, 81000, Podgorica

(511) Klasa 25: Odjeća, obuća, pokrivala za glavu.

Klasa 41: Obrazovanje; pružanje obuke; zabava; sportske i kulturne aktivnosti.

Klasa 43: Usluge obezbeđivanja hrane i pića; privremeni smještaj; usluge hotela, bara i restorana.

(111) **14925**

(151) 27.10.2020.

(210) Ž-2019-326

(220) 03.09.2019.

(732) D.O.O BUIL'D, Bečići bb, PF 70, ME

(540)

ANATOLIA

(550) I

(511) Klasa 36: Usluge upravljanja nepokretnostima (administriranje zgradama), tj. usluge izdavanja ili procjene ili finansiranja.

Klasa 43: Usluge obezbjeđivanja hrane i pica; privremeni smještaj; usluge koje pružaju lica ili ustanove čija je namjena pripremanje hrane i pica za potrošnju i usluge obezbjeđivanja ishrane i smještaja u hotelima, pansionima ili drugim ustanovama koje obezbjeđuju privremeni smještaj.

(111) **14926**

(151) 27.10.2020.

(210) Ž-2019-11

(220) 18.01.2019.

(732) Lidl Stiftung & Co. KG, Stiftsbergstraße 1, 74172, Neckarsulm, DE

(540)

DIZZY

(550) I

(740) AOD MSA IP - Milojević Sekulić Advokati, Karađorđeva 65, 11000, Beograd

(511) Klasa 32: Pivo, mineralne i sodne vode i druga bezalkoholna pića, voćni napici i voćni sokovi, sirupi i drugi preparati za proizvodnju pića.

(111) **14927**

(151) 27.10.2020.

(210) Ž-2019-22

(220) 28.01.2019.

(732) Jim Beam Brands Co., 222 W. Merchandise Mart Plaza, Suite 1600, 60654, Chicago, Illinois, US

(540)

KNOB CREEK

(550) I

(740) AOD MSA IP - Milojević Sekulić Advokati, Karađorđeva 65, 11000, Beograd

(511) Klasa 33: Alkoholna pića, izuzev piva; viski.

(111) **14928**

(151) 27.10.2020.

(210) Ž-2019-390

(220) 14.10.2019.

(732) Colgate-Palmolive Company (a Delaware corporation), 300 Park Avenue, 10022, New York, New York, US

(540)



(550) I

(740) Jasna Jusić, Dalmatinska 2, 81000, Podgorica

(511) Klasa 3: Nemedicinska pasta za zube, nemedicinska tečnost za ispiranje usta.

Klasa 21: Četkice za zube.

(111) **14929**

(151) 27.10.2020.

(210) Ž-2019-203

(220) 23.05.2019.

(732) ISHIHARA SANGYO KAISHA,LTD., 3-15, Edobori, 1-chome, Nishi-ku, Osaka, JP

(540)

KRYOR

(550) I

(740) Miladin Popović, Đoka Miraševića 21/III, 81000, Podgorica

(511) Klasa 5: Fungicidi kao poljoprivredne hemikalije; insekticidi; nematicidi; herbicidi; pesticidi.

(111) **14930**

(151) 27.10.2020.

(210) Ž-2019-338

(220) 05.09.2019.

(732) Kent Gida Maddeleri Sanayii ve Ticaret Anonim Sirketi, Cumhuriyet Mahallesi 2253, Sokak. No.11, 41400, Gebze/Kocaeli, TR

(540)

OLIPS

(550) I

(740) Miladin Popović, Đoka Miraševića 21/III, 81000, Podgorica

(511) Klasa 30: Konditorski proizvodi bez medikamenata; čokolada; konditorski proizvodi od čokolade; konditorski proizvodi od šećera, uključujući slatki korijen, karamelu, žele; smrznuti konditorski proizvodi; rashlađeni konditorski proizvodi; sladoled; led; deserti; kolači, biskviti i vafli; žvakaće gume i žvake.

(111) **14931**

(151) 27.10.2020.

(210) Ž-2019-394

(220) 16.10.2019.

(732) Merck Sharp & Dohme Corp., One Merck Drive, 08889, Whitehouse Station, New Jersey, US

(540)

PIFELTRO

(550) I

(740) Jasna Jusić, Dalmatinska 2, 81000, Podgorica

(511) Klasa 5: Farmaceutski preparati.

(111) **14932**

(151) 27.10.2020.

(210) Ž-2019-395

(220) 16.10.2019.

(732) Merck Sharp & Dohme Corp., One Merck Drive, 08889, Whitehouse Station, New Jersey, US

(540)

ZUMELPRA

(550) I

(740) Jasna Jusić, Dalmatinska 2, 81000, Podgorica

(511) Klasa 5: Farmaceutski preparati.

(111) **14937**

(151) 27.10.2020.

(210) Ž-2019-97

(220) 12.03.2019.

(732) Novartis AG, 4002, Basel, CH

(540)

TASUTERID

(550) I

(740) AOD MSA IP - Milojević Sekulić Advokati, Karađorđeva 65, 11000, Beograd

(511) Klasa 5: Farmaceutski preparati za ljudsku upotrebu.

(111) **14933**

(151) 27.10.2020.

(210) Ž-2019-396

(220) 16.10.2019.

(732) Merck Sharp & Dohme Corp., One Merck Drive, 08889, Whitehouse Station, New Jersey, US

(540)

ZIERVUS

(550) I

(740) Jasna Jusić, Dalmatinska 2, 81000, Podgorica

(511) Klasa 5: Farmaceutski preparati.

(111) **14934**

(151) 27.10.2020.

(210) Ž-2019-397

(220) 16.10.2019.

(732) Merck Sharp & Dohme Corp., One Merck Drive, 08889, Whitehouse Station, New Jersey, US

(540)

DELSTRIGO

(550) I

(740) Jasna Jusić, Dalmatinska 2, 81000, Podgorica

(511) Klasa 5: Farmaceutski preparati.

(111) **14935**

(151) 27.10.2020.

(210) Ž-2019-398

(220) 16.10.2019.

(732) Merck Sharp & Dohme Corp., One Merck Drive, 08889, Whitehouse Station, New Jersey, US

(540)

ZOTREPLIX

(550) I

(740) Jasna Jusić, Dalmatinska 2, 81000, Podgorica

(511) Klasa 5: Farmaceutski preparati.

(111) **14938**

(151) 27.10.2020.

(210) Ž-2019-346

(220) 11.09.2019.

(300) JM 077757 od 19.05.2019. godine

(732) Sincerely Ltd. B.V., 116 Ravenhill Road, 94563 CA, Orinda, US

(540)

LOVEFROM

(550) I

(740) Jasna Jusić, Dalmatinska 2, 81000, Podgorica

(511) Klasa 3: Preparati za bijeljenje i ostale tvari za pranje rublja; preparati za čišćenje, poliranje, odmašćivanje i abrazivni preparati; sapuni; parfimerijski proizvodi, eterična ulja, kozmetički proizvodi, proizvodi za njegu zuba; preparati za osvježavanje vazduha; aromati [esencijalna ulja]; tamjan; mirišljavi štapići; ulja za parfeme i mirise; potpuri [mirisi]; mirisne vrećice za rublje; mirišljava vodica; mirisljivo drvo; losioni za poslije brijanja; sredstva protiv znojenja [toaletni proizvodi]; preparati za brijanje; kolonjska voda; maska [parfimerijski proizvod]; kozmetički preparati; losioni za kozmetičke svrhe; šminka; parfemi; sapun; toaletni proizvodi; sprejovi za tijelo; preparati za ljepotu i njegu; ne-medicinski preparati za njegu i nanošenje na kosu, tjeme, kožu i nokte; preparati za sunčanje; preparati za zaštitu od sunca; preparati za osvježavanje daha; preparati za kosu; losioni za kosu; šamponi; regeneratori za kosu; preparati za njegu kože; nemedicinski preparati za nanošenje na, regeneraciju i njegu kose, tjemena, kože i noktiju; vještački nokti; lak za nokte; preparati za pranje rublja; preparati za struganje; sredstva i preparati za depilaciju; šmirgl papir; kamen za glačanje; preparati za pranje vozila; regeneratori za tkaninu; sapun deterdžent; omekšivači tkanine; preparati za bijeljenje rublja; sapuni u prahu; prašak za

pranje; soda za pranje; preparati za čišćenje i poliranje kože i cipela; abrazivna krpa; abrazivni papir; ljepila za kozmetičke svrhe; antistatički preparati za upotrebu u domaćinstvu; krpa za struganje; šmirgl papir; preparati za uklanjanje laka; šamponi za kućne ljubimce; odmašćivači i preparati za struganje; preparati za rast kose.

Klasa 7: Mašinske alatke; motori i mašine [osim za kopnena vozila]; kvačila i prenosne komponente [osim za kopnena vozila]; poljoprivredna oruđa koja se ne pokreću ručno; inkubatori za jaja; automatski prodajni automati; roboti; industrijski roboti; laboratorijski roboti; transportni roboti; automatizovani sistemi za rukovanje materijalima koji se sastoje od industrijske opreme, naime, jedinice na mobilni pogon, podesivi inventorski spremnici, inventorske stanice i stanice za održavanje, sve to za potrebe obrade i podnošenja naloga magacinima za obavljanje distribucije i proizvodnje; mješalice; aparati za pripremanje pića, električne mješalice za domaćinstva; aparati za rezanje hljeba; aparati za kuvanje; električni otvarači konzervi; uređaji za potkresivanje [uređaji]; mlinovi za kafu, koji nijesu ručni; aparati za drobljenje; aparati za rezanje; aparati za punjenje; filter aparati; električni aparati za spremanje hrane; električni kuhinjski aparati; aparati za mljevenje; aparati koji se drže u ruci, a koji se ne pokreću ručno; aparati za peglanje; električni kuhinjski mlinovi; električni kuhinjski aparati; električni noževi; električni kuhinjski aparati za rezanje; električni uređaji i aparati za čišćenje; uređaji i aparati za poliranje [električni]; aparati za pravljenje pašte; sjeckalica za meso [uređaj]; mikseri [uređaji]; uređaji za miješanje; pumpe [uređaji]; uređaji za ispiranje; uređaji za oštrenje; usisivači; električne mutilice za korištenje u domaćinstvima; kosilice za travu; kultivatori; električni uređaji za podrezivanje; električni motori; uređaji za bušenje, rezanje i sitnjenje; aparati za friziranje kose; uređaji za predenje; uređaji za prskanje; uređaji za razastiranje đubriva; pletaće mašine; šivaće mašine; aparati za zaptivanje i čepljenje boca; aparati za duvanje; pištolj za raspršivanje farbe; raspršivači (uređaji); sakupljači kamenca u kotlovima; uređaji za šišanje životinja; uređaji za pravljenje slika; kvačila i mjenjači (osim za kopnena vozila); kese (usisivači —); kertridži za uređaje za filtriranje; otvarači i zatvarači vrata [uređaji]; glave za bušilice [djelovi mašina]; rezači/svrkla za burgije [djelovi mašina]; grijači za dizel motore; oprema za paljenje motora sa unutrašnjim sagorijevanjem; točkovi za oštrenje [djelovi mašina]; crijeva za usisivače; djelovi i oprema za sve naprijed pomenute robe.

Klasa 8: Ručni alat i pribor [ručni]; pribor za ručavanje; vatreno oružje; brijaći; ručne sjeckalice; ručno pokretani prerađivači hrane; ručno pokretani rezači hrane; ne- električni otvarači konzervi; mesarske sjekire/satare; alat za rezanje [ručni]; turpije [alat]; ručno pokretani baštenski alat; ručne pumpe; pegle [ne-električne ručne]; viljuške; noževi; kašike; alati za bušenje rupa [ručni alati]; ne-električni rezači pica; probijači [ručni alat]; makaze; strugači [ručni alat]; instrumenti za oštrenje; strigači [ručni alat]; kašike; escajg [noževi, viljuške i kašike]; pribor za ručavanje u kantinama; kutije prilagođene za pribor za ručavanje; sjeckalice za povrće; sjekači za povrće; noževi za rezanje šnicli; pribor za šišanje i uklanjanje dlaka; uređaji za friziranje kose; alat za manikir; alat za pedikir; pribor za čuvanje; ručni poljoprivredni uređaji i alati; ručni uređaji i alati za baštovanstvo; ručni uređaji i alati za pejzažno uređenje; uređaji za održavanje kamina; ručni alati za rezanje, bušenje, sitnjenje, oštrenje i površinsku obradu; alati za stezanje i pričvršćivanje; alati i uređaji za podizanje; makazice za bradu; uređaji za oštrenje sječiva; štipaljke za stolare ili bačvare; gvozdeni savijači; električne pegle; glačala; rudarske poluge; klješta za uvijanje; klješta za uklanjanje kožice oko noktiju; strugarske šipke; sjekači; sjekači za šipke/bonsek; alat za rezanje [ručni]; turpijice od šmirgle; makazice za šišanje za ličnu upotrebu; pincete za uklanjanje dlaka; čelik za noževe; pincete i klješta za uklanjanje kožice oko noktiju; pincete za uklanjanje dlaka; komplet za pedikir; turpije za nokte; sprave za uvlačenje

konca u iglu; makaze; makaze za nokte; pribor za jelo za bebe, novorođenčad i djecu; plastično stono posuđe (pribor za jelo) za jednokratnu upotrebu; kašike sa zaobljenim vrhom za bebe, novorođenčad i djecu; avani za tučenje; pribor za brijanje; kutije za žilete; djelovi i oprema za sve naprijed pomenute robe.

Klasa 9: Računari; računarski hardver; ručni računari; tablet računari; telekomunikacioni uređaji i instrumenti; telefoni; mobilni telefoni; pametni telefoni; uređaji za bežičnu komunikaciju za prenos glasa, podataka, slika, audio, video i multimedijalnog sadržaja; mrežni komunikacioni uređaji; ručni digitalni elektronski uređaji koji omogućavaju pristup internetu i koji služe za slanje, prijem i čuvanje telefonskih poziva, elektronske pošte i drugih digitalnih podataka; nosivi računarski hardver; nosivi digitalni elektronski uređaji koji omogućavaju pristup internetu i koji služe za slanje, prijem i čuvanje telefonskih poziva, elektronske pošte i drugih digitalnih podataka; pametni satovi; pametne naočare; pametni prstenovi; nosivi uređaji za praćenje aktivnosti; pametne narukvice [mjerni instrumenti]; elektronski čitači knjiga; računarski softver; računarski softver za postavljanje, konfiguraciju, rad i upravljanje računarima, računarskim vanjskim jedinicama, mobilnim uređajima, mobilnim telefonima, pametnim satovima, pametnim naočarima, nosivim uređajima, slušalicama koje se umeću u uši, slušalicama koje se stavljaju na glavu, televizorima, upravljačkim kutijama za televizore, audio i video plejerima i rekorderima, sistemima kućnog bioskopa i sistemima za zabavu; softver za izradu aplikacija; softver za kompjuterske igrice; prethodno snimljeni audio, video i multimedijalni sadržaj koji se može preuzimati; računarske vanjske jedinice; vanjske jedinice za računare, mobilne telefone, mobilne elektronske uređaje, nosive elektronske uređaje, pametne satove, pametne naočare, slušalice koje se umeću u uši, slušalice koje se stavljaju na glavu, televizije, upravljačke kutije za televizore i audio i video plejere i rekordere; nosive vanjske jedinice za korištenje sa računarima, mobilnim telefonima, mobilnim elektronskim uređajima, pametnim satovima, pametnim naočarima, pametnim prstenovima, slušalicama koje se umeću u uši, slušalicama koje se stavljaju na glavu, televizorima, upravljačkim kutijama za televizore i audio i video plejerima i rekorderima; biometrijski aparati za utvrđivanje i provjeru identiteta; mjerači ubrzanja; visinomjeri; aparat za mjerenje rastojanja; aparat za bilježenje rastojanja; pedometri; aparat za mjerenje pritiska; pokazivači pritiska; monitori, ekrani, ekrani koji se nose na glavi i slušalice koje se stavljaju na glavu za korištenje sa računarima, pametnim telefonima, mobilnim elektronskim uređajima, nosivim elektronskim uređajima, pametnim satovima, pametnim naočarima, televizorima, upravljačkim kutijama za televizore i audio i video plejerima i rekorderima; ekrani, naočare, upravljači i slušalice za virtuelni i prošireni prikaz realnosti; 3D naočare; naočare; naočare za sunce; sočiva za naočare; optičko staklo; optička roba; optički aparati i instrumenti; fotoaparati; blicevi za fotoaparate; tastature, miševi, podmetači za miševе, štampači, disk drajvz i hard drajvz; uređaji za snimanje i reprodukciju zvuka; digitalni audio i video plejeri i rekorderi; audiozvučnici; audio pojačivači i prijemnici; audio aparati za motorna vozila; aparati za snimanje i prepoznavanje glasa; slušalice koje se umeću u uši; slušalice koje se stavljaju na glavu; mikrofoni; televizori; televizijski prijemnici i monitori; upravljačke kutije za televizore; radija; radio prenosnici i prijemnici; korisnički interfejsi za računare i elektronske uređaje ugrađene u motorna vozila, naime, elektronske kontrolne table, monitori, ekrani osjetljivi na dodir, daljinski upravljači, priključne stanice, konektori, prekidači i upravljači koji se glasovno aktiviraju; globalni pozicioni sistemi (GPS uređaji); navigacioni instrumenti; navigacioni aparati za vozila unutrašnji [računari]; daljinski upravljači za upravljanje računarima, mobilnim telefonima, mobilnim elektronskim uređajima, nosivim elektronskim uređajima, pametnim satovima, pametnim naočarima, slušalicama koje se

umeću u uši, slušalicama koje se stavljaju na glavu, audio i video plejerima i rekorderima, televizorima, upravljačkim kutijama za televizore, zvučnicima, pojačivačima, sistemima kućnih bioskopa i sistemima za zabavu; nosivi uređaji za upravljanje računarima, mobilnim telefonima, mobilnim elektronskim uređajima, pametnim satovima, pametnim naočarima, slušalicama koje se umeću u uši, slušalicama koje se stavljaju na glavu, audio i video plejerima i rekorderima, televizorima, upravljačkim kutijama za televizore, zvučnicima, pojačivačima, sistemima kućnih bioskopa i sistemima za zabavu; aparati za smještaj podataka; računarski čipovi; baterije; punjači za baterije; električni i elektronski konektori, spojnice, žice, kablovi, punjači, priključci, priključne stanice i adapteri za korištenje sa računarima, mobilnim telefonima, ručnim računarima, računarskim vanjskim jedinicama, mobilnim elektronskim uređajima, nosivim elektronskim uređajima, pametnim telefonima, pametnim naočarima, slušalicama koje se umeću u uši, slušalicama koje se stavljaju na glavu, audio i video plejerima i rekorderima, televizorima, upravljačkim kutijama za televizore; interaktivni ekrani osjetljivi na dodir; interfejsi za računare, računarski ekrani, mobilni telefoni, mobilni elektronski uređaji, nosivi elektronski uređaji, pametni satovi, pametne naočare, televizori, upravljačke kutije za televizore i audio i video plejeri i rekorderi; zaštitni filmovi prilagođeni za računarske ekrane, ekrane mobilnih telefona i ekrane pametnih satova; djelovi i pribor za računare, računarske vanjske jedinice, mobilne telefone, mobilne elektronske uređaje, nosive elektronske uređaje, pametne satove, pametne naočare, slušalice koje se umeću u uši, slušalice koje se stavljaju na glavu, audio i video plejere i rekordere, televizore i upravljačke kutije za televizore; navlake, kese, kutije, omoti, trake i uzice za računare, mobilne telefone, mobilne elektronske uređaje, nosive elektronske uređaje, pametne satove, pametne naočare, slušalice koje se umeću u uši, slušalice koje se stavljaju na glavu, upravljačke kutije za televizore i audio i video plejere i rekordere; štapovi za držanje mobilnih telefona prilikom pravljenja selfia; punjači za elektronske cigarete; elektronske kragne za dresiranje životinja; elektronske agende; aparati za provjeru markica na pošti; registarske kase; mehanizmi za aparate za kovani novac; mašine za diktiranje; markeri za obilježavanje ivica; glasačke mašine; elektronski očitivači robe (etikete); faksimil mašine; aparati i instrumenti za mjerenje težine; instrumenti za mjerenje; elektronske table za obavješavanje; aparati za mjerenje; podmetači [silikonske ploče]; integrisana kola; pojačivači; fluorescentni ekrani; daljinski upravljači; optička vlakna; električne instalacije za daljinsko upravljanje industrijskim procesima; svjetlosni zaustavljači; elektrolizeri; uređaji za gašenje požara; radiološki aparati za industrijsku upotrebu; aparati i oprema za spašavanje; zviždeći alarmi; crtani filmovi; jajoliki svijećnaci; zviždaljke za pse; ukrasni magneti; elektrificirane ograde; prenosivi retarderi za automobile na daljinsko upravljanje; računarski hardver za reprodukciju, organizaciju, preuzimanje, prenošenje, manipulaciju i pregled audio datoteka i medijskih datoteka; elektronski uređaji koji omogućavaju pristup internetu i slanje, prijem i smještaj digitalnih podataka; pametni audio zvučnici kojima se upravlja glasom sa sposobnostima virtuelnog personalnog asistenta; personalni digitalni asistenti; elektronski aparati za glasovne komande i prepoznavanje glasa za upravljanje radom elektronskih uređaja za široku upotrebu i sistemima stambenih zgrada; elektronski aparati za glasovne komande i prepoznavanje glasa i uređaji za daljinsko upravljanje za upravljanje i praćenje elektronskih uređaja, rasvjete, kućanskih aparata, termostata, sistema za grijanje i hlađenje, alarma i kućnih sigurnosnih i nadzornih sistema, detektora dima i ugljen monoksida, brava i reza za vrata i prozora i kućnih automatskih sistema za široku upotrebu: pribor za pametne audio zvučnike; programi za kompjuterske igrice, prenosive igrice sa ekranima od tečnog kristala.

Klasa 10: Osnovni instrumenti za wellness, naime, zdravlje, fitnis, vježbanje i velnis senzori, monitori i ekrani za mjerenje, prikazivanje, praćenje, monitoring, čuvanje i prenos biometrijskih podataka, otkucaja srca, pokreta tijela i sagorelih kalorija; osnovni aparati i uređaji za velnis za mjerenje, prikazivanje, praćenje, monitoring, čuvanje i prenos biometrijskih podataka, otkucaja srca, pokreta tijela i sagorelih kalorija.

Klasa 11: Aparati za rasvjetu, grijanje, proizvodnju pare, kuvanje, hlađenje, sušenje, ventilaciju, snabdijevanje vodom i sanitarne potrebe; roštilji; oprema za kupatila; instalacije za kupatila; oprema za tuševe; oprema za lavaboe; aparati za hlađenje pića; pijaća voda (filteri za -); električna čebad, (nijesu za medicinsku upotrebu); mašine za pravljenje hljeba; tosteri za hljeb; električna svjetla; plafonska svjetla; zidna svjetla; električna svjetla; ukrasna svjetla; solarna svjetla; svijećnaci; električni aparati za kuvanje kafe; šporeti; aspiratori za eliminisanje mirisa i pare u kuhinjama; električne sprave za kuvanje; frižideri; zamrzivači; oprema i instalacije za hlađenje; električne friteze; električni ventilatori za ličnu upotrebu; sobni ventilatori; električne lampe; električne lampice za božićnu jelku; električni aparati za kuvanje na paru; boce za vruću vodu; kutije za led; lampe; držači abažura; fenjeri za osvjetljavanje; sijalice; mikrotalasne pećnice [aparati za kuvanje]; višenamjenska kuvala; plotne; električne džepne lampe; električni lonci za kuvanje pod pritiskom; čajnici; električni čajnici; kuhinjski šporeti [peći]; lampe; držači abažura; sijalice; električne sijalice; daske za wc šolje; električne kafetijere (posude za kuvanje kafe); kade; tuševi; daske za wc šolje i prenosive sanitarne instalacije; sanitarni aparati i instalacije; adapteri za daske za wc šolje i adapteri za daske za wc šolje za djecu; sterilizatori i aparati i oprema za sterilizaciju; sterilizatori za bočice za bebe; vrećice za sterilizaciju za jednokratnu upotrebu; uređaji za sterilizaciju na pari; uređaji za sterilizaciju ultraljubičastim zracima; uređaji za sterilizaciju na putovanju za bočice i opremu za hranjenje beba; svjetla na biciklima; mašine za pravljenje kafe; kupatilske instalacije i oprema uključujući wc šolje; djelovi i oprema za sve gore navedene robe.

Klasa 12: Vozila; aparati za kretanje po kopnu, vazduhu, vodi ili šinama; letjelice; automobili; bicikla; kola; dronovi; dronovi sa kamerama; civilni dronovi; vozila na električni pogon; motocikli; kamioni; vozila bez vozača; bespilotne letjelice; električna vozila; kombiji; dostavni kombiji; vozila na daljinsko upravljanje koja nijesu igračke; gume i točkovi za vozila i bicikla; alarmi i uređaji protiv krađe za vozila; ljepljive gumene zakrpe za popravku unutrašnjih guma; vazdušne pumpe [pribor za vozila]; oprema protiv zasljepljivanja za vozila; lanci protiv klizanja; automobilske gume; kočione pločice za automobile (sigurnosne); navlake (za sjedišta) za vozila; navlake za volane; sigurnosni pojasevi za sjedišta vozila; brisači farova; nasloni za glavu za sjedišta u vozilima; rodkapne; nosači prtljaga za vozila; mreže za prtljag kod vozila; nosači skija za automobile; kolica za transport; prozori za vozila; brisači vjetrobrana; vjetrobrani; brisači vjetrobrana; pretinci u kolima; spremnici za prtljažnik; držači vozačkih dozvola; vrpce za zaštitu od sunca; pomični krovovi; roletne; držači boca pića kod vozila po kopnu; pregrade za pse u vozilima; gepek na krovu vozila; krovni nosači; nosači na krovu; blatobrani; antistatičke trake; nasloni i jastuci prilagođeni za vozila po kopnu; pribor za popravku probušene gume; prikolice; sirene za maglu; neklizajući podovi; pokrivači za vjetrobrane ili zaštita od mraza i/sunca; navlake za vozila; lanci za snijeg; profili guma; pomoćno dječije sjedište u kolima; nosiljke za djecu; pokazivači širine za bicikla, aerodinamički profil za kopnena vozila; zvučni sistemi upozorenja za bicikla; korpe prilagođene za korištenje na biciklima; zvana za bicikla; kočnice za bicikla; lanci za bicikla; ramovi za bicikla; ručke od bicikala; pumpe za bicikla; felge bicikala; sjedišta za bicikla; osovine za bicikla; postolja za bicikla; gume za bicikla; unutrašnje gume za bicikla; pumpe za bicikla; držači boca za vode na

motociklima; dječija kolica; kolica za bebe; nosiljke za bebe; navlake za nosiljke za bebe; kabanice za nosiljke za bebe; navlake za kolica za bebe; kabanice za kolica za bebe; invalidska kolica; ručna kolica sa jednim točkom (tačke); kolica za transport; djelovi i pribor za sve naprijed navedene robe.

Klasa 14: Plemeniti metali i njihove legure; nakit; nakit, drago kamenje; bedževi od plemenitog metala; perlice za izradu nakita; kutije od plemenitog metala; imitacija zlata (predmeti napravljeni od-); slonovača [za nakit]; kutije za nakit; privjesci za ključeve [obični ili ukrasni]; medalje; predmeti od imitacije zlata; poludrago kamenje; statue/statuete od plemenitog metala; horološki i hronometarski instrumenti; satovi; ručni satovi; časovnici; klatna za časovnike i satove; kutije za časovnike i klatna; kutije za časovnike i klatna; kutije za satove [reklamne]; kaiševi za ručne satove; narukvice za satove; kutije za satove; lanci za satove; djelovi i pribor za sve naprijed pomenute robe.

Klasa 15: Muzički instrumenti; palice za bubnjeve; gudala za muzičke instrumente; kutije za muzičke instrumente; klavijature za muzičke instrumente; dirke za muzičke instrumente; piskovi za muzičke instrumente; muzički pultovi; muzički sintisajzeri; muzičke kutije; prigušivači za muzičke instrumenti; pedale za muzičke instrumente; čivije (ključevi za zatezanje žica) za muzičke instrumente; perforirane muzičke rolne; klavijatura za pijano; dirke za klavir; žice za klavir; trzalice; duvačke svirale; rolne (perforirane muzičke-); postolja za muzičke instrumente; zvučne viljuške; ključevi za štimovanje; aparat za okretanje muzičkih nota; ventili za muzičke instrumente; djelovi i pribor za sve naprijed pomenute robe.

Klasa 16: Papir, karton; štampane stvari i knjige; materijal za korićenje knjiga; fotografije; kancelarijski pribor; naljepnice i ljepila za upotrebu u kancelariji ili domaćinstvu; umjetnički materijali; slikarske četkice; pisaće mašine i kancelarijski pribor; materijal za poduku i nastavu; plastični materijali za pakovanje; štamparska slova, štamparski blokovi; štampane publikacije; knjige; časopisi; bilteni; periodične publikacije; brošure; knjižice; pamfleti; priručnici; dnevници; leci; čestitke; reklamni i promotivni materijal; katalozi; knjige iz oblasti fikcije i publicistike na različite teme; serije knjiga iz oblasti fikcije i publicistike, stripovi, romani sa ilustracijama, ilustrovane priče i priče u stripu, priče u crtežima i grafike; periodične publikacije iz oblasti stripova, priča u crtežima i grafici; štampane stvari iz oblasti računara; štampane stvari iz oblasti tablet računara; štampane stvari iz oblasti multimedijalnih proizvoda, interaktivnih proizvoda i usluga putem interneta; katalozi u vezi sa računarskim softverom; računarske brošure; priručnici o računarima; publikacije o računarskom hardveru; priručnici za računarski hardver; uputstva za korisnike računarskih hardvera; uputstva za korištenje računara; priručnici za računare; publikacije u vezi sa tehnologijom, digitalnom tehnologijom i malim aparatima; uputstva za korisnike u elektronski čitljivom, mašinski čitljivom ili računarski čitljivom formatu za korištenje ili za prodaju uz nosive i ručne elektronske uređaje i računare; katalozi muzičkih aparata i instrumenata; katalozi telekomunikacionih aparata, mobilnih telefona, ručnih i mobilnih digitalnih elektronskih uređaja za slanje i primanje telefonskih poziva, faksova, elektronske pošte, videa, instant poruka, muzičkih, audiovizuelnih i drugih multimedijalnih djela i drugih digitalnih podataka; muzičke knjige; muzički priručnici; muzički časopis; pisaći pribor; telefonski adresari; planovi rada (agende); dnevници; kalendari; poster; okačene i neokačene fotografije; štampani uzorci za majice i trik majice; štampani uzorci za šivenje; materijali za izlaganje; preslikači i naljepnice; knjižice za prodaju sa audio trakama; preslikači; dnevници; poklon čestitke; poklon vaučeri; etikete; mape; dnevници; rječnici; lični organajzeri; poštanske markice; razglednice; poster; zamjenjive papirne kese za usisivače; papirne kese za spremanje hrane u mikrotalasnoj pećnici; papirni proizvodi za

jednokratnu upotrebu; upijajući papir; papirne maramice; papirni ubrusi; vaučeri; kutije za poklone; vrećice za poklone; fotografski štamparski papir; papirni stolnjaci; papirni podmetači; papirni uski dugački stolnjaci; djelovi i pribor za sve naprijed navedene robe. Klasa 18: Koža i imitacija kože; životinjska koža, štavljena koža; koferi i putne torbe; kišobrani i suncobrani; štapovi; bičevi, remenje i sedlarska roba; akten tašne; vreće, vreće za kampere; vreće za sport; vreće za plažu; kutije od kože ili kožni adresari; omoti i korice za blokove [bilježnice]; kutije od kože ili kožni adresari, imenici ili albumi; prekrivači namještaja od kože ili imitacije kože; putne torbe za odjeću; kutije za šešire od kože ili imitacije kože; ranci; futrole za ključeve; privjesci za prtljag; suncobrani; novčanici; tašne; ruksaci; torbe za kupovinu; rameni kaiševi od kože ili imitacije kože; koferi; kaiševi - remenici za nošenje novorodenčadi; torbe za alat, prazne; putni kompleti [kožna roba]; akten tašne; kaiševi; kožni kaiševi; ogrlice i povoci za životinje; futrole za ključeve; pertle; muzičke kutije; tašne; školske torbe; novčanici; krzno i odjeća i artikli napravljeni od krzna; putne torbe; neseseri, prazni; torbe za kupovinu na točkicama; djelovi i pribor za sve naprijed pomenute robe.

Klasa 20: Namještaj; ogledala, ramovi za slike; neobrađena ili poluobrađena kost, rog, slonovača, kitova kost ili sedef; školjke; morska pjena; žuti ćilibar; fotelje; bačve, nemetalne; korpe, nemetalne; okviri za krevete; točkići za krevete, nemetalni; navlake za krevet osim posteljine; oprema za krevet, nemetalna; kreveti; kreveti za kućne ljubimce; drveni okviri kreveta; klupe [namještaj]; jastuci; stalci za boce; kutije od drveta ili plastike; drške za metle, nemetalne; burad, nemetalna; stolice [sjedišta]; sanduci, nemetalni; komode; daske za sječenje [stolovi]; spone i zatege za kablove i cijevi, koji nijesu od metala; zatvarači kontejnera, nemetalni; kuke za kačenje odjeće, nemetalne;

vješaonici za kapute; stalci za kapute; kontejneri, nemetalni [za skladištenje, transport]; plutani čepovi; navlake za garderobu [garderobler]; sanduci (gajbe); ormani; držači zavjesa, koji nijesu od tekstila; kuke za zavjese; šipke za zavjese; alke za zavjese; šipke za zavjese; omče i petlje za zavjese; jastuci; stolice za ležanje (ligeštuli); dekoracije od plastike za hranu; pisaći stolovi; oglasne table; divani; zvana na vratima, nemetalna i ne-električna; klinovi za vrata, nemetalni; zatvarači za vrata, nemetalni; djelovi za vrata, nemetalni; kvake za vrata, nemetalne; sprave za kucanje na vratima; toaletni stočići; naslonjače (ležaljke); ventilatori za ličnu upotrebu, koji nijesu električni; figurice [statuete] od drveta, voska, gipsa ili plastike; ormani za dokumenta; postolja za saksije; postolja za saksije [namještaj]; oprema za namještaj, nemetalna; namještaj od metala; police; korpe za rublje sa poklopcem; kućice i kontejneri za kućne ljubimce; ručna ogledala [toaletna ogledala]; držači za šešire; kuke, nemetalne, za vješanje odjeće; kućni brojevi, nemetalni, koji ne svijetle; unutrašnje prozorske roletne [za zamračenje] [namještaj]; namještaj na naduvavanje; reklamni predmeti na naduvavanje; platnene unutrašnje prozorske roletne; okrugle ručke, nemetalne; merdevine od drveta ili plastike; stalci za časopise; krojačke lutke; dušeci; ormarići za lijekove; ogledala; pločice od ogledala; skulpture [ukras]; kancelarijski namještaj; plastični kontejneri za pakovanje; papirne roletne; kočiči [igle], nemetalni; jastuci; stalci za tanjire; stubovi, nemetalni; stalci [namještaj]; ratan; podmetači ili pokrivači za sudopere koji se mogu uklanjati; paravani za kamine [namještaj]; paravani [namještaj]; sofe, divani i klupe; police za skladištenje; djelovi polica; vitrine [namještaj]; ormani, kredenci za posude; vreće za spavanje u šatoru; podmetači za spavanje; sofe; statue od drveta, voska, gipsa ili plastike; stepenice [merdevine], nemetalne; pomoćne male merdevine, nemetalne; stolice; stolovi; ploče od stola; kutije za alat, nemetalne, prazne; držači za peškire, pričvršćeni, nemetalni; stalci za peškire [namještaj]; tacne, nemetalne; kolica [namještaj]; stalci za kišobrane; umivaonici [namještaj]; zvonca

pokretana vjetrom [ukrasna]; zatvarači za prozore, nemetalni; oprema za prozore, nemetalna; umjetnička djela od drveta, voska, gipsa ili plastike; nemetalne kante; namještaj za kupatila; namještaj za skladišta; kontejneri za drenažu ulja; čepovi za zatvaranje; nemetalne L table i tablice sa oznakom zemlje na vozilima; nemetalne oznake; držači vozačke dozvole (nemetalni), nemetalni zatvarači, matice i podloške; posude za vodu; kutije za alat i kolica (nemetalna); unutrašnje roletne od letvica; radne klupe; vreće za spavanje, stolice na rasklapanje, stoličice na rasklapanje i kreveti na rasklapanje; jastuci; vazdušni kreveti; korpe; vješaonici za odjeću; tablice sa brojevima; nemetalne trake za kablove; police (rafovi); ormarići; kutije za odlaganje; gajbice; ogledala; kontejneri za gorivo; držači za knjige, korpe; djelovi i pribor za sve naprijed pomenute robe.

Klasa 21: Kućne ili kuhinjske potrepštine i posude; češljevi i sušeri; četke [osim slikarskih četki]; materijali za pravljenje četaka; artikli za čišćenje; čelična vuna; neobrađeno ili poluobrađeno staklo [osim građevinskog stakla]; staklarija, porcelan i grnčarija; abrazivni jastučići za upotrebu u kuhinji; posude [za čuvanje hrane]; korpe za upotrebu u domaćinstvu; kašike za prelivanje [pribor za kuvanje]; mutilice, ne-električne; krigle za pivo; čaše za pivo; vrčevi za pivo; mješalice, ne-električne, za upotrebu u domaćinstvu; otvarači za boce, električni i ne-električni; boce; zdjele [činije]; korpice za hljeb, za kućnu upotrebu; kutije za hljeb; daske za sječenje hljeba; metle; četkarska roba; kofe; kandelabri [svijećnaci]; sprave za gašenje svijeća; teglice sa svijećom [držači]; prstenovi za svijeće; uređaji za čišćenje tepiha; kazani (kotlovi); keramički proizvodi za upotrebu u domaćinstvu; kofe za šampanjac; čaše za šampanjac; porcelanski ukrasi; štapići za jelo; instrumenti za čišćenje, ručni; vješalice za veš; krpe za čišćenje; podmetači koji nijesu od papira i koji nijesu stono platno; ručni mikseri za koktele; posude za miješanje koktela; filteri za kafu, ne-električni; mlinovi za kafu, ručni; filteri za kafu, ne-električni; džezve za kafu, ne-električne; servisi za kafu [stono posuđe]; posuđe za upotrebu u domaćinstvu ili kuhinji; šerpe; kompleti šerpi; kuhinjske metalne igle (za ražanj); pribor za kuvanje, ne-električni; hladionica [posude za led]; vadičepovi, električni i ne-električni; flašice; mlinovi za upotrebu u kuhinji; ne-električni; kristal [staklarija]; šolje; poslužavnici za escajg; kuhinjske daske za sječenje; bokali; friteze, ne-električne; aparati za dezodorans za ličnu upotrebu; pokrivači za sudove; posude; tanjiri za jednokratnu upotrebu; čaše za piće; slamke za piće; posude za piće i pribor za barove; kante za otpatke; zemljane posude; čašice za jaja; figurice [statuete] porcelanske, keramičke, zemljane ili staklene; izletničke korpe zajedno sa posuđem; bočice; saksije za cvijeće; posude za kuvanje na pari, ne-električne; tiganji; lijevci; baštovanske rukavice; presa za bijeli luk [kuhinjski pribor]; staklene zdjele; staklene posude [za čuvanje hrane]; staklo, obrađeno ili neobrađeno, osim stakla u građevinarstvu; rukavice za domaćinstvo; rende za kuhinjsku upotrebu; roštilji [pribor za kuvanje]; toplotno-izolacione posude; posude za čuvanje toplote pića; pljoske; držači za cvijeće i biljke [za cvijetne aranžmane]; tople posude, bez električnog zagrijavanja; kalupi za kocke leda; sobni akvarijumi; sobni terarijumi [za uzgajanje biljaka]; navlake za daske za peglanje; daske za peglanje; čajnici, ne-električni; kuhinjske posude; kuhinjski mlinovi, ne-električni; kuhinjske potrepštine; kutije za hranu; mlinovi za korištenje u domaćinstvu, ručni; kašike za miješanje [kuhinjske potrepštine]; brisači poda sa resama od tkanine; šolje; kompleti šolja; četkice za nokte; držači za salvete; prstenovi za salvete; rukavice za pećnice; papirni tanjiri; noževi za kolače; mlinci za biber, ručni; sprejovi za parfeme; lopatice za posluživanje pite; pehari (bokali za piće); aparati i mašine za poliranje u domaćinstvu, ne-električni; porcelansko posuđe; podmetači za vruće šerpe; poklopci za šerpe; šerpe; lonci; uređaji za kuvanje pod pritiskom [autoklavi], ne-električni; oklagije, kućne; činije za salatu; slanici; tacne; kutlače [stono posuđe]; servisi [posuđe], četke za

brijanje; stalci za četke za brijanje; kutije ze sapun; dozeri za sapun; držači za sapun; zdjele za sapun; špatule [kuhinjske potrepštine]; kompleti začina; porcelanske, keramičke, zemljane ili staklene figurice; cediljke za upotrebu u domaćinstvu; posude za šećer; tanjiri; pribor za jelo osim noževa, viljušaka i kašika; vrčevi; čajnici; servisi za čaj [posuđe]; četke za toalet; neseseri sa toaletnim priborom; držači toalet papira; toaletne potrepštine; četkice za zube; držači za peškire u vidu šipki i prstenova; poslužavnici za domaćinstvo; potrepštine za domaćinstvo; vaze; činije za povrće; korita za pranje rublja; korpe za bacanje papira; uređaji za zalivanje; hladionici za vino; bokali za vino; čaše za vino; prozorske kutije za cvijeće; umjetnička djela od porcelana, keramike, pečene gline ili stakla; tegle; krčazi; boce; vaze; posude za biljke; ukrasne ploče; rukavice za vađenje hrane iz pećnice; komplet posuda; limene kutije za kolače; limovi za pečenje u domaćinstvu; kontejneri za odlaganje hrane; spremnici za hranu; tegle ze držanje hrane; tacne za domaćinstva; poslužavnici za hranu; porcelansko posuđe; ukrasni predmeti od porcelana; kafetijere; kante za otpatke sa pedalom; kante za rublje; korpe za rublje; artikli za kupatila; artikli za tuševе; krpe za prašinu, krpe za brisanje i jelenska koža, sve za čišćenje; kofe; strugači leda; čelična vuna, nemetalni pribor i posuđe, uključujući boce za vodu; neelektrične džezvem pribor za nošenje vode za kampovanje i izlete i metalne tacne za izlete; krpe i podmetače od staklenog vlakna za upotrebu prilikom popravki motora vozila i slično; držači čaša; dozatori i aparati za doziranje; deodorišući aparati; djelovi i pribor za sve neprijed pomenute robe.

Klasa 24: Tekstili i zamjene za tekstile; prekrivači za krevete; stolnjaci; posteljina; tekstili za kupatilo, izuzev odjeće; rukavice za tuširanje i kupanje; ćebad za krevete; posteljino rublje; posteljina; platno; podmetači [stono platno]; navlake za jastuke; prekrivači za namještaj [nepričvršćeni]; držači zavjesa od tekstila; zavjese od tekstila ili plastike; platno (tkanine); tkanine za tekstilnu upotrebu; peškiri za lice od tekstila; flanel [tkanina]; maramice od tekstila; rublje za domaćinstvo; pokrivači za dušeke; mrežaste zavjese; nepredena tekstilna platna; jastučnice; otirači koji nijesu od papira; zavjese za tuš od tekstila ili plastike; postava za vreće za spavanje; stolnjaci koji nijesu od papira; stono platno koje nije od papira; podmetači za sto koji nijesu od papira; stone salvete od tekstila; dugački uski stolnjaci; tekstilni materijal; peškiri od tekstila; prekrivači za putovanja [za preko krila]; ćebenca; kuhinjske krpe; peškiri za kupanje; peškiri za plažu; tapiserije zidne od tekstila; ćebad za kućne ljubimce; tkanina za zastave i ukrasne zastavice; platna za tapete ili vezenje; gaza; ubrusi od tkanine za uklanjanje šminke; pelene za bebe; platno za pelene; maramice od tekstila; mreže protiv komaraca.

Klasa 25: Odjeća, obuća, pokrivala za glavu; kecelje [odjeća]; bandane [marame za oko vrata]; bademantili; pojasevi [odjeća]; portikle, ne od papira; čizme; vrhovi kapa; kape [pokrivala za glavu]; kaputi; sobni ogrtači; haljine; štitnici za uši [odjeća]; rukavice [odjeća]; šeširi; vrpce za glavu [odjeća]; kabanice [odjeća]; čarape; jakne [odjeća]; dresovi [odjeća]; pletenina [odjeća]; dokoljenice [grijači nogu]; helanke [pantalone]; kostimi za maskenbal; pojasevi za nošenje novca [odjeća]; mufovi [odjeća]; spoljna odjeća; radni kombinezoni; ogrtači, kaputi; pidžame; papirna odjeća; papirni šeširi [odjeća]; gotova, konfekcijska odjeća; sandale; ešarpe za nošenje; marame, šalovi; šalovi; košulje; cipele; košulje kratkih rukava; kape za tuširanje; suknje; maske za spavanje; odjeća za spavanje; negliže s gaćicama; sobne papuče; čarape; džemper; majice; pantalone; donji veš; uniforme; prsluci; viziri [pokrivala za glavu]; vodootporna odjeća; pelene za bebe od tekstila; kostimi za maskenbal; pojasevi za novac; kamašne / dokoljenice; podvezice za čarape; kramponi za kopačke; naramenice za odjeću; vrhovi obuće; djelovi i pribor za sve naprijed pomenute robe.

Klasa 26: Čipka i vez, trake i gajtani; dugmad, kukice i očice, špenadle i igle; vještačko cvijeće; prekrivači za čajnike; galanterija izuzev konaca; drikeri i kopče za gornje djelove odjeće; kopče za odjeću; elastične trake za držanje rukava; vještačke brade; vještačka kosa; vještački brkovi; šnale, ukosnice; kape za farbanje kose; uvijači kose, vikleri, koji nijesu ručni ne-električni pribor; papiri za uvijanje kose; igle za kovrdžanje kose; produžeci kose; držači za kosu [pokretni]; mrežice za kosu; ukrasi za kosu; šnale za kosu; ukosnice; trake za kosu; zakrpe za popravku tekstilnih proizvoda koje se lijepe pomoću toplote; ljudska kosa; igle za pletenje; jastučići za igle; uzice i povoci za djecu; kutije za šivenje; naprsci za šivenje; kopče za cipele; rupice za pertle za cipele; elementi za kopčanje cipela; pertle za cipele; ukrasi za cipele; ukrasi za odjeću; pantalone za bicikliste; perike; patentni zatvarači; patentni zatvarači za torbe; patentni zatvarači; patentni zatvarači za torbe; djelovi i pribor za sve naprijed pomenute robe.

Klasa 27: Tepisi, ćilimi, otirači i prostirke, linoleum i drugi materijali za prekrivanje podova; zidne tapete [koje nijesu od tekstila]; prostirke za kupatila; tepih pločice; dekorativne zidne tapete koje nijesu od tekstila; otirači; podne obloge; otirači koji se ne klizaju; tekstilne tapete; podovi od vinila; tapete; podne pločice; zidne i plafonske obloge; prostirke; vještačka trava; djelovi i pribor za sve naprijed navedene robe.

Klasa 28: Igre i igračke; aparati za video igre; gimnastička i sportska oprema; ukrasi za božićnu jelku; elektronske ručne konzole za igrice; električne kompjuterske igrice, osim onih koje su podešene za korištenje sa televizijskim prijemnicima; električni i elektronski aparati za zabavu (automatski, koji se pokreću ubacivanjem metalnih novčića); video igrice, osim onih koje su podešene samo za korištenje sa televizijskim prijemnicima; kompjuterski aparati za igranje osim onih koji se pokreću ubacivanjem metalnih novčića ili su podešeni za korištenje sa televizijskim prijemnicima; igračke i igre za video izlazom; interaktivne kompjuterske igračke i igrice; samostalni uređaji za video igrice sa ugrađenim ekranom; kompjuterski aparati za igranje, elektronski aparati za igranje i aparati za video igrice koji nijesu obuhvaćeni drugim klasama; konzole za igranje; zaštitni filmovi prilagođeni za ekrane za nosive igrice; upravljači za konzole za igranje; konji za klackanje, fliperi; aparati za igranje flipera (igračke); muzičke igračke, igrice i predmeti za igranje; audio uređaj kao igračka; muzičke kutije kao igračke; muzički instrumenti kao igračke; gramofoni igračke i za kasetofoni; igračke na baterije; elektronske igračke; elektronski pokretane igračke; kompjuteri igračke (koji ne rade); mobilni telefoni igračke (koji ne rade); lutke; neobične maske za lice (igračka); drangulije u obliku suvenira; staklene sniježne kugle; akcione figurice i dodaci za akcione figurice; odjeća i dodaci za lutke koji nijesu obuhvaćeni drugim klasama, a sve za lutke; hokej igrice; kamioni igračke; vozila na elektronski pogon, štitnici za vožnju bicikla, vozila igračke u kojima se može voziti, makete vozila, vozova i aviona, modeli vozova, kompleti za izradu modela vozila, igračke na naduvavanje, odjeća za lutke i druge igračke i lutke, vozila igračke; sezonski i praznični ukrasi; baloni; društvene igre; slagalice; plišane igračke, kasice prasice, kompleti za modelovanje; lopte; leteći tanjiri, društvene igre, modeli liveni u kalupu, građevinske kocke za igranje za, kutije za igračke, tiketi za loto, leteći tanjiri, slagalice, igračke psi; igračke mačke; dronovi [igračke], igračke, upravljači za igračke; društvene igre za stolom; igranje karata; loptice za igre, bilijarski stolovi, bilijarske loptice, bilijarski štapovi i ostala oprema za bilijar, loptice za golf, držači golf loptica, oznake za golf loptice, uređaj za izbacivanje loptica; bilijarski stolovi i štapovi, stalci za bilijarske štapove i loptice; sprave za bodi bilding; sprave za rehabilitaciju tijela; sprave

za vježbanje; sprave za jačanje grudnih mišića [sprave za vježbanje]; pojasevi za dizanje tegova [sportski artikli]; pojasevi za dizanje tegova i druga sportska i gimnastička oprema; streličarski pribor; gimnastički i sportski artikli koji nijesu obuhvaćeni drugim klasama; skejbordovi; tobogani i sanke; bob sanke, pikado strelice, meta za pikado; igre lovačkih vabilica, bazeni [artikli za igranje]; plastične piste; bejzbol rukavice; sličuge; praskave božićne bombone; štapovi i pribor za pecanje; čigre; paravani za kamuflažu [sportski artikli]; grebalice za lutriju; traka za upijanje znoja za palicu ili reket; kompjuterski i video uređaji za igranje igrice, osim onih koji se pokreću ubacivanjem kovanog novčića ili onih koji su prilagođeni za korištenje sa televizijskim prijemnicima.

Klasa 30: Kafa, čaj, kako i zamjena za kafu; riža; tapioka, sago (skrob iz sjemena palme sago), brašno i pripravci od žitarica; hljeb, kolači i konditorski proizvodi; sladoledi; šećer, med, melasa; kvasac, prašak za pečenje; so; senf; sirće, sosovi (začinski dodaci); začini; led; mirođije; slatkiši od badema; pasta od badema; anisovo sjeme; aromatični preparati za prehrambene proizvode; zamjena za kafu; prašak za pecivo; soda bikarbona; ječmeno brašno; brašno od boba; propolis; pivsko sirće; vezivni agensi za sladoled; hljeb; kifle; prezla; zemičke; glazure za kolače; prah za kolače (prašak za pecivo); bonbone; kapar; pločice od žitarica; grickalice od žitarica; proizvodi od žitarica; burgeri od sira [sendviči]; žvakaće gume; čips [proizvodi od žitarica]; čokoladni napici; čokoladni musevi; kakao; napici od kakaoa; kafa; napici od kafe; začinski dodaci; keksi; so za kuvanje; kukuruzne pahuljice (konrflejks); kukuruzno brašno; kuskus [griz, krupica]; krekeri; krem od vanile; dezertni musevi [konditorski proizvodi]; tijesto; prelive za salate; arome za slatkiše, osim esencijalnih ulja; zamrznuti jogurti [ledeni konditorski proizvodi]; baštenske trave, konzervirane [začinske]; đumbir [začin]; kolačići od đumbira; glukoza za upotrebu u kulinarstvu; aditivi sa glutenom za upotrebu u kulinarstvu; gluten spremljen kao hrana; šećerni sirup; glazura za šunke; visokoproteinske pločice od žitarica; med; sladoled; led za hlađenje napitaka; prirodni ili vještački led; ledeni čaj; infuzije (nemedicinske); kečap [paradajz sos]; pastile [konditorski proizvodi]; marcipan; majonez; sokovi od mesa; pite od mesa; musli; prirodni zaslađivači; obroci spremljeni sa rezancima; rezanci; oraščić; proizvodi od ovsa; ovsene pahuljice; ovsena kaša; palmin šećer; palačinke; pašta; sos za paštu; tjestenina; peciva; poslastice od kikirikija; biber; slatkiši sa mentom; biberi [začini]; pesto [sos]; pite; pice; kokice; praline; pudinzi; kiševi; ravioli; začinski umak [začinski dodatak]; rižini kolači; matični mliječ; dvopek; sago; sendviči; sosevi [začinski dodaci]; začini; griz, krupica; sorbeti [ledeni]; soja sos; špegete; proljećnje rolnice; šećer; suši; takosi; tapioka; tartevi; čaj; napici sa čajem; sredstva za zgušnjavanje za kuvanje hrane; sos od paradajza; tortilje; kurkuma za hranu; nepržena kafa; sirće; vafli; pšenično brašno; pšenične klice za ljudsku ishranu; germa; konditorski proizvodi; nemedicinski konditorski proizvodi; smrznuti konditorski proizvodi; konditorski proizvodi od šećera; čokolada; čokoladni konditorski proizvodi; konditorski proizvodi u zamrznutom stanju; konditorske pločice; pastile; slatke tablete; slatkiši; sladoledi na štapiću; čokolade; keksi; torte; slatka peciva; napolitanke; grickalice od riže; grickalice od pšenice; grickalice od rezanaca; sladoled i proizvodi od sladoleda, rashlađeni i zamrznuti konditorski proizvodi i dezerti; hladni čaj.

Klasa 32: Piva; mineralne i gazirane vode i druga bezalkoholna pića; voćni napici i voćni sokovi; sirupi i drugi proizvodi za pravljenje napitaka; englesko pivo; pivo; plzensko pivo; tarnno pivo; radler (miješano piće od piva i gaziranog bezalkoholnog pića); crno pivo; kvas; pivo sa niskim procentom alkohola; bezalkoholno jabukovo vino; bezalkoholna vina; bezalkoholni aperitivi; napici koji sadrže vitamine; napici obogaćeni vitaminima; pića od surutke; bezalkoholni kokteli; energetska pića; energetska pića koja sadrže kofein;

aromatizirana gazirana pića; voćni sokovi; pića od guarane; napici na bazi meda; izotonični napici; izotonična pića; hipertonična i hipotonična pića (za upotrebu od strane ili po potrebi sportista); sportska pića; bezalkoholna pića bez slada; biljno mlijeko; stona voda; sok od paradajza [napitak]; sokovi od povrća; vode; šumeće tablete (šerbetne) i šumeći prah za pića; frapei (bezalkoholni voćni napici); slakovina; pivo od slada; kokteli sa pivom; pivo od đumbira; ekstrakti hmelja za proizvodnju piva.

Klasa 33: Alkoholna pića (osim piva); alkoholna pića sa sadržajem voća; alkoholne esencije; alkoholni ekstrakti; aperitivi; gorka pića; konjak; cachaca (vrsta brazilskog alkoholnog pića); kalvados; krem likeri; pivo od jabuke; kokteli; kurakao; digestivi [likeri i alkoholna pića]; destilisana pića; alkoholni voćni ekstrakti; džin; rakija; medovina; trešnjevača; likeri; nira [alkoholno piće na bazi šećerne trske]; likeri od metvice; kruškovača; vina od komine; unaprijed pomiješana alkoholna pića (koja u sebi nemaju pivo); rižin alkohol; rum; sake; žestoka alkoholna pića; tekila; votka; viski; vino; alkoholna energetska pića; alkoholni punčevi; miješani viski; burbon viski; kalvados; gazirana alkoholna pića; destilovani napici i žestoka pića; aromatični žestoka alkoholna pića; rakija; likeri koji sadrže krem; pića sa niskim procentom alkohola; vino sa niskim procentom alkohola; viski od slada; kuvana vina; porto; vino iz Porta; rum punč; sangria, šneps; šeri; pjenušava vina; tekila; vermut.

Klasa 34: Duvan; pribor za pušače; šibice; držači za šibice; lule za duvan; lule za duvan (upijajući papir za -); čistači za lule; kese za duvan; cigarete; cigarete koje sadrže zamjene duvana, koji nijesu za medicinsku upotrebu; cigaret papir; filteri za cigarete; cigare; tabakere; sjekači za cigare; cigarilosi; trave za pušenje; pepeljare za pušače; elektronske cigarete; elektronske cigare; raspršivači elektronskih cigareta; kartomizeri elektronskih cigareta; čistači elektronskih cigareta; elektronske lule; elektronske nargile; arome, koje nijesu esencijalna ulja, za korištenje u elektronskim cigaretama; tečni nikotinski rastvori za korištenje u električnim cigaretama; ovlaživači (tabakera); upaljači za pušače; burmut; burmutice.

Klasa 35: Reklamiranje; poslovni menadžment; poslovna administracija; kancelarijski poslovi; oglašavanje putem pošte; vođenje poslova oglašavanja; reklamne usluge, naime, promovisanje roba i usluga trećih lica; usluge oglašavanja po kategorijama; prezentacija roba; razvijanje reklamnih artikala; distribucija uzoraka; oglašavanje direktnom poštom; distribucija reklamnog sadržaja; distribucija reklama za treća lica putem elektronske komunikacione mreže; usluge preloma za reklamne svrhe; usluge modela za reklamne svrhe ili prodajne promocije; iznajmljivanje reklamnog prostora; oglašavanje putem interneta na računarskim mrežama; oglašavanje na internetu i globalnim računarski mrežnim sistemima; organizacija izložbi za komercijalne ili reklamne svrhe; organizacija sajмова za komercijalne ili reklamne svrhe; oglašavanje na otvorenom; promovisanje roba i usluga trećih lica putem ograničene dostupnosti; ponude nižih cijena putem onlajn elektronske komunikacione mreže; obezbjeđivanje onlajn reklamnog vodiča koji se može pretraživati a koji sadrži robe i usluge trećih lica; reklamiranje na radiju; iznajmljivanje reklamnih termina na komunikacionim medijima; maloprodajne usluge oglašavanja, naime, distribucija reklamnih materijala za treće strane putem elektronske komunikacione mreže; ažuriranje reklamnog materijala; televizijsko reklamiranje; analiza tržišta; istraživanje tržišta; usluge istraživanja tržišta i informisanja; ispitivanje javnog mnjenja; odnosi sa javnošću; usuge odnosa sa javnošću; objavljivanje reklamnih tekstova; reklamne agencije; transkribovanje; reklamni tekstovi (pisanje -); iznajmljivanje reklamnog materijala; agencije za zapošljavanje; zapošljavanje osoblja; psihološki testovi u vezi sa izborom osoblja; konsultantske usluge u vezi sa

zapošljavanjem osoblja; promovisanje korištenja energije sa farmi vjetroturbina; promovisanje korištenja energije iz solarnih farmi; računovodstvo; administrativna obrada narudžbenica; pomoć kod nabavke roba i usluga za treća lica; pomoć u kupovini roba i usluga za treća lica; usluge revizije; knjigovodstvo; poslovna pomoć za umjetnike i izvođače; procjene poslovanja; usluge pružanja poslovnih informacija; ispitivanje poslovanja; poslovno istraživanje; usluge pomoći u upravljanju poslovanjem; konsultantske usluge u poslovnom upravljanju; konsultantske usluge u organizaciji poslovanja; komercijalno upravljanje licenciranjem rob i usluga trećih lica; usluge agencija za pružanje komercijalnih informacija; pomoć u komercijalnom upravljanju; prikupljanje analiza troškova; kopiranje dokumenata; analiza troškova; umnožavanje dokumenata; sastavljanje izvoda sa računa; ekonomska predviđanja; usluge stručnjaka za efikasnost; pomoć u industrijskom upravljanju; usluge fakturisanja; fotokopiranje; izrada platnih spiskova; izrada poreskih prijavi; usluge poslovnog konsultovanja; obezbjeđivanje internetskog imenika komercijalnih informacija; usluge promjena poslovnog sjedišta; iznajmljivanje aparata za kopiranje; iznajmljivanje automata za prodaju; istraživanja za sponzorstva; sekretarske usluge; stenografske usluge; telefonski odgovori za nedostupne pretplatnike; transkribovanje; daktilografske usluge; obrada teksta; prikupljanje i sistematizacija podataka u računarske baze podataka; prikupljanje poslovnih informacija u bazu podataka dostupnu preko globalne računarske mreže, koja se može pretraživati; prikupljanje računarskih baza podataka za prenošenje, prikazivanje i smještanje transakcionih, identifikacionih i finansijskih informacija; prikupljanje informacija u računarske baze podataka; prikupljanje statističkih podataka; kompjuterizovano upravljanje podacima; usluge kompjuterizovanog upravljanja bazama podataka; kompjuterizovana obrada narudžbenica dobijenih putem interneta; usluge upravljanja bazama podataka; obezbjeđivanje internetskog imenika komercijalnih informacija; pružanje poslovnih informacija putem baze podataka koja se može pretraživati i putem globalne računarske mreže; pretraživanje podataka u računarskoj bazi podataka, za treća lica; pretraživanje podataka u računarskim datotekama, za treća lica; sortiranje i uređivanje informacije u računarskim bazama podataka; upravljanje programom popusta koji omogućava učesnicima da dobiju popuste za usluge dostave putem korišćenja programa za članove i programa varijabilne cijene dostave; usluge pretplate na novine (za treća lica); usluge pretplate na telekomunikacione usluge, za treća lica; usluge pretplate za medije, za treća lica; internetska prodaja muzike na malo u digitalnom obliku ili pohranjene na medijima; kompjuterizovano internetsko naručivanje usluga za treća lica osnovnih roba ili roba široke potrošnje; usluge programa lojalnosti kupaca koji obezbijavaju nagrade u vidu jeftinijih usluga otpreme; usluge baza podataka kako bi treća lica mogla da jednostavno pregledaju i biraju usluge sa internetske stranice; distribucija reklama za treća lica putem interneta; promovisanje roba i usluga trećih lica nuđenjem nižih cijena ograničenom broju kupaca putem interneta; prikupljanje jednog broja pružaoca usluga da bi treća lica mogla da jednostavno pregledaju i biraju usluge sa internetskih strana; usluge aukcija; aukcija; usluge aukcionarstva; usluge poslovnog posredovanja za prodaju i kupovinu roba i usluga; usluge upoređivanja (cijena -); kompjuterizovano naručivanje usluga preko interneta za osnovne robe i robe široke potrošnje; agencije koje se bave uvozom i izvozom; usluge pružanja informacija, naime, pružanja informacija kupcima o proizvodima iz maloprodaja, uz mogućnost obezbjeđivanja proizvoda koji ih konkretno interesuju; usluge informisanja, savjetovanja i konsultovanja u vezi sa svim naprijed pomenutim.

Klasa 41: Obrazovanje; pružanje obuka; zabava; sportske i kulturne aktivnosti; obezbjeđivanje muzike putem interneta koja se ne može preuzimati; obezbjeđivanje audio

sadržaja putem interneta koji se ne može preuzimati, uključujući muziku, radio programe u emotivanju, audio knjige, podcast i vebkast sadržaje; zabava, naime, obezbjeđivanje audio i multimedijalnog sadržaja, igrice, softverskih aplikacija; pružanje informacija, novosti i komentara iz oblasti zabave, popularne kulture, rekreacije i slobodnih aktivnosti, sporta i sportskih događaja, edukativnih usluga, koncerata, kulturnih događaja i pozorišnih predstava uživo; pružanje informacija u vezi sa organizovanjem edukativnih, kulturnih, sportskih i zabavnih izložbi i zajedničkih, sportskih i kulturnih aktivnosti, takmičenja i igara; obezbjeđivanje audio publikacija putem računarskih mreža, koje se ne mogu preuzimati, naime, periodičnih publikacija i izvjestaja na temu obrazovanja, zabave, popularne kulture, rekreacije i slobodnih aktivnosti, sporta i sportskih aktivnosti, tehnologije, koncerata, kulturnih aktivnosti i pozorišnih predstava uživo; pružanje informacija iz oblasti obrazovanja i zabavnih aktivnosti i događaja za djecu; organizovanje časova, radionica i podučavanja korištenjem softverskih aplikacija koje se pokreću glasom; iznajmljivanje biblioteka; obazbjeđivanje elektronskih publikacije putem interneta, koje se ne mogu preuzimati; distribucija video traka; obezbjeđivanje usluga igara virtualne stvarnosti putem interneta na računarskoj mreži; vođenje fitnes časova; iznajmljivanje igraćaka; iznajmljivanje opreme za igranje; dresiranje životinja; umjetnici modeliranja; organizovanje igara na sreću; usluge obrazovanja, podučavanja i obuka na računaru; obezbjeđivanje igrice na računaru; usluge elektronskog izdavaštva; obezbjeđivanje elektronskih knjiga, časopisa, novina, žurnala, periodičnih izdanja i drugih publikacija; obazbjeđivanje onlajn tekstualnih, video, audio i multimedijalnih programa; usluge rezervacije karata i rezervisanja za zabavne, sportske i kulturne događaje; pružanje informacije, savjeta, novosti, kritika i komentara iz oblasti zabavnih, sportskih i kulturnih događaja; organizovanje i vođenje komercijalnih, trgovinskih i poslovnih konferencija; rezervacija sjedišta za zabavne programe; informacije iz obrazovanja; informacije iz oblasti zabave; informacije (o rekreacijama -); iznajmljivanje audio opreme; usluge obuke putem simulatora; usluge savjetovanja i konsultovanja u vezi sa svim naprijed pomenutim.

Klasa 42: Arhitektura; usluge projektovanja, gradnje i arhitektonske usluge; konsultantske usluge u vezi sa arhitekturom, projektovanjem i gradnjom; usluge arhitektonskog planiranja i konsultovanja; arhitektonske usluge za interijer; arhitektonske usluge za projektovanje zgrada, industrijskih objekata i komercijalnih zgrada; konsultovanje u vezi sa električnim i elektronskim aparatima i opremom i audivizuelnim robama; usluge projektovanja; usluge tehničkog projektovanja; tehničko istraživanje; osmišljavanje proizvoda; grafički dizajn; dizajniranje ambalaže; dizajniranje nakita; dizajniranje hardvera; dizajniranje namještaja; konsultacije o projektu; projektovanje kuća; građevinsko projektovanje; dizajn automobila; modni dizajn; projektovanje i izrada računarskog hardvera, sofvera, spoljašnjih jedinica i kompjuterskih i video igrice; usluge konsultovanja o računarskom hardveru i softveru; računarsko programiranje; projektovanje računarskih baza podataka; smještaj elektronskih podataka; usluge računarstva u klauđu; iznajmljivanje računarskog hardvera, softvera i spoljašnjih jedinica; obezbjeđivanje onlajn softvera koji se ne može preuzimati; konsultantske usluge za razvijanje računarskih sistema, baza podataka i aplikacija; konsultacije u vezi sa bezbjednosti računara i podataka; usluge kodiranja podataka; obezbjeđivanje informacija putem interneta o računarskom hardveru ili softveru; održavanje, popravka i ažuriranje računarskog hardvera, softvera, spoljašnjih jedinica i aplikacija; usluge tehničke podrške, dijagnostifikovanje i otklanjanje problema kod računarskog hardvera i softvera i usluge tehničke podrške korisnicima računara; usluge kreiranje, dizajniranje i održavanja internetskih stranica; usluge hostovanje internetskih stranica; obezbjeđivanje pretraživača

za potrebe dobijanja podataka putem interneta i drugih elektronskih komunikacionih mreža; kreiranje indeksa onlajn informacija, stranica i drugih resursa dostupnih na internetu i drugim elektronskim komunikacionim mrežama; usluge kartografije i izrade mapa; obezbjeđivanje internetskog portala koji omogućava korisnicima pregled i preuzimanje elektronskih knjiga, publikacija i drugih dokumenata; naučne i tehnološke usluge; usluge industrijskog dizajna; usluge industrijske analize i istraživanja; usluge pružanja informacija, savjeta i konsultacija u vezi sa svim naprijed pomenutim; kontrola kvaliteta; anketiranje; hemijsko istraživanje; kliničko ispitivanje; meteorološke informacije; testiranje materijala; unutrašnji dizajna; dizajniranje haljina; utvrđivanje autentičnosti umjetničkih djela; grafičko umjetničko dizajniranje; slanje podataka (rasijavanje oblaka) pomoću tehnologije oblaka; analiziranje rukopisa [grafologija]; procjena nematerijalne imovine.

(111) **14936**

(151) 27.10.2020.

(210) Ž-2019-80

(220) 07.03.2019.

(732) Carlsberg Srbija d.o.o., Proleterska 17, 21413, Čelarevo, RS

(540)



(550) I

(740) AOD MSA IP - Milojević Sekulić Advokati, Karađorđeva 65, 11000, Beograd

(511) Klasa 32: Pivo.

(111) **14939**

(151) 27.10.2020.

(210) Ž-2019-380

(220) 04.10.2019.

(732) PepsiCo, Inc., 700 Anderson Hill Road, NY 10577, Purchase, US
(540)

Papir, Kamen, Makaze

(550) I

(740) Jasna Jusić, Dalmatinska 2, 81000, Podgorica

(511) Klasa 29: Meso; riba; živina; divljač; mesne prerađevine; konzervisano, sušeno i kuvano voće i povrće; želei; džemovi; kompoti; jaja; mlijeko; mliječni proizvodi; jestiva ulja i masti; umaci; sir; jogurt; jestive sjemenke; prerađeni orašasti plodovi; obrađena jestiva sjemena; hranljive pločice na bazi orašastih plodova; mješavine voća i orašastih plodova; čips od krompira; listići od krompira; grickalice na bazi krompira; grickalice na bazi soje; čips od soje; grickalice na bazi voća; čips od voća; juka čips; govedina kao gotova hrana; sušena govedina; ekstrudirana svinjska koža; salate od povrća; namazi od voća i povrća; grickalice i čips na bazi povrća, gotova hrana za grickanje koja se primarno sastoji od krompira i čipsa, orašastih plodova, orašastih proizvoda, sjemenki, voća, povrća ili njihovih kombinacija; grickalice i namazi na bazi mahunarki.

Klasa 30: Kafa, čaj, kakao; zamjena za kafu; šećer; pirinač, tapioka; sago; brašno; proizvodi od žitarica; hleb, kolači; poslastice; sladoledi; med; melasa; kvasac, prašak za pecivo; so; senf; sirće, sosovi (kao dodaci); začini; žitarice; prerađena zrna žitarica; prehrambeni proizvodi za grickanje od brašna cijelog zrna žitarica; prehrambeni proizvodi za grickanje od krompirovog brašna; prehrambeni proizvodi za grickanje od pirinčanog brašna; krekeri; takos čips; tortilja čips; čips na bazi brašna; čips na bazi zrna žitarica; prehrambeni proizvodi za grickanje na bazi zrna žitarica; pločice na bazi žitarica; pločice od žitarica i energetske pločice; prehrambeni proizvodi za grickanje na bazi pirinča; čips od pirinča; listići od pirinča; krekeri od pirinča; ekstrudirani pirinač; kolači od pirinča; prehrambeni proizvodi za grickanje od kukuruza; prerađeni kukuruz; kokice; pečeni kukuruz; grickalice od ekstrudiranog kukuruza; grickalice na bazi kukuruza; ekstrudirane grickalice koje sadrže kukuruz; papadum; perece; granola; pločice na bazi granole; obrađena sjemena žitarica; pločice koje sadrže mješavinu zrna žitarica, orašastih plodova i sušenog voća (poslastice); umaci; sosevi; karamelizovani orasi (poslastice); grickalice na bazi granole; gotova hrana za grickanje koja se primarno sastoji od zrna žitarica, kukuruza, cijelog zrna žitarica ili njihovih kombinacija.

(111) **14940**

(151) 27.10.2020.

(210) Ž-2019-382

(220) 07.10.2019.

(300) CH 047582019 od 05.04.2019. godine za klase 07 i 11

(732) Intuit Inc., 2535 Garcia Avenue, CA 94043, Mountain View, US

(540)

INTUIT

(550) I

(740) Jasna Jusić, Dalmatinska 2, 81000, Podgorica

(511) Klasa 7: Mašine, mašinski alati, alati na pogon; motori i pogonske mašine, osim za kopnena vozila; mašinske spojnice i transmisioni elementi, osim za kopnena vozila; poljoprivredne sprave, osim alata kojima se upravlja ručno; inkubatori za jaja; automati za prodaju; industrijski roboti; trodimenzionalni (3D) štampači; olovke za 3D štampanje; električni i mehanički upisivači (imprinteri) platnih kartica; električni i mehanički upisivači (imprinteri) kreditnih kartica; generatori električne energije na solarni pogon; prenosni električni generatori; električni i mehanički uređaji za cijedenje voćnih sokova; električne i mehaničke prese za voće i povrće; električni i mehanički blenderi za hranu; električne i mehaničke mašine za mljevenje hrane; usisivači; usisivači koji mogu sakupljati i suhu prljavštinu i tečnost; bežični usisivači; filteri za prašinu i vreće za usisavače; nastavci za usisivač za širenje parfema i dezinfekcijskih sredstava; mašine za čišćenje tepiha; bežični čistači; mlinovi za so i papar, osim ručnih; mašine za pranje posuđa, uključujući mašine za pranje posuđa koje stoje na radnim površinama; mašine za pranje boca; mašine za pranje odjeće; mašine za čišćenje na paru; centrifuglane mašine za sušenje koje ne griju; mašine za hemijsko čišćenje, uključujući mašine za hemijsko čišćenje koje stoje na radnim površinama; mašine za pravljenje sode i mineralne vode; električne i mehaničke mašine za pripremu hrane; mašine za pranje voća; sredstva za čišćenje i usisavanje bazena; mehanički mlinovi za kafu; električni rezači za pice; mehanički alati za travnjake i dvorište; mehaničke kosilice za travu i korov; čistači za snijeg; električni kuhinjski mikseri; električne makaze; električni noževi; električni otvarači za konzerve; električni vakuumski zaptivači za hranu; električne drobilice za led; električne hranilice za divljač, životinje i kućne ljubimce; električni sistem za otvaranje i zatvaranje vrata; električni motori za kapije; električne jedinice za ultrazvučno čišćenje; mašine za plivanje u kontra struji vodenog toka.

Klasa 9: Aparati i instrumenti, naučni, nautički, geodetski, fotografski, kinematografski i optički, kao i aparati i instrumenti za vaganje, mjerenje, signalizaciju, kontrolu (inspekciju), spasavanje i nastavu; aparati i instrumenti za vođenje, prebacivanje, transformisanje, akumuliranje, podešavanje ili kontrolisanje električne struje; aparati za snimanje, prenos, reprodukciju zvuka ili slika; magnetni nosači podataka, diskovi za snimanje; kompakt diskovi, DVD-i i druga digitalna sredstva za snimanje; mehanizmi za aparate koji se pokreću kovanicama; registar kase, računске mašine, oprema za obradu podataka, računari; aparati za gašenje požara; računarski hardver; računarski softver; računarski aplikativni softver za mobilne uređaje; računarski softver za upotrebu u računovodstvu, knjigovodstvu, obradi transakcija, upravljanju transakcijama, pripremi i planiranju poreza, prijavi poreza, upravljanju porezom, upravljanjem poslovnim procesima i finansijskom planiranju; računarski softver za upotrebu u upravljanju profesionalnom poreskom praksom; računarski softver za upravljanje bazama podataka, objedinjavanje podataka, izvještavanje i prenos podataka; računarski softver za sigurnosno kopiranje elektroničkih datoteka na mreži; alati i šabloni za razvoj softvera; računarski softver za upotrebu u distribuciji, instaliranju i ažuriranju drugih aplikacija; računarski softver za saradnju i dijeljenje podataka sa drugima; računarski softver za sinhronizaciju podataka između

računara i mobilnih uređaja; računarski softver koji se koristi za elektroničku razmjenu računovodstvenih, finansijskih, korisničkih podataka, podataka o kontaktima, podataka o proizvodima i poslovnih podataka; računarski softver za upravljanje zalihama, upravljanje troškovima projekata, procjenama, troškovima poslovanja, praćenje vremena zaposlenih, upravljanje poslovnim operacijama i upravljanje projektima; računarski softver i računarski hardver za upotrebu u transakcijama na prodajnom mjestu, obradi transakcija, upravljanje štampanim računima i maloprodajnim operacijama; računarski softver za kreiranje, prilagođavanje i upravljanje fakturama, evidentiranje plaćanja i izdavanje računa; računarski softver za upotrebu u organizovanju, servisiranju i praćenju podataka o prodaji, naplatama i potraživanjima; računarski softver za praćenje prihoda, troškova, prodaje i profitabilnosti prema lokaciji preduzeća, odsjeka, vrsti poslovanja ili drugom korisničkom polju; računarski softver za računanje i naplatu poreza na promet i kreiranje izvještaja o plaćanju poreza na promet odgovarajućim poreskim agencijama; računarski softver za fakturisanje i plaćanje kreditnim karticama; računarski softver za onlajn bankarstvo; računarski softver za kontrolu pristupa finansijskim informacijama putem postavki elektroničkih dozvola; računarski softver za kreiranje, prilagođavanje, štampanje, izvoz i kupovinu putem e-pošte; računarski softver za praćenje vremena koliko rade zaposleni i podugovorena lica; računarski softver za kreiranje i upravljanje budžetima; računarski softver za kreiranje procjena cijena i prenošenje procjena cijena na račune; računarski softver za automatizaciju kreiranja računa; računarski softver za kreiranje, prilagođavanje, štampanje, izvoz i slanje finansijskih izvještaja e-poštom, poslovnih izvještaja, bilansa stanja, izvještaja o dobitima i gubicima, izvještaja o gotovinskom toku i oporezivih izvještaja o prodaji; računarski softver za kreiranje, štampanje i praćenje čekova i naloga za kupovinu; računarski softver za praćenje prodaje, troškova i plaćanja; računarski softver za analizu finansijskog stanja preduzeća i industrija; računarski softver za upravljanje spiskovima kupaca, podajom putem obrazaca e-poštom i štampano, i praćenjem stanja; računarski softver za unos kontakata i finansijskih podataka iz drugih elektronskih servisa i softvera; računarski softver za transakcije na prodajnom mjestu i upravljanje maloprodajom; računarski softver za upotrebu u administraciji i upravljanju platnim spiskovima, planovima naknada, planovima osiguranja, penzijskim planovima, planovima osiguranja za slučaj nezaposlenosti i unaprijed plaćenim planovima zdravstvene zaštite; računarski softver za upravljanje podacima o zdravstvenoj zaštiti, podacima o receptu, medicinskoj istoriji, medicinskim računima, evidenciji pacijenata i drugim medicinskim podacima; računarski softver za upravljanje medicinskim osiguranjem, medicinskim plaćanjima, troškovima i naplatama; softver za upravljanje odnosima sa klijentima (CRM); softver za planiranje resursa preduzeća (ERP); softver za upravljanje poslovanjem za potrebe upravljanja nekretninama i imovinom, upravljanja uslugama i opravkama automobila, izgradnje i upravljanja zgrada, upravljanja zdravstvenom praksom, upravljanja advokatskim firmama, upravljanja neprofitnim organizacijama i javnim sektorom, upravljanja maloprodajnih objekata i restorana, kao i upravljanja putničkih usluga; računarska periferna oprema; ladice za gotovinu; računarski štampači; računarski štampači i terminali na prodajnom mjestu; čitači i skeneri kreditnih i debitnih kartica; čitači i skeneri bar kodova; POS terminali za kreditne kartice i terminali za obradu transakcija na kreditnoj kartici.

Klasa 11: Rasvjetni uređaji, uređaji za grijanje, kuvanje, hlađenje, sušenje, ventilaciju, uređaji za vodosnabdijevanje i sanitarne svrhe; lampe; LED svjetla; učvršćivači za rasvjetu, uključujući učvršćivače za rasvjetne uređaje na solarnu energiju; baterijske džepne lampe; svjetiljke u obliku olovke; stona rasvjeta; baterijske džepne lampe sa laserskim usmjerivačem; svjetla za čitanje i svjetla za knjige; reflektori i svjetla za bicikla; prenosiva

pomoćna svjetla; prenosive čeone lampe; lampe za zglobove i čeone lampe za ličnu upotrebu; abažuri; električne i svijeće bez plamena; grijači; patio grijači; uređaji za grijanje prostora; džepni grijači; grijači stopala; grijači kreveta; stolovi sa vatrom i ognjišta; prijemnici solarne energije; mašine za sušenje odjeće; električni stalak za odjeću za sušenje; aparati za peglanje odjeće na paru; električni grijači pića; peći, uključujući i prenosive; mašine za kafu; aparati za hlađenje pića; aparati za kuvanje riže; uređaji za kuvanje pod pritiskom; električni uređaj za pečenje vafila; električni grilovi za sendviče; električni aparati za kuvanje jaja; mašine za pravljenje hljeba; električni aparati za pravljenje kafe; električne mašine za espresso kafu; grilovi (kućni aparati), električni grilovi, grilovi na gas; grilovi na ugalj; ražnjevi; električni vinski podrumi; termofoori; aparati za kade za hidromasažu; prenosivi i ručni tuševi; prenosive kade za stopala; dekorativne vodene fontane; navlake za spa po meri; toalet za kompostiranje; fenovi za kosu; aparati za sušenje ruku; električne mašine za toplo brijanje sa penom; električni šporeti; prenosivi šporeti za kampovanje; električne ringle i pekači; uređaji za spremanje hrane na paru; mikrotalasne pećnice; rerne za pečenje; pećnice za kuvanje; uređaji za vakumiranje; frižideri; prenosivi rashladni uređaji za potrebe potrošača; rashlane vitrine; minibarovi; električni aparati za sušenje suđa, uređaji za kontrolu okoline; kućni aparati za čišćenje vazduha i jonizatori; električni i aparati na pogon za raspršivanje vazduha za domaćinstvo; isušivači vazduha; klima uređaji i ventilatori; električni ventilatori za ličnu upotrebu; aparati za rashlađivanje vazduha; aparati i mašine za filtriranje i prečišćavanje vazduha; električne jedinice za dezodorisanje prostora; fotonaponski uređaji za proizvodnju energije; aparati za rashlađivanje na solarnu energiju; solarni termalni sistemi za grijanje vazduha; filteri za pijaću vodu; aparati za filtriranje i sterilizaciju vode.

Klasa 42: Naučne i tehnološke usluge i istraživanja i dizajn u vezi sa istim; industrijske analize i usluge industrijskog istraživanja; dizajn i razvoj računarskog hardvera i softvera; instaliranje, održavanje, unapređivanje ili iznajmljivanje računarskog softvera; pružanje privremenog korišćenja onlajn softvera koji se ne može preuzimati; elektronsko pohranjivanje podataka; hosting usluge i softver u vidu servisa; softver zasnovan na oblaku i softverske platforme zasnovane na oblaku; pružanje privremenog korišćenja onlajn softvera koji se ne može preuzimati za upotrebu u računovodstvu, knjigovodstvu, procesuiranju transakcija, upravljanju transakcijama, pripremi i planiranju poreza, prijavljivanju poreza, upravljanju poslovnim procesima, i finansijskom planiranju; pružanje privremenog korišćenja onlajn softvera koji se ne može preuzimati za upotrebu u upravljanju profesionalnom poreskom praksom; pružanje privremenog korišćenja onlajn softvera koji se ne može preuzimati za upravljanje bazama podataka, sakupljanje podataka, izvještavanje podataka, i prenos podataka; pružanje privremenog korišćenja onlajn softvera koji se ne može preuzimati za onlajn čuvanje elektronskih datoteka; alati i šabloni za razvoj softvera; pružanje privremenog korišćenja onlajn softvera koji se ne može preuzimati za korišćenje u distribuciji, instaliranju i unapređivanju drugih aplikacija; pružanje privremenog korišćenja onlajn softvera koji se ne može preuzimati za saradnju i dijeljenje podataka sa drugima; pružanje privremenog korišćenja onlajn softvera koji se ne može preuzimati za sinhronizaciju podataka između računara i mobilnih uređaja; pružanje privremenog korišćenja onlajn softvera koji se ne može preuzimati za elektronsku razmjenu računovodstvenih, finansijskih, potrošačkih, podataka o kontaktima, podataka o proizvodu i poslovnih podataka; računarski softver za upravljanje inventarom, upravljanje troškovima projekta, procjenjivanje, troškove poslovanja, praćenje vremena zaposlenih, upravljanje poslovnim operacijama i upravljanje projektima; pružanje privremenog korišćenja onlajn softvera koji se ne može preuzimati za korišćenje u transakcijama na mestu prodaje, obradi transakcija, štampanju računa i upravljanju procesima u maloprodaji; pružanje

privremenog korišćenja onlajn softvera koji se ne može preuzimati za kreiranje, prilagođavanje i upravljanje fakturama, bilježnje uplata, i izdavanje potvrda (računa); pružanje privremenog korišćenja onlajn softvera koji se ne može preuzimati za organizovanje, servisiranje i praćenje podataka o prodaji, podataka o naplatama i potraživanjima; pružanje privremenog korišćenja onlajn softvera koji se ne može preuzimati za praćenje primanja, troškova, prodaje, i profitabilnosti prema poslovnoj lokaciji, odjeljenju, vrsti posla, ili drugim korisničkim oblastima; pružanje privremenog korišćenja onlajn softvera koji se ne može preuzimati za računanje i naplatu poreza na promet i kreiranje izvještaja za plaćanje poreza na promet odgovarajućim poreskim agencijama; pružanje privremenog korišćenja onlajn softvera koji se ne može preuzimati za fakturisanje preko kreditnih kartica i procesuiranje plaćanja kreditnim karticama; pružanje privremenog korišćenja onlajn softvera koji se ne može preuzimati za onlajn bankarstvo; pružanje privremenog korišćenja onlajn softvera koji se ne može preuzimati za kontrolu pristupa finansijskim informacijama putem podešavanja elektronske dozvole; pružanje privremenog korišćenja onlajn softvera koji se ne može preuzimati za kreiranje, prilagođavanje, štampanje, izvoz i e-mail nabavku porudžbina; pružanje privremenog korišćenja onlajn softvera koji se ne može preuzimati za praćenje vremena rada zaposlenih i podugovarača; pružanje privremenog korišćenja onlajn softvera koji se ne može preuzimati za kreiranje i upravljanje budžetima; pružanje privremenog korišćenja onlajn softvera koji se ne može preuzimati za kreiranje procjene troškova i prenos procijenjenih troškova na račune; pružanje privremenog korišćenja onlajn softvera koji se ne može preuzimati za automatsko kreiranje računa; pružanje privremenog korišćenja onlajn softvera koji se ne može preuzimati za kreiranje, prilagođavanje, štampanje, izvoz i e-mail slanje finansijskih izvještaja, poslovnih izvještaja, bilansa, profita i gubitaka, izvještaja o novčanim tokovima, i izvještaja o oporezivom prometu; pružanje privremenog korišćenja onlajn softvera koji se ne može preuzimati za kreiranje, štampanje i praćenje čekova i nabavku porudžbenica; pružanje privremenog korišćenja onlajn softvera koji se ne može preuzimati za praćenje prodaje, troškova i uplata; računarski softver za analiziranje finansijskog statusa preduzeća i industrija; pružanje privremenog korišćenja onlajn softvera koji se ne može preuzimati za upravljanje potrošačkim listama, e-poštu i štampanje prodajnih obrazaca, i praćenje tekućih bilansa; pružanje privremenog korišćenja onlajn softvera koji se ne može preuzimati za unos kontakata i finansijskih podataka sa drugih elektronskih servisa ili softvera; pružanje privremenog korišćenja onlajn softvera koji se ne može preuzimati za transakcije na mjestu prodaje ili upravljanje maloprodajom; pružanje privremenog korišćenja onlajn softvera koji se ne može preuzimati za upotrebu u administraciji ili upravljanju platnim spiskovima, štednim planovima, planovima osiguranja, penzionim planovima, planovima osiguranja za slučaj nezaposlenosti, i pretplatničkim planovima zdravstvenog osiguranja; pružanje privremenog korišćenja onlajn softvera koji se ne može preuzimati za upravljanje informacijama o zdravstvenoj njezi, informacijama o receptima, medicinskoj istoriji, medicinskim računima, bilješkama o pacijentima, i drugim medicinskim bilješkama; pružanje privremenog korišćenja onlajn softvera koji se ne može preuzimati za upravljanje medicinskim osiguranjem, medicinskim uplatama, troškovima i računima; pružanje privremenog korišćenja onlajn softvera koji se ne može preuzimati za upravljanje odnosima sa potrošačima (CRM); pružanje privremenog korišćenja onlajn softvera koji se ne može preuzimati za planiranje resursa u korporacijama (ERP); pružanje privremenog korišćenja onlajn softvera za poslovno upravljanje koji se ne može preuzimati za upotrebu u upravljanju nepokretnostima i imovinom, upravljanju auto-moto uslugama i popravkama; upravljanju konstrukcijama i građevinama, upravljanju praksama zdravstvene njege,

upravljanju advokatskim firmama, upravljanju neprofitnim organizacijama i organizacijama javnog sektora, upravljanju maloprodajom i restoranima, i upravljanju putničkim servisima; elektronsko pohranjivanje datoteka i podataka; pohranjivanje elektronskih medija, naime slika, teksta, audio, finansijskih i kontakt podataka; usluge pohranjivanja za arhiviranje baza podataka, slika i drugih elektronskih podataka; usluge hostinga podataka; hosting softverskih programa za upotrebu u upravljanju, organizovanju, i dijeljenju podataka na računarskom serveru i za saradnju zasnovanu na web-u na globalnoj računarskoj mreži i na internoj računarskoj mreži, usluge tehničke podrške; tehničke konsultacije u oblasti računarskog hardvera i softvera; usluge instaliranja računarskog softvera, podešavanja, i konfiguracijske usluge; usluge računarskog softvera i sistemske integracije; konverzija podataka u smislu podataka ili informacija o programima za računare; usluge vraćanja podataka; usluge tehničke podrške, naime, utvrđivanje i rješavanje problema računarskog softvera, web sajta, onlajn usluga, problema na web i onlajn aplikacijama, problema mobilnih aplikacija, problema na mreži, i problema sa podacima i bazama podataka; sinhronizovanje podataka između računara i mobilnih uređaja.

(111) **14941**

(151) 27.10.2020.

(210) Ž-2019-312

(220) 19.08.2019.

(732) Arexons S.p.A, Via Antica di Cassano, 23, 20063, Cernusco sul Naviglio MI, IT

(540)



(550) I

(740) Miladin Popović, Đoka Miraševića 21/III, 81000, Podgorica

(511) Klasa 21: Krpe za čišćenje.

(111) **14942**

(151) 27.10.2020.

(210) Ž-2019-363

(220) 25.09.2019.

(732) AbbVie Biotechnology Ltd, Clarendon House, 2 Church Street, HM 11, Hamilton, BM

(540)

RINVOQ

(550) I

(740) Miladin Popović, Đoka Miraševića 21/III, 81000, Podgorica

(511) Klasa 5: Farmaceutski preparati.

(111) **14943**

(151) 27.10.2020.

(210) Ž-2019-291

(220) 23.07.2019.

(732) 7-Eleven, Inc., 3200 Hackberry Road, 75063, Irving, Texas, US

(540)



(550) I

(740) Božidar S. Radulović, Studentska bb, Lamela 3/18, 81000, Podgorica

(511) Klasa 30: Kafa; čaj; kakao; šećer; pirinač; tapioka; sago; testenina; zamene za kafu; brašno i proizvodi od žitarica; hleb; peciva; poslastice; ledene poslastice; kolači; biskviti, suvi kolačići; med; melasa; kvasac; prašak za pecivo; so; senf; sirće; začini; led; pekarske poslastice, tart (slatka pita bez gornje kore) i pite; salate od makarona, pirinča i testenina; začinski dodaci, naročito kečap (sos), reliš (dodatak jelu), kiseli krastavac; reliš od kiselog krastavca, roštiljski sos, ljuti sos, čili sos, sos od sira i majonez; punjene rolnice i sendviči; sendviči sa viršlama; smrznuti, gotovi ili spakovani obroci koji se prvenstveno sastoje od pirinča, rezanaca i/ili testenine; pirinčane kuglice; zemičke kuvane na pari; takito (mala pržena rolovana punjena tortilja) i sendvič vrapovi; pica; pekarski proizvodi, naime gibanice, fokča, keks, braunis, mafini i krofne; čokolada; koštunjavo voće, grickalice i proizvodi od hleba sa čokoladnim prelivom; slatkiši, čokoladice i zvakace gume; napici na bazi kafe i čaja;

topla čokolada; pločice sa jogurtom; čips i krekeri napravljeni od kukuruza, pšenice i žita; salsa sos; sladoled; pikantne grickalice; pločice od žitarica i energetske pločice; mešavina grickalica koja se prvenstveno sastoji od krekerica, pereca, i/ili gotovih kokica; mešavina grickalica koja se prvenstveno sastoji od koštunjavog voća sa prelivom (poslastica); žitarice, grickalice na bazi žitarica, zrna kukuruza, granole, pirinča i pšenice.

Klasa 35: Oglašavanje; vođenje poslova; poslovno upravljanje; kancelarijski poslovi; usluge maloprodaje u supermarketima u oblasti robe široke potrošnje.

Klasa 43: Usluge obezbeđivanja hrane i pića; privremeni smeštaj; obezbeđivanje privremenog boravka i/ili pansioniskog boravka u hotelima, hostelima, pansionima, kampovima, smeštajima za odmor i turističkim smeštajima; usluge rezervisanja privremenog smeštaja za boravak i/ ili pansioniski boravak u hotelima, hostelima, pansionima, kampovima, smeštajima za odmor i turističkim smeštajima; pružanje usluga restorana, barova, samouslužnih restorana, kantina, kafića, kafeterija i snek barova; usluge rezervisanja restorana, barova, samouslužnih restorana, kantina, kafića, kafeterija i snek barova.

(111) **14944**

(151) 27.10.2020.

(210) Ž-2019-277

(220) 12.07.2019.

(732) Airwair International Limited, Cobb's Lane, Wollaston, Northamptonshire, NN29 7SW, Wellingborough, GB

(540)

AIRWAIR

(550) I

(740) Miladin Popović, ul. Capital Plaza, ulica šeika Zajeda 13-IV/68, 81000, Podgorica

(511) Klasa 3: Preparati za čišćenje i poliranje cipela; sapuni i deterdženti; krema i sredstva za poliranje čizama; crni lak za obuću (sredstva za poliranje obuće); vosak za cipele; kreme za kožne proizvode, sredstva za poliranje kožnih proizvoda; sredstva za poliranje obuće, sredstva za obnavljanje obuće, sredstva za čišćenje i zaštitu gornjih dijelova obuće koji su od tekstila; sredstva za čišćenje i zaštitu kožnih proizvoda.

Klasa 9: Sigurnosna i obuća i odjeća za upotrebu u industriji; zaštitna i sigurnosna oprema; sigurnosna obuća za zaštitu od nesreća ili povreda; zaštitna obuća za sprečavanje nesreća ili povreda; zaštitne cipele; zaštitne industrijske cipele; zaštitne cipele (od nezgode ili povrede); cipele za zaštitu od nesreća, zračenja i požara; čizme (zaštitna obuća); zaštitne industrijske čizme; sigurnosne čizme za upotrebu u industriji (za zaštitu od nesreće ili povreda); zaštitna odjeća za sprječavanje povreda; zaštitna odjeća za sprječavanje nesreća; odjeća za zaštitu od nesreća, zračenja i požara; izolovana odjeća za zaštitu od

nesreća ili povreda; zaštitna radna odjeća (za zaštitu od nesreća ili povreda); odjeća za zaštitu od povreda; đonovi i ulošci za industrijsku obuću; jastučići za kolena za radnike; šlemovi; zaštitne rukavice.

Klasa 18: Koža, neobrađena ili poluobrađena; krzno, neobrađeno ili poluobrađeno; imitacije kože; vještačka koža; moleskin (imitacija kože); torbe; kaiševi za sedla, podesivi kaiševi za prtljag i kožni kaiševi za ramena; ženske tašne; džepni novčanici; kozmetičke torbice [prazne]; novčanici; futrole za ključeve; futrole za vizitkarte; sanduci (prtljag) i koferi; školske torbe i rančevi; školske torbe na rame; torbe na rame; pismo torbe; ruksaci; naprtnjače; torbe za kupovinu; sportske torbe; kontejneri, odnosno putni setovi (kožni proizvodi); putne torbe; kišobrani; suncobrani i štapovi za hodanje; ručke za štapove i štapovi za hodanje; aktovke; ručne torbe; velike torbe; bičevi, remenje i sedlarski proizvodi; kožne vezice; prtljag koji nije kožni; klasične velike torbe (tote).

Klasa 25: Odjeća; sportski dresovi; trikotaža (odjeća); odjeća za bebe; kaputi; ogrtači; majice; košulje; majice; polo majice; trikotaža; jakne; farmerke; topovi; pantalone; konfekcijska odjeća; helanke; najlonske carape; donje rublje; pokrivala za glavu; kape; šeširi; znojnici; kapuljace; male kape uz glavu; marame; šalovi marame (mufovi); marame za vrat; šalovi; rukavice (odjeća); čarape; čarape (koje upijaju znoj); sokne; kaiševi; kožni remeni (odjeća); obuća; pričvršćivači pete, pomagala za fiksiranje pete; čizme; sportske čizme; podvezice; držači čarapa [tregeri]; pojasevi; sandale; cipele; gornji dijelovi čizama; ulošci za cipele; metalni dijelovi za obuću; đonovi za obuću; ulošci za obuću.

(111) **14946**

(151) 29.10.2020.

(210) Ž-2019-256

(220) 27.06.2019.

(732) HONGYUNHONGHE TOBACCO (GROUP) CO., LTD, NO. 367 HONGJIN ROAD, WUHUA DISTRICT, KUNMING CITY, YUNNAN PROVINCE, CN

(540)

WIN

(550) I

(740) Božidar S. Radulović, Studentska bb, Lamela 3/18, 81000, Podgorica

(511) Klasa 11: Grejna tela; grejne ploče; regeneratori toplote; aparati za grejanje na čvrsta, tečna ili gasna goriva; upaljači (koji nisu za pušaće); instalacije za taloženje u duvanskoj industriji; pržionici duvana; aparati na vruć vazduh; aparati za grejanje, električni; isparivači.

(111) **14948**

(151) 28.10.2020.

(210) Ž-2018-75

(220) 13.03.2018.

(732) "MONTEPASS" DOO Podgorica, Nova Dalmatinska 2008, Podgorica, ME

(540)



(550) I

(511)

Klasa3:Oglašavanje i reklamiranje; vođenje komercijalnih poslova; komercijalna administracija; kancelarijski poslovi.

Klasa 41: Obuka; stručno osposobljavanje; razonoda; sportske i kulturne djelatnosti.

Klasa 45: Pravne usluge; sigurnosne usluge za zaštitu imovine i lica; lične i društvene usluge koje pružaji drugi, namjenjene za zadovoljenje ljudskih potreba.

(111) **14949**

(151) 28.10.2020.

(210) Ž-2019-118

(220) 22.03.2019.

(732) EVEREST S.A., of Athens International Airport "Eleftherios Venizelos" Building 14B, 19019, Spata,Attica, GR

(540)



(550) I

(740) Jasna Jusić, Dalmatinska 2, 81000, Podgorica

(511) Klasa 29: Meso, riba, živina i divljač; mesni ekstrakti; konzervirano, sušeno i kuvano voće i povrće; želei, džemovi, kompoti; jaja; mlijeko i mliječni proizvodi; jestiva ulja i masti.

Klasa 30: Kafa, čaj, kakao i zamjena kafe; pirinač; tapioka i sago; brašno i proizvodi od žitarica; hleb, peciva i konditorski proizvodi; sladoledi; šećer, med, melasa; kvasac, prašak za pecivo; so; senf; sirće, sosovi (dodaci jelu); začini; led.

Klasa 32: Pivo, mineralne i gazirane vade te ostala bezalkoholna pića; voćni napici i voćni sokovi; sirupi i ostali preparati za pripremanje napitaka.

Klasa 35: Oglašavanje; poslovno upravljanje; poslovna administracija; kancelarijski poslovi.

Klasa 39: Usluge dostave hrane.

Klasa 43: Usluge obezbjeđivanja hrane i pića, usluge hrane za ponijeti.

(111) **14950**

(151) 28.10.2020.

(210) Ž-2019-145

(220) 03.04.2019.

(732) SAILUN GROUP CO.,LTD., No.588, Maoshan Road, Huangdao District, Qingdao City, Shandong, CN

(540)

The logo for RXMOTION features the word "RXMOTION" in a bold, italicized, sans-serif font. The letter "O" is stylized as a tire tread pattern.

(550) I

(740) Dejan Raičević, Vojvode Boža br.1, 81250, Cetinje

(511) Klasa 12: Automobilske gume; Gume za točkove vozila; Gazeća površina za pneumatske gume; Pneumatske gume; Protettori guma; Unutrašnje gume za bicikle i motocikle; Unutrašnje gume za pneumatske gume; Lanci, kramponi, ekseri i šiljci za gume; Spoljni omotači pneumatskih guma; Oprema za krpljenje i reparaciju unutrašnjih guma.

(111) **14951**

(151) 28.10.2020.

(210) Ž-2019-146

(220) 03.04.2019.

(732) SAILUN GROUP CO.,LTD., No.588, Maoshan Road, Huangdao District, Qingdao City, Shandong, CN

(540)

The logo for RXQUEST features the word "RXQUEST" in a bold, italicized, sans-serif font. The letter "Q" is stylized with a horizontal line through its middle.

(550) I

(740) Dejan Raičević, Vojvode Boža br.1, 81250, Cetinje

(511) Klasa 12: Automobilske gume; Gume za točkove vozila; Gazeća površina za pneumatske gume; Pneumatske gume; Protettori guma; Unutrašnje gume za bicikle i motocikle; Unutrašnje gume za pneumatske gume; Lanci, kramponi, ekseri i šiljci za gume;

Spoljni omotači pneumatskih guma; Oprema za krpljenje i reparaciju unutrašnjih guma.

(111) **14952**

(151) 28.10.2020.

(210) Ž-2019-219

(220) 10.06.2019.

(732) GABA International Holding GmbH, Grabetsmattweg, 4106, Therwil, CH

(540)

ELMEX SENSITIVE PROFESSIONAL

(550) I

(740) Jasna Jusić, Dalmatinska 2, 81000, Podgorica

(511) Klasa 21: Četkice za zube, konac za čišćenje zuba, interdentalna sredstva za čišćenje.

(111) **14953**

(151) 28.10.2020.

(210) Ž-2019-224

(220) 14.06.2019.

(732) BB&T Corporation, P.O. Box 1255, 27101, Winston-Salem, North Carolina, US

(540)

TRUIST

(550) I

(740) AOD "Lutovac & partneri", Bulevar Ivana Crnojevića 93, 81000, Podgorica

(511) Klasa 36: Finansijske i osiguravajuće usluge, i to bankarstvo, upravljanje povjerenjem, upravljanje investicijama, investiciono bankarstvo, međunarodno bankarstvo, korporativne finansije, faktoring, hipotekarno kreditiranje, finansijska klirinška kuća, finansiranje lizinga i finansiranje otkupa lizinga, finansijsko planiranje, analiza finansijskog portfelja i savjetovanje, usluge kreditnih kartica, usluge debitnih kartica, brokersko poslovanje i usluge zastupanja u osiguranju; onlajn bankarske usluge; usluge plaćanja računa putem veb stranice; usluge digitalnog bankarstva, naročito onlajn finansijsko upravljanje.

(111) **14957**

(151) 28.10.2020.

(210) Ž-2019-297

(220) 26.07.2019.

(300) TR br. 2019/20779 od 28.02.2019.godine.

(732) AMGEN İLAÇ TICARET LIMITED SİRKETİ, İs Kuleleri Levent Mah. Meltem Sokak
No:10 Kule:2 Kat:25, 4.Levent Besiktas, Istanbul, TR

(540)



(550) I

(740) Božidar S. Radulović, Studentska bb, Lamela 3/18, 81000, Podgorica

(511) Klasa 5: Farmaceutski preparati; farmaceutski preparati za upotrebu u tretmanu bolesti ili poremećaja kostiju, zglobova, kičmenog stuba, tankog creva, debelog creva, kože, pluća, oka, dojke, jajnika, grlića materice, želuca, bešike, bubrega, glave, mozga, vrata, krvi i farmaceutski preparati za lečenje autoimunih bolesti, bolesti imunog sistema, zapaljenskih bolesti, zapaljenske bolesti creva, gastrointestinalnih, genitourinarnih, mišićno-skeletnih, mišićnih, dermatoloških, plućnih, respiratornih, onkoloških, hepatoloških, virusnih, metaboličkih, endokrinih, kardiovaskularnih, kardiopulmonalnih, bolesti seksualne disfunkcije, oftalmoloških, neuroloških, hormonskih i psihijatrijskih bolesti i poremećaja; farmaceutski preparati za lečenje autoimunih bolesti i poremećaja.

Klasa 10: Medicinski uređaji i instrumenti; uređaji za otpuštanje leka; sistemi za dopremanje lekova; uređaji za ubrizgavanje za farmaceutske preparate; medicinski špricevi; hirurški uređaji i instrumenti; hirurški instrumenti i aparati; i hirurški i medicinski aparati i instrumenti za upotrebu u opštoj hirurgiji.

Klasa 35: Usluge distributerstva i usluge koje se sastoje od prikupljanja, za potrebe drugih, farmaceutskih i veterinarskih preparata za medicinske namene, hemijskih preparata za medicinske i veterinarske namene, hemijskih reagenasa za farmaceutske i veterinarske namene, medicinske kozmetike, dijetetskih dodataka ishrani za farmaceutske i veterinarske namene, dijetetskih suplemenata, suplemenata sa hranljivim sastojcima, medicinskih preparata za mršavljenje, hrane za bebe, bilja i biljnih napitaka prilagođenih za medicinske namene, stomatoloških preparata i proizvoda, materijala za stomatološke ispune, materijala za uzimanje dentalnih otisaka, stomatoloških lepkova i materijala za popravku zuba, sanitarnih preparata za medicinsku upotrebu, higijenskih uložaka, higijenskih tampona, flastera, materijala za previjanje, papirnih i tekstilnih pelena za bebe, odrasle osobe i kućne ljubimce, preparata za uništavanje štetočina, herbicida, fungicida, preparata za uništavanje glodara, dezodoranasa osim onih za ljude ili za životinje, preparata za prečišćavanje vazduha, preparata za dezodoraciju vazduha, sredstava za dezinfekciju, antiseptika,

detergenata za medicinske namene, medicinskih sapuna, sapuna za dezinfekciju, antibakterijskih losiona za ruke, farmaceutskih preparata, farmaceutskih preparata za upotrebu u tretmanu bolesti ili poremećaja kostiju, zglobova, kičmenog stuba, tankog creva, debelog creva, kože, pluća, oka, dojke, jajnika, grlića materice, želuca, bešike, bubrega, glave, mozga, vrata, i krvi i farmaceutskih preparata za lečenje autoimunih bolesti, bolesti imunog sistema, zapaljenskih bolesti, zapaljenske bolesti creva, gastrointestinalnih, genitourinarnih, mišićno-skeletnih, mišićnih, dermatoloških, plućnih, respiratornih, onkoloških, hepatoloških, virusnih, metaboličkih, endokrinih, kardiovaskularnih, kardiopulmonalnih, bolesti seksualne disfunkcije, oftalmoloških, neuroloških, hormonskih, i psihijatrijskih bolesti i poremećaja, farmaceutskih preparata za lečenje autoimunih bolesti i poremećaja, hirurških, medicinskih, stomatoloških i veterinarskih aparata i instrumenata, nameštaja posebno proizvedenog za medicinske namene, veštačkih udova i proteza, medicinskih ortopedskih proizvoda, steznika za medicinske namene, ortopedskih cipela, elastičnih zavoja i zavoja koji pružaju podršku, hirurških kecelja i hirurških sterilnih čaršafa, seksualnih pomagala za odrasle, kondoma, bočica za bebe, cucli varalica za bebe, cucli, igračaka za bebe za podršku kod rasta zuba, narukvica i prstenova za medicinske namene, antireumatskih narukvica, antireumatskih prstenova, medicinskih uređaja i instrumenata, uređaja za otpuštanje lekova, sistema za dopremanje lekova, uređaja za ubrizgavanje za farmaceutske preparate, medicinskih špriceva, hirurških uređaja i instrumenata, hirurških instrumenata i aparata i hirurških i medicinskih aparata i instrumenata za upotrebu u opštoj hirurgiji, koji omogućavaju klijentima da na jednostavan način pogledaju i kupe robu, gde takve usluge mogu da budu obezbeđene u maloprodajnim objektima, velikoprodajnim objektima, putem elektronskih medija ili putem kataloga za naručivanje poštom; usluge upućivanja, naročito obezbeđenja informacija o proizvodima klijentima u oblasti farmaceutskih proizvoda, zdravstvenih proizvoda i medicinskih proizvoda; distribucija uzoraka za svrhe ocenjivanja medicinskih proizvoda, kutija za otpad od oštih predmeta za medicinske svrhe i odgovarajućih prenosnih medicinskih frižidera; obezbeđivanje komercijalnog informacionog direktorijuma na internetu za oblasti farmaceutskih proizvoda, zdravstvenih proizvoda i medicinskih proizvoda; usluge oglašavanja i marketinga.

Klasa 41: Obezbeđivanje onlajn publikacija u obliku brošura i biltena u oblasti farmaceutskih sredstava, biološki sličnih sredstava, lekova i zdravlja; organizacija i realizacija časova, seminara i radionica u oblasti farmaceutskih sredstava, biološki sličnih sredstava, lekova i zdravlja; obrazovne usluge, naročito programi o farmaceutskim sredstvima, biološki sličnim sredstvima, lekovima i zdravlju kojima se može pristupiti preko audio, video, i aplikacija na internetu, aplikacija za mobilne telefone i računarskih mreža; obrazovne usluge, naročito realizacija programa u oblasti farmaceutskih sredstava, biološki sličnih sredstava, lekova i zdravlja.

Klasa 42: Istraživanje i razvoj farmaceutskih preparata i biološki sličnih sredstava; istraživanje i razvoj u farmaciji i biotehnologiji; informacije o medicinskim i naučnim istraživanjima u oblasti farmaceutskih sredstava, biološki sličnih sredstava i kliničkih studija; obezbeđivanje veb-sajtova sa informacijama o farmaceutskim preparatima i biološki sličnim sredstvima; usluge podrške u vezi sa farmaceutskim i biološki sličnim sredstvima, naročito usluge podrške za korisnike; obezbeđenje onlajn računarskog softvera koji se koristi za pristup, upravljanje, ažuriranje i prikazivanje elektronskih baza podataka u oblasti farmaceutskih preparata i biološki sličnih sredstava.

Klasa 44: Obezbeđivanje medicinskih informacija i usluge pružanja podrške pacijentima, naročito farmaceutski saveti i konsultacije u vidu obezbeđenja onlajn informacija o farmaceutskim sredstvima i lečenju i prevenciji različitih bolesti, poremećaja i oboljenja;

obezbeđivanje zdravstvenih i medicinskih informacija o farmaceutskim sredstvima; usluge informisanja, naročito obezbeđivanja medicinskih informacija pacijentima; obezbeđivanje medicinskih konsultacija i savetodavnih usluga putem globalne računarske mreže u oblasti farmaceutskih sredstava i različitih bolesti, poremećaja i oboljenja; obezbeđivanje medicinskih informacija za pacijente koji pate od kancera; obezbeđivanje usluga podrške pacijentima koje se odnose na kancer i lečenje kancera; obezbeđivanje informacija o zdravlju kostiju kod ležećih pacijenata koji pate od kancera pružanjem lično prilagođenih medicinskih informacija i praktičnih saveta za komunikaciju o zdravlju kostiju sa zdravstvenim radnicima; obezbeđivanje medicinskih saveta i saveta preko globalne računarske mreže u oblasti ustuga informisanja u vezi sa zdravljem kostiju, uključujući i u slučaju kancera; obezbeđivanje medicinskih informacija i usluge pružanja podrške pacijentima uključujući i u oblasti zdravlja kostiju, prevencije osteoporoze, farmaceutskih saveta i savetovanja u obliku informacija na internetu o lečenju osteoporoze i bolesti kostiju i farmaceutskim preparatima za lečenje osteoporoze; obezbeđivanje medicinskih izveštaja o pacijentima lečenim od osteoporoze i bolesti kostiju; medicinski saveti i saveti putem globalne računarske mreže u oblasti lečenja kancera i hemoterapije; obezbeđenje medicinskih informacija i usluga pružanja podrške pacijentima, npr. farmaceutskih saveta i usluga savetovanja kako bi se obezbedile onlajn informacije o imunotrombocitopeniji purpura (ITP); obezbeđivanje zdravstvenih i medicinskih informacija o imunotrombocitopeniji purpura (ITP); obezbeđivanje medicinskih informacija za pacijente koji pate od imunotrombocitopenije purpura (ITP); obezbeđivanje usluga pružanja podrške pacijentima kod lečenja medicinskih stanja, uključujući obezbeđivanje informacija o pacijentima i informacija o primeni lekova za porodice pacijenata, i obezbeđivanje medicinskih informacija za pacijente, kako bi se informisali o medicinskim pitanjima i procesima kod zdravstvenih radnika; usluge u oblasti pružanja informacija o pravilnoj primeni lekova.

(111) **14954**

(151) 30.10.2020.

(210) Ž-2019-368

(220) 25.09.2019.

(732) Colgate-Palmolive Company (a Delaware corporation), 300 Park Avenue, 10022, New York, New York, US

(540)

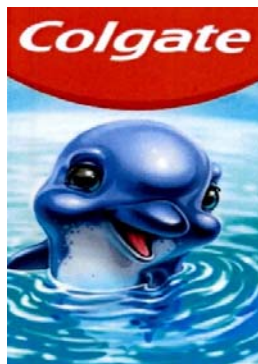

(550) I

(740) Jasna Jusić, Dalmatinska 2, 81000, Podgorica

(511) Klasa 3: Nemedicinska pasta za zube, nemedicinska tečnost za ispiranje usta.

(111) **14955**

(151) 30.10.2020.

(210) Ž-2019-400

(220) 17.10.2019.

(732) Celgene Corporation, 86 Morris Avenue, 07901, Summit, New Jersey, US

(540)

ACTOTЛEO

(550) I

(740) Jasna Jusić, Dalmatinska 2, 81000, Podgorica

(511) Klasa 5: Farmaceutski preparati za liječenje raka i autoimunih bolesti, bolesti iz oblasti onkologije, imunologije i zapaljenskih procesa; farmaceutski preparati, naime inhibitori lijeka citokina; farmaceutski preparati koji moduliraju imunološki sistem; farmaceutski preparati, naime preparati za liječenje tumora; farmaceutski i biološki preparati za imunoterapiju, uključujući T-ćelijsku terapiju; ćelije za medicinsku ili kliničku upotrebu; dijagnostički setovi koji se sastoje prevashodno od ćelija za medicinsku ili kliničku upotrebu.

(111) **14956**

(151) 30.10.2020.

(210) Ž-2019-401

(220) 17.10.2019.

(732) Celgene Corporation, 86 Morris Avenue, 07901, Summit, New Jersey, US

(540)

EHXAPHEKC

(550) I

(740) Jasna Jusić, Dalmatinska 2, 81000, Podgorica

(511) Klasa 5: Farmaceutski preparati za liječenje raka i autoimunih bolesti, bolesti iz oblasti onkologije, imunologije i zapaljenskih procesa; farmaceutski preparati, naime inhibitori lijeka citokina; farmaceutski preparati koji moduliraju imunološki sistem; farmaceutski preparati, naime preparati za liječenje tumora; farmaceutski i biološki preparati za imunoterapiju,

uključujući T-ćelijsku terapiju; ćelije za medicinsku ili kliničku upotrebu; dijagnostički setovi koji se sastoje prevashodno od ćelija za medicinsku ili kliničku upotrebu.

(111) **14947**

(151) 29.10.2020.

(210) Ž-2019-271

(220) 10.07.2019.

(732) Polar Music International AB, Banérgatan 16, 114 83, Stockholm, SE

(540)

ABBA

(550) I

(740) Božidar S. Radulović, Studentska bb, Lamela 3/18, 81000, Podgorica

(511) Klasa 9: Nasnimljene audio trake, audio diskovi i audio kasete, video trake, video diskovi i video kasete, digitalne audio i digitalne audio video trake i diskovi, CD-ovi, DVD-ovi, laserski diskovi, gramofonske ploče sa muzičkim i zabavnim sadržajem; pozorišni i muzički zvučni i video zapisi; softver za igre virtuelne realnosti; melodije zvona, muzika, mp3 fajlovi koji sadrže muziku i razonodu, grafike, slike u oblasti muzike i razonode u vezi sa muzikom, video zapisi u oblasti muzike i razonode u vezi sa muzikom i igrice, a koje se mogu preuzeti sa interneta za bežične komunikacijske uređaje; muzika, mp3 fajlovi koji sadrže muziku i razonodu u vezi sa muzikom, grafike, slike u oblasti muzike i razonode u vezi sa muzikom, video zapisi u oblasti muzike i razonode u vezi sa muzikom i kompjuterske igrice, a koje se mogu preuzeti sa interneta; softveri, trake, kertridži i kasete sa kompjuterskim igricama; softveri, trake, kertridži i kasete sa video igricama; okretne ploče kao delovi i oprema za gramofone; podloge za miševe; elektronske publikacije koje se mogu preuzeti sa interneta u obliku knjiga, knjižica, muzičkih partitura, časopisa, žurnala, priručnika, brošura, letaka, pamfleta i novina (biltena), a sve u oblasti muzike i razonode u vezi sa muzikom; mobilne aplikacije, koje se mogu preuzeti sa interneta, za korišćenje u vezi sa pristupom, prikazivanjem, distribucijom, preuzimanjem, igranjem, primanjem, strimingom i prenosom muzike i razonode u vezi sa muzikom.

Klasa 16: Štampane knjige i časopisi u oblasti muzike, razonode, umetnosti i kulture; štampane muzičke partiture; adresari; rokovnici; kalendari; čestitke, dopisnice; razglednice; pernice za obične i hemijske olovke; rezači za olovke; hemijske olovke; olovke; dnevnic; nalepnice za branike automobila; crteži koji se kopiraju na podlogu; blokovi za beleške; nalepnice; gumeni pečati; nalepnice za privremenu tetovažu; poster; kolekcionarski kartonski poklopci flaša za mleko za razmenu; kolekcionarske sličice za razmenu; spajalice za novac; kancelarijski materijal i pribor.

Klasa 18: Proizvodi od kože, naročito, tašne, ceger torbe, akten tašne, futrole za kreditne kartice, prenosne čvrste torbe, koferi, tašne za novčiće, putne torbe za odeću, torbe za teretanu, rančevi, torbe za knjige, torbice za nošenje na bokovima, portfelj tašne i novčanici; tašne; ceger torbe; akten tašne; futrole za kreditne kartice; prenosne čvrste torbe; koferi; tašne za novčiće; putne torbe za odeću; torbe za teretanu; rančevi; torbe za knjige; torbice za nošenje na bokovima; portfelj tašne i novčanici; kišobrani; ogrlice i odeća za kućne

ljubimce; prazni neseseri; kozmetički koferčići koji se prodaju prazni.

Klasa 25: Odeća, naročito bademantili, bluze, bodi, kaputi, radni mantili, haljine, kućne haljine, kostimi za Noć veštica, čarape, jakne, puloveri, helanke, rukavice sa jednim prstom, rukavice, spavačice, kombinezoni, pidžame, pantalone, sobni ogrtači, marame, šalovi, košulje, šorcevi, suknje, kratke čarape, soknice, tregeri, gornji delovi trenerki, donji delovi trenerki, dukserice, džemperi, kupaći kostimi, majice bez rukava, kravate, ženske najlon čarape, gornji delovi odeće, majice, veš, donji veš, prsluci i manžetne; obuća; pokrivala za glavu, naročito bandana marame, kape, štitnici za uši, šeširi i viziri; kaiševi; korseti; ženski donji veš; kecelje; patofnice za bebe; portikle od tkanine; bodi za bebe; odeća za malu decu; jednodelna odela za bebe.

Klasa 35: Usluge distribucije u oblasti muzičkih zvučnih zapisa i video zapisa; usluge reklamiranja i promocije i srodne konsultantske usluge; usluge reklamiranja i publiciteta; usluge udruživanja, naročito promocije interesa muzičara, pevača, kompozitora, tekstopisaca, muzičkih izvođača i umetnika; računarsko naručivanje preko interneta za robu široke potrošnje i dobra široke potrošnje; usluge računarskog naručivanja preko interneta u oblasti muzike; usluge računarske internet prodaje na malo u oblasti muzike; usluge računarskog naručivanja poklona preko interneta koje uklapaju zahteve poklonodavca sa željama i potrebama poklonoprimca; sprovođenje zanatske izložbe preko interneta, u oblasti muzike, muzičkih koncerata i spotova; usluge katalogskog naručivanja kompakt-diskova, kasete, DVD-eva, odeće i druge robe; usluge internet prodaje na malo za snimke muzike i audio-vizuelnog sadržaja koji se mogu preuzeti sa interneta, odeću i drugu robu; organizacija promocija pomoću audio-vizuelnih medija; priprema audio-vizuelnih prezentacija za reklamiranje muzike; priprema audio-vizuelnih prezentacija za upotrebu u reklamiranju; organizacija i sprovođenje zanatskih izložbi u oblasti muzike i razonode; organizacija i sprovođenje sajмова i izložbi u poslovne svrhe i svrhe reklamiranja; organizacija i sprovođenje zanatskih izložbi u oblasti muzike; promocija koncerata drugih; promocija dobara i usluga drugih ugovaranjem sa sponzorima koji će povezati svoja dobra i usluge sa koncertima i muzičkim manifestacijama; promovisanje robe drugih pripremom i postavljanjem reklama u elektronski časopis kojem se pristupa preko globalne računarske mreže; obezbeđivanje informacija o proizvodima za potrošače za robu i usluge drugih putem globalne računarske mreže; usluge maloprodajnih objekata dostupne preko računarskih komunikacija i interaktivnih televizijskih programa za kompakt diskove, kasete, DVD-eve, video kasete i licenciranu robu; pretplata na knjige, kritike, novine ili stripove.

Klasa 41: Produkcija televizijskih i radio programa; distribucija televizijskih i radio programa za druge; produkcija i objavljivanje muzike; obezbeđivanje razonode putem interneta, naročito obezbeđivanje zvučnih i video zapisa koji se ne mogu preuzeti u oblasti muzike i zabavnih sadržaja u vezi sa muzikom; usluge razonode, naročito obezbeđivanje muzičkih zvučnih snimaka i video snimaka koji se ne mogu preuzeti preko globalne računarske mreže; usluge klubova za razonodu; razvoj i distribucija obrazovnih materijala drugih u oblasti muzike i razonode; produkcija i distribucija zabavnih sadržaja za radio; snimanje i produkcija audio i zvučnih zapisa; produkcija zapisa; filmska i video produkcija; produkcija igranih filmova; distribucija igranih filmova; sindikacija u oblasti televizijskog programa; usluge razonode u obliku tekućih televizijskih programa u oblasti muzike i razonode; usluge razonode, naročito, u obliku muzičke i zabavne emisije u nastavcima koja se distribuira putem televizije, satelitskog prenosa, audio i video medija; objavljivanje knjiga i časopisa; usluge razonode u obliku tekućih radio programa u oblasti muzike; usluge razonode u obliku koncerata uživo i nastupa muzičkih umetnika i grupa; usluge razonode, naročito pojavijivanja muzičkih grupa, muzičkih umetnika i poznatih osoba uživo; usluge razonode u

obliku nastupa muzičkih umetnika prenesenih putem televizije, radija, audio i video zapisa; usluge razonode, naročito nastupi muzičkih umetnika izvedeni uživo i snimljeni za buduću distribuciju; usluge obrazovanja i razonode, naročito produkcija i prezentacija televizijskih emisija, sportskih događaja, modnih događaja, kvizova, muzičkih emisija, emisija za dodelu nagrada i komičnih emisija uživo pred publikom, koji se emituju u živom prenosu ili se snimaju za kasnije emitovanje; usluge razonode, naročito obezbeđivanje internet sajta sa muzičkim nastupima, muzičkim spotovima, odgovarajućim filmskim snimcima, fotografijama i drugim multimedijalnim materijalima sa muzikom i zabavnim sadržajima koji se ne mogu preuzeti sa interneta; usluge razonode, naročito obezbeđivanje kritika muzike, muzičkih umetnika i muzičkih spotova na internetu; usluge razonode, naročito obezbeđivanje prethodno snimljenih zapisa muzike koji se ne mogu preuzeti, informacija u oblasti muzike i komentara i članaka u vezi sa muzikom, sve to preko interneta putem globalne računarske mreže; usluge razonode, naročito nastupi profesionalnih zabavljača uživo, na televiziji i na filmovima; sprovođenje izložbi zabavnog sadržaja u obliku muzičkih festivala; usluge razonode, naročito izvođenje izložbi u oblasti muzike i umetnosti; organizacija izložbi u svrhe razonode na kojima se pojavljuju muzika i umetnost; objavljivanje internet časopisa.

(111) **14963**

(151) 29.10.2020.

(210) Ž-2019-285

(220) 17.07.2019.

(300) US 88/325087 od 04.03.2019. godine

(732) Reign Beverage Company LLC, a Delaware limited liability company, 1547 N. Knowles Ave., 90063, Los Angeles, California, US

(540)



(550) I

(740) Božidar S. Radulović, Studentska bb, Lamela 3/18, 81000, Podgorica

(511) Klasa 32: Fitnes napici.

(111) **14964**

(151) 30.10.2020.

(210) Ž-2019-286

(220) 17.07.2019.

(300) US 88/325082 od 04.03.2019. godine

(732) Reign Beverage Company LLC, a Delaware limited liability company, 1547 N. Knowles Ave., 90063, Los Angeles, California, US

(540)



(550) I

(740) Božidar S. Radulović, Studentska bb, Lamela 3/18, 81000, Podgorica

(511) Klasa 32: Fitnes napici

(111) **14958**

(151) 30.10.2020.

(210) Ž-2019-310

(220) 12.08.2019.

(732) Lidl Stiftung & Co. KG, Stiftsbergstraße 1, 74172, Neckarsulm, DE

(540)



(550) I

(740) AOD MSA IP - Milojević Sekulić Advokati, Karađorđeva 65, 11000, Beograd

(511) Klasa 4: Benzin za upaljače.

Klasa 6: Metalni lokoti (katanci) za bicikle; metalni lokoti (katanci) za motocikle; metalni karabinjeri.

Klasa 7: Delovi za podizanje i spuštanje ribarskih mreža, kao delovi mašina.

Klasa 8: Ručni alati i sprave (kojima se ručno upravlja); nožarski proizvodi, a naročito noževi za čišćenje i filetiranje ribe za ribolovce; džepni noževi; harpuni; nožarski proizvodi za kampovanje; koplja za štapove za pecanje.

Klasa 9: Zaštitna odeća za motocikliste; zaštitne kacige za motocikliste; zaštitne rukavice za motocikliste; naočare za sunce; nautički aparati i instrumenti; proizvodi za ronioce, naime ronilačka odela, ronilačke maske, prsluci za spasavanje (na naduvavanje i oni koji se ne mogu naduvati), disaljke za ronjenje, naočare za ronjenje, tegovi, pojasevi sa tegovima za ronjenje, oprema za disanje za plivanje pod vodom, boce sa vazduhom za ronioce, regulatori, dubinomeri (merači dubine mora), manometri, kompasi za određivanje pravca, termometri, čepovi za uši za ronioce, štipaljke za nos, odeća, rukavice za ronioce, obuća i pokrivala za glavu za ronjenje; štitnici za kukove za ribolovce; kamere za podvodno snimanje; aparati i instrumenti fotografski, kinematografski, optički, za vaganje, merenje, signalizaciju, kontrolu (inspekciju), spasavanje i podučavanje; merači frekvencije; brojači koraka; pametni satovi; uređaji za globalno pozicionirajući sistem (GPS); računar za biciklo; prenosivi računari za upotrebu u sportu; naočare (optika); naočare za sneg; naočare za plivanje; sigurnosne naočare; naočare protiv zaslepljivanja; ramovi za naočare; stakla za naočare; kutije za naočare; kacige za bicikliste; kacige za skijanje i snoubord; tahometri; klizni merači za dubinu; kacige za penjanje; sigurnosni proizvodi, naime, reflektirajuće sigurnosne trake koje se nose na telu; diode koje emituju svetlo.

Klasa 10: Kompresiona odeća; merači pulsa; aparati za masažu.

Klasa 11: Električne lampe; svetla za bicikle; lampe za osvetljenje; dekorativna svetla; aparati za kuvanje, hlađenje, snabdevanje vodom i za sanitarne svrhe; rashladne kutije (električne), roštilji; ventilatori.

Klasa 12: Dodatna oprema i delovi za vozila svih vrsta, a naročito dodatna oprema za motocikle i motocikle sa tri točka, koji su obuhvaćeni ovom klasom; mala električna vozila; oprema za bicikle, a naročito prikolice za bicikle, torbe za bicikle, pumpe za bicikle, montažna postolja dizajnirana za bicikle; oprema i delovi za bicikle u vidu kompleta za popravku; unutrašnje gume za bicikle; čamci i dodatna oprema za čamce; male prikolice za decu; kolica; sprej za popravljanje guma.

Klasa 14: Hronoskopi.

Klasa 17: Zaptivni materijali.

Klasa 18: Torbe, torbice, a naročito sportske torbe, višenamenske torbe i torbe koje se nose preko ramena; torbe (kovrte-kese) za pakovanje od kože; ruksaci i rančevi; putni rančevi; torbice koje se nose oko vrata; štapovi za hodanje; štapovi za planinarenje; štapovi za pešačenje; sedlarska roba, bičevi, kamdžije; jahački bičevi, uzde za treniranje konja; odeća i garderoba za životinje, prekrivači za konje, štitnici za noge za konje; torbe koje se nose na leđima; torbe za opremu; putne vreće; torbe za sedišta (bisage); kišobrani.

Klasa 19: Paviljoni za dvorište napravljeni od nemetalnih materijala.

Klasa 20: Sedišta i kreveti za upotrebu na otvorenom, a naročito stolice i ležaljke za plažu, stolice i kreveti za kampovanje, poljski kreveti, dušeci za kampovanje, nameštaj za kampovanje, stolovi za kampovanje; dušeci na naduvavanje za kampovanje; jastučići za

sedenje na naduvavanje; korpe (za ribolov), korpe u vidu ribolovačkih košara; jastučići za sedenje za ribolovce; futrole i kutije za skladištenje; stolice za ribolov; dušeci na naduvavanje.

Klasa 21: Boce i posude za piće; izotermičke torbe, prenosivi frižideri (neelektrične posude), rashladne patrone za hlađenje jela i pića; lonci, lonci za kampovanje; posude za mešanje mamaca; posude i pribor za ručavanje za kampovanje; posude za piknik; posude za prenošenje i čuvanje tečnosti i namirnica; četke, češljevi i pribor za čišćenje i negu konja.

Klasa 22: Šatori; cirade; mreže; ribarske mreže, mreže za dizanje i spuštanje; nadstrešnice za zaštitu od sunca; šatori za plažu, viseće ležaljke, mreže; vreće; vreće za transport; mreže za hvatanje ribe.

Klasa 24: Tekstil i tekstilni proizvodi koji se koriste za proizvodnju i upotrebu u vidu nadstrešnica i cirada za zaštitu od sunca, tekstil za kupanje; frotirski prekrivači za nameštaj; tekstilni peškiri; vreće za spavanje (koji su obuhvaćeni ovom klasom); vreće za spavanje za kampovanje.

Klasa 25: Odeća, obuća, rukavice [odeća], pokrivala za glavu, pojasevi, sva ispred navedena roba se odnosi isključivo na sportski sektor; motociklističke čizme, kabanice, a naročito odeća otporna na vremenske uslove za motocikliste, odeća za motocikliste; gumene čizme za kišu; odeća, obuća i pokrivala za glavu za ribolov; odeća za plažu; papuče za kupatilo; japanke [obuća]; ulošci za obuću; kramponi za cipele; kamašne, dokolenice i nazuvci; ulošci za obuću sa grejačima.

Klasa 26: Trake za kosu.

Klasa 27: Proştirke, a naročito proştirke za gimnastiku, sport, putovanja, pešačenje i kampovanje.

Klasa 28: Igre; igračke; gimnastički i sportski artikli, koji su obuhvaćeni klasom 28; lopte; reketi za badminton; mreže za badminton; oprema za badminton; reketi za skvoš; oprema za skvoš; reketi za tenis; oprema za tenis; štapovi za golf; loptice za golf; dodatna oprema za golf; reketi za stoni tenis; oprema za stoni tenis; skije; dodatna oprema za skijanje; krplice za sneg; pojasevi za penjanje; oprema za planinarenje; dodatna oprema za surfovanje; bokerske rukavice; vreće za udaranje; oprema za boks; bejzbol palice; bejzbol rukavice; hokejaški štapovi; oprema za hokej; streličarski pribor (sportski artikli); tetive za lukove; oprema za streličarstvo; oprema za vežbanje i fitnes; tramboline; kanapi za pecanje, pribor za pecanje, štapovi za pecanje i njihovi delovi; ribolovačka oprema, koja nije uključena u druge klase; dodatna oprema za ribolov, kalemovi za pecanje, najlon za pecanje, udice, olovo za ribolov, plovci za ribolov; mamci za pecanje (osim živih mamaca); veštačke muve za ribolov; mamac [veštački]; posude za mamce; držaci za pecaljke; mreže sa drškom za ribolov; varalice za ribolov; veštačke varalice za ribolov, vrše [ribolovačke zamke], rukavice za ribolov, puške (harpuni -) [sportska oprema]; štapovi, a naročito štapovi za ribolov; odela za plivanje; posude i torbe za ribolov i dodatna oprema za ribolov; peraja za plivanje; torbe prilagođene za nošenje sportske opreme; setovi za boćanje; mete i strelice za pikado; sportski rekviziti za plažu; akrobatski zmajevi; plutajuća oprema za plivanje na naduvavanje; šlaufi u obliku prstena za plivanje; bazeni za plivanje (za igranje); bazeni; daske za plivanje; daske za potrušno plivanje; sanke za sneg; skejtbord; roleri; klizaljke; štitnici, a naročito štitnici za leđa, ramena, laktove, kolena i zglobove (sportski artikli); oprema za golf, naime, golf kolica; oprema za tenis, naime, torbe za tenis; oprema za badminton, naime, torbe za badminton; oprema za skvoš, naime, torbe za skvoš.

Klasa 34: Upaljači; kremen za upaljače.

(111) **14965**

(151) 30.10.2020.

(210) Ž-2019-355

(220) 13.09.2019.

(732) Zagrebacka Pivovara d.o.o., Ilica 224, 10000, Zagreb, HR

(540)



(550) I

(740) AOD "Tripković & Raičević", Cetinjski put 40, L 5-1, stan 10, 81000, Podgorica

(511) Klasa 32: Bezalkoholna pića; izotonična pića; izotonična brzalkoholna pića.

(111) **14959**

(151) 30.10.2020.

(210) Ž-2019-426

(220) 05.11.2019.

(732) Domaća trgovina doo Podgorica, Ul.Josipa Broza Tita br.23a, 81000, Podgorica,

ME

(540)

OPUŠTENO

(550) I

(740) Goran Živković, ul. Petra Zvicera br.11, Podgorica

(511) Klasa 3: Bademovo ulje; bademov sapun; štirak za sjaj veša; štirak za pranje veša; štirak za veš; sapun*; sapun za izbeljivanje tekstila; plavilo za veš; etarsko ulje anisa;

kozmetički preparati za kupanje sapun za brijanje; vatirani štapići za kozmetičke svrhe; pamučni štapići za kozmetičku upotrebu; kozmetičke maske; bergamot ulje; soli za izbeljivanje soda za izbeljivanje belila za veš; mirišljivo drvo; preparati za ispiranje usta, koji nisu medicinski; lak za nokte; preparati za šminkanje; losioni za kosu*; kreme za cipele; boje za kosu; preparati za kovrdžanje kose; preparati za čišćenje, poliranje; preparati za poliranje; vosak za cipele; sredstva za poliranje nameštaja i podova; preparati za sjaj [poliri]; obučarski vosak; vosak za parket; vosak za poliranje; etarska ulja limuna; kolonjska voda; boje za toaletnu upotrebu; preparati za zaštitu kože [poliranje]; preparati za očuvanje kože [poliranje]; kozmetički setovi; kozmetika; pamučna vuna za kozmetičku upotrebu; kreda za čišćenje; preparati za uklanjanje mrlja; kozmetičke olovke; kreme za poliranje; kozmetičke kreme; soda za pranje, čišćenje; paste za brijanje; kreme za kožne proizvode; vosak za kožne proizvode; deterdženti, koji nisu za upotrebu u proizvodnim procesima i za medicinsku upotrebu; rastvori za čišćenje; proizvodi za odmašćivanje, koji nisu za upotrebu u procesu proizvodnje; preparati za uklanjanje šminke sredstva za čišćenje zuba [paste, gelovi, tečnosti]*; preparati za uklanjanje kamenca za upotrebu u domaćinstvu; dijamantin, boraks [arbaziv] antistatički preparati za kućnu upotrebu; preparati za uklanjanje laka; preparati za uklanjanje boje odstranjivači laka; mirišljave vode; toaletne vode; preparati za depilaciju; vosak za depilaciju; preparati za natapanje u perionicama; etarske esencije; etarska ulja; etarska ulja; ekstrakti cveća [parfemi]; šminka; preparati za čišćenje; baze za cvetne parfeme; fumigacijska sredstva [parfemi]; arome za kolače [etarska ulja]; ulja za kozmetičku upotrebu; jasminovo ulje; ulje od lavande; ulja za čišćenje; ulja za parfeme i mirise; ružino ulje; toaletna ulja; losioni za kozmetičku upotrebu; mleko za čišćenje za toaletnu upotrebu; preparati za pranje; toaletni proizvodi [sredstva za ličnu higijenu]*; preparati za štirkanje; mirisna menta [etarsko ulje]; menta za parfimerijske proizvode kozmetika za obrve; šamponi*; parfemi; preparati za negu noktiju; parfimerija; kozmetički preparati za negu kože; sapun protiv znojenja nogu; kamen za poliranje; pomade za kozmetičku upotrebu; puder za šminkanje; preparati za brijanje; dezodorantni sapun; kesice sa mirisom za rublje; safrol; komadi toaletnog sapuna; komadi sapuna; olovke za izvlačenje obrva; talk puder, za toaletnu upotrebu; kozmetičke boje; krpe za poliranje; stakleno platno [abrazivno platno]; preparati protiv znojenja; sapun protiv znojenja; tripoli kamen za poliranje; abrazivi; bademovo mleko za kozmetičku upotrebu; preparati za uklanjanje rđe; preparati za sunčanje [kozmetički]; aromatična ulja [etarska ulja]; arome za pića [etarska ulja]; hemikalije za osvežavanje boja za upotrebu u domaćinstvu [pranje veša]; soli za kupanje koje nisu za medicinsku upotrebu; kozmetički preparati; preparati za uklanjanje boja; dezodoransi za ljude ili životinje; dekorativne nalepnice za kozmetičku upotrebu; astringentna sredstva; preparati za beljenje [skidanje boje] za kozmetičku upotrebu; oplemenjivači rublja za upotrebu u perionicama; preparati za otčepljivanje odvodnih cevi; šamponi za kućne ljubimce [nemedicinski preparati za negu]; maramice natopljene sa kozmetičkim losionima; sredstva za lepljenje za kozmetičku upotrebu; losioni posle brijanja; lakovi za kosu; maskare; potpuri [mirisi]; sprejevi za osvežavanje daha; preparati za hemijsko čišćenje; odstranjivači voska sa poda [sredstva za odstranjivanje]; neklizajući vosak za podove; neklizajuće tečnosti za podove; vazduh konzerviran pod pritiskom, za čišćenje i uklanjanje prašine; gelovi za izbeljivanje zuba; krpe namočene deterdžentom za čišćenje; preparati za sjaj; lišća biljaka; mirisni štapići; sredstva za sušenje sudova u mašinama za sudove; preparati za parfimisanje vazduha; trake za osvežavanje daha; dezodoransi za kućne ljubimce; preparati za tuširanje za ličnu higijenu i dezodorisanje [toaletni proizvodi]; preparati od aloe vere za kozmetičke namene; sjajevi za usne; balzami, osim za medicinske svrhe; šamponi za suvo pranje*; preparati za sunčanje; etarsko ulje

limuna kana [kozmetička boja]; sredstva za čišćenje obuće; preparati za kupanje, ne za medicinske svrhe; balzami za kosu; proizvodi za ispravljanje kose; maramice natopljene preparatima za skidanje šminke; preparati kolagena za kozmetičke svrhe; trake za izbeljivanje zuba; arome za hranu [etarska ulja]; fitokozmetički preparati; sredstva za čišćenje za intimnu ličnu higijenu, nemedicinska; biljni ekstrakti za kozmetičke namene; sredstva za odstranjivanje laka za nokte; sredstva za uklanjanje laka za nokte; vosak za podove; šamponi za životinje [nemedicinski preparati za negu]; sredstva za ispiranje očiju, ne za medicinske namene; sredstva za vaginalno ispiranje za ličnu higijenu ili dezodorisanje; hemijski preparati za čišćenje za upotrebu u domaćinstvu; raspršivači od trske za osvežavanje vazduha; preparati za beljenje [uklanjanje boja] za upotrebu u domaćinstvu; kozmetika za decu; preparati za osvežavanje daha za ličnu higijenu; maramice za bebe natopljene preparatima za čišćenje; basma [kozmetička boja]; gel jastučići za oči za kozmetičke namene.

Klasa 16: Nosači lepljivih traka [kancelarijski pribor]; papir; poster; oglasni pano od papira ili kartona; spajalice [kancelarijski pribor]; klipse za olovke heftalice [kancelarijski rekvizit]; beležnice, notesi; albumi; slike; štampani materijal [viskoka štampa]; trake za cigare, za uvijanje cigareta; mašine za oštrenje olovaka, elektronske ili neelektronske podupirači za knjige; vodene boje [slikarske]; vodene boje, slikarske; akvarel boje; fascikle za spise [kancelarijski pribor]; tablice za pisanje; pisaljke za tablice; srebrni papir; olovke; novine; periodične publikacije; atlas; uložne mape sa prstenovima; registratori sa prstenovima; gumirane trake [kancelarijski materijal]; podmetači za pivske čaše; ulaznice; kliše; blokovi za crtanje blokovi [kancelarijski materijal]; kalemi za trake sa mastilom; manžetne za držanje pribora za pisanje; pamfleti; špenadle kao kancelarijski materijal; čiode kao kancelarijski materijal; ovlaživači vrhova prstiju [kancelarijski pribor]; jastučići za mastilo; vosak za pečačenje; sveske; obrasci za precrtavanje; paus papir; štamparska slova; karbon papir; papir za mašine za snimanje; beležnice; ugaoni lenjiri za crtanje; karte; materijal za obuku [izuzev aparata]; listovi papira [kancelarijski] karton; tube od kartona; katalozi; metalni vrh za indeksne karte; spojeni ramovi [štamparski]; omoti za papir; košuljice za spise; brojevi [štamparski]; indijsko mastilo; fascikle [kancelarijski materijal]; bušilice za papir [zumba]; higijenski papir; toalet papir; knjige; šestari za crtanje; štamparski brojevi i slova; slova, štamparska; kompozeri za slaganje; posude za pisma; konusne papirne kese; korektivna tečnost [kancelarijski rekvizit]; korektivno mastilo [heliografsko]; grafitne mine za olovke; kreda za pisanje; držači olovaka; olovke sa grafitnom minom [tehničke olovke]; papirne kutije za krem; table za crtanje; materijali za crtanje; instrumenti za crtanje; kutije za olovke; proizvodi za brisanje; materijali za pisanje; štitnici za brisanje; gumice za brisanje; elektrokardiografski papir; probadači [kancelarijski materijal]; mastilo; mastiljave trake; fotografije [štampane]; brisači za naliv pera; pečati; knjigovodstvene knjige; indeks registri; formulari [štampani]; kancelarijski materijal, izuzev nameštaja; štampani rokovnici; ovlaživači za lepljenje koverti [kancelarijski rekviziti]; dopisnice, razglednice; štampane stvari; pribor za ručno lepljenje nalepnica; štampane publikacije priručnici; papir za pisanje; pritiskači za papir; igle za kopiranje za crtačke svrhe; olovke za crtanje; stolnjaci od papira; knjižice; svetleći papir; pelir papir za kopije [kancelarijski materijal]; maramice od papira; indigo papir za umnožavače; prekrivači stolova od papira; spajalice; kancelarijski materijal i kancelarijski pribor, osim nameštaja; pergament; pastelne bojice [krede u boji]; postolja za fotografije; nalivpera; omoti za saksije od papira; aparati i mašine za umnožavanje dokumenata; papirne trake i kartice za beleženje kompjuterskih programa; prospekti; naliv pera i hemijske olovke [kancelarijski pribor]; vrećice [koverta, kese] od papira ili plastike, za pakovanje; školska oprema [sveske i pribor za pisanje]; markeri za knjige čestitke,

razglednice; lepak za papir ili upotrebu u domaćinstvu; lepljive trake za papir ili upotrebu u domaćinstvu; lepljive vrpce za papir ili upotrebu u domaćinstvu; kalendari; slikarske četkice; samolepljive trake za papir ili upotrebu u domaćinstvu; gumice [elastične trake] za kancelarije; portikle od papira; table od drvene pulpe[kancelarijske]; papir od pulpe, drvene mase papirne ili kartonske kutije; postolja za pera i olovke; ambalaža za flaše od papira ili kartona; podmetači za čaše od papira; plastična, mehurasta ambalaža za pakovanje ili umotavanje; lepak za kancelarijsku ili kućnu upotrebu; lepkovi za kancelarijsku ili upotrebu u domaćinstvu; noževi za papir [za otvaranje pisama]; vreće za đubre [od papira ili plastike]; zarezaci za olovke, elektronski i neelektronski; papirne maramice za uklanjanje šminke; stone salvete od papira; podmetači od papira; ugaonici za crtanje; T-lenjiri za crtanje; držači za olovke; nesereri sa priborom za pisanje; omotači za flaše od kartona ili papira; plakati od papira ili kartona; ubrusi od papira; ubrusi za lice od papira; etikete od papira ili kartona; viskozni papir za umotavanje, ukrasni papir; sredstva za lepljenje za papire ili upotrebu u domaćinstvu; vreće za mikrotalasno kuvanje; papirni filteri za kafu; plastična tanka rastegljiva folija za obavljanje paleta; natpisi od papira ili kartona; nalepnice [kancelarijski pribor]; papir za kopiranje; muzičke čestitke, razglednice bilteni; plastifikatori dokumenata za kancelarijsku upotrebu; brisači za table za pisanje; pločice sa hvataljkom za listove papira; papirne mašine, koje nisu pozamanterija i ukrasi za kosu; upijajuće folije od papira ili plastike za pakovanje hrane; folije od papira ili plastike za održavanje vlage za pakovanje hrane; korektorske trake [kancelarijski pribor]; posudice za boje; markeri [pisači pribor]; letci, flajeri; držači spisa, dokumenata [kancelarijski pribor]; držači stranica knjiga; papirni i kartonski materijali za pakovanje [punjenje, oblaganje]; ispuna od papira ili kartona; vaučeri; plastične kese za odlaganje životinjskog izmeta; vaši [japanski papir]; nadstolnjaci od papira; štampane muzičke partiture; transparenti [baneri] od papira; navlake za kartice sa imenom; jo jo držači kartica sa imenom [kancelarijski pribor]; kopče za navlake za kartice sa imenom [kancelarijski pribor]; portikle sa rukavima, papirne sekači papira [kancelarijski pribor]; šabloni za ukrašavanje hrane i napitaka; bedževi sa imenom [kancelarijski pribor]; trake za bar kodove šljokice za kancelarijsku upotrebu; maramice od papira za čišćenje.

Klasa 29: Kulinarske namene ekstrakti algi za ishranu želatin*; jestive masti; incuni, neživi; kikiriki puter; puter; kakao puter za ishranu; kokosov puter; puter krem; belance od jaja; kobasice krvavice; goveđa supa; goveđa supa, bujon; preparati za pravljenje bujona; kavijar; voće, konzervisano; suhomesnati proizvodi; čips od krompira; listići od krompira; kiseli kupus; kokos, osušeni; ulje repice za ishranu; repino ulje za ishranu; koncentracije za goveđu supu; koncentracije za bujon; džemovi; zaleđeno voće; supe; suvo grožđe; krastavčići; konzervisano povrće; kuvano povrće; sušeno povrće; ulja za ishranu; pavlaka [mlečni proizvod]; sir; smrznuto voće; kristalizovano voće; kroketi; ljuskari, koji nisu živi; urme; mleko; rak, koji nije živ; riblji fileti; sirište, sirilo; voće, kuvano; voćni žele; voćna pulpa; meso; riba, koja nije živa; žele za ishranu; žele od mesa; divljač, koja nije živa; đumbirov džem; konzervisana soja, za ishranu; masne supstance za proizvodnju jestive masti; smeše koje sadrže mast za kriške hleba; haringe, nežive; jastozi, koji nisu živi; kukuruzno ulje za ishranu; ulje palminih koštica za ishranu; susamovo ulje za ishranu; ostrige, koje nisu žive; riblji želatin za ishranu; šunka; žumance od jaja; jogurt; preparati za supu od povrća; sokovi od povrća za kuvanje; mesni ekstrakti; kefir [piće od mleka]; kumis [piće od mleka]; napici od mleka, u kojima mleko preovlađuje; surutka; proizvodi od mleka; bodljikavi jastog, koji nije živ; slanina; konzervisano sočivo; margarin; mermelada; životinjska moždina, srž, za ishranu; školjke, ljuskari, koji nisu živi; školjke, koje nisu žive; palmino ulje za ishranu; prerađen orah; jaja; jaja u prahu; jetrena pašteta; luk, konzervisan; masline, konzervisane; maslinovo ulje za ishranu; koštano ulje za ishranu; pektin za kulinarske namene; kiseli

krastavac; grašak, konzervirani; kobasice; usoljeno meso; sastojci za pripremanje supe; paradajz pire; salate od povrća; svinjska mast; salate od voća; sardine, nežive; losos, neživ; bubrežni loj za ishranu; tunjevina, neživa; sok od paradajza za kuvanje; suncokretovo ulje za ishranu; škembići; konzervisana gomoljika, tartuf živina, koja nije živa; kora od voća; alginati za kulinarske namene; mleveni badem; kikiriki, pripremljen; konzervisane pečurke; kokosova mast; kokosovo ulje za ishranu; konzervisan pasulj; jetra; namirnice na bazi ribe; voćni čips; školjke kapice, koja nisu žive; voće konzervisano u alkoholu; polen pripremljen kao hrana; škampi, račići, koji nisu živi; konzervisana riba; konzervisano meso; morski račići, koji nisu živi; jaja puževa za jelo; tofu; mućena pavlaka, šlag; svinjetina; jestiva ptičja gnezda; riba u konzervi; riblje brašno za ljudsku ishranu; voće u konzervi; meso u konzervi; uštipci, krofne od krompira; usoljena riba; morski krastavac, koji nije živ; čaure svilene bube za ljudsku ishranu; povrće u konzervi; panirane kobasice; pahuljice od krompira; pire od jabuka; kompot od brusnice; tahini [namaz od susama]; humus [namaz od leblebija]; morske (nori) alge, konzervisane; grickalice na bazi voća; kiselo mleko; kimči [jelo od fermentisanog povrća]; sojino mleko; milk šejk; ajvar [konzervisana paprika]; suncokretove semenke, pripremljene; riblji musevi; bezalkoholni punč od žumanaca; musevi od povrća; riblja ikra, pripremljena semenke, pripremljene*; aloe vera za ljudsku ishranu; konzervisan beli luk; proteinsko mleko; ulje od semena lana za ishranu; niskokalorični čips od krompira; niskokalorični hrskavi krompir; lecitin za kulinarske namene; mlečni fermenti za kulinarske namene; kompoti; kondenzovano mleko; smetana [kisela pavlaka]; raženka [fermentisano pečeno mleko]; fermentisano mleko; paradajz pire; pasta od povrća; pasta od plavog patlidžana; mleko od kikirikija za kulinarske svrhe; bademovo mleko za kulinarske svrhe; pirinčano mleko; artičoke, konzervirane; aranžmani od obrađenog voća; mleko u prahu*; jakitori [japanski ražnjići od piletine]; bulgogi [koreansko jelo od govedine]; kandirani orasi; začinjeno koštunjavo voće; začinjeni orasi; lešnici, pripremljeni; bobičasto voće, konzervirano; guakamol [pire od avokada]; prstenovi od luka [pohovani luk]; falafel; limunov sok za upotrebu u kulinarstvu; dehidrisano meso; zamrznuto-sušeno meso; liofilizovano meso; ovseno mleko; pavlaka [biljna] na bazi povrća; zamrznuto-sušeno povrće; liofilizovano povrće; dehidrisano povrće; ekstra devičansko maslinovo ulje za ishranu; galbi [jelo od grilovanog mesa]; eskamol [jestive larve mrava]; jestivi insekti, neživi; kukuruz šećerac, prerađen; namazi na bazi orašastih plodova; knedle na bazi krompira; viršle; viršle u kukuruznom testu na štapiću; sojino ulje za ishranu; zamene za mleko; bademovo mleko; mleko od kikirikija; kokosovo mleko; kokosovo mleko za kulinarsku upotrebu; napici na bazi kokosovog mleka; pirinčano mleko za kulinarsku upotrebu; napici na bazi bademovog mleka; napici na bazi mleka od kikirikija; creva za kobasice, prirodna ili veštačka; usoljen i sušeni bakalar; uštipci od svežeg sira; presovana voćna pasta; juba [tofu listići]; pljeskavice od soje; tofu pljeskavice; tadžin [gotovo jelo od mesa, ribe ili povrća];

Klasa 30: Alge [začin]; testenina; bademovo testo; seme anisa; seme zvezdastog anisa; konditorski proizvodi za ukrašavanje novogodišnje jelke; nemedicinski biljni čajevi; arome za kafu; aromatični dodaci za hranu; dodaci jelima; hleb bez kvasca; soli za konzervisanje namirnica; dvopek; biskviti, suvi kolačići keks; sladni biskviti; slatkiši od pepermint; slatkiši [bombone]; vafel proizvodi; slatke zemičke, kolačići kakao; kafa; nepržena kafa; biljni preparati za upotrebu kao zamena za kafu; kolači; cimet [začin]; kapra; karamele [bombone]; kari [začin]; preparati od žitarica; žvakaća guma*; cikorijska [zamena za kafu]; čaj; čokolada; marcipan; karanfilić [začin]; začinski dodaci; slatkiši; slatkiši od šećera; kornfleks; kukuruzne pahuljice; kokice; preparati za učvršćivanje mućene pavlake, šlaga; sladoled; palačinke; esencije za ishranu, izuzev etarskih esencija i etarskih ulja; kuhinjska so; dodaci za zgušnjavanje hrane za kuvanje; kurkuma*; prirodni zaslađivači; začini; kolačići od đumbira;

piment; brašno*; brašno od boba; kukuruzno brašno; kukuruzno brašno, krupno brašno od slačice; ječmeno brašno; sojino brašno; pšenično brašno; skrob za jelo; fermenti za testo; fondani [slatkiši]; sitni kolači; šećer*; arome za kolače, izuzev etarskih ulja; prašak za kolače; testo za kolače; đumbir [začin]; vezivni agensi za sladoled; led, prirodni ili veštački; led za osvežavanje; glukoza za kulinarsku namenu; gluten pripremljen kao hrana; prekrupa za ljudsku ishranu; sirće; kečap [sos]; kakao; napici sa mlekom; pića od kafe sa mlekom; pića od čokolade sa mlekom; sredstva za podizanje testa; kvasac; materijali za vezivanje kobasica; kolačići od badema [slatka peciva]; makaroni; mleveni kukuruz; kukuruz, mleveni kukuruz, prženi kukuruz; hleb*; maltoza; melasa za ishranu; zlatni sirup [šećerni sirup], melasa; mentol za poslastice; med; oljušteni ječam; senf; oraščići rezanci; tanki rezanci; pite; mleveni ječam; sendviči; pastile [bombone]; peciva; peti-ber keks; vekne hleba; začinska paprika; pice; biber; brašno od krompira*; puding; praline; ravioli; slatki koren [slatkiši]; pirinač šafran [začin]; sago; sosovi [dodaci hrani]; celerova so; griz; šerbet [zaleđeni]; sorbei [ledeni]; špageti; tapioka; brašno tapioke*; tart [slatka pita bez gornje kore]; aroma vanile za kulinarske namene; vanilin [zamena za vanilu]; rezanci za supu; pite od mesa; vekna sa mesom; sredstva za omekšavanje mesa za upotrebu u domaćinstvu; sladoledi; prašak za pravljenje sladoleda; slatkiši od badema; poslastice od kikirikija; arome, koje nisu etarska ulja; arome za pića, izuzev etarskih ulja; mleveni ovas; oljušteni ovas; hrana na bazi ovsa; ovsene pahuljice; ovseno brašno; štapovi od slatkog korenja [poslastica]; pivsko sirće; pića na bazi kafe; pića na bazi kakaoa; pića na bazi čokolade; zamene za kafu; bombone*; čips [proizvod od žitarica]; čau-čau [začin]; kus-kus [griz]; sladni ekstrakti za hranu; slad za ljudsku ishranu; propolis [pčelinji proizvod]*; propolis; reliš [dodatak jelu]; matični mleč*; morska voda za kuvanje; suši; umak od paradajza; majonez; krekeri; engleski krem; voćni žele [slatkiši]; musli; kolači od pirinča; umak, sos od soje; smrznuti jogurt [poslastičarski]; čatni [dodatak jelima]; prolećne rolnice; tako tortilje; ledeni čaj; napici od čaja; prelive za salatu; hlebne mrvice; tabule, libanska salata; alva; kiš; sosovi za meso [umaci]; pasta od soje [dodatak jelima]; miso [dodatak jelima]; grickalice na bazi žitarica; grickalice na bazi pirinča; suva zrna kukuruza bez ljuske; kukuruzni griz; prašak za pecivo; bikarbona soda za kuvanje; soda bikarbona za kuvanje; konzervisane baštenske trave [začini]; gotovi obroci od rezanaca; glazure za kolače; čokoladni musevi; deserti u obliku musa [slatkiši]; voćni prelive [sosovi]; marinade; sendviči sa sirom [čizburgeri]; pesto [sos]; glazure za šunku; seme lana za kulinarsku upotrebu [začin]; laneno seme za kulinarsku upotrebu [začin]; pšenične klice za ljudsku ishranu; visokoproteinske pločice od žitarica; tartar krem za kuvanje; glutenski dodaci za kulinarske namene; sosovi za testenine; pločice od žitarica; palmin šećer; testo, poluprerađen proizvod; cvetovi ili lišće kao zamena za čaj; testo za slatka peciva; vareniki [punjene knedle]; peljmeni [knedle punjene mesom]; čokoladni ukrasi za torte; ukrasne bombone za torte; koštunjavo voće sa čokoladnim prelivom; sutlijaš; koštunjavo voće u prahu; beli luk u prahu [začin]; baozi [testo sa nadevom]; pirinčana kaša za kulinarske namene; jiaozi [punjene knedle]; ramen [japansko jelo na bazi rezanaca]; okonomijaki [japanske pikantne palačinke]; smese za okonomijaki [japanske pikantne palačinke]; buritosi; gimhap [koreansko jelo od pirinča]; jestivi papir; jestivi papir od pirinča; namazi na bazi čokolade; čokoladni namazi koji sadrže orašaste plodove; knedle na bazi brašna sirup od agave [prirodni zaslađivač]; staklene glazure; dehidrisana jela čiji je glavni sastojak pirinač; liofilizovana jela čiji je glavni sastojak pirinač; zamrznuta-sušena jela čiji je glavni sastojak pirinač; zamrznuta-sušena jela čiji je glavni sastojak testenina; liofilizovana jela čiji je glavni sastojak testenina; dehidrisana jela čiji je glavni sastojak testenina; napici na bazi kamilice; mlečni karamel krem; bibimbap [mešavina pirinča sa povrćem i junetinom]; onigiri [pirinčane kuglice]; instant pirinač sendvič sa

viršlama; kocke leda; prerađeno seme za upotrebu kao začin; susamovo seme [začin]; pikalili; kinoa, prerađena; bulgur; heljda, prerađena brašno od heljde; sos od brusnice [začin]; sos od jabuka [začin]; krutoni; lomper [palačinke na bazi krompira]; zefir [poslastica]; pastila [poslastica]; senbei [pirinčani krekeri]; kimči [palačinke od ukiseljenog povrća]; strugani led sa zaslađenim crvenim pasuljem; mentol bombone za osvežavanje daha; žvakaće gume za osvežavanje daha; udon rezanci soba rezanci.

Klasa 31: Agrumi [južno voće], sveži; alge, neprerađene, za ljudsku ili životinjsku ishranu; morske alge, neprerađene, za ljudsku ili životinjsku ishranu; orašasto voće; životinjska menadžerija; žive životinje; hrana za životinje; drveće; Božićne jelke*; stabla drveća; žbunje; ovas [zob]; bobičasto voće, sveže; so za stoku; repa, sveža; mekinje; trupci; kokosov orah, sirov; šećerna trska; rogač, sirov; seme žitarica, neprerađeno; gljive, sveže; uljaste pogače; stočne pogače; kesten, svež; kreč za životinjsku ishranu; koren cikorije; cikorija, sveža; biskviti za pse; limun, svež; ljuska kokosovog oraha; kokos; hrana za ptice; pogača od uljane repice za stoku; krastavci, sveži; hmeljne šišarke; kaša od mekinja za ishranu životinja; kopra; školjke [žive] sveže; povrće bundeve, sveže; venci od prirodnog cveća; jaja za uzgoj, oplođena; pomije; uzgajana stoka; preparati za tovljenje životinja; brašno od pirinča za stočnu ishranu; pasulj, svež; cveće, prirodno; cveće, za dekoraciju, osušeno; polen [sirovina]; seno; hrana za jačanje životinja; hrana za stoku; stočna hrana; pšenica voće, sveže; travnjaci, prirodni; trava, prirodna; smrekine bobice; semenske klice za botaničke svrhe; zrnevlje [žitarice]; seme za životinjsku konzumaciju; seme za sadnju; semenje; zobena krupica za živinu; baštenska trava, sveža biljke; sadnice; hmelj; orah biljke kole; zelena salata, sveža; sočivo, sveže; kvasac za ishranu životinja; pluta, sirova; laneno brašno [stočna hrana]; kukuruz; kukuruzna stočna pogača; slad za vrenje i destilaciju komina; ostaci voća [komina]; lešnik, svež; brašno za životinje; riblja ikra; jaja svilene bube; lukovice; cvetne lukovice; crni luk, svež; masline, sveže; pomorandže, sveže; ječam; kopriva; sipina kost za ptice; slamene prostirke; slama [stočna hrana]; palme [lišće palminog drveta]; stabla palme; kaša za tovljenje stoke; riba, živa; vinova loza; borova šišarka; biber [biljka]; biljke, sušene, za dekoraciju; praziluk, svež; grašak, svež; krompir, svež; preparati za živinu; nosilje; stajska hrana za životinje; korenje za ishranu životinja; grožđe, sveže; rabarbara, sveža; žbunovi ruža; raž; svilena buba; jestiv susam, neprerađen; tartufi, sveži; talog nakon destilacije; živina, živa; algarovila za životinjsku ishranu; badem [voće]; kikiriki, svež; brašno od kikirikija za životinje; pogače od kikirikija za životinje; nus-proizvodi prerade žitarica za ishranu životinja; ostaci nakon prerade šećerne trske [sirovina]; mamci za pecanje, živi; rakovi, živi; ljuskari, živi; jastozi, živi; dagnje, žive; ostrige, žive; hrana za kućne ljubimce; sirova kora drveta; jastozi obični [živi]; hrana za preživljanje za životinje; napitci za kućne ljubimce; riblje brašno za životinjsku ishranu; pirinač, neprerađen; morski krastavci [živi]; papir sa peskom [prostirka] za kućne ljubimce; mirisni pesak [prostirka] za kućne ljubimce; aloe vera biljke; spanać, svež; laneno seme za ishranu životinja; seme lana za ishranu životinja; brašno od semena lana za ishranu životinja; laneno brašno za ishranu životinja; pšenične klice za ishranu životinja; artičoke, sveže; haringa, živa; losos, živ; sardine, žive; tuna, živa; beli luk, svež; tikvice, sveže; jestivo seme lana, neprerađeno; jestive semenke lana, neprerađene; aranžmani od svežeg voća; incuni, živi; jestivi insekti, živi; neprerađeni klipovi kukuruza šećerca [oljušteni ili neoljušteni]; kinoa, neprerađena; heljda, neprerađena; koi šarani, živi.

Klasa 32: Bezalkoholni voćni ekstrakti; pivo; ale pivo od đumbira; pivo od đumbira; sladno pivo; pivski slad; bezalkoholni voćni napici; pića od surutke; bezalkoholni pripravci za pravljenje napitaka; koncentracije za pravljenje napitaka; voćni sokovi; sirupi za pića vode [pića]; preparati za pravljenje gazirane vode; litijum voda; mineralna voda [piće]; Seltzer voda; stone vode šira limunade; ekstrakti hmelja za proizvodnju piva; sokovi od povrća

[pića]; sirupi za limunade; sladovina šira [nefermentisana]; bademov sirup; soda voda; šerbeti [pića]; sok od paradajza [piće]; bezalkoholna pića; pilule za gaziranje pića; praškovi za gaziranje pića; gazirana voda; sarsaparila [bezalkoholni napitak]; aperitivi, bezalkoholni; kokteli, bezalkoholni; voćni nektar [bezalkoholni]; izotonici; sok od jabuke, bezalkoholni; kvas [bezalkoholni napitak]; bezalkoholni napici na bazi meda; smutis [kašasti napici od voća ili povrća]; bezalkoholna pića od aloe vera; kokteli na bazi piva; napici od soje, osim zamena za mleko; napici za sportiste obogaćeni proteinima; napici na bazi pirinča, koji nisu zamena za mleko; bezalkoholni napici sa ukusom kafe; bezalkoholni napici sa ukusom čaja; osvežavajuća bezalkoholna pića; ječmeno vino [pivo]; energetska pića.

Klasa 33: Liker od peperminta; voćni ekstrakti, alkoholni; biteri [gorka alkoholna pića]; liker od anisa; aniset [liker]; aperitivi; arak; destilovana pića; jabukovača; kokteli; kurakao; digestivi [likeri i žestoka pića]; vino; džin; likeri; medovina; kiršć, višnjevača; žestoka pića; brendi; piket; kruškovača; sake; viski; alkoholna esencije; alkoholni ekstrakti; alkoholna pića, izuzev piva; alkoholna pića koja sadrže voće; alkohol od pirinča; rum; vodka; pomešana alkoholna pića, koja nisu na bazi piva; nira [alkoholno piće na bazi šećerne trske]; baijiu [kinesko piće od destilovanog alkohola].

Klasa 35: Pomoć u poslovnom upravljanju; obaveštenja o poslovima reklamiranje preko plakata; usluge agencija za uvoz i izvoz; usluge agencija za pružanje poslovnih informacija; analize cena i troškova; distribucija reklamnog materijala; računovodstvo; vođenje knjiga [knjigovodstvo]; revizija poslovanja; poslovno upravljanje i organizaciono savetovanje; konsultacije u poslovnom upravljanju; prezentacija robe; pomoć u poslovnom ili industrijskom upravljanju; ažuriranje oglasnih materijala; distribucija uzoraka; stručne usluge o poslovnoj efikasnosti; istraživanje tržišta; poslovne procene; poslovna ispitivanja; iznajmljivanje oglasnih materijala; konsultacije u vezi sa poslovnim organizovanjem; objavljivanje reklamnih tekstova; oglašavanje; reklamiranje; reklamiranje na radiju; poslovna istraživanja; usluge odnosa sa javnošću; reklamiranje preko televizije; prepisivanje korespondencije [kancelarijske usluge]; uređivanje izloga; usluge reklamnih agencija; savetodavne usluge u poslovnom upravljanju; marketinška istraživanja; kompjutersko upravljanje podacima; profesionalne poslovne konsultacije; organizovanje izložbi za privredne ili reklamne potrebe; poslovne informacije; ispitivanje javnog mnjenja; priprema platnih listi; pronalaženje osoblja; iznajmljivanje oglasnog prostora; obračun poreza; prikupljanje informacija u kompjuterske baze podataka; sistemacija informacija u kompjuterskim bazama podataka; organizovanje sajмова u komercijalne ili reklamne svrhe; onlajn reklamiranje na računarskoj mreži; usluge nabavke za treća lica [kupovina proizvoda i usluga za druge poslovne subjekte]; psihološko testiranje za izbor zaposlenih; usluge poređenja cena; prezentacija proizvoda putem sredstava komunikacije, u svrhu prodaje na malo; pružanje komercijalnih saveta i informacija potrošačima pri izboru roba i usluga; dogovaranje pretplate za usluge telekomunikacija za treća lica; administrativna obrada narudžbenica za kupovinu; komercijalna administracija za licence roba i usluga trećih lica; usluge podugovaranja, autsorsing [pomoć u poslovanju]; fakturisanje; pisanje reklamnih tekstova; prikupljanje statističkih podataka; marketing; usluge maloprodaje farmaceutskih, veterinarskih i higijenskih preparata i medicinskog materijala; iznajmljivanje prodajnih štandova; pružanje komercijalnih i poslovnih kontakt informacija; optimizacija pretraživača za promociju prodaje; optimizacija saobraćaja sa Internet stranice; usluge posredovanja u trgovini; pružanje poslovnih informacija putem Internet stranice; obezbeđivanje onlajn tržišta za kupce i prodavce roba i usluga; dizajniranje reklamnog materijala; angažovanje spoljnih firmi za administrativno upravljanje kompanijama; usluge prijavljivanja poreza; poslovno upravljanje programima za nadoknadu za druge; iznajmljivanje bilborda [panoa za

reklamiranje]; usluge zakazivanja sastanaka [kancelarijske usluge]; upravljanje programima lojalnosti potrošača; pisanje tekstova za reklamne namene; registrovanje pisane komunikacije i podataka ažuriranje i održavanje; informacija u registrima; sastavljanje popisa informacija za komercijalne i reklamne svrhe; poslovno upravljanje za nezavisne pružaoce usluga; pregovaranje i zaključivanje poslovnih transakcija za treća lica; usluge poslovnog posredovanja koje se odnose na povezivanje potencijalnih privatnih ulagača sa preduzetnicima kojima su potrebna finansijska sredstva; promocija robe i usluga kroz sponzorisanje sporskih događaja; usluge praćenja konkurencije; usluge praćenja tržišta; finansijska revizija; ciljni marketing; oglašavanje na otvorenom; usluge odnosa sa medijima usluge korporativne komunikacije; iznajmljivanje kancelarijske opreme u zajedničkim radnim prostorima; usluge komercijalnog lobiranja.

Klasa 43: Usluge agencija za smeštaj [hotelski, pansionski]; katering hrane i pića; usluge kafea; usluge kafeterija; usluge kantina; iznajmljivanje privremenog smeštaja; pansionske usluge; usluge restorana; usluge restorana za samoposluživanje; usluge snek-barova; usluge barova; iznajmljivanje stolova, stolica, stolnjaka i staklenog posuđa; iznajmljivanje prostorija za sastanke; iznajmljivanje aparata za kuvanje; iznajmljivanje automata za vodu za piće; iznajmljivanje aparata za osvetljenje*; pravljenje skulptura od hrane; usluge vašoku restorana; usluge udon i soba restorana; dekorisanje hrane; dekorisanje kolača; informacije i saveti u vezi sa pripremanjem obroka; usluge ličnog šefa kuhinje.

(111) **14966**

(151) 30.10.2020.

(210) Ž-2019-356

(220) 16.09.2019.

(732) The Coca-Cola Company, One Coca-Cola Plaza, 30313, Atlanta, Georgia, US

(540)



(550) I

(740) Miladin Popović, ul. Capital Plaza, ulica šeika Zajeda 13-IV/68, 81000, Podgorica

(511) Klasa 32: Pića, uključujući vode za piće, vode sa ukusom, mineralne i gazirane vode; ostala bezalkoholna pića, uključujući osvježavajuća bezalkoholna pića, energetska pića i pića za sportiste; voćni napici i sokovi uključujući kokosovu vodu; sirupi, koncentрати, praškovi i drugi preparati za pripremu pića, uključujući vode sa ukusom, mineralne i gazirane vode, osvježavajuća bezalkoholna pića, energetska pića, pića za sportiste, voćne napitke i sokove; napici i sokovi od povrća.

(111) **14960**

(151) 30.10.2020.

(210) Ž-2019-427

(220) 05.11.2019.

(732) Domaća trgovina doo Podgorica, Ul.Josipa Broza Tita br.23a, 81000, Podgorica, ME

(540)

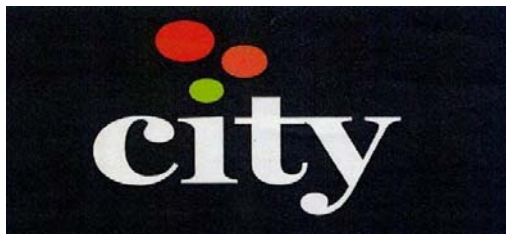

(550) I

(740) Goran Živković, ul. Petra Zvicera br.11, Podgorica

(511) Klasa 3: Bademovo ulje; bademov sapun; štirak za sjaj veša; štirak za pranje veša; štirak za veš; sapun*; sapun za izbeljivanje tekstila; plavilo za veš; etarsko ulje anisa; kozmetički preparati za kupanje sapun za brijanje; vatirani štapići za kozmetičke svrhe; pamučni štapići za kozmetičku upotrebu; kozmetičke maske; bergamot ulje; soli za izbeljivanje soda za izbeljivanje belila za veš; mirišljivo drvo; preparati za ispiranje usta, koji nisu medicinski; lak za nokte; preparati za šminkanje; losioni za kosu*; kreme za cipele; boje za kosu; preparati za kovrdžanje kose; preparati za čišćenje, poliranje; preparati za poliranje; vosak za cipele; sredstva za poliranje nameštaja i podova; preparati za sjaj [poliri]; obućarski vosak; vosak za parket; vosak za poliranje; etarska ulja limuna; kolonjska voda; boje za toaletnu upotrebu; preparati za zaštitu kože [poliranje]; preparati za očuvanje kože [poliranje]; kozmetički setovi; kozmetika; pamučna vuna za kozmetičku upotrebu; kreda za čišćenje; preparati za uklanjanje mrlja; kozmetičke olovke; kreme za poliranje; kozmetičke kreme; soda za pranje, čišćenje; paste za brijanje; kreme za kožne proizvode; vosak za kožne proizvode; deterdženti, koji nisu za upotrebu u proizvodnim procesima i za medicinsku upotrebu; rastvori za čišćenje; proizvodi za odmašćivanje, koji nisu za upotrebu u procesu proizvodnje; preparati za uklanjanje šminke sredstva za čišćenje zuba [paste, gelovi, tečnosti]*; preparati za uklanjanje kamenca za upotrebu u domaćinstvu; dijamantin, boraks [arbaziv] antistatički preparati za kućnu upotrebu; preparati za uklanjanje laka;

preparati za uklanjanje boje odstranjivači laka; mirišljave vode; toaletne vode; preparati za depilaciju; vosak za depilaciju; preparati za natapanje u perionicama; etarske esencije; etarska ulja; etarska ulja; ekstrakti cveća [parfemi]; šminka; preparati za čišćenje; baze za cvetne parfeme; fumigacijska sredstva [parfemi]; arome za kolače [etarska ulja]; ulja za kozmetičku upotrebu; jasminovo ulje; ulje od lavande; ulja za čišćenje; ulja za parfeme i mirise; ružino ulje; toaletna ulja; losioni za kozmetičku upotrebu; mleko za čišćenje za toaletnu upotrebu; preparati za pranje; toaletni proizvodi [sredstva za ličnu higijenu]*; preparati za štirkanje; mirisna menta [etarsko ulje]; menta za parfimerijske proizvode kozmetika za obrve; šamponi*; parfemi; preparati za negu noktiju; parfimerija; kozmetički preparati za negu kože; sapun protiv znojenja nogu; kamen za poliranje; pomade za kozmetičku upotrebu; puder za šminkanje; preparati za brijanje; dezodorantni sapun; kesice sa mirisom za rublje; safrol; komadi toaletnog sapuna; komadi sapuna; olovke za izvlačenje obrva; talk puder, za toaletnu upotrebu; kozmetičke boje; krpe za poliranje; stakleno platno [abrazivno platno]; preparati protiv znojenja; sapun protiv znojenja; tripoli kamen za poliranje; abrazivi; bademovo mleko za kozmetičku upotrebu; preparati za uklanjanje rđe; preparati za sunčanje [kozmetički]; aromatična ulja [etarska ulja]; arome za pića [etarska ulja]; hemikalije za osvežavanje boja za upotrebu u domaćinstvu [pranje veša]; soli za kupanje koje nisu za medicinsku upotrebu; kozmetički preparati; preparati za uklanjanje boja; dezodoransi za ljude ili životinje; dekorativne nalepnice za kozmetičku upotrebu; astringentna sredstva; preparati za beljenje [skidanje boje] za kozmetičku upotrebu; oplemenjivači rublja za upotrebu u perionicama; preparati za otčepljivanje odvodnih cevi; šamponi za kućne ljubimce [nemedicinski preparati za negu]; maramice natopljene sa kozmetičkim losionima; sredstva za lepljenje za kozmetičku upotrebu; losioni posle brijanja; lakovi za kosu; maskare; potpuri [mirisi]; sprejevi za osvežavanje daha; preparati za hemijsko čišćenje; odstranjivači voska sa poda [sredstva za odstranjivanje]; neklizajući vosak za podove; neklizajuće tečnosti za podove; vazduh konzerviran pod pritiskom, za čišćenje i uklanjanje prašine; gelovi za izbeljivanje zuba; krpe namočene deterdžentom za čišćenje; preparati za sjaj; lišća biljaka; mirisni štapići; sredstva za sušenje sudova u mašinama za sudove; preparati za parfimisanje vazduha; trake za osvežavanje daha; dezodoransi za kućne ljubimce; preparati za tuširanje za ličnu higijenu i dezodorisanje [toaletni proizvodi]; preparati od aloe vere za kozmetičke namene; sjajevi za usne; balzami, osim za medicinske svrhe; šamponi za suvo pranje*; preparati za sunčanje; etarsko ulje limuna kana [kozmetička boja]; sredstva za čišćenje obuće; preparati za kupanje, ne za medicinske svrhe; balzami za kosu; proizvodi za ispravljanje kose; maramice natopljene preparatima za skidanje šminke; preparati kolagena za kozmetičke svrhe; trake za izbeljivanje zuba; arome za hranu [etarska ulja]; fitokozmetički preparati; sredstva za čišćenje za intimnu ličnu higijenu, nemedicinska; biljni ekstrakti za kozmetičke namene; sredstva za odstranjivanje laka za nokte; sredstva za uklanjanje laka za nokte; vosak za podove; šamponi za životinje [nemedicinski preparati za negu]; sredstva za ispiranje očiju, ne za medicinske namene; sredstva za vaginalno ispiranje za ličnu higijenu ili dezodorisanje; hemijski preparati za čišćenje za upotrebu u domaćinstvu; raspršivači od trske za osvežavanje vazduha; preparati za beljenje [uklanjanje boja] za upotrebu u domaćinstvu; kozmetika za decu; preparati za osvežavanje daha za ličnu higijenu; maramice za bebe natopljene preparatima za čišćenje; basma [kozmetička boja]; gel jastučići za oči za kozmetičke namene.

Klasa 16: Nosači lepljivih traka [kancelarijski pribor]; papir; posteri; oglasni panoi od papira ili kartona; spajalice [kancelarijski pribor]; klipse za olovke heftalice [kancelarijski rekvizit]; beležnice, notesi; albumi; slike; štampani materijal [viskoka štampa]; trake za cigare, za

uvijanje cigareta; mašine za oštrenje olovaka, elektronske ili neelektronske podupirači za knjige; vodene boje [slikarske]; vodene boje, slikarske; akvarel boje; fascikle za spise [kancelarijski pribor]; tablice za pisanje; pisaljke za tablice; srebrni papir; olovke; novine; periodične publikacije; atlas; uložne mape sa prstenovima; registratori sa prstenovima; gumirane trake [kancelarijski materijal]; podmetači za pivske čaše; ulaznice; kliše; blokovi za crtanje blokovi [kancelarijski materijal]; klemi za trake sa mastilom; manžetne za držanje pribora za pisanje; pamfleti; špenadle kao kancelarijski materijal; čiode kao kancelarijski materijal; ovlaživači vrhova prstiju [kancelarijski pribor]; jastučići za mastilo; vosak za pečačenje; sveske; obrasci za precrtavanje; paus papir; štamparska slova; karbon papir; papir za mašine za snimanje; beležnice; ugaoni lenjiri za crtanje; karte; materijal za obuku [izuzev aparata]; listovi papira [kancelarijski] karton; tube od kartona; katalozi; metalni vrh za indeksne karte; spojeni ramovi [štamparski]; omoti za papir; košuljice za spise; brojevi [štamparski]; indijsko mastilo; fascikle [kancelarijski materijal]; bušilice za papir [zumba]; higijenski papir; toalet papir; knjige; šestari za crtanje; štamparski brojevi i slova; slova, štamparska; kompozeri za slaganje; posude za pisma; konusne papirne kese; korektivna tečnost [kancelarijski rekvizit]; korektivno mastilo [heliografsko]; grafitne mine za olovke; kreda za pisanje; držači olovaka; olovke sa grafitnom minom [tehničke olovke]; papirne kutije za krem; table za crtanje; materijali za crtanje; instrumenti za crtanje; kutije za olovke; proizvodi za brisanje; materijali za pisanje; štitnici za brisanje; gumice za brisanje; elektrokardiografski papir; probadači [kancelarijski materijal]; mastilo; mastiljave trake; fotografije [štampane]; brisači za naliv pera; pečati; knjigovodstvene knjige; indeks registri; formulari [štampani]; kancelarijski materijal, izuzev nameštaja; štampani rokovnici; ovlaživači za lepljenje koverti [kancelarijski rekviziti]; dopisnice, razglednice; štampane stvari; pribor za ručno lepljenje nalepnica; štampane publikacije priručnici; papir za pisanje; pritiskači za papir; igle za kopiranje za crtačke svrhe; olovke za crtanje; stolnjaci od papira; knjižice; svetleći papir; pelir papir za kopije [kancelarijski materijal]; maramice od papira; indigo papir za umnožavače; prekrivači stolova od papira; spjalice; kancelarijski materijal i kancelarijski pribor, osim nameštaja; pergament; pastelne bojice [krede u boji]; postolja za fotografije; nalivpera; omoti za saksije od papira; aparati i mašine za umnožavanje dokumenata; papirne trake i kartice za beleženje kompjuterskih programa; prospekti; naliv pera i hemijske olovke [kancelarijski pribor]; vrećice [koverta, kese] od papira ili plastike, za pakovanje; školska oprema [sveske i pribor za pisanje]; markeri za knjige čestitke, razglednice; lepak za papir ili upotrebu u domaćinstvu; lepljive trake za papir ili upotrebu u domaćinstvu; lepljive vrpce za papir ili upotrebu u domaćinstvu; kalendari; slikarske četkice; samolepljive trake za papir ili upotrebu u domaćinstvu; gumice [elastične trake] za kancelarije; portikle od papira; table od drvene pulpe [kancelarijske]; papir od pulpe, drvene mase papirne ili kartonske kutije; postolja za pera i olovke; ambalaža za flaše od papira ili kartona; podmetači za čaše od papira; plastična, mehurasta ambalaža za pakovanje ili umotavanje; lepak za kancelarijsku ili kućnu upotrebu; lepkovi za kancelarijsku ili upotrebu u domaćinstvu; noževi za papir [za otvaranje pisama]; vreće za đubre [od papira ili plastike]; zarezaci za olovke, elektronski i neelektronski; papirne maramice za uklanjanje šminke; stone salvete od papira; podmetači od papira; ugaonici za crtanje; T-lenjiri za crtanje; držači za olovke; nesereri sa priborom za pisanje; omotači za flaše od kartona ili papira; plakati od papira ili kartona; ubrusi od papira; ubrusi za lice od papira; etikete od papira ili kartona; viskozni papir za umotavanje, ukrasni papir; sredstva za lepljenje za papire ili upotrebu u domaćinstvu; vreće za mikrotalasno kvanje; papirni filteri za kafu; plastična tanka rastegljiva folija za obavijanje paleta; natpisi od papira ili kartona; nalepnice [kancelarijski pribor]; papir za kopiranje; muzičke čestitke, razglednice bilteni; plastifikatori dokumenata

za kancelarijsku upotrebu; brisači za table za pisanje; pločice sa hvataljkom za listove papira; papirne mašne, koje nisu pozamanterija i ukrasi za kosu; upijajuće folije od papira ili plastike za pakovanje hrane; folije od papira ili plastike za održavanje vlage za pakovanje hrane; korektorske trake [kancelarijski pribor]; posudice za boje; markeri [pisači pribor]; letci, flajeri; držači spisa, dokumenata [kancelarijski pribor]; držači stranica knjiga; papirni i kartonski materijali za pakovanje [punjenje, oblaganje]; ispuna od papira ili kartona; vaučeri; plastične kese za odlaganje životinjskog izmeta; vaši [japanski papir]; nadstolnjaci od papira; štampane muzičke partiture; transparenti [baneri] od papira; navlake za kartice sa imenom; jo jo držači kartica sa imenom [kancelarijski pribor]; kopče za navlake za kartice sa imenom [kancelarijski pribor]; portikle sa rukavima, papirne sekači papira [kancelarijski pribor]; šabloni za ukrašavanje hrane i napitaka; bedževi sa imenom [kancelarijski pribor]; trake za bar kodove šljokice za kancelarijsku upotrebu; maramice od papira za čišćenje.

Klasa 29: Kulinarske namene ekstrakti algi za ishranu želatin*; jestive masti; incuni, neživi; kikiriki puter; puter; kakao puter za ishranu; kokosov puter; puter krem; belance od jaja; kobasice krvavice; goveđa supa; goveđa supa, bujon; preparati za pravljenje bujona; kavijar; voće, konzervisano; suhomesnati proizvodi; čips od krompira; listići od krompira; kiseli kupus; kokos, osušeni; ulje repice za ishranu; repino ulje za ishranu; koncentracije za goveđu supu; koncentracije za bujon; džemovi; zaleđeno voće; supe; suvo grožđe; krastavčići; konzervisano povrće; kuvano povrće; sušeno povrće; ulja za ishranu; pavlaka [mlečni proizvod]; sir; smrznuto voće; kristalizovano voće; kroketi; ljuskari, koji nisu živi; urme; mleko; rak, koji nije živ; riblji fileti; sirište, sirilo; voće, kuvano; voćni žele; voćna pulpa; meso; riba, koja nije živa; žele za ishranu; žele od mesa; divljač, koja nije živa; đumbirov džem; konzervisana soja, za ishranu; masne supstance za proizvodnju jestive masti; smeše koje sadrže mast za kriške hleba; haringe, nežive; jastozi, koji nisu živi; kukuruzno ulje za ishranu; ulje palminih koštica za ishranu; susamovo ulje za ishranu; ostrige, koje nisu žive; riblji želatin za ishranu; šunka; žumance od jaja; jogurt; preparati za supu od povrća; sokovi od povrća za kuvanje; mesni ekstrakti; kefir [piće od mleka]; kumis [piće od mleka]; napici od mleka, u kojima mleko preovlađuje; surutka; proizvodi od mleka; bodljikavi jastog, koji nije živ; slanina; konzervisano sočivo; margarin; mermelada; životinjska moždina, srž, za ishranu; školjke, ljuskari, koji nisu živi; školjke, koje nisu žive; palmino ulje za ishranu; prerađen orah; jaja; jaja u prahu; jetrena pašteta; luk, konzervisan; masline, konzervisane; maslinovo ulje za ishranu; koštano ulje za ishranu; pektin za kulinarske namene; kiseli krastavac; grašak, konzervirani; kobasice; usoljeno meso; sastojci za pripremanje supe; paradajz pire; salate od povrća; svinjska mast; salate od voća; sardine, nežive; losos, neživ; bubrežni loj za ishranu; tunjevina, neživa; sok od paradajza za kuvanje; suncokretovo ulje za ishranu; škembići; konzervisana gomoljika, tartuf živina, koja nije živa; kora od voća; alginati za kulinarske namene; mleveni badem; kikiriki, pripremljen; konzervisane pečurke; kokosova mast; kokosovo ulje za ishranu; konzervisan pasulj; jetra; namirnice na bazi ribe; voćni čips; školjke kapice, koja nisu žive; voće konzervisano u alkoholu; polen pripremljen kao hrana; škampi, račići, koji nisu živi; konzervisana riba; konzervisano meso; morski račići, koji nisu živi; jaja puževa za jelo; tofu; mućena pavlaka, šlag; svinjetina; jestiva ptičja gnezda; riba u konzervi; riblje brašno za ljudsku ishranu; voće u konzervi; meso u konzervi; uštipci, krofne od krompira; usoljena riba; morski krastavac, koji nije živ; čaure svilene bube za ljudsku ishranu; povrće u konzervi; panirane kobasice; pahuljice od krompira; pire od jabuka; kompot od brusnice; tahini [namaz od susama]; humus [namaz od leblebija]; morske (nori) alge, konzervisane; grickalice na bazi voća; kiselo mleko; kimči [jelo od fermentisanog povrća]; sojino mleko; milk šejk; ajvar [konzervisana paprika]; suncokretove semenke, pripremljene; riblji musevi; bezalkoholni punč od žumanaca; musevi od povrća; riblja ikra,

pripremljena semenke, pripremljene*; aloe vera za ljudsku ishranu; konzervisan beli luk; proteinsko mleko; ulje od semena lana za ishranu; niskokalorični čips od krompira; niskokalorični hrskavi krompir; lecitin za kulinarske namene; mlečni fermenti za kulinarske namene; kompoti; kondenzovano mleko; smetana [kisela pavlaka]; raženka [fermentisano pečeno mleko]; fermentisano mleko; paradajz pire; pasta od povrća; pasta od plavog patlidžana; mleko od kikirikija za kulinarske svrhe; bademovo mleko za kulinarske svrhe; pirinčano mleko; artičoke, konzervirane; aranžmani od obrađenog voća; mleko u prahu*; jakitori [japanski ražnjići od piletine]; bulgogi [koreansko jelo od govedine]; kandirani orasi; začinjeno koštunjavo voće; začinjeni orasi; lešnici, pripremljeni; bobičasto voće, konzervirano; guakamol [pire od avokada]; prstenovi od luka [pohovani luk]; falafel; limunov sok za upotrebu u kulinarstvu; dehidrisano meso; zamrznuto-sušeno meso; liofilizovano meso;ovseno mleko; pavlaka [biljna] na bazi povrća; zamrznuto-sušeno povrće; liofilizovano povrće; dehidrisano povrće; ekstra devičansko maslinovo ulje za ishranu; galbi [jelo od grilovanog mesa]; eskamol [jestive larve mrava]; jestivi insekti, neživi; kukuruz šećerac, prerađen;namazi na bazi orašastih plodova; knedle na bazi krompira; viršle; viršle u kukuruznom testu na štapiću; sojino ulje za ishranu; zamene za mleko; bademovo mleko; mleko od kiririkija; kokosovo mleko; kokosovo mleko za kulinarsku upotrebu; napici na bazi kokosovog mleka; pirinčano mleko za kulinarsku upotrebu; napici na bazi bademovog mleka; napici na bazi mleka od kikirikija; creva za kobasice, prirodna ili veštačka; usoljen i sušeni bakalar; uštipci od svežeg sira; presovana voćna pasta; juba [tofu listići]; pljeskavice od soje; tofu pljeskavice; tadžin [gotovo jelo od mesa, ribe ili povrća];

Klasa 30: Alge [začin]; testenina; bademovo testo; seme anisa; seme zvezdastog anisa; konditorski proizvodi za ukrašavanje novogodišnje jelke; nemedicinski biljni čajevi; arome za kafu; aromatični dodaci za hranu; dodaci jelima; hleb bez kvasca; soli za konzervisanje namirnica; dvopek; biskviti, suvi kolačići keks; sladni biskviti; slatkiši od pepermint; slatkiši [bombone]; vafel proizvodi; slatke zemičke, kolačići kakao; kafa; nepržena kafa; biljni preparati za upotrebu kao zamena za kafu; kolači; cimet [začin]; kapra; karamele [bombone]; kari [začin]; preparati od žitarica; žvakaća guma*; cikorijska [zamena za kafu]; čaj; čokolada; marcipan; karanfilić [začin]; začinski dodaci; slatkiši; slatkiši od šećera; kornfleks; kukuruzne pahuljice; kokice; preparati za učvršćivanje mućene pavlake, šlaga; sladoled; palačinke; esencije za ishranu, izuzev etarskih esencija i etarskih ulja; kuhinjska so; dodaci za zgušnjavanje hrane za kuvanje; kurkuma*; prirodni zaslađivači; začini; kolačići od đumbira; piment; brašno*; brašno od boba; kukuruzno brašno; kukuruzno brašno, krupno brašno od slačice; ječmeno brašno; sojino brašno; pšenično brašno;skrob za jelo; fermenti za testo; fondani [slatkiši]; sitni kolači; šećer*; arome za kolače, izuzev etarskih ulja; prašak za kolače; testo za kolače; đumbir [začin]; vezivni agensi za sladoled; led, prirodni ili veštački; led za osvežavanje; glukoza za kulinarsku namenu; gluten pripremljen kao hrana; prekrupa za ljudsku ishranu; sirće; kečap [sos]; kakao; napici sa mlekom; pića od kafe sa mlekom; pića od čokolade sa mlekom; sredstva za podizanje testa; kvasac; materijali za vezivanje kobasica; kolačići od badema [slatka peciva]; makaroni; mleveni kukuruz; kukuruz, mleveni kukuruz, prženi kukuruz; hleb*; maltoza; melasa za ishranu; zlatni sirup [šećerni sirup], melasa; mentol za poslastice; med; oljušteni ječam; senf; oraščići rezanci; tanki rezanci; pite; mleveni ječam; sendviči; pastile [bombone]; peciva; peti-ber keks; vekne hleba; začinska paprika; pice; biber; brašno od krompira*; puding; praline; ravioli; slatki koren [slatkiši]; pirinač šafran [začin]; sago; sosovi [dodaci hrani]; celerova so; griz; šerbet [zaleđeni]; sorbei [ledeni]; špageti; tapioka; brašno tapioke*; tart [slatka pita bez gornje kore]; aroma vanile za kulinarske namene; vanilin [zamena za vanilu]; rezanci za supu; pite od mesa; vekna sa mesom; sredstva za omekšavanje mesa za upotrebu u domaćinstvu;

sladoledi; prašak za pravljenje sladoleda; slatkiši od badema; poslastice od kikirikija; arome, koje nisu etarska ulja; arome za pića, izuzev etarskih ulja; mleveni ovas; oljušteni ovas; hrana na bazi ovsa; ovsene pahuljice; ovseno brašno; štapovi od slatkog korenja[poslastica]; pivsko sirće; pića na bazi kafe; pića na bazi kakaoa; pića na bazi čokolade; zamene za kafu; bombone*; čips [proizvod od žitarica]; čau-čau [začin]; kus-kus [griz]; sladni ekstrakti za hranu; slad za ljudsku ishranu; propolis [pčelinji proizvod]*; propolis; reliš [dodatak jelu]; matični mleč*; morska voda za kuvanje; suši; umak od paradajza; majonez; krekeri; engleski krem; voćni žele [slatkiši]; musli; kolači od pirinča; umak, sos od soje; smrzniti jogurt [poslastičarski]; čatni [dodatak jelima]; prolećne rolnice; tako tortilje; ledeni čaj; napici od čaja; prelive za salatu; hlebne mrvice; tabule, libanska salata; alva; kiš; sosovi za meso [umaci]; pasta od soje [dodatak jelima]; miso [dodatak jelima]; grickalice na bazi žitarica; grickalice na bazi pirinča; suva zrna kukuruza bez ljuske; kukuruzni griz; prašak za pecivo; bikarbona soda za kuvanje; soda bikarbona za kuvanje; konzervisane baštenske trave [začini]; gotovi obroci od rezanaca; glazure za kolače; čokoladni musevi; deserti u obliku musa [slatkiši]; voćni prelive [sosovi]; marinade; sendviči sa sirom [čizburgeri]; pesto [sos]; glazure za šunku; seme lana za kulinarsku upotrebu [začin]; laneno seme za kulinarsku upotrebu [začin]; pšenične klice za ljudsku ishranu; visokoproteinske pločice od žitarica; tartar krem za kuvanje; glutenski dodaci za kulinarske namene; sosovi za testenine; pločice od žitarica; palmin šećer; testo, poluprerađen proizvod; cvetovi ili lišće kao zamena za čaj; testo za slatka peciva; vareniki [punjene knedle]; peljmeni [knedle punjene mesom]; čokoladni ukrasi za torte; ukrasne bombone za torte; koštunjavo voće sa čokoladnim prelivom; sutlijaš; koštunjavo voće u prahu; beli luk u prahu [začin]; baozi [testo sa nadevom]; pirinčana kaša za kulinarske namene; jiaozi [punjene knedle]; ramen [japansko jelo na bazi rezanaca]; okonomijaki [japanske pikantne palačinke]; smese za okonomijaki [japanske pikantne palačinke]; buritosi; gimhap [koreansko jelo od pirinča]; jestivi papir; jestivi papir od pirinča; namazi na bazi čokolade; čokoladni namazi koji sadrže orašaste plodove; knedle na bazi brašna sirup od agave [prirodni zaslađivač]; staklene glazure; dehidrisana jela čiji je glavni sastojak pirinač; liofilizovana jela čiji je glavni sastojak pirinač; zamrznuta-sušena jela čiji je glavni sastojak pirinač; zamrznuta-sušena jela čiji je glavni sastojak testenina; liofilizovana jela čiji je glavni sastojak testenina; dehidrisana jela čiji je glavni sastojak testenina; napici na bazi kamilice; mlečni karamel krem; bibimbap [mešavina pirinča sa povrćem i junetinom]; onigiri [pirinčane kuglice]; instant pirinač sendvič sa viršlama; kocke leda; prerađeno seme za upotrebu kao začin; susamovo seme [začin]; pikalili; kinoa, prerađena; bulgur; heljda, prerađena brašno od heljde; sos od brusnice [začin]; sos od jabuka [začin]; krutoni; lomper [palačinke na bazi krompira]; zefir [poslastica]; pastila [poslastica]; senbei [pirinčani krekeri]; kimči [palačinke od ukiseljenog povrća]; strugani led sa zaslađenim crvenim pasuljem; mentol bombone za osvežavanje daha; žvakaće gume za osvežavanje daha; udon rezanci soba rezanci.

Klasa 31: Agrumi [južno voće], sveži; alge, neprerađene, za ljudsku ili životinjsku ishranu; morske alge, neprerađene, za ljudsku ili životinjsku ishranu; orašasto voće; životinjska menažerija; žive životinje; hrana za životinje; drveće; Božićne jelke*; stabla drveća; žbunje; ovas [zob]; bobičasto voće, sveže; so za stoku; repa, sveža; mekinje; trupci; kokosov orah, sirov; šećerna trska; rogač, sirov; seme žitarica, neprerađeno; gljive, sveže; uljaste pogače; stočne pogače; kesten, svež; kreč za životinjsku ishranu; koren cikorije; cikorija, sveža; biskviti za pse; limun, svež; ljuska kokosovog oraha; kokos; hrana za ptice; pogača od uljane repice za stoku; krastavci, sveži; hmeljne šišarke; kaša od mekinja za ishranu životinja; kopra; školjke [žive] sveže; povrće bundeve, sveže; venci od prirodnog cveća; jaja za uzgoj, oplodena; pomije; uzgajana stoka; preparati za tovljenje životinja; brašno od pirinča za

stočnu ishranu; pasulj, svež; cveće, prirodno; cveće, za dekoraciju, osušeno; polen [sirovina]; seno; hrana za jačanje životinja; hrana za stoku; stočna hrana; pšenica voće, sveže; travnjaci, prirodni; trava, prirodna; smrekine bobice; semenske klice za botaničke svrhe; zrnevlje [žitarice]; seme za životinjsku konzumaciju; seme za sadnju; semenje; zobena krupica za živinu; baštenska trava, sveža biljke; sadnice; hmelj; orah biljke kole; zelena salata, sveža; sočivo, sveže; kvasac za ishranu životinja; pluta, sirova; laneno brašno [stočna hrana]; kukuruz; kukuruzna stočna pogača; slad za vrenje i destilaciju komina; ostaci voća [komina]; lešnik, svež; brašno za životinje; riblja ikra; jaja svilene bube; lukovice; cvetne lukovice; crni luk, svež; masline, sveže; pomorandže, sveže; ječam; kopriva; sipina kost za ptice; slamene prostirke; slama [stočna hrana]; palme [lišće palminog drveta]; stabla palme; kaša za tovljenje stoke; riba, živa; vinova loza; borova šišarka; biber [biljka]; biljke, sušene, za dekoraciju; praziluk, svež; grašak, svež; krompir, svež; preparati za živinu; nosilje; stajska hrana za životinje; korenje za ishranu životinja; grožđe, sveže; rabarbara, sveža; žbunovi ruža; raž; svilena buba; jestiv susam, neprerađen; tartufi, sveži; talog nakon destilacije; živina, živa; algarovila za životinjsku ishranu; badem [voće]; kikiriki, svež; brašno od kikirikija za životinje; pogače od kikirikija za životinje; nus-proizvodi prerade žitarica za ishranu životinja; ostaci nakon prerade šećerne trske [sirovina]; mamci za pecanje, živi; rakovi, živi; ljuskari, živi; jastozi, živi; dagnje, žive; ostrige, žive; hrana za kućne ljubimce; sirova kora drveta; jastozi obični [živi]; hrana za preživljanje za životinje; napitci za kućne ljubimce; riblje brašno za životinjsku ishranu; pirinač, neprerađen; morski krastavci [živi]; papir sa peskom [prostirka] za kućne ljubimce; mirisni pesak [prostirka] za kućne ljubimce; aloe vera biljke; spanać, svež; laneno seme za ishranu životinja; seme lana za ishranu životinja; brašno od semena lana za ishranu životinja; laneno brašno za ishranu životinja; pšenične klice za ishranu životinja; artičoke, sveže; haringa, živa; losos, živ; sardine, žive; tuna, živa; beli luk, svež; tikvice, sveže; jestivo seme lana, neprerađeno; jestive semenke lana, neprerađene; aranžmani od svežeg voća; incuni, živi; jestivi insekti, živi; neprerađeni klipovi kukuruza šećerca [oljušteni ili neoljušteni]; kinoa, neprerađena; heljda, neprerađena; koi šarani, živi.

Klasa 32: Bezalkoholni voćni ekstrakti; pivo; ale pivo od đumbira; pivo od đumbira; sladno pivo; pivski slad; bezalkoholni voćni napici; pića od surutke; bezalkoholni pripravci za pravljenje napitaka; koncentracije za pravljenje napitaka; voćni sokovi; sirupi za pića vode [pića]; preparati za pravljenje gazirane vode; litijum voda; mineralna voda [piće]; Seltzer voda; stonice vode šira limunade; ekstrakti hmelja za proizvodnju piva; sokovi od povrća [pića]; sirupi za limunade; sladovina šira [nefermentisana]; bademov sirup; soda voda; šerbeti [pića]; sok od paradajza [piće]; bezalkoholna pića; pilule za gaziranje pića; praškovi za gaziranje pića; gazirana voda; sarsaparila [bezalkoholni napitak]; aperitivi, bezalkoholni; kokteli, bezalkoholni; voćni nektar [bezalkoholni]; izotonici; sok od jabuke, bezalkoholni; kvas [bezalkoholni napitak]; bezalkoholni napici na bazi meda; smutis [kašasti napici od voća ili povrća]; bezalkoholna pića od aloe vera; kokteli na bazi piva; napici od soje, osim zamena za mleko; napici za sportiste obogaćeni proteinima; napici na bazi pirinča, koji nisu zamena za mleko; bezalkoholni napici sa ukusom kafe; bezalkoholni napici sa ukusom čaja; osvežavajuća bezalkoholna pića; ječmeno vino [pivo]; energetska pića.

Klasa 33: Liker od pepermintaa; voćni ekstrakti, alkoholni; biteri [gorka alkoholna pića]; liker od anisa; aniset [liker]; aperitivi; arak; destilovana pića; jabukovača; kokteli; kurakao; digestivi [likeri i žestoka pića]; vino; džin; likeri; medovina; kiršć, višnjevača; žestoka pića; brendi; piket; kruškovača; sake; viski; alkoholna esencije; alkoholni ekstrakti; alkoholna pića, izuzev piva; alkoholna pića koja sadrže voće; alkohol od pirinča; rum; vodka; pomešana alkoholna pića, koja nisu na bazi piva; nira [alkoholno piće na bazi šećerne trske]; baijiu [kinesko piće od destilovanog alkohola].

Klasa 35: Pomoć u poslovnom upravljanju; obaveštenja o poslovima reklamiranje preko plakata; usluge agencija za uvoz i izvoz; usluge agencija za pružanje poslovnih informacija; analize cena i troškova; distribucija reklamnog materijala; računovodstvo; vođenje knjiga [knjigovodstvo]; revizija poslovanja; poslovno upravljanje i organizaciono savetovanje; konsultacije u poslovnom upravljanju; prezentacija robe; pomoć u poslovnom ili industrijskom upravljanju; ažuriranje oglasnih materijala; distribucija uzoraka; stručne usluge o poslovnoj efikasnosti; istraživanje tržišta; poslovne procene; poslovna ispitivanja; iznajmljivanje oglasnih materijala; konsultacije u vezi sa poslovnim organizovanjem; objavljivanje reklamnih tekstova; oglašavanje; reklamiranje; reklamiranje na radiju; poslovna istraživanja; usluge odnosa sa javnošću; reklamiranje preko televizije; prepisivanje korespondencije [kancelarijske usluge]; uređivanje izloga; usluge reklamnih agencija; savetodavne usluge u poslovnom upravljanju; marketinška istraživanja; kompjutersko upravljanje podacima; profesionalne poslovne konsultacije; organizovanje izložbi za privredne ili reklamne potrebe; poslovne informacije; ispitivanje javnog mnjenja; priprema platnih listi; pronalaženje osoblja; iznajmljivanje oglasnog prostora; obračun poreza; prikupljanje informacija u kompjuterske baze podataka; sistemacija informacija u kompjuterskim bazama podataka; organizovanje sajмова u komercijalne ili reklamne svrhe; onlajn reklamiranje na računarskoj mreži; usluge nabavke za treća lica [kupovina proizvoda i usluga za druge poslovne subjekte]; psihološko testiranje za izbor zaposlenih; usluge poređenja cena; prezentacija proizvoda putem sredstava komunikacije, u svrhu prodaje na malo; pružanje komercijalnih saveta i informacija potrošačima pri izboru roba i usluga; dogovaranje pretplate za usluge telekomunikacija za treća lica; administrativna obrada narudžbenica za kupovinu; komercijalna administracija za licence roba i usluga trećih lica; usluge podugovaranja, autsorsing [pomoć u poslovanju]; fakturisanje; pisanje reklamnih tekstova; prikupljanje statističkih podataka; marketing; usluge maloprodaje farmaceutskih, veterinarskih i higijenskih preparata i medicinskog materijala; iznajmljivanje prodajnih štandova; pružanje komercijalnih i poslovnih kontakt informacija; optimizacija pretraživača za promociju prodaje; optimizacija saobraćaja sa Internet stranice; usluge posredovanja u trgovini; pružanje poslovnih informacija putem Internet stranice; obezbeđivanje onlajn tržišta za kupce i prodavce roba i usluga; dizajniranje reklamnog materijala; angažovanje spoljnih firmi za administrativno upravljanje kompanijama; usluge prijavljivanja poreza; poslovno upravljanje programima za nadoknadu za druge; iznajmljivanje bilborda [panoa za reklamiranje]; usluge zakazivanja sastanaka [kancelarijske usluge]; upravljanje programima lojalnosti potrošača; pisanje tekstova za reklamne namene; registrovanje pisane komunikacije i podataka ažuriranje i održavanje; informacija u registrima; sastavljanje popisa informacija za komercijalne i reklamne svrhe; poslovno upravljanje za nezavisne pružaoce usluga; pregovaranje i zaključivanje poslovnih transakcija za treća lica; usluge poslovnog posredovanja koje se odnose na povezivanje potencijalnih privatnih ulagača sa preduzetnicima kojima su potrebna finansijska sredstva; promocija robe i usluga kroz sponzorisanje sporskih događaja; usluge praćenja konkurencije; usluge praćenja tržišta; finansijska revizija; ciljni marketing; oglašavanje na otvorenom; usluge odnosa sa medijima usluge korporativne komunikacije; iznajmljivanje kancelarijske opreme u zajedničkim radnim prostorima; usluge komercijalnog lobiranja.

Klasa 43: Usluge agencija za smeštaj [hotelski, pansioniski]; katering hrane i pića; usluge kafea; usluge kafeterija; usluge kantina; iznajmljivanje privremenog smeštaja; pansionске usluge; usluge restorana; usluge restorana za samoposluživanje; usluge snek-barova; usluge barova; iznajmljivanje stolova, stolica, stolnjaka i staklenog posuđa; iznajmljivanje prostorija za sastanke; iznajmljivanje aparata za kuvanje; iznajmljivanje automata za vodu

za piće; iznajmljivanje aparata za osvetljenje*; pravljenje skulptura od hrane; usluge vašoku restorana; usluge udon i soba restorana; dekorisanje hrane; dekorisanje kolača; informacije i saveti u vezi sa pripremanjem obroka; usluge ličnog šefa kuhinje.

(111) **14967**

(151) 30.10.2020.

(210) Ž-2019-402

(220) 17.10.2019.

(732) Celgene Corporation, 86 Morris Avenue, 07901, Summit, New Jersey, US

(540)

ЛЕЛОКИ

(550) I

(740) Jasna Jusić, Dalmatinska 2, 81000, Podgorica

(511) Klasa 5: Farmaceutski preparati za liječenje raka i autoimunih bolesti, bolesti iz oblasti onkologije, imunologije i zapaljenskih procesa; farmaceutski preparati, naime inhibitori lijeka citokina; farmaceutski preparati koji moduliraju imunološki sistem; farmaceutski preparati, naime preparati za liječenje tumora; farmaceutski i biološki preparati za imunoterapiju, uključujući T-ćelijsku terapiju; ćelije za medicinsku ili kliničku upotrebu; dijagnostički setovi koji se sastoje prevashodno od ćelija za medicinsku ili kliničku upotrebu.

(111) **14961**

(151) 30.10.2020.

(210) Ž-2019-345

(220) 10.09.2019.

(732) Fujikura Ltd., 5-1, Kiba 1-chome, Koto-ku, 135-8512, Tokyo, JP

(540)

 **Fujikura**

(550) I

(740) Miladin Popović, ul. Capital Plaza, ulica šeika Zajeda 13-IV/68, 81000, Podgorica

(511) Klasa 7: Mašinski alati; Mašine za rezanje; Električni aparati za zavarivanje; Kontrolni mehanizam za mašine, motore sa unutrašnjim sagorijevanjem ili motore; Ručni alati, izuzev alata na ručni pogon; Matrice i kalupi (djelovi mašina).

Klasa 9: Kompjuterski programi [softver za preuzimanje]; Optička vlakna; Kablovi od optičkih vlakana; Fuzijske spojnice optičkih vlakana; Laserski generatori, ne za medicinske svrhe; Elektrode za fuzijske spojnice optičkih vlakana; Optička pojačala; Konektori za optička vlakna; Čistači optičkih konektora; Optičke spojnice za optičku komunikaciju; Fiberskopi, ne za medicinske svrhe; Utikači za električne kablove; Ploče sa elektronskim kolima; Fleksibilne štampane ploče za ožičenje (fleksibilne štampane ploče sa elektronskim kolima); Električne sklopke u obliku nizova metalnih kupola za mobilne telefone, lične digitalne asistente [PDA], automatizovanje kancelarija i mjerne instrumente; Membranske sklopke; Senzori pritiska; Senzori kiseonika, ne za medicinsku upotrebu; Elektronski konektori; Konektori za štampane ploče sa elektronskim kolima; Konektori za koaksialne kablove; Konektori za ravne kablove; Ravni kablovi; Koaksialni kablovi; Kablovski remeni za automobile; Konektori za kablovske remene za automobile; Antene; Filmske antene, naime, antene u obliku električnih krugova koji funkcionišu kao antene formirane na filmskim podlogama; Uređaji za regulaciju toplote, naime radijatori sa toplotnim cijevima za telekomunikacione mašine i aparate i elektronske mašine i aparate; Regulatori temperature za telekomunikacione mašine i aparate i elektronske mašine i aparate; Električni kablovi; Elektronski kablovi; Električne žice.

Klasa 35: Savjetovanje u vezi sa poslovnom organizacijom; Savjetovanje i upravljanje ljudskim resursima; Agencije za uvoz-izvoz; Savjetovanje u vezi sa poslovnim upravljanjem u području informacione tehnologije; Pomoć u poslovnom upravljanju.

Klasa 37: Izvođenje građevinskih radova; Telekomunikacijske usluge ožičavanja; Instalacija, popravka i održavanje optičkih vlakana, električnih žica, električnih kablova i računarskih žica i kablova; Polaganje kablova; Instalacija ožičavanja za telekomunikacijske uređaje i mreže; Pružanje tehničke podrške i tehničkih savjeta u vezi sa ugradnjom, popravkom i održavanjem systemske opreme koja se odnosi na optička vlakna, električne žice i električne kablovske mreže; Popravljanje i održavanje dalekovoda; Građevinske informacije; Instaliranje, održavanje i popravljanje mašina.

Klasa 38: Savjetovanje u vezi sa telekomunikacijama; Omogućavanje pristupa računarskim mrežama i mrežnim računarskim bazama podataka; Komunikacija optičkim mrežama; Komunikacija putem računarskih terminala; Omogućavanje telekomunikacionih veza sa globalnom računarskom mrežom; Pružanje informacija u vezi sa telekomunikacijama.

Klasa 40: Izrada i obrada optičkih vlakana, električnih žica i električnih kablova po narudžbi i specifikaciji drugih, Prilagođeno sastavljanje materijala za druge; Podaci o obradi materijala.

Klasa 41: Akademski treninzi; Lični treninzi; Pružanje obrazovnih informacija; Organizovanje i sprovođenje seminara; Obezbeđivanje on-line elektronskih publikacija koje nije moguće preuzeti.

Klasa 42: Računarsko programiranje i održavanje računarskog softvera; Savjetovanje u vezi sa informacionom tehnologijom [IT]; Tehničko savjetovanje, podrška i inženjering u vezi sa informacionom tehnologijom; Dizajn i tehničko savjetovanje u vezi sa računarskim hardverom, softverom i periferijama; Pružanje tehnoloških informacija u oblasti telekomunikacija; Istraživanja koja se odnose na telekomunikacione tehnike; Istraživanje u oblasti informacionih tehnologija; Ispitivanje, pregled i istraživanje optičkih vlakana,

električnih žica i električnih kablova; Savjetovanje u vezi sa telekomunikacionom tehnologijom.

(111) **14968**

(151) 30.10.2020.

(210) Ž-2019-237

(220) 24.06.2019.

(732) BMJ Industries FZ-LLC, P.O. Box: 31053, Al-Jazeera Al-Hamra, Ras Al Khaimah, AE

(540)



(550) I

(740) Božidar S. Radulović, Baku 30/5, 81000, Podgorica

(511) Klasa 34: Duvan; artikli za pušače; šibice.

(111) **14969**

(151) 30.10.2020.

(210) Ž-2019-262

(220) 04.07.2019.

(732) Qatar Sports Investment, Suhaim Bin Hamad Street, Al Saad, Regency Travel and Tours Building, Doha, QA

(540)

First Sport Capital
فيرست سپورت كابيٲال

(550) I

(740) Božidar S. Radulović, Baku 30/5, 81000, Podgorica

(511) Klasa 36: Investiranje, naime investiranje u sportu.

(111) **14970**

(151) 30.10.2020.

(210) Ž-2019-357

(220) 17.09.2019.

(732) G M B GENERAL TRADING L.L.C, P.O.Box:97131 - Deira, Dubai, AE

(540)



(550) I

(740) Božidar S. Radulović, Baku 30/5, 81000, Podgorica

(511) Klasa 34: Duvan; artikli za pušače; šibice.

(111) **14962**

(151) 30.10.2020.

(210) Ž-2019-178

(220) 07.05.2019.

(732) Four Seasons Hotels (Barbados) Ltd. a Barbados Company, Chancery House, High Street, Bridgetown, BB

(540)



(550) I

(740) Jasna Jusić, Dalmatinska 2, 81000, Podgorica

(511) Klasa 35: Oglašavanje; vođenje poslova; poslovno upravljanje; kancelarijski poslovi; usluge nabavke; vođenje poslova za druge, uključujući pregovaranje i zaključivanje komercijalnih transakcija, ugovaranje poslova kupovine i prodaje proizvoda; pružanje informacija o proizvodima i uslugama, dobavljačima i poslovima; usluge maloprodajnih objekata; usluge prodaje; usluge poručivanja putem pošte; usluge prodaje putem interneta ili mobilnih telefona; vođenje hotela za druge; upravljanje hotelima; obezbjeđivanje prostora za izložbe (administrativne); dijeljenje oglasa/reklama; neposredno oglašavanje putem pošte; pružanje usluga poslovnih centara; promocija apartmana, vlasničkih stanova, tajmšering nekretnina, nekretnina povremenog vlasništva, komercijalnih nekretnina, otvorenih i zatvorenih tržišnih centara, i nekretnina svih vrsta, kao i povezanih objekata i pogodnosti, uključujući i takve usluge koje se pružaju onlajn, elektronski ili putem globalne kompjuterske mreže; reklamiranje maloprodajnih šoping centara; pružanje usluga upravljanja vlasnicima radnji i/ili rukovodiocima u tržišnim centrima; upravljanje otvorenim i zatvorenim tržišnim centrima; organizacija konvencija i izložbi u poslovne i komercijalne svrhe; podsticajni nagradni programi za korisnike kreditnih kartica; upravljanje programima lojalnosti potrošača; izdavanje poklon vaučera i poklon kartica koji se mogu zamijeniti za robu i/ili usluge; usluge reklamiranja; poslovno upravljanje hotelima, spa centrima, službenim stanovima, objektima prodaje hrane objektima prodaje pića, kancelarijama, poslovnim centrima, robnim kućama, tržišnim centrima, maloprodajnim i veleprodajnim outletima; onlajn maloprodaja; konsultacije u poslovnom upravljanju, konsultacije u upravljanju hotelima, konsultacije u upravljanju spa centrima, konsultacije u poslovnom upravljanju u vezi sa hranom i pićem; poslovne savjetodavne usluge u vezi sa franšizingom; maloprodajne usluge; sortiranje raznih proizvoda, za račun trećih lica, radi omogućavanja potrošačima da ih lakše razgledaju i kupuju u hotelima, outletima za hranu i piće, poslovnim zgradama, kongresnim centrima, robnim kućama, ili veleprodajnim objektima, iz opštih robnih kataloga, kroz naručivanje putem pošte ili putem sredstava telekomunikacije ili putem internet stanica mreže za globalnu komunikaciju u vezi sa opštom trgovinom; sakupljanje mejling lista; usluge poručivanja putem pošte, telefona i svih drugih komunikacionih i telekomunikacionih sredstava; poslovno savetovanje; usluge prikaza robe; oglasne usluge; marketinške i promotivne usluge, analiza i istraživanje tržišta; usluge agencija koje se bave uvozom i izvozom; nabavka i kupovina robe u ime firmi; uređivanje izloga; usluge privatnih klubova, uključujući obezbeđivanje poslovnih prostora za upotrebu od strane članova i stanara; informacione, savjetodavne i konsalting usluge u vezi sa prethodno pomenutim uslugama; programi članstva, lojalnosti, podsticaja, nagrađivanja i otkupa za potrošače a u promotivne i/ili reklamne svrhe, svi uključeni u klasu 35; uključujući sve gore pomenute usluge koje se pružaju elektronskim putem ili onlajn putem kompjuterske baze podataka ili putem interneta; informacione, savjetodavne i konsalting usluge u vezi sa gore pomenutim uslugama; sve uključene u klasu 35.

Klasa 36: Osiguranje; finansijski poslovi; novčani [monetarni] poslovi; poslovi vezani za nepokretnosti, razvoj, kupovina, prodaja, upravljanje, iznajmljivanje, promocija i posredovanje na berzi apartmana, vlasničkih stanova, tajmšering nekretnina, komercijalnih nekretnina, zatvorenih i otvorenih tržišnih centara, nekretnina svih tipova kao i povezanih objekata i pogodnosti; razmjena povezanih pogodnosti; aranžmani razmjene za nekretnine, uključujući tajmšering nekretnine i druge nekretnine povremenog vlasništva; poslovi u vezi

sa nekretninama; usluge iznajmljivanja smeštaja; upravljanje stambenim zgradama i stambenim objektima; usluge upravljanja smeštajima; prodaja, iznajmljivanje i davanje u zakup apartmana, stanova, zgrada, kuća, vlasničkih stanova i ostalih stambenih smeštaja; razvoj, kupovina, prodaja, finansiranje, upravljanje, rukovođenje, izdavanje, promocija i posredovanje na berzi nekretnina za sve tipove nekretnina; davanje prava i upravljanje pravima drugih kojima je omogućeno da koriste nekretnine; davanje prava i upravljanje pravima korišćenja apartmana, rezidencija, nekretninama frakcionog vlasništva članovima kluba odmorišta; usluge u vezi sa apartmanima, rezidencijama, nekretninama frakcionog vlasništva, članovima kluba odmorišta, klupskim članstvima, tajmšering nekretninama za odmor, tajmšering nekretninama; obezbeđivanje smeštaja za stanovanje; davanje u zakup smeštaja u ime drugih; izdavanje apartmana; izdavanje stanova; službeni stanovi; usluge u vezi sa komercijalnim nekretninama, otvorenim i zatvorenim tržišnim centrima i nekretninama svakog tipa, i povezanim objektima; usluge u vezi sa prodajom tajmšering nekretnina i nekretnina povremenog vlasništva; usluge razmjene nekretnina, uključujući tajmšering nekretnine i nekretnine povremenog vlasništva; usluge članstva u vezi sa tajmšeringom nekretnina; pribavljanje informacija u vezi sa nekretninama, apartmanima, objektima tajmšering nekretnina i davanja u zakup apartmana; tajmšering nekretnina; tajmšering nekretnina za odmor; usluge članstva u vezi sa tajmšeringom ; usluge imovine u vezi sa brodovima za krstarenja, naime, listing , davanje u zakup, posredovanje na berzi i upravljanje stambenim i komercijalnim jedinicama na brodovima za krstarenje i finansiranje istih; finansijske usluge; usluge u vezi sa hipotekama; usluge kreditnih kartica; usluge u vezi sa novcem; pružanje usluga čuvanja u sefovima; usluge osiguranja; uključujući sve gore pomenute usluge koje se pružaju elektronski ili onlajn preko kompjuterske baze podataka ili putem interneta; informacione, savetodavne i konsalting usluge u vezi sa gore pomenutim uslugama; sve uključene u klasu 36.

Klasa 39: Transportne usluge; pakovanje i skladištenje robe; organizovanje putovanja; transport; usluge vezane za iznajmljivanje brodova, organizovanje krstarenja, rad marina; rad turističkih kancelarija i turističkih agencija; organizovanje izleta, pratnja putnika, prevoz putnika; upravljanje garažama, iznajmljivanje parkinga, parkiranje automobila, iznajmljivanje automobila; rezervisanje mjesta za putnike i rezervacije putovanja; vođenje krstarenja; usluge brodova za krstarenje; putničke usluge; putne rezervacije; krstarenja brodovima; upravljanje krstarenjima; usluge turističkih agencijama, naime, rezervacije i bukiranje za krstarenja; organizovanje prevoza za putničke izlete; pakovanje i skladištenje robe; uključujući sve gore navedene usluge koje se pružaju elektronski ili online iz kompjuterske baze podataka ili putem interneta; informacione, savjetodavne i konsalting usluge u vezi sa gore pomenutim uslugama; sve uključeno u klasu 39.

Klasa 41: Obrazovne usluge; pripremanje obuke; razonoda; sportske i kulturne aktivnosti; obezbjeđivanje rekreativnih, zabavnih i sportskih objekata; informativne usluge u vezi sa zabavama; usluge kluba; rezervisanje mjesta za priredbe, predstave, koncerte, sportske događaje, zabavu u obliku nastupa uživo; bioskopske, pozorišne, koncertne i druge zabavne usluge; obezbjeđenje prostorija za teretanu i zdravstveni klub i aktivnosti u vezi s tim; usluge umjetničke galerije; pružanje obrazovnih i predavačkih sadržaja i usluga obuke; obezbjeđivanje onlajn elektronskih publikacija, uključujući časopise i brošure; pružanje usluga za kazino i video igre; obezbjeđivanje sauna, parnih kupatila i zdravstvenih banja; organizovanje i održavanje konferencija; planiranje proslava; sprovođenje časova fitnesa; obezbjeđivanje golf terena; usluge golf klubova; usluge zdravstvenih klubova [zdravstveni i fitnes trening]; usluge turističkih kampova [zabava]; usluge noćnih klubova [zabava]; organizacija takmičenja [obrazovnih ili zabavnih]; organizacija sportskih takmičenja; usluge

ličnih trenera [fitnes trening]; iznajmljivanje opreme za ronjenje; usluge sportskih kampova; iznajmljivanje teniskih terena; zabavne usluge na kruzaru; uključujući sve gore navedene usluge koje se pružaju elektronski ili onlajn iz kompjuterske baze podataka ili putem interneta; informacione, savjetodavne i konsalting usluge u vezi sa gore pomenutim uslugama; sve uključeno u klasu 41.

Klasa 43: Privremeni smještaj; usluge obezbjeđivanje hrane i pića; iznajmljivanje privremenog smještaja; usluge privremenog smještaja; rezervacije za privremeni smještaj; usluge hotela i odmarališta; rezervacije hotela; usluge restorana; usluge barova; usluge prijema za privremeni smještaj [upravljanje dolascima i odlascima]; usluge agencija za smještaj [hoteli, pansioni]; iznajmljivanje prostorija za sastanke; iznajmljivanje rasvjetnih uređaja; iznajmljivanje stolica, stolova, stolanjaka i salveta za stolove, staklarije; iznajmljivanje kuhinjskih uređaja; usluge domova za penzionere; iznajmljivanje šatora; iznajmljivanje prenosivih zgrada; obezbjeđivanje konferencijskih objekata; zbrinjavanje životinja; usluge obdaništa (jaslice); usluge restorana, kateringa i banketa; obezbjeđivanje privremenog stanovanja na kruzaru; usluge restorana i bara koje se pružaju na kruzaru; obezbjeđivanje konferencijskih objekata; uključujući sve gore navedene usluge koje se pružaju elektronski ili onlajn iz kompjuterske baze podataka ili putem interneta; informacione, savjetodavne i konsalting usluge u vezi sa gore pomenutim uslugama.

Klasa 44: Medicinske usluge; veterinarske usluge; higijenska zaštita i nega lepote za ljude ili životinje; usluge poljoprivrede, hortikulture i šumarstva; spa usluge; kozmetički saloni; obezbjeđivanje objekata i usluga za saunu; usluge za gubljenje kilograma i oblikovanja figure; konsultacije i savjeti za ljepotu; usluge aromaterapije; usluge uređivanja kućnih ljubimaca; usluge za oporavak kod kuće; obezbjeđivanje cvjetnih aranžmana; zdravstvene spa usluge; masaža; uređivanje bašte; dizajniranje zelenih površina.

(111) **14973**

(151) 17.12.2020.

(210) Ž-2019-315

(220) 22.08.2019.

(732) Publicis Groupe SA, 133 avenue des Champs-Élysées, 75008, Paris, FR

(540)

SAATCHI & SAATCHI

(550) I

(740) Jasna Jusić, Dalmatinska 2, 81000, Podgorica

(511) Klasa 35: Savjetovanje u vezi s poslovanjem i organizacijom; poslovna administracija; savjetovanje, razvoj i primjena komercijalnih, reklamnih, komunikacionih i marketinških strategija; ekonomske prognoze; istraživanja za poslove; tržišne studije; istraživanje, sastavljanje, obrada i analiza poslovnih podataka; ažuriranje i održavanje podataka u računarskim bazama podataka; usluge oglašavanja i marketinga; promotivne

usluge; marketing, oglašavanje, razvoj sadržaja i konsultacije u vezi sa brendovima u oblasti usluga komunikacionih strategija koje se odnose na brendove; usluge brendiranja, naime, analiza i savjetovanje o brendovima za preduzeća; savjetodavne usluge u vezi sa podsticanjem prodaje; analiza poslovnih podataka u oblasti naučnih podataka i konsultantske usluge za njih; marketinška analiza u vidu usluga mjerenja i optimizacije atribucije (ovlašćenja) digitalnih medija; usluge segmentacije potrošača, naime marketinške usluge u obliku sprovođenja praćenja ponašanja potrošača i analize trendova potrošača; poslovno savjetovanje i savjetodavne usluge koje se odnose na analizu interesa potrošača i navika kupovine; usluge upravljanja reklamama, naime upravljanje komercijalnim i reklamnim materijalima i medijima; usluge kupovine i planiranja medija; iznajmljivanje i kupovina vremena i reklamnog prostora na svim sredstvima komunikacije i medijima; kreiranje, pisanje, uređivanje, objavljivanje i distribucija tekstova, vizuala, sadržaja i reklamnog materijala (brošure, prospekti, štampani materijal, oglašavanje putem pošte, medijski setovi, uzorci); promocija proizvoda i usluga drugih; produkcija, postprodukcija, montaža, objavljivanje, distribucija, iznajmljivanje i projekcija zvučnih, video i kinematografskih djela u reklamne svrhe; pisanje scenarija u reklamne svrhe; usluge modeliranja u reklamne svrhe; konsultantske usluge u vezi sa optimizacijom prometa veb stranica; pružanje, sastavljanje i analiza poslovnih informacija, poslovne statistike i komercijalnih informacija; organizovanje, razvoj i upravljanje događajima u komercijalne ili reklamne svrhe; organizaciono savjetovanje, razvoj i provođenje događaja u komercijalne ili reklamne svrhe; odnosi sa javnošću; usluge komercijalnog lobiranja; usluge poslovnog posrednika koje se odnose na usklađivanje potencijalnih privatnih investitora sa preduzetnicima kojima je potrebno finansiranje; savjetodavne usluge u vezi s oglašavanjem traženja sponzorstva; savjetovanje o strategijama društvenih medija; upravljanje zajednicama društvenih medija; onlajn oglašavanje na računarskoj mreži; poslovne procjene; evaluacije u vezi sa komercijalnim pitanjima; usluge procjene brenda; usluge poslovne strategije; usluge strategije brenda; informativne, savjetodavne i konsultantske usluge u vezi sa gore navedenim uslugama; uključujući sve gore navedene usluge koje se pružaju elektronskim putem ili putem interneta iz računarske baze podataka ili interneta

Klasa 41: Obrazovanje; obezbjeđivanje obuke; zabava; sportske i kulturne aktivnosti; izdavačke usluge; usluge objavljivanja; usluge obuke i podučavanja; stvaranje, pisanje, uređivanje, objavljivanje i distribucija tekstova, vizuala, sadržaja i materijala; objavljivanje uredničkog sadržaja veb-sajtova dostupnih putem globalne računarske mreže; usluge onlajn digitalnog izdavanja; onlajn objavljivanje knjiga i periodičnih publikacija; mikroizdavaštvo; pružanje onlajn elektronskih publikacija, digitalne muzike i digitalne zabave (koja se ne može preuzimati); produkcija, postprodukcija, uređivanje, distribucija, iznajmljivanje i projekcija zvučnih, video i kinematografskih radova, ne samo u reklamne svrhe; organizovanje kulturnih ili sportskih događaja; organizovanje akademskih skupova, konferencija i kongresa; organizacija radionica za obuku; vođenje kurseva, seminara i radionica koji se odnose na poslovanje, poslovno upravljanje, reklamiranje, marketing i promociju; usluge obrazovanja, davanja instrukcija i podučavanja u vezi sa poslovanjem, poslovnim upravljanjem, reklamiranjem, marketingom i promocijom; usluge obrazovanja, obučavanja i podučavanja koje se odnose na poslovanje, poslovno upravljanje, oglašavanje, marketing i promociju ; organizovanje i sprovođenje takmičenja (obrazovanje ili zabava); usluge korporativnog ugošteljstva; pružanje onlajn tekstova, vizuala i elektronskog sadržaja koji se ne može preuzeti; prevodilačke usluge; planiranje posebnih događaja; pružanje informacija u vezi sa sportom i sportskim događajima; pružanje informacija u vezi sa organizovanjem obrazovnih, kulturnih, sportskih ili zabavnih

manifestacija; usluge zabave i produkcije događaja, naime, organizovanje, koordinacija i sprovođenje sportskih događaja u vidu takmičenja u atletskim disciplinama, niza sportskih manifestacija, sportskih i atletskih takmičenja i sportskih događaja u zajednici; izložbene usluge; kulturne izložbe; zabavni nastupi u vidu uživo ili unaprijed snimljenog plesa, muzike, pozorišta, komedije, muzičkog benda i nastupa rok grupa, prikazivanje filmova, emisija, predstava ili muzičkih nastupa; produkcija televizijskih programa; produkcija i udruživanje radio i televizijskih programa i reklama; zvučna, video i pomoćna produkcija i usluge postprodukcije; snimanje muzike; uređivanje i unapređivanje zvuka; miješanje dijaloga, muzike, zvučnih efekata, dijaloga i naracije; automatizovana zamjena dijaloga; snimanje zvučnih efekata uživo; audio postprodukcija, reprodukcija i poboljšanje kvaliteta audio zapisa; sinhronizacija na stranom jeziku i snimanje; video postprodukcija, audio postprodukcija; dodavanje vizuelnih efekata i grafika video kaseti, audio kaseti, digitalnim medijima i filmu; mastering, uređivanje, poboljšavanje kvaliteta, obnavljanje, pretvaranje i reformatiranje filma, digitalnih medija i video kasete; uređivanje filma, digitalnih medija i video kasete; CD, DVD i mastering elektronskih medija; produkcija i specijalni efekti za reklame, filmove i televiziju; usluge eksploatacije filmova i animacija; iznajmljivanje opreme koja se koristi prilikom stvaranja filma, digitalnih medija i video kasete, kao i za upotrebu u postprodukcijom radu; produkcija, prezentacija, distribucija, udruživanje, umrežavanje i iznajmljivanje televizijskih i radijskih programa koji uključuju reklame, interaktivnu zabavu, filmove, zvučne i video zapise, interaktivne kompakt diskove i CD-ROM-ove; proizvodnja i iznajmljivanje edukativnog i materijala za obuku; iznajmljivanje radio i televizijskih emitterskih instalacija; pisanje scenarija, ne samo u reklamne svrhe; pisanje pjesama; usluge komponovanja muzike; iznajmljivanje audio i video opreme; iznajmljivanje kinematografske opreme; usluge agencija za izdavanje karata [zabava]; usluge snimanja u studiju; mikrofilmovi; titlovanje; fotografske usluge; uključujući sve gore pomenute usluge koje se pružaju onlajn preko računarske mreže ili putem interneta ili ekstraneta; informativne, savjetodavne i konsultantske usluge u vezi s prethodno navedenim uslugama; uključujući sve gore pomenute usluge koje se pružaju elektronskim putem ili onlajn iz računarske baze podataka ili interneta.

Klasa 42: Savjetovanje u vezi s informacionom tehnologijom; dizajn, razvoj, održavanje, hosting i implementacija veb sajtova, računarskog softvera, računarskih softverskih aplikacija, računarskih platformi i računarskih programa; inženjering u oblasti komunikacije i marketinga, naime tehnička analiza i tehnička obrada podataka; elektronsko čuvanje podataka; stvaranje tekstova, zvukova, muzike i video zapisa za veb stranice i veb sajtove; istraživanje i razvoj novih proizvoda za druge; dizajn, savjetovanje i razvoj aplikacija, softvera i veb sajtova; studije tehničkih projekata; grafički dizajn; programiranje softvera za internet forume; kreiranje programa za obradu podataka; softver kao usluga (SaaS); softver kao usluga (SAAS), naime softver u oblasti oglašavanja i marketinga; softver kao usluga (SAAS), naime, softver za praćenje, monitoring i izvještavanje putem medija, štampe, društvenih medija, trendova; softver kao usluga (SAAS), naime softver za razvoj tehnologije, podataka i analitičkih alata usmjerenih na reklamiranje; alati softverske tehnologije u obliku pretraživača i digitalnog kodiranja; softverske usluge, naime, pružanje onlajn platformi za praćenje, monitoring i izvještavanje putem medija, štampe, društvenih mreža, trendova; softverske usluge, naime, pružanje onlajn platformi za reklamiranje, marketing, promotivne i svrhe odnosa sa javnošću; softver kao usluga, naime, softver za procjenu ponašanja kupaca i analizu ponašanja na društvenim medijima i društvenim mrežama; softverske usluge, naime, pružanje onlajn platformi za razvoj tehnologije, podataka i analitičkih alata

usmjerenih na reklamiranje; pružanje softvera i platformi za kupovinu putem medija; alati (softverske aplikacije) za analizu brenda i društvenih medija; dizajnerska istraživanja; usluge ilustrovanja (dizajn); usluge industrijskog i komercijalnog dizajna; dizajn, kreiranje, istraživanje i razvoj ambalaže; istraživanje i dizajn novih proizvoda; razvoj novih proizvoda; dizajn, crtanje i pisanje po narudžbi, a sve

za sastavljanje veb stranica na internetu; kreiranje veb sadržaja i veb stranica; računarsko programiranje; računarske usluge, naime, dizajniranje i primjena mrežnih veb sajtova, softverskih aplikacija i računarskih mrežnih sistema informacione tehnologije za druge; usluge dizajniranja Veb sajtova; kompjutersko oblikovanje video grafike; kreiranje, uređivanje i ažuriranje sadržaja veb sajtova; računarske usluge, naime, dizajniranje i primjena reklama na banerima; usluge grafičkog dizajna; iznajmljivanje računarskih instalacija; usluge iznajmljivanja računara; iznajmljivanje računarskog softvera, računarskih platformi i računarskih aparata; informativne, savjetodavne i konsultantske usluge u vezi sa gore navedenim uslugama; uključujući sve gore navedene usluge koje se pružaju elektronskim putem ili putem interneta iz računarske baze podataka ili interneta.

(111) **14972**

(151) 30.10.2020.

(210) Ž-2018-452

(220) 19.11.2018.

(732) MERCATOR - CG D.O.O.Podgorica, Put Radomira Ivanovića 2, 81000, Podgorica, ME

(540)



(550) I

(511) Klasa 20: Namještaj , ogledala, okviri za slike, proizvodi (koji nisu obuhvaćeni drugim klasama) od drveta, plute, trske, rogoza, vrbovog pruča, roga, kosti, slonovače, kitove kosti, školjki, ćilibara, sedefa, morske pjene i zamjene svih ovih materijala, ili od plastike.

Klasa 35: Oglašavanje, vođenje poslova, poslovno upravljanje, kancelarijski poslovi.

Klasa 39: Transportne usluge, pakovanje i skladištenje robe, organizovanje putovanja.

Klasa 43: Usluge obezbjeđivanja hrane i pića, privremeni smještaj.

(111) **14974**

(151) 17.12.2020.

(210) Ž-2019-305

(220) 07.08.2019.

(732) Colgate-Palmolive Company (a Delaware corporation), 300 Park Avenue, 10022, New York, New York, US

(540)



(550) I

(740) Jasna Jusić, Dalmatinska 2, 81000, Podgorica

(511) Klasa 3: nemedicinska pasta za zube i nemedicinska tečnost za ispiranje usta.

(111) **14975**

(151) 17.12.2020.

(210) Ž-2019-316

(220) 26.08.2019.

(732) Colgate-Palmolive Company (a Delaware Corporation), 300 Park Avenue, 10022, New York, New York, US

(540)

FLOWER LOVE

(550) I

(740) Jasna Jusić, Dalmatinska 2, 81000, Podgorica

(511) Klasa 3: Proizvodi za ličnu higijenu, odnosno, preparati za čišćenje kože i tijela; sapun; tečni sapun za ruke; gelovi i kreme za tuširanje; kupke; preparati za njegu kose; dezodoransi, preparati protiv znojenja i sprejevi za ispod pazuha za ličnu upotrebu; preparati za hidrataciju tijela i kože, losioni i kreme; puder u prahu; preparati za brijanje; preparati za kozmetičko potamnjanje i preparati za zaštitu kože od uticaja sunca; maramice natopljene rastvorom za čišćenje.

(111) **14976**

(151) 17.12.2020.

(210) Ž-2019-440

(220) 08.11.2019.

(732) Mylan Inc., 1000 Mylan Boulevard Canonsburg, PA 15317, US

(540)

VIATRIS

(550) I

(740) Jasna Jusić, Dalmatinska 2, 81000, Podgorica

(511) Klasa 5: Farmaceutski preparati za liječenje kardiovaskularne, gastrointestinalne, neurološke, respiratorne, psihijatrijske, alergijske, dermatološke, plućne, metaboličke, mišićne, erektilne disfunkcije, infektivnih i zapaljenskih stanja, raka, dijabetesa, multipla skleroze; oralni i transdermalni kontraceptivi.

Klasa 10: Ubrizgači za medicinsku tečnost.

(111) **14977**

(151) 30.10.2020.

(210) Ž-2019-359

(220) 20.09.2019.

(732) L3Harris Technologies, Inc. (Delaware corporation), 1025 West NASA Boulevard, 32919, Melbourne, Florida, US

(540)

L3HARRIS

(550) I

(740) Božidar S. Radulović, Baku 30/5, 81000, Podgorica

(511) Klasa 9: Računarski hardver; snimač glasova u pilotskoj kabini i podataka o letu; snimači i odašiljači podataka o parametrima leta; poluprovodnici; radio frekvencijski prekidači; detektori radara; testeri leta, naročito, računarski hardver i softver za izvođenje simulacije leta; žičani i bežični telefoni i telefonska oprema, naročito telefonski predajnici, habovi za telekomunikacijske mreže, konektori, prijemnici i drugi uređaji, proizvodi, oprema i komponente za telefonsku komunikaciju, naročito hardverski interfejs telefonske mreže, hardver za kontrolu sigurnosti telefonije, hardver za kontrolu telefonske multimedije, telefonski prekidači, ruteri i pretplatnički hardverski interfejs, koji se koriste u računarskim i komunikacijskim mrežama i sistemima; računarski softver koji se koristi za kontrolu i upravljanje satelitima u oblasti satelitske komunikacije; računarski softver za rudarenje podataka u oblasti strateških i taktičkih obaveštajnih podataka; računarski softver za telemetriju koji se koristi za prikupljanje i odašiljanje podataka sa terenske daljinske opreme, naročito sa satelita, vazduhoplova, projektila, pokretnih kopnenih sistema, daljinski konfigurisanih fiksnih instalacija i obaveštajne Komunikacije, Komande i Kontrole; računarski softver koji se koristi za prikupljanje i odašiljanje podataka na polju medicinske tehnologije, naročito za rentgenske mašine, mašine sa magnetskim sensorima, mašine sa akustičnim sensorima, mašine za hemijsko praćenje; računarski softver koji se koristi za kontrolu i upravljanje opremom u realnom vremenu, naročito rentgenskim mašinama, mašinama sa magnetskim sensorima, mašinama sa akustičnim sensorima, mašinama za hemijsko praćenje, instrumentima za kontrolu leta, opremom za sigurnost leta, naročito snimačima glasova, telemetrijskim sistema na avionima, sistemima za održavanje na avionima, telemetrijskim skenerima, sistemima za detektovanje upada, sistemima za bodovanje borbe i slika, sistemima za upravljanje vazdušnim saobraćajem, monitorima, videofotoaparatom, radarskim sistema i sistemima za status i nadzor vozila; računarski softver za prepoznavanje i prezentaciju situacija sistema, u kontrolnom sistemu komunikacije i povezivanja podataka; pojačivači kanala i filteri frekvencija za upotrebu u telekomunikacijama; računarski hardver za procesiranje informacije o elektronskom ključu, naročito, procesiranje informacije u vezi sa elektronskim šifrovanjem i drugim sigurnosnim tehnologijama; radio frekvencijski limiteri; harmonijski generatori; satelitski transponderi; kontrolori transpondera; sistemi sigurne komunikacije koji se sastoje od digitalnih procesora, modulatora, antena, odašiljača, prijemnika i hardvera i softvera za šifrovanje, za uređaje za procesiranje sigurnosnih algoritama, koji se koriste za prikupljanje, prenos i analizu informacija iz vazduha, satelita, zemlje i mora; komunikacijski sistemi koji se sastoje od mikrotalasnih komunikacijskih veza visokog protoka podataka i računarskog hardvera; komunikacijski sistemi koji se sastoje od telefonskih komponenata i komponenata mikrotalasnog radija visokog protoka podataka, digitalnih procesora, računarskog hardvera, softvera koji sadrži algoritme koji se koriste u procesiranju sigurnih komunikacija i softvera za sigurno emitovanje i/ili prijem komunikacija i informacija ili podataka; satelitska oprema koja obezbeđuje mogućnosti podsistema, naročito, elektronski moduli i štampana kola za digitalno snimanje elektronskih podataka u čvrstom stanju, procesiranje video signala, procesiranje i translacija komunikacijskih signala; mikrotalasni uređaji, oprema, proizvodi i komponente, naročito, frekvencijski transmitori, frekvencijski konverteri, frekvencijski

sintisajzeri, frekvencijski modulatori, frekvencijski filteri, frekvencijski pojačivači snage, pasivne komponente, mehanički prekidači, bežični frekvencijski sistem za nadzor i prateći sklopovi štampanih kola za implementaciju elektronskih komponenti koje obezbeđuju određivanje frekvencije, karakterizaciju frekvencije, status frekvencije i kontrolu frekvencije; oprema za radio navigaciju koja se sastoji od mikrotalasne opreme za odašiljanje i primanje snimaka, naročito, mikroprocesora, elektronskih displeja, uređaja za digitalno skladištenje, radio odašiljača i prijemnika, koja obezbeđuje sledeće mogućnosti: navigaciju, komandovanje i kontrolu vozila, indikacije i upozorenja vozila, snimanje podataka i telemetrije; oprema i uređaji za nadgledanje, naročito, ISR (obaveštavanje, nadzor i izviđanje) podsistemi koji koriste računarski hardver i softver za obezbeđivanje sempliranja elektromagnetnog spektra sa unapred definisanom frekvencijom da bi se izvukla informacija koja se može analizirati, za potrebe vojnog i civilnog vazduhoplovstva; elektronski senzori koji u realnom vremenu obezbeđuju mogućnost prikupljanja elektronskih podataka i informacija, naročito, hvatanje eksternog elektromagnetskog spektra i pretvaranje primljene energije u digitalni prikaz energije, procesiranje elektronskih podataka i informacija, naročito, filtriranje digitalnog prikaza energije i pretvaranje u vizualni ili audio prikaz informacije, analiza elektronskih podataka i informacija, naročito, poređenje georeferentne informacije, detektovanje bilo kakve promene i prikazivanje promene u cilju vizualne potvrde, pohranjivanje elektronskih podataka i informacija, naročito, prenos podataka i informacija do digitalnog skladišta i širenje elektronskih podataka i informacija, naročito, kreiranje informacija na osnovu elektronskih paketa koji se mogu poslati na bilo kojem odabranom prenosnom mediju do druge, udaljene lokacije; elektronski računarski hardver i softver, koji omogućava prikupljanje, monitoring, analizu, skladištenje i prezentaciju medicinskih slika; računarski mrežni uređaji i oprema, naročito hardver koji omogućava povezivanje analognih ili digitalnih signala sa postojećom PSTN (javna telefonska mreža) ili globalnom informacijskom mrežom i kreiranje mogućnosti da se isti ovi signali prenesu u sistem mobilne komunikacije; telefonski računarski hardver koji omogućava kreiranje bežične poslednje milje, naročito, bežične radio veze između centralnog izvora i destinacije, gde telefonija i sistem podataka imaju mogućnost fiksnog položaja ili mobilnog rada; komunikacijski terminali koji se sastoje od računarskog hardvera koji obezbeđuje kreiranje i povezivanje multimedijalnih komunikacijskih signala, uključujući analogne signale, glas, podatke i video, i omogućava da se signali povežu sa drugim komunikacijskim terminalima ili drugim mrežnim čvorovima; radio i televizijski transmisioni sistemi koji sadrže predajnike, monitore, mikserne signala, kodere i dekodere audio i video signala i opremu za editovanje, naročito, procesore signala; predajnici i prijemnici za satelitsku komunikaciju; računarski vođeni mrežni sistemi koji se sastoje od računarskog hardvera i softvera za prenos podataka između računara povezanih u mrežu i za upravljanje računarima i prenosom podataka u pomenutoj mreži; računarski informacioni sistemi koji sadrže računare i softver za obradu podataka, obradu teksta i prikaz podataka; avionski sistemi koji sadrže digitalne mape, optičke i žičane magistrale podataka (data bus), memorijske uređaje, instrumente za prikazivanje, pohranjivanje, procesiranje i vađenje podataka o vremenu, taktici, strategiji i sigurnosti, kontrolne uređaje za pilotske kabine i ekrani sa podacima; fazirana antenska rešetka; oprema za globalno pozicioniranje, koja se sastoji od procesora podataka i ekrana; sistemi komunikacije u kontroli leta koji se sastoje od računarskog hardvera i softvera za prikazivanje, transport, prenos, kontrolu, prebacivanje, usmeravanje i primanje informacija o vazдушnom saobraćaju; računari i računarski softver za konvertovanje slika u podatke i za analizu, prikazivanje i štampanje podataka, u oblasti dvo- i tro-dimenzionalne ekstrakcije, manipulacije, prikazivanja i geografske registracije slike; sigurni računarski vođeni sistemi,

koji se sastoje od računarskog hardvera i softvera i šifrovanih baza podataka, koji se svi koriste za obezbeđivanje i kontrolisanje sigurnosti i pristupa računarskoj mreži i informacijama koje se nalaze u njoj, naročito, praćenje vazdušnog saobraćaja i prenos šifriranih poruka do pilota, upravljanje bazama podataka, prenos datoteka i za povezivanje računara i baza podataka u mrežu i za upravljanje protoka; sistem upravljanja vazdušnim linijama, koji sadrži računare i softver za upravljanje bazama podataka i za razmenu informacija o avionima i radu aviona; procesori za analizu televizijskih signala, naročito, elektronski displej paneli za prikazivanje signala, terminali za evaluaciju signala, koji se primarno sastoje od hardvera, za analizu prilagođenih signala, sa integrisanim displejom i komponentama za softversku analizu, koje rade na industrijski standardnim računarima, i monitori za evaluaciju kvaliteta analognih i digitalnih signala, serveri za analizu medija za verifikaciju kvaliteta digitalnog medijskog sadržaja, interfejs moduli signala, ručni analizatori signala, optički analizatori signala, testeri kola za monitoring emitovanih signala i alati za video monitoring, naročito, alati za video monitoring zasnovan na softveru, naročito, računarski softver za monitoring i logovanje glasnoće medijskog sadržaja; generatori vremenske reference, naročito, generatori signala vremenske reference za generisanje vremenskog i testnog signala sistema za emitovanje; hardver i računarski softver za televizijsku produkciju, post produkciju i emitovanje, naročito, demodulatori, digitalne oznake, naročito, dinamički elektronski displeji i mrežni računarski serveri i računarski softver za upravljanje i kontrolu dinamičkih elektronskih displeja, distribucionih pojačala, audio/video editora, naročito, računarske radne stanice opremljene računarskim softverom za editovanje audio i video programskih materijala, računarski hardver i računarski softver koji se prodaje kao integralna jedinica za generisanje karaktera i grafike, računarski softver za generisanje vizuelnih efekata, računarski hardver i računarski softver koji se prodaje kao integralna jedinica za generisanje i ubacivanje uživo reklama, modula sa hitnim upozorenjima, naročito, kompjuterizovani elektronski moduli i pripadajući računarski softver za implementaciju emitovanja javnih poruka sa hitnim upozorenjima, optički transporter signala, elektronski glavni kontrolni prekidači audio i video signala, kompresori audio i video signala i dekompresori audio i video signala, multiplekseri i demultiplekseri, multiekrani, aplikacioni softver za monitoring i kontrolu računarske mreže za emitovanje, elektronski mrežni kontrolni paneli, prijemnici i dekoderi za audio zapis, video zapis i podatke, elektronski usmerivački prekidači za audio i video signale, video serveri, video računarske mreže, NTP (protokol mrežnog vremena) vremenski moduli koji se primarno sastoje od računarskog hardvera i računarskog softvera za obavljanje NTP sinhronizacije vremena, satovi vremenskog signala, moduli za transport signala, audio/video sinhronizatori i upravljači vremena, koji se primarno sastoje od kola sa generisanim visoko preciznim satovima za sinhronizaciju tona sa slikom, legalizatori signala emitovanja, računarski softver za kreiranje i prikazivanje markera sa vremenskim kodom, više-niže frekvencijski konverteri signala, unakrsni konverteri formata signala, svi za upotrebu u industriji medija i zabave; emitterski softver za oglašavanje, prodaju, promet i naplatu, automatizaciju, upravljanje digitalnom imovinom, programiranje i upravljanje pravima, naročito, računarski softver za upravljanje, nadgledanje i automatizaciju kupovine, prodaje, planiranja, istraživanja, upravljanja inventarom, praćenja produkcije i procesa računovodstva za oglašavanje, i za opšti sadržaj za industriju medija i zabave; računarski softver za kontrolisanje i nadzor prekidačkih sistema za televizijske i radio signale; računarski softver za upravljanje, nadgledanje i automatizaciju kreiranja, pomeranja, lociranja, arhiviranja, vađenja i korišćenja digitalne medijske imovine; računarski softver, naročito softver za upravljanje poslovnim procesima i porukama, za upravljanje i kontrolu humanog i automatskog procesa

rada i multisistemske komunikacije, za korišćenje u industriji medija i zabave; mrežni centri upravljanja koji se primarno sastoje od mobilnih i prenosnih radio aparata i takođe sadrže kontrolore električnih baznih stanica, kontrolore elektronske komunikacije i kontrolore električne mreže; mobilni i stacionarni dvosmerni radio aparati za komunikaciju; prenosivi dvosmerni radio aparati za komunikaciju; getveji radio mreža koji sadrže računare, računarske prekidače i pripadajući računarski softver za glasovnu komunikaciju i komunikaciju podacima; mreže na bazi internet protokola koje sadrže računarski hardver i računarski softver za interoperabilnu komunikaciju; oprema za telekomunikaciju, naročito, trunkingovani radio komunikacioni sistemi za javni servis i industrijsku primenu, koji se sastoje od prenosnih komunikacijskih radio aparata, kontrolora električne bazne stanice, kontrolora elektronske komunikacije i prekidača kola; kontrolna oprema za dvosmerne mobilne i dvosmerne fiksne radio aparate, naročito, oprema bazne stanice za fiksne i mobilne mreže i komunikacije, bazni tornjevi koji se primarno sastoje od elektronskog hardvera, računarskog softvera, antene i baznih stanica, kontrolne stanice koje se primarno sastoje od radio aparata, radijskog hardvera i pripadajućeg računarskog softvera, desktop kontrolne stanice koje se primarno sastoje od radio aparata, radijskog hardvera i pripadajućeg računarskog softvera, dispečerski i konzolni hardver, naročito, dispečerske konzole i softver za obavljanje hitne i ne hitne komunikacije i obavljanje komandovanja i kontrole javne bezbednosti osoblja i imovine, računarski hardver i softver za upravljanje na licu mesta, za upravljanje komunikacijskim radio aparatima i baznim stanicama, i računarski hardver i softver za mrežno nadgledanje, za nadgledanje komunikacijskih radio aparata i baznih stanica; radijski komunikacijski sistemi koji primarno sadrže mobilne komunikacijske radio aparate i takođe sadrže nepokretne komunikacijske radio aparate, prenosne komunikacijske radio aparate, kontrolore bazne stanice, kontrolore komunikacije, i kontrolore mreže; getveji komunikacijskih radio mreža, koji se primarno sastoji od računara, računarskih prekidača i pripadajućeg računarskog softvera za obezbeđivanje getveja između mreža; svemirski rasporedivi reflektori za satelitsku komunikaciju; računari i računarski softver za konvertovanje oblaka podataka o elevaciji iz udaljenog uređaja sa senzorom u podatke, i za analizu, prikazivanje i štampanje podataka, u oblasti trodimenzionalne ekstrakcije, manipulacije, prikaza i geografskog registrovanja; računari i računarski softver za upravljanje, katalogizaciju i pozivanje geoprostornih slika, proizvoda izvedenih iz slika i drugih obaveštajnih proizvoda, kroz sinhronizaciju kataloga podataka preko disparatnih skladišnih lokacija; računari i računarski softver za upravljanje, procesiranje, eksploataciju i distribuciju pokretnih slika sa obaveštajnim podacima; računari i računarski softver za upravljanje, procesiranje, eksploataciju i distribuciju prezentacija o planiranju leta pilotima opšteg vazduhoplovstva i kontrolorima leta; mrežni komunikacijski radio aparati; brodski komunikacijski terminali koji se primarno sastoje od antene, postolja, pozicionera, modema, konvertera na više frekvence, konvertera na niže frekvence, pojačivača i korisničkog interfejsa; zemaljski komunikacijski terminali koji se primarno sastoje od antene, postolja, pozicionera, modema, konvertera na više frekvence, konvertera na niže frekvence, pojačivača i korisničkog interfejsa; računarski informacioni sistemi koji se uglavnom sastoje od računara i računarskog softvera za procesiranje podataka, procesiranje teksta i prikazivanje podataka u oblastima popisnog informacijskog sistema, zdravstvenog informacijskog sistema, pametnih sistema distribucije električne energije, sistema izveštavanja o i prognoze vremenskih prilika i sistema za ekološko predviđanje i izveštavanje; avionska oprema, naročito, kompresori i dekompresori video signala, izvori snage, montažni nosači posebno adaptirani za montiranje i povezivanje električnih aparata, procesori vazduhoplovnih signala za mrežnu interoperabilnost i ciljanje, sigurni mrežni

prekidači, računarski softver u vidu mrežnih protokola za olakšavanje razmene elektronskih poruka i podataka, radio frekventne (RF) veze podataka za oružje, UHF/VHF bežične veze podataka, elektronika faziranih antenskih rešetki, naročito elektronika generatora signala koja se primarno sastoji od pojačivača snage, a takođe sadrži i pojačivač niskog šuma, pomerač faze, jedinicu vremenskog kašnjenja, prekidače odašiljanja i primanja, jedinicu za deljenje, jedinicu za kombinovanje, konverter na više frekvence, konverter na niže frekvence, kontrolore niza i nizove napajanja i kontrolnu opremu, naročito kontrolne jedinice antene, referentne jedinice određivanja pozicije i pravca, kontrolne jedinice odašiljača/prijemnika, kontrolori pozicije antene i prekidači za selekciju frekvencijskog opsega; komunikacijski sistemi kontrole leta, koji se sastoje od računarskog hardvera i računarskog softvera za prikazivanje, prenos, kontrolu, prebacivanje, usmeravanje i primanje podataka o vremenskim prilikama; dvosmerni radio aparati za komunikaciju putem glasa, podataka, slika i videa, za upotrebu od strane vojnih i drugih vladinih agencija; dvosmerni komunikacijski radio uređaji, naročito, komunikacijski radio aparati za glas i podatke, koji mogu da rade na više frekventnih opsega, da bi se omogućilo službenicima javne bezbednosti i prvim responderima, kao što su agencije za sprovođenje zakona, hitna pomoć, vatrogasci i vojno osoblje da međusobno interoperabilno komuniciraju, iako njihova postojeća komunikacijska infrastruktura možda nije međusobno kompatibilna; trunkigovani radio komunikacijski sistemi za javni servis i industrijsku primenu, naročito, bazne stanice mobilne telefonije i bazne stanice mobilnog radija za dvosmernu mobilnu telefoniju i fiksne komunikacijske radio aparate; zvučnici za mobilne dvosmerne komunikacijske radio aparate; zvučnici za stacionarne dvosmerne komunikacijske radio aparate; punjači baterija za dvosmerne komunikacijske radio aparate; komunikacijske mreže na bazi internet protokola koje primarno sadrže računarski hardver i računarski softver za implementaciju interoperabilnih komunikacija; kriptografski moduli, naročito, elektronski moduli sa ugrađenim firmverom u svrhu šifrovanja podataka; integrisana kola, naročito mašine za šifrovanje; radio frekvencijski bežični komunikacijski adapteri, naročito, mrežne interfejs karte; softver za upravljanje radio frekvencijskim bežičnim mrežnim interfejs kartama; komunikacijski softver za povezivanje radio frekvencijskih bežičnih mrežnih interfejs karti sa lokalnom komunikacijskom mrežom; radijski mrežni getvej koji se primarno sastoji od računara, računarskih prekidača i računarskog softvera, na polju glasovne komunikacije i komunikacije podacima; računarski softver koji se koristi na polju kontrole leta, naročito, za nadzor, održavanje, administriranje, rešavanje problema i konfigurisanje računarskog softvera za nadgledanje performansi sistema kontrole leta, definisanje mapiranja, apodovanje ažuriranog softvera i novih verzija, kontrolu pristupa, korisničke definicije, dodeljivanje sklopova, uređivanje hardvera, obnavljanje i izveštavanje o dijagnostici.

Klasa 35: Usluge savetovanja i konsultacija u vezi sa upravljanjem logistikom u oblasti telekomunikacija; usluge poslovne konsultacije i pomoći u radu telekomunikacijskih sistema i mreža za druge; usluge poslovne konsultacije i pomoći u oblasti upravljanja telekomunikacijskim mrežama, naročito rad sa i administracija telekomunikacijskih mreža i komunikacijskih veza za druge.

Klasa 37: Tehničko konsultovanje na polju gradnje fiksnih zemaljskih postrojenja; tehničko konsultovanje i asistencija na polju konstruisanja, popravke i održavanja podmornica i brodova; tehničko konsultovanje koje se odnosi na instalaciju, popravku i održavanje mobilnih i fiksnih postrojenja na zemlji, satelita i odnosnih informacionih sistema, naročito, sigurnosnih informacija, komunikacija, mikrotalasnih proizvoda i telemetrije i instrumentacije; tehničko konsultovanje i asistencija na polju raspoređivanja/upotrebe opreme i sistema računarskog hardvera; usluge nadgradnje informacione tehnologije (IT) i

komunikacijske infrastrukture, naročito, ažuriranje računarskog hardvera za IT i komunikacijske sisteme; usluge održavanja telekomunikacijskih sistema, naročito, održavanje radio, televizijske i digitalne komunikacijske opreme za druge.

Klasa 38: Tehničko konsultovanje na polju satelitske komunikacije i komunikacije putem povezanih komunikacijskih informacijskih sistema, naročito, komunikacije putem satelitskog prenosa, mikrotalasnih proizvoda i telemetrije i instrumentacije; usluge konsultovanja i tehničke asistencije na polju sigurne komunikacije i telemetrije.

Klasa 42: Tehničko konsultovanje i asistencija na polju avijacije; informacijsko tehnološko konsultovanje u oblasti podmornica i brodova, mobilnih i fiksnih postrojenja na zemlji, satelita i odnosnih informacionih sistema, naročito u vezi sa sigurnošću podataka, komunikacijama, mikrotalasnim proizvodima i telemetrijom i instrumentacijom; projektovanje računarskih sistema za integraciju softvera, održavanje i korisničke usluge, sisteme podrške za integraciju softvera, održavanje i planiranje usluga podrške i provizioniranja, i provizioniranje kontrole usluge podrške za satelitske kontrolne mreže, odbrambene komunikacijske sisteme u realnom vremenu, i odbrambene sisteme za prikupljanje obaveštajnih podataka u realnom vremenu; projektovanje računarskih sistema za inženjersku podršku za lansiranje satelita, raspoređene komunikacijske sisteme i raspoređene sisteme za prikupljanje obaveštajnih podataka; konsultovanje i tehnička asistencija na polju prilagođavanja računarskog hardvera i softvera; konsultovanje i asistencija u vezi sa uslugama upravljanja računarskim programom, uslugama upravljanja računarom na licu mesta, i raspoređivanjem i upravljanjem bežičnim komunikacijskim mrežama drugih i uslugama upravljanja komunikacijskim vezama; usluge tehničke podrške, naročito, rešavanje problema u smislu dijagnostikovanja i testiranja problema računarskog hardvera i softvera; obezbeđivanje interaktivnog veb-sajta koji omogućava korisnicima ulaz, pristup, nadgledanje i generisanje projektovanih strateških i taktičkih signalnih izveštaja o obaveštajnim podacima; usluge migracije IT i komunikacijske infrastrukture; usluge raspoređivanja IT i komunikacijske infrastrukture; usluge tehničke podrške, naročito migracija centra za podatke, servera i aplikacija za baze podataka; usluge migracije podataka; upravljanje uslugama na bazi sigurne informacione tehnologije (IT) za druge, naročito, upravljanje IT softverskim aplikacijama, upravljanje uslugama za preduzeća, naročito, upravljanje softverskim aplikacijama, upravljanje proverom informacija, naročito, upravljanje restriktivnim mrežama, podacima i pristupom informacijama i upravljanje pregledom i eliminacijom neautorizovanih podataka i programa iz datoteka i mreža i menadžment sajber sigurnosti, naročito, održavanje računarskog softvera koje se odnose na sigurnost računara i sprečavanje računarskih rizika; usluge konsultovanja na polju računarskog hardvera i softvera; tehničko konsultovanje na polju telekomunikacijskih tehnologija; tehničko konsultovanje na polju informacione tehnologije (IT); ažuriranje i održavanje računarskog softvera, usluge integracije informacione tehnologije (IT); usluge tehničke podrške, naročito, nadgledanje mrežnih sistema; daljinsko tehnološko nadgledanje računarske mreže i usluge održavanja softvera; računarske usluge, naročito daljinsko upravljanje sistema informacione tehnologije (IT) drugih; planiranje, projektovanje i upravljanje sistemima informacione tehnologije (IT); projektovanje računarskog hardvera i softvera; projektovanje računarske mreže za druge; usluge obezbeđivanja informacija za zaštitu poverljivosti, integriteta i dostupnosti informacionih sistema i važnih poslovnih podataka drugih, naročito, projektovanje, raspoređivanje i upravljanje sigurnim komunikacijskim sistemima i informacijskim mrežama, za zaštitu poverljivosti, integriteta i raspoloživosti informacijskih sistema i važnih poslovnih podataka drugih; usluge projektovanja telekomunikacijskih sistema, naročito, projektovanje radio, televizijske i

digitalne komunikacijske opreme za druge, i projektovanje i integracija računarskih sistema i mreža za druge, naročito, projektovanje i integracija telefonskih sistema, komunikacijskih sistema i sistema za prikazivanje.

Klasa 45: Konsultovanje i tehnička asistencija na polju usluga informacione sigurnosti i obaveštajne sigurnosti za sigurnu i nesigurnu komunikaciju putem glasa, podataka i videa, korisničku autorizaciju, prepoznavanje i šifrovanje poruka.

(111) **14978**

(151) 30.10.2020.

(210) Ž-2019-360

(220) 20.09.2019.

(732) L3Harris Technologies, Inc. (Delaware corporation), 1025 West NASA Boulevard, 32919, Melbourne, Florida, US

(540)



(550) I

(740) Božidar S. Radulović, Baku 30/5, 81000, Podgorica

(511) Klasa 9: Računarski hardver; snimač glasova u pilotskoj kabini vazduhoplova i podataka o letu; snimači i odašiljači podataka o parametrima leta; poluprovodnici; radio frekvencijski prekidači; detektori radara; tester leta, naročito, računarski hardver i softver za izvođenje simulacije leta; računarski softver za simulaciju leta; telefonski predajnici; habovi za telekomunikacijske mreže; konektori za telekomunikacijske mreže; prijemnici za telekomunikacijske mreže; hardverski interfejs telefonske mreže; hardver za kontrolu sigurnosti telefonije; hardver za kontrolu telefonske multimedije; telefonski prekidači, ruteri i pretplatnički hardverski interfejs, koji se koriste u računarskim i komunikacijskim mrežama i sistemima; računarski softver koji se koristi za upravljanje i kontrolu u oblasti satelitske komunikacije; računarski softver za rudarenje u oblasti strateških i taktičkih obaveštajnih podataka; računarski softver za telemetriju koji se koristi za prikupljanje i odašiljanje podataka, sa satelita, vazduhoplova, projektila, pokretnih kopnenih sistema, daljinski konfigurisanih fiksnih instalacija; računarski softver koji se koristi za prikupljanje i odašiljanje podataka za medicinske rentgenske mašine, mašine sa magnetskim sensorima, mašine sa akustičnim sensorima, mašine za hemijsko praćenje; računarski softver koji se koristi za kontrolu i upravljanje opremom u realnom vremenu; računarski softver za upravljanje i kontrolu rentgenskih mašina; računarski softver za upravljanje i kontrolu mašina sa magnetskim sensorima; računarski softver za upravljanje i kontrolu mašina za medicinski imidžing (vizuelno snimanje); računarski softver za upravljanje i kontrolu mašina sa akustičnim sensorima; računarski softver za upravljanje i kontrolu mašina za hemijsko praćenje; instrumenti za kontrolu leta; oprema za sigurnost leta, naročito snimači glasova, telemetrijski sistemi za upotrebu na vazduhoplovima; računarski softver koji se koristi za

upravljanje i kontrolu vazduhoplovnih sistema za održavanje na vazduhoplovima; računarski softver za upravljanje i kontrolu telemetrijskih skenera; sistemi za detektovanje upada; računarski softver za upravljanje i kontrolu sistema za bodovanje borbe i slika, računarski softver za upravljanje i kontrolu sistema za upravljanje vazдушnim saobraćajem; računarski softver za upravljanje i kontrolu monitora, foto aparata i video kamera; računarski softver za upravljanje i kontrolu radarskih sistema; računarski softver koji se koristi za sisteme statusa i nadzora vozila; računarski softver za prepoznavanje i prezentaciju situacija sistema, u kontrolnom sistemu komunikacije i povezivanja podataka; telekomunikacioni pojačivači kanala; filteri frekvencija za upotrebu u telekomunikacijama; računarski hardver za procesiranje informacije o elektronskom ključu, naročito, procesiranje informacije u vezi sa elektronskim šifrovanjem i drugim sigurnosnim tehnologijama; radio frekvencijski limiteri; harmonijski generatori; satelitski transponderi; kontrolori transpondera; sistemi sigurne komunikacije koji se sastoje od digitalnih procesora, modulatora, antena, odašiljača, prijemnika i hardvera i softvera za šifrovanje, za uređaje za procesiranje sigurnosnih algoritama, koji se koriste za prikupljanje, prenos i analizu informacija iz vazduha, satelita, zemlje i mora; komunikacijski sistemi koji se sastoje od mikrotalasnih komunikacijskih veza visokog protoka podataka i računarskog hardvera; komunikacijski sistemi koji se sastoje od telefonskih komponenata i komponenata mikrotalasnog radija visokog protoka podataka, digitalnih procesora, računarskog hardvera, softvera koji sadrži algoritme koji se koriste u procesiranju sigurnih komunikacija i softvera za sigurno emitovanje i/ili prijem komunikacija i informacija ili podataka; ugrađena satelitska oprema koja obezbeđuje mogućnosti podsistema, naročito, elektronski moduli i štampana kola za digitalno snimanje elektronskih podataka u čvrstom stanju, procesiranje video signala, procesiranje i translacija komunikacijskih signala; mikrotalasni uređaji, oprema, proizvodi i komponente, naročito, frekvencijski transmitori, frekvencijski konverteri, frekvencijski sintisajzeri, frekvencijski modulatori, frekvencijski filteri, frekvencijski pojačivači snage, pasivne komponente, mehanički prekidači, bežični frekvencijski monitori; oprema za radio navigaciju koja se sastoji od mikrotalasne opreme za odašiljanje i primanje snimaka, naročito, mikroprocesora, elektronskih displeja, uređaja za digitalno skladištenje, radio odašiljača i prijemnika, koja obezbeđuje sledeće mogućnosti: navigaciju, komandovanje i kontrolu vozila, indikacije i upozorenja vozila, snimanje podataka i telemetrije; oprema i uređaji za nadgledanje, naročito, ISR (obaveštavanje, nadzor i izviđanje) podsistemi koji koriste računarski hardver i softver za obezbeđivanje sempliranja elektromagnetnog spektruma sa unapred definisanom frekvencijom da bi se izvukla informacija koja se može analizirati, za potrebe vojnog i civilnog vazduhoplovstva; elektronski senzori koji u realnom vremenu obezbeđuju mogućnost prikupljanja elektronskih podataka i informacija; elektronski računarski hardver i softver, koji omogućava prikupljanje, monitoring, analizu, skladištenje i prezentaciju medicinskih slika; hardver koji omogućava povezivanje analognih ili digitalnih signala sa postojećom PSTN (javna telefonska mreža) ili globalnom informacijskom mrežom i kreiranje mogućnosti da se isti ovi signali ubace u sistem mobilne komunikacije; telefonski računarski hardver koji omogućava kreiranje bežične poslednje milje, naročito, bežične radio veze između centralnog izvora i destinacije, gde telefonija i sistem podataka imaju mogućnost fiksnog položaja ili mobilnog rada; komunikacijski terminali koji se sastoje od računarskog hardvera koji obezbeđuje kreiranje i povezivanje multimedijalnih komunikacijskih signala, uključujući analogne signale, glas, podatke i video, i omogućava da se signali povežu sa drugim komunikacijskim terminalima ili drugim mrežnim čvorovima; radio i televizijski transmisioni sistemi koji sadrže predajnike, monitore, mikse signala, kodere i dekodere audio i video signala i opremu za editovanje, naročito, procesore signala; predajnici i

prijemnici za satelitsku komunikaciju; računarski vođeni mrežni sistemi koji se sastoje od računarskog hardvera i softvera za prenos podataka između računara povezanih u mrežu i za upravljanje računarima i prenosom podataka u pomenutoj mreži; računarski informacioni sistemi koji sadrže računare i softver za obradu podataka, obradu teksta i prikaz podataka; avionski sistemi koji sadrže digitalne mape, optičke i žičane magistrale podataka (data bus), memorijske uređaje, instrumente za prikazivanje, pohranjivanje, procesiranje i vađenje podataka o vremenu, taktici, strategiji i sigurnosti, kontrolne uređaje za pilotske kabine i ekrane sa podacima; fazirana antenska rešetka; oprema za globalno pozicioniranje, koja se sastoji od procesora podataka i ekrana; računarski softver i računarski hardver za upotrebu u sistemima komunikacije u kontroli leta za prikazivanje transporta, prenos glasa, podataka i slika, kontrolu, prebacivanje, usmeravanje i primanje informacija o vazдушnom saobraćaju; računari i računarski softver za konvertovanje slika u podatke i za analizu, prikazivanje i štampanje podataka, u oblasti dvo- i tro-dimenzionalne ekstrakcije, manipulacije, prikazivanja i geografske registracije slike; sigurni računarski vođeni sistemi, koji se sastoje od računarskog hardvera i softvera i šifrovanih baza podataka, koji se svi koriste za obezbeđivanje i kontrolisanje sigurnosti i pristupa računarskoj mreži i informacijama koje se nalaze u njoj, naročito, praćenje vazdušnog saobraćaja i prenos šifrovanih poruka do pilota, upravljanje bazama podataka, prenos datoteka i za povezivanje računara i baza podataka u mrežu i za upravljanje protoka avio saobraćaja; sistem upravljanja vazдушnim linijama, koji sadrži računare i softver za upravljanje bazama podataka i za razmenu informacija o avionima i radu aviona; procesori za analizu televizijskih signala, naročito, elektronski displej paneli za prikazivanje signala, terminali za evaluaciju signala, koji se primarno sastoje od hardvera, za analizu prilagođenih signala, sa integrisanim displejom i komponentama za softversku analizu, koje rade na industrijski standardnim računarima, i monitor za evaluaciju kvaliteta analognih i digitalnih signala, serveri za analizu medija za verifikaciju kvaliteta digitalnog medijskog sadržaja, interfejs moduli signala, ručni analizatori signala, optički analizatori signala, tester kola za monitoring emitovanih signala i alati za video monitoring, naročito, alati za video monitoring zasnovan na softveru, naročito, računarski softver za monitoring i logovanje glasnoće medijskog sadržaja; generatori vremenske reference, naročito, generatori signala vremenske reference za generisanje vremenskog i testnog signala sistema za emitovanje; hardver i računarski softver za televizijsku produkciju, post produkciju i emitovanje, naročito, demodulatori, digitalne oznake, naročito, dinamički elektronski displeji i mrežni računarski serveri i računarski softver za upravljanje i kontrolu dinamičkih elektronskih displeja, distribucionih pojačala, audio/video editora, naročito, računarske radne stanice opremljene računarskim softverom za editovanje audio i video programskih materijala, računarski hardver i računarski softver koji se prodaje kao integralna jedinica za generisanje karaktera i grafike, računarski softver za generisanje vizuelnih efekata, računarski hardver i računarski softver koji se prodaje kao integralna jedinica za generisanje i ubacivanje uživo reklama, modula sa hitnim upozorenjima, naročito, kompjuterizovani elektronski moduli i pripadajući računarski softver za implementaciju emitovanja javnih poruka sa hitnim upozorenjima, optički transporter signala, elektronski glavni kontrolni prekidači audio i video signala, kompresori audio i video signala i dekompresori audio i video signala, multiplekseri i demultiplekseri, multiokrani, aplikacioni softver za monitoring i kontrolu računarske mreže za emitovanje, elektronski mrežni kontrolni paneli, prijemnici i dekoderi za audio zapis, video zapis i podatke, elektronski usmerivački prekidači za audio i video signale, video serveri, NTP (protokol mrežnog vremena) vremenski moduli koji se primarno sastoje od računarskog hardvera i računarskog softvera za obavljanje NTP sinhronizacije vremena, satovi vremenskog signala, moduli za

transport signala, audio/video sinhronizatori i upravljači vremena, koji se primarno sastoje od kola sa generisanim visoko preciznim satovima za sinhronizaciju tona sa slikom, računarski softver za kreiranje i prikazivanje markera sa vremenskim kodom, više-niže frekvencijski konverteri signala, unakrsni konverteri formata signala, svi za upotrebu u industriji medija i zabave; emitterski softver za oglašavanje, prodaju, promet i naplatu, automatizaciju, upravljanje digitalnom imovinom, programiranje i upravljanje pravima, naročito, računarski softver za upravljanje, nadgledanje i automatizaciju kupovine, prodaje, planiranja, istraživanja, upravljanja inventarom, praćenja produkcije i procesa računovodstva za oglašavanje, i za opšti sadržaj za industriju medija i zabave; računarski softver za kontrolisanje i nadzor prekidačkog sistema za televizijske i radio signale; računarski softver za upravljanje, nadgledanje i automatizaciju kreiranja, pomeranja, lociranja, arhiviranja, vađenja i korišćenja digitalne medijske imovine; softver za upravljanje poslovnim procesima i za porukama, za upravljanje i kontrolu humanog i automatskog procesa rada i multisistemske komunikacije, za korišćenje u industriji medija i zabave; mrežni centri upravljanja koji se primarno sastoje od mobilnih i prenosnih radio aparata i takođe sadrže kontrolore električnih baznih stanica, kontrolore elektronske komunikacije i kontrolore električne mreže; mobilni i stacionarni dvosmerni radio aparati za komunikaciju; prenosivi dvosmerni radio aparati za komunikaciju; getveji radio mreža koji sadrže računare, računarske prekidače i pripadajući računarski softver za glasovnu komunikaciju i komunikaciju podacima; mreže na bazi internet protokola koje sadrže računarski hardver i računarski softver za interoperabilnu komunikaciju; oprema za telekomunikaciju, naročito, trunkingovani radio komunikacioni sistemi za javni servis i industrijsku primenu, koji se sastoje od prenosnih komunikacijskih radio aparata, kontrolora električne bazne stanice, kontrolora elektronske komunikacije i prekidača kola; kontrolna oprema za dvosmerne mobilne i dvosmerne fiksne radio aparate, naročito, oprema bazne stanice za fiksne i mobilne mreže i komunikacije, bazni tornjevi koji se primarno sastoje od elektronskog hardvera, računarskog softvera, antene i baznih stanica, kontrolne stanice koje se primarno sastoje od radijskog hardvera i pripadajućeg računarskog softvera, desktop kontrolne stanice koje se primarno sastoje od radio aparata, radijskog hardvera i pripadajućeg računarskog softvera, dispečerski i konzolni hardver, naročito, dispečerske konzole i softver za obavljanje hitne i ne-hitne komunikacije i obavljanje komandovanja i kontrole javne bezbednosti osoblja i imovine, računarski hardver i softver za upravljanje na licu mesta, za upravljanje komunikacijskim radio aparatima i baznim stanicama, i računarski hardver i softver za mrežno nadgledanje, za nadgledanje komunikacijskih radio aparata i baznih stanica; radijski komunikacijski sistemi koji primarno sadrže mobilne komunikacijske radio aparate i takođe sadrže nepokretne komunikacijske radio aparate, prenosne komunikacijske radio aparate, kontrolore bazne stanice, kontrolore komunikacije, i kontrolore mreže; getveji komunikacijskih radio mreža, koji se primarno sastoji od računara, računarskih prekidača i pripadajućeg računarskog softvera za obezbeđivanje getveja između mreža; prostorno rasporedivi reflektori za satelitsku komunikaciju; računari i računarski softver za obradu podataka o geografskoj elevaciji koja se odnosi na elevaciju lokacija na zemlji, kako bi se generisao, prikazao i štampao trodimenzionalni geografski registrovani prikaz takvih lokacija; računari i računarski softver za upravljanje, katalogizaciju i pozivanje geoprostornih slika, proizvoda izvedenih iz slika i drugih obaveštajnih proizvoda, kroz sinhronizaciju kataloga podataka preko disparatnih skladišnih lokacija; računari i računarski softver za upravljanje, procesiranje, eksploataciju i distribuciju pokretnih slika sa obaveštajnim podacima; računari i računarski softver za upravljanje, procesiranje, eksploataciju i distribuciju prezentacija o planiranju leta pilotima opšteg vazduhoplovstva i kontrolorima

leta; mrežni komunikacijski radio aparati; brodski komunikacijski terminali koji se primarno sastoje od antene, postolja, pozicionera, modema, konvertera na više frekvence, konvertera na niže frekvence, pojačivača i korisničkog interfejsa; zemaljski komunikacijski terminali koji se primarno sastoje od antene, postolja, pozicionera, modema, konvertera na više frekvence, konvertera na niže frekvence, pojačivača i korisničkog interfejsa; računarski informacijski sistemi koji se uglavnom sastoje od računara i računarskog softvera za procesiranje podataka, procesiranje teksta i prikazivanje podataka u oblastima popisnog informacijskog sistema, zdravstvenog informacijskog sistema, pametnih sistema distribucije električne energije, sistema izveštavanja o i prognoze vremenskih prilika i sistema za ekološko izveštavanje i predviđanje; avionska oprema, naročito, kompresori i dekompresori video signala, izvori snage, montažni nosači posebno adaptirani za montiranje i povezivanje električnih aparata, procesori vazduhoplovnih signala za mrežnu interoperabilnost oružja i ciljanje oružjem, sigurni mrežni prekidači, računarski softver u vidu mrežnih protokola za olakšavanje razmene elektronskih poruka i podataka, radio frekventne (RF) veze podataka za oružje, UHF/VHF bežične veze podataka, elektronika generatora signala koja se primarno sastoji od pojačivača snage, a takođe sadrži i pojačivač niskog šuma, pomerač faze, jedinicu vremenskog kašnjenja, prekidače odašiljanja i primanja, jedinicu za deljenje, jedinicu za kombinovanje, konverter na više frekvence, konverter na niže frekvence, kontrolore niza i nizove napajanja i kontrolnu opremu, kontrolne jedinice antene, referentne jedinice za određivanje pozicije i pravca, kontrolne jedinice odašiljača/prijemnika, kontrolore pozicije antene i selektivni prekidači frekvencijskog opsega; komunikacijski sistemi kontrole leta, koji se sastoje od računarskog hardvera i računarskog softvera za prikazivanje, prenos, kontrolu, prebacivanje, usmeravanje i primanje podataka o vremenskim prilikama; dvosmerni radio aparati za komunikaciju putem glasa, podataka, slika i videa, za upotrebu od strane vojnih i drugih vladinih agencija; dvosmerni komunikacijski radio uređaji, naročito, komunikacijski radio aparati za glas i podatke, koji mogu da rade na više frekventnih opsega, da bi se omogućilo službenicima javne bezbednosti i prvim responentima, kao što su agencije za sprovođenje zakona, hitna pomoć, vatrogasci i vojno osoblje, da međusobno inoperabilno komuniciraju, iako njihova postojeća komunikacijska infrastruktura možda nije međusobno kompatibilna; trunkigovani radio komunikacijski sistemi za javni servis i industrijsku primenu, naročito, bazne stanice mobilne telefonije i bazne stanice mobilnog radija za dvosmernu mobilnu telefoniju i fiksne komunikacijske radio aparate; zvučnici za mobilne dvosmerne komunikacijske radio aparate; zvučnici za stacionarne dvosmerne komunikacijske radio aparate; punjači baterija za dvosmerne komunikacijske radio aparate; komunikacijske mreže na bazi internet protokola koje primarno sadrže računarski hardver i računarski softver za implementaciju interoperabilnih komunikacija; kriptografski moduli, naročito, elektronski moduli sa ugrađenim firmverom u svrhu šifrovanja podataka; mašine za šifrovanje; radio frekvencijski bežični komunikacijski adapteri, naročito, mrežne interfejs karte; softver za upravljanje radio frekventnim bežičnim mrežnim interfejs kartama; komunikacijski softver za povezivanje radio frekvencijskih bežičnih mrežnih interfejs karti sa lokalnom komunikacijskom mrežom; radijski mrežni getvej koji se primarno sastoji od računara, računarskih prekidača i računarskog softvera, na polju glasovne komunikacije i komunikacije podacima; računarski softver koji se koristi na polju kontrole leta, naročito, za nadzor, održavanje, administriranje, rešavanje problema i konfigurisanje računarskog softvera za nadgledanje performansi sistema kontrole leta, definisanje mapiranja, aploadovanje ažuriranog softvera i novih verzija, kontrolu pristupa, korisničke definicije, obnavljanje i izveštavanje o dijagnostici.

Klasa 35: Usluge savetovanja i konsultacija u vezi sa poslovnim upravljanjem u oblasti

telekomunikacione logistike; usluge poslovne konsultacije i pomoći u radu telekomunikacijskih sistema i mreža za druge; usluge poslovne konsultacije i pomoći u oblasti telekomunikacija, naročito rad sa i administracija telekomunikacijskih mreža i komunikacijskih veza za druge.

Klasa 37: Tehničko konsultovanje na polju gradnje fiksnih zemaljskih postrojenja; tehničko konsultovanje i asistencija na polju konstruisanja, popravke i održavanja podmornica i brodova; tehničko konsultovanje koje se odnosi na instalaciju, popravku i održavanje mobilnih i fiksnih postrojenja na zemlji, satelita i odnosnih računarskih informacionih sistema; tehničko konsultovanje i asistencija na polju raspoređivanja opreme i sistema računarskog hardvera; usluge nadgradnje informacione tehnologije (IT) i komunikacijske infrastrukture, naročito, ažuriranje računarskog hardvera za IT i komunikacijske sisteme; usluge održavanja telekomunikacijskih sistema, naročito, održavanje radio, televizijske i digitalne komunikacijske opreme za druge.

Klasa 38: Tehničko konsultovanje na polju satelitske komunikacije i komunikacije putem povezanih komunikacijskih informacijskih sistema, naročito, komunikacija putem satelitskog prenosa, mikrotalasnih proizvoda i telemetrije i instrumentacije; usluge konsultovanja i tehničke asistencije na polju sigurne komunikacije i telemetrije.

Klasa 42: Tehničko konsultovanje i asistencija na polju avijacije; informacijsko tehnološko konsultovanje u oblasti podmornica i brodova, mobilnih i fiksnih postrojenja na zemlji, satelita i odnosnih informacionih sistema, naročito u vezi sa sigurnošću podataka, komunikacijama, mikrotalasnim proizvodima i telemetrijom i instrumentacijom; projektovanje računarskih sistema za integraciju softvera, održavanje i korisničke usluge, sisteme podrške za integraciju softvera, održavanje i planiranje usluga podrške i provizioniranja, i provizioniranje kontrole usluge podrške za satelitske kontrolne mreže, odbrambene komunikacijske sisteme u realnom vremenu, i odbrambene sisteme za prikupljanje obaveštajnih podataka u realnom vremenu; projektovanje računarskih sistema za inženjersku podršku za lansiranje satelita, raspoređene komunikacijske sisteme i raspoređene sisteme za prikupljanje obaveštajnih podataka; konsultovanje i tehnička asistencija na polju prilagođavanja računarskog hardvera i softvera; konsultovanje i asistencija u vezi sa uslugama upravljanja računarskim programom, uslugama upravljanja računarom na licu mesta, i raspoređivanjem i upravljanjem bežičnim komunikacijskim mrežama drugih i uslugama upravljanja komunikacijskim vezama; usluge tehničke podrške, naročito, rešavanje problema u smislu dijagnostikovanja i testiranja problema računarskog hardvera i softvera; obezbeđivanje interaktivnog veb-sajta koji omogućava korisnicima ulaz, pristup, nadgledanje i generisanje projektovanih strateških i taktičkih signalnih izveštaja o obaveštajnim podacima; usluge migracije IT i komunikacijske infrastrukture; usluge tehničkog projektovanja i raspoređivanja telekomunikacionih mreža i računarskih mreža za druge; usluge tehničke podrške za migraciju centra za podatke, servera i aplikacija za baze podataka; usluge migracije podataka; upravljanje IT softverskim aplikacijama, upravljanje uslugama za preduzeća, naročito, upravljanje softverskim aplikacijama, upravljanje restriktivnim mrežama i podacima, održavanje računarskog softvera koje se odnosi na sigurnost računara i sprečavanjem računarskog rizika; usluge konsultovanja na polju računarskog hardvera i softvera; tehničko konsultovanje na polju telekomunikacijskih tehnologija; tehničko konsultovanje na polju informacione tehnologije (IT); ažuriranje i održavanje računarskog softvera, usluge integracije informacione tehnologije (IT); usluge tehničke podrške, naročito, nadgledanje računarskih mreža putem daljinskog pristupa; daljinsko tehnološko nadgledanje računarske mreže i usluge održavanja softvera; daljinsko upravljanje sistema informacione tehnologije (IT) drugih; planiranje, projektovanje i

upravljanje sistemima informacione tehnologije (IT); projektovanje računarskog hardvera i softvera; projektovanje računarske mreže za druge; usluge obezbeđivanja informacija za projektovanje, raspoređivanje i upravljanje sigurnim komunikacijskim sistemima i informacijskim mrežama, za zaštitu poverljivosti, integriteta i raspoloživosti informacijskih sistema i važnih poslovnih podataka drugih; projektovanje radio, televizijske i digitalne komunikacijske opreme za druge; projektovanje i integracija telefonskih sistema, komunikacijskih sistema i sistema za prikazivanje informacija.

Klasa 45: Konsultovanje i tehnička asistencija na polju usluga informacione sigurnosti i obaveštajne sigurnosti za sigurnu i nesigurnu komunikaciju putem glasa, podataka i videa, korisničku autorizaciju, prepoznavanje i šifrovanje poruka.

(111) **14981**

(151) 03.11.2020.

(210) Ž-2019-415

(220) 30.10.2019.

(732) International Foodstuffs Co LLC, P.O. Box No. 4115, Sharjah, AE

(540)

AMBER

(550) I

(740) Miladin Popović, Đoka Miraševića 21/III, 81000, Podgorica

(511) Klasa 29: Jestiva ulja, masti, topljeno maslo, margarin, maslac, proizvodi za supu, mlijeko i mliječni proizvodi, mlijeko s ukusom, mliječni šejkovi, meso, riba, živina i divljač, mesni ekstrakti, konzervisano, sušeno i kuvano voće i povrće, prelive svih vrsta i opisa uključujući ne-mliječne prelive, slatka pavlaka, želei, džemovi, kompoti, jaja, grickalice na bazi krompira i bez krompira, čips od krompira i listići od krompira, sve vrste konzervisanog i osušenog sočiva, pasulja, graška i mahunarki (ne za poljoprivredne namjene), pečurke, konzervisani kikiriki.

Klasa 30: Čokolade, slatkiši, bombone, biskviti (svi tipovi), kolači, tjestenine, makaroni, rezanci, instant rezanci, špageti, rezanci za supu, kvasac, prašak za pecivo i ostali pekarski sastojci, prelive za salate, majonez, sirće, kečap i sosovi (začini), polu- gotovi proizvodi od tijesta, smrznuto tijesto, smrznute parate, sladoledi, ne- mliječni smrznuti deserti, smrznuti voćni deserti, ledeni deserti, kafa, čaj, kakao, šećer, pirinač, tapioka, sago, zamjena za kafu, hleb, pecivo, melasa, so, senf, brašno od žitarica, začini, prehrambena pića (proizvodi na bazi zrnavlja i bilja), umaci, biljni čaj, med.

(111) **14980**

(151) 03.11.2020.

(210) Ž-2019-361

(220) 20.09.2019.

(732) Colgate-Palmolive Company (a Delaware Corporation), 300 Park Avenue, 10022, New York, New York, US

(540)

COLGATE SMILE FOR GOOD

(550) I

(740) Jasna Jusić, Dalmatinska 2, 81000, Podgorica

(511) Klasa 3: Nemedicinska pasta za zube i nemedicinska tečnost za ispiranje usta.
Klasa 21: Četkice za zube.

(111) **14982**

(151) 03.11.2020.

(210) Ž-2019-422

(220) 31.10.2019.

(732) AL ATHEED GENERAL TRADING L.L.C, P.O.BOX 27142, DEIRA, AL-RASS, DUBAI, AE

(540)



(550) I

(740) Božidar S. Radulović, Studentska bb, Lamela 3/18, 81000, Podgorica

(511) Klasa 29: Meso, riba, živina i divljač; ekstrakti od mesa; konzervisano, sušeno i kuvano voće i povrće; žele, džemovi, kompoti; jaja, mlijeko i mliječni proizvodi; jestiva ulja i masti.

Klasa 30: Kafa, čaj, kakao i vještačka kafa; pirinač, tapioka i sago; brašno i proizvodi od žitarica; hleb, peciva i konditorski proizvodi; ledene poslastice; med, melasa; kvas, prašak za pecivo; so; senf; sirće, sos (začini); začini; led.

Klasa 32: Piva; mineralne i gazirane vode i druga bezalkoholna pića; voćni napici i voćni sokovi; sirupi i drugi preparati za pravljenje pića.

(111) **14983**

(151) 03.11.2020.

(210) Ž-2019-63

(220) 20.02.2019.

(300) US br. 88/100,628 od 31.08.2018.godine

(732) Bioverativ Therapeutics Inc. and Bioverativ Therapeutics Inc., 225 Second Avenue, 02451, WALTHAM, US and 225 Second Avenue, WALTHAM, Massachusetts 02451, US

(540)

CIBEMTOR

(550) I

(740) Božidar S. Radulović, Studentska bb, Lamela 3/18, 81000, Podgorica

(511) Klasa 5: Farmaceutski preparati za lečenje bolesti hladnih aglutinina i hronične imune trombocitopenije.

(111) **14984**

(151) 05.11.2020.

(210) Ž-2019-362

(220) 24.09.2019.

(732) Colgate-Palmolive Company (a Delaware Corporation), 300 Park Avenue, 10022, New York, New York, US

(540)



(550) I

(740) Jasna Jusić, Dalmatinska 2, 81000, Podgorica

(511) Klasa 3: Nemedicinska pasta za zube i nemedicinska tečnost za ispiranje usta.

(111) **14985**

(151) 06.11.2020.

(210) Ž-2019-364

(220) 25.09.2019.

(732) Colgate-Palmolive Company (a Delaware corporation), 300 Park Avenue, 10022, New York, New York, US

(540)



(550) I

(740) Jasna Jusić, Dalmatinska 2, 81000, Podgorica

(511) Klasa 3: Nemedicinska pasta za zube, nemedicinska tečnost za ispiranje usta.

(111) **14986**

(151) 06.11.2020.

(210) Ž-2019-365

(220) 25.09.2019.

(732) Colgate-Palmolive Company (a Delaware corporation), 300 Park Avenue, 10022, New York, New York, US

(540)



(550) I

(740) Jasna Jusić, Dalmatinska 2, 81000, Podgorica

(511) Klasa 3: Nemedicinska pasta za zube, nemedicinska tečnost za ispiranje usta.

(111) **14990**

(151) 06.11.2020.

(210) Ž-2019-100

(220) 13.03.2019.

(732) Al-Furat For Tobacco and Cigarettes Industry Co., Al-Basrah Street, Jabal Amman, 5th Circle, P.O. Box 941936, 11194, Amman, JO

(540)

ELEGANCE

(550) I

(740) Luka Stijepović, Bulevar Svetog Petra Cetinjskog 130/VII, 81000, Podgorica

(511) Klasa 34: Duvan, sirov ili prerađen; duvanski proizvodi uključujući cigarete, cigare, cigarilosi, duvan za motanje, duvan za lule, duvan za žvakanje, cigarete koje sadrže zamjenu duvana, koje nisu za medicinsku upotrebu; aromatizovani duvan; melasa (zamjena za duvan); burmut; elektronske cigarete; elektronske nargile; glava za elektronske nargile; upaljači za cigarete; artikli za pušače uključujući upijajući papir za duvanske lule, kutije za cigarete (tabakere), sekači za cigare, držači cigara, rezervoari gasa za upaljače, filteri za cigarete, muštikle, usnici za mustikle, papir za cigarete, usnici za cigarete, džepne mašine za uvijanje cigareta, kremen, humidori (kutije za čuvanje cigara), čistači za duvanske lule, stalci za lule, kese za duvan, kutije za burmut, pljuvaonice za pušače, usnici od žutog ćilibara

za muštikle, posude za duvan, pepeljare za pušače, tube za cigarete; bilje za pušenje; šibice; kutije za šibice; držači za šibice; duvan za nargile; duvan melasa; supstance za pušenje (koje nisu za medicinsku ili lekovitu upotrebu); aromatizovane mješavine duvana i melase za upotrebu u nargilama; aromatizovane tečnosti i rastvorljivi praškovi za upotrebu u nargilama; elektronske lule; tečnost za elektronsku nargilu sadržana od aroma u tečnom obliku za punjenje električnih nargila ili kertridža za elektronsku nargilu; nargile (šiša); pribor ili djelovi za nargile (uključujući ugalj za nargilu, činije i glave od nargile, cijevi za nargilu, podloge za nargilu, usnici i filteri za nargilu, drške od nargile, torbe i kutije za nargilu, posude od nargile).

(111) **14987**

(151) 06.11.2020.

(210) Ž-2019-366

(220) 25.09.2019.

(732) Colgate-Palmolive Company (a Delaware corporation), 300 Park Avenue, 10022, New York, New York, US

(540)



(550) I

(740) Jasna Jusić, Dalmatinska 2, 81000, Podgorica

(511) Klasa 3: Nemedicinska pasta za zube, nemedicinska tečnost za ispiranje usta.

(111) **14991**

(151) 06.11.2020.

(210) Ž-2019-332

(220) 04.09.2019.

(732) United Castle International Company Limited, Room 3101, 31/F, Office Tower, Convention Plaza, 1Harbour Road , HK

(540)



(550) I

(740) Jasna Jusić, Dalmatinska 2, 81000, Podgorica

(511) Klasa 9: Računarski softver; Baterije za elektronske cigarete; baterije za elektronske uređaje koji se koriste za zagrijavanje duvana, punjači za baterije za elektronske uređaje koji se koriste za zagrijavanje duvana; USB punjači za elektronske uređaje koji se koriste za zagrijavanje duvana; auto punjači za elektronske cigarete; auto punjači za uređaje koji se koriste za zagrijavanje duvana; djelovi i oprema za gore pomenuto.

Klasa 11: Elektronski isparivači; aparati za zagrijavanje tečnosti; aparati za stvaranje isparenja, žičani isparivač; djelovi i oprema za gore pomenuto.

Klasa 34: Duvan; Duvan, sirov ili prerađen, uključujući cigare, cigarete, cigarilose, duvan za savijanje sopstvenih cigareta, duvan za lule, duvan za žvakanje, burmut, duvanske zamjene (nije za medicinske svrhe); artikli za pušače, uključujući papir i fišeke za cigarete, filtere za cigarete, limenke za duvan, kutije za cigarete i pepeljare, a ne od plemenitih metala, njihovih legura ili presvučenih njima; lule, džepni aparat za savijanje cigareta; upaljači; šibice; elektronske cigarete; isparivači za pušenje; djelovi i oprema za gore pomenuto.

Klasa 35: Maloprodajne usluge u vezi sa računarskim softverom, baterije za elektronske cigarete, baterije za elektronske uređaje koji se koriste za zagrijavanje duvana, punjači za baterije za elektronske uređaje koji se koriste za zagrijavanje duvana, USB punjači za elektronske uređaje koji se koriste za zagrijavanje duvana, auto punjači za elektronske cigarete, auto punjači za uređaje koji se koriste za zagrijavanje duvana; Maloprodajne usluge u vezi s elektronskim isparivačima, uređajima za zagrijavanje tečnosti, aparatima za stvaranje isparenja, žičanim isparivačem; Maloprodajne usluge u vezi sa duvanom (sirov), duvanom (prerađeni), cigarima, cigaretama, cigarilosima, duvanom za savijanje sopstvenih cigareta, duvanom za lule, duvanom za žvakanje, burmutom; Maloprodajne usluge u vezi sa zamjenama duvana (ne u medicinske svrhe), artiklima za pušače, papir i fišeci za cigarete, filteri za cigarete, limenke za duvan, kutije za cigarete i pepeljare, lule; Maloprodajne usluge u vezi sa džepnim aparatima za savijanje cigareta, upaljačima,

šibicama, elektronskim cigaretama; Maloprodaja elektronskih cigareta; Spajanje, u korist drugih, različitih proizvoda, naime duvana, zamjena za duvan, elektronskih isparivača, baterija i punjača za elektronske cigarete, omogućavajući potrošačima da tu robu lako upoređuju i kupuju; oglašavanje; poslovni menadžment; marketing i promotivne usluge; informativne i savjetodavne usluge u vezi sa prethodno navedenim.

(111) **14992**
(151) 06.11.2020.
(210) Ž-2019-333

(220) 04.09.2019.
(732) United Castle International Company Limited, Room 3101, 31/F, Office Tower, Convention Plaza, 1 Harbour Road, HK
(540)



(550) I

(740) Jasna Jusić, Dalmatinska 2, 81000, Podgorica

(511) Klasa 9: Računarski softver; Baterije za elektronske cigarete; baterije za elektronske uređaje koji se koriste za zagrijavanje duvana, punjači za baterije za elektronske uređaje koji se koriste za zagrijavanje duvana; USB punjači za elektronske uređaje koji se koriste za zagrijavanje duvana; auto punjači za elektronske cigarete; auto punjači za uređaje koji se koriste za zagrijavanje duvana; djelovi i oprema za gore pomenuto.

Klasa 11: Elektronski isparivači; aparati za zagrijavanje tečnosti; aparati za stvaranje isparenja, žičani isparivač; djelovi i oprema za gore pomenuto.

Klasa 34: Duvan; Duvan, sirov ili prerađen, uključujući cigare, cigarete, cigarilose, duvan za savijanje sopstvenih cigareta, duvan za lule, duvan za žvakanje, burmut, duvanske zamjene (nije za medicinske svrhe); artikli za pušače, uključujući papir i fišeke za cigarete, filtere za cigarete, limenke za duvan, kutije za cigarete i pepeljare, a ne od plemenitih metala, njihovih legura ili presvučenih njima; lule, džepni aparat za savijanje cigareta; upaljači; šibice; elektronske cigarete; isparivači za pušenje; djelovi i oprema za gore pomenuto.

Klasa 35: Maloprodajne usluge u vezi sa računarskim softverom, baterije za elektronske cigarete, baterije za elektronske uređaje koji se koriste za zagrijavanje duvana, punjači za baterije za elektronske uređaje koji se koriste za zagrijavanje duvana, USB punjači za elektronske uređaje koji se koriste za zagrijavanje duvana, auto punjači za elektronske cigarete, auto punjači za uređaje koji se koriste za zagrijavanje duvana; Maloprodajne usluge u vezi s elektronskim isparivačima, uređajima za zagrijavanje tečnosti, aparatima za

stvaranje isparenja, žičanim isparivačem; Maloprodajne usluge u vezi sa duvanom (sirov), duvanom (prerađeni), cigarima, cigaretama, cigarilosima, duvanom za savijanje sopstvenih cigareta, duvanom za lule, duvanom za žvakanje, burmutom; Maloprodajne usluge u vezi sa zamjenama duvana (ne u medicinske svrhe), artiklima za pušače, papir i fišeci za cigarete, filteri za cigarete, limenke za duvan, kutije za cigarete i pepeljare, lule; Maloprodajne usluge u vezi sa džepnim aparatima za savijanje cigareta, upaljačima, šibicama, elektronskim cigaretama; Maloprodaja elektronskih cigareta; Spajanje, u korist drugih, različitih proizvoda, naime duvana, zamjena za duvan, elektronskih isparivača, baterija i punjača za elektronske cigarete, omogućavajući potrošačima da tu robu lako upoređuju i kupuju; oglašavanje; poslovni menadžment; marketing i promotivne usluge; informativne i savjetodavne usluge u vezi sa prethodno navedenim.

(111) **14988**

(151) 06.11.2020.

(210) Ž-2019-367

(220) 25.09.2019.

(732) Colgate-Palmolive Company (a Delaware corporation), 300 Park Avenue, 10022, New York, New York, US

(540)



(550) I

(740) Jasna Jusić, Dalmatinska 2, 81000, Podgorica

(511) Klasa 3: Nemedicinska pasta za zube, nemedicinska tečnost za ispiranje usta.

(111) **14993**

(151) 06.11.2020.

(210) Ž-2019-334

(220) 04.09.2019.

(732) United Castle International Company Limited, Room 3101, 31/F, Office Tower, Convention Plaza, 1 Harbour Road, HK

(540)



(550) I

(740) Jasna Jusić, Dalmatinska 2, 81000, Podgorica

(511) Klasa 9: Računarski softver; Baterije za elektronske cigarete; baterije za elektronske uređaje koji se koriste za zagrijavanje duvana, punjači za baterije za elektronske uređaje koji se koriste za zagrijavanje duvana; USB punjači za elektronske uređaje koji se koriste za zagrijavanje duvana; auto punjači za elektronske cigarete; auto punjači za uređaje koji se koriste za zagrijavanje duvana; djelovi i oprema za gore pomenuto.

Klasa 11: Elektronski isparivači; aparati za zagrijavanje tečnosti; aparati za stvaranje isparenja, žičani isparivač; djelovi i oprema za gore pomenuto.

Klasa 34: Duvan; Duvan, sirov ili prerađen, uključujući cigare, cigarete, cigarilose, duvan za savijanje sopstvenih cigareta, duvan za lule, duvan za žvakanje, burmut, duvanske zamjene (nije za medicinske svrhe); artikli za pušače, uključujući papir i fišeke za cigarete, filtere za cigarete, limenke za duvan, kutije za cigarete i pepeljare, a ne od plemenitih metala, njihovih legura ili presvučenih njima; lule, džepni aparat za savijanje cigareta; upaljači; šibice; elektronske cigarete; isparivači za pušenje; djelovi i oprema za gore pomenuto.

Klasa 35: Maloprodajne usluge u vezi sa računarskim softverom, baterije za elektronske cigarete, baterije za elektronske uređaje koji se koriste za zagrijavanje duvana, punjači za baterije za elektronske uređaje koji se koriste za zagrijavanje duvana, USB punjači za elektronske uređaje koji se koriste za zagrijavanje duvana, auto punjači za elektronske cigarete, auto punjači za uređaje koji se koriste za zagrijavanje duvana; Maloprodajne usluge u vezi s elektronskim isparivačima, uređajima za zagrijavanje tečnosti, aparatima za stvaranje isparenja, žičanim isparivačem; Maloprodajne usluge u vezi sa duvanom (sirov), duvanom (prerađeni), cigarima, cigaretama, cigarilosima, duvanom za savijanje sopstvenih cigareta, duvanom za lule, duvanom za žvakanje, burmutom; Maloprodajne usluge u vezi sa zamjenama duvana (ne u medicinske svrhe), artiklima za pušače, papir i fišeci za cigarete, filteri za cigarete, limenke za duvan, kutije za cigarete i pepeljare, lule; Maloprodajne usluge u vezi sa džepnim aparatima za savijanje cigareta, upaljačima, šibicama, elektronskim cigaretama; Maloprodaja elektronskih cigareta; Spajanje, u korist drugih, različitih proizvoda, naime duvana, zamjena za duvan, elektronskih isparivača, baterija i punjača za elektronske cigarete, omogućavajući potrošačima da tu robu lako

upoređuju i kupuju; oglašavanje; poslovni menadžment; marketing i promotivne usluge; informativne i savjetodavne usluge u vezi sa prethodno navedenim.

(111) **14994**

(151) 06.11.2020.

(210) Ž-2019-335

(220) 04.09.2019.

(732) United Castle International Company Limited, Room 3101, 31/F, Office Tower, Convention Plaza, 1 Harbour Road, HK

(540)



(550) I

(740) Jasna Jusić, Dalmatinska 2, 81000, Podgorica

(511) Klasa 9: Računarski softver; Baterije za elektronske cigarete; baterije za elektronske uređaje koji se koriste za zagrijavanje duvana, punjači za baterije za elektronske uređaje koji se koriste za zagrijavanje duvana; USB punjači za elektronske uređaje koji se koriste za zagrijavanje duvana; auto punjači za elektronske cigarete; auto punjači za uređaje koji se koriste za zagrijavanje duvana; djelovi i oprema za gore pomenuto.

Klasa 11: Elektronski isparivači; aparati za zagrijavanje tečnosti; aparati za stvaranje isparenja, žičani isparivač; djelovi i oprema za gore pomenuto.

Klasa 34: Duvan; Duvan, sirov ili prerađen, uključujući cigare, cigarete, cigarilose, duvan za savijanje sopstvenih cigareta, duvan za lule, duvan za žvakanje, burmut, duvanske zamjene (nije za medicinske svrhe); artikli za pušače, uključujući papir i fišeke za cigarete, filtere za cigarete, limenke za duvan, kutije za cigarete i pepeljare, a ne od plemenitih metala, njihovih legura ili presvučenih njima; lule, džepni aparat za savijanje cigareta; upaljači; šibice; elektronske cigarete; isparivači za pušenje; djelovi i oprema za gore pomenuto.

Klasa 35: Maloprodajne usluge u vezi sa računarskim softverom, baterije za elektronske cigarete, baterije za elektronske uređaje koji se koriste za zagrijavanje duvana, punjači za baterije za elektronske uređaje koji se koriste za zagrijavanje duvana, USB punjači za elektronske uređaje koji se koriste za zagrijavanje duvana, auto punjači za elektronske cigarete, auto punjači za uređaje koji se koriste za zagrijavanje duvana; Maloprodajne usluge u vezi s elektronskim isparivačima, uređajima za zagrijavanje tečnosti, aparatima za stvaranje isparenja, žičanim isparivačem; Maloprodajne usluge u vezi sa duvanom (sirov), duvanom (prerađeni), cigarima, cigaretama, cigarilosima, duvanom za savijanje sopstvenih cigareta, duvanom za lule, duvanom za žvakanje, burmutom; Maloprodajne usluge u vezi sa zamjenama duvana (ne u medicinske svrhe), artiklima za pušače, papir i fišeci za cigarete, filteri za cigarete, limenke za duvan, kutije za cigarete i pepeljare, lule;

Maloprodajne usluge u vezi sa džepnim aparatima za savijanje cigareta, upaljačima, šibicama, elektronskim cigaretama; Maloprodaja elektronskih cigareta; Spajanje, u korist drugih, različitih proizvoda, naime duvana, zamjena za duvan, elektronskih isparivača, baterija i punjača za elektronske cigarete, omogućavajući potrošačima da tu robu lako upoređuju i kupuju; oglašavanje; poslovni menadžment; marketing i promotivne usluge; informativne i savjetodavne usluge u vezi sa prethodno navedenim.

(111) **14989**

(151) 06.11.2020.

(210) Ž-2019-369

(220) 25.09.2019.

(732) TOYOTA JIDOSHA KABUSHIKI KAISHA (also trading as TOYOTA MOTOR CORPORATION), 1, Toyota-cho, Toyota-shi, 471-8571, Aichi-ken, JP

(540)

HIGHLANDER

(550) I

(740) Jasna Jusić, Dalmatinska 2, 81000, Podgorica

(511) Klasa 12: Automobili i njihovi strukturalni djelovi.

(111) **14995**

(151) 09.11.2020.

(210) Ž-2019-435

(220) 07.11.2019.

(732) Essity Hygiene and Health Aktiebolag, SE-405 03, Göteborg, SE

(540)



(550) I

(740) Jasna Jusić, Dalmatinska 2, 81000, Podgorica

(511) Klasa 3: Proizvodi za njegu kože, naime krema za pranje, pjena za pranje, perinealna krema i pjena za pranje; regeneratori, krema za čišćenje, sapuni, parfimerija, eterična ulja i gelovi, preparati za hidrataciju, losioni; jednokratne vlažne krpe impregnirane sredstvima za čišćenje ili jedinjenjima za ličnu upotrebu (nemedicinska).

Klasa 5: Apsorbujući sanitarni preparati, sanitarne salvete, tamponi, peškiri, navlake za upotrebu kao zaštita od menstruacije ili inkontinencije; higijenski ulošci; sanitarni peškiri; preparati za vaginalnu higijenu (medicinski); ulošci bez krilaca, vlažne maramice (medicinske); gaćice za sanitarne svrhe; jastučići za dojke; jastučići za dojenje; ulošci za trudnice; pelene od papira ili celuloze.

Klasa 16: Papir i papirna galanterija (ukoliko nisu obuhvaćeni drugim klasama), posebno papir za potrebe čišćenja i sušenja; papirni proizvodi za sanitarne svrhe; papirni ubrusi; krpe za pranje od papirnih proizvoda izrađenih od celuloznog materijala, uključujući pelene, maramice za lice, salvete, maramice, toaletni papir; štampani materijal, novine i časopisi, knjige; fotografije; edukativni materijali i materijali za obuku.

(111) **14996**

(151) 09.11.2020.

(210) Ž-2019-406

(220) 23.10.2019.

(732) GRE Grand River Enterprises Deutschland GmbH, Rietzer Berg 28, 14797 Kloster Lehnin/OT Rietz, 14797 Kloster Lehnin/OT Rietz, DE

(540)

MONAWK

(550) I

(740) Božidar S. Radulović, Baku 30/5, 81000, Podgorica

(511) Klasa 5: Proizvod koji se odnosi na kanabis, naime, ulja; ulja dobijena iz kanabisa; kanabis i marihuana proizvodi koji se odnose na kanabis, naime ulja, melemi, koncentrovane paste, tinkture, tablete i kapsule, od kojih svaka sadrži kanabis; ulja, melemi, koncentrovane paste, tinkture, tablete i kapsule koje sadrže smole i ulja dobijena iz kanabisa; nutritivna sredstva za medicinske svrhe; nutritivna sredstva za medicinske svrhe koja sadrže kanabis; nutritivna sredstva za medicinske svrhe koji sadrže derivate kanabisa, naime smole i ulja; topikalne kreme za kožu (kreme koje se primjenjuju na tjelesnim površinama), čvrsti i tečni sapuni, aditivi za kupanje, ljekovito bilje za kupanje, ulja za kupanje, kreme za tijelo, ulja za tijelo, losioni za lice i tijelo, mlijeko za lice i tijelo, losion za

lice i preparati za njegu kože od kojih svaki sadrži derivate kanabisa; seksualni lubrikanti za ličnu upotrebu; transdermalni flasteri koji sadrže kanabis; oralni sprejevi koji sadrže kanabis; svaki od gore navedenih proizvoda za ublažavanje boli, za opuštanje, za smanjenje stresa i umora, za poboljšanje raspoloženja, za održavanje opšteg zdravlja i blagostanja, za ublažavane anksioznosti, za ublažavanje depresije, kao sredstvo za spavanje; svi gore navedeni proizvodi takođe sa konopljom, uljem od sjemena konoplje ili kanabinoidom.

Klasa 34: Neobrađeni duvan, prerađeni duvan i duvanski proizvodi, uključeni u klasu 34, a posebno cigarete, cigare, cigarilose, sitno rezani duvan, duvan za lule, duvan za žvakanje, burmut, cigarete koje sadrže duvanske zamjene, ne za medicinske svrhe; proizvodi za pušače, posebno metalne kutije za duvan, kutije za cigarete, držači za cigarete, pepešjare (sva gore pomenuta roba koja nije od plemenitih metala ili nije presvučena sa njima), papir za cigarete, prazne cigarete (tube), filter za cigarete, lule za pušenje, džepna mašinicica za motanje cigareta, upaljači, uključeni u klasu 34; šibice; derivati kanabisa, naime smole i ulja; kanabis i marihuana za rekreativnu upotrebu; proizvodi od konoplje za pušenje; kanabis za pušenje; proizvodi od kanabisa za pušenje; proizvodi za pušače, naime, vreće za upotrebu sa marihuanom i kanabisom; proizvodi za pušače, naime oralni isparivači za pušače; suva marihuana, suvi kanabis; proizvodi za pušače, naime, drobilice za upotrebu sa kanabisom i marihuanom.

(111) **14997**

(151) 09.11.2020.

(210) Ž-2019-503

(220) 17.12.2019.

(732) Pivovary Staropramen s.r.o., Nádražní 43/84, CZ-15000, Prague 5, CZ

(540)



(550) I

(740) AOD "Tripković & Raičević", Cetinjski put 40, L 5-1, stan 10, 81000, Podgorica

(511) Klasa 32: Piva, stout, lager (piva sa donjom fermentacijom ili piva donjeg vrenja), tamna piva (porter) i svetla piva, ale piva (piva sa gornjom fermentacijom ili piva gornjeg vrenja); mineralne i gazirane vode i druga bezalkoholna pića; voćni napici i voćni sokovi; sirupi i drugi preparati za pripremanje pića.

(111) **14998**

(151) 09.11.2020.

(210) Ž-2019-504

(220) 17.12.2019.

(732) Pivovary Staropramen s.r.o., Nádražní 43/84, CZ-15000, Prague 5, CZ

(540)



(550) I

(740) AOD "Tripković & Raičević", Cetinjski put 40, L 5-1, stan 10, 81000, Podgorica

(511) Klasa 32: Piva, stout, lager (piva sa donjom fermentacijom ili piva donjeg vrenja), tamna piva (porter) i svetla piva, ale piva (piva sa gornjom fermentacijom ili piva gornjeg vrenja); mineralne i gazirane vode i druga bezalkoholna pića; voćni napici i voćni sokovi; sirupi i drugi preparati za pripremanje pića.

(111) **14999**

(151) 09.11.2020.

(210) Ž-2019-505

(220) 18.12.2019.

(732) Bayer Aktiengesellschaft, Kaiser-Wilhelm-Allee, 51373, Leverkusen, DE

(540)

PARTIX

(550) I

(740) Jasna Jusić, Dalmatinska 2, 81000, Podgorica

(511) Klasa 1: Hemijski proizvodi koji se koriste u poljoprivredi, hortikulturi i šumarstvu, osim fungicida, herbicida i paraziticida; supstance za očuvanje sjemena; preparati za regulaciju rasta biljaka; geni sjemena za poljoprivrednu proizvodnju; đubriva.
Klasa 5: Preparati za uništavanje štetočina; fungicidi, herbicidi.

(111) **15000**

(151) 09.11.2020.

(210) Ž-2019-509

(220) 24.12.2019.

(732) SAILUN GROUP CO.,LTD., No.588, Maoshan Road, Huangdao District, Qingdao City, Shandong, CN

(540)

DYNAMO

(550) I

(740) AOD "Ćupić", Bulevar Džordža Vašingtona 79, 81000, Podgorica

(511) Klasa 12: Automobilske gume; unutrašnje gume za pneumatike; omotači za pneumatske gume; pune gume za točkove vozila; gume za točkove vozila; gazišta za protektiranje guma; glavčine za točkove vozila; felne za točkove vozila; pneumatici za točkove vozila; lanci protiv klizanja.

(111) **15001**

(151) 09.11.2020.

(210) Ž-2019-518

(220) 27.12.2019.

(732) Goodyear Tyres UK Limited, 2920 Trident Court, Solihull Parkway Birmingham Business Park, B37 7YN, Birmingham, GB

(540)

GEOMAX MX14

(550) I

(740) Jasna Jusić, Dalmatinska 2, 81000, Podgorica

(511) Klasa 12: Pneumatske gume.

(111) **15002**

(151) 10.11.2020.

(210) Ž-2019-478

(220) 06.12.2019.

(732) Ivana Calovic Putincanin, Seestrasse 3, 6354, Vitznau, CH

(540)

IC Yourselfie

(550) I

(740) Bojan Popović, City kvart, Faza I, Ulaz II/38, Podgorica

(511) Klasa 9: Naučni, nautički, geodetski, fotografski, kinematografski i optički aparati i instrumenti kao i aparati i instrumenti za vaganje, mjerenje, signalizaciju, kontrolu (inspekciju), za pomoć (spašavanje) i za obuku; aparati i instrumenti za vođenje, distribuciju, transformisanje, akumuliranje, podešavanje ili upravljanje električne struje; aparati za snimanje, prijenos, reprodukciju zvuka ili slika; magnetni nosači podataka, diskovi za snimanje; kompaktni diskovi, DVD i drugi numerički nosači za snimanje; mehanizmi za uređaje koji se pokreću uz prethodno ubacivanje novca ili žetona; registarske blagajne, računari, oprema za obradu podataka i kompjuteri; uređaji za gašenje požara; kompjuterski programi (softveri).

Klasa 16: Papir, karton i proizvodi od tih materijala koji nisu obuhvaćeni drugim klasama; štamparski proizvodi; proizvodi za uvezivanje knjiga; fotografije; pribor za pisanje; ljepila (ljepljive materije za papirne proizvode ili za kućne potrebe); slikarski pribor; kistovi; pisaće mašine i kancelarijski pribor (osim namještaja); oprema za nastavu i obuku (osim aparata); plastični materijali za ambalažu (koji nisu obuhvaćeni drugim klasama); štamparska slova; klišeji.

Klasa 28: Igre i igračke; gimnastički i sportski predmeti koji nisu obuhvaćeni drugim klasama; ukrasi za božićne jelke.

Klasa 32: Pivo; mineralne i gazirane vode i ostala bezalkoholna pića; pića od voća i voćni sokovi; sirupi i ostali preparati za pripremanje napitaka.

Klasa 33: Alkoholna pića (osim piva).

Klasa 35: Oglašavanje i reklamiranje; vođenje komercijalnih poslova; komercijalna administracija; kancelarijski poslovi.

Klasa 36: Osiguranje; finansijski poslovi; monetarni poslovi; upravljanje nekretninama.

Klasa 37: Izgradnja; popravke; usluge postavljanja (instaliranja).

Klasa 38: Telekomunikacije.

Klasa 41: Obuka; stručno osposobljavanje; razonoda; sportske i kulturne djelatnosti.

(111) **15003**

(151) 10.11.2020.

(210) Ž-2019-479

(220) 06.12.2019.

(732) Ivana Calovic Putincanin, Seestrasse 3, 6354, Vitznau, CH

(540)



(550) I

(740) Bojan Popović, City kvart, Faza I, Ulaz II/38, Podgorica

(511) Klasa 9: Naučni, nautički, geodetski, fotografski, kinematografski i optički aparati i instrumenti kao i aparati i instrumenti za vaganje, mjerenje, signalizaciju, kontrolu (inspekciju), za pomoć (spašavanje) i za obuku; aparati i instrumenti za vođenje, distribuciju, transformisanje, akumuliranje, podešavanje ili upravljanje električne struje; aparati za snimanje, prijenos, reprodukciju zvuka ili slika; magnetni nosači podataka, diskovi za snimanje; kompaktni diskovi, DVD i drugi numerički nosači za snimanje; mehanizmi za uređaje koji se pokreću uz prethodno ubacivanje novca ili žetona; registarske blagajne, računari, oprema za obradu podataka i kompjuteri; uređaji za gašenje požara; kompjuterski programi (softveri).

Klasa 16: Papir, karton i proizvodi od tih materijala koji nisu obuhvaćeni drugim klasama; štamparski proizvodi; proizvodi za uvezivanje knjiga; fotografije; pribor za pisanje; ljepila (ljepljive materije za papirnate proizvode ili za kućne potrebe); slikarski pribor; kistovi; pisaće mašine i kancelarijski pribor (osim namještaja); oprema za nastavu i obuku (osim aparata); plastični materijali za ambalažu (koji nisu obuhvaćeni drugim klasama); štamparska slova; klišeji.

Klasa 28: Igre i igračke; gimnastički i sportski predmeti koji nisu obuhvaćeni drugim klasama; ukrasi za božićne jelke.

Klasa 32: Pivo; mineralne i gazirane vode i ostala bezalkoholna pića; pića od voća i voćni sokovi; sirupi i ostali preparati za pripremanje napitaka.

Klasa 33: Alkoholna pića (osim piva).

Klasa 35: Oglašavanje i reklamiranje; vođenje komercijalnih poslova; komercijalna administracija; kancelarijski poslovi.

Klasa 36: Osiguranje; finansijski poslovi; monetarni poslovi; upravljanje nekretninama.

Klasa 37: Izgradnja; popravke; usluge postavljanja (instaliranja).

Klasa 38: Telekomunikacije.

Klasa 41: Obuka; stručno osposobljavanje; razonoda; sportske i kulturne djelatnosti.

(111) **15004**

(151) 12.11.2020.

(210) Ž-2019-49

(220) 07.02.2019.

(732) Adnan AlNen & Partners\ Al-Durra Food Products, Erbeen Town, P.O.Box: 92

Damascus countryside, SY

(540)



(550) I

(740) Božidar S. Radulović, Baku 30/5, 81000, Podgorica

(511) Klasa 29: Meso, riba, živina i divljač; ekstrakti mesa; konzervirano, smrznuto, sušeno i kuvano voće i povrće; želei, džemovi, kompoti; jaja, mlijeko i mliječni proizvodi; jestiva ulja i masti.

Klasa 30: Kafa, čaj, kakao, šećer, pirinač, tapioka, sago, vještačka kafa; brašno i proizvodi od žitarica, hljeba, peciva i konditorskih proizvoda, sladoled; med, melasa; kvasac, prašak za pecivo; so, senf; sirće, sosovi (kao dodaci); začini; led.

Klasa 31: Poljoprivredni, hortikulturni i šumarski proizvodi i zrnelje koje nije uključeno u druge klase; žive životinje; svježe voće i povrće; sjemena, prirodne biljke i cvijeće; hrana za životinje; slad.

Klasa 32: Pivo; mineralne i gazirane vode i druga bezalkoholna pića; voćni napici i voćni sokovi; sirupi i drugi preparati za pripremu napitaka.

(111) **15005**

(151) 12.11.2020.

(210) Ž-2019-496

(220) 13.12.2019.

(732) Philip Morris Products S.A., Quai Jeanrenaud 3, 2000, Neuchâtel, CH

(540)

IQOS ILUMA

(550) I

(740) Milena Pejović, Cetinjski put 11, The Capital Plaza IV floor., 81000, Podgorica

(511) Klasa 9: Baterije za elektronske cigarete; baterije za elektronske uređaje koji se koriste za zagrevanje duvana, punjači za elektronske uređaje koji se koriste za zagrevanje duvana; USB punjači za elektronske uređaje koji se koriste za zagrevanje duvana; automobilski punjači za elektronske cigarete; automobilski punjači za uređaje koji se koriste za zagrevanje duvana; punjači za baterije za elektronske cigarete.

Klasa 34: Žičani vaporizatori za elektronske cigarete i elektronske uređaje za pušenje; duvan, sirov ili prerađen; duvanski proizvodi uključujući cigare, cigarete, cigarilose, duvan za uvijanje cigareta, duvan za lule, duvan za žvakanje, duvan za šmrkanje, kretek; snus (duvan u prahu); zamena za duvan (za nemedicinsku upotrebu); artikli za pušače, uključujući papir za cigarete, tube za cigarete, filtere za cigarete, kutije za duvan, kutije za cigarete, tabakere i pepeljare, lule, džepne mašine za uvijanje cigareta, upaljače; šibice; duvanski štapići, duvanski proizvodi za zagrevanje, elektronski uređaji, i njihovi delovi, koji se koriste za zagrevanje cigareta ili duvana u cilju oslobađanja aerosola koji sadrži nikotin za inhalaciju; tečni nikotinski rastvori za upotrebu u elektronskim cigaretama; elektronski uređaji za pušenje; elektronske cigarete; elektronske cigarete kao zamena za tradicionalne cigarete; elektronski uređaji koji sadrže aerosol za inhalaciju nikotina; oralni vaporizatori za pušače, duvanski proizvodi i zamene za duvan; artikli za pušače elektronskih cigareta; delovi i oprema za navedene proizvode iz klase 34; uređaji za gašenje cigareta i cigara koje se zagrevaju i duvanskih štapića koji se zagrevaju; punjive elektronske kutije za cigarete.

(111) **15006**

(151) 12.11.2020.

(210) Ž-2019-491

(220) 12.12.2019.

(732) PARK LIMITED d.o.o., Naselje Svete Petke BB Budva Agencija Bencom, ME

(540)



(550) I

(511) Klasa 28: Igre i igračke; Gimnastički i sportski predmeti koji nisu obuhvaćeni drugim klasama; Ukrasi za božićne jelke; Aparate za razonodu ili za igranje koncipirane za upotrebu s nezavisnim ekranom za prikazivanje ili s monitorom; Pribor za pecanje; Sprave za sport i zimske igre; Aparati za igre na sreću; Aparati za kockanje [aparati za igre]; Automatske igre [mašine] uz prethodno plaćanje; Babuške; Baloni za igru; Bazeni [predmet za igru]; Bejzbol (rukavice za bejzbol); Bicikli za treniranje na mjestu; Bicikli za treniranje na mjestu (roleri za bicikla za treniranje na mjestu); Bilijarske krede; Bilijarske kuglice; Bilijarski čunjevi [kiljevi]; Bilijarski štapovi; Bilijarski štapovi (komadić okrugle kože na vrhu biljarskih štapova); Bilijarski štapovi (kreda za biljarske štapove); Bilijarski stolovi; Bilijarski stolovi koji se

upotrebljavaju uz prethodno plaćanje; Bilijarski stolovi (rubovi biljarskih stolova); Bingo kartice; Bočice s cuclom za lutke; Boja (pištolji s bojom) [sportski predmeti]; Bokserske rukavice; Bokserske vreće; Bomboni, praskavi božićni bomboni; Božićna drvca-novogodišnje jelke (ukrasi za božićna drvca) [osim rasvjetnih tijela i slatkiša]; Božićna drvca-novogodišnje jelke (postolja za božićna drvca); Božićna drvca-novogodišnje jelke od sintetičkog materijala; Bubnjevi na štapovima za pecanje; Bučice za vježbanje; Čizmice sa klizaljka; Cjevanice (zaštite za cjevanice) [sportska oprema]; Dama [igra] (pribor za igru dame); Daske s jedrima, za vodu; Daske s jedrom ģarboli za daske s jedrom); Daske s jedrom (oprema za daske s jedrom); Daske za plivanje; Daske za skijanje; Daske za surfovanje (kaiševi za daske za surfanje); Daske za trbušno plivanje; Daske za valove [surfing]; Daske za veslanje; Detonatori, praskavi [igračke]; Diskovi za sport; Dizanje tegova (kaiševi za dizače tegova) [sportski pribor]; Domino (pribor za igranje domina); Društvene igre; Elektronske igre (aparati za elektronske igre); Figurice za igru; Fizička kultura (aparati za fizičku kulturu); Fizičke vježbe (sprave za fizičke viježbe); Fokina koža za oblaganje skija; Gađanje lukom (oprema za gađanje lukom); Gimnastičke protezaljke, za razvlačenje; Glineni golubovi [mete]; Glineni golubovi (naprave za gađanje glinenih golubova); Golf (naprava za stavljanje na mjesto busena s travom u golfu); Golf (rukavice za golf); Golf (štapovi za golf); Golf (torbe za štapove za gľof); Građevinski elementi [igračke]; Graditeljske igre; Guma za lopte za igru; Harpuni (puške za gađanje ostima) [sportski pribor]; Hokej (palice za hokej); Igle za pumpe za pumpanje lopti za igru; Igračke; Igračke karte; Igračke od pliša; Igračke, vozila s daljinskim upravljanjem; Igračke za domaće životinje; Igračke za grickanje [kod nicanja zubi]; Igre; Ivce skija; Jačanje mišića (sprave za jačanje mišića); Jahaonica, Jedrilice; Kaleidoskopi; Kamufliranje (zasloni za kamufliranje); Karnevalske maske; Kartice za struganje za lutriju; Klizaljke za led; Kockice za kockanje; Kolica za torbe za golf; Kolutovi za igru; Konfeti; Konji-ljulaške [igračke]; Konjske potkovice za igru; Kontrole na igračkama; Kontrolori za igraće konzole; Kopče za skije; Koturaljke; Koturaljke s točkicama u nizu; Krevetići za lutke; Kriket (torbe za kriket); Kućice za lutke; Kuglana [igra]; Kuglanje (uređaji i mehanizmi za kuglanje); Kugle za igru; Kuglice za igru [špekule]; Leptiri (mrežice za leptire); Leteći tanjiri [igračke]; Ljulaške [ljuljaške]; Lopte za igru; Loptice za badminton; Lov (mamci za lov); Lukovi za gađanje; Lutke [igračke]; Lutke (odjeća za lutke); Lutke (pozorišne lutke) [marionete]; Lutke (sobe za lutke); Ma-jong [kineska igra]; Mačevanje (maske za mačevanje); Mačevanje (oružje za mačevanje); Mačevanje (rukavice za mačevanje); Mađioničari (pribor za mađioničare); Makete (kompleti za izradu maketa); Makete za igru; Mali avioni bez pilota [igračke]; Mamac [pribor za pecanje]; Mamci (mirisni mamci za lov ili ribolov); Mamci za lov ili za ribolov; Mamci za pecanje, vještački; Maske, pozorišne; Maske za igru; Mete (elektronske mete); Mete za gađanje [ciljevi]; Mobili [igračke sastavljene od više elemenata koji trepere uz najmanje strujanje vazduha]; Motke za skok s motkom; Motke za skok u dalj; Mreže [sportski pribor]; Municija za pištolje s bojom [sportski pribor]; Namotaji za papirne zmajevе; Navlake za skije i daske za surfovanje; Nogomet, sobni (stolovi za sobni fudbal); Obloge za skije; Odskočne daske [sportski artikli]; Oprema za ples [ples] (oprema za kotiljon); Pačinko [mašine za igre]; Pazle; Pecačke niti; Pecanje (pribor za pecanje); Pehari za nagrade u igrama; Penjanje (kaiševi za penjanje); Penjanje (pribor protiv sklizanja pri penjanju); Peraje za plivače; Pinjata; Pištolji [igračke]; Pištolji igračke (upaljači za pištolje igračke); Plišane igračke; Plišane igračke za pričvršćenom dekom za maženje; Plivanje (plovci za plivanje i kupanje); Plivanje (pojasevi za plivanje); Pločice za igru [pakovi]; Plovci za pecanje; Podloge za igru za bebe; Pračke [sportski artikli]; Prsluci za plivanje; Pumpe posebno namjenjene za pumpanje lopti za igru; Reketi; Reketi (strune od ovčijih crijeva za rekete); Reketi za snijeg [krplje]; Reketi (žice za rekete); Roboti

igračke; Ručke [gimnastičke sprave]; Rukavice [oprema za igru]; Rukavice za kriket; Rulet (okretna ploča za rulet); Šah [igra]; Sanke [sportski artikli]; Saonice za trke [bob sanke]; Sapunica (igračke za pravljenje mjhurića od sapunice); Šeširi od papira za zabave; Signalizatori dodira [pecački pribor]; Skejtbord; Skije; Skije za vodu; Skije za vodu [surfing]; Skuteri; Smola za atletičare; Snijeg, vještački za božićna drvca; Snježne kugle; Sportisti (zaštitne gaćice za atletičare) [sportski artikli]; Sprave za penjanje [oprema za planinarenje]; Štapovi za mažuretkinje; Štapovi za pecanje; Startni blokovi [polazišta] za sport; Stolne igre; Stolovi za stolni tenis; Strelice; Strojevi za bacanje loptica; Svjećice (držači svjećica) za božićna drvca; Table za igranje dame; Table za igranje šaha; Tenis (mrežice za tenis); Teniske loptice (naprave za izbacivanje teniskih loptica); Tobogani [igra]; Tricikli za djecu [igračke]; Triktrak [igra s kockicama i s figuricama za damu]; Udice; Upravljačke ručice za video igrice; Varke [predmeti za prevaru za zabavu]; Vazdušni pištolji [igračke]; Video igre (elektronski mašine za video igre; Video igre (mašine za video igre); Video igrice (prenosive igrice sa zaslonima od tečnih kristala); Vozila [igračke]; Vozila (mali modeli vozila); Vrećaste mreže za pecanje; Vrše [ribarske naprave]; Zaštita za koljenja [sportski pribor]; Zaštita za laktove [sportski pribor]; Zaštitne folije prilagođene za ekrane za prenosne igre; Zaštitne ispune za sportsku odjeću [jastučići]; Žetoni za igre; Žetoni za kockanje; Žice za pecanje [flaks]; Žiroskopi i stabilizatori za makete aviona; Zmajevi, papirni; Zvončići za božićna drvca; Zvrkovi [igračke].

Klasa 41: Obuka; Stručno osposobljavanje; Razonoda; Sportske i kulturne djelatnosti; Usluge osoba ili ustanova koje se bave razvojem mentalnih sposobnosti lica ili životinja, kao i usluge rasonode i zaokupljanja pažnje; Usluge obučavanja osoba ili uvježbavanja životinja, u svim njihovim vidovima; Usluge čiji je osnovni cilj razbibriga, zabava ili rekreacija lica; Usluge prikazivanja javnosti umjetničkih i literarnih djela u kulturne i obrazovne svrhe; Agencije za prodaju ulaznica za priredbe (zabava); Aikido obuka; Akademije [obrazovanje]; Cirkusi; Cirkusi [zabavni parkovi]; Elektronsko izdavaštvo; Emisije (Produkcija-); Filmska produkcija, različita od reklamnih filmova; Filmski studiji; Fizičko vaspitanje; Fotografija; Fotografske reportaže; Gimnastička obuka; Inforinacije o obrazovanju; Informacije o rekreaciji; Informacije o zabavi; Internati; Izdavanje knjiga; Iznajmljivanje audio opreme; Iznajmljivanje dekora za priredbe; Iznajmljivanje igrački; Iznajmljivanje kinematografskih filmova; Iznajmljivanje kinoaparature i pribora; Iznajmljivanje opreme za igranje; Iznajmljivanje radio i televizijskih aparata; Iznajmljivanje ronilačke opreme; Iznajmljivanje scenografije; Iznajmljivanje sportske opreme, osim vozila; Iznajmljivanje sportskih terena; Iznajmljivanje stadiona; Iznajmljivanje umjetničkih djela; Iznajmljivanje unutrašnjih akvarijuma; Iznajmljivanje uređaja za rasvjetu za pozorišne i televizijske studije; Iznajmljivanje videokamera; Iznajmljivanje videorekordera; Iznajmljivanje videotraka; Iznajmljivanje zvučnih snimaka; Iznajmljivanje teniskih terena; Kampovi za sportsko usavršavanje; Kazino usluge (kockanje); Knjižare; Kockanje, igre na sreću; Kroćenje životinja [dresiranje], Ljetovanje (usluge kampova za ljetovanje) zabava; Mentorstvo; Mjerenje vremena na sportskim događajima; Montaža videotraka; Muzejske usluge (prezentacije, izložbe); Muzička produkcija; Muzičke sale; Noćni klubovi; Nuđenje sportskih objekata u najam; Obezbjedivanje igrališta za golf; Objavljivanje elektronskih knjiga i žurnala online; Objavljivanje tekstova, osim u reklamne svrhe; Obrazovna ispitivanja; Obuka; Obuka dopisnim putem; Obuka za sado [obuka iz ceremonije pripreme čaja]; Organizacija i vođenje individualnih foruma; Organizacija i vođenje simpozijuma; Organizacija modnih revija u zabavne svrhe; Organizacija takmičenja [obrazovanje ili zabava]; Organiziranje takmičenja u ljepoti; Organizovanje balova; Organizovanje i vođenje kolokvijuma; Organizovanje i vođenje kongresa; Organizovanje i vođenje konferencija; Organizovanje i vođenje

koncerata; Organizovanje i vođenje radionica za stručno osposobljavanje; Organizovanje i vođenje seminara; Organizovanje izložbi u kulturne ili obrazovne svrhe; Organizovanje lutrija; Organizovanje nastupa (usluge impresarija); Organizovanje sportskih takmičenja; Pisanje pjesama; Pisanje scenarija; Planiranje prijema (zabava); Podučavanje; Ponuda prostora za rekreaciju; Poziranje za umjetnike; Pozorišna produkcija; Prakična obuka (demonstracija); Predškolska obuka; Prevodilačke usluge; Produkcija televizijskih i radio programa; Profesionalna orijentacija (edukacija ili usluge obuke); Projekcije u kinodvoranama; Pružanje filmova koji se ne mogu preuzeti putem usluga prenosa videozapisa na zahtjev; Pružanje on-line video snimaka, koji nisu za preuzimanje; Pružanje online elektronskih publikacija, nisu za preuzimanje; Pružanje televizijskih programa koji se ne mogu preuzeti putem usluga prenosa videozapisa na zahtjev; Putujuće knjižare; Radijska zabava; Redigiranje tekstova [ne u reklamne svrhe]; Reporterske usluge; Rezervisanje sjedišta za priredbe; Sinhronizacija; Školske usluge obrazovanja; Snimanje na mikrofilmove; Snimanje na videotrake; Stavljanje podnaslova; Televizijska zabava; Treniranje; Tumačenje znakovnog jezika; Usluge disk džokeja; Usluge diskoteka; Usluge formatiranja publikacija, osim u reklamne svrhe; Usluge kaligrafije; Usluge karaoka; Usluge klubova za zabavu ili obrazovanje; Usluge komponovanja muzike; Usluge lučnog trenera (fitnes treneri); Usluge nuđenja online igara na kompjuterskoj mreži; Usluge obučavanja preko simulatora; Usluge orkestra; Usluge pisanja scenarija; Usluge prekvalifikacije; Usluge studija za snimanje; Usluge usmenog prevođenja; Usluge vođenih tura; Usluge zabavnih arkada; Usluge zdravstvenih klubova (centri za zdravlje i fitnes); Usluge zooloških vrtova; Uživo nastupi; Vjeronauka; Vođenje fitnes časova; Zabava.

(111) **15007**

(151) 12.11.2020.

(210) Ž-2019-508

(220) 23.12.2019.

(732) Intercontinental Great Brands LLC, 100 Deforest Avenue, 07936, East Hanover, New Jersey, US

(540)

OREO

(550) I

(740) Miladin Popović, Đoka Miraševića 21/III, 81000, Podgorica

(511) Klasa 29: Mliječni proizvodi, posebno mliječni deserti i ohlađeni deserti, uključujući museve, proizvode od pavlake i jogurta.

Klasa 30: Sladoledi, smrznute poslastice; deserti, ohlađeni deserti; mješavine za pečenje; preparati napravljeni od žitarica, žitarice za doručak.

(111) **15008**

(151) 13.11.2020.

(210) Ž-2020-1

(220) 03.01.2020.

(732) NSAR GENERAL TRADING (L.L.C), P.O. Box 171611, Dubai, AE

(540)



(550) I

(740) Božidar S. Radulović, Baku 30/5, 81000, Podgorica

(511) Klasa 34: Duvan; artikli za pušače; šibice.

(111) **15009**

(151) 13.11.2020.

(210) Ž-2020-24

(220) 27.01.2020.

(732) Reign Beverage Company LLC, a Delaware limited liability company, 1547 N. Knowles Ave., 90063, Los Angeles, California, US

(540)

REIGN INFERNO

(550) I

(740) Božidar S. Radulović, Baku 30/5, 81000, Podgorica

(511) Klasa 32: Energetska pića; bezalkoholna pića; napici za sportiste.

(111) **15010**

(151) 13.11.2020.

(210) Ž-2020-37

(220) 05.02.2020.

(732) Regent Hospitality Worldwide, Inc., Ugland House, P.O.Box 309, KY1-1104, Grand Cayman, KY

(540)

REGENT

(550) I

(740) Jasna Jusić, Dalmatinska 2, 81000, Podgorica

(511) Klasa 35: Usluge upravljanja hotelima za druge; usluge franšiznog poslovanja sa hotelima; usluge poslovnog savjetovanja i konsultovanja u vezi sa upravljanjem, radom i franšiznim poslovanjem hotela; poslovno upravljanje hotelima i drugim smještajnim kapacitetima; usluge reklamiranja hotela i nekretnina; vođenje programa vjernosti klijenata i podsticaja; promotivne usluge u oblasti programa vjernosti klijenata i podsticaja.

Klasa 36: Usluge u vezi sa nekretninama, odnosno, izgradnja, iznajmljivanje, upravljanje, izdavanje i posredovanje stanovima, kondominijumima, nekretninama sa vremenski ograničenim korištenjem, stambenim nekretninama, nekretninama za odmor i objektima i sadržajima u vezi sa njima; usluge razmjene nekretnina za vremenski ograničeno korištenje.

Klasa 43: Usluge hotela, smještaja i privremenog smještaja; usluge pružanja informacija o hotelima, smještajima i privremenom smještaju; usluge rezervisanja hotela, smještaja i privremenog smještaja; usluge restorana, bara, koktel bara, kafea, kafića, i snek bara; usluge kejtinga za snabdijevanje hranom i pićem; usluge rezervacije restorana; obezbjeđivanje objekata za održavanje konferencija, sastanaka, događaja, konvencija i izložbi; iznajmljivanje stolica, stolova, stolnjaka i čaša.

(111) **15011**

(151) 13.11.2020.

(210) Ž-2020-68

(220) 25.02.2020.

(732) TPK d.o.o., Carice Milice 79, Paraćin, RS

(540)

LAFINO

(550) I

(740) Miladin Popović, Đoka Miraševića 21/III, 81000, Podgorica

(511) Klasa 3: Kozmetički proizvodi, mirisi i parfimerijski proizvodi; esencijalna ulja.

(111) **15012**

(151) 13.11.2020.

(210) Ž-2020-69

(220) 25.02.2020.

(732) Exxon Mobil Corporation, 5959 Las Colinas Boulevard, 75039, Irving, Texas, US

(540)

The Mobil logo consists of the word "Mobil" in a bold, sans-serif font. The letter "o" is red, while the other letters are blue.

(550) I

(740) AOD "Ćupić", Bulevar Džordža Vašingtona 79, 81000, Podgorica

(511) Klasa 9: Aparati i instrumenti naučni, pomorski, geodetski, fotografski, kinematografski, optički, za vaganje, mjerenje, signalizaciju, kontrolu (inspekciju), spasavanje i nastavu; aparati i instrumenti za provođenje, prekid, transformaciju, akumulaciju, regulisanje ili kontrolu električne energije; aparati za snimanje, prenos i reprodukciju zvuka ili slike; magnetni nosači podataka, diskovi za snimanje; kompakt diskovi, DVD i drugi digitalni nosači podataka; mehanizmi za aparate koji se pokreću novcem; registar kase, računске mašine, oprema za obradu podataka, računari; kompjuterski softver; aparati za gašenje požara; kompjuterski programi (softver koji se može skinuti sa interneta); softver koji se može skinuti sa interneta u formi mobilne aplikacije.

(111) **15013**

(151) 16.11.2020.

(210) Ž-2020-5

(220) 14.01.2020.

(732) Qatar Airways Group (Q.C.S.C.), Qatar Airways Tower, Airport Road, P.O. Box 22550, Doha, QA

(540)

The Qatar Airways logo features the word "QATAR" in a large, bold, serif font. Below it, "AIRWAYS" is written in a smaller, sans-serif font, followed by the Arabic word "القطرية" (Al-Qatariya). To the right of the text is a stylized graphic of a falcon's head in profile, facing right. Below the entire logo is the slogan "Going Places Together" in a bold, sans-serif font.

(550) I

(740) Božidar S. Radulović, Baku 30/5, 81000, Podgorica

(511) Klasa 16: Vizitkarte, časopisi, vozne karte, blokovi karata.

Klasa 39: Prevoz; ambalaža i skladištenje roba; putni aranžmani, naime vazdušni prevoz, organizovanje krstarenja, organizovanje obilazaka, rezervisanje sjedišta za putovanja, kurirska služba, prevoz putnika, rezervacija prevoza, informacije o prevozu.

(111) **15014**

(151) 16.11.2020.

(210) Ž-2020-6

(220) 14.01.2020.

(732) Qatar Airways Group (Q.C.S.C.), Qatar Airways Tower, Airport Road, P.O. Box 22550, Doha, QA

(540)



(550) I

(740) Božidar S. Radulović, Baku 30/5, 81000, Podgorica

(511) Klasa 16: Vizitkarte, časopisi, vozne karte, blokovi karata.

Klasa 39: Prevoz; ambalaža i skladištenje roba; putni aranžmani, naime vazdušni prevoz, organizovanje krstarenja, organizovanje obilazaka, rezervisanje sjedišta za putovanja, kurirska služba, prevoz putnika, rezervacija prevoza, informacije o prevozu.

(111) **15015**

(151) 16.11.2020.

(210) Ž-2020-22

(220) 24.01.2020.

(732) Casio Keisanki Kabushiki Kaisha (Casio Computer Co., Ltd.), 6-2, Hon-machi 1-chome, Shibuya-ku, Tokyo, JP

(540)

BABY-G

(550) I

(740) Božidar S. Radulović, Baku 30/5, 81000, Podgorica

(511) Klasa 9: Pametni satovi; nosivi računari; nosivi pratioci aktivnosti; nosivi monitori za video prikaz; baterije; punjači za baterije; kablovi za punjenje; električni adapteri; slušalice koje idu u uši i slušalice koje se nose preko glave; mobilne aplikacije i softver koji se mogu preuzeti sa interneta, a za obradu, pregled i uređivanje podataka sa pametnih satova i mobilnih uređaja koji sadrže globalne sisteme za pozicioniranje, kompase, barometre, visinomere, pedometre, merače pulsa, akcelerometre i termometre; pametni satovi koji imaju funkciju radio- upravljanja; njihovi delovi i oprema.

(111) **15016**

(151) 16.11.2020.

(210) Ž-2020-31

(220) 31.01.2020.

(732) Century 21 Real Estate LLC (Delaware limited liability corporation), 175 Park Avenue, NJ 07940, Madison, US

(540)



(550) I

(740) Božidar S. Radulović, Baku 30/5, 81000, Podgorica

(511) Klasa 36: Osiguranje; finansijski poslovi; novčani (monetarni) poslovi; poslovi vezani za nepokretnosti; usluge posredovanja u poslovima koji se odnose na nepokretnosti; usluge franšiza, naročito obezbjeđivanje finansijskih informacija i savjeta u vezi sa osnivanjem i/ili upravljanjem poslovanjem koji se odnose na posredovanje u vezi sa nepokretnostima; usluge upravljanja imovinom; usluge agencija za nepokretnosti; lizing nepokretnosti; procjena i određivanje vrijednosti nepokretnosti; usluge izdavanja nepokretnosti; obezbjeđivanje informacija u oblasti nepokretnosti preko interneta; usluge investiranja u nepokretnosti; eskro usluge koje se odnose na nepokretnosti; konsultantske usluge koje se odnose na nepokretnosti; savjetodavne i administrativne usluge u vezi sa hipotekama.

(111) **15017**

(151) 16.11.2020.

(210) Ž-2020-23

(220) 27.01.2020.

(732) Advanced New Technologies Co., Ltd., Cayman Corporate Centre, 27 Hospital Road Grand Cayman, KY 1-9008, George Town, KY

(540)

ANTFIN

(550) I

(740) Jasna Jusić, Dalmatinska 2, 81000, Podgorica

(511) Klasa 9: Aparati i instrumenti naučni, pomorski, geodetski, fotografski, kinematografski, optički, za vaganje, mjerenje, signalizaciju, kontrolu (inspekciju), spasavanje i nastavu; aparati i instrumenti za provođenje, prekid, transformaciju, akumulaciju, regulisanje ili kontrolu električne energije; aparati za snimanje, prenos i reprodukciju zvuka ili slike; magnetni nosači podataka, diskovi za snimanje; mehanizmi za aparate koji se pokreću novcem; registar kase, računarske mašine, oprema za obradu podataka i računari; kompjuterski softver; kompjuterski programi; kompjuterski softver u obliku aplikacije za mobilne uređaje i računare; softverske aplikacije za upotrebu sa mobilnim uređajima; softver za procesuiranje elektronskih plaćanja za druge i od drugih; kompjuterski softver i softverske aplikacije koje se koriste u vezi sa finansijskim uslugama, finansijskim transakcijama, elektronskom trgovinom, elektronskim plaćanjem, razmenom stranih valuta, uslugama trgovine i posredovanja i savjetodavnim uslugama o investiranju; softver za autentifikaciju; kompjuterski softver i kompjuterske softverske aplikacije (koji se mogu preuzeti); softver za razmjenu trenutnih poruka; softver za dijeljenje datoteka; komunikacijski softver za elektronsku razmjenu podataka, audio i video sadržaja, slika i grafika putem kompjuterskih, mobilnih, bežičnih i telekomunikacionih mreža; kompjuterski softver za obradu slika, grafika, audio i video sadržaja i teksta; kompjuterski softver koji se može preuzimati koji olakšava elektronski prenos informacija, podataka, dokumenata, glasa i slika preko Interneta; kompjuterski softver koji se može preuzimati koji omogućava korisnicima da učestvuju na onlajn sastancima i časovima, sa pristupom podacima, dokumentima, slikama i softverskim aplikacijama kroz Internet pretraživač; kompjuterski softver koji se može preuzeti, za pristup, pregled i upravljanje udaljenim kompjuterima i kompjuterskim mrežama; softver za računarstvo u oblaku koji se može preuzimati; softver koji se nalazi u oblaku, a koji se može preuzimati; kompjuterski softver za praćenje i procjenu kupaca i ličnog ponašanja u vezi sa odlukama koje se tiču kupovine; kompjuterske softverske aplikacije za upotrebu u vezi sa očuvanjem životne sredine, klimatskim promjenama i kompenzacijom za emisiju ugljenika; onlajn elektronske publikacije (koje se mogu preuzeti sa interneta ili sa kompjuterske mreže ili iz kompjuterske baze podataka); elektronske publikacije koje se mogu preuzimati, u obliku časopisa, članaka, brošura, lifleta, tehničkih specifikacija, informacionih materijala, priručnika u oblastima poslovanja, elektronske trgovine, informacionih tehnologija, računarstva u oblaku, telekomunikacija, interneta, obuka u vezi sa poslovanjem i elektronskom trgovinom, upravljanja poslovanjem, prodajom, marketingom i finansijama; kompjuterske periferne jedinice; noutbuk računari;

laptop računari; prenosivi računari; ručni računari; lični digitalni asistenti; lični media plejeri; mobilni telefoni; pametni telefoni; digitalne kamere; baterije, punjači za baterije; računarske radne stanice; računarski serveri; kompjuterski i telekomunikacioni mrežni hardver; kompjuterski mrežni adapteri, prekidači, ruteri i čvorovi; bežični i žični modemi i komunikacione kartice i uređaji; držači za laptop; torbe za računare; aparti za gašenje požara; kompjuterski hardver i firmver; automobilski sistemi za navigaciju; kompakt diskovi; digitalna muzika (koja se može preuzeti sa interneta); telekomunikacijski aparati; podloge za miševe; slušalice za mobilne telefone; dodaci za mobilne telefone; igre, slike, bioskopski filmovi, filmovi i muzika koji se mogu preuzeti; sistemi za alarme; bezbjednosne kamere; mobilne radio i televizijske jedinice za emitovanje; oprema za televizijsko emitovanje; kamere; video kamere; slušalice; telefonske slušalice koje se nose u uvetu; zvučnici; uređaji i oprema za globalno pozicionirajući sistem [GPS]; programi i softver za kompjuterske, elektronske i video igre (uključujući i softver koji se može preuzeti sa interneta); displeji od tečnih kristala za telekomunikacionu i elektronsku opremu; set top boks; daljinski upravljači; programi za skladištenje podataka; naočare i naočare za sunce; elektronske table sa natpisom; kodirane ili magnetne bankovne kreditne, debitne, gotovinske ili identifikacione kartice; automatski bankomati; čitači elektronskih knjiga; toner kertridži, prazni, za štampače i fotokopire; uređaji za nadgledanje beba; video uređaji za nadgledanje beba; poklopci za fotografska sočiva; tablet računari; kodirane ključ kartice; 3D naočare; memorijske kartice za mašine za video igre; nosivi računari, pametni telefoni, monitori, displeji, kompjuterski hardver, uređaji za praćenje aktivnosti, audio oprema, aparati za komunikaciju, telekomunikacioni aparati, kompjuterski periferni uređaji, nosivi media plejeri i digitalni elektronski uređaji za komunikaciju; nosivi računari, pametni telefoni, monitori, displeji, kompjuterski hardver, uređaji za praćenje aktivnosti, audio oprema, aparati za komunikaciju, telekomunikacioni aparati, kompjuterski periferni uređaji, nosivi media plejeri i digitalni elektronski uređaji za komunikaciju koji se koriste za olakšavanje transakcija plaćanja putem elektronskih sredstava i kako bi dozvolili kupcima da pristupe finansijskim informacijama i informacijama o bankovnom računu i da vrše transakcije bankovnih poslova; nosivi računari, pametni telefoni, monitori, displeji, kompjuterski hardver, uređaji za praćenje aktivnosti, audio oprema, aparati za komunikaciju, telekomunikacioni aparati, kompjuterski periferni uređaji, nosivi media plejeri i digitalni elektronski uređaji za komunikaciju koji mogu da pruže pristup bežičnim komunikacijskim mrežama, telekomunikacionim mrežama i internetu; mobilne aplikacije koje se mogu preuzeti za upotrebu sa nosivim računarima, pametnim telefonima, monitorima, displejima, kompjuterskim hardverom, uređajima za praćenje aktivnosti, audio opremom, aparatima za komunikaciju, telekomunikacionim aparatima, kompjuterskim perifernim uređajima, nosivim media plejerima i digitalnim elektronskim uređajima za komunikaciju; kompjuterske softverske aplikacije za upotrebu sa nosivim računarima, pametnim telefonima, monitorima, displejima, kompjuterskim hardverom, uređajima za praćenje aktivnosti, audio opremom, aparatima za komunikaciju, telekomunikacionim aparatima, kompjuterskim perifernim uređajima, nosivim media plejerima i digitalnim elektronskim uređajima za komunikaciju; kodirane ili magnetne pripejd platne, bankovne, kreditne, debitne, gotovinske i identifikacione kartice.

Klasa 36: Osiguranje; finansijski poslovi; novčani poslovi; poslovi vezani za nepokretnosti; kliring i usklađivanje finansijskih transakcija putem globalne računarske mreže; onlajn bankarske usluge i finansijske usluge; usluge kreditnih kartica, procesuiranje i prenos računa i uplata, i pružanje osiguranja za finansijske transakcije; usluge prenosa sredstava; prenos sredstava elektronskim putem za druge; prenos uplata za druge putem interneta; finansijske usluge u oblasti usluga obrade računa i uplata; organizovanje i upravljanje

lizingom i zakupom; iznajmljivanje i lizing nepokretnosti; procjena nepokretnosti; valuacija nepokretnosti; finansijske usluge u vezi sa nepokretnostima, investiranje u nepokretnosti; brokerske usluge u vezi sa nepokretnostima; usluge agencija za nepokretnosti; usluge stambenih agencija; usluge aktuara; upravljanje nepokretnostima i konsalting usluge; ubiranje najamnine; iznajmljivanje kancelarija (nepokretnosti); iznajmljivanje apartmana i stanova; pružanje finansijskih informacija putem interneta; usluge depozita i usluge izdavanja putničkih vaučera; ulaganje kapitala; finansijske evaluacije [osiguranje, bankarstvo, nepokretnosti]; finansijske i usluge upravljanja aktivom; osiguranje i finansijske usluge; finansijske usluge pružene putem telekomunikacijskih sredstava; finansijske konsalting i savjetodavne usluge; onlajn bankarstvo; bankarske usluge pružene onlajn sa računarskih baza podataka ili interneta; usluge posredovanja u prometu sa hartijama od vrijednosti, usluge notiranja cijena na berzi; posredovanje u vezi sa akcijama i obveznicama, finansijske analize; usluge debitnih kartica, usluge platnih kartica i usluge čekovne garancije; bankarske, usluge štednih računa i investicione usluge; usluge finansijskog kliringa; kreditna verifikacija putem globalne računarske informacione mreže; elektronske usluge upravljanja rizikom kredita; usluge elektronskog plaćanja za kupovinu i elektronskog plaćanja računa; zaduživanje finansijskih računa i kreditne usluge; elektronske bankarske usluge; izdavanje pretplatničkih kartica, platnih kartica i debitnih kartica; usluge telefonskih kreditnih kartica; informativne usluge u vezi sa finansijama i osiguranjem, pružene onlajn sa računarske baze podataka ili interneta; agencija za prikupljanje naknada za gas i električnu energiju; procjena antikviteta; procjena umjetničkih djela; procjena nakita; procjena polovnih vozila; snabdijevanje poreskim informacijama (finansijske usluge); prikupljanje priloga za dobrotvorne fondove; organizovanje dobrotvornog prikupljanja; dobrotvorno prikupljanje; iznajmljivanje mašina za brojenje papirnog novca i kovanica; iznajmljivanje bankomata ili automatizovanih mašina za izdavanje gotovine; usluge onlajn plaćanja; organizovanje finansija za građevinske projekte; izdavanje vaučera; pružanje usluga elektronskog transfera sredstava; mjenjačke usluge, usluge izdavanja gotovine, pružanje pripejd kartica ili tokena, usluge transfera novca; uključujući sve gore navedene usluge pružene elektronskim putem; konsultantske, informativne i savjetodavne usluge u vezi sa elektronskim transferom sredstava; usluge transfera strane valute; razmjena stranih valuta; trgovina valutama; poslovanje u vezi sa valutama; posredovanje u vezi sa valutama; finansijske transakcije putem blokčejna; pružanje usluga dobrotvornog prikupljanja u vezi sa kompenzacijom za emisiju ugljenika; posredovanje u kompenzaciji za emisiju ugljenika; finansijsko sponzorisanje programa kompenzacije za emisiju ugljenika; finansiranje i ulaganje u projekte smanjenja emisije ugljenika; ulaganje u programe i projekte kompenzacije za emisiju ugljenika; ulaganje u fondove za smanjenje emisije ugljenika; pružanje zajmova; pružanje privremenih zajmova; konsultantske, informativne i savjetodavne usluge u vezi sa gore navedenim uslugama.

Klasa 42: Naučne i tehnološke usluge i istraživanja i projektovanja u vezi sa njima, usluge industrijskih analiza i istraživanja; projektovanje i razvoj računarskog hardvera i softvera; softver u vidu servisa (SaaS); kodiranje, dekodiranje i autentifikacija informacija, poruka i podataka; pružanje usluga korisničke autentifikacije koristeći biometrijsku, autentifikaciju prepoznavanjem lica, otiskom prsta, prepoznavanje glasa i druge tipove hardverske i softverske tehnologije za autentifikaciju prilikom pružanja finansijskih usluga, elektronske trgovine, donacija, praćenja licenciranih proizvoda i angažovanja obožavatelja; usluge obezbjeđivanja podataka; IT bezbjednost, zaštita i obnova; analize računarskih bezbjednosnih prijetnji za zaštitu podataka; pružanje usluga bezbjednosti za računarske mreže, pristup računaru i kompjuterizovane transakcije; sertifikacija (kontrola kvaliteta)

podataka putem blokčaina; autentifikacija podataka putem blokčaina; uključujući sve prethodno navedene usluge u vezi sa sistemima plaćanja; računarske usluge u vezi sa prenosom informacija, podataka, dokumenata i slika preko interneta; usluge provajdera aplikacija (ASP), naime, hosting računarskih softverskih aplikacija za druge; usluge provajdera aplikacija (ASP) za pružanje softvera u oblasti veb zasnovanih konferencija, audio konferencija, elektronskih poruka, kolaboracije dokumenata, video konferencija, i obrade glasa i poziva; pružanje onlajn softvera koji se ne može preuzimati za olakšavanje interoperabilnosti više softverskih aplikacija; usluge tehničke podrške u vezi sa računarskim softverom i aplikacijama pruženim onlajn, putem email-a i telefona; računarske usluge, naime kreiranje onlajn zajednice za registrovane korisnike da učestvuju u raspravi, dobiju povratnu informaciju od svojih vršnjaka, formiraju virtuelne zajednice, učestvuju u društvenim mrežama i razmenjuju dokumenta; savjeti o računarskim tehnologijama pruženi internet korisnicima putem telefonske podrške; računarske usluge u vezi sa kreiranjem indeksa informacija, stranica i izvora na računarskoj mreži; pružanje alata za pretraživanje na internetu; dizajn računara, noutbuk računara, laptop računara, prenosivih računara i ručnih računara; dizajn ličnih digitalnih asistenata i ličnih media plejera; dizajn mobilnih telefona i pametnih telefona; dizajn digitalnih kamera; računarske usluge; računarsko programiranje; računarske integracione usluge; usluge računarske analize; računarsko programiranje u vezi sa odbranom od virusa; usluge računarskog sistemskog softvera; usluge projektovanja softvera; projektovanje i razvoj veb-stranica; hosting veb-stranica za druge; hosting softver računarskih aplikacija za pretraživanje i vraćanje informacija iz baze podataka i računarske mreže; pružanje tehničkih informacija po posebnom zahtjevu krajnjih korisnika putem telefona ili globalne računarske mreže; savjetodavne usluge u vezi sa računarskim softverom; računarske usluge u vezi sa prilagođenim pretraživanjem računarske baze podataka i veb-stranica; računarsko i elektronsko kodiranje i dekodiranje signala; konverzija fizičkih podataka i dokumenata u elektronske medijske formate; testiranje proizvoda i usluge procjene; arhitektonske i usluge dizajna; dizajn enterijera zgrada, kancelarija i apartmana; računarske informativne usluge; mrežne informativne usluge, naime, pružanje tehničkih informacija u vezi sa računarima i mrežama u oblasti poslovanja i elektronske trgovine; pružanje računarskih programa za upravljanje rizikom bezbjednosti; usluge računarskih bezbjednosnih informacija, znanja i usluge testiranja; usluge osiguranja kvaliteta; računarske usluge u vezi sa sertifikacijom poslovnih transakcija i pripremanje izvještaja u vezi sa njima; računarske bezbjednosne usluge u vezi sa kontrolom pristupa računarima, elektronskim mrežama i bazama podataka; obezbjeđivanje prenosa podataka i transakcija putem računarskih mreža; konsultacije u oblasti bezbjednosti podataka; tehnološke konsultacije u vezi sa bezbjednošću telekomunikacija; bezbjednosne usluge kompjuterizovanih komunikacionih mreža; pružanje informacija u oblasti interneta, svjetske komunikacione mreže i bezbjednosti kompjuterizovanih komunikacionih mreža i sigurnog prenosa podataka i informacija; konsalting usluge u oblasti interneta, svjetske komunikacione mreže i bezbjednosti kompjuterizovanih komunikacionih mreža, usluge bezbjednosti informacija; usluge autentifikacije za bezbjednost računara; onlajn autentifikacija elektronskih potpisa; pohranjivanje rezervnih podataka van glavne lokacije (off-site); usluge čuvanja elektronskih podataka; pružanje informacija o računarskim tehnologijama i programiranju putem veb- stranica; kartografske usluge; računarstvo u oblaku; usluge hosting provajdera oblaka; pružanje privremene upotrebe softvera koji se zasniva na oblaku i koji se ne može preuzeti i softvera za računarstvo u oblaku; elektronsko pohranjivanje podataka; pružanje virtuelnih računarskih sistema i virtuelne računarske sredine putem računarstva u oblaku; iznajmljivanje softvera za zabavu; tehničko istraživanje

u vezi sa kompenzacijom emisije ugljenika; pružanje informacija, savjeta i konsultacija u vezi sa kompenzacijom emisije ugljenika i zaštitom životne sredine; pružanje tehnoloških informacija o svijesti o životnoj sredini i ekološkim inovacijama; testiranje životne sredine, usluge procjene i monitoringa; istraživanja u oblasti zaštite i očuvanja životne sredine; istraživanja i pružanje naučnih informacija u oblasti klimatskih promjena; naučne i industrijske konsultativne usluge u vezi sa gorivima, emisijom goriva i ugljen-dioksida i problemima životne sredine; usluge naučnog i tehnološkog istraživanja u vezi sa preporukama za smanjenje ugljen-dioksida na ekonomičan način; usluge naučnog i tehnološkog istraživanja u vezi sa upravljanjem programima za kompenzaciju emisije ugljenika; usluge istraživanje životne sredine, usluge upravljanja i zaštite; konsultativne, informativne i savjetodavne usluge u vezi sa naprijed navedenim uslugama.

(111) **15018**

(151) 16.11.2020.

(210) Ž-2020-75

(220) 28.02.2020.

(732) Kerzner International Limited, Atlantis Paradise Island, Coral Towers Executive Office, P.O. Box N4777, Nassau, BS

(540)

SIRO

(550) I

(740) Jasna Jusić, Dalmatinska 2, 81000, Podgorica

(511) Klasa 36: Lizing nekretnina; usluge upravljanja nekretninama; usluge vezane za nekretnine, naime, lizing, posredovanje, upravljanje i vođenje kondominijuma i vila; finansiranje u vezi sa nekretninama; usluge upravljanja nekretninama i imovinom; usluge vezane za nekretnine, naime, zakup, iznajmljivanje i upravljanje kućama za odmor, kondominijumima i vilama, kao i upravljanje jedinicama kondominijuma; usluge udruženja vlasnika kuća, naime, upravljanje zajednicom u vidu brige o zajedničkim prostorima i sadržajima.

Klasa 39: Usluge marine, uključujući iznajmljivanje vozova za plovila, skladištenje brodova, usluge iznajmljivanja marine; organizovanje putovanja i krstarenja, usluge iznajmljivanja morskih plovila; pružanje informacija u vezi sa marinama; pružanje pomoći u vezi sa pristajanjem; pomoć na doku pri transferu prtljaga i namirnica, transport između marine i odmarališta; organizacija putovanja, naime organizovanje i vođenje turističkih obilazaka i pružanje informacija u oblasti turističkih obilazaka; usluge turističke agencije, naime rezervisanje i bukiranje prevoza; usluge avio prevoza; naime čarter i redovne usluge avio prevoza za putnike i tovar; organizovanje ekskurzija za turiste u oblasti podvodnog ronjenja i ronjenja s maskom na disaljku kao i krstarenja brodom i zakupljivanja broda.

Klasa 41: Usluge zabave u vezi sa akvarijumima, morskim staništem i pratećim izložbama; usluge klubova zdravlja, naime, obezbjeđivanje obuke i opreme u oblasti fizičkih vježbi; klubovi zdravlja za fizičke vježbe; konsultacije za fizičku kondiciju; instrukcije za fizičku

kondiciju; obezbjeđivanje objekata za fitnes i vježbanje; individualni i grupni fitnes treninzi; obezbjeđivanje sportskih objekata i teniskih terena; razonoda u vidu turnira u golfu i tenisu; usluge golf klubova; usluge nosača golf palica; usluge zabave u vidu tematskih parkova kao što su vodeni sportovi, vožnje gliserima i izložbe, atrakcije i vožnje u zabavnim parkovima; razonoda u vidu noćnih klubova; obezbjeđivanje kazino usluga i kazino objekata; usluge zabave koje pružaju hoteli; obezbjeđivanje usluga dječijih kampova.

Klasa 43: Obezbjeđivanje privremenog smještaja; obezbjeđivanje hotelskog smještaja, hotelskih usluga, usluga odmarališta; organizovanje smještaja u odmaralištima; pružanje objekata i usluga za kongrese; usluge putničkih agencija, rezervisanje smještaja i rezervisanje i bukiranje za ručavanje; usluge restorana i barova; zdravstvene usluge, naime, obezbjeđivanje hrane i smještaja koji su specijalizovani za promociju opšteg zdravlja i dobrobiti klijenata; usluge spa centra, naime, obezbjeđivanje privremenog smještaja i obroka klijentima spa centra ili salona ljepote.

Klasa 44: Usluge spa centra; usluge salona ljepote; rezervisanje i bukiranje tretmana u spa centrima i salonima ljepote za druge; usluge spa centara u vezi sa zdravljem i opštim dobrom tijela i duha; pružanje informacija iz oblasti zdravlja i opšteg fizičkog i mentalnog zdravlja.

(111) **15019**

(151) 18.11.2020.

(210) Ž-2019-482

(220) 09.12.2019.

(732) British American Tobacco (Brands) Inc., 251 Little Falls Drive, Suite 100, DE 19808-1674, Wilmington, Delaware, US

(540)



(550) I

(740) Miladin Popović, Đoka Miraševića 21/III, 81000, Podgorica

(511) Klasa 34: Cigarete; duvan, sirov ili prerađen; duvan za zamotavanje; duvan za lulu; duvanski proizvodi; zamjene za duvan (ne u medicinske svrhe); cigare; cigarilos; upaljači za cigarete; upaljači za cigare; šibice; artikli za pušaće; cigaret papir; cigaret tube; filteri za cigarete; džepni aparati za zamotavanje cigareta; ručne mašine za ubrizgavanje duvana u papirne tube; elektronske cigarete; tečnosti za elektronske cigarete; duvanski proizvodi namijenjeni za zagrijavanje.

(111) **15020**

(151) 18.11.2020.

(210) Ž-2019-483

(220) 09.12.2019.

(732) British American Tobacco (Brands) Inc., 251 Little Falls Drive, Suite 100, DE 19808-1674, Wilmington, Delaware, US

(540)



(550) I

(740) Miladin Popović, Đoka Miraševića 21/III, 81000, Podgorica

(511) Klasa 34: Cigarete; duvan, sirov ili prerađen; duvan za zamotavanje; duvan za lulu; duvanski proizvodi; zamjene za duvan (ne u medicinske svrhe); cigare; cigarilosi; upaljači za cigarete; upaljači za cigare; šibice; artikli za pušaće; cigaret papir; cigaret tube; filteri za cigarete; džepni aparati za zamotavanje cigareta; ručne mašine za ubrizgavanje duvana u papirne tube; elektronske cigarete; tečnosti za elektronske cigarete; duvanski proizvodi namijenjeni za zagrijavanje.

(111) **15021**

(151) 18.11.2020.

(210) Ž-2020-3

(220) 10.01.2020.

(732) Lidl Stiftung & Co. KG , Stiftsbergstraße 1, 74172, Neckarsulm, DE

(540)



(550) I

(740) AOD MSA IP - Milojević Sekulić Advokati, Karađorđeva 65, 11000, Beograd

(511) Klasa 33: Alkoholna pića (izuzev piva), a naročito žestoka pića.

(111) **15022**

(151) 18.11.2020.

(210) Ž-2020-42

(220) 07.02.2020.

(732) Lidl Stiftung & Co. KG , Stiftsbergstraße 1, 74172, Neckarsulm, DE

(540)



(550) I

(740) AOD MSA IP - Milojević Sekulić Advokati, Karađorđeva 65, 11000, Beograd

(511) Klasa 5: Lekovi; farmaceutski preparati; sanitarni preparati za upotrebu u medicini; vitaminsko mineralni preparati; dijetetske supstance (koje su obuhvaćene ovom klasom); dodaci ishrani (koji su obuhvaćeni ovom klasom).

(111) **15026**

(151) 18.11.2020.

(210) Ž-2019-261

(220) 04.07.2019.

(732) "MULTIMAT" DOO PODGORICA, Trg Golootockih žrtava bb, ME

(540)



(550) I

(511) Klasa 28: Igre i igračke; gimnastički i sportski predmeti koji nisu obuhvaćeni drugim klasama; ukrasi za božićne jelke

Klasa 41: Obuka; stručno osposobljavanje; razonoda; sportske i kulturne djelatnosti.

(111) **15023**

(151) 18.11.2020.

(210) Ž-2020-57

(220) 18.02.2020.

(732) Hemofarm A.D. farmaceutsko-hemijska industrija Vršac, Beogradski put bb, 26300, Vršac, RS

(540)

BELL

(550) I

(740) AOD MSA IP - Milojević Sekulić Advokati, Karađorđeva 65, 11000, Beograd

(511) Klasa 5: Farmaceutski preparati.

(111) **15024**

(151) 18.11.2020.

(210) Ž-2020-74

(220) 27.02.2020.

(732) VITRINOR VITRIFICADOS DEL NORTE, S.A.L., Barrio de Rioseco, S/N, 39788, Guriezo (CANTABRIA), ES

(540)



(550) I

(740) AOD MSA IP - Milojević Sekulić Advokati, Karađorđeva 65, 11000, Beograd

(511) Klasa 21: Kuhinjski proizvodi za upotrebu u domaćinstvu proizvedeni od čelika, emajla i aluminijuma, kao što su tiganji, lonci, tepsije, čajnici, vok tiganji.

(111) **15025**

(151) 18.11.2020.

(210) Ž-2020-79

(220) 05.03.2020.

(732) Hemofarm A.D. farmaceutsko-hemijska industrija Vršac, Beogradski put bb, 26300, Vršac, RS
(540)

TREGONA

(550) I

(740) AOD MSA IP - Milojević Sekulić Advokati, Karađorđeva 65, 11000, Beograd

(511) Klasa 5: Farmaceutski proizvodi.

(111) **15028**

(151) 18.11.2020.

(210) Ž-2020-35

(220) 04.02.2020.

(732) Kraft Foods Schweiz Holding GmbH, Chollerstrasse 4, 6300, Zug, CH

(540)

MILKA JUST FOR YOU

(550) I

(740) Miladin Popović, Đoka Miraševića 21/III, 81000, Podgorica

(511) Klasa 30: Kakao; napici na bazi kakaa i čokolade i preparati za pravljenje istih; čokolada, nemedicinski konditorski proizvodi, posebno konditorski proizvodi od čokolade i konditorski proizvodi od šećera; keksi, napolitanke, kolači, peciva, čizkejk, pečeni i proizvodi od tijesta; preparati od žitarica; jestivi led, naime proizvodi od sladoleda, smrznute poslastice i deserti; rashlađene poslastice i deserti; čokoladni namazi.

(111) **15027**

(151) 19.11.2020.

(210) Ž-2019-373

(220) 27.09.2019.

(732) Novartis AG, Basel, 4002, CH

(540)

RUNAPLAX

(550) I

(740) AOD MSA IP - Milojević Sekulić Advokati, Karađorđeva 65, 11000, Beograd

(511) Klasa 5: Farmaceutski preparati za ljudsku upotrebu.

(111) **15029**

(151) 19.11.2020.

(210) Ž-2019-381

(220) 04.10.2019.

(732) H Hospitality Collection Holding Limited, P.O. Box 32932, 33, Al Khatem tower, Abu Dhabi Global Market Square, Al Maryah Island, Abu Dhabi, AE

(540)

CUE

(550) I

(740) Jasna Jusić, Dalmatinska 2, 81000, Podgorica

(511) Klasa 41: Obrazovanje; obezbjeđivanje obuke; zabava; sportske i kulturne aktivnosti; obezbjeđivanje hotelskih sadržaja za potrebe obuke; pružanje usluga teretane i sadržaja zdravstvenog kluba; organizovanje i sprovođenje konferencija, sastanaka, izložbi, treninga, radionica, poslovnih sajmova, kongresa i predavanja; obezbjeđivanje rekreacionih sadržaja; usluge kampa (odmor) [zabava]; klupske usluge [zabava ili obrazovanje]; vođenje časova fitnesa; ronilačka oprema (iznajmljivanje ronilačke opreme); informacije o zabavi; izložbe (organizovanje) za kulturne ili obrazovne svrhe; iznajmljivanje opreme za igre; usluge zdravstvenog kluba [zdravstveni i fitnes trening]; informacije (rekreacija); iznajmljivanje biblioteka; nastupi uživo (prezentacija); usluge ličnog trenera [fitnes trening].

Klasa 43: Usluge obezbjeđivanja hrane i pića; privremeni smještaj; hotelske usluge; usluge rezervacije, bukiranja i davanja informacija u vezi sa hotelima i privremenim smještajem; usluge potpuno opremljenih apartmana [smještaj]; hotelske usluge obezbjeđivanja objekata za konferencije, sastanke, izložbe, obuke, radionice, poslovne sajmove, kongrese i predavanja; ugostiteljske usluge [smještaj/hrana i piće]; usluge restorana, samouslužnih restorana, restorana sa hranom za ponijeti, kafeterija, kafića, snack-barova; usluge obezbjeđivanja kateringa hrane i pića; dnevne jaslice [jasle].

Klasa 44: Higijenske i kozmetičke usluge; usluge aromaterapije; turska kupatila; usluge kozmetičkog salona; usluge frizerskog salona; usluge masaže; usluge saune; usluge banja; zdravstvene i usluge opuštanja u odmaralištima; usuge pružanja zdravstvenih, fitnes i medicinskih informacija; usluge procjene kondicije; savjeti o ishrani; kozmetičke i usluge njege kože; usluge kozmetičkih tretmana; pružanje usluga i obezbjeđivanje uređaja za tamnjenje kože; pružanje usluga manikira i pedikira; zdravstvena zaštita; manikir; usluge solarijuma; usluge vizažista.

(111) **15035**

(151) 19.11.2020.

(210) Ž-2019-434

(220) 07.11.2019.

(732) BMJ INDUSTRIES FZ-LLC, P.O. Box: 31053, Al Jazeera Al Hamra Free Zone, Ras Al Khaimah, AE

(540)

TAJ

(550) I

(740) Ana Ivanović, Bulevar Svetog Petra Cetinjskog br.149, 81000, Podgorica

(511) Klasa 34: Duvan; pribor za pušače; šibice.

(111) **15035**

(151) 19.11.2020.

(210) Ž-2019-347

(220) 11.09.2019.

(732) Papoutsanis S.A., 71st klm Ethnikis Odou Athinon Lamias, Vathi Avlidos, (in English 71st klm National Road Athens-Lamia, 34100 Halkida), 34100, Halkida, GR

(540)



(550) I

(740) AOD "Ćupić", Bulevar Džordža Vašingtona 79, 81000, Podgorica

(511) Klasa 3: Šamponi i balzami za kosu; maske za kosu; pjene za kupanje; ulja za kozmetičke svrhe; ulja za kosu i tijelo; sapuni za ličnu upotrebu; sapuni za lice; sapuni za tijelo; piling sapuni; glicerinski sapuni; tečni sapuni; sredstva za čišćenje za intimnu ličnu higijenu, nemedicinski; kozmetičke kreme i kozmetičke emulzije za lice i tijelo; losioni za lice i tijelo; mirisni sprej za ličnu upotrebu; mirisi; preparati za zaštitu od sunca i preparati za sunčanje (ne za medicinske svrhe); gelovi za njegu stopala, nemedicinski; preparati za

uklanjanje šminke; preparati prije brijanja i posle brijanja.

(111) **15038**

(151) 19.11.2020.

(210) Ž-2019-349

(220) 11.09.2019.

(732) Papoutsanis S.A., 71st klm Ethnikis Odou Athinon Lamias, Vathi Avlidios, (in English 71st klm National Road Athens-Lamia, 34100 Halkida), 34100, Halkida, GR

(540)



(550) I

(740) AOD "Ćupić", Bulevar Džordža Vašingtona 79, 81000, Podgorica

(511) Klasa 3: Šamponi i balzami za kosu; maske za kosu; pjene za kupanje; ulja za kozmetičke svrhe; ulja za kosu i tijelo; sapuni za ličnu upotrebu; sapuni za lice; sapuni za tijelo; piling sapuni; glicerinski sapuni; tečni sapuni; sredstva za čišćenje za intimnu ličnu higijenu, nemedicinski; kozmetičke kreme i kozmetičke emulzije za lice i tijelo; losioni za lice i tijelo; mirisni sprej za ličnu upotrebu; mirisi; preparati za zaštitu od sunca i preparati za sunčanje (ne za medicinske svrhe); gelovi za njegu stopala, nemedicinski; preprati za uklanjanje šminke; preparati prije brijanja i posle brijanja.

(111) **15038**

(151) 19.11.2020.

(210) Ž-2019-353

(220) 13.09.2019.

(732) "12 mjeseci" DOO Bar, Topolica 1, Bar, ME

(540)



(550) I

(740) Dea Tršić, Bulevar Revolucije A-3, Bar

(511) Klasa 35: Oglašavanje i reklamiranje; vođenje komercijalnih poslova; komercijalna administracija; kancelarijski poslovi.

Klasa 43: Usluge obezbjeđivanja hrane i pića; privremeno primanje na stan.

Klasa 44: Medicinske usluge; veterinarske usluge; higijenska njega i njega ljepote za ljude ili za životinje; usluge poljoprivrede, povrtlarstva i šumarstva.

(111) **15039**

(151) 19.11.2020.

(210) Ž-2019-354

(220) 13.09.2019.

(732) "12 mjeseci" DOO Bar, Topolica 1, Bar, ME

(540)



(550) I

(740) Dea Tršić, Bulevar Revolucije A-3, Bar

(511) Klasa 35: Oglašavanje i reklamiranje; vođenje komercijalnih poslova; komercijalna administracija; kancelarijski poslovi.

Klasa 43: Usluge obezbjeđivanja hrane i pića; privremeno primanje na stan.

Klasa 44: Medicinske usluge; veterinarske usluge; higijenska njega i njega ljepote za ljude ili za životinje; usluge poljoprivrede, povrtlarstva i šumarstva.

(111) **15040**

(151) 19.11.2020.

(210) Ž-2019-377

(220) 03.10.2019.

(732) JT International S.A., Rue Kazem-Radjavi 8, 1202, Geneva, CH

(540)

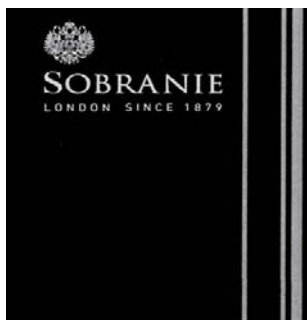

(550) I

(740) Jasna Jusić, Dalmatinska 2, 81000, Podgorica

(511) Klasa 34: Duvan, koji je prerađen ili neprerađen; duvan za pušenje, duvan za lule, duvan za savijanje, duvan za žvakanje, duvan za sisanje, cigarete, elektronske cigarete, cigare, cigarilosi; burmut; artikli za pušače uključeni u klasu 34; papir za cigarete, fišeci za cigarete i šibice.

(111) **15041**

(151) 19.11.2020.

(210) Ž-2019-379

(220) 04.10.2019.

(732) H Hospitality Collection Holding Limited, P.O. Box 32932, 33, Al Khatem tower, Abu Dhabi Global Market Square, Al Maryah Island, Abu Dhabi, AE

(540)

STORY

(550) I

(740) Jasna Jusić, Dalmatinska 2, 81000, Podgorica

(511) Klasa 41: Obrazovanje; obezbjeđivanje obuke; zabava; sportske i kulturne aktivnosti; obezbjeđivanje hotelskih sadržaja za potrebe obuke; pružanje usluga teretane i sadržaja zdravstvenog kluba; organizovanje i sprovođenje konferencija, sastanaka, izložbi, treninga, radionica, poslovnih sajmova, kongresa i predavanja; obezbjeđivanje rekreacionih sadržaja; usluge kampa (odmor) [zabava]; klupske usluge [zabava ili obrazovanje]; vođenje časova fitnesa; ronilačka oprema (iznajmljivanje ronilačke opreme); informacije o zabavi; izložbe (organizovanje) za kulturne ili obrazovne svrhe; iznajmljivanje opreme za igre; usluge zdravstvenog kluba [zdravstveni i fitnes trening]; informacije (rekreacija); iznajmljivanje biblioteka; nastupi uživo (prezentacija); usluge ličnog trenera [fitnes trening].

Klasa 43: Usluge obezbjeđivanja hrane i pića; privremeni smještaj; hotelske usluge; usluge rezervacije, bukiranja i davanja informacija u vezi sa hotelima i privremenim smještajem; usluge potpuno opremljenih apartmana [smještaj]; hotelske usluge obezbjeđivanja objekata za konferencije, sastanke, izložbe, obuke, radionice, poslovne sajmove, kongrese i predavanja; ugostiteljske usluge [smještaj/hrana i piće]; usluge restorana, samouslužnih restorana, restorana sa hranom za ponijeti, kafeterija, kafića, snack-barova; usluge obezbjeđivanja kateringa hrane i pića; dnevne jaslice [jasle].

Klasa 44: Higijenske i kozmetičke usluge; usluge aromaterapije; turska kupatila; usluge kozmetičkog salona; usluge frizerskog salona; usluge masaže; usluge saune; usluge banja; zdravstvene i usluge opuštanja u odmaralištima; usluge pružanja zdravstvenih, fitnes i medicinskih informacija; usluge procjene kondicije; savjeti o ishrani; kozmetičke i usluge njege kože; usluge kozmetičkih tretmana; pružanje usluga i obezbjeđivanje uređaja za tamnjenje kože; pružanje usluga manikira i pedikira; zdravstvena zaštita; manikir; usluge solarijuma; usluge vizažista.

(111) **15042**

(151) 19.11.2020.

(210) Ž-2016-515

(220) 15.12.2016.

(732) HELLENIC FUELS AND LUBRICANTS SINGLE MEMBER INDUSTRIAL AND COMMERCIAL SOCIETE ANONYME, also trading as "EKO ABEE", 8A Cheimarras street, 15125, Marousi, GR

(540)



(550) I

(511) Klasa 1: Hemikalije koje se koriste u industriji, nauci i fotografiji, kao i poljoprivredi, hortikulturi i šumarstvu; računске vještačke smole, računске plastične mase; dubriva; jedinjenja za gašenje požara; preparati za kaljenje i lemljenje; hemijske supstance za očuvanje namirnica; supstance za štavljenje; lijepkovi koji se koriste u industriji; hemijski aditivi za upotrebu u proizvodnji maziva; hemijski aditivi; hemijski aditivi za maziva; deterdžentni aditivi za maziva; naftni derivati; naftni raspršivači; katalizatori pucanja nafte; hemijski dodaci za naftu; deterdžentni aditivi za benzin (petrolej); hemijski aditivi za ulja za grijanje; hemijski proizvodi dobijeni od nafte; aditivi za navodnjavanje; hemijski preparati za disperziju nafte; aditivi (hemijski) za naftne derivate; tečnosti za korišćenja u naftnoj industriji; hemijski dodaci tečnostima pri vađenju nafte iz bušotina; hemijski aditivi za dizel goriva; katalizatori za upotrebu u obradivačkoj naftnoj industriji; hemikalije za primjenu u industriji za preradu nafte; hemikalije za upotrebu u formiranju naftnih bušotina; aditivi za podizanje broja naftnih oktana; polimeri za upotrebu pri bušenju i naftnoj industriji; tečnosti za upotrebu u transportu cestica materijala sa naftnih izvora; hemijski aditivi za beton naftnih bušotina; smjese za zaptivanje za spriječavanje curenja iz naftnih rezervoara (hemikalije).;

Klasa 4: Industrijska ulja i masti; maziva; mješavine za upijanje prašine, vlaženje i vezivanje; goriva (uključujući motorni benzin) i osvjetlivači; svijeće i fitilji za rasvjetu; ulja za podmazivanje; ulja za turbine; sintetička ulja; mineralna ulja; lubrikantne masti; maziva za automobile; auto maziva za automobilske motore; mazivna ulja za motore motornih vozila; maziva za motorna vozila; višenamjenska maziva; maziva pri bušenju naftnih bušotina; morska ulja; maziva za upotrebu u industrijskim procesima; sintetička maziva; masti; masti za automobile; masti za podmazivanje vozila; mast za kočnice; petrolej; sirova nafta; ulje za rasvetu; vještački petrolej; tečni naftni gas; petrolejski nusproizvodi; naftni koks; naftni etar; industrijska lož ulja; naftni gas; ligroin; petrohemijski naftni aditivi; naftna goriva; goriva dobijena iz sirove nafte; tečni naftni gasovi koji se koriste kod motornih vozila; gasne ulje za grijanje domaćinstava; tečni naftni gasovi koji se koriste za domaće potrebe; tečni naftni gasovi koji se koriste u industrijske svrhe; pojačivaci sagorijevanja (naftni derivati); aditivi (nehemijski) za naftne derivate; naftni koks koji se upotrebljava kao gorivo; gasne ulje za industrijsko grijanje; jedinjenja na bazi nafte za upijanje prašine; aditivi (ne-hemijski) za goriva; dizel ulje; mazut; sirova nafta; motorna ulja.;

Klasa 7: Priručne mašine, automatske (manipulatori); pumpe za točenje goriva na servisnim stanicama; samopodešavajuće pumpe za gorivo; uređaji za podizanje; mehanizmi za podizanje za vozila; mehanizmi za podizanje za prikolice; instalacije za izvlačenje prašine u cilju čišćenja; nastavci za usisivače za raspršivanje parfema i dezinfekcionih sredstava; mašine za usisavanje za industrijsku upotrebu; automatski aparati za prodaju; samopodešavajuće pumpe za gorivo; instalacije za uklanjanje prašine u cilju čišćenja; dizalice (mašine); elektromehaničke mašine za hemijsku industriju; kranovi (aparati za podizanje); pokretne dizalice za mostove; priručni aparati za utovar i istovar; mašine za sortiranje za industriju; mašine za prepad u ulja; instalacije za pranje vozila; ručni alat za mehaničko pokretanje; mašine za čišćenje i aparati za čišćenje, električni; uređaji za čišćenje koji koriste paru; aparati za čišćenje pod visokim pritiskom; aparati za konverziju goriva za motore sa unutrašnjim sagorijevanjem; uređaji za uštedu goriva za motore i mašine; mašine za pranje koje se pokreću novcem; pumpe za podmazivanje; katalitički pretvarači; aparati za konverziju goriva za motore sa unutrašnjim sagorijevanjem; mašine za transport; mašine i aparati za čišćenje, električni; pneumatski transporteri; instalacije za pranje za vozila; vazdušni jastuci kao oprema za pokretanje vozila; pneumatski cijevni vodovi; mašine za katranisanje; instalacije za pranje za vozila; mašine za pranje koje se pokreću novcem; mašine za ispiranje; mašine za presovanje; kompresori (mašine); električni aparati za

zavarivanje; aparati za zavarivanje, električni; mašine za pecacenje za industrijsku upotrebu; trake za prenosnike; platforme za utovar; izduvne mašine za kompresiju, izbacivanje i prenos gasova; električni generatori na dizel gorivo; mašine za pumpanje za naftne bušotine; oprema za izvlacenje nafte; alati za izvlacenje nafte; pumpe za naftu za motore za suvozemna vozila; oprema za poljoprivredu, zemljane radove, izgradnju, vadenje nafte i gasa i rudarstvo.;

Klasa 12: Vozila; aparati za kretanje po zemlji, vazduhu ili vodi; dizel motori za suvozemna vozila.;

Klasa 35: Oglašavanje; poslovno upravljanje; poslovna administracija; kancelarijski poslovi; maloprodajne usluge u vezi sa: hemikalijama koje se upotrebljavaju u industriji, nauci i fotografiji, kao i poljoprivredi, hortikulturi i šumarstvu; neobrađene vještačke smole, neobrađena plastika; dubriva; smješe za gašenje požara; preparati za kaljenje i lemljenje; hemijske supstance za čuvanje hrane; supstance za štavljenje; lijepkovi koji se koriste u industriji; hemijski aditivi za upotrebu u proizvodnji maziva; hemijski aditivi; hemijski aditivi za maziva; deterdžentski aditivi za maziva; naftni derivati; sredstva za raspršivanje nafte; katalizatori za krekovanje nafte; hemijski naftni aditivi; deterdžentski aditivi za gorivo (benzin); hemijski aditivi za ulja za grijanje; hemijski proizvodi koji su derivati nafte; aditivi za proces ubacivanja vode u naftu; hemijski preparati za rasprskivanje nafte; aditivi (hemijski) za naftne proizvode; tečnosti za upotrebu u naftnoj industriji; hemijski aditivi za tečnost za bušotine nafte; hemijski aditivi za dizel goriva; katalizatori koji se upotrebljavaju u industriji obrade nafte; hemikalije koje se upotrebljavaju u rafinerijama nafte; hemikalije koje se upotrebljavaju u formiranju naftnih bušotina; aditivi za podizanje broja oktana u nafti; polimeri za upotrebu u bušenju i naftnoj industriji; tečnosti za upotrebu u prenosu čestica u naftnim bušotinama; hemijski aditivi za cement za naftne bušotine; zaptivne smješe za zaustavljanje curenja iz naftnih cisterni (hemikalija); industrijska ulja i masti; maziva; smješe za upijanje, vlaženje i vezanje prašine; goriva (uključujući motorna goriva) i rasvjetna sredstva; svijece i fitilji za paljenje; motorna ulja; mazivna ulja; ulja za turbine; sintetička ulja; mineralna ulja; mazivne masti; automobilska maziva; automobilska maziva za motore automobile; nafta; sirova nafta; ulja za osvjetljavanje; vještačka nafta; tečni naftni gas; nusprodukti nafte; naftni koks; naftni etar; industrijska goriva; naftni gas; ligroin; petrohemijski naftni aditivi; naftni derivati kao goriva; goriva od sirove nafte; tečni naftni gas za upotrebu u motornim vozilima; naftni gas za grijanje kuće; tečni naftni gas za kućne potrebe; tečni i naftni gas za industrijske potrebe; pojačivači sagorijevanja (naftni proizvodi); aditivi (nehemijski) za naftne proizvode; naftni koks za upotrebu kao gorivo; naftni gas za industrijsko grijanje; smješe za upijanje prašine na bazi nafte; aditivi (nehemijski) za goriva; dizel ulje; mazut; sirova nafta; automatske mašine za upravljanje (manipulatori); pumpe za točenje goriva na benzinskim stanicama; samoregulirajuće pumpe za goriva; aparati za podizanje; mehanizmi za podizanje vozila; mehanizmi za podizanje za prikolice; instalacije za izbacivanje prašine za potrebe čišćenja; dodaci za usisivače za rasprskivanje parfema i dezinfekcionih sredstava; usisnici za industrijske potrebe; automatske mašine za prodaju; samoregulirajuće pumpe za goriva; instalacije za uklanjanje prašine za potrebe čišćenja; dizalice (mašine); elektromehaničke mašine za hemijsku industriju; kranovi (aparati za dizanje); mostovi sa valjcima; aparati za upravljanje utovarom i istovarom; sortirne mašine za industriju; mašine za rafinisanje nafte; instalacije za pranje vozila; ručni alati, izuzev onih kojima se ručno upravlja; električne mašine i aparati za čišćenje; uređaji za čišćenje parom; uređaji za čišćenje pod visokim pritiskom; aparati za pretvaranje goriva za motore sa unutrašnjim sagorijevanjem; ekonomizatori za motore i pogonske motore; mašine za pranje veša koje rade na kovanice; mazivne pumpe; katalitički konverteri; aparati za pretvaranje goriva za

motore sa unutrašnjim sagorijevanjem; mašine za prenos; električne mašine i aparati za čišćenje; pneumatski prenosnici; instalacije za pranje vozila; uređaji sa vazdušnim jastucima za vozila koja se krecu; pokretne trake sa pneumatskim cijevima; mašine za nanošenje katrana; instalacije za pranje vozila; mašine za pranje veša koje rade na kovanice; mašine za ispiranje; mašine za sabijanje; kompresori (mašine); električni aparati za varenje; aparati za varenje, električni; mašine za zaptivanje za industrijske potrebe; kaiševi za pokretne trake; platforme za utovarivanje; mašine za duvanje za kompresiju, izduvavanje i prenos gasova; dizelski električni generatori; mašine za pumpanje nafte; naftne bušotine; alati za bušenje nafte; naftne pumpe za kopnena motorna vozila; oprema za vadenje i kopanje nafte i gasa za poljoprivredu, kopanje zemlje, gradevi narstvo; vozila; aparati za kretanje kopnom, vazduhom ili vodom; dizel motori za kopnena vozila.;

Klasa 37: Protektiranje guma; popravke pumpi; pranje vozila; poliranje; vulkanizacija guma (popravke); bušenje dubokih naftnih ili gasnih bušotina; instalacija, održavanje i popravka mašina; građenje fabrika; instalacija i popravka električnih aparata; instalacija i popravka opreme za grijanje; čišćenje vozila; nadgledanje (upravljanje) gradnje zgrada; popravka i održavanje gorionika; čišćenje i popravka bojlera; podmazivanje vozila; izvlacenje rude; instalacija, popravka i održavanje mašinerije; iznajmljivanje građevinske opreme; iznajmljivanje mašina za pranje rublja; čišćenje vozila; pranje motornih vozila; pranje vozila; poliranje vozila; održavanje vozila; održavanje i popravka vozila; izgradnja i održavanje cjevovoda; servisi za vozila (za sipanje goriva i održavanje); održavanje vozila, servisne stanice (benzinske pumpe), popravka ili održavanje opreme za benzinske pumpe, pružanje informacija u vezi sa popravkom ili održavanjem opreme za benzinske pumpe; pumpanje nafte; regulacija naftnih gorionika; izgradnja naftnih cjevovoda; postavljanje naftnih cjevovoda; pumpanje sirove nafte; vadenje nafte; eksploatisanje naftnih polja za potrebe vadenja nafte; bušenje sirove nafte; izgradnja i održavanje cjevovoda; vlažno bušenje vode i nafte; ojačavanje naftnih platformi malterom; bušenje nafte i gasa; izgradnja građevina za proizvodnju sirove nafte; izgradnja građevina za čuvanje sirove nafte; izgradnja građevina za prenos sirove nafte; instalacija omota, cjevovoda i ijcevi za bušenje nafte.;

Klasa 39: Usluge transporta; usluge pakovanja i skladištenja robe; usluge transporta nafte; usluge skladištenja nafte; usluge skladištenje ulja za sagorijevanje; usluge transporta sirove nafte; usluge distribucije nafte; usluge transporta cjevovodima; usluge informisanja u vezi sa transportom nafte.;

Klasa 40: Usluge reciklaže dubreta i otpada; usluge prerade otpada; usluge spaljivanje otpada i dubreta; usluge uništavanje otpada i dubreta; usluge dekontaminacije opasnih materija; usluge abrazije; usluge rafinerije; usluge iznajmljivanja kazana; usluge prerade nafte; usluge informisanja u vezi sa preradom materijala; usluge kazandžija; usluge uništavanja otpada i dubreta; usluge prerade nafte; usluge probijanja naftnih izvora; usluge saniranja posledica od izlivanja nafte; usluge prerade naftnih derivata; usluge prerade sirove nafte; usluge prerade nafte; usluge obrade otpadnih ulja; usluge prerade gasa i nafte; usluge savjetovanja u vezi sa postupanjem u slučaju zagađenja nafte; usluge obrada goriva.;

Klasa 42: Naučne i tehnološke usluge, kao i usluge istraživanja i projektovanja u vezi sa njima; usluge industrijskih analiza i istraživanja; projektovanje i razvoj računarskog hardvera i softvera; usluge istraživanje nafte; usluge ispitivanje naftnih izvora; usluge istraživanja naftnih polja; usluge analize potapanja nafte; usluge ispitivanja slojeva zemlje koji sadrže naftu; usluge analiza za eksploataciju naftnih polja; naftni slojevi (usluge pripremanja ispitivanja); slojevi koji sadrže naftu (usluge pripremanja ispitivanja); usluge izrade ispitivanja naftnih polja; usluge istraživanja u cilju otkrivanja nafte; usluge istraživanja i pretraživanja nafte i gasa; usluge geofizicog istraživanja za naftnu industriju; analitičke

usluge vezane za istraživanje naftnih polja; usluge analize i ispitivanja vezane za naftnu industriju; usluge analize i ispitivanja u oblasti istraživanja nafte; usluge analize i ispitivanja vezane za istraživanja nafte; usluge sprovođenja studija izvodljivosti koje su vezane za istraživanje naftnih polja; usluge sprovođenja studija izvodljivosti koje su vezane za eksploataciju naftnih polja; usluge geofizičkih istraživanja za industrije nafte, gasa i rudarsku industriju; usluge sprovođenja tumacenja snimaka magnetne rezonance i analiza za naftnu industriju.

(111) **15043**

(151) 27.11.2020.

(210) Ž-2020-66

(220) 25.02.2020.

(732) DOO HELP Podgorica, Ulica Žrtava fašizma (Georgi Dimitrova) br.1(2), Konik, Podgorica, ME

(540)



(550) I

(511) Klasa 35: Oglašavanje, reklamiranje i maloprodaja sledećih proizvoda: lekovi; medicinska sredstva; hrana za posebne prehrambene potrebe i suplementi; homeopatski proizvodi i aromaterijski proizvodi koji se koriste za održavanje i unapređivanje zdravlja, a nijesu lekovi i medicinska sredstva; dječija i bebi oprema, kao i drugi proizvodi namijenjeni za pravilan i zdrav razvoj djece; mjerni instrumenti i testovi za kućnu upotrebu i samokontrolu (baterije, crijeva, filteri, maske); medicinska i funkcionalna pomagala i pomagala koja se mogu koristiti u medicinske svrhe, anatomska obuća, pomagala za pravilan hod, pomagala za deformitete; kozmetički, higijenski i drugi proizvodi za njegu i unapređenje i zaštitu zdravlja, drugi proizvodi koji služe za unapređenje i zaštitu zdravlja i promociju zdravih stilova života.

Klasa 39: Prevoz, ambalažiranje i skladištenje proizvoda nabrojanih u klasi 35.

(111) **15044**

(151) 30.11.2020.

(210) Ž-2019-507

(220) 23.12.2019.

(732) The Cockpit USA LLC, 874 Walker Road, Suite C, 19904, Dover, Delaware, US

(540)

COCKPIT USA

(550) I

(740) Jasna Jusić, Dalmatinska 2, 81000, Podgorica

(511) Klasa 25: Odjeća, obuća, pokrivala za glavu.

(111) **15045**

(151) 30.11.2020.

(210) Ž-2019-514

(220) 25.12.2019.

(732) POSCO INTERNATIONAL Corporation, 10, Tongil-ro, Jung-gu, Seoul, KR

(540)

DAEWOO

(550) I

(740) Jasna Jusić, Dalmatinska 2, 81000, Podgorica

(511) Klasa 7: Mašine i alatne mašine; motori (osim za suvozemna vozila); kvačila i remeni (osim za suvozemna vozila); poljoprivredne mašine; inkubatori.

Klasa 9: Video rekorderi, aparati za snimanje zvuka, magnetofoni, radio aparati, gramofoni, telefonski aparati, računari, televizijski aparati, video trake.

Klasa 11: Uređaji za osvjetljavanje, grijanje, proizvodnju pare, kvanje, hlađenje, sušenje i prozračivanje, vodovodne i sanitarne instalacije.

Klasa 12: Vozila, uređaji za kretanje po kopnu, vazduhu ili vodi.

(111) **15046**

(151) 30.11.2020.

(210) Ž-2019-515

(220) 25.12.2019.

(732) POSCO INTERNATIONAL Corporation, 10, Tongil-ro, Jung-gu, Seoul, KR

(540)



(550) I

(740) Jasna Jusić, Dalmatinska 2, 81000, Podgorica

(511) Klasa 7: Mašine i alatne mašine; motori (osim za suvozemna vozila); kvačila i remeni (osim za suvozemna vozila); poljoprivredne mašine; inkubatori.

Klasa 9: Video rekorderi, aparati za snimanje zvuka, magnetofoni, radio aparati, gramofoni, telefonski aparati, računari, televizijski aparati, video trake.

Klasa 11: Uređaji za osvjetljavanje, grijanje, proizvodnju pare, kuvanje, hlađenje, sušenje i prozračivanje, vodovodne i sanitarne instalacije.

Klasa 12: Vozila, uređaji za kretanje po kopnu, vazduhu ili vodi.

(111) **15047**

(151) 30.11.2020.

(210) Ž-2019-521

(220) 31.12.2019.

(732) MULTIFIT Tiernahrungs GmbH, Westpreußenstr. 32-38, 47809, Krefeld, DE

(540)



(550) I

(740) Jasna Jusić, Dalmatinska 2, 81000, Podgorica

(511) Klasa 31: Hrana za životinje; sijeno; kosti za žvakanje; pijesak (piljevina za životinje), posebno ptičji pijesak; piljevina za životinje.

(111) **15048**

(151) 30.11.2020.

(210) Ž-2019-490

(220) 12.12.2019.

(732) VIVO MOBILE COMMUNICATION CO., LTD., 283#, BBK Road, Wusha, Chang'an, Dongguan, Guangdong, CN

(540)

The logo for the brand 'Vivo' is displayed in a bold, black, sans-serif font. The letters are lowercase and closely spaced, with a distinctive dot above the 'i'.

(550) I

(740) Miladin Popović, Đoka Miraševića 21/III, 81000, Podgorica

(511) Klasa 9: Aparati za obradu podataka; Lični digitalni asistenti [PDA]; Aparati za telekomunikacije u obliku nakita; Aplikacije za softver mobilnih telefona koje se mogu preuzimati; Tablet računari; Interaktivni terminali sa ekranima osjetljivim na dodir; Pametne naočare; Pametni satovi; Olovke za ekran osjetljiv na dodir; Nosivi računari; Aparati za prepoznavanje lica; Navigacioni instrumenti; Uređaji za globalno pozicionirajući sistem (GPS); Pametni telefoni; Mobilni telefoni; Trake za mobilne telefone; Nosivi uređaji za mjerenje aktivnosti; Futrole za mobilne telefone; Navlake za mobilne telefone; Zaštitne folije prilagođene za ekrane mobilnih telefona; Nosivi pametni telefoni; Stalci prilagođeni za mobilne telefone; Kabineti za zvučnike; Bežični zvučnici; Slušalice; Bežične slušalice; Slušalice za mobilne telefone; Bežični setovi za mobilne telefone; Selfi štapovi za upotrebu sa pametnim telefonima; Selfi sočiva; USB kablovi; USB kablovi za mobilne telefone; Ispravljači struje; Baterije, električne; Punjači baterija; Baterije koje se mogu dopunjavati; Bežični punjači; Punjači baterija za mobilne telefone; Inteligentne slušalice „bubice“, Inteligentne slušalice; Naočare koje uvećavaju stvarnost; Setovi koji uvećavaju stvarnost; Naočare za virtuelnu stvarnost; Setovi za virtuelnu stvarnost; Hardver za virtuelnu realnost; Softver za virtuelnu i uvećanu stvarnost; Pametni zvučnici; Pametni televizor; Noutbuk računari; Računari; Ekрани za mobilne telefone; Stalci za mobilne telefone za upotrebu u vozilima; Prenosive stanice za punjenje (baterije koje se mogu dopunjavati); Pametne trake; Vage za mjerenje tjelesne masti; Vage sa analizatorom tjelesne mase; Čipovi [integrisana kola]; Elektronski čipovi.

(111) **15049**

(151) 30.11.2020.

(210) Ž-2019-499

(220) 16.12.2019.

(732) VIVO MOBILE COMMUNICATION CO., LTD., 283#, BBK Road, Wusha, Chang'An, Dongguan, Guangdong, CN
(540)

iQOO

(550) I

(740) Miladin Popović, Đoka Miraševića 21/III, 81000, Podgorica

(511) Klasa 9: Aparati za obradu podataka; Računarski softver, snimljen; Računarski programi, koji se mogu preuzimati; Lični digitalni asistenti [PDA]; Računarske softverske platforme, snimljene ili koje se mogu preuzimati; Grafički elementi za mobilne telefone koji se mogu preuzimati; Aparati za telekomunikacije u obliku nakita; Aplikacije za softver mobilnih telefona koje se mogu preuzimati; Tablet računari; Interaktivni terminali sa ekranima osjetljivim na dodir; Humanoidni robot sa vještačkom inteligencijom; Pametne naočare (obrada podataka); Naočare koje uvećavaju stvarnost; Naočare za virtuelnu stvarnost; Pametni satovi (obrada podataka); Softver za igru virtuelne stvarnosti; USB čitači kartica; Olovke za ekran osjetljiv na dodir; Nosivi računari; Aparati za prepoznavanje pokreta; Skeneri za otiske prstiju; Uređaji za prepoznavanje lica; Navigacioni instrumenti; Uređaji za globalno pozicionirajući sistem (GPS); Pametni telefoni; Mobilni telefoni; Trake za mobilne telefone; Nosivi uređaji za mjerenje aktivnosti; Futrole za mobilne telefone; Navlake za mobilne telefone; Zaštitne folije prilagođene za ekrane mobilnih telefona; Nosivi pametni telefoni; Uređaji za mobilne telefone za rukovanje bez ruku; Stalci prilagođeni za mobilne telefone; Kabineti za zvučnike; Bežični zvučnici; Inteligentni zvučnici; Zvučnici zasnovani na vještačkoj inteligenciji; Slušalice; Bežične slušalice; Setovi za virtuelnu stvarnost; Slušalice prilagođene za mobilne telefone; Bežični setovi za pametne telefone; Prijemnici za televizor; Selfi štapovi [ručni monopodi]; Selfi štapovi za mobilne telefone; Selfi sočiva; Narukvice za povezivanje (aparati za mjerenje); USB kablovi; USB kablovi za mobilne telefone; Konverzivni priključci; Ispravljači struje; Ekran za mobilne telefone; Nosivi monitori za prikazivanje videa; Baterije, električne; Punjači baterija; Prenosive stanice za punjenje (baterije koje se mogu dopunjavati); Bežični punjači; Stalci za mobilne telefone za upotrebu u vozilima; USB priključci; Emotikoni za mobilne telefone koji se mogu preuzimati; Softver za računarske igrice, koji se mogu preuzimati.

(111) **15050**

(151) 30.11.2020.

(210) Ž-2020-26

(220) 29.01.2020.

(732) IP HOLDINGS UNLTD LLC, 103 Foulk Road, 19803, Wilmington, Delaware, US

(540)

ECKO UNLTD.

(550) I

(740) Jasna Jusić, Dalmatinska 2, 81000, Podgorica

(511) Klasa 25: Odjeća i pokrivala za glavu.

(111) **15051**

(151) 30.11.2020.

(210) Ž-2020-27

(220) 29.01.2020.

(732) IP HOLDINGS UNLTD LLC, 103 Foulk Road, 19803, Wilmington, Delaware, US

(540)

ECKO RED

(550) I

(740) Jasna Jusić, Dalmatinska 2, 81000, Podgorica

(511) Klasa 25: Odjeća i pokrivala za glavu.

(111) **15052**

(151) 30.11.2020.

(210) Ž-2020-28

(220) 29.01.2020.

(732) IP HOLDINGS UNLTD LLC, 103 Foulk Road, 19803, Wilmington, Delaware, US

(540)



(550) I

(740) Jasna Jusić, Dalmatinska 2, 81000, Podgorica

(511) Klasa 25: Odjeća, obuća i pokrivala za glavu.

Klasa 35: Usluge maloprodaje i onlajn maloprodajne usluge u vezi sa odjećom i pratećim dodacima.

(111) **15053**

(151) 30.11.2020.

(210) Ž-2020-49

(220) 12.02.2020.

(732) Cargill, Incorporated, 15407 McGinty Road West, 55391, Wayzata, Minnesota, US

(540)



(550) I

(740) Miladin Popović, Đoka Miraševića 21/III, 81000, Podgorica

(511) Klasa 30: Kakao i čokolada.

(111) **15054**

(151) 30.11.2020.

(210) Ž-2020-78

(220) 04.03.2020.

(732) Mylan Pharmaceuticals, Inc., 781 Chestnut Ridge Road , 26505, Morgantown, West Virginia, US

(540)

SEMGLEE

(550) I

(740) Jasna Jusić, Dalmatinska 2, 81000, Podgorica

(511) Klasa 5: Farmaceutski preparati za liječenje dijabetesa.

(111) **15055**

(151) 30.11.2020.

(210) Ž-2020-9

(220) 15.01.2020.

(732) TripAdvisor LLC, 400 1st Avenue, 02494, Needham, Massachusetts, US

(540)



(550) I

(740) Jasna Jusić, Dalmatinska 2, 81000, Podgorica

(511) Klasa 9: Softver za preuzimanje u obliku mobilne aplikacije koja se koristi za pristup vodičima i recenzijama pružalaca usluga putovanja, turističkih odredišta, izleta i lokalnih atrakcija; softver za preuzimanje u vidu mobilne aplikacije koji se koristi za pristup pretraživačkoj bazi podataka u oblastima transporta, putovanja i planiranja putovanja; softver za preuzimanje za postavljanje (upload), manipulisanje, skladištenje i dijeljenje fotografija, grafike, videa i drugih multimedijalnih sadržaja putem interneta; softverska aplikacija za preuzimanje za pristup veb stranici na kojoj korisnici mogu da objavljuju ocjene, recenzije i preporuke na popisima nekretnina za odmor, privremenom smještaju, događajima, lokacijama, preduzećima, uslugama i aktivnostima u oblastima zabave, putovanja, turizma i restorana; softverska aplikacija za preuzimanje za rezervisanje i bukiranje prevoza, putovanja i restorana.

Klasa 35: Usluge upoređivanja cijena u oblasti putovanja i smještaja za upotrebu od strane potrošača u određivanju troškova prevoza i smještaja, dostupnih elektronskim putem preko računarskih mreža i globalnih informacionih mreža; pružanje korisničkih informacija drugima o prevozu, putovanju i smještaju, dostupnih elektronskim putem preko računarskih mreža i globalnih informacionih mreža; usluge oglašavanja, naime, promocija i marketing roba i usluga drugih putem elektronskih komunikacionih mreža; obezbjeđivanje veb stranice koja sadrži recenzije, ocjene i preporuke korisnika o hotelima i ostalim privremenim smještajnim objektima u komercijalne svrhe.

Klasa 38: Pružanje onlajn elektronskih oglasnih tabli i foruma za prenos poruka i fotografija među korisnicima računara u oblasti putovanja; obezbjeđivanje pristupa interaktivnim bazama podataka za prenos poruka između korisnika računara i pretplatnika koji se tiču putovanja, slobodnih aktivnosti, hrane i pića i restorana; obezbjeđivanje onlajn soba za časkanje, usluga slanja instant poruka i usluge elektronskih oglasnih tabli; obezbjeđivanje pristupa računarskim bazama podataka u oblastima društvenog umrežavanja i upoznavanja; obezbjeđivanje onlajn foruma korisnicima za dijeljenje i striming informacija, audio, video, zabavnog sadržaja ili informacija, u cilju formiranja virtuelnih zajednica i uključivanja u društvene mreže.

Klasa 39: Usluge informisanja o putovanju, obezbjeđivanje onlajn računarske baze podataka u oblasti pružanja informacija o putovanju; obezbjeđivanje pristupa ocjenama pružalaca usluga putovanja, odredišta putovanja i turističkih tura putem računarskih mreža i globalnih informacionih mreža; obezbjeđivanje onlajn pretraživačke baze podataka sa informacijama o prevozu, putovanju i planiranju ruta; pružanje konsultatnskih usluga u vezi sa putovanjem; pružanje elektronskih informacija u vezi sa putovanjima; usluge putničkih agencija, naime, usluge rezervisanja i bukiranja prevoza i usluge rezervisanja putovanja; pružanje informacija, vijesti i ocjena pružalaca putničkih usluga.

Klasa 42: Računarske usluge, naime, obezbjeđivanje pretraživača za dobijanje podataka o

putovanju i informacijama putem računarskih mreža i globalnih informacionih mreža; obezbjeđivanje pristupa internet pretraživačima; obezbjeđivanje onlajn računarskog softvera koji se ne može preuzeti za postavljanje (upload), manipulisanje, čuvanje i dijeljenje fotografija, grafike, videa i drugih multimedijalnih sadržaja putem interneta; računarske usluge, naime, stvaranje onlajn zajednice za registrovane korisnike koji će učestvovati u diskusijama, dobijati povratne informacije od drugih korisnika i formirati virtualne zajednice; obezbjeđivanje onlajn računarskog softvera koji se ne može preuzeti za rezervisanje i bukiranje transporta, putovanja i restorana; usluge softvera kao usluge (SaaS) koje sadrže računarski softver za pristup, pregled i pretraživanje onlajn baza podataka; usluge platforme kao usluge (PaaS) koje sadrže računarski softver za pristup, pregled i pretraživanje onlajn baza podataka; usluge softvera kao usluge (SaaS) koji sadrže računarski softver za pristup, nadzor, praćenje, pretraživanje, čuvanje i razmjenu informacija o temama od opšteg interesa, putovanjima, slobodnim aktivnostima, hrani i piću i restoranima; usluge platforme kao usluge (PaaS) koje sadrže računarski softver za pristup, nadzor, praćenje, pretraživanje, čuvanje i razmjenu informacija o putovanjima, slobodnim aktivnostima, hrani i piću i restoranima; usluge softvera kao usluge (SaaS) koje sadrže računarski softver za upotrebu kao aplikacioni programski interfejs (API); usluge platforme kao usluge (PaaS) koje sadrže računarski softver za upotrebu kao aplikacioni programski interfejs (API).

Klasa 43: Pružanje informativnih usluga o smještaju i restoranima; obezbjeđivanje pristupa recenzijama hotelskog smještaja i restorana putem računarskih mreža i globalnih informacionih mreža; obezbjeđivanje pristupa onlajn recenzijama o lokalnim atrakcijama putem Interneta, naime, obezbjeđivanje onlajn recenzija o restoranima, hotelima i odmaralištima koji pružaju usluge obroka i smještaja putem računarskih mreža i globalnih informacionih mreža; usluge putničkih agencija, naime, pomoć pri rezervisanju i bukiranju smještaja preko računarskih mreža, globalnih računarskih komunikacionih mreža i mobilnih mreža; usluge rezervacije restorana; pružanje onlajn rezervisanja, bukiranja i pretraživanja prenoćišta, privremenog smještaja i iznajmljivanje privremenog smještaja za odmor.

(111) **15056**

(151) 16.12.2020.

(210) Ž-2018-387

(220) 18.10.2018.

(732) P.T. Sumatra Tobacco Trading Company, Jalan Pattimura No. 3, Pematang Siantar, Sumatera Utara, ID

(540)



(550) I

(511) Klasa 34: Pepeljare (nemetalne), cigare, cigarete, filteri za cigarete, papir za cigarete, upaljači za pušače, šibice, artikli za pušače, duvan.

(111) **15057**

(151) 16.12.2020.

(210) Ž-2018-503

(220) 18.12.2018.

(732) Jim Beam Brands Co., 222 W. Merchandise Mart Plaza, Suite 1600, 60654, Chicago, Illinois, US

(540)

RED STAG

(550) I

(740) AOD MSA IP - Milojević Sekulić Advokati, Karađorđeva 65, 11000, Beograd

(511) Klasa 33: Alkoholna pića, naime, viski sa aromama.

(111) **15061**

(151) 17.12.2020.

(210) Ž-2018-77

(220) 13.03.2018.

(732) DRUŠTVO SA OGRANICENOM ODGOVORNOŠĆU " HUMAN RESOURCE PARTNERS" D.O.O. BUDVA, BUDVA, ME

(540)



(550) I

(511) Klasa 35: Oglašavanje i reklamiranje; vođenje komercijalnih poslova; komercijalna administracija; kancelarijski poslovi.

Klasa 41: Obuka; stručno osposobljavanje; razonoda; sportske i kulturne djelatnosti.

Klasa 45: Pravne usluge; sigurnosne usluge za zaštitu imovine i lica; lične i društvene usluge koje pružaju drugi, namjenjene za zadovoljenje ljudskih potreba.

(111) **15078**

(151) 23.12.2020.

(210) Ž-2019-13

(220) 21.01.2019.

(732) Pharmacia & Upjohn Company LLC, 7000 Portage Road, MI 49001, Kalamazoo, Michigan, US

(540)



(550) I

(740) Jasna Jusić, Dalmatinska 2, 81000, Podgorica

(511) Klasa 5: Farmaceutski proizvodi, medicinski i veterinarski preparati; sanitarni preparati za medicinske svrhe; dijetetska hrana i supstance za medicinsku ili veterinarsku upotrebu, hrana za bebe; dijetetski suplementi za ljude i životinje; flasteri, materijali za zavijanje; materijali za plombiranje zuba, zubarska smola; dezinfekciona sredstva; preparati za uništavanje štetočina; fungicidi, herbicidi.

Klasa 10: Hirurški, medicinski, zubarski i veterinarski aparati i instrumenti; vještački udovi, oči i zubi; ortopedski artikli; hirurški materijali za zašivanje; terapijska i pomoćna sredstva prilagođena osobama sa invaliditetom; aparati za masažu; aparati, uređaji i artikli za dojenčad; aparati, uređaji i artikli za seksualne aktivnosti; medicinski uređaji za oftalmološku upotrebu.

Klasa 44: Medicinske usluge; veterinarske usluge; higijenska zaštita i njega ljepote za ljude ili životinje; agrikulturne, hortikulturne i šumarkse usluge.

(111) **15085**

(151) 25.12.2020.

(210) Ž-2020-82

(220) 06.03.2020.

(732) Lidl Stiftung & Co. KG , Stiftsbergstrasse 1, 74172, Neckarsulm, DE

(540)

ANESSIA

(550) I

(740) AOD "Lutovac & partneri", Bulevar Ivana Crnojevića 93, 81000, Podgorica

(511) Klasa 33: Alkoholna pića (osim piva), naročito žestoka pića.

(111) **15086**

(151) 25.12.2020.

(210) Ž-2020-83

(220) 06.03.2020.

(732) Lidl Stiftung & Co. KG , Stiftsbergstrasse 1, 74172, Neckarsulm, DE

(540)

SWIFT

(550) I

(740) AOD "Lutovac & partneri", Bulevar Ivana Crnojevića 93, 81000, Podgorica

(511) Klasa 34: Duvanski proizvodi, pepeljare (ne od plemenitih metala, njihove legure ili premazane njime), papir za cigarete, usnici za cigarete sa filterima i bez njih, filteri za cigarete, upaljači, uređaji za uvijanje i punjenje cigareta, šibice, gore navedena roba uključena u ovu klasu.

(111) **15087**

(151) 25.12.2020.

(210) Ž-2020-84

(220) 06.03.2020.

(732) Lidl Stiftung & Co. KG , Stiftsbergstrasse 1, 74172, Neckarsulm, DE

(540)

HAMPSTEAD

(550) I

(740) AOD "Lutovac & partneri", Bulevar Ivana Crnojevića 93, 81000, Podgorica

(511) Klasa 33: Alkoholna pića (osim piva), naročito džin.

(111) **15088**

(151) 25.12.2020.

(210) Ž-2020-85

(220) 06.03.2020.

(732) Lidl Stiftung & Co. KG , Stiftsbergstrasse 1, 74172, Neckarsulm, DE

(540)



(550) I

(740) AOD "Lutovac & partneri", Bulevar Ivana Crnojevića 93, 81000, Podgorica

(511) Klasa 33: Alkoholna pića (osim piva).

(111) **15090**

(151) 25.12.2020.

(210) Ž-2020-21

(220) 24.01.2020.

(732) SHAMDATH RAGOEBIER, Dr. Sophi Redmondstraat 176 B, Paramaribo, South America, SR
(540)

RUMBA

(550) I

(740) Ana Zeković, Bulevar Svetog Petra Cetinjskog 130/VII, 81000, Podgorica

(511) Klasa 34: Duvan; Cigarete; Predmeti za pušače; Šibice.



INDUSTRIJSKI DIZAJN

INDUSTRIAL DESIGN

**MEĐUNARODNI KODOVI ZA IDENTIFIKACIJU BIBLIOGRAFSKIH
PODATAKA O DIZAJNU PREMA WIPO CT.80
RECOMMENDATION CONCERNING BIBLIOGRAPHIC DATA RELATING TO
INDUSTRIAL DESIGNS WIPO CT.80**

CRNOGORSKI	MDK	ENGLESKI
Registarski broj	11	Number of registration
Datum registracije	15	Date of the registration
Očekivani datum isteka registracije	18	Expected expiration date of the registration
Broj prijave	21	Number of the application
Datum podnošenja prijave	22	Date of filing of the application
Podaci o izložbenom pravu prvenstva	23	Exhibition priority data
Broj prijavljenih dizajna	28	Number of industrial designs included in the application
Podaci o pravu prvenstva na osnovu Pariske konvencije	30	Data relating to priority under the Paris Convention
Klasa i podklasa Lokarnske klasifikacije	51	Class and subclass of the Locarno Classification
Naziv dizajna	54	Title of the industrial design
Prikaz	55	Reproduction of the industrial design (e.g., drawing, photograph) and explanations relating to the reproduction
Ime autora dizajna	72	Name of the creator
Ime i adresa nosioca prava	73	Name and address of the owner
Ime i adresa punomoćnika	74	Name and address of the representative

OBJAVA DIZAJNA
PUBLICATION OF INDUSTRIAL DESIGN

INFORMACIJ A	KOD	PODATAK
Registarski broj	11	00147
Datum registracije	15	13.10.2020.
Očekivani datum isteka registracije/obnove	18	21.08.2023.
Broj prijave	21	D-2018-5
Broj prijavljenih dizajna	28	5
Datum podnošenja prijave	22	21.08.2018.
Podaci o pravu prvenstva na osnovu Pariske konvencije	30	pravo prvenstva od 22.02.2018. godine po osnovu prijave industrijskog dizajna broj DM/101 371.
Klasa i podklasa Lokarnske klasifikacije	51	03-01
Naziv dizajna	54	GABRIELLE TORBE SA ŠEVRONOM.

Prikaz

55

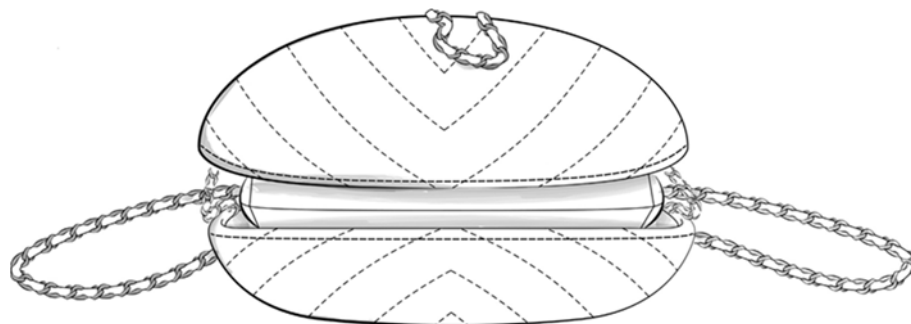

1.1

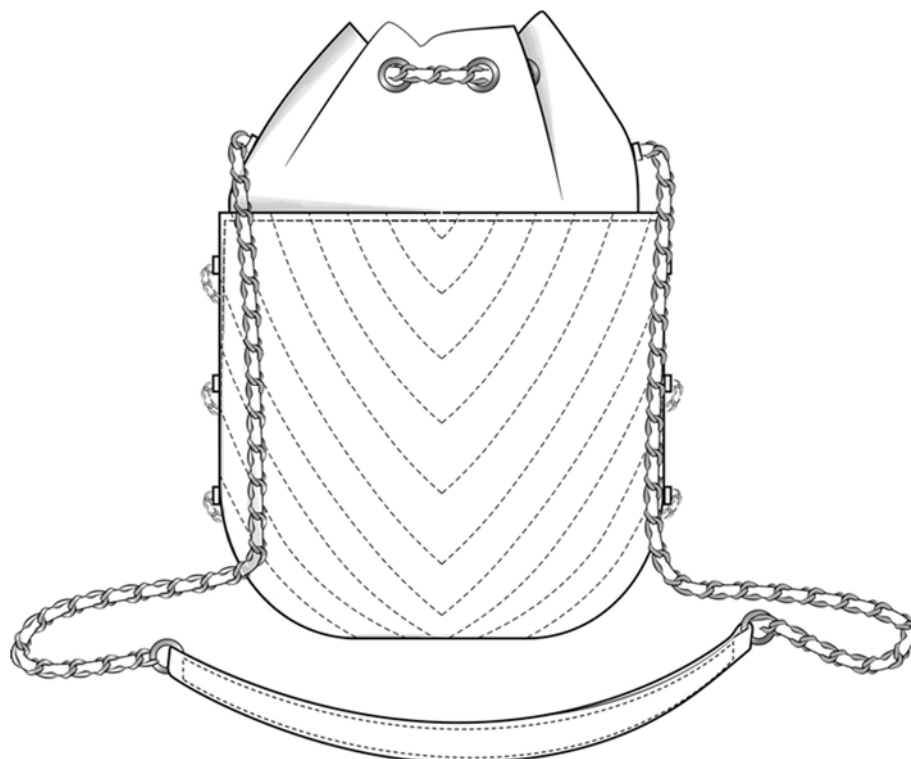

1.2

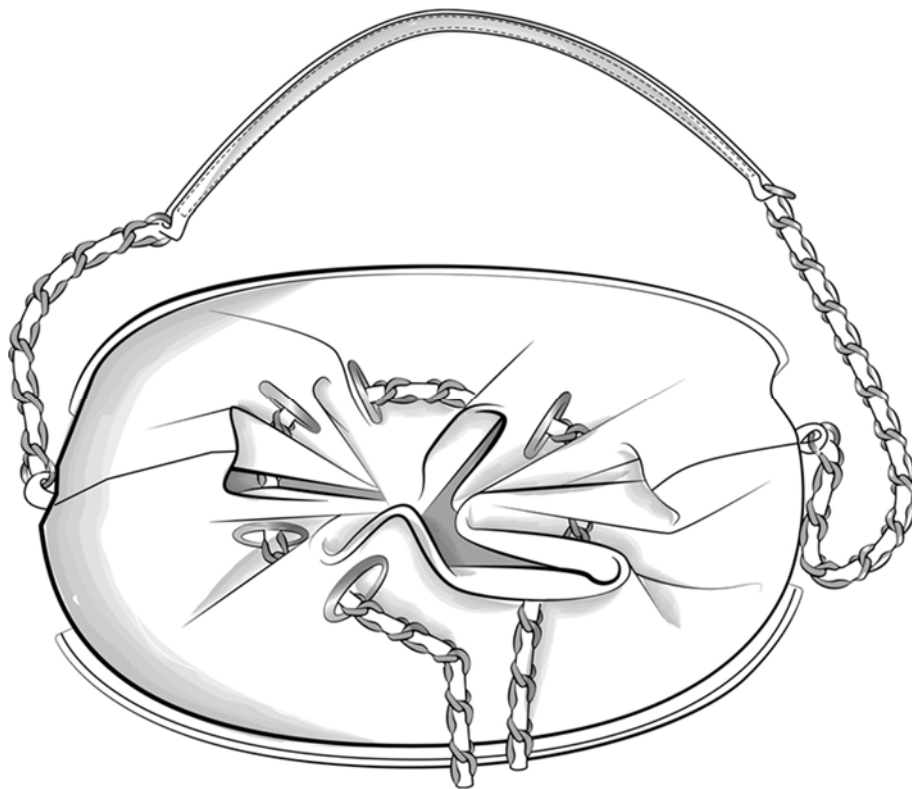

1.3

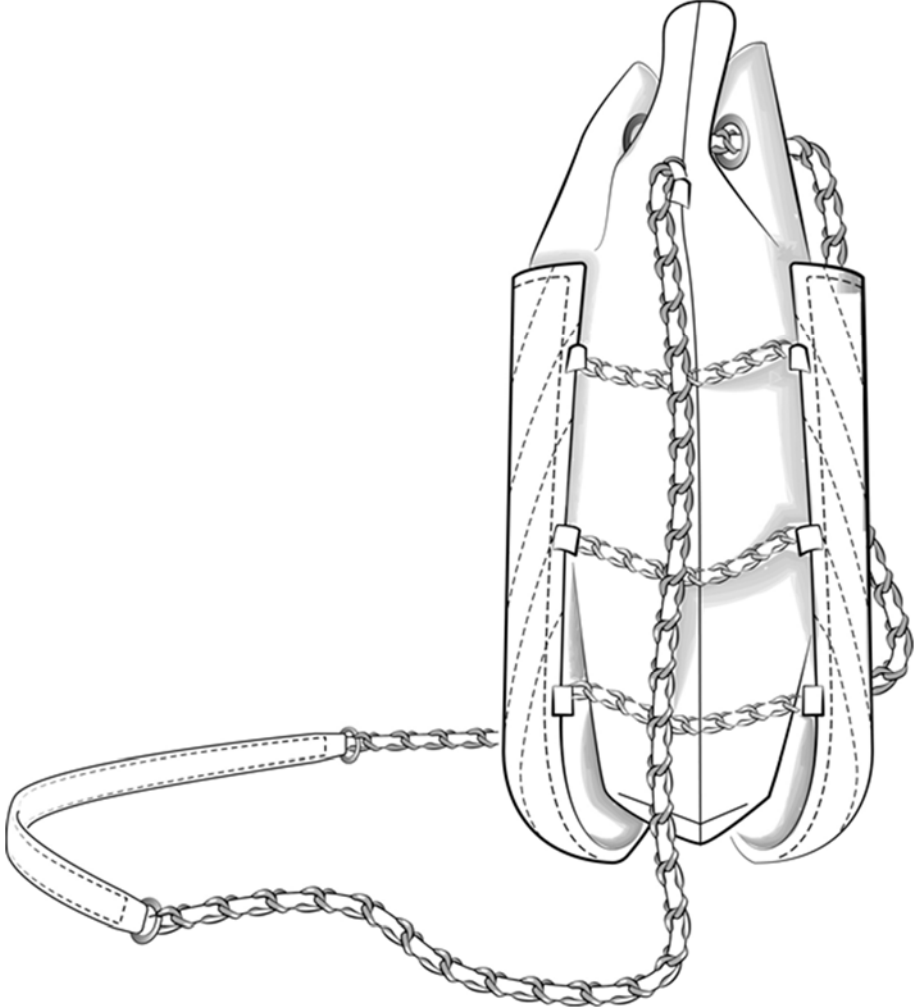

1.4



1.5

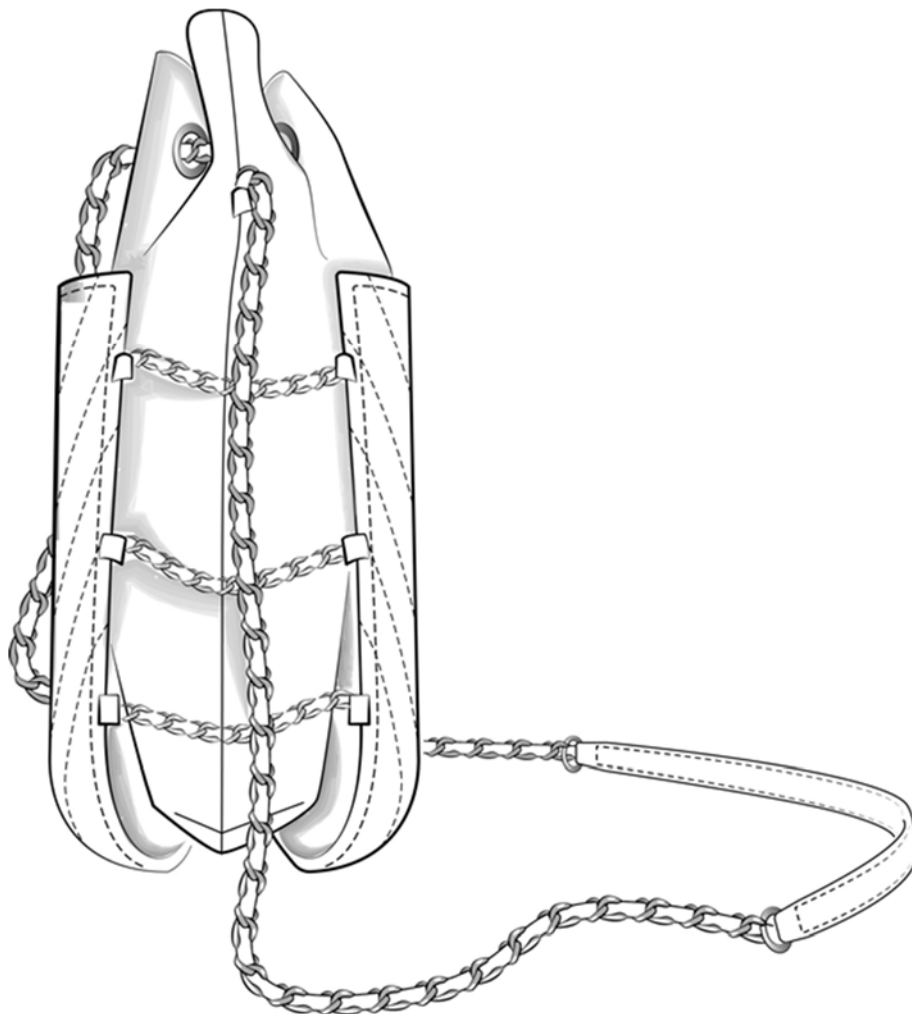

1.6

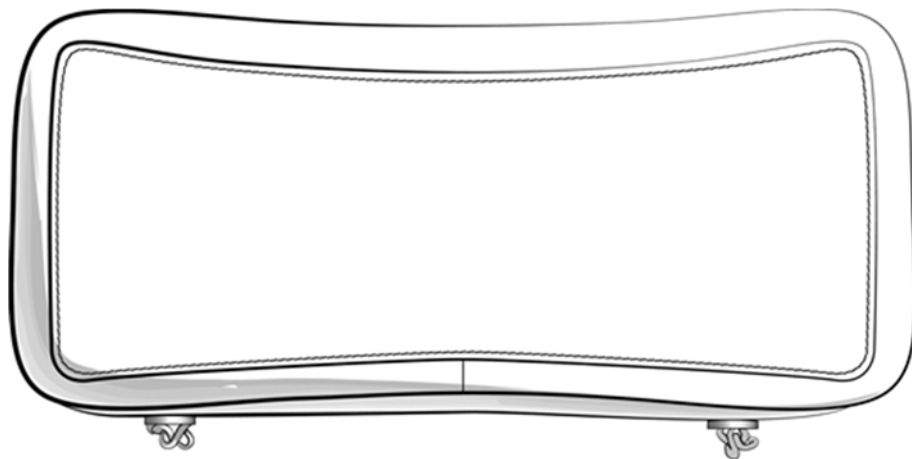

2.1

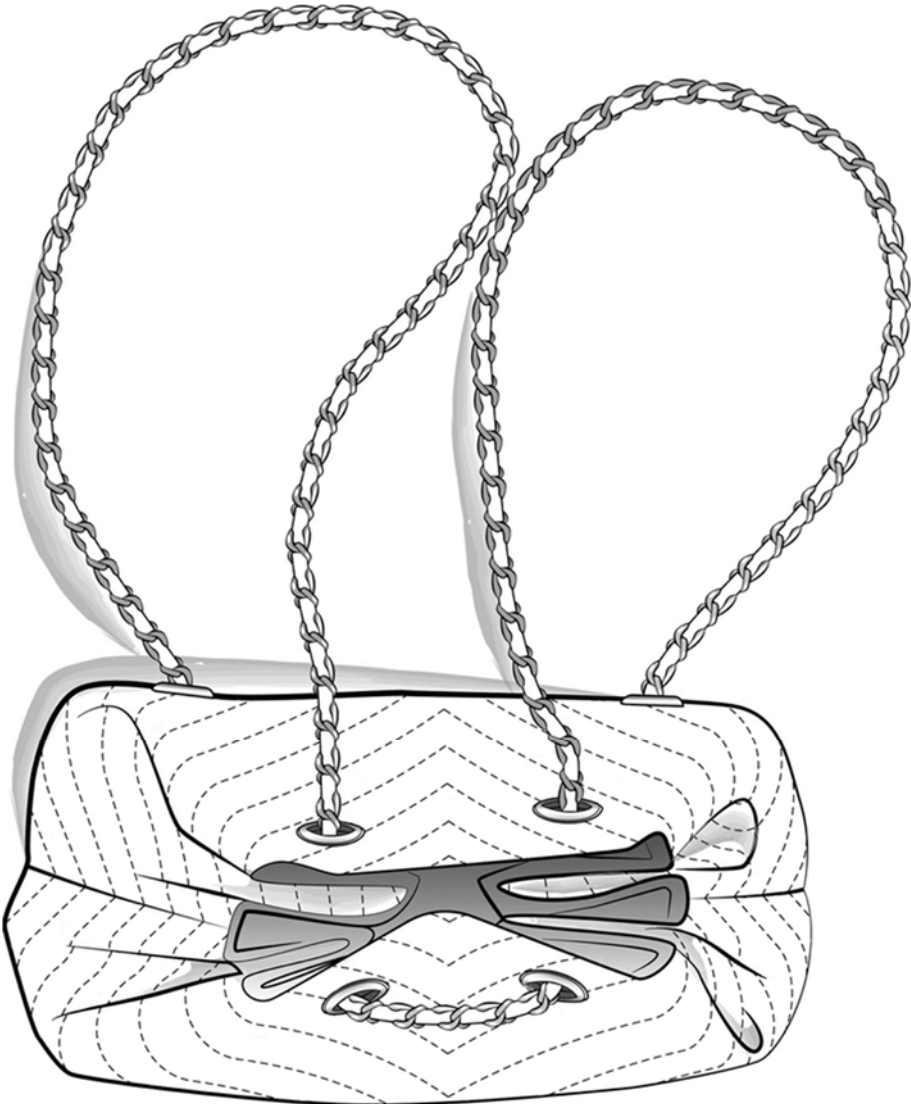

2.2

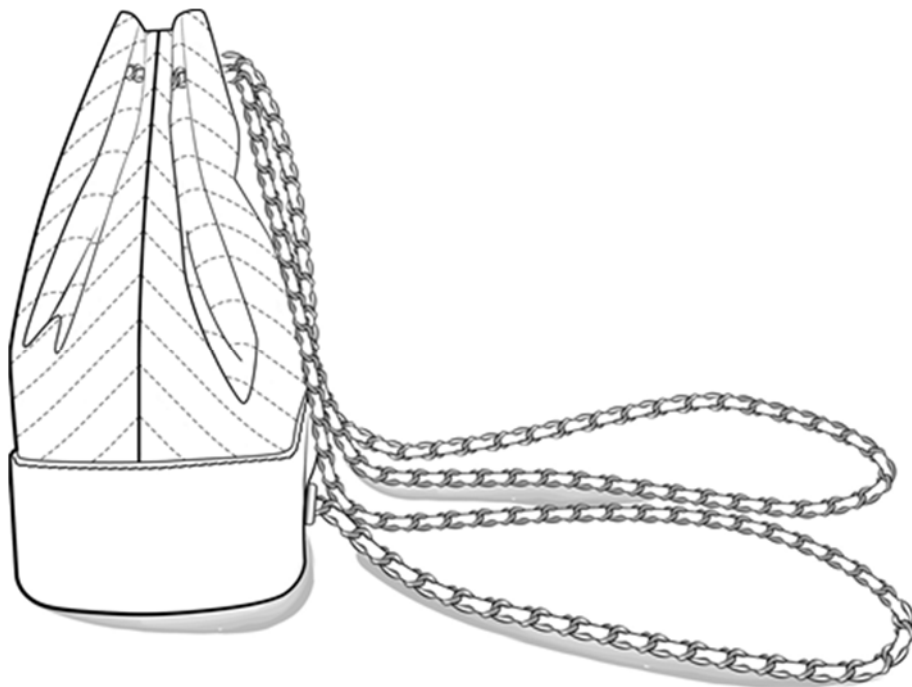

2.3



2.4

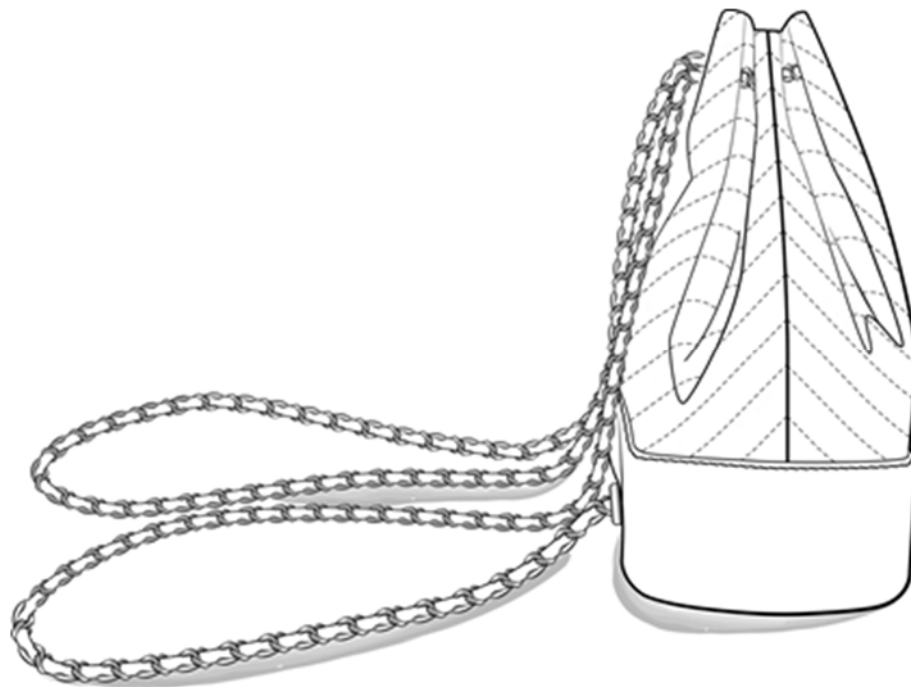

2.5

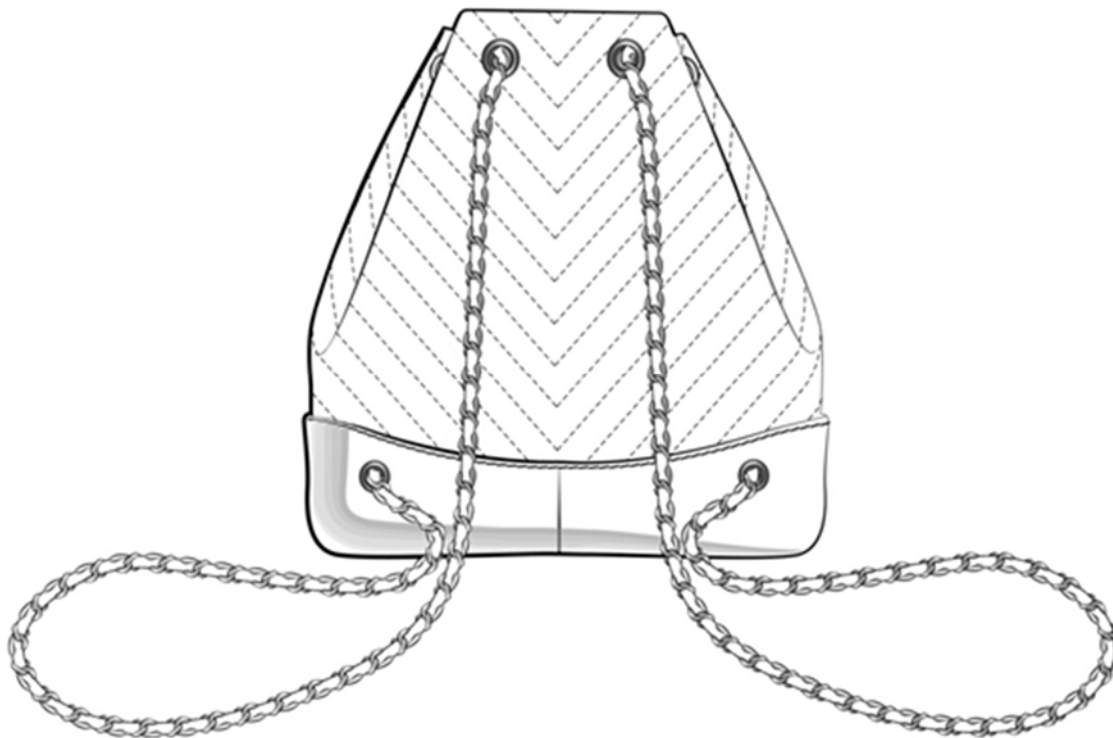

2.6

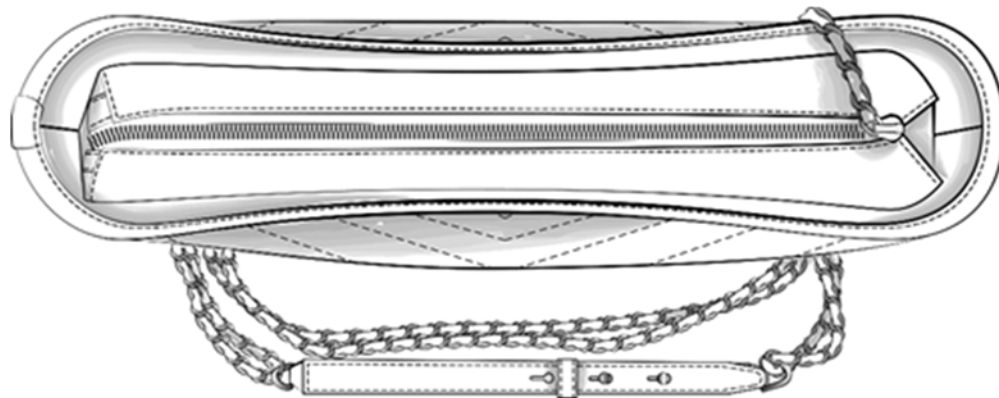

3.1

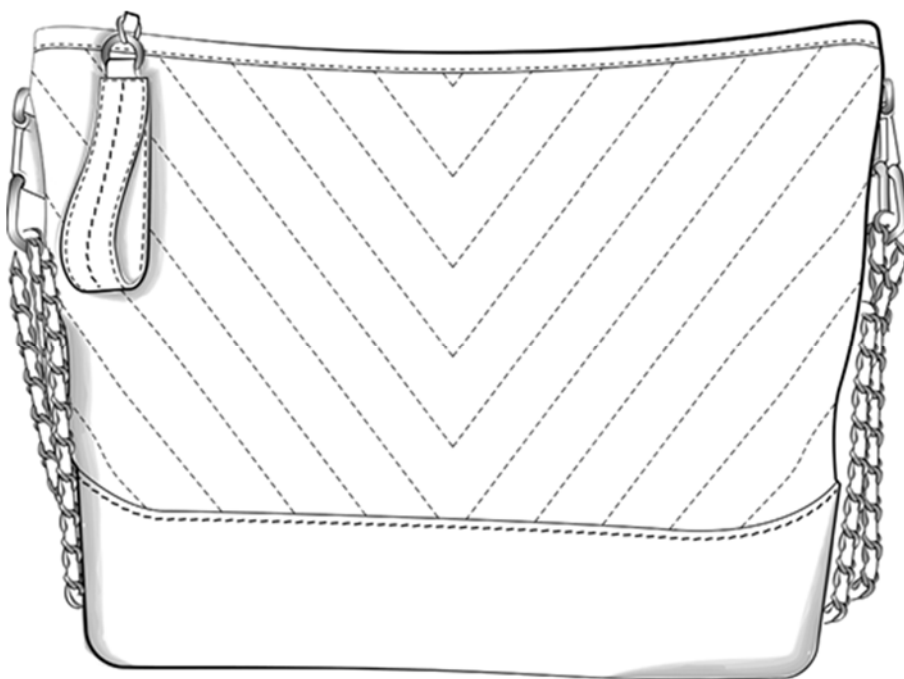

3.2

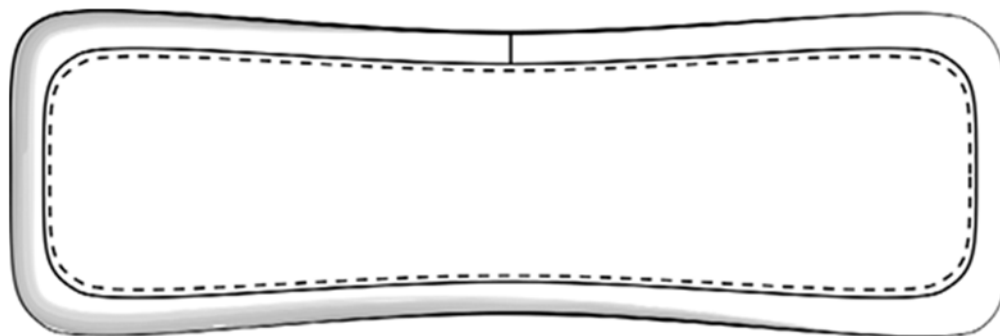

3.3

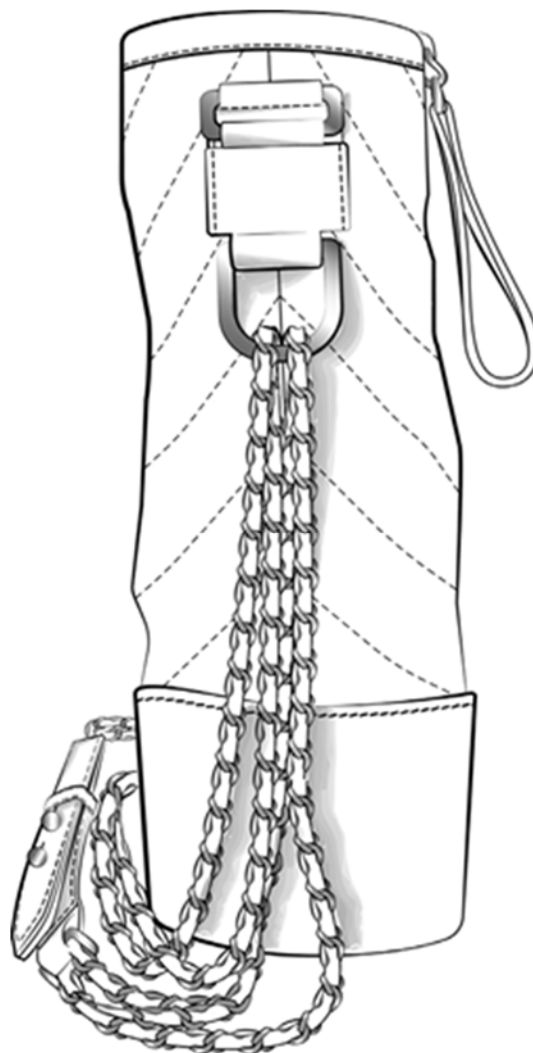

3.4

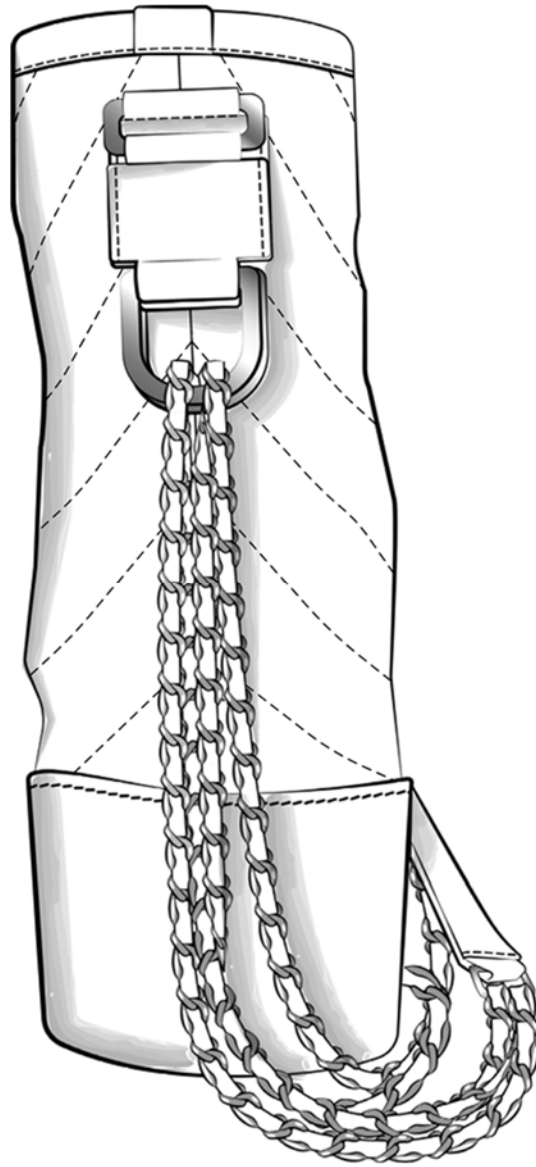

3.5

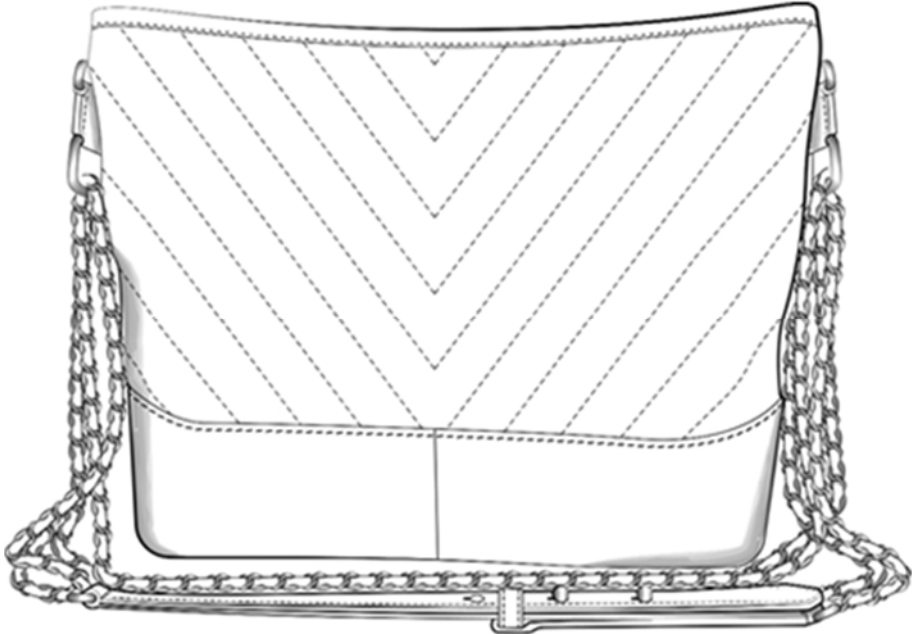

3.6



4.1



4.2

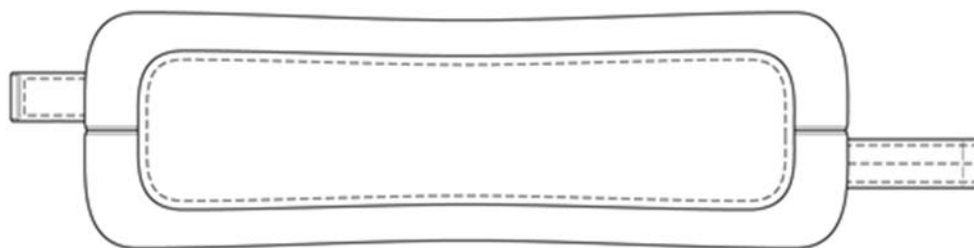

4.3

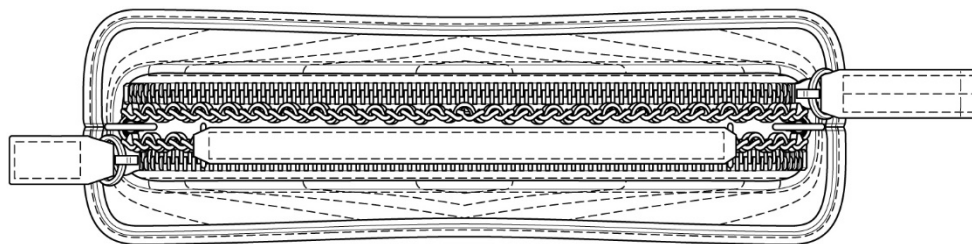

4.4



4.5

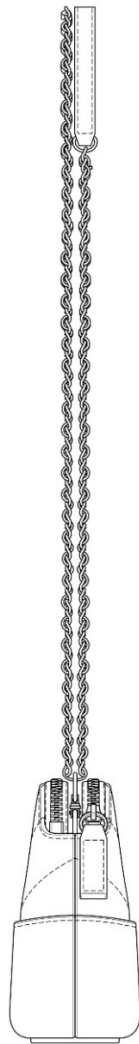

4.6

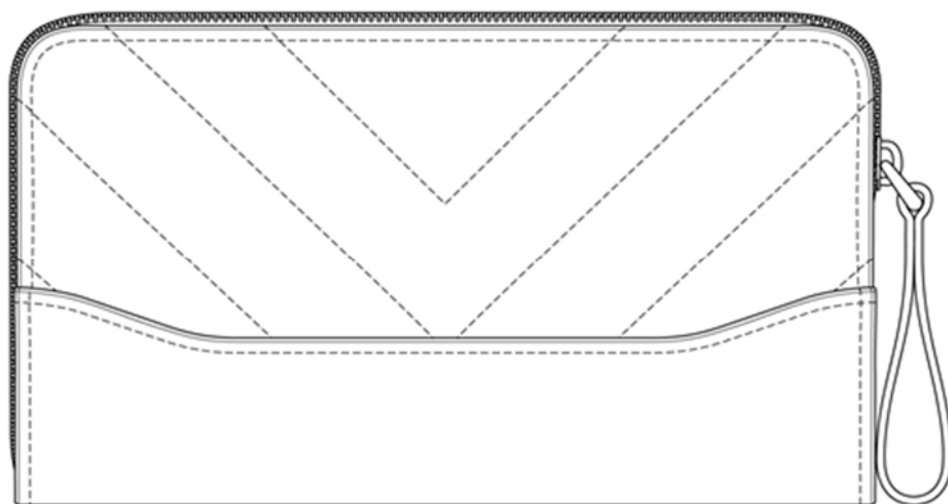

5.1

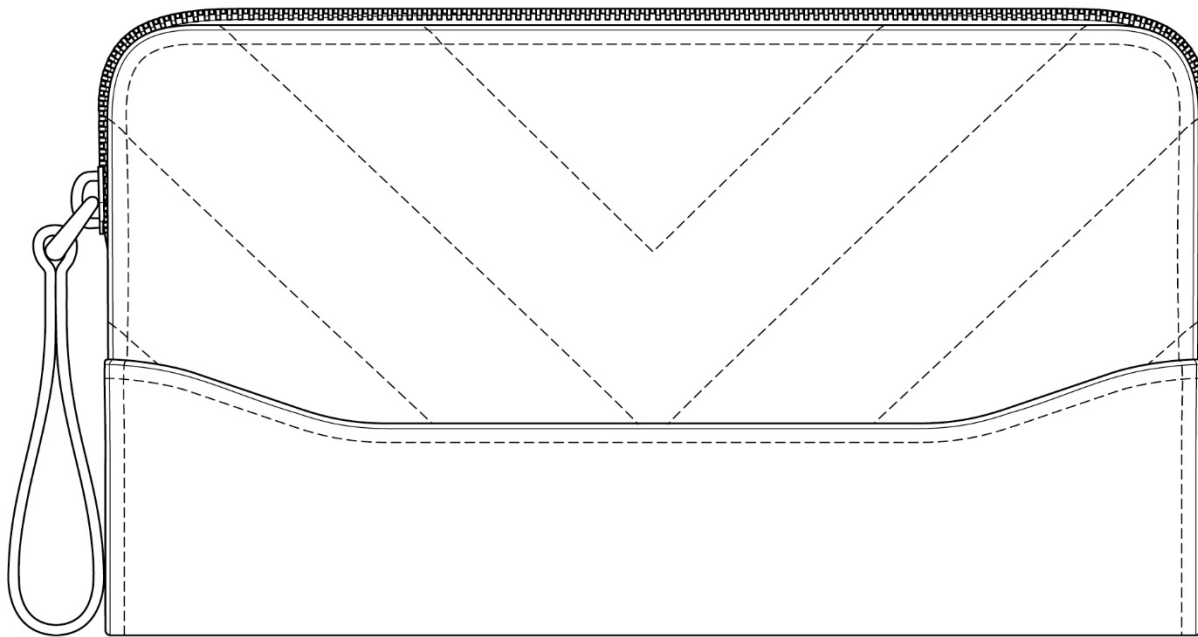

5.2

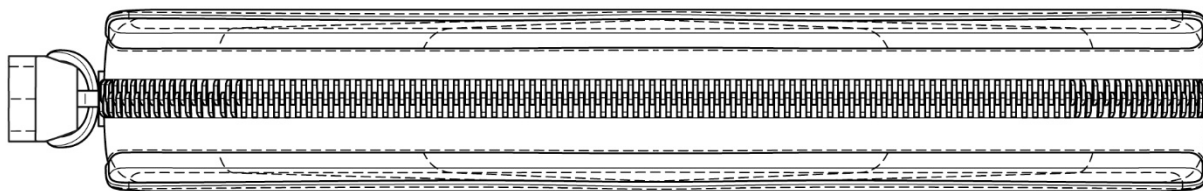

5.3

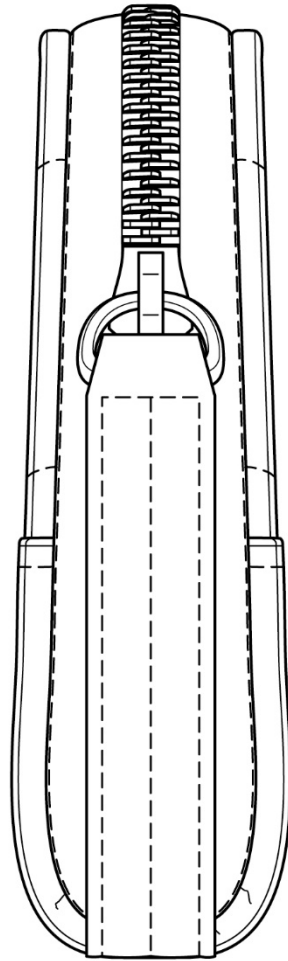

5.4

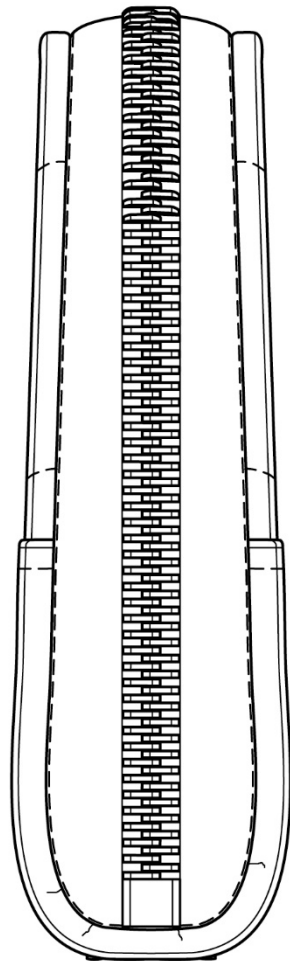

5.5

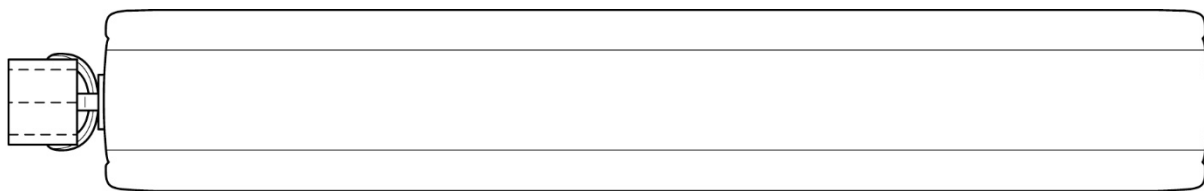

5.6

Ime autora dizajna	72	Marianna NITSCH, CHANEL, 135, avenue Charles de Gaulle F-92200 NEUILLY-SUR-SEINE, Francuska.
Ime i adresa nosioca prava	73	CHANEL, 135, avenue Charles de Gaulle F-92200 NEUILLY-SUR-SEINE, Francuska,
Ime i adresa punomocnika	74	Miladin Popović, Đoka Miraševića 21/III, Podgorica

INFORMACIJA	KOD	PODATAK
Registarski broj	11	00148
Datum registracije	15	13.10.2020.
Očekivani datum isteka registracije/obnove	18	26.09.2023.
Broj prijave	21	D-2018-6
Broj prijavljenih dizajna	28	16
Datum podnošenja prijave	22	26.09.2018.
Podaci o pravu prvenstva na osnovu Pariske konvencije	30	pravo prvenstva od 29.03.2018. godine po osnovu prijave industrijskog dizajna broj 005138096 (Evropska unija).
Klasa i podklasa Lokarnske klasifikacije	51	23-02
Naziv dizajna	54	DRŽAČI ZA DEZODORANS (ZA SANITARNU OPREMU)



1.1



1.2



1.3

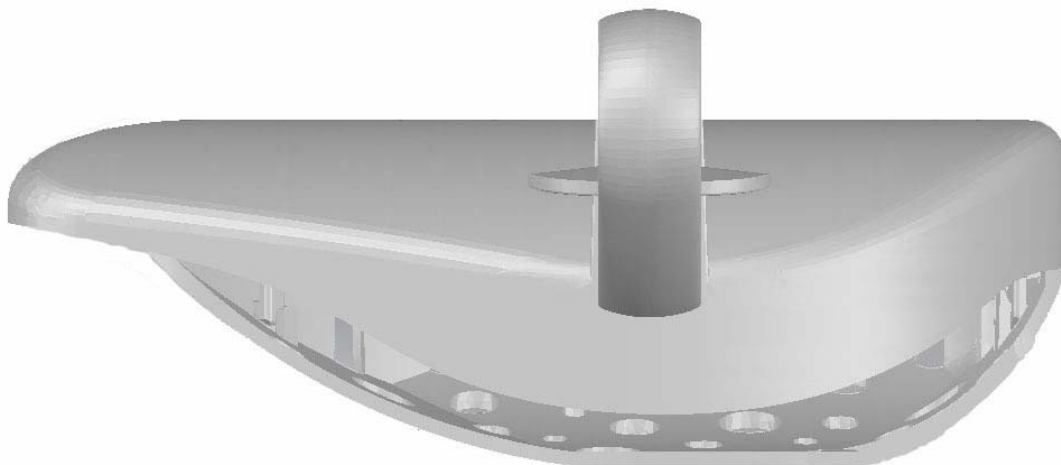

1.4



1.5



1.6



2.1



2.2

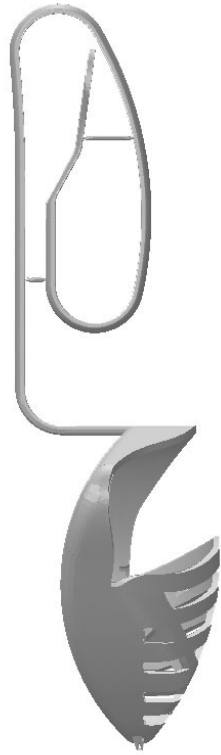

2.3

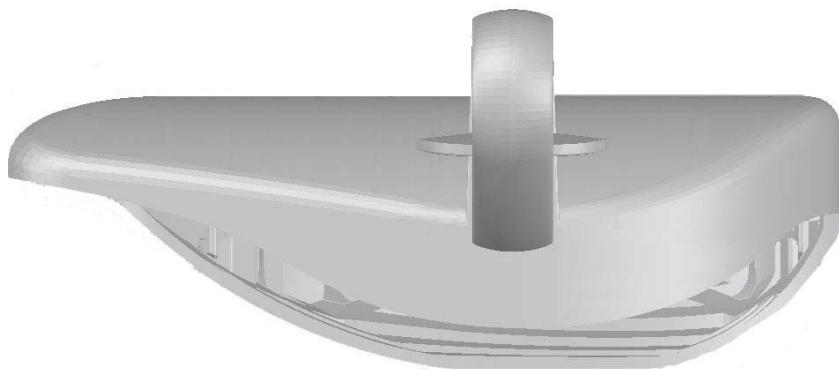

2.4

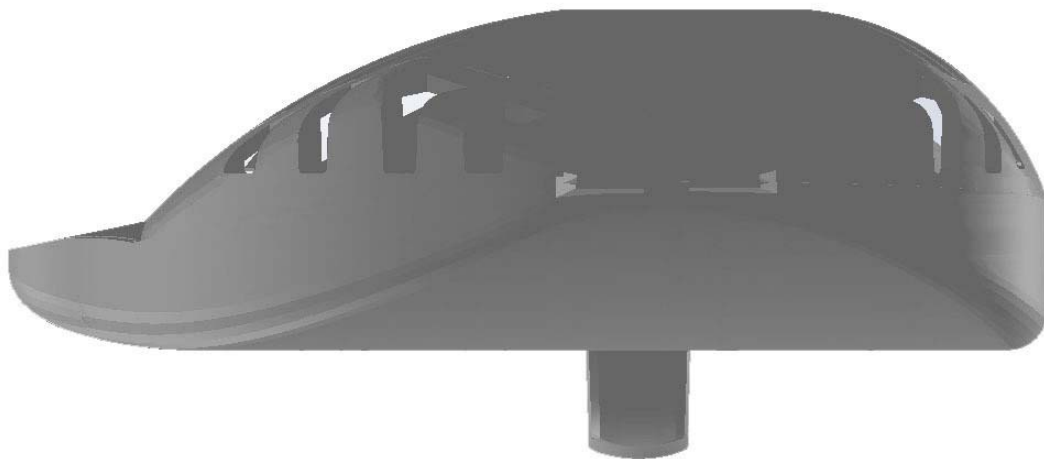

2.5



2.6



3.1

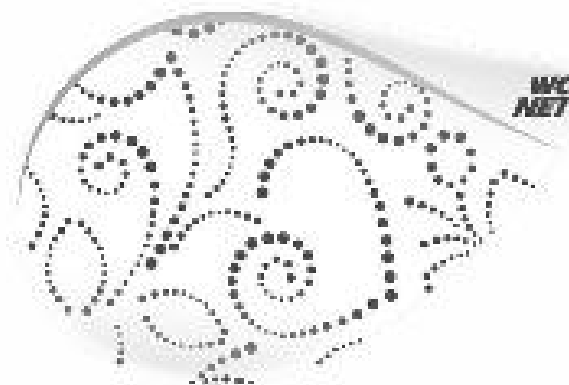

4.1



5.1



6.1

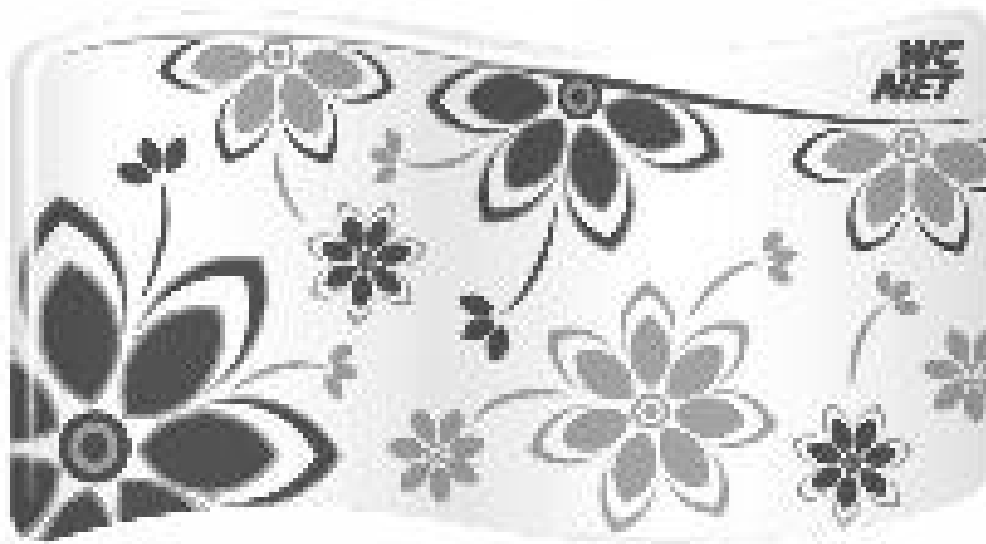

7.1



8.1



9.1

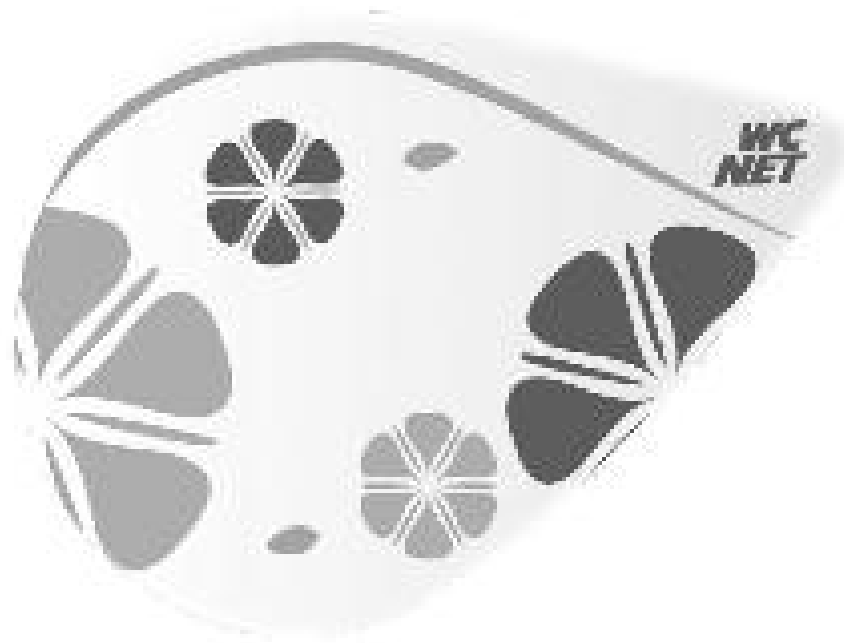

10.1

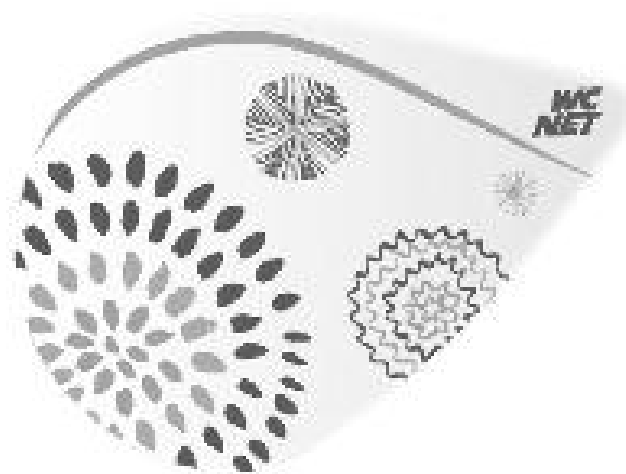

11.1



12.1



13.1

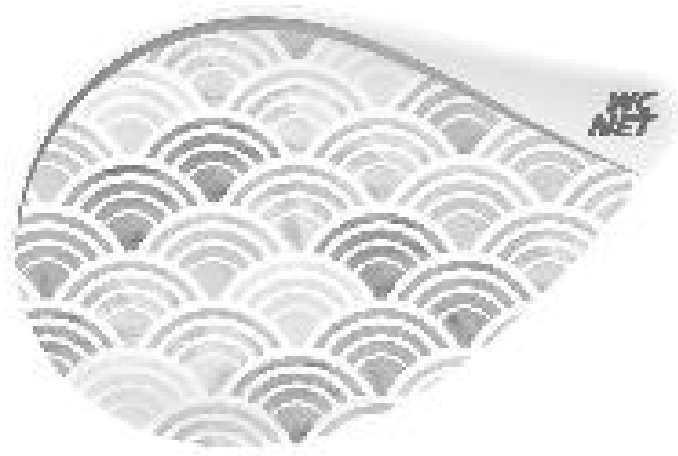

14.1

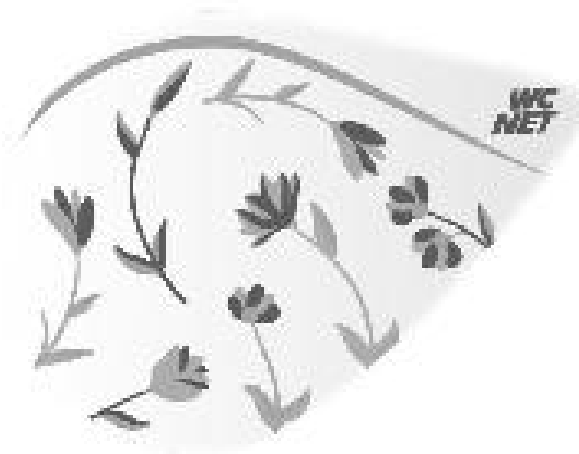

15.1

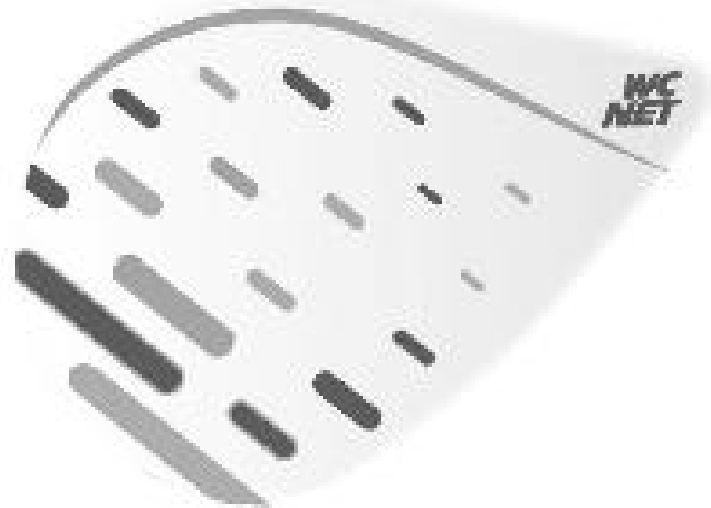

16.1

Ime autora dizajna	72	Michele CANTISANI, C/O BOLTON MANITOBA S.p.A., Via G.B. Pirelli, 19, I-20124 Milano, Italija
Ime i adresa nosioca prava	73	BOLTON MANITOBA S.p.A., Via G.B. Pirelli, 19, I-20124 Milano, Italija
Ime i adresa punomocnika	74	Miladin Popović, Đoka Miraševića 21/III, Podgorica

INFORMACIJA	KOD	PODATAK
Registarski broj	11	00149
Datum registracije	15	13.10.2020.
Očekivani datum isteka registracije/obnove	18	02.11.2023.
Broj prijave	21	D-2018-7
Broj prijavljenih dizajna	28	4
Datum podnošenja prijave	22	02.11.2018.
Podaci o pravu prvenstva na osnovu Pariske konvencije	30	pravo prvenstva od 03.05.2018. godine po osnovu prijave industrijskog dizajna broj 72115 (WIPO).
Klasa i podklasa Lokarnske klasifikacije	51	02-02
Naziv dizajna	54	UNIFORME

Prikaz 55



1.1



1.2



1.3



1.4



1.5



1.6



2.1



2.2



2.3



2.4



2.5



2.6



3.1



3.2



3.3

801



3.4



3.5

803



3.6

804



4.1



4.2



4.3

807



4.4



4.5



4.6

Ime autora dizajna	72	Kathryn Wilson, 19 Parkway, APSE Heath, Sandown, PO36 0LN, Isle of Wight, United Kingdom
Ime i adresa nosioca prava	73	Eurocar International, 2 rue René Caudron Bâtiment OP, 78960 Voisins le Bretonneux, France
Ime i adresa punomoćnika	74	Jasna Jusić, Dalmatinska broj 2, Podgorica

INFORMACIJA	KOD	PODATAK
Registarski broj	11	00146
Datum registracije	15	30.07.2020.
Očekivani datum isteka registracije/obnove	18	24.03.2025.
Broj prijave	21	D-2020-2
Broj prijavljenih dizajna	28	1
Datum podnošenja prijave	22	24.03.2020.
Podaci o pravu prvenstva na osnovu Pariske konvencije	30	
Klasa i podklasa Lokarnske klasifikacije	51	02-05
Naziv dizajna	54	KRAVATA

Prikaz 55



1.1

811



1.2



1.3

Ime autora dizajna	72	Radojka Krivokapić Radonjić
Ime i adresa nosioca prava	73	Kriva ulica, bb Kotor
Ime i adresa punomocnika	74	

OBJAVE OBNOVE VAŽENJA INDUSTRIJSKOG DIZAJNA
PUBLICATION OF INDUSTRIAL DESIGN RENEWAL

Registarski broj dizajna	Ime i adresa nosioca industrijskog dizajna	Datum do kojeg važi obnova industrijskog dizajna
(11)	(73)	(18)
00069	Honda Motor Co.,Ltd., 1-1, Minami-Aoyama 2-Chome, Minato-ku, Tokyo, Japan	24.08.2025.
00028	THE COCA-COLA COMPANY (a corporation of the State of Delaware) One Coca-Cola Plaza, NW, Atlanta, Georgia 30313, U.S.A	16.08.2025.
00130	Petroleum Nasional Berhad (PETRONAS), Tower 1, Petronas Twin Towers, Kuala Lumpur City Centr, 50088 Kuala Lumpur, Malaysia	26.08.2025.

CIP – Katalogizacija u publikaciji
Nacionalna biblioteka Crne Gore „Đurđe Crnojević“
347.77/78 (497.16)
Crnogorski glasnik intelektualne svojine: Službeni glasnik
Ministarstva ekonomskog razvoja Crne Gore = Official
Gazete of the Ministry of Economic Development
Montenegro
Glavni i odgovorni urednik: Dragana Ranitović
2021, br.37 - 815. - Podgorica
(Bulevar Mihaila Lalića broj 1): Ministarstvo ekonomskog
razvoja, 2021. - 30 cm
Tromjesečno.
ISSN 1800-8003 = Crnogorski glasnik intelektualne svojine
(Podgorica)
COBISS.CG-ID 15168784