

ISSN 1800-8003

**CRNOGORSKI  
GLASNIK  
INTELEKTUALNE  
SVOJINE**

INTELLECTUAL PROPERTY GAZETTE OF MONTENEGRO

**38/2021**

Službeni glasnik intelektualne svojine Crne Gore  
Official Gazette of the Montenegrin Intellectual Property

MINISTARSTVO EKONOMSKOG RAZVOJA  
Bulevar Mihaila Lalića broj 1  
Podgorica  
Crna Gora

# CRNOGORSKI GLASNIK INTELEKTUALNE SVOJINE

Godina XI

Datum objavljivanja 20.04.2021.

Izdavač:

**MINISTARSTVO EKONOMSKOG RAZVOJA**

Bulevar Mihaila Lalića broj 1

Podgorica

Crna Gora

Za izdavača:

**mr Jakov Milatović**

Glavni i odgovorni urednik:

**Dragana Ranitović**

Urednički odbor:

Vesna Nikčević

Lidija Martić

Marko Perišić

Tehnički urednik:

Milica Petrović Njegoš

Crnogorski glasnik intelektualne svojine službeno je glasilo za intelektualnu svojinu Crne Gore. U Glasniku se objavljuju sve relevantnim zakonima i pravilnicima propisane informacije iz postupka dodjele prava industrijskog vlasništva, informacije o dodijeljenim pravima te o kasnijim promjenama u vezi s tim pravima, kao i ostale službene informacije.

The Montenegrin intellectual property gazette is the official gazette of the Intellectual Property of the Montenegro. The Gazette publishes all the information, prescribed by the relevant laws and regulations, relating to the industrial property granting procedure concerning granted rights and subsequent changes made in connection with such right, as well as other official information.

# ***SADRŽAJ / CONTENTS***

**DVOSLOVNE OZNAKE ZEMALJA, TERITORIJA I MEĐUNARODNIH ORGANIZACIJA / Two letter code countries, territories and international organizations .....5**

## ***PATENTI / PATENTS***

**MEĐUNARODNI KODOVI ZA IDENTIFIKACIJU BIBLIOGRAFSKIH PODATAKA O PATENTIMA PREMA WIPO STANDARDU ST. 9 / Recommendation concerning bibliographic data on and relating to patents- wipo-st. 9 .....7**

**OBJAVE PRIJAVA PATENATA / PUBLICATION OF PATENT APPLICATIONS .....8**

**OBJAVA PROŠIRENIH EVROPSKIH PATENATA / Publication of extended european patents .....13**

**OBJAVA UPISA PROMJENA / Publication of record of changes .....170**

**OBJAVA ZAHTJEVA ZA PROŠIRENJE EVROPSKIH PRIJAVA PATENATA / Publication of request for the extension of the effects of european patent applications .....171**

**INDEKS BROJEVA ZAHTJEVA ZA PROŠIRENJE EVROPSKIH PRIJAVA PATENTA / Index on number of requests for extension on european patent application.....268**

**INDEKS KLASIFIKACIONIH OZNAKA ZAHTJEVA ZA PROŠIRENJE EVROPSKIH PRIJAVA PATENTA PREMA MEĐUNARODNOJ KLASIFIKACIJI PATENATA / Index on classification marks on requests for extension of european patent application in accordance with the international patent classification .....301**

**INDEKS PODNOSILACA ZAHTJEVA ZA PROŠIRENJE EVROPSKIH PRIJAVA PATENTA / Index on number of applications for extension of european patent application .....341**

## ***ŽIGOVÍ / TRADEMARKS***

**MEĐUNARODNI KODOVI ZA IDENTIFIKACIJU BIBLIOGRAFSKIH PODATAKA O ŽIGOVIMA PREMA WIPO ST 60 / Recommendation concerning bibliographic data relating to trademarks- wipo-st.....389**

**OBJAVA PRIJAVA ŽIGOVA / Publication of trademark applications .....491**

**OBJAVA ŽIGOVA / Publication of trademarks .....506**

## **INDUSTRIJSKI DIZAJN/INDUSTRIAL DESIGN**

MEĐUNARODNI KODOVI ZA IDENTIFIKACIJU BIBLIOGRAFSKIH PODATAKA O DIZAJNU  
PREMA WIPO ST 80 / Recommendation concerning bibliographic data relating to industrial  
design- wipo-st. 80 .....738

**OBJAVE OBNOVE VAŽENJA INDUSTRIJSKOG DIZAJNA** / Publication of industrial design  
renewal .....739

## DVOSLOVNE OZNAKE ZEMALJA, TERITORIJA I MEĐUNARODNIH ORGANIZACIJA

### Two letter code countries, territories and international organizations

<b>AD</b> Andora	<b>CF</b> Centralna Afrička Republika	<b>GB</b> Velika Britanija
<b>AE</b> Ujedinjeni Arapski Emirati	<b>CG</b> Kongo	<b>GC</b> Patentna kancelarija Savjeta za saradnju država Arapskog Zaliva (GCC)
<b>AF</b> Afganistan	<b>CH</b> Švajcarska	<b>GD</b> Grenada
<b>AG</b> Antigva i Barbuda	<b>CI</b> Obala Bjelokosti	<b>GE</b> Gruzija
<b>AI</b> Angvila	<b>CK</b> Kukova ostrva	<b>GG</b> Guernsey
<b>AL</b> Albanija	<b>CL</b> Čile	<b>GH</b> Gana
<b>AM</b> Armenija	<b>CM</b> Kamerun	<b>GI</b> Gibraltar
<b>AN</b> Holandski Antili	<b>CN</b> Kina	<b>GL</b> Grenland
<b>AO</b> Angola	<b>CO</b> Kolumbija	<b>GM</b> Gambija
<b>AP</b> Afrička regionalna organizacija za industrijsko vlasništvo (ARIPO)	<b>CR</b> Kostarika	<b>GN</b> Gvineja
<b>AR</b> Argentina	<b>CU</b> Kuba	<b>GQ</b> Ekvatorska Gvineja
<b>AT</b> Austrija	<b>CV</b> Kabo Verde	<b>GR</b> Grčka
<b>AU</b> Australija	<b>CY</b> Kipar	<b>GS</b> Južna Džordžija i Ostrva Južni Sendvič
<b>AW</b> Aruba	<b>CZ</b> Češka Republika	<b>GT</b> Gvatemala
<b>AZ</b> Azerbejdžan	<b>DE</b> Njemačka	<b>GW</b> Gvineja-Bisao
<b>BA</b> Bosna i Hercegovina	<b>DJ</b> Džibuti	<b>GY</b> Gvajana
<b>BB</b> Barbados	<b>DK</b> Danska	<b>HK</b> Hongkong – Posebna administrativna regija
<b>BD</b> Bangladeš	<b>DM</b> Dominika	<b>NR</b> Kine
<b>BE</b> Belgija	<b>DO</b> Dominikanska Republika	<b>HN</b> Honduras
<b>BF</b> Burkina Faso	<b>DZ</b> Alžir	<b>HR</b> Hrvatska
<b>BG</b> Bugarska	<b>EA</b> Evroazijska patentna organizacija (EAPO)	<b>HT</b> Haiti
<b>BH</b> Bahrein	<b>EC</b> Ekvador	<b>HU</b> Mađarska
<b>BI</b> Burundi	<b>EE</b> Estonija	<b>IB</b> Međunarodna kancelarija Svjetske organizacije za intelektualno vlasništvo (WIPO)
<b>BJ</b> Benin	<b>EG</b> Egipat	<b>ID</b> Indonezija
<b>BM</b> Bermudi	<b>EH</b> Zapadna Sahara	<b>IE</b> Irska
<b>BN</b> Brunej Darussalam	<b>EM</b> Kancelarija za harmonizaciju Unutrašnjeg tržišta (žigovi i dizajn) (OHIM)	<b>IL</b> Izrael
<b>BO</b> Bolivija	<b>EP</b> Evropska patentna kancelarija (EPO)	<b>IM</b> Ostrvo Man
<b>BR</b> Brazil	<b>ER</b> Eritreja	<b>IN</b> Indija
<b>BS</b> Bahami	<b>ES</b> Španija	<b>IQ</b> Irak
<b>BT</b> Butan	<b>ET</b> Etiopija	<b>IR</b> Iran (Islamska Republika)
<b>BV</b> Ostrvo Buve	<b>FI</b> Finska	<b>IS</b> Island
<b>BW</b> Bocvana	<b>FJ</b> Fidži	<b>IT</b> Italija
<b>BX</b> Kancelarija za intelektualno vlasništvo Beneluksa (BOIP)	<b>FK</b> Foklandska ostrva (Malvini)	<b>JE</b> Džersi
<b>BY</b> Bjelorusija	<b>FO</b> Farska Ostrva	<b>JM</b> Jamajka
<b>BZ</b> Belize	<b>FR</b> Francuska	<b>JO</b> Jordan
<b>CA</b> Kanada	<b>GA</b> Gabon	
<b>CD</b> Demokratska Republika Kongo		

**JP** Japan  
**KE** Kenija  
**KG** Kirgistan  
**KH** Kambodža  
**KI** Kiribati  
**KM** Komori  
**KN** Sveti Kristofor i Nevis  
**KP** Demokratska Narodna  
Republika Koreja  
**KR** Republika Koreja  
**KW** Kuvajt  
**KY** Kajmanska Ostrva  
**KZ** Kazahstan  
**LA** Narodna Demokratska  
Republika Laos  
**LB** Libanon  
**LC** Sveta Lucija  
**LI** Lihtenštajn  
**LK** Šri Lanka  
**LR** Liberija  
**LS** Lesoto  
**LT** Litva  
**LU** Luksemburg  
**LV** Latvija  
**LY** Libijska Arapska  
Džamahirija  
**MA** Maroko  
**MC** Monako  
**MD** Republika Moldavija  
**ME** Crna Gora  
**MG** Madagaskar  
**MK** Sjeverna Makedonija  
**ML** Mali  
**MM** Mianmar  
**MN** Mongolija  
**MO** Makao  
**MP** Sjeverna Marijanska  
Ostrva  
**MR** Mauritanija  
**MS** Montserrat  
**MT** Malta  
**MU** Mauricijus  
**MV** Maldivi  
**MW** Malavi  
**MX** Meksiko  
**MY** Malezija  
**MZ** Mozambik  
**NA** Namibija  
**NE** Niger  
**NG** Nigerija  
**NI** Nikaragva

**NL** Holandija  
**NO** Norveška  
**NP** Nepal  
**NR** Nauru  
**NZ** Novi Zeland  
**OA** Afrička organizacija  
za intelektualno  
vlasništvo (OAPI)  
**OM** Oman  
**PA** Panama  
**PE** Peru  
**PG** Papuanska Nova  
Gvineja  
**PH** Filipini  
**PK** Pakistan  
**PL** Poljska  
**PT** Portugal  
**PW** Palau  
**PY** Paragvaj  
**QA** Katar  
**QZ** Kancelarija Zajednice  
za biljne sorte  
(Evropska Unija)  
(CPVO)  
**RO** Rumunija  
**RS** Srbija  
**RU** Ruska Federacija  
**RW** Ruanda  
**SA** Saudijska Arabija  
**SB** Solomonska Ostrva  
**SC** Sejšeli  
**SD** Sudan  
**SE** Švedska  
**SG** Singapur  
**SH** Sveta Jelena  
**SI** Slovenija  
**SK** Slovačka  
**SL** Sijera Leone  
**SM** San Marino  
**SN** Senegal  
**SO** Somalija  
**SR** Surinam  
**ST** Sveti Toma i Princip  
**SV** Salvador  
**SY** Sirijska Arapska  
Republika  
**SZ** Svazi  
**TC** Turska i Kajkoska  
Ostrva  
**TD** Čad  
**TG** Togo

**TH** Tajland  
**TJ** Tadžikistan  
**TL** Istočni Timor  
**TM** Turkmenistan  
**TN** Tunis  
**TO** Tonga  
**TR** Turska  
**TT** Trinidad i Tobago  
**TV** Tuvalu  
**TW** Tajvan, Kineska  
Pokrajina  
**TZ** Ujedinjena Republika  
Tanzanija  
**UA** Ukrajina  
**UG** Uganda  
**US** Sjedinjene Američke  
Države  
**UY** Urugvaj  
**UZ** Uzbekistan  
**VA** Sveta Stolica (Vatikan)  
**VC** Sveti Vincent i  
Grenadini  
**VE** Venecuela  
**VG** Britanska Djevičanska  
Ostrva  
**VN** Vijetnam  
**VU** Vanuatu  
**WO** Svjetska organizacije  
za intelektualno  
vlasništvo (WIPO)  
(Međunarodna  
kancelarija)  
**WS** Samoa  
**XN** Nordijski institut za  
patente (NPI)  
**YE** Jemen  
**ZA** Južnoafrička  
Republika  
**ZM** Zambija  
**ZW** Zimbabve



## ***PATENTI***

## ***PATENTS***

### **MEĐUNARODNI KODOVI ZA IDENTIFIKACIJU BIBLIOGRAFSKIH PODATAKA O PATENTIMA PREMA WIPO STANDARDU ST. 9**

**Reccommendation concerning bibliografic data on and relating to patents-  
wipo-st. 9**

<b>CRNOGORSKI</b>	<b>MDK</b>	<b>ENGLESKI</b>
IDENTIFIKATOR DOKUMENTA	<b>10</b>	IDENTIFICATION OF THE PATENT
BROJ DOKUMENTA	<b>11</b>	NUMBER OF THE PATENT
VRSTA DOKUMENTA	<b>13</b>	KIND-OF-DOCUMENT CODE ACCORDING TO WIPO STANDARD
BROJ PRIJAVE	<b>21</b>	NUMBER(S) ASSIGNED TO THE APPLICATION(S)
DATUM PODNOŠENJA PRIJAVE	<b>22</b>	DATE(S) OF FILING THE APPLICATION(S)
DATUM IZLAGANJA NA MEĐUNARODNOJ IZLOŽBI	<b>23</b>	DATE OF EXHIBITING AT THE INTERNATIONAL EXIBITION
PODACI O PRAVU PRVJENSTVA	<b>30</b>	PRIORITY DATA
DATUM OBJAVLJIVANJA PRIJAVE	<b>43</b>	PUBLICATION DATE OF THE UNEXAMINED APPLICATION
DATUM OBJAVLJIVANJA PATENTA	<b>45</b>	PUBLICATION DATE OF REGISTERED PATENT
MEĐUNARODNA KLASIFIKACIJA PATENATA	<b>51</b>	INTERNATIONAL PATENT CLASSIFICATION CODE
NAZIV PRONALASKA	<b>54</b>	TITLE OF THE INVENTION
APSTRAKT ILI PATENTNI ZAHTEV	<b>57</b>	ABSTRACT OR CLAIM
BROJ OSNOVNE PRIJAVE (ILI PATENTA) ZA KOJI SE PODNOSI DOPUNSKA PRIJAVA	<b>61</b>	NUMBER OF THE EARLIER APPLICATION (OR PATENT) TO WHICH THE PRESENT DOCUMENT IS AN ADDITION
BROJ PRVOBITNE PRIJAVE IZ KOJE JE PRIJAVA IZDVOJENA	<b>62</b>	NUMBER OF THE EARLIER APPLICATION FROM WHICH THE PRESENT DOCUMENT HAS BEEN DIVIDED UP
IME PODNOSIOCA PRIJAVE	<b>71</b>	NAME OF THE APPLICANT
IME PRONALAZAČA	<b>72</b>	NAME OF THE INVENTOR
IME NOSIOCA PATENTA	<b>73</b>	NAME OF THE OWNER OF PATENT
IME PUNOMOĆNIKA	<b>74</b>	NAME OF THE REPRESENTATIVE
BROJ I DATUM PODNOŠENJA MEĐUNARODNE PRIJAVE	<b>86</b>	NUMBER AND FILING DATE OF THE INTERNATIONAL APPLICATION
BROJ I DATUM MEĐUNARODNE OBJAVE	<b>87</b>	NUMBER AND DATE OF THE PUBLICATION OF THE INTERNATIONAL APPLICATION

**OBJAVE PRIJAVA PATENATA**  
**Publication of patent application**

(11) **03826** (13) **B**

(51) **E06B/3/00**<sup>(2006.01)</sup>

(21) P-2019-296

(22) 22.10.2019

(54) me **NEPRODORNA MAGNETNA MREŽICA PROTIV INSEKATA**  
en **THE MAGNETIC SWATTER WHICH NON-PENETRATING EXTERNAL FACTORS**

(73) Urul, Mert

Vojvođanska 12, Budva, 85310/ ME

(72) Mr Senol, Guvenc

Vojvođanska 12, Budva, 85310/ ME

(57)

Izum se odnosi na mreže protiv insekata koje sprečavaju prodiranje spoljašnjih uticaja kao i potpuna, učinkovita zaštita od vanjskih uticaja prevučena nanotehnologijom, nanočelijama koje su sakupljači prašine (5) j nanočelijama, koje odbijaju prašinu (6), tj. nanočelijama sa zaštitnim slojem nanotehnologije (5) i nanočelijama koji odbijaju prašinu (6) između kojih se stvara magnetsko polje (1) a sadrži i induktor (2).

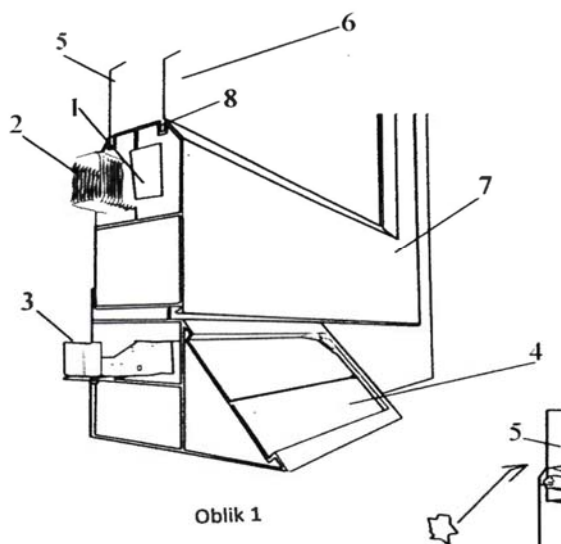



(11) **03827 (13) B**

(51) **E06C 1/26<sup>(2006.01)</sup>**

(21) P-2019-297

(22) 23.10.2019

(54) me **MINI SKELA ZA STANDARDNU VISINU PLAFONA (260 cm)**  
en **MINI SCAFFOLDING FOR STANDARD CEILING HEIGHT (260 cm)**

(73) Mr Sekulović, Saša

Skopska 104, Podgorica, 81000

(72) Mr Sekulović, Saša

Skopska 104, Podgorica, 81000

(57)

Mini skela omogućava potpuno nove uslove za sve vrste poslova koji se mogu i žele obaviti na plafonima visine 2, 60m, koja je standardna u Crnoj Gori, ali i mnogo šire. Kod nas se molerski i drugi radovi obavljaju na improvizovanim skelama, koje nijesu za to adekvatne. Mini skela omogućava siguran rad, slobodno kretanje, ima šire i sigurnije gazište što daje veću mogućnost samom radniku - umjesto da brine o svom kretanju i ravnoteži, lakše će se koncentrisati na posao koji radi, takođe, moći će da obuhvati veći dio plafona i neće mu biti potrebni pomagači pri poslu. Mini skela je lako podesiva za tri visine pomoću vrlo jednostavnog mehanizma, pa je mogu koristiti svi radnici, bez obzira na svoje fizičke predispozicije (svejedno da li je čovjek visok 160 ili 190cm). Pouzdana je i prilagodljiva svim prostorima. lako nosiva, ne zauzima prostor, i može se koristiti, uz osnovnu, i u druge svrhe. Olakšava posao i time ubrzava rad. Mogu je koristiti i neprofesionalci, sasvim sigurno i pouzdano.

(11) 03825 (13) B

(51) E04H 17/00<sup>(2006.01)</sup>  
H02S 20/10<sup>(2015.01)</sup>  
H02S 20/30<sup>(2015.01)</sup>

H02S 20/00<sup>(2015.01)</sup>  
H02S 20/21<sup>(2015.01)</sup>

(21) P-2019-87

(22) 20.03.2019

(54) me **PAMETNA MONTAŽNA-DEMONTAŽNA OGRADA SA SOLARNIM PANELIMA  
(E.H.T. 06-3)**

en **SMART MOUNTABLE-DEMOUNTABLE FENCE WITH SOLAR PANELS (E.H.T. 06-3)**

(73) JUNČAJ, Albert

Dušići, Tuzi, 81206

(72) ANĐUŠIĆ, Dragan

Rada Kneževića 13, Nikšić, 81400/ ME

(57)

Pametna montažna-demontažna ograda sa solarnim panelima (E.H.T. 06-3) je pronalazak koji ujedno služi kao ograda za ograđivanje površine i kao solarna fotonaponska elektrana malih i velikih razmjera. Pronalazak čine solarni paneli (1) koji se postavljaju na ZF kutijama (2) koje su postavljene na tijelu nosaca (4) koji je pričvršćen sa gornjom lučnom pločevinom (3) i donjom pločevinom (6). Držači sajle (5) služe za postavljanje plastificirane štancovane žice na koje se kači perforirana PVC mreža. Tijelo nosača je fiksirano fišerovim šarafima za betonski dio koji je očvršćen armaturom F16mm (7). Prostor između svakog nosača (8) je predviđen za sađenje drveća za živu ogradu. Cijela konstrukcija je montažno-demontažna osim betonskog dijela.

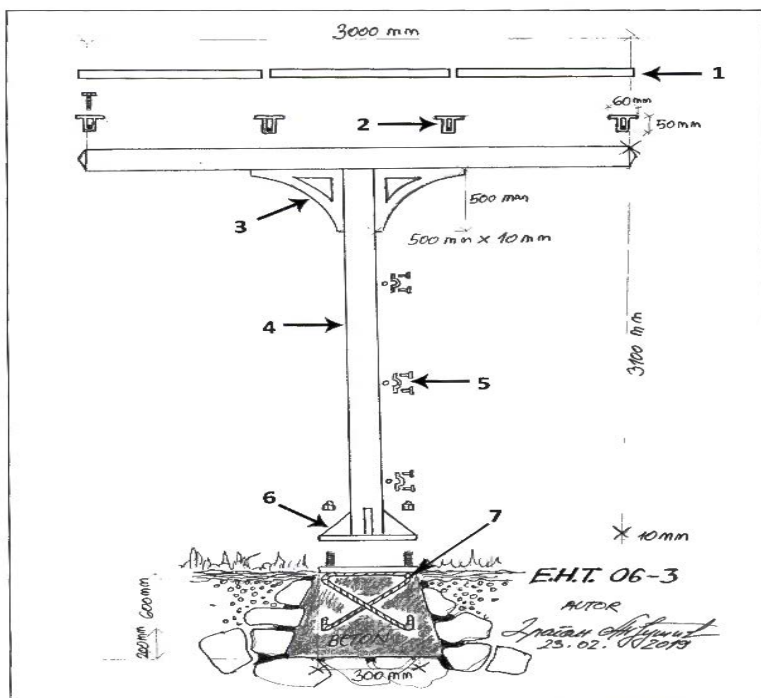

Slika 1

(11) **03842** (13) **B**

(51) **H02M7/00**<sup>(2006.01)</sup>

(21) P-2020-182

(22) 26.08.2020

(54) me **Elektrostanica za punjenje akumulatorskih baterija**  
en **Battery charging power plant**

(73) BOJOVIĆ, Milan

Njegoševa br.4, Žabljak, 84220 / ME

(72) BOJOVIĆ, Milan

Njegoševa 4, Žabljak, 84220/ ME

(57)

Novo konstruktivno rešenje iz oblasti energetske elektronike koje pripada elektrouređajima-punjačima akumulatorskih baterija, koje koristi energiju iz 12V baterije autonomno bez drugih izvora energije. Pouzdan u radu, ekološki čist bez sagorevanja goriva, lak za održavanje i jednostavan u proizvodnji. Konstrukcija se sastoji u tome: što se baterija 12V tacka 1 poveže sa tačkom 2 uređajem ZMP-2013-73. Tačka 2 sa tačkom 1, tačkom 3 amerimetrom i voltimetrom jednosmjerne struje i tačkom 6 pretvaračem. Tačka 3 poveže sa tačkom 4 regulatorom napona i tačkom 5 utičnicom jednosmjerne struje. Tačka 6 pretvarač sa tačkom 7 amperimetrom i voltimetrom naizmjenične struje a tačka 7 sa tačkom 8 regulatorom napona naizmjenične struje. Tačka 8 sa tačkom 9 utičnicom Naizmjenične struje napona 220V što sve povezano čini jednu funkcionalnu cjelinu.

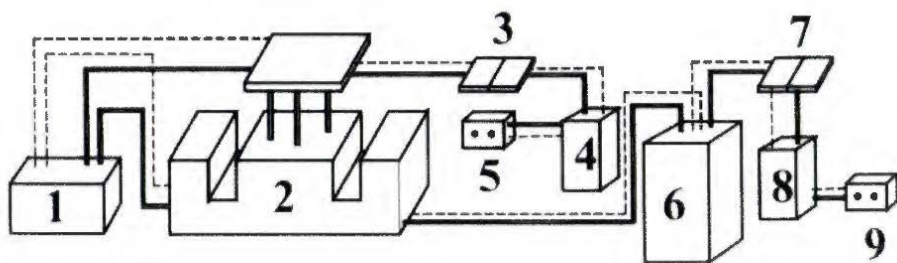

**Legenda:**

— "+" vod

- - - "-" vod

**Slika 1.**

(11) **03824** (13) **B**

(51) **A01G 17/00**<sup>(2006.01)</sup>

**A47F 10/00**<sup>(2006.01)</sup>

(21) P-2021-9

(22) 12.01.2021

(54) me **Prirodno oplemenjene amfore i vina iz mora**  
en **Naturally refined amphorae for wine from the sea**

(73) ĐERIĆ, Nevres

Dobrota bb, Kotor, 85330/ ME

(72) ĐERIĆ, Nevres

Dobrota bb, Kotor, 85330/ ME

(57)

Zaključak pronalaska je dobijanje novog traženog unikatno prirodno oblikovanog proizvoda-suvenira koji će da ukrašavaju razne prostore, turističke objekte, restorane, konobe, baste, dvorišta i plovne objekte ali i da ujedno spriječimo devastaciju i otuđenje javnih dobara kojih je nažalost bilo jer je potražnja istih velika.

Kvalitet i vizuelnost proizvoda daje vjernu sliku onih amfora po nekoliko stotina godina starosti ali sa deset puta manjom cijenom. Ovaj pronalazak primjenjiv za unutrašnju i vanjsku upotrebu i prodaju na našem i inostranom tržištu.



**OBJAVA PROŠIRENIH EVROPSKIH PATENATA**  
**Publication of extended european patents**

(11) **03723** (13) **B**

(51) **C07D 401/12**<sup>(2006.01)</sup>  
**C07D 417/12**<sup>(2006.01)</sup>

**A61K 31/497**<sup>(2006.01)</sup>

**A61K 31/506**<sup>(2006.01)</sup>

**C07D 413/12**<sup>(2006.01)</sup>

**A61K 31/444**<sup>(2006.01)</sup>

**A61K 31/4439**<sup>(2006.01)</sup>

**A61P 25/28**<sup>(2006.01)</sup>

(21) P-2018-267

(22) 09.11.2015

(30) 201400648 10.11.2014 DK  
201500447 07.08.2015 DK

(96) 15805109.4/09.11.2015

(86) EP PCT/EP2015/076015/09.11.2015

(87) WO 2016/075063/19.05.2016/2016/20

(97) EP 3218365/20.09.2017/2017/38

EP 3218365/10.10.2018/2018/41

(54) me **2-AMINO-6-(DIFLUOROMETIL)- 5,5-DIFLUORO-6-FENIL-3,4,5,6-TETRAHIDROPIRIDINI KAO BACE1 INHIBITORI**  
en **2-AMINO-6-(DIFLUOROMETHYL)- 5,5-DIFLUORO-6-PHENYL-3,4,5,6-TETRAHYDROPYRIDINES AS BACE1 INHIBITORS**

(73) H. Lundbeck A/S

Ottiliavej 9, 2500 Valby/ DK

(72) JUHL, Karsten

Brydeholm 56, DK-2670 Greve/ DK

TAGMOSE, Lena

Østervang 16, DK-2800 Lyngby/ DK

MARIGO, Mauro

Jyttevej 23, DK-2740 Skovlunde/ DK

(57)

1. Jedinjenje formule I

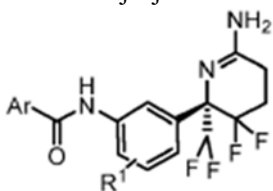

Formula I

u kojoj je Ar odabran iz grupe koju čine fenil, piridil, pirimidil, pirazinil, imidazolil, pirazolil, tiazolil, oksazolil, izoksazolil, i gde je Ar opciono supstituisani jednim ili više supstituenata odabran od halogena, CN, C1-C6 alkila, C2-C6 alkenila, C2-C6 alkinila, C1-C6 fluoroalkila ili C1-C6 alkoksi; i

R1 je vodonik, halogen, C1-C3 fluoroalkil ili C1-C3 alkil;

ili njegova farmaceutski prihvatljiva so.

**Patent sadrži još 12 patentnih zahtjeva**

(11) **03753** (13) **B**

(51) **C07K 16/28**<sup>(2006.01)</sup>

**A61P 37/06**<sup>(2006.01)</sup>

(21) P-2019-212

(22) 19.02.2014

(30) 13425029 19.02.2013 EP

(96) 14705767.3/19.02.2014

(86) EP PCT/EP2014/053243/19.02.2014

(87) WO 2014/128168/28.08.2014/2014/35

(97) EP 2864359/29.04.2015/2015/18

EP 2864359/24.04.2019/2019/17

(54) me **ANTI-CD26 ANTITELA I NJIHOVE PRIMENE**  
en **ANTI-CD26 ANTIBODIES AND USES THEREOF**

(73) ADIENNE S.A.

Via Zurigo, 46, 6900 Lugano/ CH

(72) , DI NARO, Antonio Francesco

Via San Bartolomee, CH-6922 Morcote/ CH

(57)

1. Izolovano monoklonsko antitelo koje specificno vezuje humani CD26, navedeno antitelo koje sadrzi varijabilni region teskog lanca i varijabilni region lakog lanca, gde navedeni varijabilni region teskog lanca saddi VH CDR I koji sadrzi sekvencu predstavljenu u SEQ 10 NO: 133, VH CDR2 koji sadrzi sekvencu predstavljenu u SEQ 10 NO: 134, i VH CDR3 koji saddi sekvencu predstavljenu u SEQ 10 NO: 1, i gde navedeni varijabilni region lakog lanca sadrzi VL CDR1 koji sadrzi sekvencu predstavljenu u SEQ 10 NO: 129, VL CDR2 koji saddi sekvencu predstavljenu u SEQ 10 NO: 130, i VL CDR3 koji saddi sekvencu predstavljenu u SEQ ID NO: 2, gde navedeni varijabilni region lakog lanca sadrzi aminokiselinsku sekvencu odabranu iz grupe koja se sastoji od SEQ ID NOs: 4, i 6 do 21, i gde navedeni varijabilni region teskog lanca sadrzi aminokiselinsku sekvencu odabranu iz grupe koja se sastoji od SEQ 10 NOs: 22 do 47.

**Patent sadrži još 14 patentnih zahtjeva**

(11) **03754** (13) **B**

(51) **C07D 401/04**<sup>(2006.01)</sup>

**C07D 471/04**<sup>(2006.01)</sup>

**A61K 31/403**<sup>(2006.01)</sup>

**A61P 37/00**<sup>(2006.01)</sup>

**C07D 403/04**<sup>(2006.01)</sup>

**C07D 209/88**<sup>(2006.01)</sup>

**A61P 29/00**<sup>(2006.01)</sup>

(21) P-2019-363

(22) 23.10.2015

(30) 201462068234 P 24.10.2014 US

(96) 15790408.7/23.10.2015

(86) US PCT/US2015/057077/23.10.2015

(87) WO 2016/065236/28.04.2016/2016/17

(97) EP 3209651/30.08.2017/2017/35

EP 3209651/23.10.2019/2019/43

(54) me **DERIVATI KARBAZOLA**  
en **CARBAZOLE DERIVATIVES**

(73) BRISTOL-MYERS SQUIBB COMPANY

Route 206 and Province Line Road, Princeton, NJ 08543/ US

(72) AHMAD, Saleem

c/o Bristol-Myers Squibb Company Route 206&Province Line Road, Princeton, New Jersey 08543/ US  
BATT, Douglas G.

c/o Bristol-Myers Squibb Company Route 206&Province Line Road, Princeton, New Jersey 08543/ US  
LIU, Qingjie

c/o Bristol-Myers Squibb Company Route 206&Province Line Road, Princeton, New Jersey 08543/ US  
MACOR, John E.

55 Commanders Drive Washinton Crossing, PA 18977/ US

TINO, Joseph A.

c/o Bristol-Myers Squibb Company Route 206&Province Line Road, Princeton, New Jersey 08543/ US  
WATTERSON, Scott Hunter

8 Donovan Road Pennington, NJ 08534, US/ US

NAIR, Satheesh Kesavan

c/o Syngene International Limited Biocon Special Economic Zone Biocon Park Plot No. 2&3 Bommasandra Industrial  
Area IV Phase Jigani Link Road Bommasandra, Bangalore Karnataka/ IN

MAISHAL, Tarun Kumar

c/o Syngene International Limited Biocon Special Economic Zone Biocon Park Plot No. 2&3 Bommasandra Industrial  
Area IV Phase Jigani Link Road Bommasandra, Bangalore Karnataka/ IN

(57)

1. Jedinjenje formule (I)

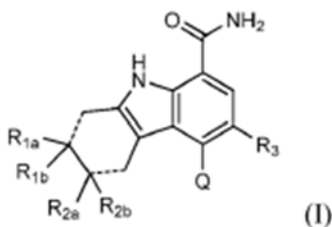

ili njegova so, gde:

dve isprekidane linije predstavljaju ili dve jednostruke ili dve dvostruke veze; i R1b i R2b su prisutni samo ako su dve isprekidane linije dve jednostruke veze;

Q je:

(i)

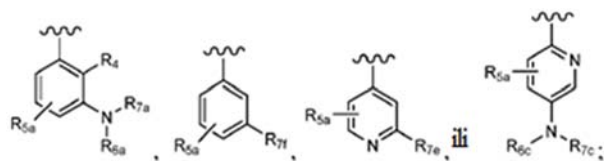

(ii)

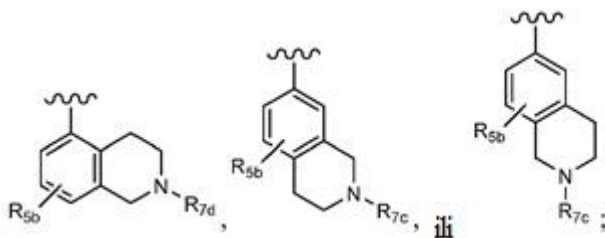
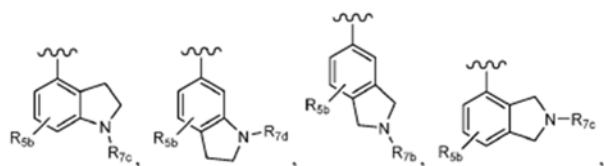

(iii)

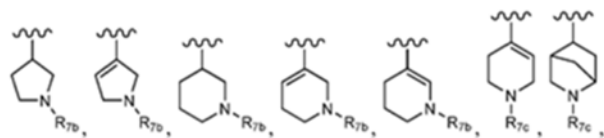



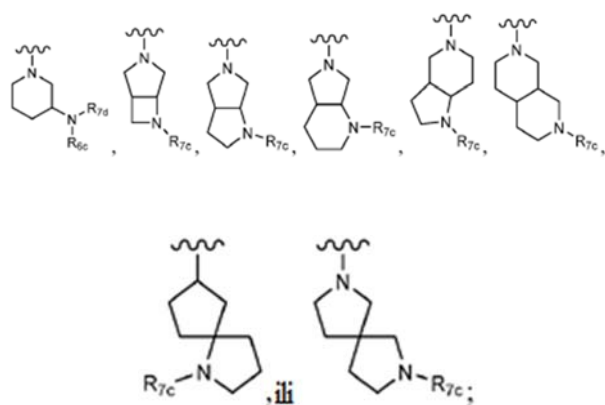

iii  
(iv)

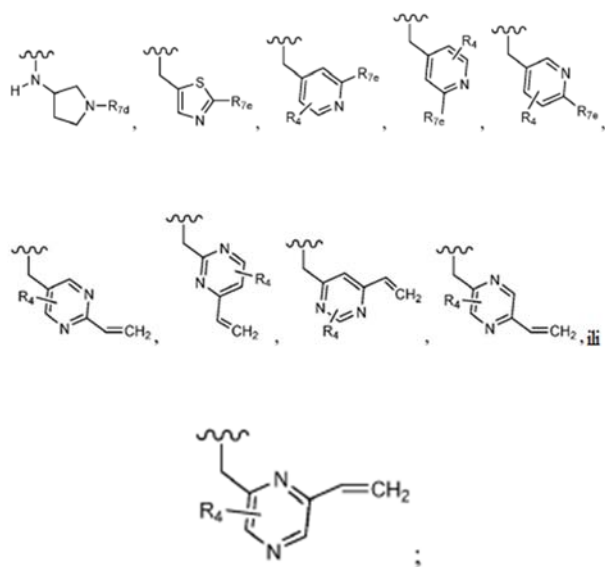

R1a je:

- (i) H, -CN, -CF<sub>3</sub>, -CH<sub>3</sub>, -CR<sub>8a</sub>R<sub>8b</sub>OH, -CR<sub>8a</sub>R<sub>8b</sub>CR<sub>8a</sub>R<sub>8b</sub>OH, -CH(OH)CH<sub>2</sub>OH, -NHR<sub>9</sub>, -C(O)NR<sub>10a</sub>R<sub>10b</sub>, -C(O)(morfolinil), -C(O)(piperazinil), ili -C(O)(metil piperazinil); ili  
(ii)

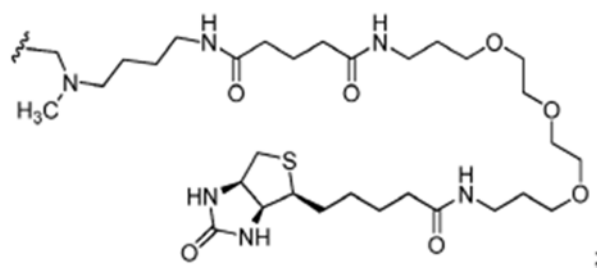

R1b, kada je prisutan, je H ili -CH<sub>3</sub>, pod uslovom da ako R1a je H onda R1b je takođe H;

R2a je H, F, ili Cl, pod uslovom da ako R1a je drugačije od H onda R2a je H;

R2b, kada je prisutan, je isti kao R2a;

R3 je H, F, ili Cl;

R4 je H, F, Cl, ili -CH<sub>3</sub>;

R5a je H, F, Cl, -OCH<sub>3</sub>, ili -OCF<sub>3</sub>;

R5b je H, F, Cl, -OCH<sub>3</sub>, ili -OCF<sub>3</sub>;

R6a je H, -CH<sub>3</sub> ili ciklopropil;

R6c je H, -CH<sub>3</sub> ili ciklopropil;

R7a je -C(O)CH=CH(R11), -C(O)C≡CR12, ili -S(O)<sub>2</sub>CH=CH<sub>2</sub>;

R7b je -C(O)CH=CH<sub>2</sub>;

R7c je -C(O)CH=CH<sub>2</sub> ili -C(O)C≡CR12;

R7d je -CN, -C(O)CH=CH<sub>2</sub>, ili -C(O)C≡CR13;

R7e je -CH=CH<sub>2</sub> ili -C≡CR13;

R7f je pirolidinil supstituisan sa R7c, -CH=CHC(O)(morfolinil), ili -CH=CHC(O)(pirolidinil);

R8a je H ili -CH<sub>3</sub>;

R8b je H ili -CH<sub>3</sub>;

R9 je C1-4 alkil;

R10a i R10b su nezavisno H ili -CH<sub>3</sub>;

R11 je H ili -CH<sub>3</sub>;

R12 je H, C1-4 alkil, ili ciklopropil; i

R13 je H, C1-4 alkil, ili ciklopropil;

pod uslovima da:

(a) ako Q je

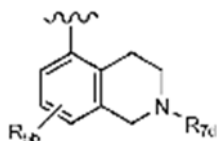

i R7d je -CN ili -C(O)CH=CH<sub>2</sub>, onda R3 je H; i

(b) ako isprekidane linije predstavljaju dve jednostruke veze, onda:

(i) Q nije

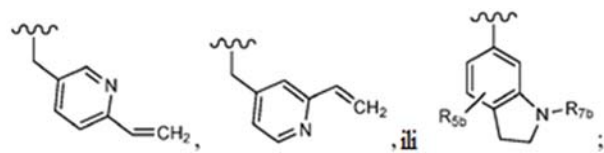

- (ii) R11, ako je prisutan, je H; i
- (iii) jedinjenje formule (I) nije:

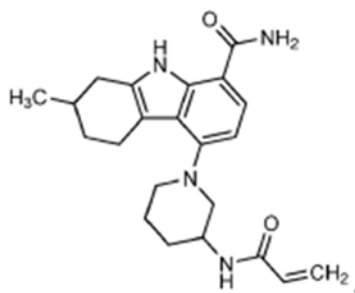

**Patent sadrži još 17 patentnih zahtjeva**

(11) **03748** (13) **B**

(51) **C07D 487/04**<sup>(2006.01)</sup>

**A61K 31/519**<sup>(2006.01)</sup>

**A61P 9/10**<sup>(2006.01)</sup>

**A61P 9/04**<sup>(2006.01)</sup>

**C07D 519/00**<sup>(2006.01)</sup>

**A61P 9/00**<sup>(2006.01)</sup>

**A61P 9/12**<sup>(2006.01)</sup>

(21) P-2020-103

(22) 20.12.2016

(30) PCT/CN2015/098251 22.12.2015 WO

(96) 16823455.7/20.12.2016

(86) US PCT/US2016/067654/20.12.2016

(87) WO 2017/112617/29.06.2017/2017/26

(97) EP 3394067/31.10.2018/2018/44

EP 3394067/01.04.2020/2020/14

(54) me **DERIVATI 4-AMINO-2-(1H-PIRAZOLO[3,4-B]PIRIDIN-3-IL)-6-OKSO-6,7-DIHIDRO-5H--PIROLO[2,3-D]PIRIMIDINA I RESPEKTIVNI(1H-INDAZOL-3-IL) DERIVATI KAO MODULATORI CGMP ZA LEČENJE KARDIOVASKULARNIH BOLESTI**

en **4-AMINO-2-(1H-PYRAZOLO[3,4-B]PYRIDIN-3-YL)-6-OXO-6,7-DIHYDRO-5H-PYRROLO[2,3-D]PYRIMIDINE DERIVATIVES AND THE RESPECTIVE (1H-INDAZOL-3-YL) DERIVATIVES AS CGMP MODULATORS FOR TREATING CARDIOVASCULAR DISEASES**

(73) MERCK SHARP & DOHME CORP.

126 East Lincoln Avenue, Rahway, NJ 07065-0907/ US

(72) BERGER, Raphelle

126 East Lincoln Avenue, Rahway, New Jersey 07065-0907/ US

CHEN, Yi-Heng

126 East Lincoln Avenue, Rahway, New Jersey 07065-0907/ US

LI, Guoqing

2000 Galloping Hill Road, Kenilworth, New Jersey 07033/ US

GARFUNKLE, Joie

600 Coporate Drive, Lebanon, New Jersey 08833/ US

LI, Hong

126 East Lincoln Avenue, Rahway, New Jersey 07065-0907/ US

MIAO, Shouwu

295 Prestwick Way, Edison, New Jersey 08820/ US

RAGHAVAN, Subharekha

2000 Galloping Hill Road, Kenilworth, New Jersey 07033/ US

SMITH, Cameron J.

9004 Snowford Court, Montgomery Village, Maryland 20886-4017/ US

STELMACH, John

228 Seneca Place, Westfield, New Jersey 07090/ US

WHITEHEAD, Alan

126 East Lincoln Avenue, Rahway, New Jersey 07065-0907/ US

ZHANG, Rui

2000 Galloping Hill Road, Kenilworth, New Jersey 07033/ US

ZHANG, Yong

126 East Lincoln Avenue, Rahway, New Jersey 07065-0907/ US

FU, Jianmin

6 Tai-He Road BDA, Beijing 100176/ CN

JI, Gang

6 Tai-He Road BDA, Beijing 100176/ CN

JIANG, Falong

6 Tai-He Road BDA, Beijing 100176/ CN

(57)

1. Jedinjenje Formule (I)

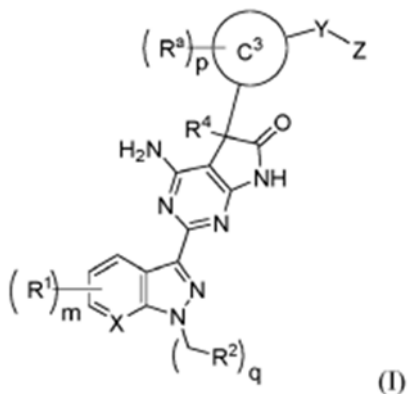

ili njegova farmaceutski prihvatljiva so, **naznačeni time**, što

X je C(H) ili N;

svaki R1 je nezavisno halo, hidroksi, C1-C3 alkil, C3-C6 cikloalkil ili -O-C1-C3 alkil;

R2 je:

(a.) C1-C6 alkil, gde je pomenuti C1-C6 alkil R2 nesupstituisan ili je supstituisan sa 1 do 6 komponenti nezavisno odabranih između fluoro ili -O-C1-C3 alkil;

(b.) prsten C2, gde je prsten C2:

(i.) C3-C12 cikloalkil;

(ii.) fenil;

(iii.) 5- ili 6-člani monociklični heteroaril koji sadrži 1 do 2 heteroatoma odabrana između N, O, ili S; ili

(iv.) 5- ili 6-člani monociklični heterociklil koji sadrži 1 do 2 heteroatoma odabrana između N, O, ili S;

gde je prsten C2 nesupstituisan ili je supstituisan sa 1 do 3 komponente nezavisno odabrane između halo, cijano, C1-C3 alkil, -O-C1-C3 alkil, ili okso;

R4 je C1-C6 alkil, CF3, ili C3-C6 cikloalkil;

prsten C3 je:

(a.) fenil;

(b.) 5- ili 6-člani monociklični heteroaril ili 9- do 10-člani biciklični heteroaril koji sadrži 1 do 3 heteroatoma odabrana između N, O, ili S;

(c.) 5- ili 6-člani monociklični heterociklil koji sadrži 1 do 3 heteroatoma odabrana između N, O, ili S; ili

(d.) C3-C6 cikloalkil;

svaki Ra je nezavisno odabran između halo, cijano, C1-C3 alkil, -O-C1-C3 alkil, okso, ili hidroksi;

Y je:

(a.) veza;

(b.) grupa formule

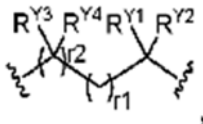

gde su RY1 i RY2 nezavisno H, C1-C3 alkil, hidroksi, fluoro, C1-C3 hidroksialkil, ili amino; ili alternativno RY1 i RY2, zajedno sa atomom ugljenika za koji su prikazani formiraju C3-C6 cikloalkil;

RY3 i RY4 su nezavisno H, C1-C3 alkil, hidroksi, fluoro, ili C1-C3 hidroksialkil; ili alternativno RY3 i RY4, zajedno sa atomom ugljenika za koji su prikazani formiraju C3-C6 cikloalkil;

(c.) grupa formule

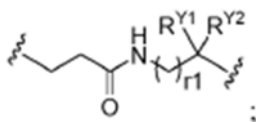

(d.) prsten AH, gde je prsten AH C3-C6 cikloalkil ili fenil, pri čemu je prsten AH nesupstituisan ili je supstituisan sa 1 do 3 komponente nezavisno odabrane između halo ili C1-C3 alkil;

(e.) grupa -CH=CH-; ili

(f.) grupa

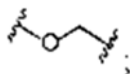

Z je:

(a.) -CO<sub>2</sub>H; (b.) -C(O)N(H)OH; (c.)

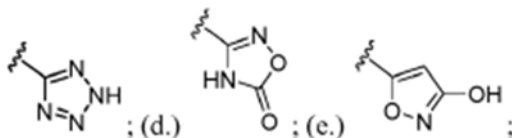

(f.) -SO<sub>3</sub>H; (g.) -P(=O)(OH)<sub>2</sub>; ili (h.) -C(O)N(H)S(O)<sub>2</sub>CH<sub>3</sub>;

donji indeks m je 0, 1, ili 2;

donji indeks p je 0, 1, 2, ili 3;

donji indeks q je 0 ili 1;

donji indeks r<sub>1</sub> je 0, 1, 2, 3, ili 4; i

donji indeks r<sub>2</sub> je 0 ili 1.

**Patent sadrži još 33 patentnih zahtjeva.**

(11) **03749** (13) **B**

(51) **C07J 3/00**<sup>(2006.01)</sup>  
**C07J 43/00**<sup>(2006.01)</sup>  
**A61P 25/08**<sup>(2006.01)</sup>  
**A61K 45/06**<sup>(2006.01)</sup>  
**C07J 33/00**<sup>(2006.01)</sup>  
**C07J 9/00**<sup>(2006.01)</sup>

**C07J 17/00**<sup>(2006.01)</sup>  
**A61K 31/56**<sup>(2006.01)</sup>  
**A61P 25/00**<sup>(2006.01)</sup>  
**C07J 31/00**<sup>(2006.01)</sup>  
**C07J 41/00**<sup>(2006.01)</sup>

(21) P-2020-105

(22) 27.11.2015

(30) PCT/CN2014/092369 27.11.2014 WO

(96) 15862506.1/27.11.2015

(86) CN PCT/CN2015/095765/27.11.2015

(87) WO 2016/082789/02.06.2016/2016/22

(97) EP 3224269/04.10.2017/2017/40

EP 3224269/26.02.2020/2020/09

(54) me **KOMPOZICIJE I POSTUPCI ZA LEČENJE POREMEĆAJA CNS-a**  
en **COMPOSITIONS AND METHODS FOR TREATING CNS DISORDERS**

(73) Sage Therapeutics, Inc.

215 First Street, Cambridge, MA 02142/ US

(72) BOTELLA, Gabriel Martinez

17 Parmenter Road, Wayland, Massachusetts 01778/ US

HARRISON, Boyd L.

9 Wheatston Court, Princeton Junction, New Jersey 08550/ US

ROBICHAUD, Albert Jean

2 Earhart Street 915, Cambridge, Massachusetts 02141/ US

SALITURO, Francesco G.

25 Baker Drive, Marlborough, Massachusetts 01752/ US

BERESIS, Richard Thomas

Apartment 2504, Building 1, 199 Shimen, 2 Road, Shanghai 200040/ CN

(57)

1. Jedinjnjenje Formule (II):

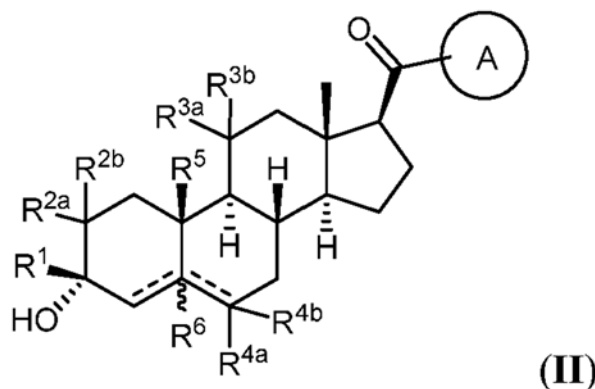

ili njegova farmaceutski prihvatljiva so;

naznačeno time da:

Prsten A je supstituisan ili nesupstituisan aril ili heteroaril;

R1 je vodonik, ili supstituisani ili nesupstituisani C1-6 alkil, supstituisani ili nesupstituisani C2-6 alkenil, supstituisani ili nesupstituisani C2-6 alkinil, ili supstituisani ili nesupstituisani C3-6 karbociklil;

svaki od R2a i R2b je nezavisno izabran od sledećih: vodonik, halogen, supstituisani ili nesupstituisani C1-6 alkil, supstituisani ili nesupstituisani C2-6 alkenil, supstituisani ili nesupstituisani C2-6 alkinil, supstituisani ili nesupstituisani C3-6 karbociklil, supstituisani ili nesupstituisani aril, supstituisani ili nesupstituisani heteroaril, -N(RA)(RB), ili -ORA2,

gde svaki od RA i RB je nezavisno vodonik, supstituisani ili nesupstituisani C1-6 alkil, supstituisani ili nesupstituisani C2-6 alkenil, supstituisani ili nesupstituisani C2-6 alkinil, supstituisani ili nesupstituisani C3-6 karbociklil, supstituisani ili nesupstituisani heterociklil, supstituisani ili nesupstituisani aril, ili supstituisani ili nesupstituisani heteroaril, ili RA i RB, zajedno sa atomom azota za koji su vezani formiraju prsten (npr., heteroaril, heterociklil), ili R2a i R2b, zajedno sa atomom ugljenika za koji su vezani formiraju prsten; RA2 je vodonik ili supstituisani ili nesupstituisani C1-6 alkil, supstituisani ili nesupstituisani C2-6 alkenil, supstituisani ili nesupstituisani C2-6 alkinil, supstituisani ili nesupstituisani C3-6 karbociklil, supstituisani ili nesupstituisani aril, ili supstituisani ili nesupstituisani heteroaril; R3a je vodonik, -N(RA)(RB), ili -ORA3, gde RA3 je vodonik, supstituisani ili nesupstituisani C1-6 alkil, supstituisani ili nesupstituisani C2-6 alkenil, supstituisani ili nesupstituisani C2-6 alkinil, ili supstituisani ili nesupstituisani C3-6 karbociklil supstituisani ili nesupstituisani aril, supstituisani ili nesupstituisani heteroaril, i

R3b je vodonik ili -N(RA)C(O)RA3; ili

R3a i R3b su spojeni da formiraju okso (=O) grupu;

svaki od R4a i R4b je nezavisno izabran od vodonika ili halogena;

R5 je vodonik, nesupstituisani C1-6 alkil, ili -CH2ORA5, gde RA5 je vodonik, supstituisani ili nesupstituisani C1-6 alkil, supstituisani ili nesupstituisani C2-6 alkenil, supstituisani ili nesupstituisani C2-6 alkinil, ili supstituisani ili nesupstituisani C3-6 karbociklil, supstituisani ili nesupstituisani aril, supstituisani ili nesupstituisani heteroaril;

R6 je odsutan ili vodonik; i

-----  
-----

predstavlja prostu ili dvogubu vezu, gde

kada jedan od -----  
-----

je dvoguba veza, druga -----  
-----

je prosta veza; i

kada jedna od -----  
-----

je dvoguba veza, R6 je odsutan.

**Patent sadrži još 13 patentnih zahtjeva**



(11) **03795** (13) **B**

(51) **C07D403/12**<sup>(2006.01)</sup>

**C07D249/08**<sup>(2006.01)</sup>

**A61P35/00**<sup>(2006.01)</sup>

**C07D413/12**<sup>(2006.01)</sup>

**A61P25/00**<sup>(2006.01)</sup>

**A61K31/4196**<sup>(2006.01)</sup>

(21) P-2020-110

(22) 09.05.2013

(30) 201261644802P 09.05.2012 US

201361798188P 15.03.2013 US

(96) 18164757.9/09.05.2013

(97) EP 3404027/21.11.2018/2018/47

EP 3404027/04.03.2020/2020/10

(54) me **MODULATORI NUKLEUSNOG TRANSPORTA I NJIHOVE UPOTREBE**  
en **NUCLEAR TRANSPORT MODULATORS AND USES THEREOF**

(73) Biogen MA Inc.

225 Binney Street, Cambridge, MA 02142/ US

(72) SANDANAYAKA, Vincent, P.

10 Laurel Avenue, Northboro, MA 01532/ US

SHECHTER, Sharon

18 Ivy Lane, Andover, MA 01810/ US

SHACHAM, Sharon

15 Bontempo Road, Newton, MA 02459/ US

MCCAULEY, Dilara

85 Gore Street, Cambridge, MA 02141/ US

BALOGLU, Erkan

8 Benjamin Terrace, Stoneham, MA 02180/ US

(57)

1. Jedinjenje formule I:

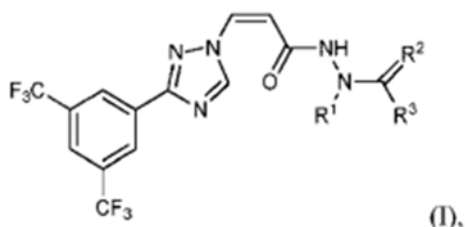

ili njegova farmaceutski prihvatljiva so, solvat ili hidrat, naznačeni time, što:

R1 se bira između vodonika i C1-C4 alkil;

R2 je O; i

R3 se bira između -N(R4)-(C3-C6 cikloalkil), -C1-C6 alkil, -(C0-C4 alkilen)-heterociklil, i -(C0-C4 alkilen)-heteroaril, gde je bilo koji alkil, alkilen, heterociklil, i heteroaril deo R3 opciono i nezavisno supstituisan; i

R4 se bira između vodonika i C1-C4 alkil.

**Patent sadrži još 14 patentnih zahtjeva**

(11) **03789** (13) **B**

(51) **C07K 14/47**<sup>(2006.01)</sup>

**A61K 48/00**<sup>(2006.01)</sup>

**A61K 38/37**<sup>(2006.01)</sup>

**C12N 15/86**<sup>(2006.01)</sup>

**C07K 14/755**<sup>(2006.01)</sup>

(21) P-2020-114

(22) 23.04.2015

(30) 20140009089 21.05.2014 GB

(96) 15720762.2/23.04.2015

(86) GB PCT/GB2015/051201/23.04.2015

(87) WO 2015/177501/26.11.2015/2015/47

(97) EP 3145949/29.03.2017/2017/13

EP 3145949/08.04.2020/2020/15

(54) me **LENTIVIRUSNI VEKTORI**

en **LENTIVIRAL VECTORS**

(73) IP2IPO Innovations Limited

Top Floor, The Walbrook Building, 25 Walbrook, London EC4N 8AF/ GB

ID Pharma Co., Ltd.

Techno Park Oho, 6 Ohkubo, Tsukuba-shi, Ibaraki 300-2611/ JP

(72) ALTON, Eric Walter Frederick Wolfgang

National Heart and Lung Institute, Emmanuel Kaye Building, Manresa Road, London Greater London SW3 6LR/ GB

GRIESENBACH, Uta

14 Hornbeam Terrace, Carshalton Greater London SM5 1RU/ GB

PYTEL, Kamila Malgorzata

7 Hylde Court, 3 - 5 St Albans Road, London Greater London NW5 1RE/ GB

PAUL-SMITH, Michael Christian

Flat 4, 26 Alexandra Grove, London Greater London N4 2LF/ GB

PRINGLE, Ian Andrew

John Radcliffe Hospital (Level 4), University of Oxford, Oxford Oxfordshire OX3 9DU/ GB

HYDE, Stephen Charles

John Radcliffe Hospital (Level 4), University of Oxford, Oxford Oxfordshire OX3 9DU/ GB

GILL, Deborah Rebecca

John Radcliffe Hospital (Level 4), University of Oxford, Oxford Oxfordshire OX3 9DU/ GB

DAVIES, Lee Adrian

5 Town Furlong, Appleton, Abingdon Oxfordshire OX13 5JW/ GB

BOYD, Alan Christopher

115 Greenbank Road, Edinburgh Lothian EH10 5RR/ GB

MCLACHLAN, Gerard

26 Lyne Park, West Linton Peeblesshire EH46 7HP/ GB

INOUE, Makoto

6 Ohkubo, Tsukuba Ibaraki 300-2611/ JP

(57)

1. Lentivirusni vektor pseudoklasifikovan sa hemaglutinin-neuraminidazom (HN) i spojenim (F) proteinima iz respiratornog paramiksovirusa, pri čemu navedeni lentivirusni vektor sadrži hibridni humani CMV ojačani/EF1a (hCEF) promoter i transgen, i pri čemu lentivirusni vektor nedostaje bilo koji intron pozicioniran između navedenog promotera i navedenog transgena.

**Patent sadrži još 12 patentnih zahtjeva**

(11) **03745** (13) **B**

(51) **C07D 401/12**<sup>(2006.01)</sup>

**A61P 9/00**<sup>(2006.01)</sup>

**A61P 29/00**<sup>(2006.01)</sup>

**A61K 31/4439**<sup>(2006.01)</sup>

**A61P 17/00**<sup>(2006.01)</sup>

**A61P 35/00**<sup>(2006.01)</sup>

(21) P-2020-115

(22) 25.11.2015

(30) 2014014195032 26.11.2014 EP

(96) 15800828.4/25.11.2015

(86) EP PCT/EP2015/077596/25.11.2015

(87) WO 2016/083433/02.06.2016/2016/22

(97) EP 3224254/04.10.2017/2017/40

EP 3224254/15.04.2020/2020/16

(54) me **SUPSTITUISANI INDAZOLI, POSTUPAK ZA NJIHOVO DOBIJANJE, FARMACEUTSKI PREPARATI, KOJI-IH SADRŽE, KAO I NJIHOVA UPOTREBA ZA PROIZVODNJU LEKOVA**  
en **SUBSTITUTED INDAZOLES, PROCESS FOR THEIR PREPARATION, PHARMACEUTICAL FORMULATIONS CONTAINING THEM, AND THEIR USE FOR THE PREPARATION OF MEDICAMENTS**

(73) BAYER PHARMA AKTIENGESELLSCHAFT

Müllerstrasse 178, Berlin, 13353 / DE

(72) BOTHE, Ulrich

Kavalierstr. 15, 13187 Berlin/ DE

SIEBENEICHER, Holger

Kruppstr. 18, 10557 Berlin/ DE

SCHMIDT, Nicole

455 Mission Bay Blvd. South, San Francisco, CA 94158/ US

NUBBEMEYER, Reinhard

Moorweg 96, 13509 Berlin/ DE

BÖMER, Ulf

Leipziger Str. 49, 16548 Glienicke/ DE

GÜNTHER, Judith

Parkstr. 60, 13187 Berlin/ DE

STEUBER, Holger

Hannoversche Strasse 19A, 10115 Berlin/ DE

LANGE, Martin

Straßburger Str. 9K, 10405 Berlin/ DE

STEGMANN, Christian

Schliemannstr. 39, 10437 Berlin/ DE

SUTTER, Andreas

Pistoriusstr. 7, 13086 Berlin/ DE

RAUSCH, Alexandra

Schönhauser Str. 54C, 13158 Berlin/ DE

HAUFF, Peter

Erich-Nehlhans-Str. 30, 10247 Berlin/ DE

FRIEDRICH, Christian

Altstädtische Fischerstr. 17, 14770 Brandenburg/ DE

(57)

1. Jedinjenja opšte formule (I)

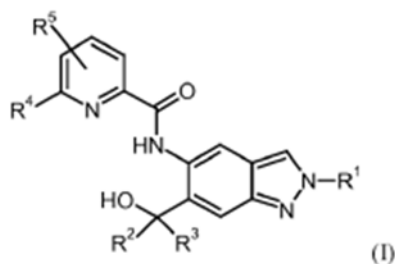

u kojoj:

R1 predstavlja C1-C6 alkil, pri čemu je C1-C6 alkil grupa nesupstituisana ili jednostruko ili višestruko supstituisana, jednako ili različito pomoću halogena, hidroksila, nesupstituisanog ili jednostruko ili višestruko halogenom supstituisanog C3-C6 cikloalkila, ostatkom R6 ili R8O ili grupu izabranu između:

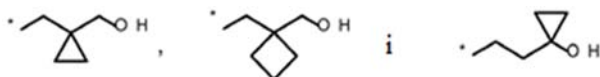

pri čemu \* predstavlja mesto vezivanja grupe na ostatak molekula;

R2 i R3 uvek imaju istu definiciju i oba su bilo vodonik ili C1-C6-alkil;

R4 predstavlja halogen, cijano, nesupstituisan ili jednostruko ili višestruko, identično ili različito supstituisan C1-C6-alkil ili nesupstituisan ili jednostruko ili višestruko, identično ili različito supstituisan C3-C6-cikloalkil, i ti supstituenti su izabrani iz grupe halogena i hidroksila;

R5 predstavlja vodonik, halogen, ili nesupstituisani ili jednostruko ili višestruko halogenom supstituisani C1-C6-alkil;

R6 je nesupstituisani ili jednostruko ili di-metilom supstituisani monociklični zasićeni heterociklus koji ima 4 do 6 atoma u prstenu, koji obuhvata heteroatom ili heterogrupu iz grupe O, S, SO i SO<sub>2</sub>;

R8 predstavlja C1-C6-alkil, pri čemu C1-C6-alkilna grupa jeste nesupstituisana ili jednostruko ili višestruko, jednako ili različito supstituisana halogenom;

i njihove diastereomere, enantiomere, njihove soli, njihove solvate ili solvate njihovih soli.

**Patent sadrži još 18 patentnih zahtjeva.**

(11) **03746** (13) **B**

(51) **G16B 15/20**<sup>(2019.01)</sup>

(21) P-2020-116

(22) 25.11.2013

(30) 20120194206 26.11.2012 EP

(96) 13796039.9/25.11.2013

(86) EP PCT/EP2013/074556/25.11.2013

(87) WO 2014/080005/30.05.2014/2014/22

(97) EP 2923291/30.09.2015/2015/40

EP 2923291/27.05.2020/2020/22

(54) me **ODREĐIVANJE NIVOA ENZIMSKIH FUKNCIONALNOSTI KORIŠĆENJEM TRODIMENZIONALNIH OBLAKA TAČKI PREDSTAVLJAJUĆI FIZIČKO-HEMIJSKA SVOJSTVA PROTEINSKIH ŠUPLJINA**  
en **DETERMINING NOVEL ENZYMATIC FUNCTIONALITIES USING THREE-DIMENSIONAL POINT CLOUDS REPRESENTING PHYSICO CHEMICAL PROPERTIES OF PROTEIN CAVITIES**

(73) Innophore GmbH

Am Eisernen Tor 3, 8010 Graz/ AT

(72) GRUBER, Karl

Artur-Michlgasse 23/27, A-8042 Graz/ AT

STEINKELLNER, Georg

Kainach 81, A-8573 Kainach/ AT

GRUBER, Christian

Stubenbergweg 12, A-8160 Weiz/ AT

(57)

1. Metod skrininga za katalizator predutvrđene hemijske reakcije, obuhvatajući korake:

a) utvrđivanje fizičko-hemijskih svojstava na lokacijama mrežnih voksela, pri čemu mreža uključuje šupljinu aktivnog mesta prvog enzima, kako bi se dobio upit oblaka tački za svaki tip fizičko-hemijskog svojstva, pri čemu fizičko-hemijska svojstva su potencijalne energije nevezujućih H atoma, izabrane od sumpora, hlora, kalcijuma, mangana, gvožđa, cinka, broma, joda, fluora, magnezijuma, fosfora, alifatičnog ugljenika, aromatičnog ugljenika, azota i vodonika, potencijalne energije prijemnika H-veze, izabrane od azota, sumpora i kiseonika, potencijalne energije donora H-veze, kao vodonik, elektrostatički potencijal, hidrofobnost, i pristupačnost

b) kreiranje baze podataka oblaka tačke odgovarajućih oblaka tački za šupljine aktivnog mesta predodređenih proteina;

c) pretraživanje baze podataka sa upitom oblaka tački kako bi se time identifikovao jedan od predutvrđenih proteina koji ima šupljinu aktivnog mesta koja se podudara sa šupljinom aktivnog mesta prvog enzima, na taj način identifikujući drugi enzim kao katalizator, upoređivanjem upita oblaka tački sa odgovarajućim oblacima tački iz baze podataka oblaka tačke,

pri čemu

korak d) obuhvata isticanje upita oblaka tački i odgovarajućih oblaka tački iz baze podataka oblaka tačke, upoređivanje obuhvata poređenje fizičko-hemijskih svojstava na mrežnim vokselima upita oblaka tački sa fizičko-hemijskim svojstvima na najbližim mrežnim vokselima odgovarajućih oblaka tački iz baze podataka oblaka tačke i generisanje individualne ocene identičnosti

koja predstavlja kvalitet podudaranja za svako fizičko-hemijsko svojstvo, i generisanje ocene identičnosti kao procenjena suma individualnih ocena identičnosti.

**Patent sadrži još 1 patentnih zahtjeva**

(11) **03747** (13) **B**

(51) **A61K 31/19**<sup>(2006.01)</sup>

**A61K 31/185**<sup>(2006.01)</sup>

**A61P 25/00**<sup>(2006.01)</sup>

**A61K 31/192**<sup>(2006.01)</sup>

**A61K 31/195**<sup>(2006.01)</sup>

**A61P 25/28**<sup>(2006.01)</sup>

**A61K 31/575**<sup>(2006.01)</sup>

(21) P-2020-117

(22) 24.02.2014

(30) 201361804690 P 24.03.2013 US  
201314140083 24.12.2013 US

(96) 14775675.3/24.02.2014

(86) US PCT/US2014/018040/24.02.2014

(87) WO 2014/158547/02.10.2014/2014/40

(97) EP 2978419/03.02.2016/2016/05  
EP 2978419/15.04.2020/2020/16

(54) me **KOMPOZICIJE ZA POBOLJŠANJE ĆELIJSKE VIJABILNOSTI I POSTUPCI ZA NJIHOVU UPOTREBU**  
en **COMPOSITIONS FOR IMPROVING CELL VIABILITY AND METHODS OF USE THEREOF**

(73) Amylyx Pharmaceuticals Inc.

43 Thorndike St, Cambridge, MA 02141/ US

(72) COHEN, Joshua B.

118 Huntington Ave Apt. 306, Boston, Massachusetts 02116-5760/ US

KLEE, Justin

169 Monsignor O'Brien Highway No.403, Cambridge, Massachusetts 02141/ US

(57)

1. Kompozicija koja obuhvata efikasnu količinu tauroursodezoksiholinske kiseline (TUOCA) ili njenu farmaceutski prihvatljivu so, i efikasnu količinu 4-fenilbuteme kiseline (4-PBA) ili njenu farmaceutski prihvatljivu so, za upotrebu u postupku lečenja subjekta koji ima oboljenje ili je u riziku od neurodegenerativnog oboljenja.

**Patent sadrži još 15 patentnih zahtjeva.**

(11) **03750** (13) **B**

(51) **A61K 9/48**<sup>(2006.01)</sup>

(21) P-2020-118

(22) 22.03.2012

(30) MI20110445 22.03.2011 IT

(96) 16202982.1/22.03.2012

(97) EP 3178474/14.06.2017/2017/24

EP 3178474/18.03.2020/2020/12

(54) me **FARMACEUTSKA FORMULACIJA KOJA SADRŽI INOZITOL**  
en **PHARMACEUTICAL FORMULATION COMPRISING INOSITOL**

(73) LO. LI. Pharma S.r.l.

Via dei Luxardo 33, 00156 Roma/ IT

(72) UNFER, Vittorio

Via Cesare Massini 43, 00155 Rome/ IT

(57)

1. Meka kapsula koja se sastoji od omotača na bazi želatina i punjenja navedenog omotača, gde navedeno punjenje sadrži rastvor, suspenziju ili disperziju aktivnih sastojaka, pri čemu su navedeni aktivni sastojci:

- inozitol; i
- najmanje jedno od folne kiseline, polifenola kaka, genisteina, L-arginina, vitamina E, selena, N-acetilcisteina i melatonina;

u vehikulumu koji sadrži želatin, glicerol, etanol ili njihove smeše, pri čemu je navedeni inozitol mio-inozitol.

**Patent sadrži još 6 patentnih zahtjeva.**



(11) **03751** (13) **B**

(51) **A61P 25/28**<sup>(2006.01)</sup>

**C07K 16/18**<sup>(2006.01)</sup>

(21) P-2020-119

(22) 15.10.2013

(30) 201261713996 P 15.10.2012 US

(96) 13805277.4/15.10.2013

(86) EP PCT/EP2013/071567/15.10.2013

(87) WO 2014/060444/24.04.2014/2014/17

(97) EP 2906597/19.08.2015/2015/34

EP 2906597/08.04.2020/2020/15

(54) me **ANTITELA USMERENA NA BETA-AMILOID**  
en **ANTIBODIES TO AMYLOID BETA**

(73) Medimmune Limited

Milstein Building Granta Park, Cambridge, Cambridgeshire CB21 6GH/ GB

(72) GROVES, Maria

Milstein Building, Granta Park, Cambridge Cambridgeshire CB21 6GH/ GB

GUSTAVSSON, Suzanne

Fågelvägen 14, S-14140 Huddinge/ SE

HÖGLUND, Kina

Tomtebodavägen 23B, Floor 4, S-171 65 Solna/ SE

LOWNE, David

Milstein Building Granta Park, Cambridge Cambridgeshire CB21 6GH/ GB

LLOYD, Chris

Milstein Building, Granta Park, Cambridge Cambridgeshire CB21 6GH/ GB

NICKSON, Adrian

University of Cambridge, Lensfield Road, Cambridge Cambridgeshire CB1 2EW/ GB

NIVA, Camilla

Tavelsjovägen 20, S-120 59 Arsta/ SE

SIMON, Sylvia

Ingenjörsvägen 40, S-11759 Stockholm/ SE

(57)

1. Molekul antitela usmeren na humani A $\beta$ 1-42, naznačen time što molekul antitela sadrži VH domen i VL domen, gde VH domen sadrži aminokiselinsku sekvencu SEQ ID NO: 524 i gde VL domen sadrži aminokiselinsku sekvencu SEQ ID NO: 533.

**Patent sadrži još 5 patentnih zahtjeva.**

(11) **03790** (13) **B**

(51) **C07K 19/00**<sup>(2006.01)</sup>

**A61K 9/19**<sup>(2006.01)</sup>

**C07K 14/16**<sup>(2006.01)</sup>

**A61K 47/18**<sup>(2017.01)</sup>

**A61K 38/16**<sup>(2006.01)</sup>

**A61P 9/10**<sup>(2006.01)</sup>

**A61K 47/12**<sup>(2006.01)</sup>

**A61K 38/10**<sup>(2006.01)</sup>

(21) P-2020-120

(22) 28.05.2015

(30) 201462004142 P 28.05.2014 US

(96) 15799583.8/28.05.2015

(86) IB PCT/IB2015/053995/28.05.2015

(87) WO 2015/181756/03.12.2015/2015/48

(97) EP 3149048/05.04.2017/2017/14

EP 3149048/29.01.2020/2020/05

(54) me **HLORIDNA SO TAT-NR2B9C**

en **CHLORIDE SALT OF TAT-NR2B9C**

(73) NoNO Inc.

479A Wellington St. W, Toronto, ON M5V 1E7/ CA

(72) GARMAN, Jonathan David

148 Lawrie Road, Thornhill, Ontario L4J8N1/ CA

(57)

1. Hloridna so peptida koja je TAT-NR2B9c (SEK ID BR: 6) Hi se razlikuje od TAT-NR2B9c za do 5 supstitucija aminokiselina, umetanjem ili brisanjem, pri čemu su anjoni veći od 99 % u hloridnoj soli.

**Patent sadrži još 14 patentnih zahtjeva.**

(11) **03755** (13) **B**

(51) **A61K 39/395**<sup>(2006.01)</sup>

**C12N 15/13**<sup>(2006.01)</sup>

**C12P 21/08**<sup>(2006.01)</sup>

**C12N 1/19**<sup>(2006.01)</sup>

**C07K 16/40**<sup>(2006.01)</sup>

**C12N 15/63**<sup>(2006.01)</sup>

**C12N 5/10**<sup>(2006.01)</sup>

(21) P-2020-121

(22) 04.05.2012

(30) 201161482567 P 04.05.2011 US

(96) 12779347.9/04.05.2012

(86) US PCT/US2012/036509/04.05.2012

(87) WO 2012/151481/08.11.2012/2012/45

(97) EP 2704743/12.03.2014/2014/11

EP 2704743/11.03.2020/2020/11

(54) me **KOMPOZICIJE ZA INHIBICIJU MASP-2 ZAVISNE AKTIVACIJE KOMPLEMENTA**  
en **COMPOSITIONS FOR INHIBITING MASP-2 DEPENDENT COMPLEMENT ACITIVATION**

(73) Omeros Corporation

201 Elliott Avenue West, Seattle, WA 98119/ US

(72) , DUDLER, Thomas

13410 NE 36th Street, Bellevue, WA 98005/ US

, GOMBOTZ, Wayne, R.

15545 61st Avenue NE, Kenmore, WA 98028/ US

, PARENT, James, Brian

P.O. Box 10278, Bainbridge Island, WA 98110/ US

, TEDFORD, Clark, E.

4058 NE Lookout Lane, Poulsbo, WA 98370/ US

, KAVLIE, Anita

Stromsborgveien 39H, N-0287 Oslo/ NO

, HAGEMANN, Urs, Beat

Nydalen Alle 29, N-0484 Oslo/ NO

, REIERSEN, Herald

Njards Veo 5C, N-1412 Sofiemyr/ NO

, KIPRIJANOV, Sergej

Hovseterveien 98, N-0768 Oslo/ NO

(57)

1. Izolovano humano monoklonsko antitelo, iii njegov antigen vezujuci fragment, koji vezuje humani MASP-2 i inhibira MASP-2 zavisnu aktivaciju komplementa, pri cemu antitelo iii njegov antigen vezujuci fragment sadri:i:

a) varijabilni region teskog lanca koji sadri:i aminokiselinu navedenu u

SEQ 10 NO: 20; i

b) varijabilni region lakog lanca koji sadri:i aminokiselinsku sekvencu navedenu u SEQ 10 NO: 24.

**Patent sadrži još 10 patentnih zahtjeva.**

(11) **03742** (13) **B**

(51) **A61K 9/50**<sup>(2006.01)</sup>

**A61K 31/573**<sup>(2006.01)</sup>

(21) P-2020-122

(22) 12.02.2013

(30) 201202433 13.02.2012 GB

201261599704 P 16.02.2012 US

201261600958 P 20.02.2012 US

(96) 13709499.1/12.02.2013

(86) GB PCT/GB2013/050311/12.02.2013

(87) WO 2013/121184/22.08.2013/2013/34

(97) EP 2814469/24.12.2014/2014/52

EP 2814469/08.04.2020/2020/15

(54) me **FORMULACIJA OSLOBAĐANJA KONTROLISANOM HIDROKORTIZONOM**

en **HYDROCORTISONE CONTROLLED RELEASE FORMULATION**

(73) Diurnal Limited

Cardiff MediCentre, Heath Park Cardiff CF14 4UJ/ GB

(72) HUATAN, Hiep

Diurnal Limited Cardiff MediCentre Health Park, Cardiff CF14 4UJ/ GB

ROSS, Richard

Diurnal Limited Cardiff MediCentre Health Park, Cardiff CF14 4UJ/ GB

WHITAKER, Martin

Diurnal Limited Cardiff MediCentre Health Park, Cardiff CF14 4UJ/ GB

(57)

1. Farmaceutska kompozicija adaptirana za oralnu primjenu koja sadrži: jezgro koje sadrži hidrokortizon i nosac i navedeno jezgro koje dodiruje sloj koji sadrži polimer sa odloženim oslobađanjem pri čemu polimer sa odloženim oslobađanjem u osnovi sadrži smesu poli(metakrilne kiseline, metilmetakrilata) u odnosu 1:2 i poli (metakrilna kiselina, metilmetakrilat) u odnosu 1:1 i prilagodan da odloži oslobađanje hidrokortizona iz navedenog jezgra naznačeno time da jezgro sadrži čestice mikrokristalne celuloze, naznačeno time, da je preeničnik navedenih čestica između 2001Jm-12001Jm i iznosi 75-85% tež/tež kompozicije.

**Patent sadrži još 15 patentnih zahtjeva**

(11) **03741** (13) **B**

(51) **C07C 303/32**<sup>(2006.01)</sup>

**C07C 233/18**<sup>(2006.01)</sup>

(21) P-2020-125

(22) 28.07.2014

(30) PCT/CN2013/080337 29.07.2013 WO  
1360124 17.10.2013 FR

(96) 14758162.3/28.07.2014

(86) FR PCT/FR2014/051944/28.07.2014

(87) WO 2015/015102/05.02.2015/2015/05

(97) EP 3027588/08.06.2016/2016/23

EP 3027588/01.04.2020/2020/14

(54) me **KONPLEKSI AGOMELATINA I SULFONSKIH KISJELINA, POSTUPAK NJIHOVE PROIZVODNJE I PROIZVODNJE FARMACEUTSKIH PRIPRAVAKA KOJI IH SADRŽAVAJU**  
en **COMPLEXES OF AGOMELATINE AND SULPHONIC ACIDS, METHOD FOR PREPARING SAME AND THE PHARMACEUTICAL COMPOSITIONS CONTAINING THEM**

(73) Les Laboratoires Servier

35, Rue de Verdun, 92284 Suresnes/ FR

Shanghai Institute Of Pharmaceutical Industry

No.1320 West Beijing Road, Jing'an District/ CN

(72) SHAN, Hanbin

24 Dongfangxincun Gaoan, Gaoan Jiangxi 330800/ CN

SHEN, Yuhui

Room 603 Lane 358 n° 30 Sanmen Road, Shanghai 200439/ CN

LUO, Ying

Room 803 Unit 4 J1 Building Xian Shi Garden, Nan Chang Jiangxi 300006/ CN

LETELLIER, Philippe

25 Rue du Faubourg Saint Jean, F-45000 Orléans/ FR

LYNCH, Michael

74 Rue des Chaises, F-45140 Saint Jean de la Ruelle/ FR

(57) Kompleksi agomelatina i sulfonske kiseline, **naznačeni time**, da su predstavljeni formulom (I):

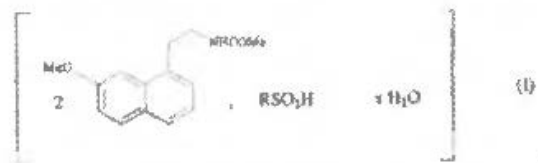

Pri čemu je x 0 ili 1, a RSO<sub>3</sub>H predstavlja 1,5-naftalendisulfonsku kiselinu ili benzensulfonsku kiselinu

**Patent sadrži još 15 patentnih zahtjeva**

(11) **03757** (13) **B**

(51) **C07H 15/26**<sup>(2006.01)</sup>  
**A61K 31/7052**<sup>(2006.01)</sup>

**C07D 487/04**<sup>(2006.01)</sup>

**A61P 1/04**<sup>(2006.01)</sup>

(21) P-2020-126

(22) 22.11.2016

(30) 201562259273 P 24.11.2015 US

(96) 16808876.3/22.11.2016

(86) US PCT/US2016/063254/22.11.2016

(87) WO 2017/091544/01.06.2017/2017/22

(97) EP 3380486/03.10.2018/201840

EP 3380486/19.02.2020/202008

(54) me **PROLEKOVI JAKI INHIBITORNIH JEDINJENJA ZA LEČENJE GASTORINTESTINALNE INFLAMATORNE BOLESTI**

en **PRODRUGS OF A JAK INHIBITOR COMPOUND FOR TREATMENT OF GASTROINTESTINAL INFLAMMATORY DISEASE**

(73) THERAVANCE BIOPHARMA R&D IP, LLC

901 Gateway Boulevard, South San Francisco, CA 94080/ US

(72) HUDSON, Ryan

1454 Walbrook Drive, San Jose, California 95129/ US

LONG, Daniel D.

10 Sunview Drive, San Francisco, California 94131/ US

WILTON, Donna A.A.

181 Fair Oaks Street, San Francisco, California 94110/ US

LOO, Mandy

2119 Imwalle Court, San Jose, California 95131/ US

BRASSIL, Patrick J.

1215 Chantal Way, Redwood City, California, CA 94061/ US

(57)

I. Jedinjenje formule (I):

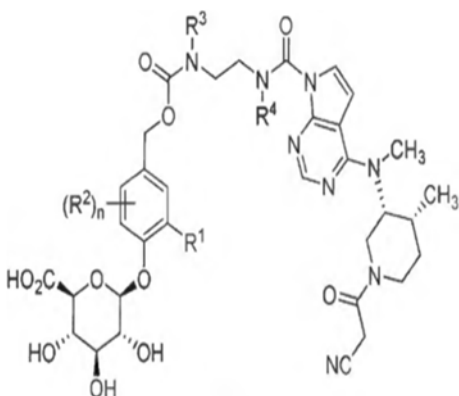

(I)  
gde

$n$  je 0,1 ili 2;

$R^1$  je izabran od vodonika,  $C_{1-4}$  alkil,  $C_{1-3}$  alkoksi, amino, nitro, halo, cijano, hidroksi triflurometil grupe;  
svaki  $R^2$ , kada je prisutan, nezavisno je izabran od  $C_{1-4}$  alkil,  $C_{1-3}$  alkoksi, amino, nitro, halo, cijano, hidroksi i triflurometil grupe;  
 $R^3$  je vodonik, metil ili etil;  $R^4$  je vodonik, metil ili etil;  
ili njegova farmaceutski prihvatljiva so.

**Patent sadrži još 21 patentnih zahtjeva**

(11) **03841** (13) **B**

(51) **C07K 16/18**<sup>(2006.01)</sup>

**A61K 39/35**<sup>(2006.01)</sup>

**A61P 37/08**<sup>(2006.01)</sup>

(21) P-2020-127

(22) 02.05.2013

(30) 201261642083 P 03.05.2012 US

201261718044 P 24.10.2012 US

201361783312 P 14.03.2013 US

(96) 13721544.8/02.05.2013

(86) US PCT/US2013/039192/02.05.2013

(87) WO 2013/166236/07.11.2013/2013/45

(97) EP 2844672/11.03.2015/2015/11

EP 2844672/12.02.2020/2020/07

(54) me **HUMANA ANTITELA NA FEL D1 I POSTUPCI NJIHOVE UPOTREBE**  
en **HUMAN ANTIBODIES TO FEL D1 AND METHODS OF USE THEREOF**

(73) REGENERON PHARMACEUTICALS, INC.

777 Old Saw Mill River Road, Tarrytown NY 10591/ US

(72) ORENGO, Jamie

600 West 122nd Street Apartment 216, New York, NY 10027/ US

MURPHY, Andrew J.

10 Newton Court, Croton-on-Hudson, NY 10520/ US

(57)

1. Izolovano humano monoklonsko antitelo, iii njegov fragment koji vezuje antigen, koje se specifčno vezuje za macji alergen Fel d1, pri cemu:

antitelo iii fragment koji vezuje antigen sadrzi: (i) HCVR sa aminokiselinskom sekvencom navedenom u SEQ ID NO: 18; i (ii) LCVR sa aminokiselinskom sekvencom navedenom u SEQ ID NO: 26; a

pri cemu je antitelo iii fragment koji vezuje antigen izotipa razlicitog od IgA izotipa.

**Patent sadrži još 9 patentnih zahtjeva**



(11) **03759** (13) **B**

(51) **C07D 471/04**<sup>(2006.01)</sup>

**A61K 31/407**<sup>(2006.01)</sup>

**A61P 35/00**<sup>(2006.01)</sup>

**A61P 13/12**<sup>(2006.01)</sup>

**C07D 487/04**<sup>(2006.01)</sup>

**A61K 31/437**<sup>(2006.01)</sup>

**A61P 31/18**<sup>(2006.01)</sup>

**A61P 3/10**<sup>(2006.01)</sup>

(21) P-2020-128

(22) 14.12.2020

(30) PCT/CN2016/079362 15.04.2016 WO

(96) 17781931.5/14.04.2017

(86) CN PCT/CN2017/080511/14.04.2017

(87) WO 2017/177955/19.10.2017/2017/42

(97) EP 3442972/20.02.2019/2019/08

EP 3442972/04.03.2020/2020/10

(54) me **INHIBITORI BROMODOMENA**  
en **BROMODOMAIN INHIBITORS**

(73) AbbVie Inc.

1 North Waukegan Road, North Chicago, IL 60064/ US

(72) FIDANZE, Steven D.

320 Rock Hall Circle, Grayslake Illinois 60030/ US

HASVOLD, Lisa A.

552 Shakespeare Drive, Grayslake Illinois 60030/ US

LIU, Dachun

1276 Georgetown Way, Vernon Hills Illinois 60061/ US

MCDANIEL, Keith F.

26029 W. Laurel Court, Wauconda Illinois 60084/ US

PRATT, John

8210 61st Avenue, Kenosha Wisconsin 53142/ US

SCHRIMPF, Michael

327 Cambridge Dr., Grayslake Illinois 60030/ US

SHEPPARD, George S.

807 Locust Road, Wilmette Illinois 60091/ US

WANG, Le

338 East Colonial Drive, Vernon Hills Illinois 60061/ US

LI, Bing

c/o AbbVie Inc. 1 N. Waukegan Road, North Chicago Illinois 60064/ US

(57)

1. N-etil-4-[2-(4-fluoro-2,6-dimetilfenoksi)-5-(2-hidroksipropan-2-il)fenil]-6-metil-7-okso- 6,7-dihidro-1H-pirololo[2,3-c]piridin-2-karboksamid, iii njegova farmaceutska prihodljiva so.

**Patent sadrži još 1 patentnih zahtjeva**

(11) **03804** (13) **B**

(51) **A61K 31/27**<sup>(2006.01)</sup>  
**A61K 31/454**<sup>(2006.01)</sup>  
**C07D 401/04**<sup>(2006.01)</sup>  
**C07D 249/06**<sup>(2006.01)</sup>

**A61K 31/41**<sup>(2006.01)</sup>  
**C07D 401/14**<sup>(2006.01)</sup>  
**A61K 31/4192**<sup>(2006.01)</sup>

(21) P-2020-141

(22) 20.06.2017

(30) 201662352792 P 21.06.2016 US

(96) 17734594.9/20.06.2017

(86) US PCT/US2017/038216/20.06.2017

(87) WO 2017/223016/28.12.2017/2017/52

(97) EP 3472148/24.04.2019/2019/17

EP 3472148/11.03.2020/2020/11

(54) me **KARBAMOILOKSIMETIL TRIAZOL CIKLOHEKSILNE KISELINE KAO ANTAGONISTI LPA**  
en **CARBAMOYLOXYMETHYL TRIAZOLE CYCLOHEXYL ACIDS AS LPA ANTAGONISTS**

(73) Bristol-Myers Squibb Company

Route 206 and Province Line Road , Princeton, NJ 08543 / US

(72) CHENG, Peter, Tai, Wah

350 Carter Road, Hopewell, NJ 08540/ US

KALTENBACH, Robert, F., III

350 Carter Road, Hopewell, NJ 08540/ US

LI, Jun

350 Carter Road, Hopewell, NJ 08540/ US

SHI, Jun

350 Carter Road, Hopewell, NJ 08540/ US

SHI, Yan

350 Carter Road, Hopewell, NJ 08540/ US

TAO, Shiwei

c/o Bristol-Myers Squibb Company 350 Carter Road, Hopewell, NJ 08540/ US

ZHANG, Hao

350 Carter Road, Hopewell, NJ 08540/ US

DHANUSU, Suresh

Biocon Special Economic Zone Biocon Park Plot No. 2&3 Bommasandra Industrial Area IV Phase Jigani Link Road  
Bommasandra, Bangalore 560099 Karnataka/ IN

SELVAKUMAR,, Kumaravel

Biocon Special Economic Zone Biocon Park Plot No. 2&3 Bommasandra Industrial Area IV Phase Jigani Link Road  
Bommasandra, Bangalore 560 099 Karnataka/ IN

REDDIGUNTA, Ramesh Babu

26 Iruvaram Village and Post Chittoor District Andhra Pradesh, Indha Pin 517128/ IN

WALKER, Steven J.

Route 206 and Province Line Road, Princeton, NJ 08543/ US

KENNEDY, Lawrence J.

350 Carter Road, Hopewell, NJ 08540/ US

CORTE, James R.

350 Carter Road, Hopewell, NJ 08540/ US

FANG , Tianan

350 Carter Road, Hopewell, NJ 08540/ US

JUSUF, Sutjano

350 Carter Road, Hopewell, NJ 08540/ US

(57)

## 1. Jedinjenje prema formuli (I)

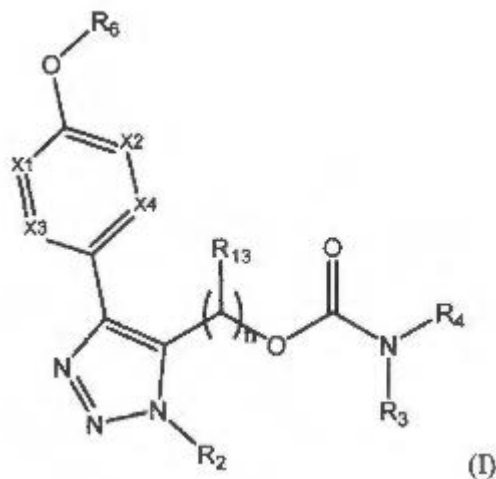

ili stereoisomeri, tautomeri, farmaceutski prihvatljive soli iiii solvati istog, gde

R2 je nezavisno odabran od H i C1-4 alkila supstituisanog sa 1-5 R9;

R13 je nezavisno odabran od H, D, i C1-4 alkila supstituisanog sa 1-3 R9;

R3 i R4 su nezavisno odabrani od H, C1-7 alkila supstituisanog sa 1-3 R9, -(CR7R7)<sub>r</sub>-C3-8 cikloalkila supstituisanog sa 1-3 R8, -(CR7R7)<sub>r</sub>-arila supstituisanog sa 1-3 R8, C2-7alkenila supstituisanog sa 1-3 R9, -(CR7R7)<sub>r</sub>-5-6 članog heterociklicnog prstena supstituisanog sa 1-3 R8, -

(CR7R7)<sub>r</sub>-5-6 članog heteroarilnog prstena supstituisanog sa 1-3 R8, ili R3 i R4 se kombinuju sa N za koji su vezani da formiraju 4-9 člani heterociklicni prsten supstituisan sa 1-3 R8;

X1, X2, X3, i X4 su nezavisno odabrani od CR5 i N; pod uslovom da ne više od dva od X1, X2, X3, i X4 ili X4 su N;

R5 je nezavisno odabran od H, F, Cl, OR7, CN, N(R7)<sub>2</sub>, C1-4 alkila supstituisanog sa 1-5 R9, C1-4 alkoksi grupe supstituisane sa 1-5 R9, i C1-4 heteroalkila supstituisanog sa 1-5 R9;

R6 je C3-8 cikloalkil koji je supstituisan sa R10 i (-CH<sub>2</sub>)<sub>0-1</sub>R11;

R7 je nezavisno odabran od H, C1-4 alkila, i C3-6 cikloalkila; ili R7 i R7, zajedno sa atomom ugljenika za koji se oba vezuju, formiraju C3-6 cikloalkilni prsten;

R8 je nezavisno odabran od H, D, C1-6 alkila supstituisanog sa 1-5 R9, C2-6 alkenila, C2-6 alkinila, fenila, -(CH<sub>2</sub>)<sub>r</sub>-C3-6 cikloalkila, F, Cl, Br, CN, COOH, i C1-4 alkoksi grupe;

R9 je nezavisno odabran od H, D, F, Cl, NH<sub>2</sub>, OH, OC1-5alkila, C1-5alkila, C1-5 heteroalkil C3-6 cikloalkila, i fenila, gde kada R9 je Cl, NH<sub>2</sub> ili OH on nije supstituisan na C1 alkila za koji je vezan;

R10 je nezavisno odabran od H, D, C1-4 alkila, F, Cl, Br, OR7, NHC(=O)OR7, i NHC(=O)OR7;

R11 je nezavisno odabran od H, CN, -C(=O)R12, tetrazolila,

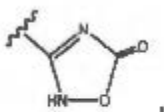

i

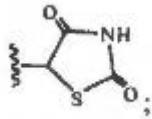

R<sub>12</sub> je nezavisno odabran od OH, OC<sub>1-4</sub> alkila, NH<sub>2</sub>, NHCH<sub>2</sub>CH<sub>2</sub>SO<sub>3</sub>H, i NHSO<sub>2</sub>C<sub>1-4</sub>alki;

r je nezavisno odabran od nula, 1, 2, 3 i 4,

i n je odabran od 1, 2, 3 ili 4.

**Patent sadrži još 30 patentnih zahtjeva**

(11) **03799** (13) **B**

(51) **C07K 16/30**<sup>(2006.01)</sup>

**C07K 16/28**<sup>(2006.01)</sup>

**G01N 33/574**<sup>(2006.01)</sup>

**A61K 47/68**<sup>(2017.01)</sup>

**G01N 33/566**<sup>(2006.01)</sup>

(21) P-2020-142

(22) 30.08.2013

(30) 201261695791 P 31.08.2012 US

201361756254 P 24.01.2013 US

(96) 13833526.0/30.08.2013

(86) US PCT/US2013/057682/30.08.2013

(87) WO 2014/036495/06.03.2014/2014/10

(97) EP 2890717/08.07.2015/2015/28

EP 2890717/04.03.2020/2020/10

(54) me **DIJAGNOSTIČKI TESTOVI I KOMPLETI ZA DETEKCIJU FOLATNOG RECEPTORA 1**  
en **DIAGNOSTIC ASSAYS AND KITS FOR DETECTION OF FOLATE RECEPTOR 1**

(73) ImmunoGen, Inc.

830 Winter Street, Waltham, MA 02451/ US

(72) TESTA, Nathan E.

53 Myrtle Street 4, Waltham Massachusetts 02453/ US

CARRIGAN, Christina N.

4003 24th Str., Apt. 3 , San Francisco, CA 94114/ US

AB, Olga

26 Bayberry Circle, Millis Massachusetts 02054/ US

TAVARES, Daniel

27 Sylvester Road, Natick Massachusetts 01760/ US

WOLF, Beni B.

29 Fairbanks Road, Lexington Massachusetts 02421/ US

(57)

1. Antitelo ili njegov antigen-vezujući fragment koje se specifično vezuje za FOLR1, naznačeno time što navedeno antitelo ili njegov antigen-vezujući fragment sadrži VH- CDR1, VH-CDR2, VH-CDR3, VL-CDR1, VL-CDR2 i VL-CDR3 aminokiselinske sekvence: SEQ ID NO: 1, 2, i 3 i SEQ ID NO: 13, 14, i 15.

#### Patent sadrži još 12 patentnih zahtjeva

(11) **03805** (13) **B**

(51) **A61K 35/747**<sup>(2015.01)</sup>

**A61K 9/00**<sup>(2006.01)</sup>

**A61K 9/48**<sup>(2006.01)</sup>

**A23L 33/21**<sup>(2016.01)</sup>

**A23L 33/135**<sup>(2016.01)</sup>

**A61P 1/00**<sup>(2006.01)</sup>

(21) P-2020-143

(22) 05.09.2014

(30) MI20131467 06.09.2013 IT

(96) 14790323.1/05.09.2014

(86) IB PCT/IB2014/064285/05.09.2014

(87) WO 2015/033305/12.03.2015/2015/10

(97) EP 3041489/13.07.2016/2016/28

EP 3041489/15.04.2020/2020/16

(54) me **UPOTREBA KOMPOZICIJE KOIA OBUHVATA MIKROORGANIZME ZA POVEĆANJE INTESTINALNE PROIZVODNJE BUTERNE KISELINE, FOLNE KISELINE ILI NIACINA I/ILI SMANJENJE INTESTINALNE PROIZVODNJE ĆILIBARNE KISELINE**

en **USE OF A COMPOSITION COMPRISING MICROORGANISMS TO INCREASE THE INTESTINAL PRODUCTION OF BUTYRIC ACID, FOLIC ACID OR NIACIN AND/OR DECREASE THE INTESTINAL PRODUCTION OF SUCCINIC ACID**

(73) Sofar SPA

Via Firenze 40, 20060 Trezzano Rosa (MI)/ IT

(72) BIFFI, Andrea

Via Mulino Vecchio 146, I-24059 Urgnano (Bergamo)/ IT

ROSSI, Ruggero

Via Federico Engels 1, I-20153 Milano/ IT

FIORE, Walter

Via Giuseppe Rossini 12, I-20060 Trezzano Rosa (Milano)/ IT

GUGLIELMETTI, Simone Domenico

Via Cima Otto e Camillo 23, I-20134 Milano/ IT

(57)

1. Bakterijski soj *Lactobacillus paracasei* DG deponovan u Nacionalnoj zbirki kultura mikroorganizama instituta Paster u Parizu 05.05.1995., pod brojem deponovanja CNCM 1-1572 za upotrebu u lečenju i/ili sprečavanju intestinalnih patoloških stanja zavisnih od butirata i/ili sukcinata.

**Patent sadrži još 8 patentnih zahtjeva.**

(11) **03791** (13) **B**

(51) **C07D 471/14**<sup>(2006.01)</sup>

**A61K 31/4985**<sup>(2006.01)</sup>

**A61P 13/12**<sup>(2006.01)</sup>

(21) P-2020-144

(22) 18.08.2017

(30) 201662379372 P 25.08.2016 US

(96) 17761381.7/18.08.2017

(86) PCT/US2017/047479/18.08.2017

(87) WO 2018/039051/01.03.2018/2018/09

(97) EP 3504208/03.07.2019/2019/27

EP 3504208/10.06.2020/2020/24

(54) me **DERIVAT TRIAZOLOPIRAZINONA KORISTAN KAO INHIBITOR LJUDSKOG PDE1**  
en **TRIAZOLOPYRAZINONE DERIVATIVE USEFUL AS A HUMAN PDE1 INHIBITOR**

(73) ELI LILLY AND COMPANY

Lilly Corporate Center, Indianapolis, IN 46285/ US

(72) REKHTER, Mark David

P.O. Box 6288, Indianapolis, Indiana 46206-6288/ US

SHI, Qing

P.O. Box 6288, Indianapolis, Indiana 46206-6288/ US

(57)

1. Spoj, **naznačen time** što je spoj formule:

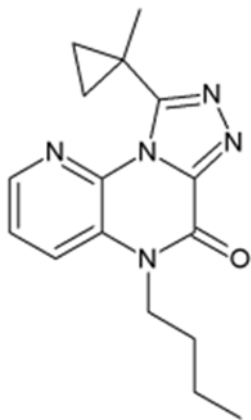

ili njegova farmaceutski prihvatljiva sol.

**Patent sadrži još 9 patentnih zahtjeva.**

(11) **03810** (13) **B**

(51) **A61K 9/08**<sup>(2006.01)</sup>

**A61K 31/198**<sup>(2006.01)</sup>

**A61K 9/00**<sup>(2006.01)</sup>

**A61K 47/18**<sup>(2017.01)</sup>

**A61K 47/10**<sup>(2017.01)</sup>

(21) P-2020-145

(22) 23.02.2016

(30) 201514634452 27.02.2015 US

(96) 16756169.5/23.02.2016

(86) US PCT/US2016/019093/23.02.2016

(87) WO 2016/137969/01.09.2016/2016/35

(97) EP 3261676/03.01.2018/2018/01

EP 3261676/17.06.2020/2020/25

(54) me **TEKUĆE FORMULACIJE LEVOTIROKSINA**

en **LIQUID LEVOTHYROXINE FORMULATIONS**

(73) TAP Pharmaceuticals AG

Neuhofstrasse 5A, 5th Floor, 6340 Baar/ CH

(72) Parikh, Nilesh

1672 Railroad Street, Corona, CA 92880/ US

Hite, William

1672 Railroad Street, Corona, CA 92880/ US

(57)

1. Farmaceutska otopina, **naznačena time** što sadrži:

- od 0,00 1% tež./vol. do 0,0 1% tež./vol. levotiroksina;
- najmanje 70% tež./tež. gliceroia;
- manje od 30% tež./tež. vode; i
- od 0,01% tež./tež. do 1.5% tež./tež. etilendiamintetraoctene kiseiine (EDTA), i gdje je otopina stabilna za skladištenje.

**Patent sadrži još 14 patentnih zahtjeva.**



(11) **03792** (13) **B**

(51) **C07D 271/08**<sup>(2006.01)</sup>  
**A61K 31/4245**<sup>(2006.01)</sup>

**C07D 413/04**<sup>(2006.01)</sup>  
**A61P 35/00**<sup>(2006.01)</sup>

(21) P-2020-146

(22) 07.11.2014

(30) 201361901689 P 08.11.2013 US

(96) 14812015.7/07.11.2014

(86) US PCT/US2014/064531/07.11.2014

(87) WO 2015/070007/14.05.2015/2015/19

(97) EP 3066085/14.09.2016/2016/37

EP 3066085/13.05.2020/2020/20

(54) me **POSTUPAK SINTEZE INHIBITORA INDOLAMIN 2,3-DIOKSIKSENAZE**  
en **PROCESS FOR THE SYNTHESIS OF AN INDOLEAMINE 2,3-DIOXYGENASE INHIBITOR**

(73) Incyte Holdings Corporation

1801 Augustine Cut-Off, Wilmington, DE 19803/ US

(72) TAO, Ming

1704 Brittany Drive, Maple Glen, Pennsylvania 19002/ US

FRIETZE, William

900 Merrybell Lane, Kennett Square, PA 19348/ US

MELONI, David J.

127 Megan Drive, Bear, Delaware 19701/ US

WENG, Lingkai

28 Landmark Drive, Malvern, Pennsylvania 19355/ US

ZHOU, Jiacheng

46 Bay Boulevard, Newark, Delaware 19702/ US

PAN, Yongchun

11 Emsley Dr., Wilmington, DE 19810/ US

(57)

1. Postupak koji obuhvata reagovanje jedinjenja formule F5:



sa aldehidom formule F6:

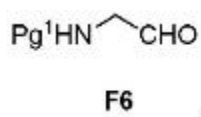

pri čemu je Pg1 amino zaštitna grupa, da se dobije jedinjenje formule F7:

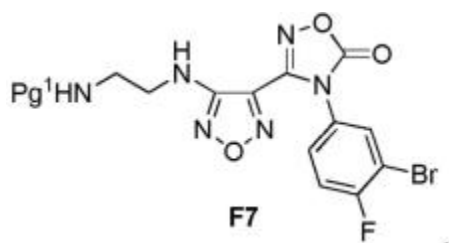

**Patent sadrži još 28 patentnih zahtjeva.**

(11) **03793** (13) **B**

(51) **C07D 401/06**<sup>(2006.01)</sup>

**C07D 413/14**<sup>(2006.01)</sup>

**C07D 407/14**<sup>(2006.01)</sup>

**C07D 471/04**<sup>(2006.01)</sup>

**A61K 31/4725**<sup>(2006.01)</sup>

**C07D 401/14**<sup>(2006.01)</sup>

**C07D 403/14**<sup>(2006.01)</sup>

**C07D 413/06**<sup>(2006.01)</sup>

**A61P 35/00**<sup>(2006.01)</sup>

(21) P-2020-147

(22) 05.12.2013

(30) 201261740596 P 21.12.2012 US

(96) 17206218.4/05.12.2013

(97) EP 3339303/27.06.2018/2018/26

EP 3339303/24.06.2020/2020/26

(54) me **LAKTAMI KONDEZIRANI S ARILOM I HETEROARILOM**  
en **ARYL AND HETEROARYL FUSED LACTAMS**

(73) PFIZER INC.

235 East 42nd Street, New York, NY 10017/ US

(72) EDWARDS, Martin Paul

10555 Science Center Drive, San Diego, CA California 92121/ US

KUMPF, Robert Arnold

3280 Avenida Anacapa, Carlsbad, CA California 92009/ US

KUNG, Pei-Pei

5504 Shannon Ridge Lane, San Diego, CA California 92130/ US

MCALPINE, Indrawan James

7190 Calabria Court, Unit C, San Diego, CA California 92122/ US

NINKOVIC, Sacha

8902 Nottingham Place, La Jolla, CA California 92037/ US

RUI, Eugene Yuanjin

11254 Caminito Corriente, San Diego, CA California 92128/ US

SUTTON, Scott Channing

11660 Weatherwood Place, San Diego, CA California 92131/ US

TATLOCK, John Howard

10220 Camino San Thomas, San Diego, CA California 92127/ US

WYTHES, Martin James

10555 Science Center Drive, San Diego, CA California 92121/ US

ZEHNDER, Luke Raymond

4653 Rainier Avenue, San Diego, CA California 92120/ US

(57)

1. Spoj formule (II-A):

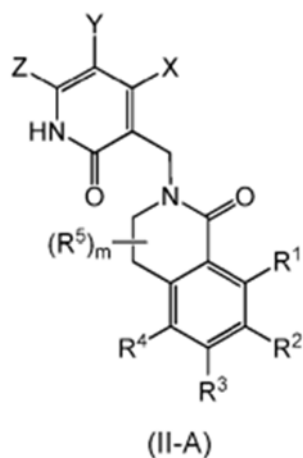

ili njegova farmaceutski prihvatljiva sol,

**naznačen time što:**

R1 je C1-C8 alkil, C1-C8 alkoksi, halogen, -OH, -CN ili -NR7R8, gdje svaki navedeni C1-C8 alkil ili C1-C8 alkoksi može biti supstituiran s jednim ili više R21;

R2 je C1-C8 alkil koji može biti supstituiran s 1 do 3 R22;

R3 je H, C1-C8 alkil, C1-C8 alkoksi, halogen, -OH, -CN ili -NR7R8, gdje svaki navedeni C1-C8 alkil ili C1-C8 alkoksi može biti supstituiran s jednim ili više R23;

R4 se bira iz skupine koju čine H, halogen, C1-C8 alkil, C3-C8 cikloalkil, 3-12-eročlani heterociklil, C6-C12 aril, 5-12-eročlani heteroaril, -(C1-C4 alkil)Rz, -ORx, -CN, -C(O)Rx, -CO2Rx, -C(O)NRxRy, -SRx, -SORx, -SO2Rx, -SO2NRxRy, -NO2, -NRxRy, -NRxC(O)Ry, -NRxC(O)NRxRy, -NRxC(O)ORy, -NRxSO2Ry, -NRxSO2NRxRy, -OC(O)Rx i -OC(O)NRxRy;

svakog Rx i Ry se neovisno bira iz skupine koju čine H, C1-C8 alkil, C3-C8 cikloalkil, 3-12-eročlani heterociklil, C6-C12 aril i 5-12-eročlani heteroaril; ili Rx i Ry se može uzeti zajedno s N atomom na kojeg su vezani kako bi tvorili 3-12-eročlani heterociklil ili 5-12-eročlani heteroaril prsten, od kojih svaki može sadržavati 1, 2 ili 3 dodatna heteroatoma, koje se bira između O, N i S;

svakog Rz se neovisno bira iz skupine koju čine C3-C8 cikloalkil, 3-12-eročlani heterociklil, C6-C12 aril i 5-12-eročlani heteroaril; i

gdje svaki navedeni C1-C8 alkil u R4, Rx ili Ry i svaki navedeni C1-C4 alkil u (C1-C4 alkil)Rz može biti supstituiran s jednim ili više R24, a svaki navedeni C3-C8 cikloalkil, 3-12-eročlani heterociklil, C6-C12 aril, ili 5-12-eročlani heteroaril u R4, Rx, Ry, Rz, ili Rx i Ry uzet zajedno može biti supstituiran s jednim ili više R34;

svakog R5 se neovisno bira iz skupine koju čine halogen, -OH, =O, C1-C4 alkil, C1-C4 alkoksi, -CN, -NR9R10 i -C(O)NR9R10, gdje svaki navedeni C1-C4 alkil ili C1-C4 alkoksi može biti supstituiran s 1 do 3 supstituenta, koje se neovisno bira iz skupine koju čine halogen, -OH, C1-C4 alkoksi, -CN, -NR9R10 i -C(O)NR9R10;

svakog R7 i R8 se neovisno bira iz skupine koju čine H, C1-C8 alkil, C3-C8 cikloalkil, 3-12-eročlani heterociklil, C6-C12 aril, te 5-12-eročlani heteroaril; ili

R7 i R8 se može uzeti zajedno s N atomom na kojeg su vezani kako bi tvorili 3-12-eročlani heterociklil ili 5-12-eročlani heteroaril, od kojih svaki može sadržavati 1, 2 ili 3 dodatna heteroatoma, koje se bira između O, N i S;

gdje svaki navedeni C1-C8 alkil u R7 ili R8 može biti supstituiran s jednim ili više R27, a svaki navedeni C3-C8 cikloalkil, 3-12-eročlani heterociklil, C6-C12 aril, ili 5-12-eročlani heteroaril u R7, R8, ili R7 i R8 uzet zajedno može biti supstituiran s jednim ili više R37;

svaki R9 i R10 je neovisno H ili C1-C4 alkil; ili

R9 i R10 se može uzeti zajedno s N atomom na kojeg su vezani kako bi tvorili 3-12-eročlani heterociklil ili 5-12-eročlani heteroaril, od kojih svaki može sadržavati 1, 2 ili 3 dodatna heteroatoma, koje se bira između O, N i S;

gdje svaki navedeni C1-C4 alkil u R9 ili R10, a svaki navedeni 3-12-eročlani heterociklil ili 5-12-eročlani heteroaril u R9 i R10 uzet zajedno može biti supstituiran s 1 do 3 supstituenta, koje se neovisno bira iz skupine koju čine halogen, -OH, =O, C1-C4 alkil, C1-C4 alkoksi, -CN, -NH<sub>2</sub>, -NH(C1-C4 alkil) i -N(C1-C4 alkil)<sub>2</sub>;

m je 0 to 4;

svakog R21, R22, R23 i R24 se neovisno bira iz skupine koju čine halogen, C1-C8 alkil, -CN, =O, -C(O)Re, -CO<sub>2</sub>Re, -C(O)NRcRf, -ORe, -SRe, -SORe, -SO<sub>2</sub>Re, -SO<sub>2</sub>NRcRf, -NO<sub>2</sub>, -NRcRf, -NRc(O)Rf, -NRc(O)NRcRf, -NRc(O)ORf, -NRcSO<sub>2</sub>Rf, -NRcSO<sub>2</sub>NRcRf, -OC(O)Re, -OC(O)NRcRf, C3-C8 cikloalkil, 3-12-eročlani heterociklil, C6-C12 aril i 5-12-eročlani heteroaril;

svakog R8 i Rf se neovisno bira iz skupine koju čine H, C1-C8 alkil, C3-C8 cikloalkil, 3-12-eročlani heterociklil, C6-C12 aril i 5-12-eročlani heteroaril; ili

Re i Rf se može uzeti zajedno s N atomom na kojeg su vezani kako bi tvorili 3-12-eročlani heterociklil ili 5-12-eročlani heteroaril prsten, od kojih svaki može sadržavati 1, 2 ili 3 dodatna heteroatoma, koje se bira između O, N i S;

gdje svaki navedeni C1-C8 alkil, C3-C8 cikloalkil, 3-12-eročlani heterociklil, C6-C12 aril ili 5-12-eročlani heteroaril u R24, Re, Rf, ili Re i Rf uzet zajedno može biti supstituiran s 1 do 3 supstituenta, koje se neovisno bira iz skupine koju čine halogen, -OH, =O, C1-C4 alkil, C1-C4 alkoksi, C1-C6 haloalkil, C1-C6 hidroksialkil, C1-C4 alkoksi-C1-C6 alkil, -CN, -NH<sub>2</sub>, -NH(C1-C4 alkil) i -N(C1-C4 alkil)<sub>2</sub>;

svakog R27 se neovisno bira iz skupine koju čine halogen, -OH, C1-C4 alkoksi, -CN, -NR<sub>9</sub>R<sub>10</sub>, C3-C8 cikloalkil, 3-12-eročlani heterociklil, C6-C12 aril i 5-12-eročlani heteroaril, gdje svaki navedeni C1-C4 alkoksi, C3-C8 cikloalkil, 3-12-eročlani heterociklil, C6-C12 aril ili 5-12-eročlani heteroaril može biti supstituiran s 1 do 3 supstituenta, koje se neovisno bira iz skupine koju čine halogen, -OH, =O, C1-C4 alkil, C1-C4 alkoksi, C1-C6 haloalkil, C1-C6 hidroksialkil, C1-C4 alkoksi-C1-Ca alkil, -CN, -NH<sub>2</sub>, -NH(C1-C4 alkil) i -N(C1-C4 alkil)<sub>2</sub>;

svakog R34 i R37 se neovisno bira iz skupine koju čine halogen, C1-C8 alkil, -CN, =O, -C(O)Rc, -CO<sub>2</sub>Rc, -C(O)NRcRd, -ORc, -SRc, -SORc, -SO<sub>2</sub>Rc, -SO<sub>2</sub>NRcRd, -NO<sub>2</sub>, -NRcRd, -NRcC(O)Rd, -NRcC(O)NRcRd, -NRcC(O)ORd, -NRcSO<sub>2</sub>Rd, -NRcSO<sub>2</sub>NRcRd, -OC(O)Rc, -OC(O)NRcRd, C3-C8 cikloalkil, 3-12-eročlani heterociklil, C6-C12 aril i 5-12-eročlani heteroaril;

svakog Rc i Rd se neovisno bira iz skupine koju čine H, C1-C6 alkil, C3-C8 cikloalkil, 3-12-eročlani heterociklil, C6-C12 aril i 5-12-eročlani heteroaril; ili

Rc i Rd se može uzeti zajedno s N atomom na kojeg su vezani kako bi tvorili 3-12-eročlani heterociklil ili 5-12-eročlani heteroaril prsten, od kojih svaki može sadržavati 1, 2 ili 3 dodatna heteroatoma, koje se bira između O, N i S;

gdje svaki navedeni C1-C8 alkil, C1-C8 cikloalkil, 3-12-eročlani heterociklil, C6-C12 aril ili 5-12-eročlani heteroaril u R34, R37, Rc, Rd, ili Rc i Rd uzet zajedno može biti supstituiran s 1 do 3 supstituenta, koje se neovisno bira iz skupine koju čine halogen, -OH, =O, C1-C4 alkil, C1-C4 alkoksi, C1-C6 haloalkil, C1-C6 hidroksialkil, C1-C4 alkoksi-C1-C6 alkil, -CN, -NH<sub>2</sub>, -NH(C1-C4 alkil) i -N(C1-C4 alkil)<sub>2</sub>;

X i Z se neovisno bira iz skupine koju čine H, C1-C8alkil, C2-C8 alkenil, C2-C8 alkinil, C3-C8 cikloalkil, 3-12-eročlani heterociklil, C6-C12 aril, 5-12-eročlani heteroaril, halogen, CN, -C(O)Ra, -CO<sub>2</sub>Ra, -C(O)NRaRb, -SRa, -SORa, -SO<sub>2</sub>Ra, -SO<sub>2</sub>NRaRb, -NO<sub>2</sub>, -NRaRb, -NRaC(O)Rb, -NRaC(O)NRaRb, -NRaC(O)ORa, -NRaSO<sub>2</sub>Rb, -NRaSO<sub>2</sub>NRaRb, -ORa, -OC(O)Ra ili -OC(O)NRaRb;

gdje svaki navedeni C1-C8 alkil, C2-C8 alkenil, C2-C8 alkinil, C3-C8 cikloalkil, 3-12-eročlani heterociklil, C6-C12 aril ili 5-12-eročlana heteroarilna skupina mogu biti supstituirani s jednim ili više supstituenti, koje se neovisno bira iz skupine koju čine halogen, -CN, -C(O)Ra, -CO<sub>2</sub>Ra, -C(O)NRaRb, -SRa, -SORa, -SO<sub>2</sub>Ra, -SO<sub>2</sub>NRaRb, -NO<sub>2</sub>, -NRaRb, -NRaC(O)Rb, -NRaC(O)NRaRb, -NRaC(O)ORa - NRaSO<sub>2</sub>Rb, -NRaSO<sub>2</sub>NRaRb, -ORa, -OC(O)Ra, -OC(O)NRaRb, C3-C8 cikloalkil, 3-12-eročlani heterociklil, C6-C12 aril, te 5-12-eročlani heteroaril;

svaki Ra i Rb je neovisno H, C1-C8 alkil, C2-C8 alkenil, C2-C8 alkinil, C3-C8 cikloalkil, 3-12-eročlani heterociklil, C6-C12 aril ili 5-12-eročlani heteroaril, gdje svaki navedeni C1-C8 alkil, C2-C8 alkenil, C2-C8 alkinil, C3-C8 cikloalkil, 3-12-eročlani heterociklil, C6-C12 aril i 5-12-eročlani heteroaril može biti supstituiran s jednim ili više supstituenti, koje se neovisno bira iz skupine koju čine halogen, C1-C4 alkil, -OR<sub>14</sub>, -NR<sub>14</sub>, -CO<sub>2</sub>R<sub>14</sub>, -C(O)NR<sub>14</sub>, -SO<sub>2</sub>R<sub>14</sub> i -SO<sub>2</sub>NR<sub>14</sub>, gdje svaki R<sub>14</sub> je neovisno H ili C1-C4 alkil; ili

Ra i Rb se može uzeti zajedno s N atomom na kojeg su vezani kako bi tvorili 3-12-eročlani heterociklil ili 5-12-eročlani heteroaril, od kojih svaki može sadržavati 1, 2 ili 3 dodatna heteroatoma, koje se bira između O, N i S, **naznačen time** što navedeni heterociklil ili heteroaril može biti supstituiran s jednim ili više supstituenti, koje se neovisno bira iz skupine koju čine halogen, -OH, =O, C1-C4 alkil, C1-C4 alkoksi, C1-C6 haloalkil, C1-C6 hidroksialkil, C1-C4 alkoksi-C1-C6 alkil, -CN, -NH<sub>2</sub>, -NH(C1-C4 alkil) i -N(C1-C4 alkil)<sub>2</sub>; i

Y je H, halogen, -OH ili C1-C4 alkoksi.

**Patent sadrži još 11 patentnih zahtjeva.**

(11) **03800** (13) **B**

(51) **C07D 417/14**<sup>(2006.01)</sup>

**A61P 25/28**<sup>(2006.01)</sup>

**C07D 413/12**<sup>(2006.01)</sup>

**A61K 31/4045**<sup>(2006.01)</sup>

**C07D 403/12**<sup>(2006.01)</sup>

**C07D 417/12**<sup>(2006.01)</sup>

(21) P-2020-148

(22) 28.01.2015

(30) 201461933246 P 29.01.2014 US

201462078895 P 12.11.2014 US

(96) 18156929.4/28.01.2015

(97) EP 3348556/18.07.2018/2018/29

EP 3348556/29.04.2020/2020/18

(54) me **HETEROARIL AMIDI KAO INHIBITORI PROTEINSKE AGREGACIJE**  
en **HETEROARYL AMIDES AS INHIBITORS OF PROTEIN AGGREGATION**

(73) UCB Biopharma SRL

Allé de la Recherche 60, 1070 Brussels/ BE

(72) STOCKING, Emily M.

10835 Road to the Cure, Suite 230, San Diego, CA 92121/ US

WRASIDLO, Wolfgang

10835 Road to the Cure, Suite 230, San Diego, CA 92121/ US

(57)

1. Jedinjenje sa formulom (1):

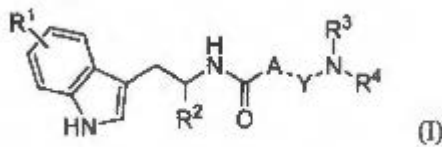

gde:

R1 je H, halo, C1-4alkil, ili CF<sub>3</sub>;

R2 je -CF<sub>3</sub>, ili C1-4alkil nesupstituisan ili supstituisan sa halo ili -CF<sub>3</sub>;

A je 5- člani heteroaril prsten;

Y je odsutno ili je C1-4alkilen; gde Y

je odsutno:

R3 i R4 zajedno sa azotom za koji su vezani formiraju monociklicni heterocikloalkil prsten, nesupstituisan ili supstituisan sa C1-4alkilom; i

gde Y je C1-4alkilen:

R3 i R4 zajedno sa azotom za koji su vezani formiraju monociklicni heterocikloalkil prsten, nesupstituisan ili supstituisan sa C1-4alkilom; ili

R3 i Y zajedno sa azotom za koji R3 je vezan formiraju monociklicni heterocikloalkil prsten, i R4 je H ili C1-4alkil; ili farmaceutski prihvatljiva so istog.

**Patent sadrži još 16 patentnih zahtjeva.**

(11) **03801** (13) **B**

(51) **C07D 471/04**<sup>(2006.01)</sup>

**A61P 35/00**<sup>(2006.01)</sup>

**A61P 37/00**<sup>(2006.01)</sup>

**A61K 31/437**<sup>(2006.01)</sup>

(21) P-2020-149

(22) 16.02.2018

(30) 201762460677P 17.02.2017 US

201762490881P 27.04.2017 US

201762573991P 18.10.2017 US

(96) 18707612.0/16.02.2018

(86) US PCT/US2018/018484/16.02.2018

(87) WO 2018/152396/23.08.2018/2018/34

(97) EP 3510034/17.07.2019/2019/29

EP 3510034/22.04.2020/2020/17

(54) me **SUPSTITUISAN IMIDAZO-HINOLINI KAO NLRP3 MODULATORI**  
en **SUBSTITUTED IMIDAZO-QUINOLINES AS NLRP3 MODULATORS**

(73) Innate Tumor Immunity, Inc.

Route 206 and Province Line Road, Princeton, New Jersey 08543/ US

(72) GLICK, Gary

1663 Snowberry Ridge Road, Ann Arbor, MI 48103 / US

GHOSH, Shomir

134 Sewall Anebue, Unit 3, Brookline, MA 02446/ US

ROUSH, William R.

250 Beach Road Apt. 207, Tequesta, FL 33469/ US

OLHAVA, Edward James

11 Scarsdale Road, Newton, MA 02460/ US

O'MALLEY, Daniel

Route 206 and Province Line Road, Princeton, New Jersey 08543/ US

(57)

1.Jedinjenje koje ima formulu (II):

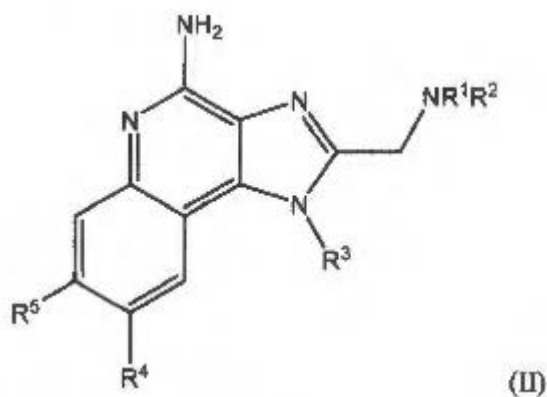

ili njegova farmaceutski prihvatljiva so, pri čemu:

R1 je nezavisno nesupstituisan C1-6 alkil, ili C(=O)Ra;

R2 je nezavisno Hili nesupstituisan C1-6 alkil;

R3 je:

(i) H;



- (ii) nesupstituisan C1-2 alkil;
- (iii) **X-R8**, pri čemu X je nerazgranat C1-6 alkilen, a **R8** je -OH, C1-4 alkoksi, -C1-4 haloalkoksi, CO2Ra, ili -CONRcRd;
- (iv) (C1-3 alkilen)-(C6-C10 aril), pri čemu aril je po izboru supstituisan sa od 1-3 supstituenta nezavisno odabrana od C1-6 alkila, C1-4 haloalkila, C1-4 alkoksi, i C1-4 haloalkoksi; ili
- (v) (C1-3 alkilen)heteroaril koji uključuje od 5 do 6 atoma u prstenu, pri čemu od 1 do 4 atoma u prstenu su svaki nezavisno odabrani od N, N(**Re**), O, i S, i pri čemu heteroaril je po izboru supstituisan sa od 1 do 3 supstituenta nezavisno odabrana od C1-6 alkila, C1-4 haloalkila, C1-4 alkoksi, i C1-4 haloalkoksi;

**R4** i **R5** su svaki nezavisno odabrani od:

- (i) H;
- (ii) halo;
- (iii) -(C0-3 alkilen)-C3-10 cikloalkila, pri čemu cikloalkil je po izboru supstituisan sa od 1 do 4 nezavisno odabrana **Rf**;
- (iv) -(C0-3 alkilen)-heterociklila koji uključuje od 3 do 10 atoma u prstenu, pri čemu od 1 do 3 atoma u prstenu su svaki nezavisno odabrani od: N(**Re**), O, i S, pri čemu heterociklil je po izboru supstituisan sa od 1 do 4 **Rf**;
- (v) -(C0-3 alkilen)-(C6-C10 arila) po izboru supstituisanog sa od 1 do 4 **Rg**;
- (vi) -(C0-3 alkilen)-heteroarila koji uključuje od 5 do 10 atoma u prstenu, pri čemu od 1 do 4 atoma u prstenu su svaki nezavisno odabrani od: N, NH, O, i S, pri čemu heteroaril je po izboru supstituisan sa od 1 do 3 **Rg**;
- (vii) C1-6 alkila po izboru supstituisanog sa od 1-2 nezavisno odabrana **Rh**; i
- (viii) -(C0-3 alkilen)-C4-10 cikloalkenila, pri čemu cikloalkenil je po izboru supstituisan sa od 1 do 2 **Rf**;

**Ra** je:

- (i) C1-6 alkil po izboru supstituisan sa od 1 do 2 **Rh**; ili
  - (ii) -(C0-3 alkilen)-C3-10 cikloalkil, pri čemu cikloalkil je po izboru supstituisan sa od 1 do 2 **Rf**;
  - (iii) -(C1-3 alkilen)-heterociklil koji uključuje od 3 do 10 atoma u prstenu, pri čemu od 1 do 3 atoma u prstenu su svaki nezavisno odabrani od N(**Re**), O, i S, pri čemu heterociklil je po izboru supstituisan sa od 1 do 4 nezavisno odabrana **Rf**;
  - (iv) -(C0-3 alkilen)-fenil po izboru supstituisan sa od 1 do 4 nezavisno odabrana **Rg**; ili
  - (v) -(C0-3 alkilen)-heteroaril koji uključuje od 5 do 10 atoma u prstenu, pri čemu od 1 do 4 atoma u prstenu su svaki nezavisno odabrani od N, N(**Re**), O, i S, pri čemu heteroaril je po izboru supstituisan sa od 1 do 3 nezavisno odabrana **Rg**;
- pri svakom pojavljivanju **Rc** i **Rd** je nezavisno H ili C1-4 alkil;
- pri svakom pojavljivanju **Re** je nezavisno H ili C1-4 alkil;

pri svakom pojavljivanju **Rf** je nezavisno C1-6 alkil, C1-4 haloalkil, -OH, F, Cl, C1-4 alkoksi, C1-4 haloalkoksi, cijano, ili fenil po izboru supstituisan sa od 1 do 4 **Rg**;

pri svakom pojavljivanju **Rg** je nezavisno halo, cijano, C1-6 alkil, C1-4 haloalkil, C1-4 alkoksi, ili C1-4 haloalkoksi; i pri svakom pojavljivanju **Rh** je nezavisno -OH, F, C1-4 alkoksi, C1-4 haloalkoksi, ili cijano.

**Patent sadrži još 21 patentnih zahtjeva.**

(11) **03794** (13) **B**

(51) **C07D 401/14**<sup>(2006.01)</sup>

**C07D 403/06**<sup>(2006.01)</sup>

**A61K 31/4439**<sup>(2006.01)</sup>

**A61K 31/501**<sup>(2006.01)</sup>

**A61K 31/4155**<sup>(2006.01)</sup>

**C07D 401/10**<sup>(2006.01)</sup>

**C07D 403/14**<sup>(2006.01)</sup>

**A61K 31/444**<sup>(2006.01)</sup>

**A61K 31/506**<sup>(2006.01)</sup>

**A61P 27/00**<sup>(2006.01)</sup>

(21) P-2020-150

(22) 31.05.2017

(30) 20160009517 31.05.2016 GB

201662343363 P 31.05.2016 US

201702044 08.02.2017 GB

201762456219 P 08.02.2017 US

(96) 17728593.9/31.05.2017

(86) GB PCT/GB2017/051546/31.05.2017

(87) WO 2017/207983/07.12.2017/2017/49

(97) EP 3464271/10.04.2019/2019/15

EP 3464271/13.05.2020/2020/20

(54) me **DERIVATI PIRAZOLA KAO INHIBITORI KALIKREINA PLAZME**  
en **PYRAZOLE DERIVATIVES AS PLASMA KALLIKREIN INHIBITORS**

(73) Kalvista Pharmaceuticals Limited

Porton Science Park, Bybrook Road, Porton Down, Salisbury SP4 0BF , Wiltshire/ GB

(72) DAVIE, Rebecca Louise

Building 227, Tetricus Science Park, Porton Down Salisbury SP4 0JQ/ GB

EDWARDS, Hannah Joy

Building 227, Tetricus Science Park, Porton Down Salisbury SP4 0JQ/ GB

EVANS, David Michael

Building 227, Tetricus Science Park, Porton Down Salisbury SP4 0JQ/ GB

HODGSON, Simon Teanby

Orchard House The Avenue, Ampthill Bedfordshire MK45 2NR/ GB

PETHEN, Stephen John

Building 227, Tetricus Science Park, Porton Down Salisbury SP4 0JQ/ GB

ROOKER, David Philip

Building 227, Tetricus Science Park, Porton Down Salisbury SP4 0JQ/ GB

(57)

1. Jedinjenje izabrano iz grupe koja se sastoji iz:

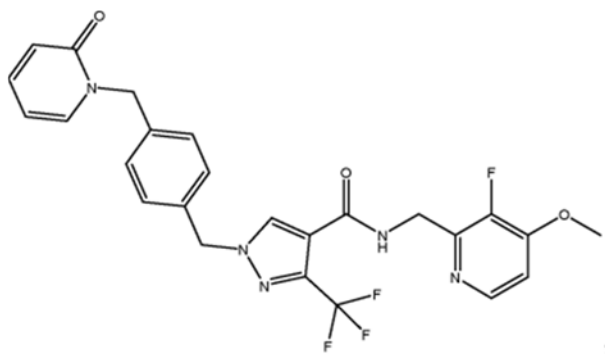

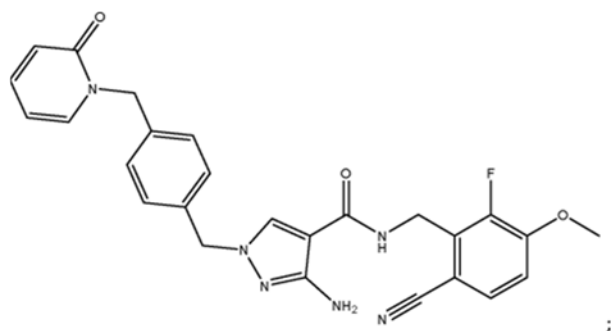
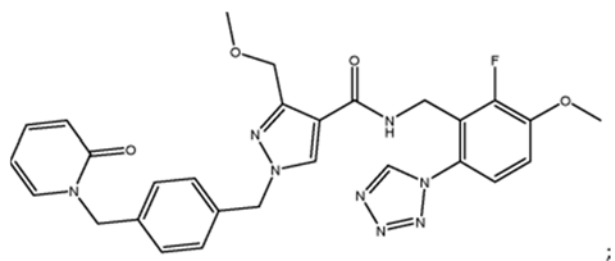
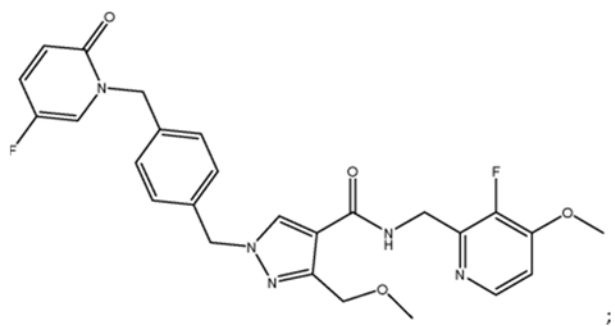
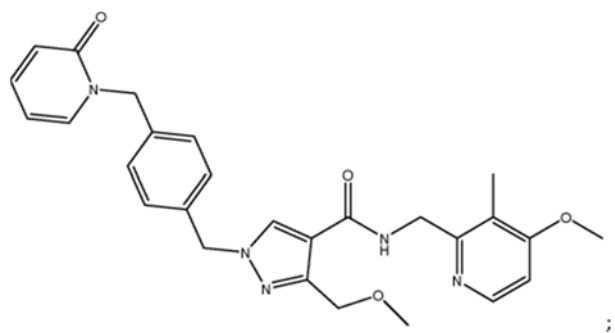

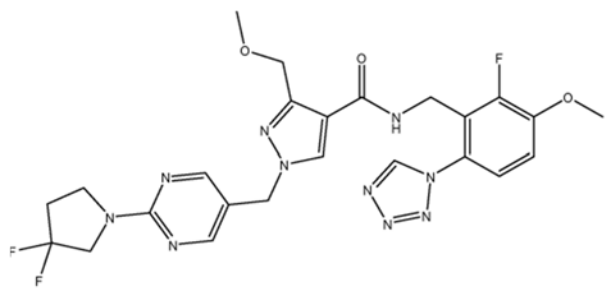
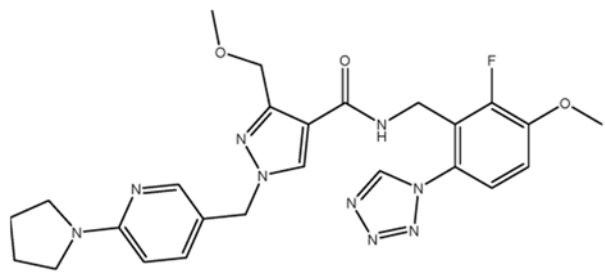

i njihovih farmaceutski prihvatljivih soli i solvata.

**Patent sadrži još 14 patentnih zahtjeva.**

(11) **03796** (13) **B**

(51) **C07K 16/28**<sup>(2006.01)</sup>

**A61P 37/04**<sup>(2006.01)</sup>

(21) P-2020-152

(22) 13.03.2014

(30) 201361789325 P 15.03.2013 US

(96) 14709691.1/13.03.2014

(86) EP PCT/EP2014/054967/13.03.2014

(87) WO 2014/140180/18.09.2014/2014/38

(97) EP 2970464/20.01.2016/2016/03

EP 2970464/06.05.2020/2020/19

(54) me **ANTI-LAG-3 VEZUJUĆI PROTEINI**  
en **ANTI-LAG-3 BINDING PROTEINS**

(73) GlaxoSmithKline Intellectual Property Development Limited

980 Great West Road, Brentford, Middlesex TW8 9GS/ GB

(72) HAMBLIN, Paul Andrew

Gunnels Wood Road, Stevenage Hertfordshire SG1 2NY/ GB

LEWIS, Alan Peter

Gunnels Wood Road, Stevenage Hertfordshire SG1 2NY/ GB

WEBB, Thomas Matthew

980 Great West Road, Brentford Middlesex TW8 9GS/ GB

(57)

1. Humanizovano antitelo ili njegov fragment koji je sposoban da se veže za Limfocitni Aktivacijski Gen 3 (LAG-3) i koji sadrži  
a) varijabilni laki lanac (VL) SEQ ID NO. 4 i b) varijabilni teški lanac (VH) SEQ ID NO. 9.

**Patent sadrži još 18 patentnih zahtjeva.**

(11) **03797** (13) **B**

(51) **A61K 39/00**<sup>(2006.01)</sup>

**A61P 3/06**<sup>(2006.01)</sup>

**C07K 16/40**<sup>(2006.01)</sup>

**A61K 38/00**<sup>(2006.01)</sup>

(21) P-2020-153

(22) 03.05.2013

(30) 201261642363 P 03.05.2012 US

(96) 13724077.6/03.05.2013

(86) US PCT/US2013/039561/03.05.2013

(87) WO 2013/166448/07.11.2013/2013/45

(97) EP 2844285/11.03.2015/2015/11

EP 2844285/15.07.2020/2020/29

(54) me **STABILNE FORMULACIJE KOJE SADRŽE ANTI-PCSK9 ANTITELA**  
en **STABLE FORMULATIONS CONTAINING ANTI-PCSK9 ANTIBODIES**

(73) Amgen Inc.

One Amgen Center Drive M/S 28-2-C, Thousand Oaks, CA 91320-1799/ US

(72) CLOGSTON, Christi L.

601 Country View Place, Camarillo, California 93010/ US

OSSLUND, Timothy David

475 Vista Montana, Camarillo, California 93010/ US

(57)

1. Stabilna formulacija koja obuhvata

monoklonalno antitelo koje se specifično vezuje za PCSK9, pri čemu PCSK9 obuhvata aminokiseline SEQ ID NO:1, monoklonalno antitelo u količini od 100 mg/ml do 150 mg/ml, i

farmaceutski prihvatljiv pufer u količini od 0.05 mM do 40 mM, pri čemu taj farmaceutski prihvatljiv pufer predstavlja natrijumacetatni pufer, i

farmaceutski prihvatljiv surfaktant u količini koja je 0.004 mas./vol.% do 0.01 mas./vol.%, pri čemu taj farmaceutski prihvatljiv surfaktant predstavlja polisorbit 80, polisorbit 60, polisorbit 40 ili polisorbit 20, i

najmanje jedan farmaceutski prihvatljiv stabilizator od 0.5 mas./vol.% do 10 mas./vol.%,

pri čemu ta stabilna formulacija ima pH između 4.0 do 6.0,

pri čemu pomenuti farmaceutski prihvatljiv stabilizator predstavlja prolin, i

pri čemu monoklonalno antitelo obuhvata

varijabilni region lakog lanca koji obuhvata aminokiselinsku sekvencu SEQ ID NO:23 ili njenu varijantu, pri čemu ta varijanta obuhvata jedno ubacivanje, deleciju i/ ili supstituciju aminokiseline u odnosu na SEQ ID NO:23; i

varijabilni region teškog lanca koji obuhvata aminokiselinsku sekvencu SEQ ID NO:49 ili njenu varijantu, pri čemu ta varijanta obuhvata jedno ubacivanje, deleciju i/ ili supstituciju aminokiseline u odnosu na SEQ ID NO:49, i

konstantni region lakog lanca SEQ ID NO:156 i konstantni region teškog lanca SEQ ID NO:154 ili SEQ ID NO:155.

**Patent sadrži još 12 patentnih zahtjeva.**

(11) **03803** (13) **B**

(51) **C07D 495/16**<sup>(2006.01)</sup>

**A61K 31/519**<sup>(2006.01)</sup>

**A61P 37/00**<sup>(2006.01)</sup>

**C07D 519/00**<sup>(2006.01)</sup>

**A61P 35/00**<sup>(2006.01)</sup>

**A61P 19/00**<sup>(2006.01)</sup>

(21) P-2020-155

(22) 09.12.2016

(30) 201562265836 P 10.12.2015 US

(96) 16820106.9/09.12.2016

(86) US PCT/US2016/065954/09.12.2016

(87) WO 2017/100662/15.06.2017/2017/24

(97) EP 3386991/17.10.2018/2018/42

EP 3386991/03.06.2020/2020/23

(54) me **POLICIKLIČNA JEDINJENJA KAO INHIBITORI BRUTONOVE TIROZIN KINAZE**  
en **POLYCYCLIC COMPOUNDS AS INHIBITORS OF BRUTON'S TYROSINE KINASE**

(73) JANSSEN PHARMACEUTICA N.V.

Turnhoutseweg 30 , Beerse, 2340 / BE

(72) ARORA, Nidhi

3210 Merryfield Row, San Diego, California 92121/ US

BACANI, Genesis M.

3210 Merryfield Row, San Diego, California 92121/ US

BARBAY, Joseph Kent

Welsh&McKean Roads, Spring House, Pennsylvania 19477/ US

BEMBENEK, Scott D.

3210 Merryfield Row, San Diego, California 92121/ US

CAI, Min

Building 4, 720 Cailun Road, Zhangjian Hi-Tech Park,, Shanghai 201203/ CN

CHEN, Wei

Building 4, 720 Cailun Road, Zhangjian Hi-Tech Park,, Shanghai 201203/ CN

DECKHUT, Charlotte Pooley

3210 Merryfield Row, San Diego, California 92121/ US

EDWARDS, James P.

3210 Merryfield Row, San Diego California 92121/ US

GHOSH, Brahmananda

1400 McKean Road, Spring House, Pennsylvania 19477/ US

KREUTTER, Kevin

15 Fountain Road, Arlington, MA 02476-7512/ US

LI, Gang

Building 4, 720 Cailun Road, Zhangjian Hi-Tech Park, Shanghai 201203/ CN

TICHENOR, Mark S.

3210 Merryfield Row, San Diego, California 92121/ US

VENABLE, Jennifer D.

3210 Merryfield Row, San Diego, California 92121/ US

WEI, Jianmei

3210 Merryfield Row, San Diego, California 92121/ US

WIENER, John J. M.

3210 Merryfield Row, San Diego, California 92121/ US

WU, Yao

Building 4,720 Cailun Road, Zhangjian Hi-Tech Park, Shanghai 201203/ CN

XIAO, Kun

Building 4,720 Cailun Road, Zhangjian Hi-Tech Park, Shanghai 201203/ CN

ZHANG, Feihuang

Building 4,720 Cailun Road, Zhangjian Hi-Tech Park, Shanghai 201203/ CN

ZHU, Yaoping

Building 4, 720 Cailun Road, Zhangjian Hi-Tech Park, Shanghai 201203/ CN

(57)

1. Jedinjenje formule (I):

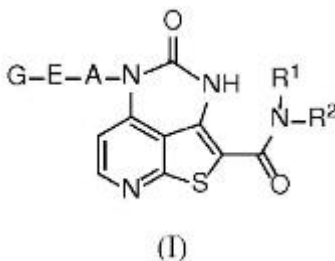

gde

R1 je H;

R2 je izabran iz grupe koju čine: CH<sub>2</sub>-cikloheksil, gde cikloheksil je opciono supstituisan sa OH; 3-hidroksiadamantan-1-il; i C<sub>3</sub>-6cikloalkil opciono supstituisan sa 1, 2, ili 3 supstituenata, od kojih je svaki nezavisno izabran iz grupe koju čine: OH, halogen, C<sub>1</sub>-6alkil, C<sub>1</sub>-6haloalkil, OC<sub>1</sub>-6alkil, CN, NR<sub>6</sub>R<sub>7</sub>, NR<sub>8</sub>-C(O)H, NR<sub>8</sub>-C(O)-C<sub>1</sub>-6alkil, NR<sub>8</sub>-C(O)-C<sub>1</sub>-6haloalkil, NR<sub>8</sub>-C(O)-O-C<sub>1</sub>-6alkil, NR<sub>8</sub>-C(O)-C<sub>1</sub>-6alk-OH, NR<sub>8</sub>-C(O)-C<sub>1</sub>-6alk-NR<sub>6</sub>R<sub>7</sub>, i NR<sub>8</sub>-C(O)-C(R<sub>3</sub>)=CR<sub>4</sub>(R<sub>5</sub>); gde

R3 je izabran iz grupe koju čine: H, CN, halogen, C<sub>1</sub>-6haloalkil, i C<sub>1</sub>-6alkil;

R4 i R5 su svaki nezavisno izabrani iz grupe koju čine: H; C<sub>0</sub>-6alk-NR<sub>6</sub>R<sub>7</sub>; C<sub>1</sub>-6alk-O-C<sub>1</sub>-6alkil; C<sub>3</sub>-6cikloalkil; heterocikloalkil opciono supstituisan sa C<sub>1</sub>-6alkil; i -linker-PEG-Biotin;

R6 i R7 su svaki nezavisno izabrani iz grupe koju čine:

H, C<sub>1</sub>-6alkil, C(O)H, i CN; i

R8 je H;

ili R1 i R2, zajedno sa azotovim atomom za koji su vezani, obrazuju pirolidinil prsten opciono supstituisan sa NR<sub>6</sub>R<sub>7</sub>, gde R6 i R7 su svaki nezavisno izabrani iz grupe koju čine H; C<sub>1</sub>-6alkil; NR<sub>8</sub>-C(O)-C<sub>1</sub>-6alkil; i NR<sub>8</sub>-C(O)-C(R<sub>3</sub>)=CR<sub>4</sub>(R<sub>5</sub>), gde R3 je H ili CN; R4 je H; i R5 je H ili ciklopropil;

A je izabran iz grupe koju čine: piridil; fenil; pirimidinil; pirazinil; piridin-2(1H)-on; i piridazinil; gde A je opciono supstituisan sa 1, 2, ili 3 supstituenata, od kojih je svaki nezavisno izabran iz grupe koju čine: halogen, C<sub>1</sub>-6alkil, C<sub>1</sub>-6haloalkil, i OC<sub>1</sub>-6alkil;

E je izabran iz grupe koju čine: O, veza, i CH<sub>2</sub>;

G je izabran iz grupe koju čine: H; halogen; C<sub>1</sub>-6alkil; C<sub>1</sub>-6haloalkil; NH(C<sub>1</sub>-6alkil); C<sub>3</sub>-6cikloalkil; fenil; pirimidinil; piridil; piridazinil; piridin-2(1H)-on; heterocikloalkil koji sadrži kiseonikov heteroatom; i fenil-CH<sub>2</sub>-O-fenil, gde -O-fenil je supstituisan sa CN; gde fenil; piridil; piridazinil; i piridin-2(1H)-on je opciono supstituisan sa 1, 2, ili 3 supstituenata, od kojih je svaki nezavisno izabran iz grupe koju čine:

halogen, C<sub>1</sub>-6alkil, C<sub>1</sub>-6haloalkil, OC<sub>1</sub>-6haloalkil, i OC<sub>1</sub>-6alkil; i

njegovi stereoizomeri i izotopske varijante; i

njegove farmaceutski prihvatljive soli.

**Patent sadrži još 18 patentnih zahtjeva**



(11) **03802** (13) **B**

(51) **A61K31/137**<sup>(2006.01)</sup>

**A61P37/06**<sup>(2006.01)</sup>

**A61K31/138**<sup>(2006.01)</sup>

**A61P37/00**<sup>(2006.01)</sup>

**A61K31/135**<sup>(2006.01)</sup>

**A61K31/661**<sup>(2006.01)</sup>

(21) P-2020-156

(22) 21.12.2009

(30) 20080139672P 22.12.2008 US

20090218530P 19.06.2009 US

20090246715P 29.09.2009 US

(96) 18201062.9/21.12.2009

(97) EP 3453387/13.03.2019/2019/11

EP 3453387/03.06.2020/2020/23

(54) me **REZIM DOZIRANJA AGONISTA S1P RECEPTORA**  
en **DOSAGE REGIMEN FOR A S1P RECEPTOR AGONIST**

(73) Novartis AG

Lichtstrasse 35, Basel, 4056/ CH

(72) SCHMOUDER, Robert

One Health Plaza, East Hanover, , New Jersey 07936/ US

DUMORTIER, Thomas

Postfach, 4002 Basel / CH

DAVID, Olivier

Postfach, 4002 Basel / CH

LOOBY, Michael

Postfach, 4002 Basel / CH

(57)

1. Upotreba modulatora ili agonista S1P receptora u proizvodnji leka za lečenje autoimunske bolesti, pri čemu je autoimunska bolest izabrana sa liste koja se sastoji od multiple skleroze, polimiozitisa, lupus nefritisa, reumatoidnog artritisa, zapaljenske bolesti creva i psorijaze, pri čemu se, pre otpočinjanja primene modulatora ili agonista SIP receptora u standardnoj dnevnoj terapijskoj dozi, navedeni modulator ili agonist S1P receptora primenjuje u dnevnoj dozi koja je niža od standardne dnevne terapijske doze tokom početnog perioda lečenja i pri čemu je najviša početna doza između 0,01 mg i 0,30 mg.

**Patent sadrži još 10 patentnih zahtjeva**

(11) **03806** (13) **B**

(51) **C07K 16/28**<sup>(2006.01)</sup>

**C07K 16/30**<sup>(2006.01)</sup>

**A61P 35/00**<sup>(2006.01)</sup>

**C07K 16/40**<sup>(2006.01)</sup>

**A61K 39/395**<sup>(2006.01)</sup>

(21) P-2020-157

(22) 19.11.2015

(30) 201462083056 P 21.11.2014 US

(96) 15816276.8/19.11.2015

(86) US PCT/US2015/061639/19.11.2015

(87) WO 2016/081748/26.05.2016/2016/21

(97) EP 3221363/27.09.2017/2017/39

EP 3221363/06.05.2020/2020/19

(54) me **ANTITELA PROTIV CD73 I NJIHOVA UPOTREBA**  
en **ANTIBODIES AGAINST CD73 AND USES THEREOF**

(73) BRISTOL-MYERS SQUIBB COMPANY

Route 206 and Province Line Road, Princeton, NJ 08543/ US

(72) LONBERG, Nils

700 Bay Road, Redwood City, CA 94063/ US

KORMAN, Alan J.

700 Bay Road, Redwood City, CA 94063/ US

BARNHART, Bryan C.

700 Bay Road, Redwood City, CA 94063/ US

YAMNIUK, Aaron P.

Route 206 & Province Line Road, Princeton, NJ 08543/ US

SRINIVASAN, Mohan

700 Bay Road, Redwood City, CA 94063/ US

HENNING, Karla A.

700 Bay Road, Redwood City, CA 94063/ US

LEI, Ming

Route 206 & Province Line Rd., Princeton, NJ 08543/ US

SEGA, Emanuela

700 Bay Rd., Redwood City, CA 94063/ US

GOODENOUGH, Angela

406 Stockham Ave., Morrisville, PA 19067/ US

JURE-KUNKEL, Maria N.

Route 206 & Province Line Rd., Princeton, NJ 08543/ US

CHEN, Guodong

Route 206 & Province Line Rd., Princeton, NJ 08543/ US

SACK, John

Route 206 & Province Line Rd., Princeton, NJ 08543/ US

HUANG, Richard

Route 206 & Province Line Rd., Princeton, NJ 08543/ US

CORBETT, Martin J.

Route 206 & Province Line Rd., Princeton, NJ 08543/ US

MYERS, Joseph E.

Route 206 & Province Line Rd., Princeton, NJ 08543/ US

SCHWEIZER, Liang

Beijing West Road 758 Long 15-1802, Shanghai PR/ CN

HATCHER, Sandra V.

Route 206 & Province Line Rd., Princeton, NJ 08543/ US

HUANG, Haichun

700 Bay Rd., Redwood City, CA 94063/ US

ZHANG, Pingping  
700 Bay Rd., Redwood City, CA 94063/ US

(57)

1. Izolovano antitelo koje se vezuje za humani klaster diferencijacije 73 (CD73) i sadrži CDR1, CDR2, i CDR3 sekvence teškog lanca koje sadrže SEK ID BROJEVA (SEQ ID NOs): 5, 6, i 7, redom, i CDR1, CDR2, i CDR3 sekvence lakog lanca koje sadrže SEQ ID NOs: 13, 14, i 15, redom, gde antitelo sadrži konstantni region teškog lanca koji sadrži IgG2 zglob i IgG2 CH1 domen.

**Patent sadrži još 13 patentnih zahtjeva**

(11) **03807** (13) **B**

(51) **C07D 403/12**<sup>(2006.01)</sup>

**C07D 401/06**<sup>(2006.01)</sup>

**C07D 403/04**<sup>(2006.01)</sup>

**C07D 413/04**<sup>(2006.01)</sup>

**C07D 471/04**<sup>(2006.01)</sup>

**C07D 487/10**<sup>(2006.01)</sup>

**A61K 31/4045**<sup>(2006.01)</sup>

**A61P 37/00**<sup>(2006.01)</sup>

**C07D 401/04**<sup>(2006.01)</sup>

**C07D 401/12**<sup>(2006.01)</sup>

**C07D 403/10**<sup>(2006.01)</sup>

**C07D 417/04**<sup>(2006.01)</sup>

**C07D 487/04**<sup>(2006.01)</sup>

**C07D 209/18**<sup>(2006.01)</sup>

**A61P 29/00**<sup>(2006.01)</sup>

(21) P-2020-158

(22) 23.10.2015

(30) 201462068225 P 24.10.2014 US

(96) 18205411.4/23.10.2015

(97) EP 3461821/03.04.2019/2019/14

EP 3461821/13.05.2020/2020/20

(54) me **JEDINJENJA INDOL KARBOKSAMIDA KORISNA KAO INHIBITORI KINAZE**  
en **INDOLE CARBOXAMIDE COMPOUNDS USEFUL AS KINASE INHIBITORS**

(73) BRISTOL-MYERS SQUIBB COMPANY

Route 206 and Province Line Road, Princeton, NJ 08543/ US

(72) AHMAD, Saleem

Route 206 and Province Line Road, Princeton, NJ 08543/ US

TEBBEN, Andrew J

Route 206 and Province Line Road, Princeton, NJ 08543/ US

GONG, Hua

Route 206 and Province Line Road, Princeton, NJ 08543/ US

LIU, Qingjie

Route 206 and Province Line Road, Princeton, NJ 08543/ US

NGU, Khehyong

Route 206 and Province Line Road, Princeton, NJ 08543/ US

WATTERSON, Scott Hunter

Route 206 and Province Line Road, Princeton, NJ 08543/ US

(57)

1. Jedinjenje sa Formulom (1):

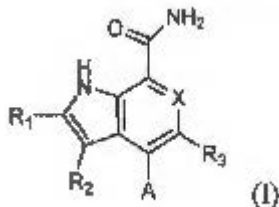

ili so istog, gde:

X je CR4;

A je:

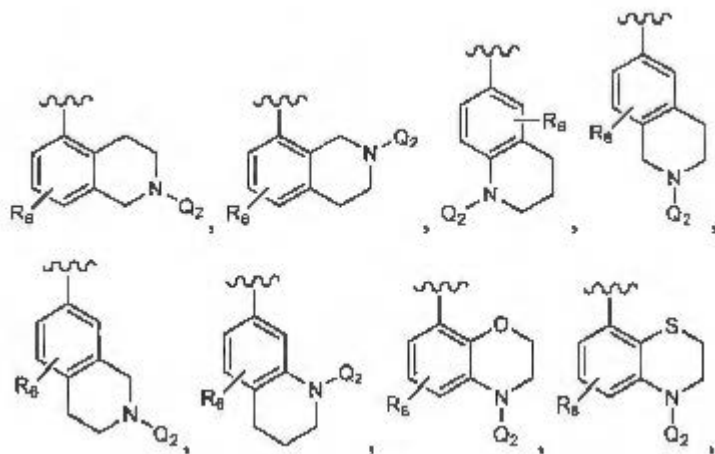

ili

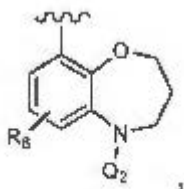

Q2 je  $-C(O)CH=CH_2$ ,  $-C(O)CH=CHCH_2N(CH_3)_2$ ,  $-C(O)C=CR_7$ ,  $-C(O)C=C(C1-3\text{hidroksialkil})$ ,  $-C(O)C=C(\text{fenil})$ ,  $-C(O)C=CSi(CH_3)_3$ , ili  $-S(O)_2CH=CH_2$ ;

R1 je H,  $-CH_3$ ,  $-CF_3$ , ili fenil supstituisan sa nula ili 1 R12;

R2 je H,  $-CH_3$ , ciklopropil, ili fenil supstituisan sa nula ili 1 R12, pod uslovom da najmanje jedan od R1 i R2 je  $-CH_3$ ;

R3 je F ili Cl;

R4 je H ili F;

R6 je H, F, Cl,  $-CF_3$ , ili C1-3 alkoksi;

R7, pri svakom pojavljivanju, je nezavisno H, C1-4 alkil, ili ciklopropil; i

R12 je F, Cl,  $-CN$ ,  $-CF_3$ , ili C1-3 alkoksi.

**Patent sadrži još 7 patentnih zahtjeva.**

(11) **03808** (13) **B**

(51) **C07K 14/47**<sup>(2006.01)</sup>

(21) P-2020-159

(22) 14.07.2016

(30) 201512369 15.07.2015 GB  
201562192670 P 15.07.2015 US

(96) 16739102.8/14.07.2016

(86) EP PCT/EP2016/066706/14.07.2016

(87) WO 2017/009400/19.01.2017/2017/03

(97) EP 3322717/23.05.2018/2018/21  
EP 3322717/10.06.2020/2020/24

(54) me **NOVI PEPTIDI I KOMBINACIJA PEPTIDA ZA UPOTREBU U IMUNOTERAPIJI ZA EPITELIJALNI KARCINOM JAJNIKA I DRUGE MALIGNIJE TUMORE**  
en **NOVEL PEPTIDES AND COMBINATION OF PEPTIDES FOR USE IN IMMUNOTHERAPY AGAINST EPITHELIAL OVARIAN CANCER AND OTHER CANCERS**

(73) immatics biotechnologies GmbH  
Paul-Ehrlich-Strasse 15, 72076 Tübingen/ DE

(72) SCHUSTER, Heiko  
Dorfackerstrasse 22, 72074 Tübingen/ DE  
PEPER, Janet

Friedrich-Schaal-Strasse 6, 72074 Tübingen/ DE  
WAGNER, Philipp

Bopserstrasse 2, 70180 Stuttgart/ DE  
RAMMENSEE, Hans-Georg  
Sommerhalde 3, 72070 Tübingen/ DE

(57)

1. Peptid koji sadrži aminokiselinsku sekvencu u skladu sa ID BR. SEKV 82.

**Patent sadrži još 13 patentnih zahtjeva.**

(11) **03809** (13) **B**

(51) **C07D 231/14**<sup>(2006.01)</sup>

**A01N 51/00**<sup>(2006.01)</sup>

**C07D 295/033**<sup>(2006.01)</sup>

**A61P 25/00**<sup>(2006.01)</sup>

(21) P-2020-160

(22) 16.10.2015

(30) 201462064957 P 16.10.2014 US

(96) 15851053.7/16.10.2015

(86) US PCT/US2015/056066/16.10.2015

(87) WO 2016/061537/21.04.2016/2016/16

(97) EP 3206493/23.08.2017/2017/34

EP 3206493/06.05.2020/2020/19

(54) me **KOMPOZICIJE I POSTUPCI ZA LEČENJE POREMEĆAJA CNS-a**  
en **COMPOSITIONS AND METHODS FOR TREATING CNS DISORDERS**

(73) Sage Therapeutics, Inc.

215 First Street, Cambridge, MA 02142/ US

(72) MARTINEZ BOTELLA, Gabriel

17 Parmenter Road, Wayland, MA 01778/ US

SALITURO, Francesco G.

25 Baker Drive, Marlborough, MA 01752/ US

ROBICHAUD, Albert Jean

2 Earhart Street 915, Cambridge, MA 02141/ US

HARRISON, Boyd L.

9 Wheatston Court, Princeton Junction, NJ 08550/ US

(57)

1. Jedinjenje formule **(I)**:

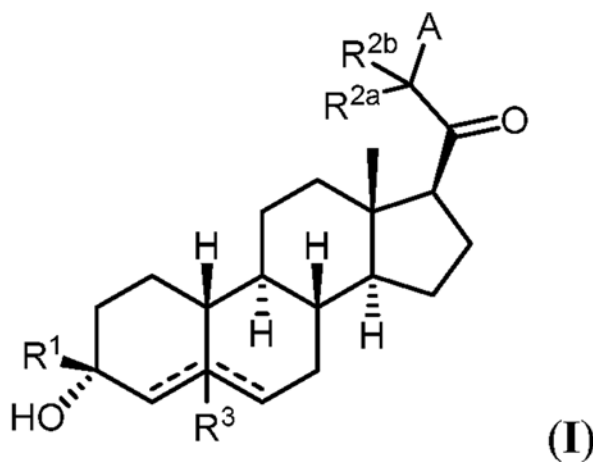

ili njegova farmaceutska prihvatljiva so, u kome:

A je 3-10 -člani heterociklil ili monociklični ili biciklični heteroaril;

R<sup>1</sup> je nesupstituisan C<sub>1</sub>-6 alkil ili -haloalkil;

R<sup>2a</sup> je nesupstituisan C<sub>1</sub>-6 alkil;

R<sup>2b</sup> je vodonik ili nesupstituisan C<sub>1</sub>-6 alkil;

ili R<sup>2a</sup> i R<sup>2b</sup> su spojeni tako da formiraju okso (=O) grupu;

ili R<sup>2a</sup> i R<sup>2b</sup> zajedno sa atomom ugljenika za koji su vezani formiraju 3-6-člani karbociklil ili heterociklil prsten;

R<sup>3</sup> je odsutan ili je vodonik; i

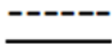

predstavlja jednogubu ili dvogubu vezu, pri čemu, kada je jedan od

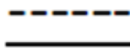

dvoguba veza, drugi

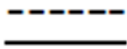

je jednoguba veza; i kada je jedan od

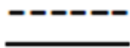

dvoguba veza, R3 je odsutan; gde je heterociklil ili heteroaril nesupstituisan; ili susptituisan sa najmanje jednim RA, gde je RA jednako C1-6 alkil, C2-6 alkenil, C2-6 alkinil, C3-6 karbociklil, C1-6 haloalkil, halogen, cijano, -ORA6, -C(=O)ORA6, -SRB6, -S(=O)RB6 ili S(=O)2RB6, gde je RA6 jednako vodonik ili C1-6 alkil, C2-6 alkenil, C2-6 alkinil, C3-6 karbociklil, ili C1-6 haloalkil, i RB6 je C1-6 alkil ili C3-6 karbociklil.

**Patent sadrži još 18 patentnih zahtjeva.**



(11) **03811** (13) **B**

(51) **C07H 21/00**<sup>(2006.01)</sup>  
**C12N 15/113**<sup>(2010.01)</sup>

**C12P 19/34**<sup>(2006.01)</sup>

(21) P-2020-161

(22) 21.04.2016

(30) 201562151891 P 23.04.2015 US

(96) 16720636.6/21.04.2016

(86) US PCT/US2016/028657/21.04.2016

(87) WO 2016/172346/27.10.2016/2016/43

(97) EP 3286203/28.02.2018/2018/09

EP 3286203/06.05.2020/2020/19

(54) me **POSTUPCI ZA PRIPREMU POLINUKLEOTIDA UPOTREBOM KOMPOZICIJA MULTIVALENTNE KATJONSKE SOLI**

en **METHODS OF POLYNUCLEOTIDE PREPARATION USING MULTIVALENT CATION SALT COMPOSITIONS**

(73) Geron Corporation

919 E. Hillsdale Blvd., Foster City, CA 94404/ US

(72) RAMIYA, Premchandran H.

1416 Allamere Drive, San Ramon, California 94582/ US

(57)

1. Postupak za pripremu polinukleotida, pri čemu postupak sadrži:

- a) dovođenje u kontakt prve polinukleotidne kompozicije sa multivalentnom katjonskom solju kako bi se istaložila prva polinukleotidna so;
- b) razdvajanje prve polinukleotidne soli od prve polinukleotidne kompozicije dovedene u kontakt, kako bi se dobila druga polinukleotidna kompozicija koja sadrži prvu polinukleotidnu so;

gde prva polinukleotidna kompozicija sadrži:

(i) polinukleotid koji ima sekvencu od 7 ili više nukleozidnih subjedinica i najmanje dve od nukleozidnih subjedinica su povezane N3'→P5' tiofosforamidatnom vezom između subjedinica;

i

(ii) solubilne proizvode i reagense sinteze koji nisu cilj sinteze

c) dovođenje u kontakt druge polinukleotidne kompozicije iz koraka (b) sa nosačem za reverzno-faznu hromatografiju;

i

d) eluciju sa nosača za reverzno-faznu hromatografiju treće polinukleotidne kompozicije koja sadrži drugu solubilnu polinukleotidnu so.

**Patent sadrži još 27 patentnih zahtjeva.**

(11) **03814** (13) **B**

(51) **A61K39/395**<sup>(2006.01)</sup>

**C07K16/24**<sup>(2006.01)</sup>

**A61K47/26**<sup>(2006.01)</sup>

**A61K39/00**<sup>(2006.01)</sup>

**G01N33/567**<sup>(2006.01)</sup>

**A61K9/00**<sup>(2006.01)</sup>

**A61K9/08**<sup>(2006.01)</sup>

**A61K47/18**<sup>(2017.01)</sup>

(21) P-2020-162

(22) 28.12.2006

(30) 20050754889P 29.12.2005 US

(96) 17156111.1/28.12.2006

(97) EP 3219328/20.09.2017/2017/38

EP 3219328/17.06.2020/2020/25

(54) me **HUMANA ANTI-IL-23 ANTITELA, KOMPOZICIJE, POSTUPCI I UPOTREBE**  
en **HUMAN ANTI-IL-23 ANTIBODIES, COMPOSITIONS, METHOD AND USES**

(73) Janssen Biotech, Inc.

800/850 Ridgeview Drive, Horsham, PA 19044/ US

(72) BENSON, Jacqueline

5 Oak Glen Drive, Malvern, PA 19355/ US

CARTON, Jill

3787 Kratz Road, Collegeville, PA 19426/ US

CUNNINGHAM, Mark

716 Garden Drive, Kennett Square, PA 19348/ US

ORLOVSKY, Yevgeniya I.

2804 Century Lane, Chadds Ford, PA 19317/ US

RAUCHENBERGER, Robert

Esterbergstrasse 9, Farchant 82490 / DE

SWEET, Raymond

700 Oak Spring Road, Bryn Mawr, PA 19010/ US

(57)

1. Izolovano IL-23p19 antitelo, u kome pomenuto antitelo je potpuno humano generisano iz izoljenog faga i vezuje se za IL-23p 19 ili njegov fragment, gde se pomenuto antitelo vezuje za humani IL-23p19 na jednom ili više aminokiselinskih ostataka 93-105 SEK 10 BR:145.

**Patent sadrži još 11 patentnih zahtjeva.**

(11) **03815** (13) **B**

(51) **C07D 401/04**<sup>(2006.01)</sup>  
**A61K 31/4184**<sup>(2006.01)</sup>

**A61K 31/4439**<sup>(2006.01)</sup>

**A61P 35/00**<sup>(2006.01)</sup>

(21) P-2020-163

(22) 04.06.2013

(30) 201261656888 P 07.06.2012 US

(96) 18157435.1/04.06.2013

(97) EP 3348553/18.07.2018/2018/29

EP 3348553/08.07.2020/2020/28

(54) me **KRISTALNI OBLICI MODULATORA RECEPTORA ANDROGENA**  
en **CRYSTALLINE FORMS OF AN ANDROGEN RECEPTOR MODULATOR**

(73) ARAGON PHARMACEUTICALS, INC.,  
10990 Wilshire Blvd. Suite 300, Los Angeles, CA 90024/ US  
SLOAN-KETTERING INSTITUTE FOR CANCER RESEARCH  
1275 York Avenue, New York, NY 10065/ US

(72) DILHAS, Anna  
Häsingerstr. 32, 4055 Basel/ CH

OUERFELLI, Ouathek  
2077 Center Avenue, Apt. 3J, Fort Lee, NJ 07024/ US

SMITH, Nicholas D.  
1204 Beryl Street, San Diego, CA 92109/ US

HERBERT, Mark R.  
4180 Amoroso Street, San Diego, CA 92111/ US

(57)

1. Kristalni oblik A 4-[7-(6-cijano-5-trifluorometilpiridin-3-il)-8-okso-6-tiokso-5,7-diazaspiro[3.4]okt-5-il]-2-fluoro-N-metilbenzamida, što ima najmanje jednu od karakterisitka:

(a) spektar difrakcije X-zraka praha (XRPD), sa karakterističnim pikovima na  $4.8 \pm 0.1^\circ$  2-teta,  $7.1 \pm 0.1^\circ$  2-teta,  $14.2 \pm 0.1^\circ$  2-teta,  $16.3 \pm 0.1^\circ$  2-teta,  $20.1 \pm 0.1^\circ$  2-teta;

(b) parametre jedinične ćelije koji su jednaki sledećem na  $-173^\circ\text{C}$ :

Kristalni sistem	Ortorombični			
		<i>a</i>	16.3429(3) Å	⊘ 90°
Prostorna grupa	<i>P2(1)2(1)2</i>	<i>b</i>	37.7298(7) Å	⊘ 90°
		<i>c</i>	7.23410(10) Å	⊘ 90°
<i>V</i>	4460.65(16) Å <sup>3</sup>			
<i>Z</i>	8			
<i>D<sub>c</sub></i>	1446 g·cm <sup>-1</sup>			

i opciono:

(c) isti spektar difrakcije X-zraka praha (XRPD), kao što je (a), posle skladištanja na  $40^\circ\text{C}$  i 75% RV (relativne vlažnosti), tokom najmanje nedelju dana;

(d) DSK termogram sa endotermom koji ima početak na temperaturi  $108-120^\circ\text{C}$  i maksimum na  $133-135^\circ\text{C}$ ; ili

(e) njihovu kombinaciju.

**Patent sadrži još 14 patentnih zahtjeva.**

(11) **03816** (13) **B**

(51) **A61K 35/74**<sup>(2015.01)</sup>

**A61P 29/00**<sup>(2006.01)</sup>

**A61P 35/00**<sup>(2006.01)</sup>

(21) P-2020-164

(22) 23.11.2016

(30) 20150020638 23.11.2015 GB

(96) 18159098.5/23.11.2016

(97) EP 3360558/15.08.2018/2018/33

EP 3360558/15.07.2020/2020/29

(54) me **KOMPOZICIJE KOJE SADRŽE BAKTERIJSKE SOJEVE**  
en **COMPOSITIONS COMPRISING BACTERIAL STRAINS**

(73) 4D PHARMA RESEARCH LIMITED

Life Sciences Innovation Building, Cornhill Road, Aberdeen, Aberdeenshire AB25 2ZS/ GB

(72) MULDER, Imke Elisabeth

Life Sciences Innovation Building, Cornhill Road, Aberdeen, Aberdeenshire AB25 2ZS/ GB

HOLT, Amy Beth

Life Sciences Innovation Building, Cornhill Road, Aberdeen, Aberdeenshire AB25 2ZS/ GB

MCCLUSKEY, Seanin Marie

Life Sciences Innovation Building, Cornhill Road, Aberdeen, Aberdeenshire AB25 2ZS/ GB

LENNON, Grainne Clare

Life Sciences Innovation Building, Cornhill Road, Aberdeen, Aberdeenshire AB25 2ZS/ GB

AHMED, Suaad

Life Sciences Innovation Building, Cornhill Road, Aberdeen, Aberdeenshire AB25 2ZS/ GB

(57)

1. Kompozicija koja sadrži jedan bakterijski soj vrste *Eubacterium contortum*, pn čemu kompozicija ne sadrži bilo koje druge bakterijske sojeve ili vrste ili gde kompozicija sadrži samo minimalne ili biološki nerelevante količine drugih bakterijskih sojeva ili vrsta za upotrebu u terapiji .

**Patent sadrži još 15 patentnih zahtjeva.**

(11) **03818** (13) **B**

(51) **A23L 7/126**<sup>(2016.01)</sup>

**A23L 17/00**<sup>(2016.01)</sup>

(21) P-2020-165

(22) 22.07.2019

(30) 20180100352 30.07.2018 GR

(96) 19386035.0/22.07.2019

(97) EP 3603413/05.02.2020/2020/06

EP 3603413/22.07.2020/2020/30

(54) me **POHOVANI ZGRUDVANI PROIZVOD KOJI SADRŽI KOMADIĆE OLJUŠTENIH ŠKAMPI ILI DRUGIH OLJUŠTENIH MORSKIH PLODOVA KOJI IMAJU LJUŠTURU I POSTUPAK ZA PROIZVODNJU TOG PROIZVODA**

en **BREADED NUGGET PRODUCT CONTAINING PEELED SHRIMP OR OTHER PEELED SHELL-BEARING CATCH PIECES AND PRODUCT PRODUCTION METHOD**

(73) ATHANASIOS CHATZISOTIRIOU ABEE ALIEVMATON SA with distinguishing title AQUA TRADE SA  
Keramida, Nea Mihaniona,, 57004 Nea Mihaniona (Thessaloniki)/ GR

(72) Chatzisotiriou, Athanasios

P.O. Box 212, 57004 Nea Michaniona (Thessaloniki)/ GR

(57)

1. Pohovani zgrudvani proizvod koji sadrži komadiće celih oljuštenih škampi ili drugih oljuštenih morskih plodova, koji sadrži 40% do 60% mešavine za pohovanje, koja sadrži prezle, brašna i kašastu mešavinu i 60% do 40% mešavine oljuštenih škampi ili drugih oljuštenih morskih plodova, **naznačen time**, što mešavina oljuštenih škampi ili drugih oljuštenih morskih plodova sadrži mešavinu usitnjene ljuštore škampi ili drugih morskih plodova i vode, koja se koristi kao sredstvo za bojenje i vezivni materijal za oljuštene škampe ili druge oljuštene morske plodove bez upotrebe sintetičkih supstanci za bojenje, pri čemu se ova mešavina ne koristi kao materijal za pohovanje.

**Patent sadrži još 14 patentnih zahtjeva.**

(11) **03819** (13) **B**

(51) **A61K39/395**<sup>(2006.01)</sup>

**C07K16/46**<sup>(2006.01)</sup>

**A61K39/00**<sup>(2016.01)</sup>

**C07K16/28**<sup>(2006.01)</sup>

**C12P21/08**<sup>(2006.01)</sup>

(21) P-2020-166

(22) 22.03.2016

(30) 201562137034P 23.03.2015 US

201562147484P 14.04.2015 US

201562156588P 04.05.2015 US

201562242489P 16.10.2015 US

201562255635P 16.11.2015 US

(96) 16769535.2/22.03.2016

(86) WO PCT/US2016/023524/22.03.2016

(87) WO 2016/154177/29.09.2016/2016/39

(97) EP 3273992/31.01.2018/2018/05

EP 3273992/13.05.2020/2020/20

(54) me **ANTITELA ZA ICOS**

en **ANTIBODIES TO ICOS**

(73) Jounce Therapeutics, Inc.

780 Memorial Drive, Cambridge, MA 02139/ US

(72) SAZINSKY, Stephen

780 Memorial Drive,, Cambridge, Massachusetts 02139/ US

MICHAELSON, Jennifer S.

780 Memorial Drive,, Cambridge, Massachusetts 02139/ US

SATHYANARAYANAN, Sriram

780 Memorial Drive,, Cambridge, Massachusetts 02139/ US

ELPEK, Kutlu Goksu

780 Memorial Drive,, Cambdridge, Massachusetts 02139/ US

(57)

1. Izolovano monoklonsko antitelo koje se vezuje za ICOS, naznačeno time što antitelo sadrži (a) HCDR1 koji sadrži sekvencu amino-kiselina SEQ ID NO: 62; (b) HCDR2 koji sadrži sekvencu amino-kiselina SEQ ID NO: 63; (c) HCDR3 koji sadrži sekvencu amino- kiselina SEQ ID NO: 64; (d) LCDR1 koji sadrži sekvencu amino-kiselina SEQ D NO: 65; (e) LCDR2 koji sadrži sekvencu amino-kiselina SEQ ID NO: 66; i (f) LCDR3 koji sadrži sekvencu amino-kiselina SEQ ID NO: 67, i što antitelo sadrži konstantni region teškog lanca humani IgG1 ili konstantni region teškog lanca humanog IgG3.

**Patent sadrži još 17 patentnih zahtjeva.**

(11) **03812** (13) **B**

(51) **A61K 31/27**<sup>(2006.01)</sup>

**A61K 31/5377**<sup>(2006.01)</sup>

**A61P 25/28**<sup>(2006.01)</sup>

**A61K 31/445**<sup>(2006.01)</sup>

**A61K 31/55**<sup>(2006.01)</sup>

(21) P-2020-167

(22) 14.08.2017

(30) 201641028166 18.08.2016 IN

(96) 17768234.1/14.08.2017

(86) IB PCT/IB2017/054938/14.08.2017

(87) WO 2018/033847/22.02.2018/2018/08

(97) EP 3500253/26.06.2019/2019/26

EP 3500253/24.06.2020/2020/26

(54) me **KOMBINACIJA INVERZNIH AGONISTA HISTAMIN-3 RECEPTORA SA INHIBITORIMA**

**ACETILHOLINESTERAZE**

en **COMBINATION OF HISTAMINE-3 RECEPTOR INVERSE AGONISTS WITH ACETYLCHOLINESTERASE**

**INHIBITORS**

(73) Suven Life Sciences Limited

5th Floor Serene Chambers, Road No. 5, Off Avenue 7, Banjara Hills, Hyderabad, Telangana 500034/ IN

(72) NIROGI, Ramakrishna

Suven Life Sciences Limited, Serene Chambers Road-5 Avenue 7, Banjara Hills, Hyderabad Telangana 500034/ IN  
SHINDE, Anil Karbhari

Suven Life Sciences Limited, Serene Chambers Road-5 Avenue 7, Banjara Hills, Hyderabad Telangana 500034/ IN  
MOHAMMED, Abdul Rasheed

Suven Life Sciences Limited, Serene Chambers Road-5 Avenue 7, Banjara Hills, Hyderabad Telangana 500034/ IN  
JAYARAJAN, Pradeep

Suven Life Sciences Limited, Serene Chambers Road-5 Avenue 7, Banjara Hills, Hyderabad Telangana 500034/ IN  
BHYRAPUNENI, Gopinadh

Suven Life Sciences Limited, Serene Chambers Road-5 Avenue 7, Banjara Hills, Hyderabad Telangana 500034/ IN  
JASTI, Venkateswarlu

Suven Life Sciences Limited, Serene Chambers Road-5 Avenue 7, Banjara Hills, Hyderabad Telangana 500034/ IN  
(57)

1. Kombinacija koja sadrži inverzni agonist histamin-3 receptora i inhibitor acetilholinesteraze; naznačena time da je inverzni agonist histamin-3 receptora izabran iz grupe koja se sastoji od:

N-[4-(1-Ciklobutylpiperidin-4-iloksi)fenil]-2-(morfolin-4-il)acetamida;

N-[4-(1-Ciklopropilpiperidin-4-iloksi)fenil]-2-(morfolin-4-il)acetamida; i

N-[4-(1-Izopropilpiperidin-4-iloksi)fenil]-2-(morfolin-4-il)acetamida;

ili njihove farmaceutske prihvatljive soli.

**Patent sadrži još 17 patentnih zahtjeva.**

(11) **03813** (13) **B**

(51) **C07K 16/28**<sup>(2006.01)</sup>

(21) P-2020-168

(22) 15.04.2011

(30) 324944 P 16.04.2010 US

(96) 17163411.6/15.04.2011

(97) EP 3202789/09.08.2017/2017/32

EP 3202789/06.05.2020/2020/19

(54) me **ANTI-VLA-4 ANTITELA**  
en **ANTI-VLA-4 ANTIBODIES**

(73) Biogen MA Inc.

225 Binney Street, Cambridge, MA 02142/ US

(72) LUGOVSKOY, Alexey A.

35 Audrey Road,, Belmont, MA 02478/ US

TAYLOR, Frederick R.

98 Gulliver Street,, Milton, MA 02186/ US

MCLACHLAN, Karen

948 Valley Ave,, Solana Beach, CA 92075/ US

(57)

1. Farmaceutska kompozicija koja sadrži molekul rekombinantnog antitela, ili njegov  $\alpha$ 4-vezujući fragment, koji sadrži varijabilni teški lanac i varijabilni laki lanac, naznačena time što:

(a) varijabilni teški lanac sadrži sekvencu regiona okvira varijabilnog teškog lanca iz IGHV1-f i CDR iz VH lanca murinskog antitela HPI/2, pri čemu CDRI sadrži sekvencu GFNIKDTYM, CDR2 sadrži sekvencu RIDP ASGDTKYDPKFQV i CDR3 sadrži sekvencu GMWVSTGYALDF, i amino-

kiselinski ostaci na pozicijama regiona okvira 24 i 94 varijabilnog teškog lanca u skladu sa Kabat šemom numeracije su supstituisani, pri čemu supstituisani ostatak na poziciji regiona okvira 24 je alanin (A) i supstituisani ostatak na poziciji regiona okvira 94 je asparaginska kiselina (D);

(b) varijabilni laki lanac sadrži sekvencu regiona okvira varijabilnog lakog lanca iz IGKV4-1 i CDR iz VL lanca murinskog antitela HPI /2, pri čemu CDRI sadrži sekvencu KASQSVTNDVA, CDR2 sadrži sekvencu YASNRYT i CDR3 sadrži sekvencu QQDYSSPYT, i amino-kiselinski ostaci na

pozicijama regiona okvira 1, 67 i 87 varijabilnog lakog lanca u skladu sa Kabat šemom numeracije su supstituisani, pri čemu supstituisani ostatak na poziciji regiona okvira 1 je serin (S), supstituisani ostatak na poziciji regiona okvira 67 je tirozin (Y) i supstituisani ostatak na poziciji regiona

okvira 87 je fenilalanin (F);

i pri čemu molekul rekombinantnog antitela ili njegov  $\alpha$ 4-vezujući fragment vezuje VLA-4.

**Patent sadrži još 5 patentnih zahtjeva.**



(11) **03820** (13) **B**

(51) **C07D 487/04**<sup>(2006.01)</sup>

**A61K 31/437**<sup>(2006.01)</sup>

**A61K 31/519**<sup>(2006.01)</sup>

(21) P-2020-169

(22) 07.04.2017

(30) 20160000221 12.04.2016 DK

(96) 17715943.1/07.04.2017

(86) EP PCT/EP2017/058332/07.04.2017

(87) WO 2017/178350/19.10.2017/2017/42

(97) EP 3442975/20.02.2019/2019/08

EP 3442975/29.07.2020/2020/31

(54) me **1,5-DIHIDRO-4H-PIRAZOLO[3,4-D]PIRIMIDIN-4-ONI I 1,5-DIHIDRO-4H-PIRAZOLO[4,3-C]PIRIDIN-4-ONI KAO PDE1 INHIBITORI**

en **1,5-DIHYDRO-4H-PYRAZOLO[3,4-D]PYRIMIDIN-4-ONES AND 1,5-DIHYDRO-4H-PYRAZOLO[4,3-C]PYRIDIN-4-ONES AS PDE1 INHIBITORS**

(73) H. Lundbeck A/S

Ottiliavej 9, Valby, 2500 / DK

(72) JUHL, Karsten

Ottiliavej 9,, 2500 Valby/ DK

JESSING, Mikkel

Ottiliavej 9,, 2500 Valby/ DK

LANGGÅRD, Morten

Ottiliavej 9,, 2500 Valby/ DK

VITAL, Paulo Jorge Vieira

Ottiliavej 9,, 2500 Valby/ DK

MARIGO, Mauro

Ottiliavej 9,, 2500 Valby/ DK

KEHLER, Jan

Ottiliavej 9,, 2500 Valby/ DK

RASMUSSEN, Lars Kyhn

Ottiliavej 9,, 2500 Valby/ DK

(57)

1.Jedinjenje formule (I)

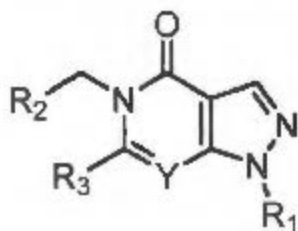

(I)

u kojoj

Y je N ili CH;

R1 je odabrano iz grupe koju čine ravni ili razgranati C<sub>2</sub>-C<sub>8</sub> alkil, zasićeni monociklični C<sub>3</sub>-C<sub>8</sub> cikloalkil, oksetanil, tetrahidrofuranil i tetrathidropiranil; od kojih svi mogu biti supstituisani jednom ili više puta jednim ili više supstituenata odabranih iz grupe koju čine metil, fluor, hidroksi, cijano i metoksi;

R2 je odabrano iz grupe koju čine, ravni ili razgranati C<sub>1</sub>-C<sub>8</sub> alkil, fenil, benzo[1,3]dioksol i zasićeni monociklični C<sub>3</sub>-C<sub>8</sub> cikloalkil; ili

R2 je fenil supstituisan jednom ili više puta jednim ili više supstituenata odabranih iz grupe koju čine halogen, C<sub>1</sub>-C<sub>3</sub> alkil i metoksi; ili

R2 je piridin supstituisan supstituentom odabranim iz grupe koju čine halogen, C<sub>1</sub>-C<sub>3</sub> alkil, C<sub>1</sub>-C<sub>3</sub>alkoksi, C<sub>1</sub>-C<sub>3</sub> fluoroalkoksi, C<sub>3</sub>-C<sub>4</sub> cikloalkoksi i C<sub>4</sub>-C<sub>5</sub> metilcikloalkoksi; ili

R2 je odabrano iz grupe koju čine 5-člani heteroarili supstituisani C<sub>1</sub>-C<sub>3</sub> alkilom;

R3 je odabrano iz grupe koju čine ravni ili razgranati C<sub>1</sub>-C<sub>3</sub> alkil i zasićeni monociklični C<sub>3</sub>-C<sub>8</sub> cikloalkil; pri čemu svaki može biti opciono supstituisan supstituentom odabranim iz grupe koju čine halogen, C<sub>1</sub>-C<sub>3</sub> alkoksi, fenil, dialkilamin i oksetan;

i njegovi tautomeri i farmaceutski prihvatljive soli.

**Patent sadrži još 14 patentnih zahtjeva.**

(11) **03821** (13) **B**

(51) **A61K 31/4985**<sup>(2006.01)</sup>

**A61K 31/55**<sup>(2006.01)</sup>

**A61P 25/18**<sup>(2006.01)</sup>

**A61P 25/24**<sup>(2006.01)</sup>

**A61K 31/5377**<sup>(2006.01)</sup>

**A61K 45/06**<sup>(2006.01)</sup>

**A61P 25/22**<sup>(2006.01)</sup>

**A61P 25/28**<sup>(2006.01)</sup>

(21) P-2020-170

(22) 26.10.2017

(30) 2016PA00659 28.10.2016 DK

(96) 17791080.9/26.10.2017

(86) EP PCT/EP2017/077497/26.10.2017

(87) WO 2018/078038/03.05.2018/2018/18

(97) EP 3532064/04.09.2019/2019/36

EP 3532064/29.07.2020/2020/31

(54) me **KOMBINOVANE TERAPIJE KOJE OBUHVATAJU IMIDAZOPIRAZINONE ZA LEČENJE PSIHIJATRIJSKIH I/ILI KOGNITIVNIH POREMEĆAJA**

en **COMBINATION TREATMENTS COMPRISING IMIDAZOPYRAZINONES FOR THE TREATMENT OF PSYCHIATRIC AND/OR COGNITIVE DISORDERS**

(73) H. LUNDBECK A/S

Ottiliavej 9 , Valby, 2500 / DK

(72) KEHLER, Jan

Ottiliavej 9,, 2500 Valby/ DK

RASMUSSEN, Lars Kyhn

Ottiliavej 9,, 2500 Valby/ DK

LANGGÅRD, Morten

Ottiliavej 9,, 2500 Valby/ DK

JESSING, Mikkel

Ottiliavej 9,, 2500 Valby/ DK

VITAL, Paulo Jorge Vieira

Ottiliavej 9,, 2500 Valby/ DK

JUHL, Karsten

Ottiliavej 9,, 2500 Valby/ DK

(57)

1. 1) Jedinjenje formule (I)

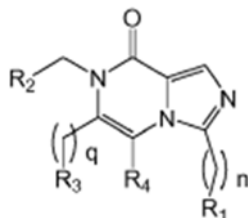

(I)

u kojoj

n predstavlja 0 ili 1;

q predstavlja 0 ili 1;

R1 je izabran iz grupe koju čine benzil, indanil, indolin i 5-člani heteroarili; pri čemu svi oni mogu biti supstituisani supstituentom izabranim iz grupe koju čine halogen i C1-C3 alkil; ili

R1 je izabran iz grupe koju čine zasićeni monociklični prstenovi koji sadrže 4-6 atoma ugljenika i 1-2 atoma azota; pri čemu svi oni mogu biti supstituisani jednom ili više puta jednim ili više supstituenata izabranih iz grupe koju čine metil, fluor i sulfonamid; ili

R1 je izabran iz grupe koju čine laktami koji sadrže 4-6 atoma ugljenika; pri čemu svi oni mogu biti supstituisani jednom ili više puta jednim ili više supstituenata izabranih iz grupe koju čine metil i fluor; ili

R1 je izabran iz grupe koju čine biciklični etri kao što je, 7-oksabiciklo[2.2.1]heptan; pri čemu svi oni mogu biti supstituisani jednom ili više puta jednim ili više supstituenata izabranih iz grupe koju čine metil i fluor; ili

R1 je izabran iz grupe koju čine linearni ili razgranati C1-C8 alkil, zasićeni monociklični C3-C8 cikloalkil, oksetanil, tetrahidrofurani i tetrahidropirani; pri čemu svi oni mogu biti supstituisani jednom ili više puta jednim ili više supstituenata izabranih iz grupe koju čine metil, fluor, hidroksi, cijano ili metoksi; ili

R1 predstavlja linearni ili razgranati C1-C3 alkil, koji je supstituisan supstituentom izabranim iz grupe koju čine fenil i 5-člani heteroaril, pri čemu pomenuti 5-člani heteroaril može biti supstituisan jednim ili više C1-C3 alkila; ili

R1 je izabran iz grupe koju čine morfolin, tetrahidrofur-3-amin, heksahidro-2*H*-furo[3,2-*b*]pirol i homomorfolin; pri čemu svi oni mogu biti supstituisani jednim ili više supstituenata izabranih iz grupe koju čine C1-C3 alkil;

R2 je izabran iz grupe koju čine vodonik, linearni ili razgranati C1-C8 alkil, fenil, zasićeni monociklični C3-C8 cikloalkil, oksetanil, benzo[*d*][1,3]dioksolil, tetrahidrofurani i tetrahidropirani; ili

R2 predstavlja fenil ili piridil supstituisan jednim ili više supstituenata izabranih iz grupe koju čine hidroksil, amino, cijano, halogen, C1-C3 alkil, C1-C3 alkoksi, C3-C5 cikloalkoksi, C3-C5 cikloalkil-metoksi, C1-C3 fluoroalkoksi, i -NC(O)CH<sub>3</sub>; ili

R2 predstavlja 5-člani heteroaril koji može biti supstituisan jednim ili više C1-C3 alkila;

R3 je izabran iz grupe koju čine vodonik, halogen, C1-C5 alkil, C3-C5 cikloalkil i fenil; ili

R3 je izabran iz grupe koju čine fenil supstituisan jednom ili više puta C1-C3 alkilom; metil supstituisan jednom, dva ili tri puta fluorom; etil supstituisan jednom, dva ili tri puta fluorom;

R4 predstavlja vodonik;

i njegovi tautomeri i farmaceutski prihvatljive adicione soli;

pod uslovom da R2 i R3 ne mogu predstavljati vodonik u isto vreme; i

2) drugo jedinjenje, pri čemu je to jedinjenje korisno u lečenju psihijatrijskog poremećaja; pri čemu je pomenuto drugo jedinjenje izabrano iz grupe koju čine klozapin, risperidon, paliperidon, olanzapin, kvetijapin, amisulprid, ziprasidon, aripiprazol, breksiprazol, asenapin, haloperidol, iloperidon, lurasidon, hloropromazin, blonanserin, perfenazin, levomepromazin, sulpirid, flufenazin, zuklopentiksol, flupentiksol i kariprazin; pri čemu su 1) i 2) za kombinovanu upotrebu u lečenju psihijatrijskog i/ili kognitivnog poremećaja.

**Patent sadrži još 9 patentnih zahtjeva.**

(11) **03817** (13) **B**

(51) **C07H 19/10**<sup>(2006.01)</sup>

**A61P 35/00**<sup>(2006.01)</sup>

**A61K 31/7068**<sup>(2006.01)</sup>

(21) P-2020-171

(22) 25.06.2015

(30) 201411253 25.06.2014 GB  
2050MU2014 25.06.2014 IN

(96) 15733497.0/25.06.2015

(86) GB PCT/GB2015/051857/25.06.2015

(87) WO 2015/198058/30.12.2015/2015/52

(97) EP 3160978/03.05.2017/2017/18  
EP 3160978/29.07.2020/2020/31

(54) me **PROLEKOVI GEMCITABINA**  
en **GEMCITABINE PRODRUGS**

(73) NuCana plc

3 Lochside Way, Edinburgh EH12 9DT/ GB

(72) GRIFFITH, Hugh

10 Lochside Place, Edinburgh Scotland EH12 9RG/ GB

MCGUIGAN, Christopher

Redwood Building, King Edward VII Avenue, Cardiff South Glamorgan CF10 3NB/ GB

SLUSARCZYK, Magdalena

Redwood Building, King Edward VII Avenue, Cardiff South Glamorgan CF10 3NB/ GB

SERPI, Michaela

Redwood Building, King Edward VII Avenue, Cardiff South Glamorgan CF10 3NB/ GB

FERRARI, Valentina

83 West Cliff Road, Ramsgate CT11 9NS/ GB

(57)

1. Farmaceutska formulacija koja sadrži gemcitabin-[fenil-benzoksi-L-alaninil]-(S)-fosfat 3:

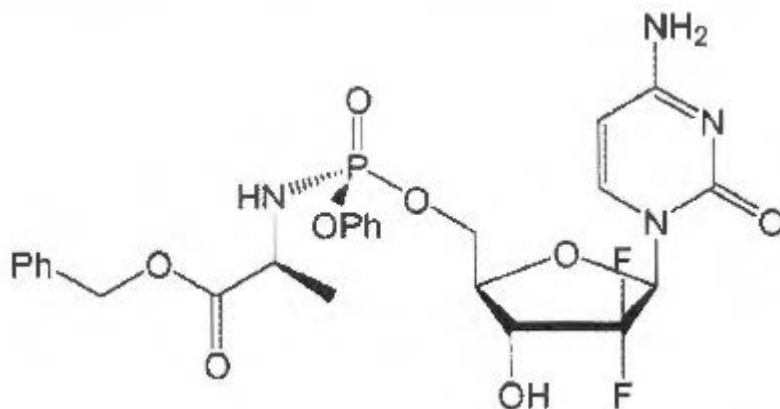

ili njegovu farmaceutski prihvatljivu so ili solvat, koji ima diastereoizomernu čistoću veću od 90% i najmanje jedan farmaceutski prihvatljiv ekscipijens; pri čemu je formulacija vodena formulacija koja takode sadrži polarni organski rastvarač.

**Patent sadrži još 10 patentnih zahtjeva.**

(11) **03822** (13) **B**

(51) **C07D 231/18**<sup>(2006.01)</sup>

**A61P 29/00**<sup>(2006.01)</sup>

**A61K 31/415**<sup>(2006.01)</sup>

(21) P-2020-173

(22) 23.04.2019

(30) 201806578 23.04.2018 GB

(96) 19721230.1/23.04.2019

(86) EP PCT/EP2019/060311/23.04.2019

(87) WO 2019/206871/31.10.2019/2019/44

(97) EP 3606909/12.02.2020/2020/07

EP 3606909/27.05.2020/2020/22

(54) me **NATRIJUMOVA SO N-((1,2,3,5,6,7-HEKSAHIDRO-S-INDACEN-4-IL)KARBAMOIL)-1-IZOPROPIL-1 H-PIRAZOL- 3-SULFONAMIDA**  
en **A SODIUM SALT OF N-((1,2,3,5,6,7-HEXAHYDRO-S-INDACEN-4-YL)CARBAMOYL)-1 -ISOPROPYL-1 H-PYRAZOLE-3-SULFONAMIDE**

(73) Inflazome Limited

88 Harcourt Street, Dublin 2/ IE

(72) MILLER, David

D6 Grain House, Mill Court,, Great Shelford, Cambridge CB22 5LD/ GB

MACLEOD, Angus

D6 Grain House, Mill Court,, Great Shelford, Cambridge CB22 5LD/ GB

DEL RIO GANCEDO, Susana

Pharmorphix® Solid State Services, 250 Cambridge Science Park, Milton Road,, Cambridge CB4 0WE/ GB

STRATFORD, Samuel Alexander

Pharmorphix® Solid State Services, 250 Cambridge Science Park, Milton Road,, Cambridge CB4 0WE/ GB

(57)

1. Natrijumova so *N-((1,2,3,5,6,7-heksahidro-s-indacen-4-il)karbamoiil)-1-izopropil-1H-pirazol-3-sulfonamida*, ili njen hidrat ili solvat.

**Patent sadrži još 16 patentnih zahtjeva.**

(11) **03828** (13) **B**

(51) **C07D 487/04**<sup>(2006.01)</sup>

**A61P 3/00**<sup>(2006.01)</sup>

**A61K 31/551**<sup>(2006.01)</sup>

**A61P 25/00**<sup>(2006.01)</sup>

(21) P-2020-175

(22) 14.04.2016

(30) P1500169 15.04.2015 HU

(96) 16718017.3/14.04.2016

(86) IB PCT/IB2016/052110/14.04.2016

(87) WO 2016/166684/20.10.2016/2016/42

(97) EP 3286193/28.02.2018/2018/09

EP 3286193/27.05.2020/2020/22

(54) me **DERIVATI INDOLA**  
en **INDOLE DERIVATIVES**

(73) RICHTER GEDEON NYRT.

Gyömrői út 19-21, Budapest, 1103/ HU

(72) BEKE, Gyula

Kert u. 7-9., H-2092 Budakeszi/ HU

ÉLES, János

Ördögszikla út 2., H-1121 Budapest/ HU

BOROS, András

Kamilla u. 7., H-2112 Veresegyház/ HU

FARKAS, Sándor

Olajliget u. 42., H-1103 Budapest/ HU

KESERÜ, György Miklós

Eötvös út 47-53., 1121 Budapest/ HU

(57)

I. Jedinjenja opste formule (I)

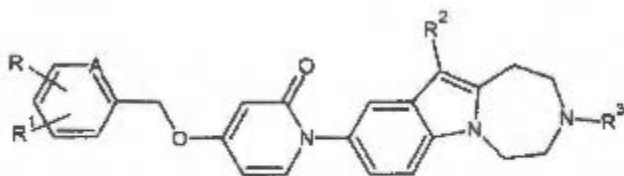

(I)

gde

značenje A je CH ili atom azota;

značenje R je atom vodonika ili halogena ili C<sub>1</sub>-C<sub>6</sub>alkilna grupa sa ravnim ili razgranatim lancem;

značenje R<sup>1</sup> je atom vodonika ili halogena ili

C<sub>1</sub>-C<sub>6</sub>alkilna grupa sa ravnim ili razgranatim lancem,ili

C<sub>1</sub>-C<sub>6</sub> alkoksigrupa sa ravnim ili razgranatim lancem,ili

mono ili polihalogenovana C<sub>1</sub>-C<sub>6</sub> haloalkilna grupa sa ravnim ili razgranatim lancem;

značenje R<sup>2</sup> je atom vodonika ili halogena ili

C<sub>1</sub>-C<sub>6</sub>alkilna grupa sa ravnim ili razgranatim lancem, ili

C<sub>1</sub>-C<sub>6</sub>alkoksi grupa sa ravnim ili razgranatim lancem ili

mono ili polihalogenovana C<sub>1</sub>-C<sub>4</sub> haloalkilna grupa sa ravnim ili razgranatim lancem;

značenje R<sup>3</sup> je vodonik ili

C<sub>1</sub>-C<sub>6</sub> alkilna grupa sa ravnim ili razgranatim lancem, opciono supstituisana sa C<sub>3</sub>-C<sub>6</sub> cikloalkilnom grupom, ili

mono ili polihalogenovana C<sub>1</sub>-C<sub>6</sub> haloalkilna grupa sa ravnim ili razgranatim lancem; ili

C<sub>3</sub>-C<sub>6</sub>cikloalkilna grupa, ili

C<sub>1</sub>-C<sub>6</sub>alkanoilna grupa sa ravnim ili razgranatim lancem

i/ili soli, i/ili geometrijski izomeri, i/ili stereoisomeri, i/ili dijastereizomeri, i/ili hidrati,

i/ili solvati, i/ili njihove polimorfne modifikacije.

**Patent sadrži još 20 patentnih zahtjeva.**



(11) **03823** (13) **B**

(51) **C11D 3/38**<sup>(2006.01)</sup>

(21) P-2020-176

(22) 20.04.2016

(30) UB20150028 22.04.2015 IT

(96) 16726169.2/20.04.2016

(86) IB PCT/IB2016/052230/20.04.2016

(87) WO 2016/170479/27.10.2016/2016/43

(97) EP 3286291/28.02.2018/2018/09

EP 3286291/03.06.2020/2020/23

(54) me **PROIZVOD ZA ČIŠĆENJE, SANITIZACIJU I HIGIJENSKU OBRADU**  
en **PRODUCT FOR CLEANING, SANITIZING AND HYGIENIZATION**

(73) Copma S.C.A.R.L.

Via Veneziani 32, 44100 Ferrara/ IT

(72) RODOLFI, Alberto

Via Sarti 25,, 44042 Cento (Ferrara)/ IT

CASELLI, Elisabetta

Via Acquedotto 61,, 44123 Ferrara/ IT

(57)

1. Proizvod za čišćenje, sanitizaciju i higijensku obradu, koji sadrži: osnovni rastvor sa deterdžentom, sredstvom za sanitizaciju i higijensko delovanje, a koji sadrži najmanje surfaktant izabran od nejonskih surfaktanata, katjonskih surfaktanata i amfoternih surfaktanata; spore probiotskih bakterija pomešane sa ovim osnovnim rastvorom; **koji se karakteriše time** što dodatno sadrži bakteriofagne elemente pomešane sa ovim osnovnim rastvorom i koji ima baktericidno dejstvo na prethodno definisane nepoželjne bakterijske vrste koje su prisutne na kontaminiranim površinama, pri čemu su ovi bakteriofagni elementi, u sadejstvu sa sporama probiotskih bakterija, u stanju da sprovedu kombinovano i sinergističko delovanje protiv štetnih mikroorganizama.

**Patent sadrži još 7 patentnih zahtjeva.**

(11) **03829** (13) **B**

(51) **C07K 16/28**<sup>(2006.01)</sup>

**A61P 37/06**<sup>(2006.01)</sup>

(21) P-2020-177

(22) 16.09.2016

(30) 201562220442 P 18.09.2015 US

(96) 16774750.0/16.09.2016

(86) US PCT/US2016/052040/16.09.2016

(87) WO 2017/049024/23.03.2017/2017/12

(97) EP 3350223/25.07.2018/2018/30

EP 3350223/17.06.2020/2020/25

(54) me **ANTITELA KOJA SE SPECIFIČNO VEŽU NA TL1A**  
en **ANTIBODIES THAT SPECIFICALLY BIND TO TL1A**

(73) Cephalon, Inc.

41 Moores Road, Frazer, Pennsylvania 19355/ US

(72) POULTON, Lynn Dorothy

Level 2 37 Epping Road,, Macquarie Park, NSW 2113/ AU

POLLARD, Matthew

60 Summerland Place,, Pullenvale, Queensland 4069/ AU

DOYLE, Anthony G.

Level 2 37 Epping Road,, Macquarie Park, NSW 2113/ AU

COOKSEY, Bridget Ann

Level 2 37 Epping Road,, Macquarie Park, NSW 2113/ AU

PANDE, Vanya

Level 2 37 Epping Road,, Macquarie Park, NSW 2113/ AU

CLARKE, Adam William

Level 2 37 Epping Road,, Macquarie Park, NSW 2113/ AU

(57)

1. Rekombinantno antitelo, **naznačeno time**, što specifično veže TNF-sličan ligand 1A (TL1A) i sadrži varijabilni region iz teškog lanca koji sadrži amino-kiselinsku sekvencu SEQ ID NO: 3 i varijabilni region iz lakog lanca koji sadrži amino-kiselinsku sekvencu SEQ ID NO: 4.

**Patent sadrži još 12 patentnih zahtjeva.**

(11) **03830** (13) **B**

(51) **A61K 8/64**<sup>(2006.01)</sup>

**C07K 16/42**<sup>(2006.01)</sup>

(21) P-2020-178

(22) 07.04.2015

(30) 201461976684 P 08.04.2014 US

(96) 15776002.6/07.04.2015

(86) US PCT/US2015/024650/07.04.2015

(87) WO 2015/157238/15.10.2015/2015/41

(97) EP 3128997/15.02.2017/2017/07

EP 3128997/05.08.2020/2020/32

(54) me **VEZUJUĆI MOLEKULI SPECIFČNI ZA IL- 21 I NJIHOVE UPOTREBE**  
en **BINDING MOLECULES SPECIFIC FOR IL-21 AND USES THEREOF**

(73) Boston Pharmaceuticals Inc.

55 Cambridge Parkway, Suite 400, Cambridge MA 02142/ US

(72) ETTINGER, Catherine

One MedImmune Way, Gaithersburg, MD 20878/ US

KARNELL, Jodi

One MedImmune Way, Gaithersburg, MD 20878/ US

DAMSCHRODER, Melissa

One MedImmune Way, Gaithersburg, MD 20878/ US

CHOWDHURY, Partha

One MedImmune Way, Gaithersburg, MD 20878/ US

XIAO, Xiaodong

One MedImmune Way, Gaithersburg, MD 20878/ US

TSUI, Ping

One MedImmune Way, Gaithersburg, MD 20878/ US

VARKEY, Reena

One MedImmune Way, Gaithersburg, MD 20878/ US

DRABIC, Stacey

One MedImmune Way, Gaithersburg, MD 20878/ US

CARTER, Laura

2687 Georgetown Boulevard, Ann Arbor, MI 48105/ US

HERBST, Ronald

One MedImmune Way, Gaithersburg, MD 20878/ US

DU, Qun

One MedImmune Way, Gaithersburg, MD 20878/ US

NAIMAN, Brian Michael

One MedImmune Way, Gaithersburg, MD 20878/ US

(57)

1. Izolovano antitelo ili njegov antigen vezujući fragment koji se specifično vezuje za IL-21 koji obuhvata varijabilni region (VH) teškog lanca i varijabilni region (VL) lakog lanca, pri čemu

(a) VH obuhvata aminokiselinsku sekvencu SEQ ID NO: 19; i

(b) VL obuhvata aminokiselinsku sekvencu SEQ ID NO: 21.

**Patent sadrži još 12 patentnih zahtjeva.**

(11) **03839** (13) **B**

(51) **C07D 487/04**<sup>(2006.01)</sup>

**A61K 31/5513**<sup>(2006.01)</sup>

**C07K 16/28**<sup>(2006.01)</sup>

**C07D 519/00**<sup>(2006.01)</sup>

**A61P 35/00**<sup>(2006.01)</sup>

**C07K 7/02**<sup>(2006.01)</sup>

(21) P-2020-179

(22) 02.09.2015

(30) 201462045248 P 03.09.2014 US

201462087040 P 03.12.2014 US

201562149370 P 17.04.2015 US

201562164305 P 20.05.2015 US

(96) 15763739.8/02.09.2015

(86) US PCT/US2015/048059/02.09.2015

(87) WO 2016/036801/10.03.2016/2016/10

(97) EP 3189056/12.07.2017/2017/28

EP 3189056/10.06.2020/2020/24

(54) me **CITOTOKSIČNI DERIVATI BENZODIAZEPINA**  
en **CYTOTOXIC BENZODIAZEPINE DERIVATIVES**

(73) ImmunoGen, Inc.

830 Winter Street, Waltham, MA 02451/ US

(72) CHARI, Ravi V.J.

174 Winchester Street,, Newton, MA 02461/ US

MILLER, Michael Louis

4 Maymont Drive,, Framingham, MA 01701/ US

SHIZUKA, Manami

253 Payson Road,, Belmont, MA 02478/ US

(57)

1. Citotoksično jedinjenje predstavljeno sledećom formulom:

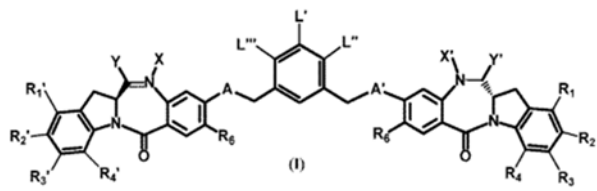

ili njegova farmaceutski prihvatljiva so, naznačeno time što:

L' je predstavljen sledećom formulom:

-NR<sup>5</sup>-P-C(=O)-(CRaRb)<sub>m</sub>-J (B1);

-NR<sup>5</sup>-P-C(=O)-Cy-(CRaRb)<sub>m</sub>'-J (B2);

ili

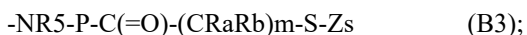

ili pri čemu:

P je amino-kiselinski ostatak ili peptid koji sadrži između 2 do 20 amino-kiselinskih ostataka;

J je N-hidroksisukcinimid estar, N-hidroksi sulfosukcinimid estar, nitrofenil estar, dinitrofenil estar, sulfo-tetrafluorfenil estar, i pentafluorfenil estar;

Ra i Rb, za svako pojavljivanje, su svaki nezavisno -H, (C1-C3)alkil ili naelektrisani supstituent ili grupa koja se može jonizovati Q, pri čemu je Q SO<sub>3</sub>H ili njegova farmaceutski prihvatljiva so;

m je ceo broj od 1 do 6;

m' je 0 ili ceo broj od 1 do 6;

Cy je ciklični alkil koji ima 5 ili 6 atoma ugljenika u prstenu opciono supstituisanih halogenom, -OH, (C1-C3)alkilom, (C1-C3)alkoksijem, ili halo(C1-C3)alkilom; i

Zs je -H, -SRd, -C(=O)Rd1 ili je odabran od bilo koje od sledećih formula:

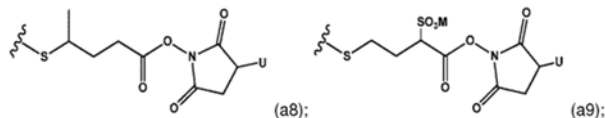
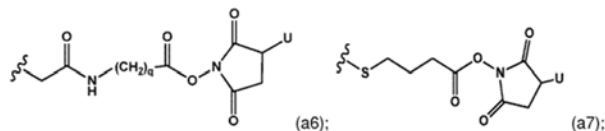
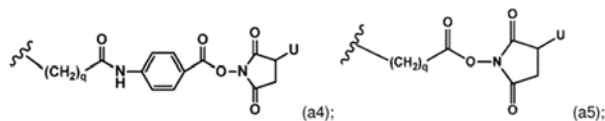
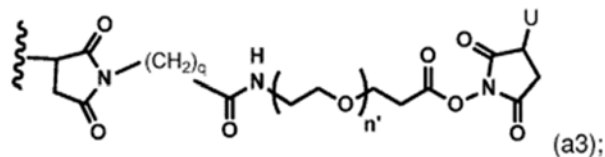
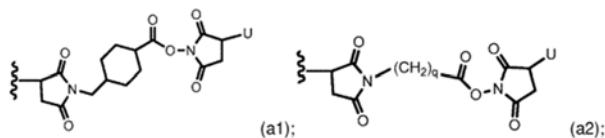

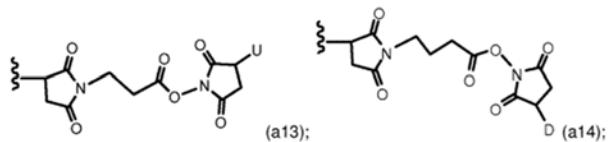
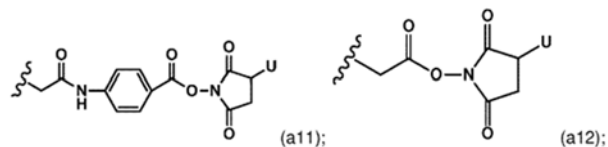
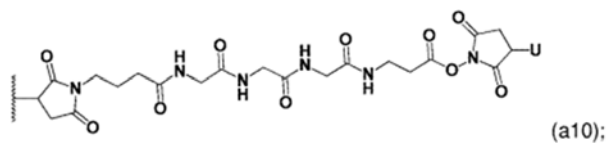

ili

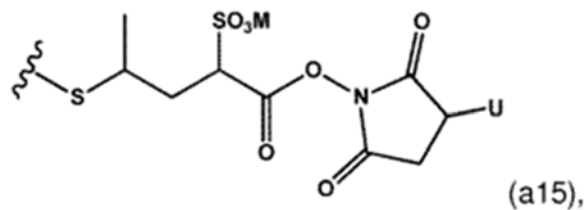

pri čemu:

q je ceo broj od 1 do 5;

n' je ceo broj od 2 do 6;

U je -H ili SO<sub>3</sub>M;

M je H<sup>+</sup>, Na<sup>+</sup> ili K<sup>+</sup>;

Rd je linearni ili granati alkil koji ima 1 do 6 atoma ugljenika ili je odabran od fenila, nitrofenila, dinitrofenila, karboksinitrofenila, piridila ili nitropiridila; i

Rd1 je linearni ili granati alkil koji ima 1 do 6 atoma ugljenika;

L'' i L''' su oba -H;

dvostruka linija  $\equiv$

između N i C predstavlja jednostruku vezu ili dvostruku vezu, pod uslovom da kada je dvostruka veza X je odsutan i Y je -H, ili linearni ili granati alkil koji ima 1 do 4 atoma ugljenika, i kada je jednostruka veza, X je -H, Y je -OH ili -SO<sub>3</sub>M;

R1, R2, R3, R4, R1', R2', R3' i R4' su svi -H;

R6 je -OMe;

X' i Y' su oba -H;

A i A' su -O-; i

M je H, Na<sup>+</sup> ili K<sup>+</sup>; i

R5 za svako pojavljivanje je nezavisno -H ili opciono supstituisani linearni ili granati alkil koji ima 1 do 10 atoma ugljenika.

**Patent sadrži još 20 patentnih zahtjeva.**

(11) **03831** (13) **B**

(51) **C07D 231/12**<sup>(2006.01)</sup>

**C07D 417/04**<sup>(2006.01)</sup>

**C07D 471/04**<sup>(2006.01)</sup>

**A61K 31/437**<sup>(2006.01)</sup>

**C07D 403/04**<sup>(2006.01)</sup>

**C07D 417/14**<sup>(2006.01)</sup>

**C07D 487/04**<sup>(2006.01)</sup>

**A61P 37/00**<sup>(2006.01)</sup>

(21) P-2020-181

(22) 06.09.2017

(30) 201662394779 P 15.09.2016 US

(96) 17768914.8/06.09.2017

(86) US PCT/US2017/050197/06.09.2017

(87) WO 2018/052772/22.03.2018/2018/12

(97) EP 3512833/24.07.2019/2019/30

EP 3512833/29.07.2020/2020/31

(54) me **HETEROARILA KARBOKSAMIDNA JEDINJENJA KAO INHIBITORI RIPK2**  
en **HETEROARYL CARBOXAMIDE COMPOUNDS AS INHIBITORS OF RIPK2**

(73) Boehringer Ingelheim International GmbH

Binger Strasse 173, Ingelheim am Rhein, 55216/ DE

(72) LIU, Pingrong

900 Ridgebury Road, PO Box 368, Ridgefield Connecticut 06877/ US

MILLER, Craig Andrew

900 Ridgebury Road, PO Box 368, Ridgefield Connecticut 06877/ US

YU, Maolin

48 Ledgewood Drive, Brookfield, CT 06804/ US

ZHANG, Zhonghua

900 Ridgebury Road, PO Box 368, Ridgefield Connecticut 06877/ US

RUPPEL, Sabine

900 Ridgebury Road, PO Box 368, Ridgefield CT 06877/ US

PADYANA, Anil K.

900 Ridgebury Road, PO Box 368, Ridgefield CT 06877/ US

(57)

1. Jedinjenje sa formulom (I):

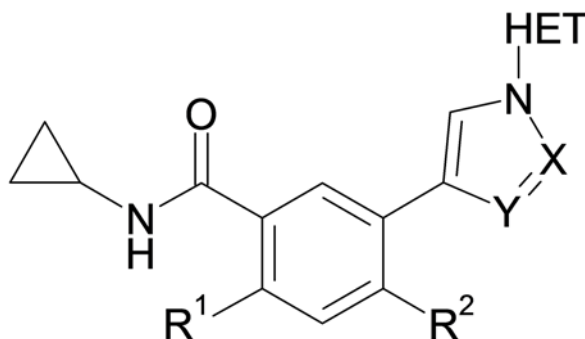

I

ili njegove farmaceutski prihvatljive soli, pri čemu:

**X** je N i **Y** je CH; ili

**X** je CH i **Y** je N;



**HET** je 5-očlani heteroarilni prsten koji sadrži jedan do tri heteroatoma izabrana od azota i sumpora, gdje svaki heteroarilni prsten je opciono supstituisan sa jednom do dvije grupe supstituenata nezavisno izabrane od **R3 i R4**; ili

**HET** je 5-očlani heteroarilni prsten koji sadrži jedan do tri heteroatoma izabrana od azota i sumpora, gdje svaki heteroarilni prsten je supstituisan sa dvije grupe supstituenata izabrane od **Ra i Rb**, pri čemu **Ra i Rb** zajedno sa atomima za koje su vezani formiraju 5-6-očlani heterociklični ili heteroarilni prsten koji može biti opciono supstituisan sa jednim do dva supstituenta izabrana od **R3 i R4**;

**R1** je vodonik ili F;

**R2** je C1-3 alkil ili Cl;

**R3 i R4** su svaki nezavisno izabrani od:

- (a) –H,
- (b) –O R5,
- (c) -O- C1-6alkil-O- C1-3 alkil
- (d) –O-C3-6 cikloalkil,
- (e) -C(O)R5,
- (f) C1-6alkil opciono supstituisan sa jednim do tri –OH, fluor, heterociklil opciono supstituisan sa okso, C3-6 cikloalkil, –CO2R5, -O- C1-6alkil, aril, -N(R5)(R6), ili -C(O)N(R5)(R6),
- (g) C3-6 cikloalkil opciono supstituisan sa jednim do tri –OH, sa jednim do tri fluor, C1-6alkil, -OC1-6alkil, C1-6alkil-OC1-6alkil, C1-6alkil-OH, CF3, -OC3-6cikloalkil, -CO2H, -CO2R5, C3-6cikloalkil, 5-6-očlani heteroaril, C3-6 heterociklil, N(R5)(R6), ili -C(O)N(R5)(R6),
- (h) –CO2R5,
- (i) -C(O)N(R5)(R6),
- (j) –S(O)2N(R5)(R6),
- (k) –S(O)n-R5,
- (l) 5-6-očlana heteroaril grupa opciono supstituisana sa jednom do tri grupe izabrane od C1-6alkil, C3-6cikloalkil, halogen, -CF3, -OH, -(CH2)nCO2R5, -C(O)N(R5)(R6), -N(R5)(R6), -NH-SO2C1-6alkil, C1-6alkoksil, C1-6alkil-O- C1-3 alkil, C1-6alkilhidroksil, C1-3alkil-CN, okso, fenil opciono supstituisan sa halogen i -S(O)nC1-6alkil,
- (m) 4-10-očlana monociklična, biciklična ili spirociklična heterociklična grupa koja sadrži N, S ili O, gdje svaki heterocikl je opciono supstituisan sa 1-3 supstituenta izabrana od 3-6-očlana heterociklična prstena, halogen, -C1-3alkil, -C1-3alkil –O- C1-3alkil i -C1-3alkil- C(O)N(R5)(R6),
- (n) aril,
- (o) -N(R5)(R6);

R5 i R6 su svaki nezavisno izabrani od –H, 4-6-očlani heterociklil, -C(O)-C1-3 alkil -C(O)-C1-3 cikloalkil i –(C1-C6)alkil, gdje svaki R5 i R6 je nezavisno opciono supstituisan sa –OH, C3-6 cikloalkil, -C1-3alkil, –O- C1-3alkil, -NH-C1-3 alkil ili –N-(C1-3-alkil)2; ili

R5 i R6 zajedno sa atomom azota za koji su vezani formiraju 4-6-očlani heterociklični prsten opciono supstituisan sa metil; i

**n** je 0, 1, ili 2.

**Patent sadrži još 33 patentnih zahtjeva.**

(11) **03835** (13) **B**

(51) **C07D 417/14**<sup>(2006.01)</sup>

**A61K 31/427**<sup>(2006.01)</sup>

**A61P 31/04**<sup>(2006.01)</sup>

(21) P-2020-183

(22) 20.09.2016

(30) 201562222430 P 23.09.2015 US

(96) 16848099.4/20.09.2016

(86) CN PCT/CN2016/099482/20.09.2016

(87) WO 2017/050218/30.03.2017/2017/13

(97) EP 3353175/01.08.2018/2018/31

EP 3353175/12.08.2020/2020/33

(54) me **SOLI I ČVRSTI OBLICI MONOBAKTAMSKOG ANTIBIOTIKA**  
en **SALTS AND SOLID FORMS OF MONOACTAM ANTIBIOTIC**

(73) NOVARTIS AG

Lichtstrasse 35, Basel, 4056/ CH

(72) AUBIN, Eric

St. Johann, Postfach, Forum 1, Novartis Campus,, 4056 Basel/ CH

FISCH, Andreas

WSJ-340.8.69A, Novartis Campus,, 4056 Basel/ CH

MUTZ, Michael

Werk Klybeck, Postfach,, 4002 Basel/ CH

RIEBESEHL, Bernd Ulrich

Postfach,, 4002 Basel/ CH

SCHOENHENTZ, Marc

St. Johann, Postfach, Forum 1, Novartis Campus,, 4056 Basel/ CH

CASAREZ, Anthony

5300 Chiron Way,, Emeryville, CA 94608/ US

LI, Zaixing

China, 4218 Jinke Road, Zhangjiang Hi-Tech Park, Pudong New Area,, Shanghai 201203/ CN

LINDVALL, Mika

5300 Chiron Way,, Emeryville, CA 94608/ US

MOSER, Heinz Ernst

5300 Chiron Way,, Emeryville, CA 94608/ US

RECK, Folkert

5300 Chiron Way,, Emeryville, CA 94608/ US

SETHURAMAN, Vijay

5300 Chiron Way,, Emeryville, CA 94608/ US

SIMMONS, Robert Lowell

5300 Chiron Way,, Emeryville, CA 94608/ US

(57)

1. So (L)-arginina 1-(((Z)-(1-(2-aminotiazol-4-il)-2-okso-2-(((3S,4R)-2-okso-4-((2-oksooksazolidin-3-il)metil)-1-sulfoazetid-3-il)amino)etiliden)amino)oksi) ciklopropankarboksilne kiseline.

**Patent sadrži još 14 patentnih zahtjeva.**

(11) **03832** (13) **B**

(51) **F41A 3/44**<sup>(2006.01)</sup>

**F41A 5/02**<sup>(2006.01)</sup>

(21) P-2020-184

(22) 20.04.2016

(96) 16719919.9/20.04.2016

(86) IB PCT/IB2016/052242/20.04.2016

(87) WO 2017/182843/26.10.2017/2017/43

(97) EP 3446061/27.02.2019/2019/09

EP 3446061/03.06.2020/2020/23

(54) me **PIŠTOLJ SA UREĐAJEM ZA ZABRAVLJIVANJE**  
en **HANDGUN WITH A LOCKING DEVICE**

(73) Arsenal Firearms Finance Limited

Tortola Aleman, Cordero, Galindo & Lee Trust (BVI) Limited, Road Town, P.O. Box 3175/ VG

(72) STRESHINSKY, Dimitry

Place de l'Alma 5,, 75008 Paris/ FR

(57)

1. Pištolj (1) koji sadrži:

- okvir (2) pistolja;

- cev (4) nošenu od strane okvira (2) pištolja, koja sa bliže strane ograničava komoru (6) za ispaljivanje pruža se duž uzdužne ose (X);

- klizač (8), koji se može translirati uzdužno u odnosu na cev (4) između prednje konfiguracije u kojoj klizač zatvara komoru (6) za ispaljivanje, i zadnje konfiguracije u kojoj je udaljen od bližih usta (12) komore (6) za ispaljivanje, kako bi je otvorio; gde je orijentacija komore (6) za ispaljivanje

suštinski paralelna u odnosu na navedenu osu (X) u ovoj prednjoj konfiguraciji i zadnjoj konfiguraciji;

- uređaj (10) za zabavljanje koji mehanički zabavljuje cev (4) i klizač (8) jedno za drugo u prednjoj konfiguraciji, gde se on u zadnjoj konfiguraciji vodi poprečno u odnosu na cev (4) radi odbravljanja klizača (8);

navedeni pištolj (1) je **naznačen time**, što klizač (8) i uređaj (10) za zabavljanje ograničavaju lučne površine (14, 16) za zabavljanje kada su u prednjoj konfiguraciji spregnute jedna sa drugim radi zabavljanja klizača (8), i time što su u zadnjoj konfiguraciji uzajamno razmaknute u poprečnom pravcu radi otvaranja navedene komore (6);

gde uređaj (10) za zabavljanje sadrži oblikovano telo (18) koje ograničava jednu (16) od navedenih lučnih površina za zabavljanje, koje se u prednjoj konfiguraciji najmanje delimično nalazi u ulegnutom ležištu (20) za zabavljanje, delimično se pružajući u debljinu gornjeg zida (22) klizača (8), gde je navedeno oblikovano telo (18) suštinski u obliku latiničnog slova U, i gde navedeni gornji zid (22) ograničava zakrivljenu površinu (24) ležišta, usmerenu prema okviru (2) pištolja i pomoću uklapanja putem oblika spregnutu sa navedenim telom (18).

**Patent sadrži još 13 patentnih zahtjeva.**

(11) **03833** (13) **B**

(51) **A61K 31/13**<sup>(2006.01)</sup>

**A61K 31/445**<sup>(2006.01)</sup>

**A61K 31/496**<sup>(2006.01)</sup>

**A61P 25/28**<sup>(2006.01)</sup>

(21) P-2020-185

(22) 03.08.2016

(30) 201641017204 18.05.2016 IN

(96) 16763575.4/03.08.2016

(86) IB PCT/IB2016/054672/03.08.2016

(87) WO 2017/199070/23.11.2017/2017/47

(97) EP 3458039/27.03.2019/2019/13

EP 3458039/15.07.2020/2020/29

(54) me **TROSTRUKA KOMBINACIJA ČISTIH ANTAGONISTA RECEPTORA 5-HT6, INHIBITORA ACETILHOLINESTERAZE I ANTAGONISTA RECEPTORA NMDA**  
en **TRIPLE COMBINATION OF PURE 5-HT6 RECEPTOR ANTAGONISTS, ACETYLCHOLINESTERASE INHIBITORS AND NMDA RECEPTOR ANTAGONIST**

(73) Suven Life Sciences Limited

Serene Chambers, Road - 5 Avenue - 7, Banjara Hills, Hyderabad, Telangana 500034/ IN

(72) NIROGI, Ramakrishna

Serene Chambers, Road-5, Avenue 7, Banjara Hills, Hyderabad Telangana 500034/ IN

SHINDE, Anil Karbhari

Serene Chambers, Road-5, Avenue 7, Banjara Hills, Hyderabad Telangana 500034/ IN

JAYARAJAN, Pradeep

Serene Chambers, Road-5, Avenue 7, Banjara Hills, Hyderabad Telangana 500034/ IN

BHYRAPUNENI, Gopinadh

Serene Chambers, Road-5, Avenue 7, Banjara Hills, Hyderabad Telangana 500034/ IN

KAMBHAMPATI, Ramasastry

Serene Chambers, Road-5, Avenue 7, Banjara Hills, Hyderabad Telangana 500034/ IN

JASTI, Venkateswarlu

Serene Chambers, Road-5, Avenue 7, Banjara Hills, Hyderabad Telangana 500034/ IN

(57)

1. Kombinacija koja sadrži čist antagonist receptora 5-HT6, inhibitor acetilholinesteraze i antagonist receptora NMDA, naznačena time što je čist antagonist receptora 5-HT6 odabran iz grupe koja se sastoji od:

1-[(2-bromofenil)sulfonyl]-5-metoksi-3-[(4-metil-1-piperazini)metil]-1H-indola;

1-[(4-fluorofenil)sulfonyl]-5-metoksi-3-[(4-metil-1-piperazini)metil]-1H-indola; i

1-[(4-izopropilfenil)sulfonyl]-5-metoksi-3-[(4-metil-1-piperazini)metil]-1H-indola;

ili njihove farmaceutski prihvatljive soli.

**Patent sadrži još 18 patentnih zahtjeva.**

(11) **03834** (13) **B**

(51) **A61K 38/17**<sup>(2006.01)</sup>

**C07K 7/06**<sup>(2006.01)</sup>

**G01N 33/50**<sup>(2006.01)</sup>

**A61K 39/00**<sup>(2006.01)</sup>

**C07K 7/08**<sup>(2006.01)</sup>

**A61P 35/00**<sup>(2006.01)</sup>

(21) P-2020-186

(22) 15.03.2011

(30) 315704 P 19.03.2010 US  
201004551 19.03.2010 GB

(96) 17203096.7/15.03.2011

(97) EP 3329933/06.06.2018/2018/23  
EP 3329933/24.06.2020/2020/26

(54) me **NOVA IMUNOTERAPIJA PROTIV NEKOLIKO TUMORA UKLJUČUJUĆI GASTROINTESTINALNI KARCINOM I KARCINOM ŽELUCA**  
en **NOVEL IMMUNOTHERAPY AGAINST SEVERAL TUMORS INCLUDING GASTROINTESTINAL AND GASTRIC CANCER**

(73) Immatix Biotechnologies GmbH  
Paul-Ehrlich-Strasse 15, 72076 Tübingen/ DE

(72) Weinschenk, Toni  
Im Morgenrain 15,, 73773 Aichwald/ DE

Fritsche, Jens  
Lärchenweg 11,, 72144 Dusslingen/ DE

Walter, Steffen  
2901 Wroxtton Road,, Houston, TX Texas 77005/ US

Lewandrowski, Peter  
Grabenstrasse 11,, 72070 Tübingen-Hirschau/ DE

Singh, Harpreet  
5122 Morningside Dr, Apt. 525,, Houston, TX Texas 77005/ US

(57)

1. Peptid izabran iz grupe koju čini

a) peptid koji sadrži sekvencu prema ID BR. SEKV 86,

b) peptid prema a), naznačeno time što navedeni peptid sadrži nepeptidne veze, i

c) peptid prema a), naznačeno time što je navedeni peptid deo fuzionog proteina, koji konkretno sadrži N-terminalne aminokiseline HLA-DR antigen-asociranog nepromenljivog lanca (Ii), za upotrebu u medicini.

**Patent sadrži još 10 patentnih zahtjeva**

(11) **03836** (13) **B**

(51) **C07K 16/18**<sup>(2006.01)</sup>

**A61P 25/28**<sup>(2006.01)</sup>

(21) P-2020-188

(22) 20.12.2013

(30) 201261745410 P 21.12.2012 US

(96) 13818637.4/20.12.2013

(86) US PCT/US2013/076952/20.12.2013

(87) WO 2014/100600/26.06.2014/2014/26

(97) EP 2935326/28.10.2015/2015/44

EP 2935326/10.06.2020/2020/24

(54) me **HUMANA ANTI-TAU ANTITELA**  
en **HUMAN ANTI-TAU ANTIBODIES**

(73) Biogen MA Inc.

225 Binney Street, Cambridge, MA 02142/ US

Biogen International Neuroscience GmbH

Neuhofstrasse 30, 6340 Baar/ CH

(72) WEINREB, Paul H.

18 Brundette Avenue,, Andover, MA 01810/ US

CHEN, Feng

Breitensteinstrasse 84,, 8037 Zurich/ CH

GARBER, Ellen A.

14 Donnell Street,, Cambridge, MA 02138/ US

GRIMM, Jan

Burglistrasse 16,, 8600 Dubendorf/ CH

MONTRASIO, Fabio

Vogelneststrasse 7,, 8834 Schindellegi/ CH

(57)

I. Monoklonsko anti-tau antitelo ili njegov fragment koji vezuje tau, naznačeno time, što:

(a) varijabilni region teškog lanca (VH) sadrži aminokiselinsku sekvencu prikazanu u SEQ ID NO:48 i

varijabilni region lakog lanca (VL) sadrži aminokiselinsku sekvencu prikazanu u SEQ ID NO:49, ili

(b) VH sadrži aminokiselinsku sekvencu prikazanu u SEQ ID NO:47 i VL sadrži aminokiselinsku sekvencu prikazanu u SEQ ID NO:49.

**Patent sadrži još 11 patentnih zahtjeva.**

(11) **03837** (13) **B**

(51) **C07D 417/14**<sup>(2006.01)</sup>

**C07D 487/04**<sup>(2006.01)</sup>

**A61P 11/06**<sup>(2006.01)</sup>

**C07D 471/04**<sup>(2006.01)</sup>

**A61K 31/4439**<sup>(2006.01)</sup>

**A61P 11/00**<sup>(2006.01)</sup>

(21) P-2020-190

(22) 21.09.2017

(30) 201662398006 P 22.09.2016 US

(96) 17772381.4/21.09.2017

(86) EP PCT/EP2017/073916/21.09.2017

(87) WO 2018/055040/29.03.2018/2018/13

(97) EP 3515910/31.07.2019/2019/31

EP 3515910/15.07.2020/2020/29

(54) me **DERIVATI 5-[2-(PIRIDIN-2-ILAMINO)-1,3-TIAZOL-5-IL] - 2,3-DIHIDRO-1H-IZOINDOL-1-ONA I NJIHOVA UPOTREBA KAO DVOJNIH INHIBITORA FOSFATIDILINOZITOL 3-KINAZE DELTA I GAMA**  
en **5-[2-(PYRIDIN-2-YLAMINO)-1,3-THIAZOL-5-YL]-2,3-DIHYDRO-1 H-ISOINDOL-1-ONE DERIVATIVES AND THEIR USE AS DUAL INHIBITORS OF PHOSPHATIDYLINOSITOL 3-KINASE DELTA&GAMMA**

(73) Astrazeneca AB

, 151 85 Södertälje/ SE

(72) PERRY, Matthew

AstraZeneca, 431 83 Mölndal/ SE

KARABELAS, Konstantinos

AstraZeneca, 431 83 Mölndal/ SE

MOGEMARK, Mickael

AstraZeneca, 431 83 Mölndal/ SE

BOLD, Peter

AstraZeneca, 431 83 Mölndal/ SE

TYRCHAN, Christian

AstraZeneca, 431 83 Mölndal/ SE

NIKITIDIS, Antonios

AstraZeneca, 431 83 Mölndal/ SE

PETERSEN, Jens

AstraZeneca, 431 83 Mölndal/ SE

BÖRJESSON, Ulf

AstraZeneca, 431 83 Mölndal/ SE

(57)

I. Jedinjenje formule (I)

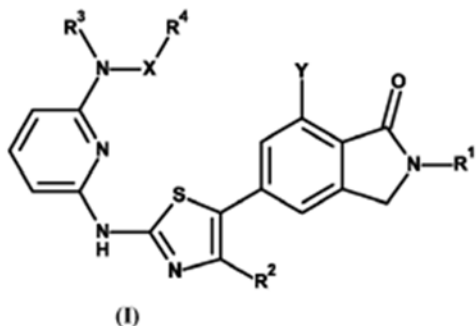

naznačeno time što

X je C(O) ili SO<sub>2</sub>;

**Y** je SO<sub>2</sub>NHR<sub>5</sub> ili SO<sub>2</sub>R<sub>6</sub>;

**R1** je izabran od C1-4alkila, naznačeno time što je pomenuti C1-4alkil opciono supstituisan sa ciklopropilom, 0, 1 ili 2 CH<sub>3</sub> i 0, 1, 2 ili 3 F;

**R2** je izabran od H ili CH<sub>3</sub>;

**R3** je izabran od H ili C1-3alkila;

**R4** je izabran od C1-3alkila, naznačeno time što je pomenuti C1-3alkil opciono supstituisan OC1-3alkilom; ili

**R3** i **R4** zajedno sa atomom N i X grade 5, 6 ili 7-člani cikloheteroalkil prsten koji sadrži 0 ili 1 dodatni heteroatom izabran od N ili O, naznačeno time što je pomenuti cikloheteroalkil prsten supstituisan sa 0, 1 ili 2 supstituenta nezavisno izabrana od CH<sub>3</sub>, OH, CH<sub>2</sub>OH ili CH<sub>2</sub>CH<sub>2</sub>OH; ili

**R3** i **R4** zajedno sa atomom N i X su izabrani od

ili

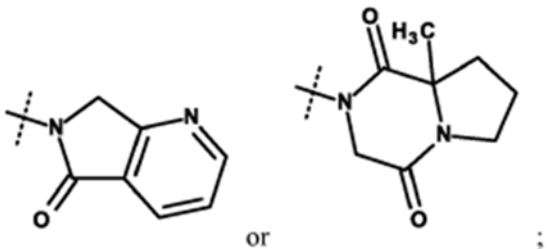

**R5** je izabran od C1-3alkila ili (oksetan-3-ila);

**R6** je izabran od C1-3alkila;

ili njegova farmaceutski prihvatljiva so.

**Patent sadrži još 12 patentnih zahtjeva**



(11) **03838** (13) **B**

(51) **A61K 9/00**<sup>(2006.01)</sup>

**A61K 9/14**<sup>(2006.01)</sup>

**A61K 9/19**<sup>(2006.01)</sup>

(21) P-2020-191

(22) 13.04.2012

(30) 201161475811 P 15.04.2011 US

(96) 12713187.8/13.04.2012

(86) EP PCT/EP2012/056818/13.04.2012

(87) WO 2012/140220/18.10.2012/2012/42

(97) EP 2696848/19.02.2014/2014/08

EP 2696848/22.07.2020/2020/30

(54) me **NANOSUSPENZIJE LEKA OSUŠENE ZAMRZAVANJEM**  
en **FREEZE DRIED DRUG NANOSUSPENSIONS**

(73) JANSSEN PHARMACEUTICA N.V.

Turnhoutseweg 30, Beerse, 2340/ BE

(72) INGHELBRECHT, Sabine Karine Katrien

Turnhoutseweg 30,, B-2340 Beerse/ BE

GIESELER, Henning

Erlangen-Nuernberg, Schlossplatz 4,, 91054 Erlangen/ DE

BEIROWSKI, Jakob Andreas

Wilhelmstrasse 13,, 91054 Erlangen/ DE

(57)

1. Nanosuspenzija osušena zamrzavanjem koja sadrži 4-[[4-[[4-(2-cijanoetenil)-2,6-dimetilfenil]amino]-2-pirimidinil]amino]benzonitril ili njegov stereoizomerni oblik; ili njegova farmaceutski prihvatljiva so, i sterilni stabilizator koji je čvrsta supstanca na sobnoj temperaturi i polivinil piroolidon.

**Patent sadrži još 15 patentnih zahtjeva**

(11) **03760** (13) **B**

(51) **C07D 239/22**<sup>(2006.01)</sup>

**C07D 403/04**<sup>(2006.01)</sup>

**C07D 413/04**<sup>(2006.01)</sup>

**A61K 31/506**<sup>(2006.01)</sup>

**A61P 1/04**<sup>(2006.01)</sup>

**A61P 3/10**<sup>(2006.01)</sup>

**A61P 17/06**<sup>(2006.01)</sup>

**A61P27/02**<sup>(2006.01)</sup>

**A61P37/02**<sup>(2006.01)</sup>

**A61P43/00**<sup>(2006.01)</sup>

**C07D 401/04**<sup>(2006.01)</sup>

**C07D 405/04**<sup>(2006.01)</sup>

**A61K 31/505**<sup>(2006.01)</sup>

**A61K 31/695**<sup>(2006.01)</sup>

**A61P 3/00**<sup>(2006.01)</sup>

**A61P 17/00**<sup>(2006.01)</sup>

**A61P 25/00**<sup>(2006.01)</sup>

**A61P29/00**<sup>(2006.01)</sup>

**A61P37/08**<sup>(2006.01)</sup>

**C07F7/12**<sup>(2006.01)</sup>

(21) P-2020-61

(22) 11.12.2015

(30) 20140251771 12.12.2014 JP

(96) 15866802.0/11.12.2015

(86) JP PCT/JP2015/084791/11.12.2015

(87) WO 2016/093342/16.06.2016/2016/23

(97) EP 3231793/18.10.2017/2017/42

EP 3231793/11.03.2020/2020/11

(54) me **SPOJEVI DIHIDROPIRIMIDIN-2-ONA I NJIHOVA UPOTREBA U MEDICINI**  
en **DIHYDROPYRIMIDINE-2-ONE COMPOUNDS AND MEDICINAL USES THEREOF**

(73) JAPAN TOBACCO INC.

2-1, Toranomom 2-chome Minato-ku, Tokyo, 105-8422/ JP

(72) YOKOTA, Masahiro

1-1 Murasaki-cho Takatsuki-shi Osaka 569-1125 / JP  
IKENOGAMI, Taku

1-1 Murasaki-cho Takatsuki-shi Osaka 569-1125 / JP  
WATANABE, Eiichi

1-1 Murasaki-cho Takatsuki-shi Osaka 569-1125 / JP  
SEKI, Noriyoshi

1-1 Murasaki-cho Takatsuki-shi Osaka 569-1125 / JP  
SAKAI, Takayuki

1-1 Murasaki-cho Takatsuki-shi Osaka 569-1125 / JP  
FUJIOKA, Shingo

1-1 Murasaki-cho Takatsuki-shi Osaka 569-1125 / JP  
SHIOZAKI, Makoto

1-1 Murasaki-cho Takatsuki-shi Osaka 569-1125 / JP  
SUWA, Katsunori

1-1 Murasaki-cho Takatsuki-shi Osaka 569-1125 / JP  
OGOSHI, Yosuke

1-1 Murasaki-cho Takatsuki-shi Osaka 569-1125 / JP  
NOGUCHI, Masato

13-2 Fukuura 1-chome Kanazawa-ku, Yokohama-shi Kanagawa 236-0004/ JP  
MAEDA, Katsuya

1-1 Murasaki-cho Takatsuki-shi Osaka 569-1125 / JP

(74) AOD "ĆUPIĆ"

Bulevar Džordža Vašigtona 79, Podgorica, 81000/ ME

(57)

1. Spoj Formule [I] ili njegova farmaceutske prihvatljiva sol:

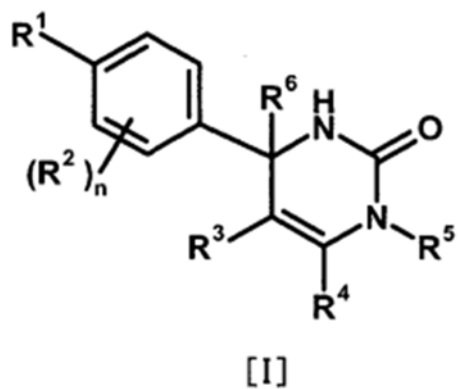

**naznačen time što**

R1 je

- (1) C4-8 alkil,
- (2) C3-8 alkil supstituiran s jednim hidroksi,
- (3) C4-8 alkil supstituiran s jednim halogenom,
- (4) C4-8 alkenil,
- (5) C4-8 alkinil,
- (6) C3-7 alkil supstituiran s jednim trifluormetilom,
- (7) C1-5 alkil supstituiran s jednim supstuentom kojeg se bira iz Skupine Xa1,
- (8) C3-6 alkoksi,
- (9) C2-7 alkoksi supstituiran s jednim trifluormetilom,
- (10) C1-3 alkoksi supstituiran s jednim supstuentom kojeg se bira iz Skupine Xa2,
- (11) C4-6 cikloalkil,
- (12) C3-6 cikloalkil supstituiran s istim ili različitim jednim do dva C1-5 alkil,
- (13) C5-6 cikloalkenil, koji može biti supstituiran s istim ili različitim jednim do dva C1-4 alkila,
- (14) spiro C6-11 cikloalkil,
- (15) C1-3 alkoksikarbonil,
- (16) C3-6 alkilsulfanil,
- (17) C3-6 alkilsulfinil,

- (18) C3-6 alkilsulfonil,
- (19) C3-6 cikloalkilsulfanil,
- (20) C3-6 cikloalkilsulfinil,
- (21) C3-6 cikloalkilsulfonil,
- (22) ciklobutilidenemetil,
- (23) ciklopentilidenemetil,
- (24) ciklohexilidenemetil, koji može biti supstituiran s istim ili različitim jednim do dva C1-3 alkila,
- (25) tetrahidropiran-4-ilidenemetil,
- (26) C3-6 cikloalkil supstituiran s jednim do dva ista halogena, ili
- (27) C5-6 cikloalkenil supstituiran s jednim do dva ista halogena;

Skupina Xa1 je

- (a) C3-6 cikloalkil, koji može biti supstituiran s istim ili različitim jednim do tri C1-5 alkila,
- (b) C3-6 cikloalkil supstituiran s istim ili različitim jednim do dva halogena,
- (c) fenil,
- (d) C2-4 alkoksi,
- (e) trimetilsilil,
- (f) karboksi, i
- (g) tetrahidropiran-4-il;

Skupina Xa2 je

- (a) C3-6 cikloalkil,
- (b) fenil, i
- (c) C1-4 alkoksi;

R2 je

- (1) halogen,
- (2) C1-6 alkil,

(3) C1-3 alkoksi, koji može biti supstituiran s fenilom, ili

(4) trifluormetil;

n je cijeli broj 0, 1 ili 2, uz uvjet da kada n je 2, gdje svaki R2 može biti različit; ili

R1 i R2 mogu biti kombinirani zajedno s benzenskim prstenom na kojeg su vezani kako bi tvorili indanil, gdje indanil može biti supstituiran s istim ili različitim jednim do dva C1-6 alkila;

R3 je

(1) -Yb-COO-R30,

(2) C1-6 alkil, koji može biti supstituiran s jednim hidroksi,

(3) C1-6 alkil supstituiran s jednim C1-4 alkoksi,

(4) C1-6 alkil supstituiran s jednim C1-4 alkilsulfonilom,

(5) C3-6 cikloalkil, koji može biti supstituiran s istim ili različitim jednim do tri supstituenta koje se bira iz Skupine Xb,

(6)

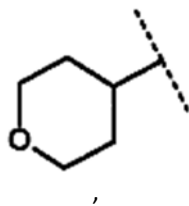

(7)

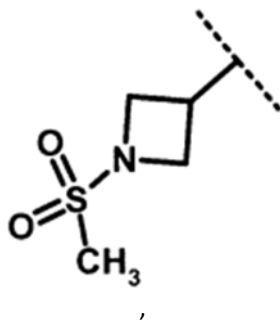

(8) fenil,

(9)

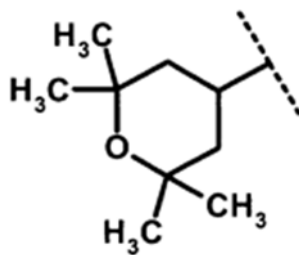

ili

(10) C2-3 alkenil;

Yb je

(a) C1-6 alkilen,

(b) C3-6 cikloalkilen,

(c) fenilen,

(d) piridindiil ili

(e)

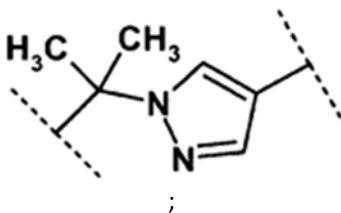

R30 je

(a) vodik ili

(b) C1-4 alkil;

Skupina Xb je

(a) halogen,

(b) C1-6 alkil,

(c) C1-3 alkil supstituiran s jednim hidroksi,

(d) C1-3 alkil supstituiran s jednim C1-3 alkoksi, i

(e) C1-3 alkoksi;

R4 je

- (1) vodik ili
- (2) metil;

R5 je

- (1) -Yc-COO-R50,
- (2) vodik,
- (3) C1-4 alkil, koji može biti supstituiran s jednim C1-3 alkoksi,
- (4) C1-4 alkil supstituiran s jednim amidom,
- (5) C1-3 alkil supstituiran s jednim C3-6 cikloalkilom supstituiranim s ista ili različita dva halogena,
- (6) C3-6 cikloalkil, koji može biti supstituiran s jednim hidroksi-C1-4 alkilom,
- (7) C3-6 cikloalkil supstituiran s jednim C1-3 alkoksi,
- (8) C3-6 cikloalkil supstituiran s jednim C1-3 alkoksi-C1-3 alkilom,
- (9) C3-6 cikloalkil supstituiran s istim ili različitim jednim do dva halogena,
- (10) C3-6 cikloalkil supstituiran s istim ili različitim jednim do dva C1-3 alkila,
- (11) tetrahidropiran-4-il ili
- (12) piridin-4-il;

Yc je

- (a) C1-6 alkilen, koji može biti supstituiran s jednim hidroksi,
- (b) CH<sub>2</sub>-CH<sub>2</sub>-O-CH<sub>2</sub> ili
- (c) (CH<sub>2</sub>)<sub>m</sub>-Yc<sub>1</sub>-(CH<sub>2</sub>)<sub>w</sub>;

m je cijeli broj 0, 1 ili 2;

w je cijeli broj 0, 1 ili 2;

Yc<sub>1</sub> je

- (a) C3-6 cikloalkilen, koji može biti supstituiran s jednim C1-3 alkilom,
- (b) fenilen,

- (c) fenilen supstituiran s jednim halogenom,
- (d) fenilen supstituiran s jednim C1-3 alkilom,
- (e) fenilen supstituiran s jednim C1-3 alkoksi,
- (f) fenilen supstituiran s jednim trifluormetilom,
- (g) umreženi C5-8 cikloalkilen,
- (h)

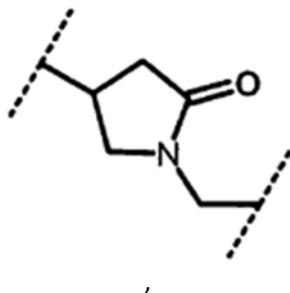

(i)

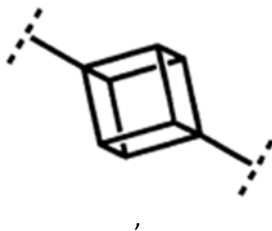

(j) spiro[3.3]heptandiil,

- (k) pirolidindiil,
- (l) pirolidindiil supstituiran s jednim karboksi,
- (m) pirolidindiil supstituiran s jednim C1-3 alkilkarbonilom,
- (n) pirolidindiil supstituiran s jednim C1-3 alkilsulfonilom,
- (o) piridindiil,
- (p) izoksazoldiil ili
- (q) pirazoldiil supstituiran s jednim C1-3 alkilom;

R50 je

- (a) vodik ili



(b) C1-4 alkil;

R6 je

(1) vodik ili

(2) metil;

uz uvjet da kada je R5 -Yc-COO-R50, Yc je (CH<sub>2</sub>)<sub>m</sub>-Yc<sub>1</sub>-(CH<sub>2</sub>)<sub>w</sub>, m i w su 0, a Yc<sub>1</sub> je (b) fenilen, (c) fenilen supstituiran s jednim halogenom, (d) fenilen supstituiran s jednim C1-3 alkilom, (e) fenilen supstituiran s jednim C1-3 alkoksi ili (f) fenilen supstituiran s jednim trifluormetilom, R6 je metil; i bilo R3 ili R5 ili njih oba imaju "-COO-".

**Patent sadrži još 36 patentnih zahtjeva**

(11) **03761** (13) **B**

(51) **A61K 9/08**<sup>(2006.01)</sup>

**A61K 31/50**<sup>(2006.01)</sup>

**A61K 9/19**<sup>(2006.01)</sup>

**A61P 9/04**<sup>(2006.01)</sup>

(21) P-2020-62

(22) 04.11.2016

(30) 20150193521 06.11.2015 EP

(96) 16790403.6/04.11.2016

(86) EP PCT/EP2016/076669/04.11.2016

(87) WO 2017/077032/11.05.2017/2017/19

(97) EP 3370693/12.09.2018/2018/37

EP 3370693/08.01.2020/2020/02

(54) me **POBOLJŠANE FORMULACIJE LEVOSIMENDANA ZA INTRAVENSKU PRIMJENU U VIDU INFUZIJE ILI INJEKCIJE I KONCENTRATA ZA INFUZIJU**  
en **IMPROVED FORMULATIONS OF LEVOSIMENDAN FOR INTRAVENOUS ADMINISTRATION AS INFUSION OR INJECTION AND OF INFUSION CONCENTRATE**

(73) CARINOPHARM GmbH

Bahnhofstraße 18, 31008 Elze/ DE

(72) WEILAND, Andrea

Georg-Knorr-Str. 4, Hohenbrunn 85662/ DE

(74) Advokat POPOVIĆ, Miladin

Đoka Miraševića 21/III, Podgorica, 81000 / ME

(57)

1. Farmaceutska kompozicija, koja sadrži levosimendan kao aktivni sastojak, i sredstvo za povećanje rastvorljivosti odabrano iz grupe koja se sastoji od sulfo-butil-etar-beta-ciklodekstrina, alfa-ciklodekstrina, metil-beta-ciklodekstrina i njihovih smeša, polietilenskih derivata alfa-tokoferola, i žučnih kiselina, pod uslovom da je upotreba ko-rastvarača kao što su etanol, propilenglikol, polietilenglikol, poloksameri ili polivinilpirolidon isključena.

**Patent sadrži još 18 patentnih zahtjeva**

(11) **03762** (13) **B**

(51) **G10L19/008**<sup>(2013.01)</sup>

**G10L19/24**<sup>(2013.01)</sup>

**G10L19/16**<sup>(2013.01)</sup>

(21) P-2020-63

(22) 07.10.2016

(30) 20150306590 08.10.2015 EP  
201662361809P 13.07.2016 US

(96) 16787751.3/07.10.2016

(86) EP PCT/EP2016/073970/07.10.2016

(87) WO 2017/060411/13.04.2017/2017/15

(97) EP 3360135/15.08.2018/2018/33  
EP 3360135/11.03.2020/2020/11

(54) me **SLOJEVITO KODIRANJE ZA PREZENTACIJE KOMPRIMOVANOG ZVUKA ILIZVUČNOG POLJA**  
en **LAYERED CODING FOR COMPRESSED SOUND OR SOUND FIELD REPRESENTATIONS**

(73) Dolby International AB

Apollo Building, 3E Herikerbergweg 1-35 1101 CN , Amsterdam Zuidoost / NL

(72) KORDON, Sven

Mühlenkampstrasse 50 A, 31515 Wunstorf / DE

KRUEGER, Alexander

Feuerbachstrasse 16, 30655 Hannover / DE

(74) Advokat RADULOVIĆ, Božidar S.

Baku 30/5, Podgorica, 81000 / ME

(57)

1. Postupak za dekodiranje komprimovane Higher Order Ambisonics, HOA, prezentacije (2100) zvuka ili zvučnog polja, pri čemu je to postupak koji obuhvata:

prijem binarnog niza koji sadrži komprimovanu HOA prezentaciju (2100) koja odgovara mnoštvu hijerarhijskih slojeva koji uključuju osnovni sloj i dva ili više poboljšanih hijerarhijskih slojeva, i koja sadrži osnovnu dodatnu informaciju (2120) koja je povezana sa osnovnim slojem i poboljšanom dodatnom informacijom (2140) koja je povezana sa dva ili više poboljšanih hijerarhijskih slojeva, pri čemu mnoštvo slojeva ima dodeljene komponente komprimovane prezentacije zvuka ili zvučnog polja, pri čemu se komponente dodeljuju respektivnim slojevima u respektivnim grupama komponenata, i pri čemu dva ili više poboljšanih hijerarhijskih slojeva obuhvataju najupotrebljiviji poboljšani hijerarhijski sloj, **naznačen time, što** svaki od dva ili više poboljšanih hijerarhijskih slojeva sadrži deo poboljšane dodatne informacije (2140) koja sadrži parametre za poboljšanje osnovne rekonstruisane prezentacije zvuka koja se može dobiti iz podataka sadržanih u respektivnom sloju i bilo kom nižem sloju od tog respektivnog sloja; i postupak dalje obuhvata dekodiranje komprimovane HOA prezentacije (2100) bazirane na osnovnoj dodatnoj informaciji (2120) koja je povezana sa osnovnim slojem, bazirane na delu poboljšane dodatne informacije (2140) koja je povezana sa najupotrebljivijim poboljšanim hijerarhijskim slojem, i koja nije bazirana na delu poboljšane dodatne informacije (2140) koja je povezana sa bilo kojim slojem od dva ili više poboljšanih hijerarhijskih slojeva.

**Patent sadrži još 6 patentnih zahtjeva.**

(11) **03763** (13) **B**

(51) **C07D471/04**<sup>(2006.01)</sup>

**A61P35/00**<sup>(2006.01)</sup>

**A61P31/00**<sup>(2006.01)</sup>

**A61P25/28**<sup>(2006.01)</sup>

**A61P9/10**<sup>(2006.01)</sup>

**A61K31/437**<sup>(2006.01)</sup>

**A61P37/00**<sup>(2006.01)</sup>

**A61P33/00**<sup>(2006.01)</sup>

**A61P11/06**<sup>(2006.01)</sup>

**A61P25/24**<sup>(2006.01)</sup>

(21) P-2020-64

(22) 22.04.2015

(30) 201461983289P 23.04.2014 US

(96) 15721085.7/22.04.2015

(86) US PCT/US2015/027047/22.04.2015

(87) WO 2015/164480/29.10.2015/2015/43

(97) EP 3134403/01.03.2017/2017/09

EP 3134403/12.02.2020/2010/07

(54) me **1H-PIRROLO[2,3-C]PIRIDIN-7(6H)-ONI I PIRAZOLO[3,4-C]PIRIDIN-7(6H)-ONI KAO INHIBITORI BET PROTEINA**

en **1H-PYRROLO[2,3-C]PYRIDIN-7(6H)-ONES AND PYRAZOLO[3,4-C]PYRIDIN-7(6H)-ONES AS INHIBITORS OF BET PROTEINS**

(73) Incyte Corporation

1801 Augustine Cut-Off, Wilmington DE 19803/ US

(72) COMBS, Andrew, P.

329 East Doe Run Road, Kennett Square, Pennsylvania 19348/ US

MADUSKUIE, Thomas, P., Jr.

613 Foulkstone Road, Wilmington, Delaware 19803/ US

FALAHATPISHEH, Nikoo

1822 Foulk Road, Wilmington, DE Delaware 19810/ US

(74) AOD "LUTOVAC & PARTNERI"

Bulevar Ivana Crnojevića 93, Podgorica, 81000 / ME

(57)

1. Jedinjenje Formule I:

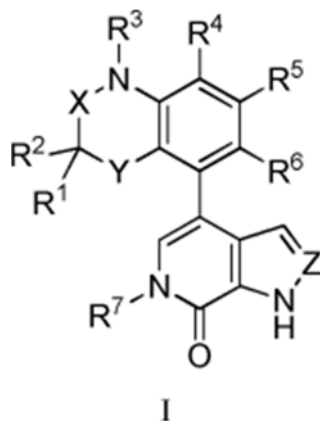

ili njegova farmaceutski prihvatljiva so, pri čemu:

X je C=O ili CR<sub>8</sub>R<sub>9</sub>;

Y je O ili NR10;

Z je CH ili N;

R1 i R2 su svaki nezavisno izabrani između H, halo, C1-6 alkil, C2-6 alkenil, C2-6 alkinil, C1-6 haloalkil,

Cy1, CN, ORa1, SRa1, C(O)Rb1, C(O)NRc1Rd1, C(O)ORa1, OC(O)Rb1, OC(O)NRc1Rd1, NRc1Rd1, NRc1C(O)Rb1, NRc1C(O)ORa1, NRc1C(O)NRc1Rd1, C(=NRe1)Rb1, C(=NRe1)NRc1Rd1, NRc1C(=NRe1)NRc1Rd1, NRc1S(O)Rb1, NRc1S(O)2Rb1, NRc1S(O)2NRc1Rd1, S(O)Rb1, S(O)NRc1Rd1, S(O)2Rb1, i S(O)2NRc1Rd1; pri čemu pomenuti C1-6 alkil, C2-6 alkenil, i C2-6 alkinil su svaki opciono supstituisani sa 1, 2, 3, 4, ili 5 supstituenata nezavisno izabrani između RA;

ili R1 i R2 zajedno sa atomom ugljenika sa kojim su vezani obrazuju C3-10 cikloalkilnu grupu ili 4-10 članu heterocikloalkilnu grupu, gde je svaka opciono supstituisana sa 1, 2, ili 3 supstituenata nezavisno izabranih između RA;

R3 je H ili C1-6 alkil opciono supstituisan sa 1, 2, ili 3 supstituenata nezavisno izabranih između halo, Cy, CN, NO2, ORa2, SRa2, C(O)Rb2, C(O)NRc2Rd2, C(O)ORa2, OC(O)Rb2, OC(O)NRc2Rd2, C(=NRe2)NRc2Rd2, NRc2C(=NRe2)NRc2Rd2, NRc2Rd2, NRc2C(O)Rb2, NRc2C(O)ORa2, NRc2C(O)NRc2Rd2, NRc2S(O)Rb2, NRc2S(O)2Rb2, NRc2S(O)2NRc2Rd2, S(O)Rb2, S(O)NRc2Rd2, S(O)2Rb2, i S(O)2NRc2Rd2;

R4 je H;

R5 je H, halo, C1-6 alkil, C2-6 alkenil, C2-6 alkinil, C1-6 haloalkil, Cy2, CN, NO2, ORa4, SRa4, C(O)Rb4,

C(O)NRc4Rd4, C(O)ORa4, OC(O)Rb4, OC(O)NRc4Rd4, NRc4Rd4, NRc4C(O)Rb4, NRc4C(O)ORa4, NRc4C(O)NRc4Rd4, C(=NRe4)Rb4, C(=NRe4)NRc4Rd4, NRc4C(=NRe4)NRc4Rd4, NRc4S(O)Rb4, NRc4S(O)2Rb4, NRc4S(O)2NRc4Rd4, S(O)Rb4, S(O)NRc4Rd4, S(O)2Rb4, ili S(O)2NRc4Rd4; pri čemu pomenuti C1-6 alkil, C2-6 alkenil, i C2-6 alkinil su svaki opciono supstituisani sa 1, 2, 3, 4, ili 5 supstituenata nezavisno izabranih između RB;

R6 je H;

R7 je C1-4 alkil;

R8 i R9 su svaki H;

R10 je H;

svaki RA je nezavisno izabran između Cy1, halo, CN, NO2, ORa1, SRa1, C(O)Rb1, C(O)NRc1Rd1, C(O)ORa1, OC(O)Rb1, OC(O)NRc1Rd1, C(=NRe1)NRc1Rd1, NRc1C(=NRe1)NRc1Rd1, NRc1Rd1, NRc1C(O)Rb1,

NRc1C(O)ORa1, NRc1C(O)NRc1Rd1, NRc1S(O)Rb1, NRc1S(O)2Rb1, NRc1S(O)2NRc1Rd1, S(O)Rb1, S(O)NRc1Rd1, S(O)2Rb1, i S(O)2NRc1Rd1;

svaki RB je nezavisno izabran između Cy2, halo, CN, NO2, ORa4, SRa4, C(O)Rb4, C(O)NRc4Rd4, C(O)ORa4, OC(O)Rb4, OC(O)NRc4Rd4, C(=NRe4)NRc4Rd4, NRc4C(=NRe4)NRc4Rd4, NRc4Rd4, NRc4C(O)Rb4,

NRc4C(O)ORa4, NRc4C(O)NRc4Rd4, NRc4S(O)Rb4, NRc4S(O)2Rb4, NRc4S(O)2NRc4Rd4, S(O)Rb4, S(O)NRc4Rd4, S(O)2Rb4, i S(O)2NRc4Rd4;

svaki Cy je nezavisno izabran između C6-10 aril, C3-10 cikloalkil, 5-10 člani heteroaril, i 4-10 člani

heterocikloalkil, od kojih je svaki opciono supstituisan sa 1, 2, 3, 4, ili 5 supstituenata nezavisno izabranih između RC;

svaki RC je nezavisno izabran između halo, C1-6 alkil, C2-6 alkenil, C2-6 alkinil, C1-6 haloalkil, C6-10 aril, C3-10 cikloalkil, 5-10 člani heteroaril, 4-10 člani heterocikloalkil, CN, ORa2, SRa2, C(O)Rb2, C(O)NRc2Rd2, C(O)ORa2, OC(O)Rb2, OC(O)NRc2Rd2, NRc2Rd2, NRc2C(O)Rb2, NRc2C(O)ORa2, NRc2C(O)NRc2Rd2, C(=NRe2)Rb2, C(=NRe2)NRc2Rd2, NRc2C(=NRe2)NRc2Rd2, NRc2S(O)Rb2, NRc2S(O)2Rb2, NRc2S(O)2NRc2Rd2, S(O)Rb2, S(O)NRc2Rd2, S(O)2Rb2, i S(O)2NRc2Rd2; pri čemu pomenuti C1-6 alkil, C2-6 alkenil, C2-6 alkinil, C6-10 aril, C3-10 cikloalkil, 5-10 člani heteroaril, i 4-10 člani heterocikloalkil su svaki opciono supstituisani sa 1, 2, 3, 4, ili 5 supstituenata nezavisno izabranih između halo, C1-4 alkil, C1-4 haloalkil, CN, ORa2, SRa2, C(O)Rb2, C(O)NRc2Rd2, C(O)ORa2, OC(O)Rb2,

OC(O)NRc2Rd2, NRc2Rd2, NRc2C(O)Rb2, NRc2C(O)ORa2, NRc2C(O)NRc2Rd2, C(=NRe2)Rb2, C(=NRe2)NRc2Rd2, NRc2C(=NRe2)NRc2Rd2, NRc2S(O)Rb2, NRc2S(O)2Rb2, NRc2S(O)2NRc2Rd2, S(O)Rb2, S(O)NRc2Rd2, S(O)2Rb2, i S(O)2NRc2Rd2;

svaki Cy1 je nezavisno izabran između C6-10 aril, C3-10 cikloalkil, 5-10 člani heteroaril, i 4-10 člani heterocikloalkil, od kojih je svaki opciono supstituisan sa 1, 2, 3, 4, ili 5 supstituenata nezavisno izabranih između RD;

svaki RD je nezavisno izabran između halo, C1-6 alkil, C2-6 alkenil, C2-6 alkinil, C1-6 haloalkil, C6-10 aril, C3-10 cikloalkil, 5-10 člani heteroaril, 4-10 člani heterocikloalkil, CN, ORa1, SRa1, C(O)Rb1,

C(O)NRc1Rd1, C(O)ORa1, OC(O)Rb1, OC(O)NRc1Rd1, NRc1Rd1, NRc1C(O)Rb1, NRc1C(O)ORa1, NRc1C(O)NRc1Rd1, C(=NRe1)Rb1, C(=NRe1)NRc1Rd1, NRc1C(=NRe1)NRc1Rd1, NRc1S(O)Rb1, NRc1S(O)2Rb1, NRc1S(O)2NRc1Rd1, S(O)Rb1, S(O)NRc1Rd1, S(O)2Rb1, i S(O)2NRc1Rd1; pri čemu pomenuti C1-6 alkil, C2-6 alkenil, C2-6 alkinil, C6-10 aril, C3-10 cikloalkil, 5-10 člani heteroaril, i 4-10 člani heterocikloalkil su svaki opciono supstituisani sa 1, 2, 3, 4, ili 5 supstituenata nezavisno izabranih između halo, C1-4 alkil, C1-4 haloalkil, CN, ORa1, SRa1, C(O)Rb1, C(O)NRc1Rd1, C(O)ORa1, OC(O)Rb1, OC(O)NRc1Rd1, NRc1Rd1, NRc1C(O)Rb1, NRc1C(O)ORa1, NRc1C(O)NRc1Rd1, C(=NRe1)Rb1, C(=NRe1)NRc1Rd1, NRc1C(=NRe1)NRc1Rd1, NRc1S(O)Rb1, NRc1S(O)2Rb1, NRc1S(O)2NRc1Rd1, S(O)Rb1, S(O)NRc1Rd1, S(O)2Rb1, i S(O)2NRc1Rd1;

svaki Cy2 je nezavisno izabran između C6-10 aril, C3-10 cikloalkil, 5-10 člani heteroaril, i 4-10

člani heterocikloalkil, od kojih je svaki opciono supstituisan sa 1, 2, 3, 4, ili 5 supstituenata nezavisno izabranih između RE;

svaki RE je nezavisno izabran između halo, C1-6 alkil, C2-6 alkenil, C2-6 alkinil, C1-6 haloalkil, C6-10 aril, C3-10 cikloalkil, 5-10 člani heteroaril, 4-10 člani heterocikloalkil, CN, ORa4, SRa4, C(O)Rb4,

C(O)NRc4Rd4, C(O)ORa4, OC(O)Rb4, OC(O)NRc4Rd4, NRc4Rd4, NRc4C(O)Rb4, NRc4C(O)ORa4, NRc4C(O)NRc4Rd4, C(=NRe4)Rb4, C(=NRe4)NRc4Rd4, NRc4C(=NRe4)NRc4Rd4, NRc4S(O)Rb4, NRc4S(O)2Rb4, NRc4S(O)2NRc4Rd4, S(O)Rb4, S(O)NRc4Rd4, S(O)2Rb4, i S(O)2NRc4Rd4; pri čemu pomenuti C1-6 alkil, C2-6 alkenil, C2-6 alkinil, C6-10 aril, C3-10 cikloalkil, 5-10 člani heteroaril, i 4-10 člani heterocikloalkil su svaki opciono supstituisani sa 1, 2, 3, 4, ili 5 supstituenata nezavisno izabranih između halo, C1-4 alkil, C1-4 haloalkil, CN, ORa4, SRa4, C(O)Rb4, C(O)NRc4Rd4, C(O)ORa4, OC(O)Rb4, OC(O)NRc4Rd4, NRc4Rd4, NRc4C(O)Rb4, NRc4C(O)ORa4, NRc4C(O)NRc4Rd4, C(=NRe4)Rb4, C(=NRe4)NRc4Rd4, NRc4C(=NRe4)NRc4Rd4, NRc4S(O)Rb4, NRc4S(O)2Rb4, NRc4S(O)2NRc4Rd4, S(O)Rb4, S(O)NRc4Rd4, S(O)2Rb4, i S(O)2NRc4Rd4;

svaki Ra1, Rb1, Rc1, i Rd1 je nezavisno izabran između H, C1-6 alkil, C1-4 haloalkil, C2-6 alkenil, C2-6 alkinil, C6-10 aril, C3-10 cikloalkil, 5-10 člani heteroaril, 4-10 člani heterocikloalkil, C6-10 aril-

C1-4 alkil, C3-10 cikloalkil-C1-4 alkil, (5-10 člani heteroaril)-C1-4 alkil, i (4-10 člani heterocikloalkil)-

C1-4 alkil, pri čemu pomenuti C1-6 alkil, C2-6 alkenil, C2-6 alkinil, C6-10 aril, C3-10 cikloalkil, 5-10 člani

heteroaril, 4-10 člani heterocikloalkil, C6-10 aril-C1-4 alkil, C3-10 cikloalkil-C1-4 alkil, (5-10 člani heteroaril)-C1-4 alkil, i (4-10 člani heterocikloalkil)-C1-4 alkil su svaki opciono supstituisani sa 1,

2, 3, 4, ili 5 supstituenata nezavisno izabranih između C1-4 alkil, C1-4 haloalkil, halo, CN, ORa5, SRa5, C(O)Rb5, C(O)NRc5Rd5, C(O)ORa5, OC(O)Rb5, OC(O)NRc5Rd5, NRc5Rd5, NRc5C(O)Rb5, NRc5C(O)NRc5Rd5, NRc5C(O)ORa5, C(=NRe5)NRc5Rd5, NRc5C(=NRe5)NRc5Rd5, S(O)Rb5, S(O)NRc5Rd5, S(O)2Rb5, NRc5S(O)2Rb5, NRc5S(O)2NRc5Rd5, i S(O)2NRc5Rd5;

ili bilo koji Rc1 i Rd1 zajedno sa N atomom sa kojim su vezani obrazuju 4-, 5-, 6-, ili 7-članu

heterocikloalkilnu grupu opciono supstituisanu sa 1, 2, ili 3 supstituenata nezavisno izabrani između C1-6 alkil, C3-7 cikloalkil, 4-7 člani heterocikloalkil, C6-10 aril, 5-6 člani heteroaril, C1-6 haloalkil, halo, CN, ORa5, SRa5, C(O)Rb5, C(O)NRc5Rd5, C(O)ORa5, OC(O)Rb5, OC(O)NRc5Rd5, NRc5Rd5, NRc5C(O)Rb5, NRc5C(O)NRc5Rd5, NRc5C(O)ORa5, C(=NRe5)NRc5Rd5, NRc5C(=NRe5)NRc5Rd5, S(O)Rb5, S(O)NRc5Rd5, S(O)2Rb5, NRc5S(O)2Rb5, NRc5S(O)2NRc5Rd5, i S(O)2NRc5Rd5, pri čemu pomenuti C1-6 alkil, C3-7 cikloalkil, 4-7 člani heterocikloalkil, C6-10 aril, i 5-6 člani heteroaril asu svaki opciono supstituisani sa 1, 2, ili 3 supstituenata nezavisno izabranih između halo, CN, ORa5, SRa5, C(O)Rb5, C(O)NRc5Rd5, C(O)ORa5, OC(O)Rb5, OC(O)NRc5Rd5, NRc5Rd5, NRc5C(O)Rb5, NRc5C(O)NRc5Rd5, NRc5C(O)ORa5, C(=NRe5)NRc5Rd5, NRc5C(=NRe5)NRc5Rd5, S(O)Rb5, S(O)NRc5Rd5, S(O)2Rb5, NRc5S(O)2Rb5, NRc5S(O)2NRc5Rd5, i S(O)2NRc5Rd5;

svaki Ra2, Rb2, Rc2, i Rd2 je nezavisno izabran između H, C1-6 alkil, C1-4 haloalkil, C2-6 alkenil, C2-6

alkinil, C6-10 aril, C3-10 cikloalkil, 5-10 člani heteroaril, 4-10 člani heterocikloalkil, C6-10 aril-

C1-4 alkil, C3-10 cikloalkil-C1-4 alkil, (5-10 člani heteroaril)-C1-4 alkil, i (4-10 člani heterocikloalkil)-

C1-4 alkil, pri čemu pomenuti C1-6 alkil, C2-6 alkenil, C2-6 alkinil, C6-10 aril, C3-10 cikloalkil, 5-10 člani

heteroaril, 4-10 člani heterocikloalkil, C6-10 aril-C1-4 alkil, C3-10 cikloalkil-C1-4 alkil, (5-10 člani

heteroaril)-C1-4 alkil, i (4-10 člani heterocikloalkil)-C1-4 alkil su svaki opciono supstituisani sa 1,

2, 3, 4, ili 5 supstituenata nezavisno izabranih između C1-4 alkil, C1-4 haloalkil, halo, CN, ORa5, SRa5, C(O)Rb5, C(O)NRc5Rd5, C(O)ORa5, OC(O)Rb5, OC(O)NRc5Rd5, NRc5Rd5, NRc5C(O)Rb5, NRc5C(O)NRc5Rd5, NRc5C(O)ORa5, C(=NRe5)NRc5Rd5, NRc5C(=NRe5)NRc5Rd5, S(O)Rb5, S(O)NRc5Rd5, S(O)2Rb5, NRc5S(O)2Rb5, NRc5S(O)2NRc5Rd5, i S(O)2NRc5Rd5;

ili bilo koji Rc2 i Rd2 zajedno sa N atomom sa kojim su vezani obrazuju 4-, 5-, 6-, ili 7-članu heterocikloalkilnu grupu opciono supstituisanu sa 1, 2, ili 3 supstituenata nezavisno izabranih između C1-6 alkil, C3-7 cikloalkil, 4-7 člani heterocikloalkil, C6-10 aril, 5-6 člani heteroaril, C1-6 haloalkil, halo, CN, ORa5, SRa5, C(O)Rb5, C(O)NRc5Rd5, C(O)ORa5, OC(O)Rb5, OC(O)NRc5Rd5, NRc5Rd5, NRc5C(O)Rb5, NRc5C(O)NRc5Rd5, NRc5C(O)ORa5, C(=NRe5)NRc5Rd5, NRc5C(=NRe5)NRc5Rd5, S(O)Rb5, S(O)NRc5Rd5, S(O)2Rb5, NRc5S(O)2Rb5, NRc5S(O)2NRc5Rd5, i S(O)2NRc5Rd5, pri čemu pomenuti C1-6 alkil, C3-7 cikloalkil, 4-7 člani heterocikloalkil, C6-10 aril, i 5-6 člani heteroaril su svaki opciono supstituisani sa 1, 2, ili 3 supstituenata nezavisno izabranih između halo, CN, ORa5, SRa5, C(O)Rb5, C(O)NRc5Rd5, C(O)ORa5, OC(O)Rb5, OC(O)NRc5Rd5, NRc5Rd5, NRc5C(O)Rb5, NRc5C(O)NRc5Rd5, NRc5C(O)ORa5, C(=NRe5)NRc5Rd5, NRc5C(=NRe5)NRc5Rd5, S(O)Rb5, S(O)NRc5Rd5, S(O)2Rb5, NRc5S(O)2Rb5, NRc5S(O)2NRc5Rd5, i S(O)2NRc5Rd5;

svaki Ra4, Rb4, Rc4, i Rd4 je nezavisno izabran između H, C1-6 alkil, C1-4 haloalkil, C2-6 alkenil, C2-6

alkinil, C6-10 aril, C3-10 cikloalkil, 5-10 člani heteroaril, 4-10 člani heterocikloalkil, C6-10 aril-

C1-4 alkil, C3-10 cikloalkil-C1-4 alkil, (5-10 člani heteroaril)-C1-4 alkil, i (4-10 člani heterocikloalkil)-

C1-4 alkil, pri čemu pomenuti C1-6 alkil, C2-6 alkenil, C2-6 alkinil, C6-10 aril, C3-10 cikloalkil, 5-10 člani

heteroaril, 4-10 člani heterocikloalkil, C6-10 aril-C1-4 alkil, C3-10 cikloalkil-C1-4 alkil, (5-10 člani heteroaril)-C1-4 alkil, i (4-10 člani heterocikloalkil)-C1-4 alkil su svaki opciono supstituisani sa 1, 2, 3, 4, ili 5 supstituenata nezavisno izabranih između C1-4 alkil, C1-4 haloalkil, halo, CN, ORa5, SRa5, C(O)Rb5, C(O)NRc5Rd5, C(O)ORa5, OC(O)Rb5, OC(O)NRc5Rd5, NRc5Rd5, NRc5C(O)Rb5, NRc5C(O)NRc5Rd5, NRc5C(O)ORa5, C(=NRe5)NRc5Rd5, NRc5C(=NRe5)NRc5Rd5, S(O)Rb5, S(O)NRc5Rd5, S(O)2Rb5, NRc5S(O)2Rb5, NRc5S(O)2NRc5Rd5, i S(O)2NRc5Rd5;

ili bilo koji Rc4 i Rd4 zajedno sa N atomom sa kojim su vezani obrazuju 4-, 5-, 6-, ili 7-članu

heterocikloalkilnu grupu opciono supstituisanu sa 1, 2, ili 3 supstituenata nezavisno izabranih između C1-6 alkil, C3-7 cikloalkil, 4-7 člani heterocikloalkil, C6-10 aril, 5-6 člani heteroaril, C1-6 haloalkil, halo, CN, ORa5, SRa5, C(O)Rb5, C(O)NRc5Rd5, C(O)ORa5, OC(O)Rb5, OC(O)NRc5Rd5, NRc5Rd5, NRc5C(O)Rb5, NRc5C(O)NRc5Rd5, NRc5C(O)ORa5, C(=NRe5)NRc5Rd5, NRc5C(=NRe5)NRc5Rd5, S(O)Rb5, S(O)NRc5Rd5, S(O)2Rb5, NRc5S(O)2Rb5, NRc5S(O)2NRc5Rd5, i S(O)2NRc5Rd5, pri čemu pomenuti C1-6 alkil, C3-7 cikloalkil, 4-7 člani heterocikloalkil, C6-10 aril, i 5-6 člani heteroaril su svaki opciono supstituisani sa 1, 2, ili 3 supstituenata nezavisno izabranih između halo, CN, ORa5, SRa5, C(O)Rb5, C(O)NRc5Rd5, C(O)ORa5, OC(O)Rb5, OC(O)NRc5Rd5, NRc5Rd5, NRc5C(O)Rb5, NRc5C(O)NRc5Rd5, NRc5C(O)ORa5, C(=NRe5)NRc5Rd5, NRc5C(=NRe5)NRc5Rd5, S(O)Rb5, S(O)NRc5Rd5, S(O)2Rb5, NRc5S(O)2Rb5, NRc5S(O)2NRc5Rd5, i S(O)2NRc5Rd5;

svaki Ra5, Rb5, Rc5, i Rd5 je nezavisno izabran između H, C1-4 alkil, C1-4 haloalkil, C2-4 alkenil, i C2-4

alkinil, pri čemu pomenuti C1-4 alkil, C2-4 alkenil, i C2-4 alkinil su svaki opciono supstituisani sa 1, 2, ili 3 supstituenata nezavisno izabranih između OH, CN, amino, halo, C1-4 alkil, C1-4 alkoksi, C1-4 alkiltio, C1-4 alkilamino, di(C1-4 alkil)amino, C1-4 haloalkil, i C1-4 haloalkoksi;

ili bilo koji Rc5 i Rd5 zajedno sa N atomom sa kojim su vezani obrazuju 4-, 5-, 6-, ili 7-članu heterocikloalkilnu grupu opcionalno supstituisanu sa 1, 2, ili 3 supstituenata nezavisno izabranih između OH, CN, amino, halo, C1-6 alkil, C1-4 alkoksi, C1-4 alkiltio, C1-4 alkilamino, di(C1-4 alkil)amino, C1-4 haloalkil, i C1-4

haloalkoksi; i

svaka Re1, Re2, Re4, i Re5 je nezavisno izabrana između H, C1-4 alkil, i CN.

**Patent sadrži još 41 patentnih zahtjeva**



(11) **03764** (13) **B**

(51) **C07D 471/04**<sup>(2006.01)</sup>

**C07D 495/04**<sup>(2006.01)</sup>

**A61P35/00**<sup>(2006.01)</sup>

**C07D 487/04**<sup>(2006.01)</sup>

**A61K 31/519**<sup>(2006.01)</sup>

(21) P-2020-65

(22) 09.06.2017

(30) 20160055387 10.06.2016 FR

20160063463 28.12.2016 FR

(96) 17728567.3/09.06.2017

(86) EP PCT/EP2017/064062/09.06.2017

(87) WO 2017/212010/14.12.2017/2017/50

(97) EP 3468971/17.04.2019/2019/16

EP 3468971/19.02.2020/2020/08

(54) me **NOVI (HERERO) ARIL-SUPSTITUISANI-PIPERIDINIL DERIVATI, POSTUPAK ZA NJIHOVU PRIPRAVU I FARMACEUTSKI PRIPRAVCI KOJI IH SADRŽE**

en **NEW (HETERO)ARYL-SUBSTITUTED-PIPERIDINYL DERIVATIVES, A PROCESS FOR THEIR PREPARATION AND PHARMACEUTICAL COMPOSITIONS CONTAINING THEM**

(73) Les Laboratoires Servier

35, rue de Verdun, Suresnes Cedex, 92284/ FR

Vernalis (R&D) Limited

Granta Park, Cambridge CB21 6GB/ GB

(72) KOTSCHY, András

Álmos Vezér utca 4, Törökbalint , 2045/ HU

WÉBER, Csaba

Szentendrei utca 9, Pilisszentlászló , 2009/ HU

VASAS, Attila

Eöri Barna u. 65, Fót, 2151 / HU

MOLNÁR, Balázs

Fenyves utca 3, Isaszeg , 2117 / HU

KISS, Árpád

Füst Milán utca 6 3/10 , Budapest , 1039 / HU

MACIAS, Alba

12 Beaulands Close, Cambridge Cambridgeshire CB4 1JA / GB

MURRAY, James Brooke

21 Parsonage Way, Linton, Cambridgeshire , CB21 4YL/ GB

LEWKOWICZ, Elodie

4 rue Georges Saché, Paris , 75014 / FR

GENESTE, Olivier

Bâtiment A 17 rue Crevel Duval , Rueil Malmaison , 92500 / FR

CHANRION, Maïa

14 rue de la Galiote Apt D441, Issy Les Moulineaux, 92130 / FR

DEMARLES, Didier

21 rue du Lièvre, Checy, 45430 / FR

IVANSCHITZ, Lisa

51 rue des Nouvelles, Suresnes , 92150 / FR

(74) Advokat JUSIĆ, Jasna

Dalmatinska 2, Podgorica, 81000 / ME

(57)

1. Spoj formule (I):

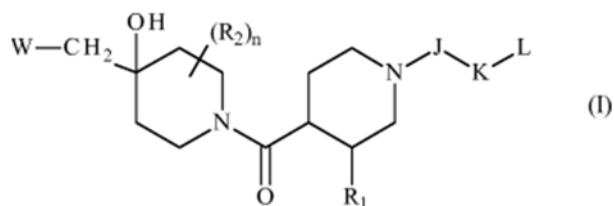

**naznačen time, da:**

- ◆ R1 predstavlja arilnu skupinu ili heteroarilnu skupinu,
- ◆ R2 predstavlja atom vodika ili atom halogena,
- ◆ n je cijeli broj jednak 0, 1 ili 2,
- ◆ J predstavlja -C(O)- skupinu, -CH(R3)- skupinu ili -SO2- skupinu,
- ◆ R3 predstavlja atom vodika ili ravnu ili razgrananu (C1-C6)alkilnu skupinu,
- ◆ K predstavlja vezu ili -Cy1- skupinu,
- ◆ L predstavlja -Cy2 skupinu ili -CH2-Cy2 skupinu,
- ◆ W predstavlja skupinu

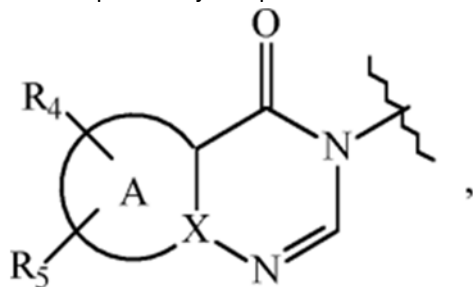

u kojem:

- A predstavlja heteroarilni prsten,
- X predstavlja atom ugljika ili atom dušika,
- R4 predstavlja atom vodika, atom halogena, ravnu ili razgrananu (C1-C6)alkilnu skupinu, ravnu ili razgrananu (C2-C6)alkenilnu skupinu, ravnu ili razgrananu (C2-C6)alkinilnu skupinu, -Y1- NR5R7 skupinu, -Y1-OR6 skupinu, ravnu ili razgrananu halo(C1-C6)alkilnu skupinu, okso skupinu, -Y1-Cy3 skupinu, -Cy3-R7 skupinu, -Cy3-OR7 skupinu ili -Y1-NR6-C(O)-R7 skupinu,
- R5 predstavlja atom vodika, atom halogena ili ravnu ili razgrananu (C1-C6)alkilnu skupinu,
- R6 predstavlja atom vodika ili ravnu ili razgrananu (C1-C6)alkilnu skupinu,
- R7 predstavlja atom vodika ili ravnu ili razgrananu (C1-C6)alkilnu skupinu ili -Y2-Cy4 skupinu,
- Y1 i Y2 neovisno jedan o drugome predstavljaju vezu ili ravnu ili razgrananu (C1-C4)alkilensku skupinu,
- ◆ Cy1 predstavlja cikloalkilnu skupinu, heterocikloalkilnu skupinu, arilnu skupinu ili heteroarilnu skupinu, koja je vezana na skupinu J i na skupinu L,
- ◆ Cy2, Cy3 i Cy4 neovisno jedan o drugome predstavljaju cikloalkilnu skupinu, heterocikloalkilnu skupinu, arilnu skupinu ili heteroarilnu skupinu,

kada se podrazumijeva da:

- "aril" znači fenilna, naftilna ili indanilna skupina,

- "heteroaril" znači bilo koja mono- ili kondenzirana bi-ciklička skupina sastavljena od 5 do 10 članova prstena, koji imaju najmanje jednu aromatsku skupinu koja sadrži 1 do 3 heteroatoma odabrana između kisika, sumpora i dušika,
- "cikloalkil" znači bilo koja mono- ili kondenzirana bi-ciklička ne-aromatska karbociklička skupina koja sadrži 3 do 7 članova prstena,
- "heterocikloalkil" znači bilo koja nearomatska mono- ili kondenzirana bi-ciklička skupina koja sadrži 3 do 10 članova prstena, i koji sadrže 1 do 3 heteroatoma odabrana između kisika, sumpora i dušika,

pri čemu su arilne, heteroarilne, cikloalkilne i heterocikloalkilne skupine tako definirane da mogu biti supstituirane s 1 do 4 skupine odabrane od ravnog ili razgranalog (C1-C6)alkila, ravnog ili razgranalog (C2-C6)alkenila, ravnog ili razgranalog (C2-C6)alkinila, ravnog ili razgranalog halo(C1- C6)alkila,

-Y1-OR', -Y1-NR'R", -Y1-S (O)m-R', okso(ili N-oksidi gdje je to prikladno), nitro, cijano, -C(O)-R',

-C(O)-OR', -O-C(O)-R', -C(O)-NR'R", -Y1-NR'-C(O)-R", -Y1-NR'-C(O)-OR", halogena, ciklopropila i

piridinila koji može biti supstituiran ravnim ili razgrananim (C1-C6)alkilnom skupinom, podrazumijeva se da R' i R" neovisno jedan o drugom predstavljaju atom vodika, ravnu ili razgrananu

(C1-C6)alkilnu skupinu, ravnu ili razgrananu (C2-C6)alkenilnu skupinu, ravnu ili razgrananu (C1-C6)alkoksi skupinu, ravni ili razgranani (C1-C6)alkil, ravnu ili razgrananu hidroksi(C1-C6)alkilnu skupinu, ravnu ili razgrananu (C1-C6)alkoksi(C1-C6)alkilnu skupinu, fenilnu skupinu, ciklopropilmetilnu skupinu, tetrahidropiraniolnu skupinu ili supstituente para (R', R") koji zajedno s dušikovim atomom tvore ne-aromatski prsten sastavljen od 5 do 7 članova prstena, koji uz dušik mogu sadržavati i drugi odabrani heteroatom iz kisika i dušika, podrazumijeva se da drugi ovdje navedeni dušik može biti supstituiran s 1 do 2 skupine koje predstavljaju atom vodika, ili ravnu ili razgrananu (C1-C6)alkilnu skupinu te se podrazumijeva da je m cijeli broj jednak 0, 1 ili 2, njihovi enantiomeri, diastereoizomeri i njihove adicijske soli s farmaceutski prihvatljivom kiselinom ili bazom.

**Patent sadrži još 33 patentnih zahtjeva**

(11) **03765** (13) **B**

(51) **A61K 39/395**<sup>(2006.01)</sup>

**C07K 16/40**<sup>(2006.01)</sup>

**A61P 3/06**<sup>(2006.01)</sup>

(21) P-2020-67

(22) 10.05.2012

(30) 201161484610P 10.05.2011 US

201161562303P 21.11.2011 US

201261595526P 06.02.2012 US

201261614417P 22.03.2012 US

201261642363P 03.05.2012 US

(96) 12722044.0/10.05.2012

(86) US PCT/US2012/037394/10.05.2012

(87) WO 2012/154999/15.11.2012/2012/46

(97) EP 2707029/19.03.2014/2014/12

EP 2707029/15.01.2020/2020/03

(54) me **POSTUPCI LIJEČENJA ILI PREVENCIJE POREMEĆAJA POVEZANIH SA HOLESTEROLOM**  
en **METHODS OF TREATING OR PREVENTING CHOLESTEROL RELATED DISORDERS**

(73) Amgen Inc.

One Amgen Center Drive, Thousand Oaks, California 91320/ US

(72) CHAN, Joyce Chi Yee

314 College Avenue, San Francisco California 94112/ US

GIBBS, John P.

4840 E. Mercer Way, Mercer Island Washington 98040 / US

DIAS, Clapton S.

4278 Via Encanto, Newbury Park California 91320 / US

WASSERMAN, Scott

5238 Via Pisa, Newbury Park California 91320/ US

SCOTT, Robert Andrew Donald

701 N. Conejo School Road, Thousand Oaks California 91362/ US

CLOGSTON, Christi L.

601 Country View Place, Camarillo California 93010 / US

OSSLUND, Timothy David

475 Vista Montana, Camarillo California 93010/ US

STEIN, Evan, A.

25 E, Superior Street, Chicago, IL 60611 / US

(74) Advokat RADULOVIĆ, Božidar S.

Baku 30/5, Podgorica, 81000 / ME

(57)

1. Monoklonalno antitelo koje se specifično vezuje za PCSK9 koje obuhvata

- a) region utvrđivanja komplementarnosti (CDR) lakog lanca od CDRL1 sekvence u SEQ ID NO:23, CDRL2 od CDRL2 sekvence u SEQ IDNO:23, i CDRL3 od CDRL3 sekvence u SEQ ID NO:23; i region utvrđivanja komplementarnosti (CDR) teškog lanca od CDRH1 sekvence u SEQID NO:49, CDRH2 od CDRH2 sekvence u SEQ ID NO:49, i CDRH3 od CDRH3 sekvence uSEQ ID NO:49; pri čemu se CDR-ovi definišu pomoću Chothia ili AbM;
- b) region utvrđivanja komplementarnosti (CDR) lakog lanca CDRL1 koji obuhvata sekvencu aminokiseline od SEQ ID NO: 158, CDRL2koji obuhvata sekvencu aminokiseline od SEQ ID NO: 162, CDRL3 koji obuhvata sekvencuaminokiseline od SEQ ID NO: 395; i region utvrđivanja komplementarnosti (CDR) teškog lanca CDRH1 koji obuhvata sekvencuaminokiseline od SEQ ID NO: 368, CDRH2 koji obuhvata sekvencu aminokiseline odSEQ ID NO: 175, CDRH3 koji obuhvata sekvencu aminokiseline od SEQ ID NO: 180;

c) region utvrđivanja komplementarnosti (CDR) lakoglanca CDRL1 koji obuhvata sekvencu aminokiseline od SEQ ID NO: 305, CDRL2 koji obuhvata sekvencu aminokiseline od SEQ ID NO: 312, CDRL3 koji obuhvata sekvencu aminokiseline od SEQ ID NO: 319; i region utvrđivanja komplementarnosti (CDR) teškog lanca CDRH1 koji obuhvata sekvencu aminokiseline od SEQ ID NO: 308, CDRH2 koji obuhvata sekvencu aminokiseline od SEQ ID NO: 320, CDRH3 koji obuhvata sekvencu aminokiseline od SEQ ID NO: 310;

ili  
d) promenljivi region lakog lanca koji obuhvata sekvencu aminokiseline od SEQ ID NO: 23 i promenljivi region teškog lanca koji obuhvata sekvencu aminokiseline od SEQ ID NO: 49

za upotrebu u

(i) snižavanju LDL holesterola u serumu ljudskog pacijenta za najmanje 15%; i/ili

(ii) lečenju ili prevenciji poremećaja povezanog sa holesterolom ljudskog pacijenta koji ima povišen nivo LDL holesterola u serumu;

što obuhvata davanje monoklonalnog antitela ljudskom pacijentu kojem je to potrebno u dozi od 70 mg do 450 mg.

**Patent sadrži još 9 patentnih zahtjeva.**

(11) **03766** (13) **B**

(51) **A61K 31/506**<sup>(2006.01)</sup>

**C07D 417/14**<sup>(2006.01)</sup>

**C07D 413/14**<sup>(2006.01)</sup>

**A61P 21/00**<sup>(2006.01)</sup>

**A61K 31/519**<sup>(2006.01)</sup>

**C07D 401/12**<sup>(2006.01)</sup>

**C07D 401/14**<sup>(2006.01)</sup>

(21) P-2020-68

(22) 22.04.2011

(30) 20100327597P 23.04.2010 US

20100412299P 10.11.2010 US

(96) 16164963.7/22.04.2011

(97) EP 3127540/08.02.2017/2017/06

EP 3127540/29.01.2020/2020/05

(54) me **ODREĐENI AMINO-PIRIMIDINI, NJIHOVE KOMPOZICIJE, I METODE NJIHOVE UPOTREBE**  
en **CERTAIN AMINO-PYRIMIDINES, COMPOSITIONS THEREOF, AND METHODS FOR THEIR USE**

(73) Cytokinetics, Inc.

280 East Grand Avenue, South San Francisco, CA 94080/ US

(72) WARRINGTON, Jeffrey

1936 Playa Street, San Mateo, California 94403/ US

ROMERO, Antonio

1309 Newbridge Avenue, San Mateo, California 94401/ US

YANG, Zhe

280 East Grand Avenue , South San Francisco, CA 94080 / US

MUCI, Alex R.

280 East Grand Avenue , South San Francisco, CA 94080 / US/ US

BERGNES, Gustave

280 East Grand Avenue , South San Francisco, CA 94080/ US

MORGAN, Bradley P.

280 East Grand Avenue, South San Francisco, CA 94080/ US

CHUANG, Chihyuan

280 East Grand Avenue , South San Francisco, CA 94080/ US

COLLIBEE, Scott

280 East Grand Avenue, South San Francisco, CA 94080 / US

QIAN, Xiangping

280 East Grand Avenue, South San Francisco, CA 94080/ US

LU, Pu-Ping

280 East Grand Avenue, South San Francisco, CA 94080/ US

(74) AOD "LUTOVAC & PARTNERI"

Bulevar Ivana Crnojevića 93 , Podgorica , 81000 / ME

(57)

1. Jedinjenje formule I:

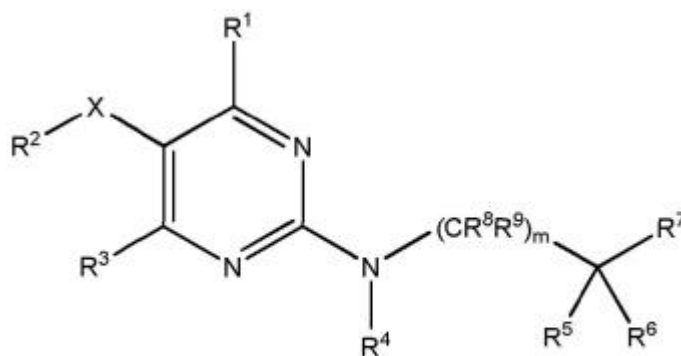

Formula I

ili njegova farmaceutski prihvatljiva so, gde :

R1 je izabran od vodonika, halogena, CN, CF3 i metila;

R2 je izabran od C3-8 cikloalkila, C3-8 cikloalkenila, 3-8 članog heterocikloalkila, 3-8 članog hetero-cikloalkenila, C6-10 arila, 5-10 članog heteroarila i NRbRc, gde svaki od C3-8 cikloalkila, C3-8 cikloalkenila, 3-8 članog heterocikloalkila, 3-8 članog heterocikloalkenila, C6-10 arila i 5-10 člane heteroarilne grupe je opciono supstituisan sa 1, 2, 3, 4 ili 5 supstituenata izabranih od halogena, CN, okso, (CH2)nORa, (CH2)nOC(O)Ra, (CH2)nOC(O)ORa, (CH2)nOC(O)NRbRc, (CH2)nNRbRc, (CH2)nNRdC(O)Ra, (CH2)nNRdC(O)ORa, (CH2)nNRdC(O)NRbRc, (CH2)nNRdC(O)C(O)NRbRc, (CH2)nNRdC(S)Ra, (CH2)nNRdC(S)ORa, (CH2)nNRdC(S)NRbRc, (CH2)nNRdC(NRe)NRbRc, (CH2)nNRdS(O)Ra, (CH2)nNRdSO2Ra, (CH2)nNRdSO2NRbRc, (CH2)nC(O)Ra, (CH2)nC(O)ORa, (CH2)nC(O)NRbRc, (CH2)nC(S)Ra, (CH2)nC(S)ORa, (CH2)nC(S)NRbRc, (CH2)nC(NRe)NRbRc, (CH2)nSRa, (CH2)nS(O)Ra, (CH2)nSO2Ra, (CH2)nSO2NRbRc, C1-6 alkila, C1-6 haloalkila, C2-6 alkenila, C2-6 alkinila, (CH2)nC3-8 cikloalkila, (CH2)n3-8 članog heterocikloalkila, (CH2)nC6-10 arila i (CH2)n5-10 članog heteroarila, gde je svaki C1-6 alkil, C2-6 alkenil, C2-6 alkinil, (CH2)nC3-8 cikloalkil, (CH2)n3-8 člani heterocikloalkil, (CH2)nC6-10 aril i (CH2)n5-10 člane heteroarilne grupe opciono supstituisan sa 1, 2, 3, 4 ili 5 Rf supstituenata;

R3 je izabran od vodonika, halogena, CN, CF3 i metila;

R4 je izabran od vodonika, C1-6 alkila, C1-6 haloalkila, C(O)Ra, C(O)ORa, C(O)NRbRc i SO2Ra;

R5 i R6 zajedno sa ugljenikovim atomom za koji su vezani obrazuju grupu izabranu između C3-8 cikloalkila, C3-8 cikloalkenila, 3-8 članog heterocikloalkila i 3-8 članog heterocikloalkenila, svaku opciono supstituisanu sa 1, 2, 3, 4 ili 5 supstituenata izabranih od halogena, CN, okso, ORa, OC(O)Ra, OC(O)ORa, NRbRc, C(O)Ra, C(O)ORa, C(O)NRbRc, S(O)Ra, SO2Ra, SO2NRbRc, C1-6 alkila i C1-6 haloalkila;

R7 je izabran od C3-8 cikloalkila, C3-8 cikloalkenila, 3-8 članog heterocikloalkila, 3-8 članog hetero-cikloalkenila, C6-10 arila i 5-10 članog heteroarila, svakog opciono supstituisanog sa 1, 2, 3, 4 ili 5 supstituenata izabranih od halogena, CN, okso, ORa, OC(O)Ra, OC(O)ORa, OC(O)NRbRc, NRbRc, NRdC(O)Ra, NRdC(O)ORa, NRdC(O)NRbRc, NRdC(O)C(O)NRbRc, NRdC(S)Ra, NRdC(S)ORa, NRdC(S)NRbRc, NRdC(NRe)NRbRc, NRdS(O)Ra, NRdSO2Ra, NRdSO2NRbRc, C(O)Ra, C(O)ORa, C(O)NRbRc, C(S)Ra, C(S)ORa, C(S)NRbRc, C(NRe)NRbRc, SRa, S(O)Ra, SO2Ra, SO2NRbRc, C1-6 alkila, C1-6 haloalkila, C2-6 alkenila, C2-6 alkinila, C3-8 cikloalkila, C3-8 cikloalkenila, 3-8 članog heterocikloalkila, 3-8 članog heterocikloalkenila, C6-10 arila, C7-11 aralkil, i 5-10 članog heteroarila, gde je svaki C1-6 alkil, C2-6 alkenil, C2-6 alkinil, C3-8 cikloalkil, C3-8 cikloalkenil, 3-8 člani heterocikloalkil, 3-8 člani heterocikloalkenil, C6-10 aril, C7-11 aralkil i 5-10 člane heteroarilne grupe opciono supstituisan sa 1, 2, 3, 4 ili 5 Rf supstituenata;

R8 i R9, u svakom javljanju, je svaki nezavisno izabran između vodonika, halogena i C1-6 alkila;

X je veza;

ili alternativno, X, R2 i R3, zajedno sa ugljenikovima tomima za koji su vezani, obrazuju 5-6 člani prsten koji opciono sadrži jedan ili više heteroatoma izabranih između kiseonika azota i sumpora, i opciono sadrži jednu ili više dvostrukih veza, i opciono supstituisan sa 1, 2, 3, 4 ili 5 Rf supstituenata;

Ra, u svakom javljanju, je nezavisno izabran između vodonika, C1-6 alkila, C1-6 haloalkila, C2-6 alkenila, C2-6 alkinila, C3-8 cikloalkila, C3-8 cikloalkenila, 3-8 članog heterocikloalkila, 3-8 članog heterocikloalkenila, C6-10 arila, C7-11 aralkila i 5-10 članog heteroarila, gde je svaki C1-6 alkil, C2-6 alkenil, C2-6 alkinil, C3-8 cikloalkil, C3-8 cikloalkenil, 3-8 člani heterocikloalkil, 3-8 člani heterocikloalkenil, C6-10 aril, C7-11 aralkil i 5-10 člane heteroarilne grupe opciono supstituisan sa 1, 2, 3, 4 ili 5 Rf supstituenata;

Rb i Rc, u svakom javljanju, je svaki nezavisno izabran između vodonika, C1-6 alkila, C1-6 haloalkila, C2-6 alkenila, C2-6 alkinila, C3-8 cikloalkila, C3-8 cikloalkenila, 3-8 članog heterocikloalkila, 3-8 članog hete-rocikloalkenila, C6-10 arila, C7-11 aralkila, 5-10 članog heteroarila, C(O)Rg, C(O)ORg, C(O)NRiRj i SO2Rg, gde je svaki C1-6 alkil, C2-6 alkenil, C2-6 alkinil, C3-8 cikloalkil, C3-8 cikloalkenil, 3-8 člani heterocikloalkil, 3-8 člani heterocikloalkenil, C6-10 aril, C7-11 aralkil i 5-10 člana heteroarilna grupa opciono supstituisan sa 1, 2, 3, 4 ili 5 Rf supstituenata;

Rd, u svakom javljanju, je nezavisno izabran između vodonika i C1-6 alkila;

Re, u svakom javljanju, je nezavisno izabran između vodonika, CN, OH, C1-6 alkoksi, C1-6 alkil i C1-6 haloalkila;

Rf, u svakom javljanju, je nezavisno izabran između halogena, CN, ORh, OC(O)Rh, OC(O)ORh, OC(O)NRiRj, NRiRj, NRdC(O)Rh, NRdC(O)ORh, NRdC(O)NRiRj, NRdC(O)C(O)NRiRj, NRdC(S)Rh, NRdC(S)ORh, NRdC(S)NRiRj, NRdC(NRe)NRiRj, NRdS(O)Rh, NRdSO2Rh, NRdSO2NRiRj, C(O)Rh, C(O)ORh, C(O)NRiRj, C(S)Rh, C(S)ORh, C(S)NRiRj, C(NRe)NRiRj, SRh, S(O)Rh, SO2Rh, SO2NRiRj, C1-6 alkila, C1-6 haloalkila, C2-6 alkenila, C2-6 alkinila, C3-8 cikloalkila, C3-8 cikloalkenila, 3-8 članog heterocikloalkila, 3-8 članog heterocikloalkenila, C6-10 arila, C7-11 aralkila i 5-10 članog heteroarila, gde je svaki C1-6 alkil, C2-6 alkenil, C2-6 alkinil, C3-8 cikloalkil, C3-8 cikloalkenil, 3-8 člani heterocikloalkil, 3-8 člani heterocikloalkenil, C6-10 aril, C7-11 aralkil i 5-10 člane heteroarilne grupe opciono supstituisan sa 1, 2, 3, 4 ili 5 Rk supstituenata;

ili dva Rf supstituenata vezana za jedan ugljenikov atom, zajedno sa ugljenikovim atomom za koji su oba vezana obrazuju grupu izabranu između karbonila, C3-8 cikloalkila i 3-8 članog heterocikloalkila;

Rg, u svakom javljanju, je nezavisno izabran između C1-6 alkila, C1-6 haloalkila, fenila, naftila, i C7-11 aralkila, svakog opciono supstituisanog sa 1, 2, 3, 4 ili 5 supstituenata izabranih od halogena, CN, OH, C1-6 alkoksi, C1-6 alkila i C1-6 haloalkila;

Rh, u svakom javljanju, je nezavisno izabran između vodonika, C1-6 alkila, C1-6 haloalkila, C2-6 alkenila, C2-6 alkinila, C3-8 cikloalkila, C3-8 cikloalkenila, 3-8 članog heterocikloalkila, 3-8 članog heterocikloalkenila, C6-10 arila, C7-11 aralkil i 5-10 članog heteroarila, gde je svaki C1-6 alkil, C2-6 alkenil, C2-6 alkinil, C3-8 cikloalkil, C3-8 cikloalkenil, 3-8 člani heterocikloalkil, 3-8 člani heterocikloalkenil, C6-10 aril, C7-11 aralkil i 5-10 člane heteroarilne grupe opciono supstituisan sa 1, 2, 3, 4 ili 5 Rk supstituenata;

Ri i Rj, u svakom javljanju, je svaki nezavisno izabran između vodonika, C1-6 alkila, C1-6 haloalkila, C2-6 alkenila, C2-6 alkinila, C3-8 cikloalkila, C3-8 cikloalkenila, 3-8 članog heterocikloalkila, 3-8 članog hete-rocikloalkenila, C6-10 arila, C7-11 aralkila, 5-10 članog heteroarila, C(O)Rg, i C(O)ORg, gde je svaki C1-6 alkil, C1-6 haloalkil, C2-6 alkenil, C2-6 alkinil, C3-8 cikloalkila, C3-8 cikloalkenila, 3-8 članog heterocikloalkil, 3-8 člani heterocikloalkenil, C6-10 aril, C7-11 aralkil i 5-10 člane heteroarilne grupe opciono supstituisan sa 1, 2, 3, 4 ili 5 supstituenata izabranih od halogena, CN, OH, C1-6 alkoksi, C1-6 alkila i C1-6 haloalkila;

Rk, u svakom javljanju, je nezavisno izabran između halogena, CN, OH, C1-6 alkoksi, NH2, NH(C1-6 alkil), N(C1-6 alkil)2, NHC(O)C1-6 alkila, NHC(O)C7-11 aralkila, NHC(O)OC1-6 alkila, NHC(O)OC7-11 aralkila, OC(O)C1-6 alkila, OC(O)C7-11 aralkila, OC(O)OC1-6 alkila, OC(O)OC7-11 aralkila, C(O)C1-6 alkila, C(O)C7-11 aralkila, C(O)OC1-6 alkila, C(O)OC7-11 aralkila, C1-6 alkila, C1-6 haloalkila, C2-6 alkenila, i C2-6 alkinila, gde svaki C1-6 alkil, C2-6 alkenil, C2-6 alkinil, i C7-11 aralkil supstituent je opciono supstituisan sa 1, 2 ili 3 supstituenata izabranih od OH, C1-6 alkoksi, NH2, NH(C1-6 alkil), N(C1-6 alkil)2, NHC(O)C1-6 alkil, NHC(O)C7-11 aralkil, NHC(O)OC1-6 alkil, i NHC(O)OC7-11 aralkil; ili dva Rk supstituenata vezana za jedan ugljenikov atom, zajedno sa ugljenikovim atomom za koji su oba vezana obrazuje karbonilnu grupu;

m je 0,1 ili 2;

n, u svakom javljanju, nezavisno je 0, 1 ili 2;

p je 0, 1 ili 2; i



q je 0, 1 ili 2.

**Patent sadrži još 25 patentnih zahtjeva.**

(11) **03767** (13) **B**

(51) **A01G 17/02**<sup>(2006.01)</sup>

(21) P-2020-69

(22) 23.06.2014

(30) 2013TO00556 03.07.2013 IT

(96) 14173406.1/23.06.2014

(97) EP 2820940/07.01.2015/2015/02

EP 2820940/22.01.2020/2020/04

(54) me **PNEUMATSKI ODSTRANJIVAČ LISTOVA**  
en **PNEUMATIC LEAF REMOVER**

(73) OLMi srl

Via Serramassone 9/A, Castiglione d'Asti (AT) , 14055/ IT

(72) Olmi, Franco

Via Serramassone 9/A , Castiglione d'Asti (AT) / IT, 14055/ IT

(74) MSA IP-MILOJEVIĆ, SEKULIĆ ADVOKATI

Karađorđeva 65, Beograd , 11000/ RS

(57)

1. Glava pneumatskog odstranjivača listova koja sadrži:

- pneumatsko kolo (3) koje sadrži najmanje jedan kanal (31) i najmanje jednu mlaznicu (33); navedeno pneumatsko kolo (3) je prilagođeno da vodi tok (f) vazduha, kroz navedeni najmanje jedan kanal (31), ka navedenoj najmanje jednoj mlaznici (33), tako da prouzrokuje isticanje mlaza (g) vazduha;
- rotor (5), za rotiranje oko ose (Y) rotacije i na koji je pneumatsko kolo (3) integralno pričvršćeno, tako da se navedeno pneumatsko kolo (3) integralno rotira sa navedenim rotorom (5);
- najmanje jednu zaštitnu ploču (7) koja sadrži najmanje jedan deflektor, koji je postavljen ispred navedene najmanje jedne mlaznice (33) u odnosu na pravac ose (Y) rotacije, tako da mlaz (g) vazduha koji ističe iz navedene najmanje jedne mlaznice (33) može barem delimično teći kroz navedeni najmanje jedan deflektor;

navedena zaštitna ploča (7) je integralno pričvršćena na navedeni rotor (5), tako da rotira sa njim;

navedeni najmanje jedan deflektor je najmanje jedna rupa (73), od kojih je svaka postavljena blizu navedene najmanje jedne mlaznice (33); gde navedena zaštitna ploča (7) sadrži:

- centralni deo (71), u odnosu na osu (Y) rotacije, koji je integralno pričvršćen na rotor (5), i
- obodni deo (72), u odnosu na osu (Y) rotacije, koji je pričvršćen na navedeni centralni deo (71) za rotiranje oko ose (Y) nezavisno, tako menjajući svoj položaj u odnosu na navedeni centralni deo (71);

pri čemu je navedena najmanje jedna rupa (73) obezbeđena u skladu sa navedenim obodnim delom (72).

**Patent sadrži još 9 patentnih zahtjeva.**

(11) **03768** (13) **B**

(51) **A01N 43/56**<sup>(2006.01)</sup>

**A61K 31/22**<sup>(2006.01)</sup>

**A61K 47/14**<sup>(2006.01)</sup>

**A61P 33/00**<sup>(2006.01)</sup>

**A01N 53/00**<sup>(2006.01)</sup>

**A61K 31/415**<sup>(2006.01)</sup>

**A61K 47/20**<sup>(2006.01)</sup>

(21) P-2020-70

(22) 22.02.2013

(30) 201261602472P 23.02.2012 US

(96) 13707523.0/22.02.2013

(86) US PCT/US2013/027312/22.02.2013

(87) WO 2013/126694/29.08.2013/2013/35

(97) EP 2816898/31.12.2014/2015/01

EP 2816898/22.01.2020/2020/04

(54) me **TROPIKALNE KOMPOZICIJE KOJE SADRŽE FIPRONIL I PERMETRIN I POSTUPCI ZA NJIHOVU UPOTREBU**

en **TOPICAL COMPOSITIONS COMPRISING FIPRONIL AND PERMETHRIN AND METHODS OF USE**

(73) Boehringer Ingelheim Animal Health USA Inc.

3239 Satellite Boulevard, Bldg. 500, Duluth, GA 30096/ US

(72) SOLL, Mark, David

605 Newport Shore, Alpharetta, GA 30005 / US

PATE, James

582 County Road 579, Hampton, NJ 08827/ US

BAKER, Lisa, A.

224 Buckingham Way, Somerset, NJ 08873/ US

(74) Advokat POPOVIĆ, Miladin

Đoka Miraševića 21/III, Podgorica, 81000 / ME

(57)

1. Topikalna kompozicija za lečenje i prevenciju ekto parazitske infestacije koja sadrži:

od 2% (tež./tež.) do 15% (tež./tež.) fipronila;

od 30% (tež./tež.) do 55% (tež./tež.) permetrina; i

neutralno ulje (ulja) i N-metil pirolidon, naznačena time, što su navedeno neutralno ulje (ulja) i N-metil pirolidon prisutni u težinsko-težinskom odnosu od 1:2.0 do 1:3.5, neutralnog (neutralnih) ulja prema N-metil pirolidonu; i

pri čemu je navedeno neutralno ulje (ulja) triglicerid frakcionisanih biljnih masnih kiselina sa dužinama lanaca od C8 do C10.

**Patent sadrži još 23 patentnih zahtjeva.**

(11) **03769** (13) **B**

(51) **A61K 31/216**<sup>(2006.01)</sup>

**A61K 47/32**<sup>(2006.01)</sup>

**A61K 47/36**<sup>(2006.01)</sup>

**A61P 1/12**<sup>(2006.01)</sup>

**A61K 9/10**<sup>(2006.01)</sup>

**A61K 47/34**<sup>(2017.01)</sup>

**A61K 47/38**<sup>(2006.01)</sup>

(21) P-2020-71

(22) 09.12.2011

(30) 20100306397 10.12.2010 EP

(96) 11797216.6/09.12.2011

(86) EP PCT/EP2011/072315/09.12.2011

(87) WO 2012/076691/14.06.2012/2012/24

(97) EP 2648696/16.10.2013/2013/42

EP 2648696/19.02.2020/2020/08

(54) me **NOVI OBLIK DAVANJA RACEKADOTRILA**  
en **NEW FORM OF ADMINISTRATION OF RACECADOTRIL**

(73) Bioprojet

30 rue des Francs Bourgeois, 75003 Paris / FR

(72) JULIEN, Jean-Stéphane

24 rue de Preney, Saint Cyr Sur Loire , 37540 / FR

MAURY, Marc

21 rue Louis Jouvét, Saint Medard En Jalles , 33160 / FR

LECOMTE, Jeanne-Marie

30 rue des Francs-Bourgeois, Paris , 75003/ FR

LIGNEAU, Xavier

4 Square du Vivier Louis, Saint Gregoire , 35760 / FR

ROBERT, Philippe

9 chemin de la Reine Iseult, Pace , 35740/ FR

SCHWARTZ, Jean-Charles

9 villa Seurat, Paris, 75014/ FR

(74) Advokat RADULOVIĆ, Božidar S.

Baku 30/5, Podgorica, 81000 / ME

(57)

1. Vodena suspenzija inhibitora enkefalinaze pogodna za oralno davanje, pri čemu pomenuta suspenzija ima pH između 3.5 i 5, pri čemu pomenuti inhibitor enkefalinaze predstavlja racekadotril .

**Patent sadrži još 14 patentnih zahtjeva.**

(11) **03770** (13) **B**

(51) **C07D 487/04**<sup>(2006.01)</sup>  
**A61P 35/00**<sup>(2006.01)</sup>

**A61K 31/4985**<sup>(2006.01)</sup>  
**C07D 403/04**<sup>(2006.01)</sup>

(21) P-2020-72

(22) 08.11.2016

(30) 201562252726P 09.11.2015 US  
201662401351P 29.09.2016 US

(96) 16791420.9/08.11.2016

(86) EP PCT/EP2016/076932/08.11.2016

(87) WO 2017/080979/18.05.2017/2017/20

(97) EP 3374359/19.09.2018/2018/38  
EP 3374359/08.01.2020/2020/02

(54) me **DERIVATI DIHIDROIMIDAZOPIRAZINONA KORISNI ZA UPOTREBU U TRETMANU RAKA**  
en **DIHYDROIMIDAZOPYRAZINONE DERIVATIVES USEFUL IN THE TREATMENT OF CANCER**

(73) AstraZeneca AB

, Södertälje, 151 85 / SE

(72) WARD, Richard, Andrew

Cambridge Science Park Milton Road , Cambridge CB4 0WG / GB

JONES, Clifford, David

Alderley Park, Macclesfield Cheshire SK10 4TG / GB

SWALLOW, Steven

Charter Way, Macclesfield Cheshire SK10 2NA / GB

GRAHAM, Mark, Andrew

Charter Way, Macclesfield Cheshire SK10 2NA / GB

DOBSON, Andrew, Hornby

Charter Way, Macclesfield Cheshire SK10 2NA/ GB

MCCABE, James, Francis

Charter Way, Macclesfield Cheshire SK10 2NA/ GB

(74) Advokat RADULOVIĆ, Božidar S.

Baku 30/5, Podgorica, 81000 / ME

(57)

1. Jedinjenje, **naznačeno time**, što ima Formulu (I) ilineki njegov farmaceutski-prihvatljivi adukt

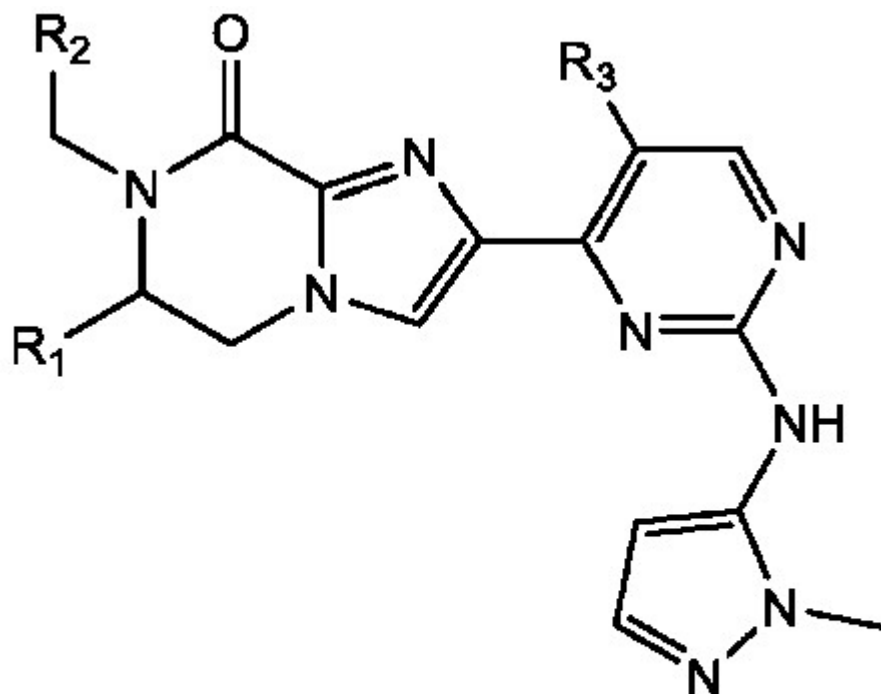

(I)

u kojoj:

R<sup>1</sup> je vodonik, C<sub>1-3</sub>alkil ili -CH<sub>2</sub>OMe;

R<sup>2</sup> je piridinil, opciono supstituisan na 1 (jednom) atomu ugljenika iz prstena sa nekim supstituentom koji je nezavisno izabran iz grupe koja se sastoji od C<sub>1-3</sub>alkila, difluorometila i trifluorometila; ili

R<sup>2</sup> je pirimidinil, opciono supstituisan na 1 (jednom) atomu ugljenika iz prstena sa nekim supstituentom koji je nezavisno izabran iz grupe koja se sastoji od C<sub>1-3</sub>alkila, difluorometila i trifluorometila; ili

R<sup>2</sup> je fenil opciono supstituisan na 1 (jednom) ili 2 (dva) atoma ugljenika iz prstena sa nekim supstituentom koji je nezavisno izabran iz grupe koja se sastoji od halo, difluorometila, trifluorometila, metoksi i -OCHF<sub>2</sub>;

R<sup>3</sup> je vodonik, C<sub>1-3</sub>alkil ili hlora.

**Patent sadrži još 18 patentnih zahtjeva.**

(11) **03771** (13) **B**

(51) **A61K 31/7048**<sup>(2006.01)</sup>

**A61K 9/00**<sup>(2006.01)</sup>

**A61K 9/10**<sup>(2006.01)</sup>

**A61P 9/00**<sup>(2006.01)</sup>

**A61K 47/36**<sup>(2006.01)</sup>

(21) P-2020-73

(22) 20.12.2013

(30) 20120003579 21.12.2012 FR

(96) 13198744.8/20.12.2013

(97) EP 2745839/25.06.2014/2014/26

EP 2745839/11.03.2020/2020/11

(54) me **FARMACEUTSKI PRIPRAVAK U OBLIKU ORALNE SUSPENZIJE KOJA UKLJUČUJE FLAVONOIDNU FRAKCIJU KSANTANSKU GUMU**  
en **PHARMACEUTICAL COMPOSITION IN THE FORM OF AN ORAL SUSPENSION INCLUDING A FLAVONOID FRACTION AND XANTHAN GUM**

(73) Les Laboratoires Servier

35, rue de Verdun, Suresnes Cedex, 92284/ FR

(72) Marsas, Stéphanie

6, allée des Chartreux, Checy , 45430 / FR

Pean, Jean-Manuel

12, rue Adolphe Crespin, Checy, 45000/ FR

(74) Advokat JUSIĆ, Jasna

Dalmatinska 2, Podgorica, 81000 / ME

(57)

1. Farmaceutski pripravak u obliku pitke oralne suspenzije u vrećici,  **naznačen time**, da kao aktivnu tvar sadrži mikroniziranu pročišćenu flavonoidnu frakciju koja sadrži od 87% do 93% diosmina, od 2,5% do 5,0% hesperidina, od 0,9% do 2,8% izorhoifolina, od 0,9 % do 2,8% linarina i manje od 1% diosmetina, čija je veličina čestica strogo manja od 5 µm, i ksantansku gumu kao pomoćnu tvar.

**Patent sadrži još 5 patentnih zahtjeva.**

(11) **03772** (13) **B**

(51) **C07K 16/28**<sup>(2006.01)</sup>

**A61P 35/00**<sup>(2006.01)</sup>

(21) P-2020-74

(22) 08.07.2016

(30) 2015EP65900 10.07.2015 WO  
201662278283P 13.01.2016 US

(96) 16739079.8/08.07.2016

(86) EP PCT/EP2016/066353/08.07.2016

(87) WO 2017/009258/19.01.2017/2017/03

(97) EP 3319993/16.05.2018/2018/20

EP 3319993/15.01.2020/2020/03

(54) me **KONJUGATI ANTITIJELA SPECIFIČNOG ZA AXL I LIJEKA ZA LIJEČENJE KANCERA**  
en **AXL-SPECIFIC ANTIBODY-DRUG CONJUGATES FOR CANCER TREATMENT**

(73) Genmab A/S

Kalvebod Brygge 43, Copenhagen V, 1560/ DK

(72) BOSHUIZEN, Julia

Legmeerstraat 83-2, NC Amsterdam , 1058/ NL

JACOBSSEN, Kirstine

Jagtvej 40 2, Odense, 5000 / DK

BREIJ, Esther

Uppsalalaan 15, 3584 CT Utrecht/ NL

KOOPMAN, Louise

Uppsalalaan 15, 3584 CT Utrecht / NL

SATIJN, David

Uppsalalaan 15, 3584 CT Utrecht / NL

VAN DEN BRINK, Edward

Uppsalalaan 15, 3584 CT Utrecht / NL

VERZIJL, Dennis

Uppsalalaan 15, 3584 CT Utrecht/ NL

DE JONG, Rob

Uppsalalaan 15, 3584 CT Utrecht / NL

VAN DIJKHUIZEN RADERSMA, Riemke

Uppsalalaan 15, 3584 CT Utrecht/ NL

PEEPER, Daniel

Anton de Langelaan 2, 1183-DN Amstelveen / NL

DITZEL, Henrik Jørn

Søgade 4, Skanderborg , 8660 / DK

PARREN, Paul

Werdorperwaard 17, PR Odijk, 3984/ NL

(74) AOD "LUTOVAC & PARTNERI"

Bulevar Ivana Crnojevića 93 , Podgorica , 81000 / ME

(57)

1. Konjugat antitela i leka (ADC) koji sadrži antitelo koje se vezuje za humani AXL za upotrebu u lečenju kancera rezistentnog na najmanje jedan terapijski agens izabran iz grupe koja se sastoji od inhibitora tirozin kinaze, inhibitora serin/treonin kinaze i hemoterapijskog agensa, pri čemu ADC sadrži najmanje jedan region za vezivanje koji sadrži VH region koji obuhvata CDR1, CDR2 i CDR3 sekvence iz SEQ ID NOs.: 36, 37 i 38, tim redom; i VL region koji obuhvata CDR1, CDR2 i CDR3 sekvence iz SEQ ID NOs.: 39, GAS i 40, tim redom.

**Patent sadrži još 36 patentnih zahtjeva.**

(11) **03773** (13) **B**



(51) **A61K 39/00**<sup>(2006.01)</sup>

**C07K 16/28**<sup>(2006.01)</sup>

(21) P-2020-75

(22) 10.12.2013

(30) 201261735362P 10.12.2012 US

201361763270P 11.02.2013 US

(96) 13814340.9/10.12.2013

(86) US PCT/US2013/074208/10.12.2013

(87) WO 2014/093396/19.06.2014/2014/25

(97) EP 2928923/14.10.2015/2015/42

EP 2928923/22.01.2020/2020/04

(54) me **ANTITIJELA ANTI-ANTIGEN 2 DENDRITSKE ĆELIJE KRV I NJIHOVE UPOTREBE**  
en **ANTI-BLOOD DENDRITIC CELL ANTIGEN 2 ANTIBODIES AND USES THEREOF**

(73) Biogen MA Inc.

225 Binney Street, Cambridge, MA 02142/ US

(72) CARAVELLA, Justin A.

121 Sciarappa Street 3, Cambridge, Massachusetts 02141 / US

GARBER, Ellen A.

14 Donnell Street, Cambridge, Massachusetts 02138/ US

RABAH, Dania Mounir

59 Magazine Street, Unit 35, Cambridge, Massachusetts 02139 / US

TAYLOR, Frederick R.

98 Gulliver Street, Milton, Massachusetts 02186/ US

(74) Advokat POPOVIĆ, Miladin

Đoka Miraševića 21/III , Podgorica , 81000 / ME

(57)

1. Izolovano antitelo koje vezuje humani antigen 2 dendritske ćelije krvi (BDCA2) (SEQ ID NO: 1),

naznačeno time što antitelo sadrži varijabilni teški (VH) domen koji je identičan amino-kiselinskoj sekvenci SEQ ID NO: 24; i pri čemu antitelo sadrži varijabilni laki (VL) domen koji je identičan amino-kiselinskoj sekvenci SEQ ID NO: 23.

**Patent sadrži još 10 patentnih zahtjeva.**

(11) **03774** (13) **B**

(51) **A61K 9/20**<sup>(2006.01)</sup>

**A61K 31/138**<sup>(2006.01)</sup>

**A61K 31/4422**<sup>(2006.01)</sup>

(21) P-2020-76

(22) 30.09.2009

(30) 20080000591 30.09.2008 HU

(96) 11003486.5/30.09.2009

(97) EP 2359815/24.08.2011/2011/34

EP 2359815/08.01.2020/2020/02

(54) me **JEDINJENJA KOJA SADRŽE AMLODIPIN I BISOPROLOL**  
en **COMPOSITIONS COMPRISING AMLODIPINE AND BISOPROLOL**

(73) Egis Gyógyszergyár Zrt.

Keresztúri út 30-38, Budapest, 1106/ HU

(72) WAGNER, László

XI. utca 36, Budapest, 1172 / HU

ZSIGMOND, Zsolt

Mátyás király u. 67, Maglód, 2234 / HU

UJFALUSSY, György

Dózsa György u. 13, Budapest, 1028/ HU

LEVENTISZNÉ HUSZÁR, Magdolna

Virányos út 24/a, Budapest, 1125/ HU

TONKA-NAGY, Péter

Ököl u. 4/b 9, Budapest, 1171/ HU

BÁRCZAY, Erzsébet

Bökényföldi u. 23, Budapest, 1165/ HU

GÓRA, Lászlóné

Gyöngyvirág u. 3, Isaszeg, 2117 / HU

Szeleczi, Edit

Osztály u. 6-10/D 1.2, Budapest, 1165/ HU

Fülöp, Ágnes

Szilágyi Dezső u. 87, Budapest, 1174/ HU

(74) Advokat JUSIĆ, Jasna

Dalmatinska 2, Podgorica, 81000 / ME

(57)

1. Upakovani dozni oblik koji obuhvata

i. stabilno čvrsto farmaceutsko jedinjenje koje sadrži bisoprolol fumarate, organski ili neorgansko punilo, dezintegrant, lubricant, anti-adheziv i opciono vezivno sredstvo, i koje dalje sadrži manje od 0.5% jedinjenja formule

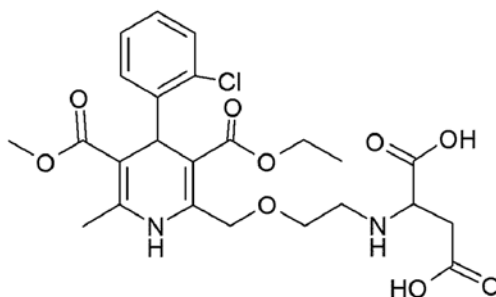

3

na osnovu težine aktivnih sastojaka,

- ii. pri čemu je homognizovano jedinjenje u obliku tablete ili kapsule,
- iii. tablete ili kapsule su upakovane u pakovanje otporno na vodu,
- iv. pri čemu je pakovanje otporno na vodu izabrano iz grupe koja sadrži hladno oblikovan blister oblikovan iz

kompozitne folije prekrivene aluminijumskom folijom, blister od termoformirane kompozitne folije otporne na vlagu i prekrivene aluminijumskom folijom, i čaše ili polipropilensku posudu opremljenu nepropusnom kapicom od polietilena ili polipropilena.

**Patent sadrži još 9 patentnih zahtjeva.**

(11) **03775** (13) **B**

(51) **A61K 31/497**<sup>(2006.01)</sup>

**A61K 31/5377**<sup>(2006.01)</sup>

**A61P 35/00**<sup>(2006.01)</sup>

**A61P 43/00**<sup>(2006.01)</sup>

**A61K 31/517**<sup>(2006.01)</sup>

**A61K 45/00**<sup>(2006.01)</sup>

**A61P 35/02**<sup>(2006.01)</sup>

(21) P-2020-77

(22) 03.02.2015

(30) 20140019226 04.02.2014 JP

(96) 15746276.3/03.02.2015

(86) JP PCT/JP2015/053018/03.02.2015

(87) WO 2015/119122/13.08.2015/2015/32

(97) EP 3103453/14.12.2016/2016/50

EP 3103453/01.04.2020/2020/14

(54) me **MEDICINSKA KOMPOZICIJA KOJA OBUHVATA DIAMINO HETEROCIKLIČNO JEDINJENJE  
KARBOKSAMIDA KAO AKTIVNI SASTOJAK**  
en **MEDICINAL COMPOSITION COMPRISING DIAMINO HETEROCYCLIC CARBOXAMIDE COMPOUND AS  
ACTIVE INGREDIENT**

(73) Astellas Pharma Inc.

5-1, Nihonbashi-Honcho 2-chome, Chuo-ku, Tokyo 103-8411/ JP

(72) EGUCHI, Tomohiro

5-1 Nihonbashi-Honcho 2-chome, Chuo-ku , Tokyo 103-8411 / JP

MORI, Masamichi

5-1 Nihonbashi-Honcho 2-chome, Chuo-ku , Tokyo 103-8411 / JP

YAMAKI, Yoko

5-1 Nihonbashi-Honcho 2-chome, Chuo-ku , Tokyo 103-8411 / JP

(74) Advokat RADULOVIĆ, Božidar S.

Baku 30/5, Podgorica, 81000 / ME

(57)

1. Farmaceutska kompozicija za upotrebu u postupku za lečenje kancera povezanog sa AXL, koja obuhvata 6-etil-3-{{3-metoksi-4-[4-(4-metilpiperazin-1-il)piperidin-1-il]fenil}amino)-5-(tetrahidro-2H-piran-4-ilamino)pirazin-2-karboksamid ili njegovu farmaceutski prihvatljivu so, i farmaceutski prihvatljiv ekscipijens, pri čemu kancer povezan sa AXL predstavlja kancer koji je stekao otpornost na terapiju antikancerskim agensom aktivacijom AXL.

**Patent sadrži još 7 patentnih zahtjeva.**

(11) **03776** (13) **B**

(51) **C07D 401/12**<sup>(2006.01)</sup>

**A61K 31/4704**<sup>(2006.01)</sup>

**C07D 215/227**<sup>(2006.01)</sup>

**C07D 405/12**<sup>(2006.01)</sup>

**A61P 35/00**<sup>(2006.01)</sup>

**A61K 31/4709**<sup>(2006.01)</sup>

**C07D 471/04**<sup>(2006.01)</sup>

**C07D 409/12**<sup>(2006.01)</sup>

(21) P-2020-78

(22) 18.09.2015

(30) 201462053006P 19.09.2014 US

201562128089P 04.03.2015 US

201562150812P 21.04.2015 US

(96) 18198969.0/18.09.2015

(97) EP 3447050/27.02.2019/2019/09

EP 3447050/19.02.2020/2020/08

(54) me **DERIVATI PIRIDIN-2(1H)-ON HINOLINONA KAO INHIBITORI MUTIRANE IZOCITRAT DEHIDROGENAZE**  
en **PYRIDIN-2(1H)-ONE QUINOLINONE DERIVATIVES AS MUTANT-ISOCITRATE DEHYDROGENASE**  
**INHIBITORS**

(73) Forma Therapeutics, Inc.

500 Arsenal St., Suite 100, Watertown, MA 02472/ US

(72) ASHWELL, Susan

8 Heald Road, Carlisle, Massachusetts 01741 / US

CAMPBELL, Ann-Marie

248 Webb Circle, Monroe, Connecticut 06468/ US

CARAVELLA, Justin Andrew

121 Sciarappa Street 3, Cambridge, Massachusetts 02141 / US

DIEBOLD, R. Bruce

2 Dolores Avenue, Apt. 11, Waltham, Massachusetts 02452/ US

ERICSSON, Anna

16 Venus Drive, Shrewsbury, Massachusetts 01545 / US

GUSTAFSON, Gary

33 Ridgecrest Drive, Ridgefield, Connecticut 06877 / US

LANCIA, David R. Jr.

45 West Broadway Unit 111, Boston, Massachusetts 02127 / US

LIN, Jian

3 Beechnut Street, Acton, Massachusetts 01720 / US

LU, Wei

40 Broadlawn Drive, Newton, Massachusetts 02467/ US

WANG, Zhongguo

19 Earl Street, Lexington, Massachusetts 02421 / US

(74) AOD "LUTOVAC & PARTNERI"

Bulevar Ivana Crnojevića 93 , Podgorica , 81000 / ME

(57)

1. Farmaceutska kompozicija koja sadrži jedinjenje formule I-13 ili njegovu farmaceutski prihvatljivu so i farmaceutski prihvatljiv nosač:

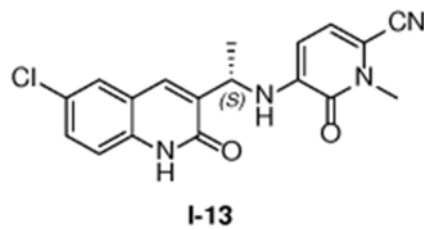

gde kompozicija sadrži od oko 0,1% do oko 99% jedinjenja formule I-13 u odnosu na masu ili zapreminu.

**Patent sadrži još 10 patentnih zahtjeva**

(11) **03777** (13) **B**

(51) **A61K 9/28**<sup>(2006.01)</sup>

**A61K 31/472**<sup>(2006.01)</sup>

**A61K 9/48**<sup>(2006.01)</sup>

**A61K 9/20**<sup>(2006.01)</sup>

(21) P-2020-79

(22) 05.06.2014

(30) 201361831909P 06.06.2013 US

(96) 14735770.1/05.06.2014

(86) US PCT/US2014/041021/05.06.2014

(87) WO 2014/197660/11.12.2014/2014/50

(97) EP 3003284/13.04.2016/2016/15

EP 3003284/12.02.2020/2020/07

(54) me **FARMACEUTSKE FORMULACIJE INHIBITORA HIF HIDROKSILAZE**  
en **PHARMACEUTICAL FORMULATIONS OF A HIF HYDROXYLASE INHIBITOR**

(73) Fibrogen, Inc.

409 Illinois Street, San Francisco, CA 94158/ US

(72) CONCA, David

409 Illinois Street , San Francisco, CA 94158 / US

FLIPPIN, Lee, Allen

409 Illinois Street , San Francisco, CA 94158 / US

LEIGH, Scott, David

409 Illinois Street, San Francisco, CA 94158/ US

WITSCHI, Claudia

409 Illinois Street , San Francisco, CA 94158/ US

WRIGHT, Lee, Robert

409 Illinois Street, San Francisco, CA 94158 / US

(74) AOD "LUTOVAC & PARTNERI"

Bulevar Ivana Crnojevića 93 , Podgorica , 81000 / ME

(57)

1. Tableta koja sadrži [(4-hidroksi-1-metil-7-fenoksi-izohinolin-3-karbonil)-amino]-sirćetnu kiselinu, farmaceutski prihvatljiv ekscipijent i efikasnu količinu sredstva za fotostabilizaciju, gde sredstvo za fotostabilizaciju sadrži titanijum dioksid i bar jednu dodatnu boju izabranu iz grupe koju čine plava boja, crvena boja, narandžasta boja, žuta boja, i njihove kombinacije, i gde

(i) sredstvo za fotostabilizaciju je pomešano u tableti; ili

(ii) tableta sadrži jezgro tablete i prevlaku, a sredstvo za fotostabilizaciju je pomešano u jezgru tablete; ili

(iii) tableta sadrži jezgro tablete i prevlaku, a jezgro tablete sadrži [(4-hidroksi-1-metil-7-fenoksi-izohinolin-3-karbonil)-amino]-sirćetnu kiselinu i farmaceutski prihvatljiv ekscipijent i prevlaka sadrži sredstvo za fotostabilizaciju.

**Patent sadrži još 14 patentnih zahtjeva**

(11) **03778** (13) **B**

(51) **A61K 9/00**<sup>(2006.01)</sup>

**A61K 47/26**<sup>(2006.01)</sup>

**A61K 45/06**<sup>(2006.01)</sup>

**A61K 31/167**<sup>(2006.01)</sup>

**A61K 31/573**<sup>(2006.01)</sup>

**A61K 47/12**<sup>(2006.01)</sup>

**A61K 9/16**<sup>(2006.01)</sup>

**A61K 9/14**<sup>(2006.01)</sup>

**A61K 31/40**<sup>(2006.01)</sup>

(21) P-2020-80

(22) 14.11.2016

(30) 20150194660 16.11.2015 EP

(96) 16801982.6/14.11.2016

(86) EP PCT/EP2016/077558/14.11.2016

(87) WO 2017/085004/26.05.2017/2017/21

(97) EP 3377108/26.09.2018/2018/39

EP 3377108/19.02.2020/2020/08

(54) me **POSTUPAK ZA PRIPREMU FORMULACIJE SUVOG PRAHA OBUHVATAJUĆI ANTIHOLINERGIK, KORTIKOSTEROID I BETA -ADRENERGIK**  
en **A PROCESS FOR PREPARING A DRY POWDER FORMULATION COMPRISING AN ANTICHOLINERGIC, A CORTICOSTEROID AND A BETA-ADRENERGIC**

(73) Chiesi Farmaceutici S.p.A.

Via Palermo 26/A, Parma, 43100 / IT

(72) CAFIERO, Claudio

Via Palermo 26/A , 43122 Parma / IT

ORTENZI, Leonardo

Via Palermo 26/A , 43122 Parma/ IT

SCHIARETTI, Francesca

Via Palermo 26/A , 43122 Parma / IT

(74) Advokat RADULOVIĆ, Božidar S.

Baku 30/5, Podgorica, 81000 / ME

(57)

1. Postupak za pripremu formulacije praha za inhalaciju za upotrebu u inhalatoru suvim prahom i pomenuti prah obuhvata:

(A) nosač koji obuhvata:

(a) 80 do 95 procenata težine, na osnovu ukupne težine pomenutog nosača, grubih čestica fiziološki prihvatljivog ekscipijenta imajući srednju veličinu čestica od najmanje 175  $\mu\text{m}$ ; i

(b) 19.6 do 4.9 procenata težine, na osnovu ukupne težine pomenutog nosača, mikronizovanih čestica fiziološki prihvatljivog ekscipijenta, i 0.1 do 0.4 procenta težine, na osnovu ukupne težine pomenutog nosača, soli masne kiseline; i

(B) mikronizovane čestice anti-muskarinskih lekova, produženog dejstva  $\beta$ 2-agonista (LABA), i opciono, inhalacioni kortikosteroid (ICS), kao aktivnih sastojaka, pomenutog postupka obuhvatajući:

(i) mešanje svih pomenutih grubih čestica fiziološki prihvatljivog ekscipijenta, svih pomenutih soli masne kiseline, prvu porciju pomenutih mikronizovanih čestica fiziološki prihvatljivog ekscipijenta, svih pomenutih mikronizovanih čestica pomenutog dugotrajnog  $\beta$ 2-agonista, pomenute anti-muskarinske lekove, i opciono, pomenute inhalacione kortikosteroide u posudi miksera za mešanje pri brzini rotacije ne nižoj d 16 rpm za vreme ne manje od 60 minuta, za dobijanje prve smeše; i

(ii) dodavanje preostalog dela pomenutih mikronizovanih čestica fiziološki prihvatljivog ekscipijenta pomenutoj prvoj smeši, za dobijanje druge smeše, i mešanje pomenute druge smeše pri brzini rotacije ne nižoj od 16 rpm za vreme od najmanje 120 minuta.



pri čemu

dugotrajni  $\beta$ 2-agonist je izabran iz grupe koja se sastoji od formoterola, salmeterola, indacaterola, olodarterola, i vilanterola;

anti-muskarinski lek je izabran iz grupe koja se sastoji od glikopironijum bromida ili hlorida, tiotropijum bromida, umecildinijum bromida, i acidinijum bromida;

inhalacioni kortikosteroid je izabran iz grupe koja se sastoji od beklometazon dipropionata i njegovih monohidratnih oblika, budesonida, flutikazon propionata, flutikazon furoata, i mometazon furoata.

**Patent sadrži još 16 patentnih zahtjeva.**

(11) **03779** (13) **B**

(51) **F01C 1/12**<sup>(2006.01)</sup>

**F04C 2/12**<sup>(2006.01)</sup>

**F04C 2/20**<sup>(2006.01)</sup>

(21) P-2020-81

(22) 23.09.2014

(96) 14777547.2/23.09.2014

(86) EP PCT/EP2014/070228/23.09.2014

(87) WO 2015/044131/02.04.2015/2015/13

(97) EP 3198119/02.08.2017/2017/31

EP 3198119/22.01.2020/2020/04

(54) me **ZUPČASTA PUMPA SA POZITIVNIM POMAKOM**  
en **POSTIVE DISPLACEMENT GEAR PUMP**

(73) G.P.S. GREEN POWER SOLUTION SA

Via Peri 17, Lugano, 6900 / CH

(72) TOMMASINI, Franco

via in Busciurina n. 10/B, Camorino (TI) , 6528 / IT

(74) Advokat ČUPIĆ, Branislav

Dalmatinska 10 , Podgorica , 81000/ ME

(57)

1. Pumpa sa pozitivnim pomakom (201) koja sadrži:

- kućište sa centralnim telom (2) i dva poklopca (20) za zatvaranje, gde navedeno centralno telo (2) poseduje dve povezane cilindrične komore (22, 23), jednu dovodnu cev (I) i jednu odvodnu cev (O), i
- dva rotora (3,4) koji su obrtno postavljeni u navedenim komorama (22, 23) centralnog tela i nošeni od strane odgovarajućih osovinama koje su obrtno postavljene u navedenim poklopcima (20) za zatvaranje,

pri čemu dva navedena rotora (3, 4) čine:

- muški rotor (3) koji sadrži najmanje jednu izbočinu (30), a ne sadrži šupljine i
- ženski rotor (4) koji sadrži najmanje jednu šupljinu (40), a ne sadrži izbočine ili zube,

gde je muški rotor (3) uzubljen sa ženskim rotorom (4), odnosno gde je najmanje jedna izbočina (30) muškog rotora spregnuta u najmanje jednoj šupljini (40) ženskog rotora bez kontakta između dva rotora, i muški rotor sadrži telo (35) sa najmanje jednim ležištem (36) i navedena najmanje jedna izbočina (30) poseduje sektor koji sadrži osnovu (34) koja je spregnuta u ležištu (36) tela (35) rotora.

gde navedeni muški rotor (3) sadrži cilindrično telo (35) i najmanje jednu izbočinu (30) koja se pruža radijalno od cilindričnog tela, dok navedeni ženski rotor (4) sadrži cilindrično telo (45) i najmanje jednu šupljinu (40) koja se pruža radijalno unutar cilindričnog tela, pri čemu

- svaka izbočina (30) muškog rotora u poprečnom preseku sadrži dve zakrivljene strane (31, 32) koje se susstiču u zaobljenoj ili ravnoj glavi (33), pri čemu su te dve strane (31, 32) izbočine simetrične u odnosu na radijalnu osu simetrije koja prolazi kroz glavu (33) izbočine, i
- svaka šupljina (40) u poprečnom preseku sadrži dve zakrivljene strane (41, 42) koje čine dovodnu stranu(41) i odvodnu stranu (42) koje imaju zakrivljene profile spojene u donjoj površini (43) konkavnog oblika,

gde su zakrivljena strana izbočine i šupljine izvedene u obliku zakrivljene krive; gde zakrivljenje ili prevoj predstavlja tačku na krivoj u kojoj zakrivljenje ili konkavnost menja znak iz plusa u minus ili iz minusa u plus; pri čemu kriva menja oblik iz konkavnog u konveksan ili obrnuto;

***naznačena time***, što profili dve strane (41, 42) šupljine nisu simetrični u odnosu na radialnu pravu liniju koja prolazi kroz dno šupljine, već je zakrivljeni profil dovodne strane (41) više savijen od zakrivljenog profila odvodne strane (42) šupljine; gde su ženski rotor (4) i muški rotor (3) postavljeni jedan pored drugog, dovodni i odvodni kanali (I, O) su postavljeni sa jedne strane i sa druge strane u odnosu na rotore (3, 4), pri čemu su ose dovodnih i odvodnih kanala (I, O) uzajamno ortogonalne.

**Patent sadrži još 8 patentnih zahtjeva.**

(11) **03780** (13) **B**

(51) **C07D 401/14**<sup>(2006.01)</sup>

**C07D 471/04**<sup>(2006.01)</sup>

**C07D 495/04**<sup>(2006.01)</sup>

**A61K 31/4365**<sup>(2006.01)</sup>

**A61K 31/4709**<sup>(2006.01)</sup>

**A61P 35/00**<sup>(2006.01)</sup>

**C07D 417/14**<sup>(2006.01)</sup>

**C07D 491/048**<sup>(2006.01)</sup>

**A61K 31/4355**<sup>(2006.01)</sup>

**A61K 31/4427**<sup>(2006.01)</sup>

**A61K 31/497**<sup>(2006.01)</sup>

(21) P-2020-82

(22) 14.01.2014

(30) 201361752897P 15.01.2013 US

201361790952P 15.03.2013 US

201361859118P 26.07.2013 US

(96) 14702389.9/14.01.2014

(86) US PCT/US2014/011486/14.01.2014

(87) WO 2014/113388/24.07.2014/2014/30

(97) EP 2945939/25.11.2015/2015/48

EP 2945939/04.03.2020/2020/10

(54) me **JEDINJENJA TIAZOLKARBOKSAMIDA I PIRIDINKARBOKSAMIDA KORISNA KAO INHIBITORI PIM KINAZE**

en **THIAZOLECARBOXAMIDES AND PYRIDINECARBOXAMIDE COMPOUNDS USEFUL AS PIM KINASE INHIBITORS**

(73) Incyte Holdings Corporation

1801 Augustine Cut-Off, Wilmington, DE 19803/ US

(72) XUE, Chu-Biao

307 Wellspring Court, Hockessin, Delaware 19707/ US

, LI, Yun-Long

1 Pin Oak Drive, Chadds Ford, Pennsylvania 19317/ US

FENG, Hao

600 Christopher Lane, Aston, Pennsylvania 19014 / US

PAN, Jun

1295 N. Providence Road A-101, Media, Pennsylvania 19063/ US

WANG, Anlai

102 Bunting Drive, Wilmington, Delaware 19808/ US

ZHANG, Ke

45 Hayloft Circle, Wilmington, Delaware 19808 / US

YAO, Wenqing

45 Magnolia Way, Chadds Ford, Pennsylvania 19317/ US

ZHANG, Fenglei

309 Daniel Drive, Ambler, Pennsylvania 19002/ US

ZHUO, Jincong

17 Forwood Drive, Boothwyn, PA 19061/ US

(74) AOD "LUTOVAC & PARTNERI"

Bulevar Ivana Crnojevića 93 , Podgorica , 81000 / ME

(57)

1. Jedinjenje formule (I):

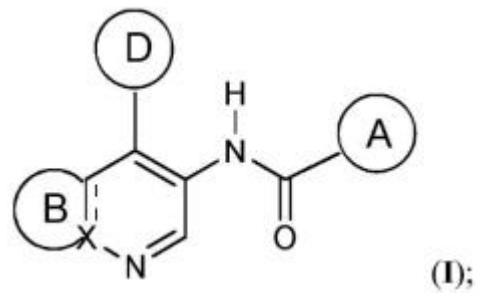

ili njegova farmaceutske prihvatljiva so, pri čemu:

X je C;

---

A, B i D su prstenovi;  
veza  $\text{--}$  predstavlja C=C vezu;  
prsten A je formule (A-1) ili (A-2):

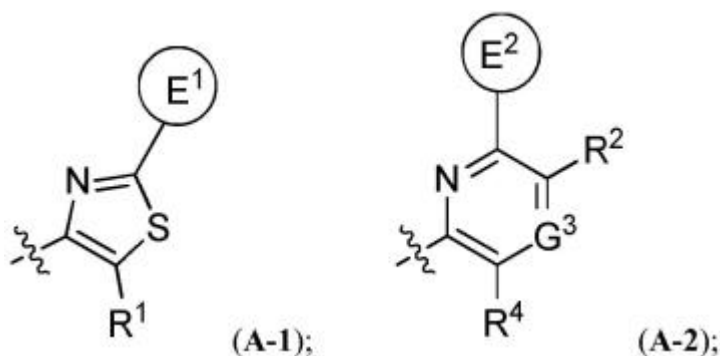

gde su E1 i E2 prstenovi;  
prsten B je prema formuli (B-2):

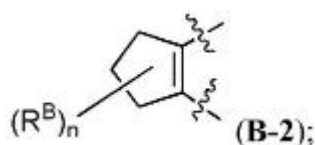

gde je n odabrano od 0, 1, 2 i 3;

prsten D je piperidinski prsten, koji je supstituisan sa k supstituentima nezavisno izabranim iz RD, pri čemu je k 0,1, 2 ili 3;

prsten E1 je fenil opciono supstituisan sa 1, 2 ili 3, supstituenta nezavisno izabranih od RE;

prsten E2 je fenil opciono supstituisan sa 1, 2 ili 3, supstituenta nezavisno izabranih od RE;

G3 je N ili CR3;

R1 je izabran od H, F i NH2;

R2 je izabran od H, halo i CN;

R3 je izabran od H, halo i CN;

R4 je izabran od H, F i NH2;

svaki RB je nezavisno izabran od CyB, halo, C1-6 alkil, C2-6 alkenil, C2-6 alkinil, C1-6 haloalkil, CN, NO2, ORa1, SRa1, C(O)Rb1, C(O)NRc1Rd1, C(O)ORa1, OC(O)Rb1, OC(O)NRc1Rd1, C(=NRe1)NRc1Rd1, NRc1C(=NRe1)NRc1Rd1, NRc1Rd1, NRc1C(O)Rb1, NRc1C(O)ORa1, NRc1C(O)NRc1Rd1, NRc1S(O)Rb1, NRc1S(O)2Rb1, NRc1S(O)2NRc1Rd1, S(O)Rb1, S(O)NRc1Rd1, S(O)2Rb1, S(O)2NRc1Rd1 i okso; pri čemu pomenuti C1-6 alkil, C2-6 alkenil, i C2-6 alkinil supstituenti od RB su svaki opciono supstituisani sa 1, 2 ili 3 supstituenta nezavisno izabranih od CyB, halo, CN, NO2, ORa1, SRa1, C(O)Rb1, C(O)NRc1Rd1, C(O)ORa1, OC(O)Rb1, OC(O)NRc1Rd1, C(=NRe1)NRc1Rd1, NRc1C(=NRe1)NRc1Rd1, NRc1Rd1, NRc1C(O)Rb1, NRc1C(O)ORa1, NRc1C(O)NRc1Rd1, NRc1S(O)Rb1, NRc1S(O)2Rb1, NRc1S(O)2NRc1Rd1, S(O)Rb1, S(O)NRc1Rd1, S(O)2Rb1 i S(O)2NRc1Rd1

svaki RD je nezavisno izabran od CyD, halo, C1-6 alkil, C2-6 alkenil, C2-6 alkinil, C1-6 haloalkil, CN, NO2, ORa2, SRa2, C(O)Rb2, C(O)NRc2Rd2, C(O)ORa2, OC(O)Rb2, OC(O)NRc2Rd2, C(=NRe2)NRc2Rd2, NRc2C(=NRe2)NRc2Rd2, NRc2Rd2, NRc2C(O)Rb2, NRc2C(O)ORa2, NRc2C(O)NRc2Rd2, NRc2S(O)Rb2, NRc2S(O)2Rb2, NRc2S(O)2NRc2Rd2, S(O)Rb2, S(O)NRc2Rd2, S(O)2Rb2, S(O)2NRc2Rd2 i okso; pri čemu pomenuti C1-6 alkil, C2-6 alkenil, i C2-6 alkinil supstituenti od RD su svaki opciono supstituisani sa 1, 2 ili 3 supstituenta nezavisno izabranih od CyD, halo, CN, NO2, ORa2, SRa2, C(O)Rb2, C(O)NRc2Rd2, C(O)ORa2, OC(O)Rb2, OC(O)NRc2Rd2, C(=NRe2)NRc2Rd2, NRc2C(=NRe2)NRc2Rd2, NRc2Rd2, NRc2C(O)Rb2, NRc2C(O)ORa2, NRc2C(O)NRc2Rd2, NRc2S(O)Rb2, NRc2S(O)2Rb2, NRc2S(O)2NRc2Rd2, S(O)Rb2, S(O)NRc2Rd2, S(O)2Rb2 i S(O)2NRc2Rd2; svaki RE je nezavisno izabran od CyE, halo, C1-6 alkil, C2-6 alkenil, C2-6 alkinil, C1-6 haloalkil, CN, NO2, ORa3, SRa3, C(O)Rb3, C(O)NRc3Rd3, C(O)ORa3, OC(O)Rb3, OC(O)NRc3Rd3, C(=NRe3)NRc3Rd3, NRc3C(=NRe3)NRc3Rd3, NRc3Rd3, NRc3C(O)Rb3, NRc3C(O)ORa3, NRc3C(O)NRc3Rd3, NRc3S(O)Rb3, NRc3S(O)2Rb3, NRc3S(O)2NRc3Rd3, S(O)Rb3, S(O)NRc3Rd3, S(O)2Rb3, S(O)2NRc3Rd3 i okso; pri čemu pomenuti C1-6 alkil, C2-6 alkenil, i C2-6 alkinil od RE su svaki opciono supstituisani sa 1, 2 ili 3 supstituenta nezavisno izabranih od CyE, halo, CN, NO2, ORa3, SRa3, C(O)Rb3, C(O)NRc3Rd3, C(O)ORa3, OC(O)Rb3, OC(O)NRc3Rd3, C(=NRe3)NRc3Rd3, NRc3C(=NRe3)NRc3Rd3, NRc3Rd3, NRc3C(O)Rb3, NRc3C(O)ORa3, NRc3C(O)NRc3Rd3, NRc3S(O)Rb3, NRc3S(O)2Rb3, NRc3S(O)2NRc3Rd3, S(O)Rb3, S(O)NRc3Rd3, S(O)2Rb3 i S(O)2NRc3Rd3;

CyB, CyD i CyE su svaki nezavisno izabrani od C6-10 aril, C3-10 cikloalkil, 5-10 -članih heteroaril i 4-10 -članih heterocikloalkil, od kojih je svaki opciono supstituisan sa 1, 2, 3, 4 ili 5 supstituenta nezavisno izabranih od halo, C1-6 alkil, C2-6 alkenil, C2-6 alkinil, C1-6 haloalkil, C6-10 aril, C3-10 cikloalkil, 5-10 -članih heteroaril, 4-10 -članih heterocikloalkil, CN, NO<sub>2</sub>, ORa<sub>4</sub>, SRa<sub>4</sub>, C(O)Rb<sub>4</sub>, C(O)NRc<sub>4</sub>Rd<sub>4</sub>, C(O)ORa<sub>4</sub>, OC(O)Rb<sub>4</sub>, OC(O)NRc<sub>4</sub>Rd<sub>4</sub>, NRc<sub>4</sub>Rd<sub>4</sub>, NRc<sub>4</sub>C(O)R<sub>14</sub>, NRc<sub>4</sub>C(O)ORa<sub>4</sub>, NRc<sub>4</sub>C(O)NRc<sub>4</sub>Rd<sub>4</sub>, C(=NRe<sub>4</sub>)Rb<sub>4</sub>, C(=NRe<sub>4</sub>)NRc<sub>4</sub>Rd<sub>4</sub>, NRc<sub>4</sub>C(=NRe<sub>4</sub>)NRc<sub>4</sub>Rd<sub>4</sub>, NRc<sub>4</sub>S(O)Rb<sub>4</sub>, NRc<sub>4</sub>S(O)2Rb<sub>4</sub>, NRc<sub>4</sub>S(O)2NRc<sub>4</sub>Rd<sub>4</sub>, S(O)Rb<sub>4</sub>, S(O)NRc<sub>4</sub>Rd<sub>4</sub>, S(O)2Rb<sub>4</sub>, i S(O)2NRc<sub>4</sub>Rd<sub>4</sub>, pri čemu pomenuti C1-6 alkil, C2-6 alkenil, C2-6 alkinil, C3-10 cikloalkil, 5-10 -člani heteroaril, i 4-10 -člani heterocikloalkil supstituenti od CyB, CyD ili CyE su svaki opciono supstituisani sa 1, 2 ili 3 supstituenta nezavisno izabranih od halo, C1-4 haloalkil, CN, NO<sub>2</sub>, ORa<sub>4</sub>, SRa<sub>4</sub>, C(O)Rb<sub>4</sub>, C(O)NRc<sub>4</sub>Rd<sub>4</sub>, C(O)ORa<sub>4</sub>, OC(O)Rb<sub>4</sub>, OC(O)NRc<sub>4</sub>Rd<sub>4</sub>, C(=NRe<sub>4</sub>)NRc<sub>4</sub>Rd<sub>4</sub>, NRc<sub>4</sub>C(=NRe<sub>4</sub>)NRc<sub>4</sub>Rd<sub>4</sub>, NRc<sub>4</sub>Rd<sub>4</sub>, NRc<sub>4</sub>C(O)Rb<sub>4</sub>, NRc<sub>4</sub>C(O)ORa<sub>4</sub>, NRc<sub>4</sub>C(O)NRc<sub>4</sub>Rd<sub>4</sub>, NRc<sub>4</sub>S(O)Rb<sub>4</sub>, NRc<sub>4</sub>S(O)2Rb<sub>4</sub>, NRc<sub>4</sub>S(O)2NRc<sub>4</sub>Rd<sub>4</sub>, S(O)Rb<sub>4</sub>, S(O)NRc<sub>4</sub>Rd<sub>4</sub>, S(O)2Rb<sub>4</sub> i S(O)2NRc<sub>4</sub>Rd<sub>4</sub>;

svaki Ra<sub>1</sub>, Rb<sub>1</sub>, Rc<sub>1</sub>, Rd<sub>1</sub>, Ra<sub>2</sub>, Rb<sub>2</sub>, Rc<sub>2</sub>, Rd<sub>2</sub>, Ra<sub>3</sub>, Rb<sub>3</sub>, Rc<sub>3</sub>, Rd<sub>3</sub>, Ra<sub>4</sub>, Rb<sub>4</sub>, Rc<sub>4</sub> i Rd<sub>4</sub> je nezavisno izabran od H, C1-6 alkil, C1-4 haloalkil, C2-6 alkenil, C2-6 alkinil, C6-10 aril, C3-10 cikloalkil, 5-10 -članih heteroaril, 4-10 -članih heterocikloalkil, C6-10 aril-C1-4 alkil, C3-10 cikloalkil-C1-4 alkil, (5-10 -članih heteroaril)-C1-4 alkil ili (4-10 -članih heterocikloalkil)-C1-4 alkil, pri čemu pomenuti C1-6 alkil, C2-6 alkenil, C2-6 alkinil, C6-10 aril, C3-10 cikloalkil, 5-10 -člani heteroaril, 4-10 -člani heterocikloalkil, C6-10 aril-C1-4 alkil, C3-10 cikloalkil-C1-4 alkil, (5-10 -člani heteroaril)-C1-4 alkil i (4-10 -člani heterocikloalkil)-C1-4 alkil je opciono supstituisan sa 1, 2, 3, 4, ili 5 supstituenta nezavisno izabranih od C1-4 alkil, C1-4 haloalkil, halo, CN, ORa<sub>5</sub>, SRa<sub>5</sub>, C(O)Rb<sub>5</sub>, C(O)NRc<sub>5</sub>Rd<sub>5</sub>, C(O)ORa<sub>5</sub>, OC(O)Rb<sub>5</sub>, OC(O)NRc<sub>5</sub>Rd<sub>5</sub>, NRc<sub>5</sub>Rd<sub>5</sub>, NRc<sub>5</sub>C(O)R<sub>15</sub>, NRc<sub>5</sub>C(O)NRc<sub>5</sub>Rd<sub>5</sub>, NRc<sub>5</sub>C(O)ORa<sub>5</sub>, C(=NRe<sub>5</sub>)NRc<sub>5</sub>Rd<sub>5</sub>, NRc<sub>5</sub>C(=NRe<sub>5</sub>)NRc<sub>5</sub>Rd<sub>5</sub>, S(O)Rb<sub>5</sub>, S(O)NRc<sub>5</sub>Rd<sub>5</sub>, S(O)2Rb<sub>5</sub>, NRc<sub>5</sub>S(O)2Rb<sub>5</sub>, NRc<sub>5</sub>S(O)2NRc<sub>5</sub>Rd<sub>5</sub> i S(O)2NRc<sub>5</sub>Rd<sub>5</sub>;

ili bilo koji Rc<sub>1</sub> i Rd<sub>1</sub> vezani za isti N atom, zajedno sa N atomom za koji su vezani, formiraju 4-, 5-, 6-ili 7-članu heterocikloalkil grupu opciono supstituisanu sa 1, 2 ili 3 supstituenta nezavisno izabranih od C1-6 alkil, C3-7 cikloalkil, 3-7 -članih heterocikloalkil, C6-10 aril, 5-6 -članih heteroaril, C1-6 haloalkil, halo, CN, ORa<sub>5</sub>, SRa<sub>5</sub>, C(O)Rb<sub>5</sub>, C(O)NRc<sub>5</sub>Rd<sub>5</sub>, C(O)ORa<sub>5</sub>, OC(O)Rb<sub>5</sub>, OC(O)NRc<sub>5</sub>Rd<sub>5</sub>, NRc<sub>5</sub>Rd<sub>5</sub>, NRc<sub>5</sub>C(O)Rb<sub>5</sub>, NRc<sub>5</sub>C(O)NRc<sub>5</sub>Rd<sub>5</sub>, NRc<sub>5</sub>C(O)ORa<sub>5</sub>, C(=NRe<sub>5</sub>)NRc<sub>5</sub>Rd<sub>5</sub>, NRc<sub>5</sub>C(=NRe<sub>5</sub>)NRc<sub>5</sub>Rd<sub>5</sub>, S(O)Rb<sub>5</sub>, S(O)NRc<sub>5</sub>Rd<sub>5</sub>, S(O)2Rb<sub>5</sub>, NRc<sub>5</sub>S(O)2Rb<sub>5</sub>, NRc<sub>5</sub>S(O)2NRc<sub>5</sub>Rd<sub>5</sub> i S(O)2NRc<sub>5</sub>Rd<sub>5</sub>, pri čemu su C1-6 alkil, C3-7 cikloalkil, 4-7 -člani heterocikloalkil, C6-10 aril i 5-6 -člani heteroaril opciono supstituisani sa 1, 2 ili 3 supstituenta nezavisno izabranih od halo, C1-4 alkil, C1-4 haloalkil, C1-4 cijanoalkil, CN, ORa<sub>5</sub>, SRa<sub>5</sub>, C(O)Rb<sub>5</sub>, C(O)NRc<sub>5</sub>Rd<sub>5</sub>, C(O)ORa<sub>5</sub>, OC(O)Rb<sub>5</sub>, OC(O)NRc<sub>5</sub>Rd<sub>5</sub>, NRc<sub>5</sub>Rd<sub>5</sub>, NRc<sub>5</sub>C(O)Rb<sub>5</sub>, NRc<sub>5</sub>C(O)NRc<sub>5</sub>Rd<sub>5</sub>, NRc<sub>5</sub>C(O)ORa<sub>5</sub>, C(=NRe<sub>5</sub>)NRc<sub>5</sub>Rd<sub>5</sub>, NRc<sub>5</sub>C(=NRe<sub>5</sub>)NRc<sub>5</sub>Rd<sub>5</sub>, S(O)Rb<sub>5</sub>, S(O)NRc<sub>5</sub>Rd<sub>5</sub>, S(O)2Rb<sub>5</sub>, NRc<sub>5</sub>S(O)2Rb<sub>5</sub>, NRc<sub>5</sub>S(O)2NRc<sub>5</sub>Rd<sub>5</sub> i S(O)2NRc<sub>5</sub>Rd<sub>5</sub>;

ili bilo koji Rc<sub>2</sub> i Rd<sub>2</sub> vezani za isti N atom, zajedno sa N atomom za koji su vezani, formiraju 4-, 5-, 6-ili 7-članu heterocikloalkil grupu opciono supstituisanu sa 1, 2 ili 3 supstituenta nezavisno izabranih od C1-6 alkil, C3-7 cikloalkil, 4-7 -članih heterocikloalkil, C6-10 aril, i 5-6 -članih heteroaril, C1-6 haloalkil, halo, CN, ORa<sub>5</sub>, SRa<sub>5</sub>, C(O)Rb<sub>5</sub>, C(O)NRc<sub>5</sub>Rd<sub>5</sub>, C(O)ORa<sub>5</sub>, OC(O)Rb<sub>5</sub>, OC(O)NRc<sub>5</sub>Rd<sub>5</sub>, NRc<sub>5</sub>Rd<sub>5</sub>, NRc<sub>5</sub>C(O)Rb<sub>5</sub>, NRc<sub>5</sub>C(O)NRc<sub>5</sub>Rd<sub>5</sub>, NRc<sub>5</sub>C(O)ORa<sub>5</sub>, C(=NRe<sub>5</sub>)NRc<sub>5</sub>Rd<sub>5</sub>, NRc<sub>5</sub>C(=NRe<sub>5</sub>)NRc<sub>5</sub>Rd<sub>5</sub>, S(O)Rb<sub>5</sub>, S(O)NRc<sub>5</sub>Rd<sub>5</sub>, S(O)2Rb<sub>5</sub>, NRc<sub>5</sub>S(O)2Rb<sub>5</sub>, NRc<sub>5</sub>S(O)2NRc<sub>5</sub>Rd<sub>5</sub> i S(O)2NRc<sub>5</sub>Rd<sub>5</sub>, pri čemu pomenuti C1-6 alkil, C3-7 cikloalkil, 4-7 -člani heterocikloalkil, C6-10 aril i 5-6 -člani heteroaril su opciono supstituisani sa 1, 2 ili 3 supstituenta nezavisno izabranih od halo, C1-4 alkil, C1-4 haloalkil, C1-4 cijanoalkil, CN, ORa<sub>5</sub>, SRa<sub>5</sub>, C(O)Rb<sub>5</sub>, C(O)NRc<sub>5</sub>Rd<sub>5</sub>, C(O)ORa<sub>5</sub>, OC(O)Rb<sub>5</sub>, OC(O)NRc<sub>5</sub>Rd<sub>5</sub>, NRc<sub>5</sub>Rd<sub>5</sub>, NRc<sub>5</sub>C(O)Rb<sub>5</sub>, NRc<sub>5</sub>C(O)NRc<sub>5</sub>Rd<sub>5</sub>, NRc<sub>5</sub>C(O)ORa<sub>5</sub>, C(=NRe<sub>5</sub>)NRc<sub>5</sub>Rd<sub>5</sub>, NRc<sub>5</sub>C(=NRe<sub>5</sub>)NRc<sub>5</sub>Rd<sub>5</sub>, S(O)Rb<sub>5</sub>, S(O)NRc<sub>5</sub>Rd<sub>5</sub>, S(O)2Rb<sub>5</sub>, NRc<sub>5</sub>S(O)2Rb<sub>5</sub>, NRc<sub>5</sub>S(O)2NRc<sub>5</sub>Rd<sub>5</sub> i S(O)2NRc<sub>5</sub>Rd<sub>5</sub>;

ili bilo koji Rc<sub>3</sub> i Rd<sub>3</sub> vezani za isti N atom, zajedno sa N atomom za koji su vezani, formiraju 4-, 5-, 6-ili 7-članu heterocikloalkil grupu opciono supstituisanu sa 1, 2 ili 3 supstituenta nezavisno izabranih od C1-6 alkil, C3-7 cikloalkil, 4-7 -članih heterocikloalkil, C6-10 aril, 5-6 -članih heteroaril, C1-6 haloalkil, halo, CN, ORa<sub>5</sub>, SRa<sub>5</sub>, C(O)Rb<sub>5</sub>, C(O)NRc<sub>5</sub>Rd<sub>5</sub>, C(O)ORa<sub>5</sub>, OC(O)Rb<sub>5</sub>, OC(O)NRc<sub>5</sub>Rd<sub>5</sub>, NRc<sub>5</sub>Rd<sub>5</sub>, NRc<sub>5</sub>C(O)Rb<sub>5</sub>, NRc<sub>5</sub>C(O)NRc<sub>5</sub>Rd<sub>5</sub>, NRc<sub>5</sub>C(O)ORa<sub>5</sub>, C(=NRe<sub>5</sub>)NRc<sub>5</sub>Rd<sub>5</sub>, NRc<sub>5</sub>C(=NRe<sub>5</sub>)NRc<sub>5</sub>Rd<sub>5</sub>, S(O)Rb<sub>5</sub>, S(O)NRc<sub>5</sub>Rd<sub>5</sub>, S(O)2Rb<sub>5</sub>, NRc<sub>5</sub>S(O)2Rb<sub>5</sub>, NRc<sub>5</sub>S(O)2NRc<sub>5</sub>Rd<sub>5</sub> i S(O)2NRc<sub>5</sub>Rd<sub>5</sub>, pri čemu pomenuti C1-6 alkil, C3-7 cikloalkil, 4-7 -člani heterocikloalkil, C6-10 aril, i 5-6 -člani heteroaril su opciono supstituisani sa 1, 2 ili 3 supstituenta nezavisno izabranih od halo, C1-4 alkil, C1-4 haloalkil, C1-4 cijanoalkil, CN, ORa<sub>5</sub>, SRa<sub>5</sub>, C(O)Rb<sub>5</sub>, C(O)NRc<sub>5</sub>Rd<sub>5</sub>, C(O)ORa<sub>5</sub>, OC(O)Rb<sub>5</sub>, OC(O)NRc<sub>5</sub>Rd<sub>5</sub>, NRc<sub>5</sub>Rd<sub>5</sub>, NRc<sub>5</sub>C(O)Rb<sub>5</sub>, NRc<sub>5</sub>C(O)NRc<sub>5</sub>Rd<sub>5</sub>, NRc<sub>5</sub>C(O)ORa<sub>5</sub>, C(=NRe<sub>5</sub>)NRc<sub>5</sub>Rd<sub>5</sub>, NRc<sub>5</sub>C(=NRe<sub>5</sub>)NRc<sub>5</sub>Rd<sub>5</sub>, S(O)Rb<sub>5</sub>, S(O)NRc<sub>5</sub>Rd<sub>5</sub>, S(O)2Rb<sub>5</sub>, NRc<sub>5</sub>S(O)2Rb<sub>5</sub>, NRc<sub>5</sub>S(O)2NRc<sub>5</sub>Rd<sub>5</sub> i S(O)2NRc<sub>5</sub>Rd<sub>5</sub>;

ili bilo koji Rc<sub>4</sub> i Rd<sub>4</sub> vezani za isti N atom, zajedno sa N atomom za koji su vezani, formiraju 4-, 5-, 6-ili 7-članu heterocikloalkil grupu opciono supstituisanu sa 1, 2 ili 3 supstituenta nezavisno izabranih od C1-6 alkil, C3-7 cikloalkil, 3-7 -članih heterocikloalkil, C6-10 aril, 5-6 -članih heteroaril, C1-6 haloalkil, halo, CN, ORa<sub>5</sub>, SRa<sub>5</sub>, C(O)Rb<sub>5</sub>, C(O)NRc<sub>5</sub>Rd<sub>5</sub>, C(O)ORa<sub>5</sub>, OC(O)Rb<sub>5</sub>, OC(O)NRc<sub>5</sub>Rd<sub>5</sub>, NRc<sub>5</sub>Rd<sub>5</sub>, NRc<sub>5</sub>C(O)Rb<sub>5</sub>, NRc<sub>5</sub>C(O)NRc<sub>5</sub>Rd<sub>5</sub>, NRc<sub>5</sub>C(O)ORa<sub>5</sub>, C(=NRe<sub>5</sub>)NRc<sub>5</sub>Rd<sub>5</sub>, NRc<sub>5</sub>C(=NRe<sub>5</sub>)NRc<sub>5</sub>Rd<sub>5</sub>, S(O)Rb<sub>5</sub>, S(O)NRc<sub>5</sub>Rd<sub>5</sub>, S(O)2Rb<sub>5</sub>, NRc<sub>5</sub>S(O)2Rb<sub>5</sub>, NRc<sub>5</sub>S(O)2NRc<sub>5</sub>Rd<sub>5</sub> i S(O)2NRc<sub>5</sub>Rd<sub>5</sub>, pri čemu pomenuti C1-6 alkil, C3-7 cikloalkil, 3-7 -člani heterocikloalkil, C6-10 aril, i 5-6 -člani heteroaril su opciono supstituisani sa 1, 2 ili 3 supstituenta nezavisno izabranih od halo, C1-4 alkil, C1-4 haloalkil, C1-4

cijanoalkil, CN ORa5, SRa5, C(O)Rb5, C(O)NRc5Rd5, C(O)ORa5, OC(O)Rb5, OC(O)NRc5Rd5, NRc5Rd5, NRc5C(O)Rb5, NRc5C(O)NRc5Rd5, NRc5C(O)ORa5, C(=NRe5)NRc5Rd5, NRc5C(=NRe5)NRc5Rd5, S(O)Rb5, S(O)NRc5Rd5, S(O)2Rb5, NRc5S(O)2Rb5, NRc5S(O)2NRc5Rd5 i S(O)2NRc5Rd5;

svaki Ra5, Rb5, Rc5 i Rd5 je nezavisno izabran od H, C1-4 alkil, C1-4 haloalkil, C2-4 alkenil i C2-4 alkinil, pri čemu pomenuti C1-4 alkil, C2-4 alkenil, i C2-4 alkinil, je opciono supstituisan sa 1, 2 ili 3 supstituenta nezavisno izabranih od OH, CN, amino, halo, C1-4 alkil, C1-4 alkoksi, C1-4 alkiltio, C1-4 alkilamino, di(C1-4 alkil)amino, C1-4 haloalkil, i C1-4 haloalkoksi;

ili bilo koji Rc5 i Rd5 vezani za isti N atom, zajedno sa N atomom za koji su vezani, formiraju 3-, 4-, 5-, 6-, ili 7-članu heterocikloalkil grupu opciono supstituisanu sa 1, 2 ili 3 supstituenta nezavisno izabranih od OH, CN, amino, halo, C1-6 alkil, C1-4 alkoksi, C1-4 alkiltio, C1-4 alkilamino, di(C1-4 alkil)amino, C1-4 haloalkil i C1-4 haloalkoksi; i

svaki Re1, Re2, Re3, Re4 i Re5 je nezavisno izabran od H, C1-4 alkil i CN.

**Patent sadrži još 48 patentnih zahtjeva.**



(11) **03781** (13) **B**

(51) **C07K 7/06**<sup>(2006.01)</sup>

**A61K 38/00**<sup>(2006.01)</sup>

(21) P-2020-83

(22) 03.04.2015

(30) 201461974899P 03.04.2014 US

(96) 15773570.5/03.04.2015

(86) US PCT/US2015/024347/03.04.2015

(87) WO 2015/154031/08.10.2015/2015/40

(97) EP 3126373/08.02.2017/2017/06

EP 3126373/04.03.2020/2020/10

(54) me **METODA ZA PRIPREMANJE AMG 416**  
en **METHOD FOR PREPARING AMG 416**

(73) Amgen Inc.

One Amgen Center Drive, Thousand Oaks, California 91320/ US

(72) BEZEMER, Jeroen

654 Camino Manzanas, Thousand Oaks, CA 91360/ US

CHEN, Ying

1429 Honey Creek Court, Newbury Park, CA 91320 / US

CROCKETT, Richard

867 Briar Cliff Road, Thousand Oaks, CA 91360 / US

CROSSLEY, Kevin

455 Serento Circle, Thousand Oaks, CA 91360/ US

CUI, Sheng

391 Lincoln Street, Lexington, MA 02421/ US

HUANG, Liang

1654 Rush Haven Way, Simi Valley, CA 93065/ US

JONES, Sian

784 Cypress Avenue, Newbury Park, CA 91320 / US

LOWER, Asher

4305 Timberdale Road, Moorpark, CA 93021 / US

RANGANATHAN, Krishnakumar

1752 Blossom Court, Thousand Oaks, CA 91320 / US

(74) Advokat RADULOVIĆ, Božidar S.

Baku 30/5, Podgorica, 81000 / ME

(57)

1. Metoda za pripremanje AMG 416 je izneta u formuli (I):

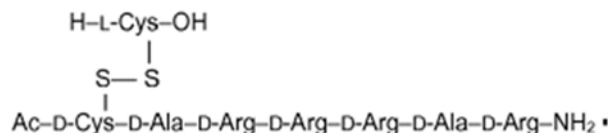

gde navedena metoda obuhvata:

dovođenje peptida koji ima strukturu Ac-D-Cys(SPy)-D-Ala-D-Arg-D-Arg-D-Arg-D-Ala-D-Arg-NH<sub>2</sub> (SEQ ID NO:4) u kontakt sa L-Cys

kako bi se dobio konjugovani proizvod formule (I).

**Patent sadrži još 7 patentnih zahtjeva.**

(11) **03782** (13) **B**

(51) **C07D 239/48**<sup>(2006.01)</sup>

**C07D 401/12**<sup>(2006.01)</sup>

**C07D 403/12**<sup>(2006.01)</sup>

**C07D 413/12**<sup>(2006.01)</sup>

**A61K 31/505**<sup>(2006.01)</sup>

**C07D 405/12**<sup>(2006.01)</sup>

**C07D 471/04**<sup>(2006.01)</sup>

**A61K 31/506**<sup>(2006.01)</sup>

(21) P-2020-84

(22) 10.04.2012

(30) 20110161595 08.04.2011 EP

(96) 17203628.7/10.04.2012

(97) EP 3330257/06.06.2018/2018/23

EP 3330257/11.03.2020/2020/11

(54) me **DERIVATI PIRIMIDINA ZA TRETMAN VIRUSNIH INFEKCIJA**  
en **PYRIMIDINE DERIVATIVES FOR THE TREATMENT OF VIRAL INFECTIONS**

(73) Janssen Sciences Ireland Unlimited Company

Barnahely, Ringaskiddy Co Cork, / IE

(72) MC GOWAN, David Craig

Turnhoutseweg 30 , Beerse , 2340 / BE

RABOISSON, Pierre Jean-Marie Bernard

Turnhoutseweg 30 , Beerse , 2340 / BE

EMBRECHTS, Werner, Constant J.

Turnhoutseweg 30 , Beerse , 2340 / BE

JONCKERS, Tim Hugo Maria

Turnhoutseweg 30 , Beerse , 2340 / BE

LAST, Stefaan Julien

Turnhoutseweg 30 , Beerse, 2340/ BE

PIETERS, Serge Maria Aloysius

Turnhoutseweg 30 , Beerse , 2340 / BE

VLACH, Jaromir

144 Impasse de l'Orchidée, La Roche sur Foron, 74800 / FR

(74) Advokat RADULOVIĆ, Božidar S.

Baku 30/5, Podgorica, 81000 / ME

(57)

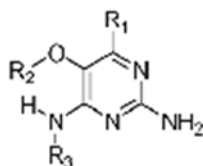

1. Jedinjenje formule (I)

ili njegova farmaceutski prihvatljiva so, tautomer, solvat ili polimorf, gde

R1 je vodonik, C1-4alkil, ciklopropil, C1-6alkoksi, halogen, hidroksil, ili trifluorometil;

R2 je C1-8alkil, (C1-4)alkoksi-(C1-4)alkil, C3-7cikloalkil, C4-7heterocikl, biciklični heterocikl, arilalkil, heteroaril, ili heteroarilalkil, od kojih je svaki opciono supstituisan sa jednim ili više supstituenata izabranih iz grupe koju čine halogen, hidroksil, amino, C1-6alkil, di-(C1-6)alkilamino, C1-6alkilamino, C1-6alkil, C1-6alkoksi, C3-6cikloalkil, karboksilna kiselina, karboksilni ester, karboksilni amid, heterocikl, aril, alkenil, alkinil, arilalkil, heteroaril, heteroarilalkil, nitril; i

R3 je C4-8alkil, C4-8alkoksi, C2-6alkenil ili C2-6 alkinil, od kojih je svaki opciono supstituisan sa jednim ili više supstituenata izabranih iz grupe koju čine halogen, hidroksil, amino, C1-3alkil, C1-3alkoksi, C3-6 cikloalkil, i nitril.

**Patent sadrži još 10 patentnih zahtjeva.**

(11) **03783** (13) **B**

(51) **A61K 31/785**<sup>(2006.01)</sup>

**C08F 226/02**<sup>(2006.01)</sup>

**C08F 8/02**<sup>(2006.01)</sup>

- (21) P-2020-85  
(22) 10.12.2015  
(30) 201462090287P 10.12.2014 US  
(96) 15823049.0/10.12.2015  
(86) US PCT/US2015/065041/10.12.2015  
(87) WO 2016/094685/16.06.2016/2016/23  
(97) EP 3229816/18.10.2017/2017/42  
EP 3229816/05.02.2020/2020/06  
(54) me **POLIMERI KOJI VEZUJU PROTONE ZA ORALNU PRIMJENU**  
en **PROTON-BINDING POLYMERS FOR ORAL ADMINISTRATION**  
(73) Tricida Inc.  
7000 Shoreline Court, Suite 201, South San Francisco, CA 94080 / US  
(72) KLAERNER, Gerrit  
7000 Shoreline Court Suite 201, South San Francisco, California 94080 / US/ US  
CONNOR, Eric F.  
7000 Shoreline Court Suite 201, South San Francisco, California 94080 / US/ US  
GBUR, Randi K.  
7000 Shoreline Court Suite 201, South San Francisco, California 94080/ US  
KADE, Matthew J.  
7000 Shoreline Court Suite 201, South San Francisco, California 94080/ US  
KIERSTEAD, Paul H.  
7000 Shoreline Court Suite 201, South San Francisco, California 94080/ US  
BUYSSE, Jerry M.  
7000 Shoreline Court Suite 201, South San Francisco, California 94080/ US  
COPE, Michael J.  
7000 Shoreline Court Suite 201, South San Francisco, California 94080/ US  
BIYANI, Kalpesh N.  
7000 Shoreline Court Suite 201, South San Francisco, California 94080/ US  
NGUYEN, Son H.  
7000 Shoreline Court Suite 201, South San Francisco, California 94080/ US  
TABAKMAN, Scott M.  
7000 Shoreline Court Suite 201, South San Francisco, California 94080/ US  
(74) AOD "LUTOVAC & PARTNERI"  
Bulevar Ivana Crnojevića 93, Podgorica, 81000 / ME

(57)

1. Postupak za pripremu umreženogaminskog polimera koji obuhvata umrežavanje prethodno obrazovanogaminskog polimera u reakcionoj smeši da bi se obrazovao umreženiaminski polimer, gde

reakciona smeša sadrži prethodno obrazovaniaminski polimer, rastvarač, agens za umrežavanje i agens za bubrenje za prethodno obrazovaniaminski polimer, pri čemu je prethodno obrazovaniaminski polimer sa apsorpcionim kapacitetom za agens za bubrenje, a količina agensa za bubrenje u reakcionoj smeši je manja od apsorpcionog kapaciteta prethodno obrazovanogaminskog polimera za agens za bubrenje; i

pri čemu je težinski odnos agensa za bubrenje prema prethodno obrazovanomaminskom polimeru u reakcionoj smeši manji od 1:1, prethodno obrazovaniaminski polimer sadrži ostatak amina koji odgovara Formuli 1:

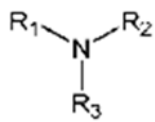

Formula 1

gde su R<sub>1</sub>, R<sub>2</sub> i R<sub>3</sub> nezavisno vodonik, hidrokarbil, supstituisani hidrokarbil, pod uslovom, međutim, da je najmanje jedan od R<sub>1</sub>, R<sub>2</sub> i R<sub>3</sub> različit od vodonika;

pri čemu je rastvarač uključen u korak umrežavanja da bi se dispergovale globule prethodno obrazovanog umreženog polimera, a, opciono, agens za umrežavanje i rastvarač mogu biti isti.

**Patent sadrži još 24 patentnih zahtjeva.**

(11) **03784** (13) **B**

(51) **A61K 35/74**<sup>(2015.01)</sup>

**A61P 35/00**<sup>(2006.01)</sup>

(21) P-2020-86

(22) 15.06.2016

(30) 20150010469 15.06.2015 GB

20150020628 23.11.2015 GB

20160004566 17.03.2016 GB

(96) 19170925.2/15.06.2016

(97) EP 3549592/09.10.2019/2019/41

EP 3549592/12.02.2020/2020/07

(54) me **KOMPOZICIJE KOJE SADRŽE SOJEVE BAKTERIJA**  
en **COMPOSITIONS COMPRISING BACTERIAL STRAINS**

(73) 4D Pharma Research Limited

Life Sciences Innovation Building, Cornhill Road, Aberdeen AB25 2ZS/ GB

(72) GRANT, George

Life Sciences Innovation Building, Cornhill Road , Aberdeen Aberdeenshire AB25 2ZS/ GB

PATTERSON, Angela Margaret

Norwich Medical School Faculty of Medicine and Health Sciences University of East Anglia, Norwich Norfolk NR4 7JT / GB

MULDER, Imke

Life Sciences Innovation Building, Cornhill Road Aberdeen Aberdeenshire, AB25 2ZS/ GB

MCCLUSKEY, Seanin

3rd Floor 9 Bond Court , Leeds Yorkshire LS1 2JZ / GB

RAFTIS, Emma

3rd Floor 9 Bond Court , Leeds Yorkshire LS1 2JZ / GB

(74) AOD "LUTOVAC & PARTNERI"

Bulevar Ivana Crnojevića 93 , Podgorica , 81000 / ME

(57)

1. Kompozicija koja sadrži bakterijski soj vrste *Parabacteroides distasonis*, za upotrebu u postupku lečenja ili sprečavanja kancera debelog creva.

**Patent sadrži još 3 patentnih zahtjeva.**

(11) **03785** (13) **B**

(51) **C07D 401/02**<sup>(2006.01)</sup>

**A61K 31/506**<sup>(2006.01)</sup>

**A61P 35/00**<sup>(2006.01)</sup>

**C07D 471/04**<sup>(2006.01)</sup>

**A61K 31/437**<sup>(2006.01)</sup>

(21) P-2020-87

(22) 25.07.2012

(30) 201161512061P 27.07.2011 US

201261591363P 27.01.2012 US

(96) 17194307.9/25.07.2012

(97) EP 3333161/13.06.2018/2018/24

EP 3333161/19.02.2020/2020/08

(54) me **2-(2,4,5-SUPSTITUISANI-ANILINO)PIRIMIDINSKI DERIVATI KAO EGFR MODULATORI KORISNI ZA LIJEČENJE RAKA**

en **2-(2,4,5-SUBSTITUTED-ANILINO)PYRIMIDINE DERIVATIVES AS EGFR MODULATORS USEFUL FOR TREATING CANCER**

(73) Astrazeneca AB

151 85 Södertälje/ SE

(72) BUTTERWORTH, Sam

Alderley Park , Macclesfield, Cheshire SK10 4TG / GB

WARD, Richard, Andrew

AstraZeneca Darwin Building Cambridge Science Park, Milton Road, Cambridge, Cambridgeshire CB4 0WG/ GB

FINLAY, Maurice, Raymond, Verschoyle

AstraZeneca, Darwin Building Cambridge Science Park, Milton Road, Cambridge, Cambridgeshire CB4 0WG/ GB

KADAMBAR, Vasantha, Krishna

AstraZeneca Alderley Park, Macclesfield, Cheshire SK10 4TG / GB

CHINTAKUNTLA, Chandrasekhara, Reddy

AstraZeneca Alderley Park, Macclesfield, Cheshire SK10 4TG/ GB

MURUGAN, Andiappan

AstraZeneca Alderley Park, Macclesfield, Cheshire SK10 4TG/ GB

CHUAQUI, Claudio, Edmundo

AstraZeneca, 35Gatehouse Drive, Waltham, MA 02451/ US

REDFEARN, Heather, Marie

AstraZeneca Charter Way, Macclesfield, Cheshire SK10 2NA / GB

(74) Advokat RADULOVIĆ, Božidar S.

Baku 30/5, Podgorica, 81000 / ME

(57)

1. Jedinjenje sa Formulom (I):

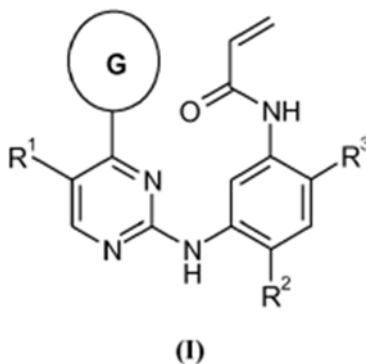

naznačeno time što:

**G** je izabran od 4,5,6,7-tetrahidropirazolo[1,5-*a*]piridin-3-il,1*H*-indol-3-il, 1-metil-1*H*-indol-3-il i pirazolo[1,5-*a*]piridin-3-il;

**R1** je izabran od vodika, fluora, klora, metila i cijano;

**R2** je izabran od metoksi i metila; i

**R3** je izabran iz grupe koja sadrži (3*R*)-3-(dimetilamino)pirolidin-1-il, (3*S*)-3-(dimetil-amino)pirolidin-1-il,3-(dimetilamino)azetidin-1-il, [2-(dimetilamino)etil]-(metil)amino, [2-(metilamino)etil](metil)amino, 5-metil-2,5-diazaspiro[3.4]okt-2-il, (3*aR*,6*aR*)-5-metilheksahidro-pirol[3,4-*b*]pirol-1(2*H*)-il, 1-metil-1,2,3,6-tetrahidropiridin-4-il,4-metilpiperazin-1-il, 4-[2-(dimetilamino)-2-oksoetil]piperazin-1-il, metil[2-(4-metilpiperazin-1-il)etil]amino, metil[2-(morfolin-4-il)etil]amino i 4-[(2*S*)-2-aminopropanoil]piperazin-1-il; ili neka njegova farmaceutski prihvatljiva so.

**Patent sadrži još 14 patentnih zahtjeva.**

(11) **03786** (13) **B**

(51) **C07D 215/56**<sup>(2006.01)</sup>

**A61K 31/445**<sup>(2006.01)</sup>

(21) P-2020-88

(22) 29.12.2020

(30) 20050754381P 28.12.2005 US

(96) 17154944.7/29.12.2020

(97) EP 3219705/20.09.2017/2017/38

EP 3219705/11.03.2020/2020/11

(54) me **FARMACEUTSKE KOMPOZICIJE AMORFNOG OBLIKA N-[2,4-BIS(1,1-DIMETILETIL)-5-HIDROKSIFENIL]-1,4-DIHIDRO-4-OKSOHINOLIN-3-KARBOKSAMIDA**  
en **PHARMACEUTICAL COMPOSITIONS OF THE AMORPHOUS FORM OF N-[2,4-BIS(1,1-DIMETHYLETHYL)-5-HYDROXYPHENYL]-1,4-DIHYDRO-4-OXOQUINOLINE-3-CARBOXAMIDE**

(73) Vertex Pharmaceuticals Incorporated

50 Northern Avenue, Boston, MA 02210/ US

(72) HURTER, Patricia

49 Tahanto Trail, Harvard MA 01451/ US

GONG, Yuchuan

10 Butler Avenue, Lexington, MA 02421 / US

YOUNG, Christopher R.

42 Francis Street, Unit 1, Waltham, MA 02451 / US

CONNELLY, Patrick

15 Lovers Lane, Harvard, MA 01451 / US

ROWE, William

770 Highland Avenue, Medford MA 02155/ US

COSTACHE, Adriana

391 Hyde Park Avenue, No. 211, Roslindale, MA 02131/ US

KRAWIEC, Mariusz

46 Littlefield Lane, Marlborough, MA 01752/ US

FENG, Yushi

131 Pierce St., Apt.306, Maldon, MA 02148 / US

TRUDEAU, Martin

38 Avenue Birch, Shannon, Québec G0A 4N0 / CA

(74) AOD "LUTOVAC & PARTNERI"

Bulevar Ivana Crnojevića 93 , Podgorica , 81000 / ME

(57)

1. Farmaceutska kompozicija koja sadrži amorfni N-[2,4-bis(1,1-dimetiletal)-5-hidroksifenil]-1,4-dihidro-4-oksohinolin-3-karboksamid gde amorfni N-[2,4-bis(1,1-dimetiletal)-5-hidroksifenil]-1,4-dihidro-4-oksohinolin-3-karboksamid ima manje od 30% kristalnog N-[2,4-bis(1,1-dimetiletal)-5-hidroksifenil]-1,4-dihidro-4-oksohinolin-3-karboksamida.

**Patent sadrži još 8 patentnih zahtjeva.**



(11) **03787** (13) **B**

(51) **C07D 207/36**<sup>(2006.01)</sup>

**C07D 403/12**<sup>(2006.01)</sup>

**A61K 31/401**<sup>(2006.01)</sup>

**C07D 207/40**<sup>(2006.01)</sup>

**C07D 405/12**<sup>(2006.01)</sup>

**A61P 31/20**<sup>(2006.01)</sup>

(21) P-2020-89

(22) 16.05.2014

(30) 20130168291 17.05.2013 EP

20130175181 04.07.2013 EP

20130182281 29.08.2013 EP

20130191209 31.10.2013 EP

20130198160 18.12.2013 EP

20140157900 05.03.2014 EP

(96) 16180180.8/16.05.2014

(97) EP 3121164/25.01.2017/2017/04

EP 3121164/19.02.2020/2020/08

(54) me **DERIVATI SULFAMILPIROROLAMIDA I NJIHOVA PRIMJENA KAO LJEKOVI ZA TRETMAN HEPATITISA B**  
en **SULPHAMOYLPIRROLAMIDE DERIVATIVES AND THE USE THEREOF AS MEDICAMENTS FOR THE**  
**TREATMENT OF HEPATITIS B**

(73) Janssen Sciences Ireland Unlimited Company

Barnahely, Ringaskiddy Co Cork,/ IE

(72) VANDYCK, Koen

Turnhoutseweg 30 , 2340 Beerse / BE

HACHÉ, Geerwin Yvonne Paul

Turnhoutseweg 30 , 2340 Beerse / BE

LAST, Stefaan Julien

Turnhoutseweg 30 , 2340 Beerse / BE

MC GOWAN, David Craig

Turnhoutseweg 30 , 2340 Beerse / BE

ROMBOOTS, Geert

Turnhoutseweg 30, 2340 Beerse / BE

VERSCHUEREN, Wim Gaston

Turnhoutseweg 30 , 2340 Beerse/ BE

RABOISSON, Pierre Jean-Marie Bernard

Turnhoutseweg 30 , 2340 Beerse/ BE

(74) Advokat RADULOVIĆ, Božidar S.

Baku 30/5, Podgorica, 81000 / ME

(57)

1. Jedinjenje Formule (IA)

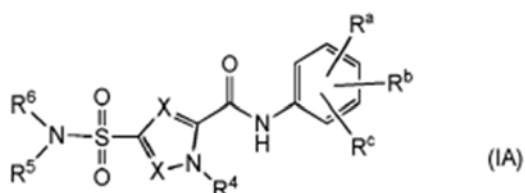

ili njegov stereoizomerni ili tautomerni oblik, gde:

Svako X nezavisno predstavlja CR7;

Ra, Rb i Rc su nezavisno odabrani iz grupe koja se sastoji od Vodoniik, Fluoro, Bromo, Hloro, -CHF2, -CF2-metil, -CH2F, -CF3, -OCF3, -CN, C1-C3alkil i C3-C4cikloalkil;

R4 je Vodoni, C1-C3alkil ili C3-C4cikloalkil;

R5 je Vodoni;

R6 je izabran iz grupe koju čine C2-C6alkil, C1-C4alkil-R8 opciono supstituisan sa jednim ili više Fluoro, C1-C4alkil-R9 koji je opciono supstituisan sa jednim ili više Fluoro i 3-7-člani mono- ili policiklični zasićeni prsten po izboru koji sadrži jedan ili više heteroatoma, svaki nezavisno odabran iz grupe koju čine O, S i N, takav 3-7-člani zasićeni prsten ili C2-C6alkil koji je opciono supstituisan sa jednim ili više supstituenata, svaki nezavisno odabran iz grupe koju čine Vodoni, -OH, Fluoro, okso, R9, R10 i C1-C4alkil opciono supstituisan sa R10;

R7 predstavlja vodoni, -CN, Fluoro, Hloro, Bromo, -CHF<sub>2</sub>, -CF<sub>2</sub>-metil, -CH<sub>2</sub>F, -CF<sub>3</sub>, C1-C3alkil ili C3-C4cikloalkil;

R8 predstavlja 3-7-člani zasićeni prsten koji opciono sadrži jedan ili više heteroatoma, svaki nezavisno odabran iz grupe koju čine O, S i N, takav 3-7-člani zasićeni prsten koji je opciono supstituisan sa jednim ili više C1-C4 alkila opciono supstituisan sa R10;

R9 predstavlja, C1-C4alkiloksi, -SO<sub>2</sub>-metil, -C(=O)-OR<sub>11</sub> ili -C(=O)-N(R<sub>11</sub>)<sub>2</sub>;

R10 predstavlja -CN, -OH, Fluoro, -CHF<sub>2</sub>, -CH<sub>2</sub>F ili -CF<sub>3</sub>;

R11 predstavlja vodoni ili C1-C3alkil;

ili njegova farmaceutski prihvatljiva so ili solvat gde takvo jedinjenje nije

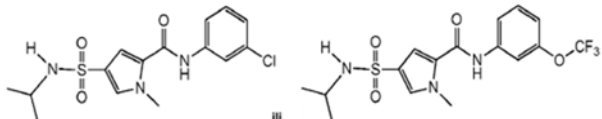

**Patent sadrži još 14 patentnih zahtjeva.**

(11) **03788** (13) **B**

(51) **C07D 487/04**<sup>(2006.01)</sup>

**C07D 519/00**<sup>(2006.01)</sup>

**A61K 31/407**<sup>(2006.01)</sup>

**A61P 7/00**<sup>(2006.01)</sup>

(21) P-2020-90

(22) 04.03.2020

(30) 201762473751P 20.03.2017 US

(96) 18209919.2/04.03.2020

(97) EP 3483164/15.05.2019/2019/20

EP 3483164/04.03.2020/2020/10

(54) me **KOMPOZICIJE PIROLOPIROLA KAO AKTIVATORI PIRUVAT KINAZE (PKR)**  
en **PYRROLOPYRROLE COMPOSITIONS AS PYRUVATE KINASE (PKR) ACTIVATORS**

(73) Forma Therapeutics, Inc.

500 Arsenal St., Suite 100, Watertown, MA 02472/ US

(72) ERICSSON, Anna

500 Arsenal Street Suite 100, Watertown, MA Massachusetts 02472/ US

GREEN, Neal

500 Arsenal Street Suite 100, Watertown, MA Massachusetts 02472 / US

GUSTAFSON, Gary

500 Arsenal Street Suite 100, Watertown, MA Massachusetts 02472/ US

HAN, Bingsong

500 Arsenal Street Suite 100 , Watertown, MA Massachusetts 02472/ US

LANCIA JR., David, R

500 Arsenal Street Suite 100 , Watertown, MA Massachusetts 02472 / US

MITCHELL, Lorna

500 Arsenal Street Suite 100, Watertown, MA Massachusetts 02472 / US

RICHARD, David

500 Arsenal Street Suite 100, Watertown, MA Massachusetts 02472/ US

SHELEKHIN, Tatiana

500 Arsenal Street Suite 100, Watertown, MA Massachusetts 02472/ US

SMITH, Chase C.

500 Arsenal Street Suite 100, Watertown, MA Massachusetts 02472/ US

WANG, Zhongguo

500 Arsenal Street Suite 100, Watertown, MA Massachusetts 02472/ US

ZHENG, Xiaozhang

500 Arsenal Street Suite 100 , Watertown, MA Massachusetts 02472/ US

(74) AOD "LUTOVAC & PARTNERI"

Bulevar Ivana Crnojevića 93 , Podgorica , 81000 / ME

(57)

1. Jedinjenje formule I:

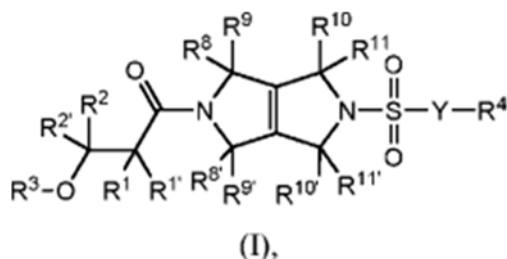

ili njegova farmaceutski prihvatljiva so,  
gde:

Y je veza, -(CR5R5')t-, -NR5(CR5R5')t-, ili -O-;

svaki R1, R1', R2, i R2' je nezavisno -H, -(C1-C6)alkil, -(C2-C6)alkenil, -(C2-C6)alkinil, -(C3-C8)cikloalkil, -(C4-C8)cikloalkenil, heterociklil, aril, heteroaril, halogen, -CN, -OR5, -SR5, -NO2, -NR5R5', -S(O)2R5, -S(O)2NR5R5', -S(O)R5, -S(O)NR5R5', -NR5(O)2R5', -NR5(O)R5', -C(O)R5, ili -C(O)OR5, gde je svaki alkil, alkenil, alkinil, cikloalkil, cikloalkenil, heterociklil, aril, ili heteroaril opciono supstituisan sa jednim ili više supstituenata odabranih iz grupe koja se sastoji od okso, halogen, -CN, -R5, -OR5, -SR5, -NO2, -NR5R5', -S(O)2R5, -S(O)2NR5R5', -S(O)R5, -S(O)NR5R5', NR5(O)2R5', -NR5(O)R5', -C(O)R5, i -C(O)OR5;

ili R1 i R1', ili R2 i R2', zajedno sa atomom za koji su vezani, mogu da se kombinuju da bi formirali -(C3-C8) cikloalkilni prsten, heterocikl, (C5-C8)spirocikl ili 5-do 8-član spiroheterocikl;

ili R1 i R2, zajedno sa atomima za koje su vezani, mogu da se kombinuju da bi formirali-(C3-C8)cikloalkil ili 3-do 8-član heterocikl;

R3 je nezavisno -H, -(C1-C6)alkil, -(C2-C6)alkenil, -(C2-C6)alkinil, -(C3-C8)cikloalkil, -(C4-C8)cikloalkenil, heterociklil, aril, heteroaril, -S(O)2R5, -S(O)2NR5R5', -S(O)R5, -S(O)NR5R5', -C(O)R5, ili -C(O)OR5', gde svaki alkil, alkenil, alkinil, cikloalkil, cikloalkenil, heterociklil, aril, ili heteroaril je opciono supstituisan sa jednim ili više supstituenata odabranih iz grupe koja se sastoji od okso, halogena, -CN, -R5, -OR5, -SR5, -NO2, -NR5R5', -S(O)2R5, -S(O)2NR5R5', -S(O)R5, -S(O)NR5R5', -NR5(O)2R5', -NR5(O)R5', -C(O)R5, i -C(O)OR5;

ili R2 i R3, zajedno sa atomima za koje su vezani, mogu da se kombinuju da bi formirali 5- do 8-član heterociklični prsten;

ili R1 i R3, zajedno sa atomima za koje su vezani, mogu da se kombinuju da bi formirali 5- do 8-član heterociklični prsten, opciono spojen sa aril ili heteroaril prstenom;

R4 je -H, -(C1-C6)alkil, -(C2-C6)alkenil, -(C2-C6)alkinil, -(C3-C8)cikloalkil, -(C4-C8)cikloalkenil, heterociklil, aril, heteroaril, halogen, -CN, -OR5, -SR5, -NO2, -NR5R5', -S(O)2R5, -S(O)2NR5R5', -S(O)R5, -S(O)NR5R5', -NR5(O)2R5', -NR5(O)R5', -C(O)R5, ili -C(O)OR5, gde svaki alkil, alkenil, alkinil, cikloalkil, cikloalkenil, heterociklil, aril, ili heteroaril je opciono supstituisan sa jednim ili više supstituenata odabranih iz grupe koja se sastoji od okso, halogena, -CN, -R5, -OR5, -SR5, -NO2, -NR5R5', -S(O)2R5, -S(O)2NR5R5', -S(O)R5, -S(O)NR5R5', -NR5(O)2R5', -NR5(O)R5', -C(O)R5, i -C(O)OR5;

svaki R5 i R5' je nezavisno, pri svakom pojavljivanju, -H, -(C1-C6)alkil, -(C2-C6)alkenil, -(C2-C6)alkinil, -(C3-C8)cikloalkil, -(C4-C8)cikloalkenil, heterociklil, aril, heteroaril, halogen, -CN, -OR6, -SR6, -NO2, -NR6R6', -S(O)2R6, -S(O)2NR6R6', -S(O)R6, -S(O)NR6R6', -NR6(O)2R6', -NR6(O)R6', -C(O)R6, ili -C(O)OR6, gde svaki alkil, alkenil, alkinil, cikloalkil, cikloalkenil, heterociklil, aril, ili heteroaril je opciono supstituisan sa jednim ili više supstituenata odabranih iz grupe koja se sastoji od okso, halogena, -CN, -R6, -OR6, -SR6, -NO2, -NR6R6', -S(O)2R6, -S(O)2NR6R6', -S(O)R6, -S(O)NR6R6', -NR6(O)2R6', -NR6(O)R6', -C(O)R6, i -C(O)OR6;

ili dva R5 na susednim atomima zajedno sa atomima za koje su vezani obrazuju aril prsten opciono supstituisan sa jednim ili više R6;

ili dva R5 na susednim atomima zajedno sa atomima za koje su vezani obrazuju heteroaril prsten opciono supstituisan sa jednim ili više R6; ili dva R5 na susednim atomima zajedno sa atomima za koje su vezani obrazuju (C3-C8)cikloalkil prsten opciono supstituisan sa jednim ili više R6;

ili dva R5 na susednim atomima zajedno sa atomima za koje su vezani obrazuju heterocikloalkil prsten opciono supstituisan sa jednim ili više R6;

ili dva R5' na susednim atomima zajedno sa atomima za koje su vezani obrazuju aril prsten opciono supstituisan sa jednim ili više R6;

ili dva R5' na susednim atomima zajedno sa atomima za koje su vezani obrazuju heteroaril prsten opciono supstituisan sa jednim ili više R6; ili dva R5' na susednim atomima zajedno sa atomima za koje su vezani obrazuju (C3-C8)cikloalkil prsten opciono supstituisan sa jednim ili više R6;

ili dva R5' na susednim atomima zajedno sa atomima za koje su vezani obrazuju heterocikloalkil prsten opciono supstituisan sa jednim ili više R6;

svaki R6 i R6' je nezavisno, pri svakom pojavljivanju, -H, -(C1-C6)alkil, -(C2-C6)alkenil, -(C2-C6)alkinil, -(C3-C8)cikloalkil, -(C4-C8)cikloalkenil, heterociklil, aril, heteroaril, halogen, -CN, -OR7, -SR7, -NO2, -NR7R7', -S(O)2R7, -S(O)2NR7R7', -S(O)R7, -S(O)NR7R7' -NR7S(O)2R7', -NR7S(O)R7', -C(O)R7, ili -C(O)OR7, gde svaki alkil, alkenil, alkinil, cikloalkil, cikloalkenil, heterociklil, aril, ili heteroaril je opciono supstituisan sa jednim ili više supstituenata odabranih iz grupe koja se sastoji od okso, halogena, -CN, -R7, -OR7, -SR7, -NO2, -NR7R7', -S(O)2R7, -S(O)2NR7R7', -S(O)R7, -S(O)NR7R7', -NR7S(O)2R7', -NR7S(O)R7', -C(O)R7,

i -C(O)OR7;

svaki R7 i R7' je nezavisno, pri svakom pojavljivanju, -H, -(C1-C6)alkil, -(C2-C6)alkenil, -(C2-C6)alkinil, -(C3-C8)cikloalkil, -(C4-C8)cikloalkenil, heterociklil, aril, heteroaril, halogen, -CN, -OH, -SH, -NO2, -NH2, -S(O)2H, -S(O)2NH2, -S(O)H, -S(O)NH2, -NHS(O)2H, -NHS(O)H, -C(O)H, ili -C(O)OH, gde svaki alkil, alkenil, alkinil, cikloalkil, cikloalkenil, heterociklil, aril, ili heteroaril je opciono supstituisan sa jednim ili više supstituenata odabranih iz grupe koja se sastoji od okso, halogena, -CN, -OH, -SH, -NO2, -NH2, -S(O)2H, -S(O)2NH2, -S(O)H, -S(O)NH2, -NHS(O)2H, -NHS(O)H, -C(O)H, i -C(O)OH;

svaki R8, R8', R9, R9', R10, R10', R11, i R11' je nezavisno, pri svakom pojavljivanju, -H, -(C1-C6)alkil, -(C2-C6)alkenil, -(C2-C6)alkinil, -(C3-C8)cikloalkil, ili -(C4-C8)cikloalkenil, gde svaki alkil, alkenil, alkinil, cikloalkil i cikloalkenil, je opciono supstituisan sa jednim ili više supstituenata odabranih iz grupe koja se sastoji od okso, halogena, -CN, -R7, -OR7, -SR7, -NO2, -NR7R7', -S(O)2R7, -S(O)2NR7R7', -S(O)R7, -S(O)NR7R7', -NR7S(O)2R7', -NR7S(O)R7', -C(O)R7, i -C(O)OR7;

i

t je 0, 1, 2, ili 3.

**Patent sadrži još 15 patentnih zahtjeva.**

(11) **03743** (13) **B**

(51) **C07D487/04**<sup>(2006.01)</sup>

**A61P37/02**<sup>(2006.01)</sup>

**A61P25/28**<sup>(2006.01)</sup>

**A61K31/4985**<sup>(2006.01)</sup>

**A61P29/00**<sup>(2006.01)</sup>

(21) P-2020-97

(22) 10.02.2017

(30) 201662299130P 24.02.2016 US

(96) 17705705.6/10.02.2017

(86) WO PCT/IB2017/050748/10.02.2017

(87) WO 2017/144995 A1/31.08.2017/2017/35

(97) EP 3419978/02.01.2019/2019/01

EP 3419978/15.04.2020/2020/16

(54) me **DERIVATI PIRAZOLO[1,5-A]PIRAZIN-4-ILA KAO INHIBITORI JAK**  
en **PYRAZOLO[1,5-A]PYRAZIN-4-YL DERIVATIVES AS JAK-INHIBITORS**

(73) Pfizer Inc.

235 East 42nd Street, New York, NY 10017/ US

(72) BROWN, Matthew Frank

443 Wheeler Road, Stonington , Connecticut 06378 ,/ US

DERMENCI, Alpay

9 Peach Lane, East Lyme, Connecticut 06333/ US

FENSOME, Andrew

260 Bolton Road, Harvard, Massachusetts 01451 / US

GERSTENBERGER, Brian Stephen

210 Winthrop Road 9, Brookline, Massachusetts 02445/ US

HAYWARD, Matthew Merrill

3 Pyrus Court, Old Lyme, Connecticut 06371/ US

OWEN, Dafydd Rhys

98 Peter Bulkeley Road, Concord, Massachusetts 01742/ US

WRIGHT, Stephen Wayne

1 Whitman Lane, Old Lyme, Connecticut 06371/ US

XING, Li Huang

8 Great Rock Road, Lexington, Massachusetts 02421/ US

YANG, Xiaojing

18 Maple Terrace, Waterford, Connecticut 06385/ US

(57)

1. Postupak za proizvodnju obloženog ambalažnog materijala (10), koji obuhvata najmanje faze:

a) obezbeđivanja supstrata (12) koji ima osnovni materijal (14) od celuloze, spoljašnjost (16) udaljenu od robe koja se pakuje kao i unutrašnjost (18) okrenutu prema robi koja se pakuje, pri čemu je osnovni materijal obložen ili neobložen papir, obložen ili neobložen karton, ili obložen ili neobložen jednoslojni karton;

b) oblaganja unutrašnjosti (18) supstrata najmanje jednim slojem vodene kompozicije koja uključuje najmanje polivinil alkohol i agens za umrežavanje i koja ima čvrsti sadržaj od najviše 25 mas.%, pri čemu se kao agens za umrežavanje koristi najmanje jedan alkil ortosilikat i/ili najmanje jedno olefinski zasićeno i/ili nezasićeno bi-, tri- ili multifunkcionalno jedinjenje, koje može reagovati sa hidroksi grupama polivinil alkohola i uključuje najmanje dve funkcionalne grupe odabrane od karboksilne kiseline i anhidrida kiseline;

c) sušenja sloja i umrežavanja polivinil alkohola pomoću agensa za umrežavanje sa formiranjem zaprečnog sloja (22a, 22b) za hidrofobna jedinjenja.

**Patent sadrži još 14 patentnih zahtjeva.**

(11) **03744** (13) **B**

(51) **C07D 405/06**<sup>(2006.01)</sup>

**A61P 35/00**<sup>(2006.01)</sup>

**A61K 31/4045**<sup>(2006.01)</sup>

(21) P-2020-98

(22) 31.05.2017

(30) 201662348457 P 10.06.2016 US

(96) 17728990.7/31.05.2017

(86) US PCT/US2017/035097/31.05.2017

(87) WO 2017/213919/14.12.2017/2017/50

(97) EP 3468965/17.04.2019/2019/16

EP 3468965/29.04.2020/2020/18

(54) me **SPOJEVI 1-TETRAHIDROPIRANILKARBONIL-2,3- DIHIDRO-1H-INDOLA, NAMIJENJENI LIJEČENJU RAKA**

en **1-TETRAHYDROPYRANYLCARBONYL-2,3-DIHYDRO-1H-INDOLE COMPOUNDS FOR TREATING CANCER**

(73) ELI LILLY AND COMPANY

Lilly Corporate Center, Indianapolis, IN 46285/ US

(72) BASTIAN, Jolie Anne

P.O. Box 6288, Indianapolis Indiana 46206-6288/ US

CHEN, Jiehao

P.O. Box 6288, Indianapolis Indiana 46206-6288/ US

COHEN, Jeffrey Daniel

P.O. Box 6288, Indianapolis Indiana 46206-6288/ US

HENRY, James Robert

P.O. Box 6288, Indianapolis Indiana 46206-6288/ US

MCMILLEN, William Thomas

P.O. Box 6288, Indianapolis Indiana 46206-6288/ US

REAMAN, Bradley Earl

P.O. Box 6288, Indianapolis Indiana 46206-6288/ US

RUBIO, Almudena

P.O. Box 6288, Indianapolis Indiana 46206-6288/ US

SALL, Daniel Jon

P.O. Box 6288, Indianapolis Indiana 46206-6288/ US

ZHAO, Gaiying

P.O. Box 6288, Indianapolis Indiana 46206-6288/ US

(57)

1. Spoj formule:

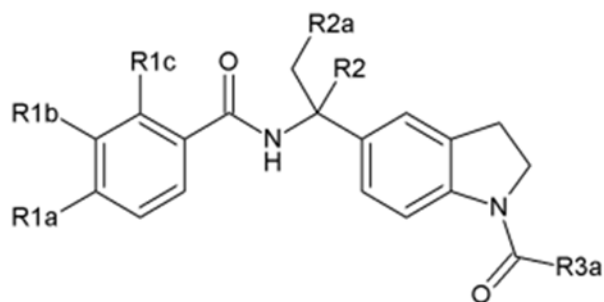



**naznačen time** što:

R1a je vodik, metil, etenil, cijano, fluor, klor, fluormetil ili difluormetil;

R1b je vodik, fluor ili klor;

R1c je vodik, hidroksi, fluor, benziloksi ili hidroksietilamino;

R2 je vodik ili metil;

R2a je vodik ili metil; i

R3a je tetrahidropirasil.

**Patent sadrži još 9 patentnih zahtjeva.**

**OBJAVA UPISA PROMJENA**  
**Publication of record of changes**

P-2008-503 (00282)	KRAUSE-RÖHM-SYSTEME AG, Postfach 40 14 66, 80714 München, Njemačka	EuroAtlantic Capital LLC, 1201 Orange Street, Wilmington, Delaware 19801, Sjedinjene Američke Države	Prenos prava
P-2010-182 (01123)	Repros Therapeutics Inc., 5 Giralda Farms, Madison, NJ 07940, United States	Allergan Pharmaceuticals International Limited, Clonshaugh Business & Technology Park, Coolock, D17 E400, Dublin, Ireland.	Prenos prava
P-2010-182 (01123)	Repros Therapeutics Inc., Timberloch Place, Suite B-7, The Woodlands TX 77380, US	Repros Therapeutics Inc., 5 Giralda Farms, Madison, NJ 07940, United States.	Promjena adrese
P-2011-91 (01299)	EURO-CELTIQUE S.A., 2, avenue Charles de Gaulle, 1653 Luxembourg, LU	EURO-CELTIQUE S.A., 1, rue Jean Piret, 2350 Luxembourg, LU	Promjena adrese
P-2014-48 (01828)	Alexion Pharmaceuticals, Inc., 352 Knotter Drive, Cheshire, Connecticut 06410, US	Alexion Pharmaceuticals, Inc., 121 Seaport Boulevard, Boston, MA 02210, USA	Prenos adrese
P-2016-250 (02584)	Shire Viropharma Incorporated, 300 Shire Way, Lexington, MA 02421, US	Shire Viropharma LLC, 300 Shire Way, Lexington, MA 02421, US	Promjena imena
P-2017-146 (02734)	Ganymed Pharmaceuticals GmbH, An der Goldgrube 12, 55131 Mainz, Germany	Astellas Pharma Inc., 5-1, Nihonbashi-Honcho 2-Chome, Chuo-ku, Tokyo 103-8411, Japan	Promjena imena
P-2017-182 (02865)	Shire Viropharma Incorporated, 300 Shire Way, Lexington, MA 02421, US	Shire Viropharma LLC, 300 Shire Way, Lexington, MA 02421, US	Promjena imena
P-2018-96 (03033)	Nearmedic International Limited, Abacus Elenion Building, 5 Themistocles Dervis St., Nicosia, Kipar	NEWALR&D Ltd, 71-75 Shelton Street, Covent Garden, London, WC2H 9JQ, Ujedinjeno Kraljevstvo	Prenos prava
P-2019-31 (03318)	Shire Viropharma Incorporated, 300 Shire Way, Lexington, MA 02421, US	Shire Viropharma LLC, 300 Shire Way, Lexington, MA 02421, US	Promjena imena
P-2019-45 (03326)	Shire Viropharma Incorporated, 300 Shire Way, Lexington, MA 02421, US	Shire Viropharma LLC, 300 Shire Way, Lexington, MA 02421, US	Promjena imena

## OBJAVA ZAHTJEVA ZA PROŠIRENJE EVROPSKIH PRIJAVA PATENATA

### Publication of request for the extension of the effects of european patent applications

(51) MKP  
**A61K 9/20 2006 (97) EP 3162362**  
**A61K 9/28 2006**  
**A61K 31/606 2006**

(96) EP 15192269.7 10/30/2015  
(97) EP 3162362, 1/13/2021 202102, de  
(54) OPTIMIZED HIGH-DOSE TABLET OF MESALAZINE  
(72) WILHELM, Rudolf, Feuerkirshenweg 2a, 74676 Bischweier, DE  
PRÖLS, Markus, Johann-von-Weerth-Str. 11, 79100 Freiburg/Breisgau, DE  
GREINWALD, Roland, Jakob-Otter-Strasse 2., 79341 Kenzingen, DE  
NACAK, Tanju, Waldstr. 9, 79288 Gottenheim, DE

(51) MKP  
**A61B 18/00 2006 (97) EP 3153124**  
**A61B 18/02 2006**  
**A61B 18/14 2006**

(96) EP 16192751.2 10/7/2016  
(97) EP 3153124, 1/20/2021 202103, en  
(31) 201514878671 (32) 08.10.2015 (33) US

(54) CATHETER WITH MEMBRANED SPINES FOR PULMONARY VEIN ISOLATION  
(72) BASU, Shubhayu, 15715 Arrow Highway, Irwindale, CA California 91706, US  
MIN, Sungwoo, 15715 Arrow Highway, Irwindale, CA California 91706, US

(51) MKP  
**A23L 2/52 2006 (97) EP 3250052**  
**A23L 2/60 2006**  
**A23L 27/12 2016**

(96) EP 16702368.8 1/26/2016  
(97) EP 3250052, 3/3/2021 202109, en  
(31) 201500903 (32) 27.01.2015 (33) TR  
201502736 06.03.2015 TR  
201503546 24.03.2015 TR

(54) A NATURAL SWEETENING COMPOSITION OF LUO HAN GUO  
(72) TOKSÖZ, Ahmet, Montero Gida Sanayi Ve Ticaret A.s. Balabandere Cad. Ilac Sanayi Yolu No: 14 Istinye, 34460 Istanbul, TR  
TOKSÖZ, Zafer, Montero Gida Sanayi Ve Ticaret A.s. Balabandere Cad. Ilac Sanayi Yolu No: 14 Istinye, 34460 Istanbul, TR  
MUTLU, Onur, Montero Gida Sanayi Ve Ticaret A.s. Balabandere Cad. Ilac Sanayi Yolu No: 14 Istinye, 34460 Istanbul, TR  
TÜRKYILMAZ, Ali, Montero Gida Sanayi Ve Ticaret A.s. Balabandere Cad. Ilac Sanayi Yolu No: 14 Istinye, 34460 Istanbul, TR  
YELKEN, Gülay, Montero Gida Sanayi Ve Ticaret A.s. Balabandere Cad. Ilac Sanayi Yolu No: 14 Istinye, 34460 Istanbul, TR  
ZAN, Merve, Montero Gida Sanayi Ve Ticaret A.s. Balabandere Cad. Ilac Sanayi Yolu No: 14 Istinye, 34460 Istanbul, TR

(51) MKP  
**A23L 2/52 2006 (97) EP 3250053**  
**A23L 2/60 2006**  
**A23L 27/12 2016**

(96) EP 16702370.4 1/26/2016  
(97) EP 3250053, 3/3/2021 202109, en  
(31) 201500903 (32) 27.01.2015 (33) TR  
201503546 24.03.2015 TR  
201503923 31.03.2015 TR

(54) A Natural Sweetener  
(72) TOKSÖZ, Ahmet, Montero Gida Sanayi VE Ticaret A.S. Balabandere Cad. Ilac Sanayi Yolu No: 14 Istinye, 34460 Istanbul, TR  
TOKSÖZ, Zafer, Montero Gida Sanayi VE Ticaret A.S. Balabandere Cad. Ilac Sanayi Yolu No: 14 Istinye, 34460 Istanbul, TR  
MUTLU, Onur, Montero Gida Sanayi VE Ticaret A.S. Balabandere Cad. Ilac Sanayi Yolu No: 14 Istinye, 34460 Istanbul, TR  
TÜRKYILMAZ, Ali, Montero Gida Sanayi VE Ticaret A.S. Balabandere Cad. Ilac Sanayi Yolu No: 14 Istinye, 34460 Istanbul, TR

YELKEN, Gülay, Montero Gida Sanayi VE Ticaret A.S. Balabandere Cad. Ilac Sanayi Yolu No: 14 Istinye, 34460 Istanbul, TR  
 ZAN, Merve, Montero Gida Sanayi VE Ticaret A.S. Balabandere Cad. Ilac Sanayi Yolu No: 14 Istinye, 34460 Istanbul, TR

- (51) MKP  
**G10K 11/178 2006 (97) EP 3644620**  
**H04R 2006**  
**H04R 1/10 2006**  
**H04R 1/28 2006**  
 (96) EP 18193193.2 9/7/2018  
 (97) EP 3644620, 3/10/2021 202110, de  
 (54) IN-EAR ANC EARPHONE  
 (72) PERKMANN, Michael, Markgraf-Rüdiger-Strasse 7/71, 1150 Wien, AT  
 WÖHRER, Daniel, Wohlmuttgasse 13, 3003 Gablitz, AT

- (51) MKP  
**A61K 39/395 2006 (97) EP 3679949**  
**A61P 19/02 2006**  
**A61P 29/00 2006**  
**C07K 16/28 2006**  
**C12Q 1/48 2006**  
**G01N 33/564 2006**  
 (96) EP 19151799.4 8/30/2013  
 (97) EP 3679949, 2/24/2021 202108, en  
 (31) 201261695641 P (32) 31.08.2012 (33) US  
 201361767989 P 22.02.2013 US  
 201361778706 P 13.03.2013 US  
 (54) METHODS OF TREATING CONDITIONS WITH ANTIBODIES THAT BIND COLONY STIMULATING FACTOR 1 RECEPTOR (CSF1R)  
 (72) WONG, Brian, Five Prime Therapeutics, Inc. 111 Oyster Point Boulevard, South San Francisco, CA 94080, US  
 MASTELLER, Emma, Five Prime Therapeutics, Inc. 111 Oyster Point Boulevard, South San Francisco, CA 94080, US  
 REEDQUIST, Kris, Five Prime Therapeutics, Inc. 111 Oyster Point Boulevard, South San Francisco, CA 94080, US  
 ZANGHI, James Allen, Five Prime Therapeutics, Inc. 111 Oyster Point Boulevard, South San Francisco, CA 94080, US  
 HAMBLETON, Julie, Five Prime Therapeutics, Inc. 111 Oyster Point Boulevard, South San Francisco, CA 94080, US  
 BAKER, Kevin, Five Prime Therapeutics, Inc. 111 Oyster Point Boulevard, South San Francisco, CA 94080, US

- (51) MKP  
**F25D 3/12 2006 (97) EP 3686524**  
**F25D 11/00 2006**  
**F25D 17/06 2006**  
**F25D 29/00 2006**  
 (96) EP 19153888.3 1/28/2019  
 (97) EP 3686524, 3/10/2021 202110, en  
 (54) COOLING SYSTEM FOR STORING AND COOLING PRODUCTS DURING TRANSPORT ON A REFRIGERATED TRANSPORT VEHICLE  
 (71) Frappa, BP 2 - 132 rue de Soras, 07430 Davezieux, FR  
 (72) Tebib, Emir, 17 rue Jean Jaures, 60330 Le Plessis Belleville, FR  
 Beil, Denis, Robert-Koch-Straße 10, 53859 Niederkassel, DE  
 Gockel, Frank, Schubertstraße 44, 42553 Velbert, DE  
 Blauvac, Germain, 132 rue de Soras, 07430 Davezieux, FR  
 Antoye, Rémi, 132 rue de Soras, 07430 DAVEZIEUX, FR

- (51) MKP  
**A61K 39/395 2006 (97) EP 3536342**  
**A61P 31/16 2006**  
 (96) EP 19155349.4 4/15/2013  
 (97) EP 3536342, 3/3/2021 202109, en  
 (31) 201261624519 P (32) 16.04.2012 (33) US  
 201361759469 P 01.02.2013 US  
 (54) METHODS FOR TREATING OR PREVENTING INFLUENZA VIRUS INFECTION BY ADMINISTERING A SERINE PROTEASE INHIBITOR  
 (72) PURCELL NGAMBO, Lisa, c/o Regeneron Pharmaceuticals, Inc. 777 Old Saw Mill River Road, Tarrytown, NY 10591, US

- (51) MKP  
**F17C 6/00 2006 (97) EP 3693652**  
 (96) EP 19155865.9 2/7/2019

- (97) EP 3693652, 3/24/2021 202112, de  
 (54) FILLING STATION FOR GAS BOTTLES AND MOTOR VEHICLES  
 (72) Tilhof, Eckhard, Churerstrasse 31, 8852 Altendorf, CH

- (51) MKP  
**A01H 5/06 2018 (97) EP 3696188**  
**A01H 6/02 2018**  
**C07K 14/415 2006**  
**C12N 15/82 2006**
- (96) EP 19157888.9 2/18/2019  
 (97) EP 3696188, 3/24/2021 202112, en  
 (54) GENE FOR RESISTANCE TO PLANT DISEASE  
 (72) TÖRJÉK, Ottó, Bismarckstraße 10, 37574 Einbeck, DE  
 BORCHARDT, Dietrich, Oehlmannstraße 4, 37574 Einbeck, DE  
 REKOSKE, Margaret, c/o Betaseed Inc 1325 Marschall Road, Shakopee, MN, 55379, US  
 MECHHELKE, Wolfgang, Alter Stadtweg 3, 37574 Einbeck, DE  
 LEIN, Jens Christoph, Schlesiering 40, 37085 Göttingen, DE  
 SCHULZ, Britta, An der Hechel 10, 37574 Einbeck, DE

- (51) MKP  
**A01K 67/027 2006 (97) EP 3629719**  
**C12N 9/02 2006**  
**C12N 15/10 2006**  
**C12N 15/90 2006**
- (96) EP 18733952.8 5/24/2018  
 (97) EP 3629719, 1/20/2021 202103, en  
 (31) 201762510921 P (32) 25.05.2017 (33) US  
 (54) METHODS FOR GENDER DETERMINATION OF AVIAN EMBRYOS IN UNHATCHED EGGS AND MEANS THEREOF  
 (71) Eggxyt Ltd, Keren HaYessod 36, 9100760 Jerusalem, IL  
 (72) OFFEN, Daniel, 10 Hayeshiva St., 3895500 Kfar HaRoe, IL

- (51) MKP  
**A61K 9/16 2006 (97) EP 3761965**  
**A61K 9/20 2006**
- (96) EP 18711270.1 3/8/2018  
 (97) EP 3761965, 1/13/2021 202102, en  
 (54) TICAGRELOR-CONTAINING TABLET FORMULATION  
 (71) Pharmaceutical Oriented Services Ltd, Lesvou str. (end) Thesi Loggos Industrial Zone, 14452 Metamorfossi Attikis, GR  
 Rontis Hellas S.A., 38, Sorou Street, 151 25 Marousi Athens, GR  
 (72) PANAGOPOULOS, Panagiotis, Lesvou str. (end) Thesi Loggos Industrial Zone, 14452 Metamorfossi Attikis, GR  
 PANITSAS, Konstantinos-Emmanouil, Lesvou str. (end) Thesi Loggos Industrial Zone, 14452 Metamorfossi Attikis, GR  
 KOMPOROZOS, Konstantinos, Lesvou str. (end) Thesi Loggos Industrial Zone, 14452 Metamorfossi Attikis, GR  
 KANTAS, Dimosthenis, Lesvou str. (end) Thesi Loggos Industrial Zone, 14452 Metamorfossi Attikis, GR  
 GEORGAKAKOU, Sofia, Lesvou str. (end) Thesi Loggos Industrial Zone, 14452 Metamorfossi Attikis, GR  
 PARELI, Ioanna, Lesvou str. (end) Thesi Loggos Industrial Zone, 14452 Metamorfossi Attikis, GR

- (51) MKP  
**C02F 1/34 2006 (97) EP 3762336**
- (96) EP 18769472.4 7/30/2018  
 (97) EP 3762336, 1/13/2021 202102, en  
 (31) 1800081 (32) 06.03.2018 (33) HU  
 (54) METHOD FOR THE CAVITATION CLEANING OF WATER-BASED SUBSTANCES AND EQUIPMENT FOR THE IMPLEMENTATION OF THE METHOD  
 (71) Celltech-Paper Kft., Patak u. 21, 9400 Opron, HU  
 (72) CSÓKA, Levente, Patak u. 21. H-9400, Sopron, HU  
 DÓKA, Gábor, Sarudi utca 23. H-9400, Sopron, HU  
 KOLONICS, Ottó, Ötvös utca 19. H-9400, Sopron, HU

- (51) MKP  
**E21B 7/04 2006 (97) EP 3781777**  
**E21B 7/06 2006**
- (96) EP 18773259.9 8/27/2018

(97) EP 3781777, 2/24/2021 202108, en  
 (31) 201815971701 (32) 04.05.2018 (33) US  
 (54) MONITORING OPERATING CONDITIONS OF A ROTARY STEERABLE SYSTEM  
 (72) SEHSAH, Ossama R., C-137-6D, DTD, Building 3194, Dhahran, SA  
 ALKHOWAILDI, Mohammed A., PO Box 2752 Saudi Aramco, Dhahran 31311, SA

---

(51) MKP  
**E21B 23/04 2006 (97) EP 3794210**  
**E21B 43/10 2006**  
 (96) EP 18773260.7 8/27/2018  
 (97) EP 3794210, 3/24/2021 202112, en  
 (31) 201816021811 (32) 28.06.2018 (33) US  
 (54) LINER HANGER SYSTEM  
 (72) ALI, Syed Muhammad, CU-247-A, West Admin Building 991, Abqaiq, SA  
 ZIA, Yassar Kamal, CU-247-A, West Admin Building 991, Abqaiq, SA

---

(51) MKP  
**E21B 33/12 2006 (97) EP 3781781**  
**E21B 33/122 2006**  
**E21B 33/124 2006**  
**E21B 37/02 2006**  
**E21B 49/00 2006**  
 (96) EP 18773262.3 8/27/2018  
 (97) EP 3781781, 2/24/2021 202108, en  
 (31) 201815956832 (32) 19.04.2018 (33) US  
 (54) TOOL FOR TESTING WITHIN A WELLBORE  
 (72) EGBE, Peter Ido, CU-248 E, Floor 2, Bldg 991, Abqaiq, SA  
 SEHSAH, Ossama R., C-137-6D, DTD, Building 3194, Dhahran, SA

---

(51) MKP  
**F23B 80/04 2006 (97) EP 3765791**  
**F23G 5/027 2006**  
**F23G 5/16 2006**  
 (96) EP 18773276.3 8/23/2018  
 (97) EP 3765791, 1/20/2021 202103, en  
 (54) PROCESS AND DEVICE FOR IMPROVING OF SYNTHESIS AND/OR FLUE GAS VELOCITY FIELD FOR REFUSE DERIVED FUEL APPLICATIONS  
 (71) Kreca, Ivo, Zajasovnik-del 13, 3305 Vransko, SI  
 (72) Kreca, Ivo, Zajasovnik-del 13, 3305 Vransko, SI

---

(51) MKP  
**E21B 43/12 2006 (97) EP 3781782**  
**E21B 43/14 2006**  
**E21B 43/32 2006**  
**E21B 47/10 2012**  
**E21B 47/12 2012**  
 (96) EP 18773627.7 8/27/2018  
 (97) EP 3781782, 2/24/2021 202108, en  
 (31) 201816004965 (32) 11.06.2018 (33) US  
 (54) CONTROLLING WATER INFLOW IN A WELLBORE  
 (72) EGBE, Peter Ido, CU-248 E, Floor 2, Bldg 991, Abqaiq, SA  
 ALSHURAIM, Fawaz Musaad, CU-249 A, Floor 2, Bldg 991, Abqaiq, SA

---

(51) MKP  
**A61K 38/18 2006 (97) EP 3586867**  
**A61P 21/00 2006**  
**C07K 14/515 2006**  
 (96) EP 19168205.3 1/28/2014  
 (97) EP 3586867, 2/24/2021 202108, en  
 (31) 201361757569 P (32) 28.01.2013 (33) US  
 (54) PLACENTA GROWTH FACTOR IN TREATING DUCHENNE MUSCULAR DYSTROPHY

(72) NORTON, Angela, c/o Shire Human Genetic Therapies INC. 300 Shire Way, Lexington, MA Massachusetts 02421, US  
 CONCINO, Michael F., c/o Shire Human Genetic Therapies INC. 300 Shire Way, Lexington, MA Massachusetts 02421, US  
 MEIYAPPAN, Muthuraman, c/o Shire Human Genetic Therapies INC. 300 Shire Way, Lexington, MA Massachusetts 02421, US  
 ISKENDERIAN, Andrea, c/o Shire Human Genetic Therapies INC. 300 Shire Way, Lexington, MA Massachusetts 02421, US

---

(51) MKP  
**C12Q 1/6855 2018 (97) EP 3631012**

(96) EP 18731697.1 5/25/2018  
 (97) EP 3631012, 1/13/2021 202102, en  
 (31) 201762511949 P (32) 26.05.2017 (33) US

(54) HIGH-THROUGHPUT POLYNUCLEOTIDE LIBRARY SEQUENCING AND TRANSCRIPTOME ANALYSIS  
 (71) AbVitro LLC, 251 Little Falls Drive, Wilmington, DE 19808, US  
 (72) GOLDFLESS, Stephen Jacob, 400 Dexter Ave, N, Suite 1200,, Seattle, Washington 98109, US  
 BRIGGS, Adrian Wrangham, 400 Dexter Ave, N, Suite 1200,, Seattle, Washington 98109, US  
 CHARI, Rajagopal, 400 Dexter Ave, N, Suite 1200,, Seattle, Washington 98109, US  
 JIANG, Yue, 400 Dexter Ave, N, Suite 1200,, Seattle, Washington 98109, US  
 HAUSE, Ronald, 400 Dexter Ave, N, Suite 1200,, Seattle, Washington 98109, US  
 VIGNEAULT, François, 400 Dexter Ave, N, Suite 1200,, Seattle, Washington 98109, US

---

(51) MKP  
**E21B 7/14 2006 (97) EP 3794211**  
**E21B 7/15 2006**  
**E21B 43/11 2006**

(96) EP 18792498.0 9/28/2018  
 (97) EP 3794211, 3/24/2021 202112, en  
 (31) 201815982398 (32) 17.05.2018 (33) US

(54) LASER TOOL  
 (72) BATARSEH, Sameeh Issa, P.O. Box 9522, Dhahran, 31311, SA

---

(51) MKP  
**B65G 5/00 2006 (97) EP 3797080**  
**E21B 43/12 2006**

(96) EP 18792512.8 10/2/2018  
 (97) EP 3797080, 3/31/2021 202113, en  
 (31) 201816037023 (32) 17.07.2018 (33) US

(54) MANAGING STORAGE OF WATER  
 (72) AZZOUNI, Suliman M., C-137-6D, DTD, Building 3194, Dhahran, SA

---

(51) MKP  
**E21B 43/26 2006 (97) EP 3797209**

(96) EP 18796123.0 10/9/2018  
 (97) EP 3797209, 3/31/2021 202113, en  
 (31) 201816130140 (32) 13.09.2018 (33) US

(54) DOWNHOLE TOOL FOR FRACTURING A FORMATION CONTAINING HYDROCARBONS  
 (72) BATARSEH, Sameeh Issa, P.O. Box 9522, Dhahran 31311, SA  
 OTHMAN, Haitham A., P.O. Box 10400, Dhahran 31311, SA

---

(51) MKP  
**B64C 39/02 2006 (97) EP 3770066**

(96) EP 19188376.8 7/25/2019  
 (97) EP 3770066, 1/27/2021 202104, de  
 (54) DRONE FOR LOW-NOISE DELIVERY OF OBJECTS  
 (71) DELIVERY EAGLE AG, Industriering 3, 9491 Ruggell, LI  
 (72) Weirather, Herbert, Industriering 3, 9491 Ruggell, LI

---

(51) MKP  
**A01N 1/02 2006 (97) EP 3775165**  
**A61K 35/17 2015**  
**C12M 3/00 2006**  
**C12N 5/0783 2010**

(96) EP 18745741.1 6/29/2018  
 (97) EP 3775165, 3/24/2021 202112, en  
 (31) 201815940901 (32) 29.03.2018 (33) US  
 (54) PROCESSES FOR PRODUCTION OF TUMOR INFILTRATING LYMPHOCYTES AND USES OF SAME IN IMMUNOTHERAPY  
 (72) WARDELL, Seth, c/o Iovance Biotherapeutics, Inc. 999 Skyway Road Suite 150, San Carlos CA 94070, US  
 BENDER, James, 3 Cloverdale, Rancho Santa Margarita, CA 92688, US

---

(51) MKP  
**C25B 1/04 2006 (97) EP 3699322**  
**C25B 9/06 2006**  
**C25B 11/02 2006**  
**C25B 15/08 2006**  
**F02B 43/10 2006**  
**F02M 25/12 2006**  
 (96) EP 19158862.3 2/22/2019  
 (97) EP 3699322, 4/7/2021 202114, de  
 (54) ELECTROLYTIC CELL  
 (71) Glöck Ökeenergie, Bengerstraße 1, 9112 Griffen, AT  
 (72) Glock, Gaston, Klagenfurter Str. 32a, 9220 Velden, AT

---

(51) MKP  
**G08B 5/36 2006 (97) EP 3534343**  
**G08B 5/38 2006**  
 (96) EP 19159767.3 2/27/2019  
 (97) EP 3534343, 1/20/2021 202103, en  
 (31) 201800003126 (32) 28.02.2018 (33) IT  
 (54) LIGHT SIGNALING DEVICE APPLICABLE TO ACCESS PASSAGES  
 (71) Came Go S.r.l., Zona Industriale Nord Settore, D/62, 33097 Spilimbergo (PN), IT  
 (72) TONA, Paolino, Via Don Tita del Rizzo, 11, 33082 Azzano Decimo (PN), IT

---

(51) MKP  
**A61K 39/40 2006 (97) EP 3617227**  
**A61P 31/04 2006**  
**C07K 16/12 2006**  
 (96) EP 19160911.4 9/10/2012  
 (97) EP 3617227, 1/13/2021 202102, en  
 (31) 201161535532 P (32) 16.09.2011 (33) US  
 201261638731 P 26.04.2012 US  
 (54) NEUTRALISING ANTIBODIES TO THE MAJOR EXOTOXIN TCDA OF CLOSTRIDIUM DIFFICILE  
 (72) HUMPHREYS, David Paul, UCB Celltech, c/o IPD 208 Bath Road, Slough, Berkshire SL1 3WE, GB  
 LIGHTWOOD, Daniel John, UCB Celltech, c/o IPD 208 Bath Road, Slough, Berkshire SL1 3WE, GB  
 TYSON, Kerry Louise, UCB Celltech, c/o IPD 208 Bath Road, Slough, Berkshire SL1 3WE, GB  
 KNIGHT, David Edward Ormonde, UCB Celltech, c/o IPD 208 Bath Road, Slough, Berkshire SL1 3WE, GB  
 HERVÉ, Karine Jeannine Madeleine, UCB Celltech, c/o IPD 208 Bath Road, Slough, Berkshire SL1 3WE, GB  
 COMPSON, Joanne Elizabeth, UCB Celltech, c/o IPD 208 Bath Road, Slough, Berkshire SL1 3WE, GB  
 PAGE, Matthew Jon Timothy, UCB Celltech, c/o IPD 208 Bath Road, Slough, Berkshire SL1 3WE, GB  
 PAYNE, Andrew Charles, UCB Celltech, c/o IPD 208 Bath Road, Slough, Berkshire SL1 3WE, GB  
 FISHER, Nicola Louise, UCB Celltech, c/o IPD 208 Bath Road, Slough, Berkshire SL1 3WE, GB  
 MACKENZIE, Brendon, UCB Celltech, c/o IPD 208 Bath Road, Slough, Berkshire SL1 3WE, GB  
 COX, Matthew, UCB Celltech, c/o IPD 208 Bath Road, Slough, Berkshire SL1 3WE, GB

---

(51) MKP  
**A61P 3/06 2006 (97) EP 3536712**  
**C07K 16/40 2006**  
 (96) EP 19162319.8 9/12/2012  
 (97) EP 3536712, 1/20/2021 202103, en  
 (31) 201161535392 P (32) 16.09.2011 (33) US  
 201161559162 P 14.11.2011 US  
 201261641321 P 02.05.2012 US  
 (54) METHODS FOR REDUCING LIPOPROTEIN(A) LEVELS BY ADMINISTERING AN INHIBITOR OF PROPROTEIN CONVERTASE SUBTILISIN  
 KEXIN-9 (PCSK9)  
 (72) SWERGOLD,, Gary, 75 Sheldrake Place, New Rochelle, NY 10804, US



(51) MKP  
**B61L 23/04 2006 (97) EP 3708990**  
**G01L 1/24 2006**  
**G01L 19/06 2006**  
**G01M 5/00 2006**  
(96) EP 19162729.8 3/14/2019  
(97) EP 3708990, 4/7/2021 202114, en  
(54) FIBER OPTIC SENSOR UNIT, OPTICAL MEASURING SYSTEM, AXLE-COUNTING DEVICE AXLE-COUNTING METHOD  
(72) Linsdall, David, Linkwood Road 2 B, SL 1 8 AT Burnham, GB  
Klemm, Rainer, Von-Weber-Str. 27, 71711 Steinheim, DE  
Föller, Scarlett, Chirstophallee 22a, 75177 Pforzheim, DE  
Heyder, Matthias, Am Teichdamme 28, 99428 Weimar, DE  
Naumovski, Petar, Knollstrasse 44, 70191 Stuttgart, DE

(51) MKP  
**E21B 36/00 2006 (97) EP 3788231**  
**E21B 43/26 2006**  
(96) EP 18783133.4 9/21/2018  
(97) EP 3788231, 3/10/2021 202110, en  
(31) 201815970604 (32) 03.05.2018 (33) US  
(54) CREATING FRACTURES IN A FORMATION USING ELECTROMAGNETIC SIGNALS  
(72) OTHMAN, Haitham A., P.O. Box 10400 Saudi Aramco, Dhahran 31311, SA  
BATARSEH, Sameeh Issa, P.O. Box 9522, Dhahran 31311, SA

(51) MKP  
**E21B 28/00 2006 (97) EP 3797206**  
**E21B 43/00 2006**  
**E21B 43/11 2006**  
**E21B 43/26 2006**  
(96) EP 18785772.7 9/21/2018  
(97) EP 3797206, 3/31/2021 202113, en  
(31) 201862711237 P (32) 27.07.2018 (33) US  
(54) LASER-INDUCED PLASMA TOOL  
(72) SAN ROMAN ALERIGI, Damian Pablo, P.O. 11740, Dhahran, 31311, SA  
BATARSEH, Sameeh Issa, P.O. Box 9522, Dhahran, 31311, SA

(51) MKP  
**G01N 27/74 2006 (97) EP 3797290**  
**G01N 33/28 2006**  
**G01V 3/10 2006**  
(96) EP 18786037.4 9/24/2018  
(97) EP 3797290, 3/31/2021 202113, en  
(31) 201815984471 (32) 21.05.2018 (33) US  
(54) DETECTING SATURATION LEVELS OF A CORE SAMPLE USING MAGNETIC FIELDS  
(72) KARIMI, Muhammad Akram, Office 3266-WS13, Building 3 KAUST Campus, Thuwal, 23955, SA  
AYUB, Muhammad, P.O. Box 6609 Saudi Aramco, Dhahran, 31311, SA  
ARSALAN, Muhammad, P.O. Box 8459 Saudi Aramco, Dhahran, 31311, SA  
SHAMIM, Atif, Office 3276, Building 3 KAUST Campus, Thuwal, 23955, SA

(51) MKP  
**G01N 22/00 2006 (97) EP 3791177**  
**G01N 33/18 2006**  
**G01N 33/24 2006**  
**G01N 33/28 2006**  
(96) EP 18789479.5 9/24/2018  
(97) EP 3791177, 3/17/2021 202111, en  
(31) 201815984469 (32) 21.05.2018 (33) US  
(54) IDENTIFYING CONTENT IN A CONDUIT  
(71) King Abdullah University of Science and Technology, 4700 King Abdullah University of Science and Technology, Thuwal 23955, SA

(72) KARIMI, Muhammad Akram, Office 3266-WS13 Building 3 KAUST Campus, Thuwal 23955, SA  
 ARSALAN, Muhammad, Saudi Aramco P.O. Box 8459, Dhahran, 31311, SA  
 SHAMIM, Atif, Office 3266-WS13 Building 3 KAUST Campus, Thuwal, 23955, SA

(51) MKP  
**C01D 3/06 2006 (97) EP 3691996**  
**C02F 1/26 2006**

(96) EP 18864958.6 10/3/2018

(97) EP 3691996, 3/24/2021 202112, en

(31) 201762567545 P (32) 03.10.2017 (33) US

(54) A SALT RECOVERY SOLUTION AND PROCESSES OF USE THEREOF

(71) Aquafortus Technologies Limited, 3A Airpark Drive Mangere, Auckland 2022, NZ

(72) BRIGGS, Daryl Joseph, 13b Stephanie Close Glenfield, Auckland 0629, NZ

PRAKASH, Chaitra, 5 Nevill Road Hobsonville, Auckland 0616, NZ

(51) MKP  
**A61K 39/395 2006 (97) EP 3699194**  
**A61K 47/68 2017**  
**A61P 35/00 2006**  
**C07K 16/28 2006**  
**C07K 16/30 2006**  
**C07K 16/46 2006**

(96) EP 19202926.2 1/27/2014

(97) EP 3699194, 4/7/2021 202114, en

(31) 201361756991 P (32) 25.01.2013 (33) US

201361785147 P 14.03.2013 US

(54) ANTIBODY CONSTRUCTS FOR CDH19 AND CD3

(72) XIAO, Shouhua, 719 Coronado Lane, Foster City, CA 94404, US

PAN, Zheng, 4315 Mockingbird Way, Fremont, CA 94555, US

WICKRAMASINGHE, Dineli, P.O. Box 94114 342 Liberty Street, San Francisco, CA 94114, US

JEFFRIES, M., Shawn, c/o Amgen Inc. One Amgen Center Drive, Thousand Oaks, California 91320-1799, US

KING, Chadwick Terence, 1325 Moody Avenue, North Vancouver, British Columbia V7L 3T5, CA

CHAN, Brian Mingtung, 2458 Kensington Crescent, Port Coquitlam, British Columbia V3C 5N8, CA

KUFER, Peter, c/o Amgen Research Munich GmbH Staffelseestr. 2, 81477 Munich, DE

RAUM, Tobias, c/o Amgen Research Munich GmbH Staffelseestr. 2, 81477 Munich, DE

HOFFMANN, Patrick, c/o Amgen Research Munich GmbH Staffelseestr. 2, 81477 Munich, DE

RAU, Doris, c/o Amgen Research Munich GmbH Staffelseestr. 2, 81477 Munich, DE

KISCHEL, Roman, c/o Amgen Research Munich GmbH Staffelseestr. 2, 81477 Munich, DE

LEMON, Bryan, 2493 Dell Avenue, Mountain View, CA 94043, US

WESCHE, Holger, 1080 Jamestown Avenue, San Francisco, CA California 94124, US

LUTTERBUENSE, Ralf, c/o Amgen Research Munich GmbH Staffelseestr. 2, 81477 Munich, DE

(51) MKP  
**A61K 31/437 2006 (97) EP 3689873**  
**A61K 31/501 2006**  
**A61K 31/506 2006**  
**A61P 35/00 2006**  
**C07D 471/04 2006**

(96) EP 19203383.5 1/29/2018

(97) EP 3689873, 3/17/2021 202111, en

(31) 201762451971 P (32) 30.01.2017 (33) US

201762523695 P 22.06.2017 US

201762560304 P 19.09.2017 US

201762592485 P 30.11.2017 US

(54) ESTROGEN RECEPTOR MODULATORS

(72) SCOTT, James, Stewart, AstraZeneca, Darwin Building, Cambridge Science Park, Milton Road, Cambridge, Cambridgeshire CB4 0WG, GB

MOSS, Thomas, Andrew, AstraZeneca Darwin Building, Cambridge Science Park, Milton Road, Cambridge, Cambridgeshire CB4 0WG, GB

HUGHES, Samantha, Jayne, AstraZeneca Darwin Building, Cambridge Science Park, Milton Road, Cambridge, Cambridgeshire CB4 0WG, GB

NISSINK, Johannes, Wilhelmus, Maria, AstraZeneca Darwin Building, Cambridge Science Park, Milton Road, Cambridge, Cambridgeshire CB4 0WG, GB

BARLAAM, Bernard, Christophe, AstraZeneca, Darwin Building, Cambridge Science Park, Milton Road, Cambridge, Cambridgeshire CB4 0WG, GB

YANG, Bin, AstraZeneca 35 Gatehouse Drive, Waltham, MA 02451, US

(51) MKP  
**A61K 31/55 2006 (97) EP 3660010**  
**A61P 25/00 2006**  
**C07D 211/34 2006**  
**C07D 211/60 2006**  
**C07D 211/62 2006**  
**C07D 401/06 2006**  
**C07D 405/12 2006**

(96) EP 19203412.2 2/3/2012  
(97) EP 3660010, 1/13/2021 202102, en

(31) 201161440254 P (32) 07.02.2011 (33) US

(54) S1P MODULATING AGENTS  
(72) THOMAS, Jermaine, 130 Library Street, Chelsea, MA 02150, US  
MI, Sha, c/o Biogen MA Inc. 225 Binney Street, Cambridge, MA 02142, US  
LIN, Edward, Yin-shiang, c/o Biogen MA Inc. 225 Binney Street, Cambridge, MA 02142, US  
ZHENG, Guo, Zhu, 14 Meriam Street, Lexington, MA 02420, US  
MA, Bin, 211 Wachusett Ave., Arlington, MA 02476, US  
CALDWELL, Richard, D., 8 Alden Street, Melrose, MA 02176, US  
GUCKIAN, Kevin, 44 Little Pond Road, Northborough, MA 01532, US  
KUMARAVEL, Gnanasambandam, 21 Appletree Lane, Lexington, MA 02420, US

(51) MKP  
**A61K 35/74 2015 (97) EP 3659613**  
**A61P 29/00 2006**  
**A61P 35/00 2006**

(96) EP 19204141.6 11/23/2016  
(97) EP 3659613, 1/13/2021 202102, en

(31) 201520638 (32) 23.11.2015 (33) GB

(54) COMPOSITIONS COMPRISING BACTERIAL STRAINS  
(72) MULDER, Imke Elisabeth, c/o 4D PHARMA RESEARCH LIMITED Life Sciences Innovation Building Cornhill Road, Aberdeen, Aberdeenshire AB25 2ZS, GB  
HOLT, Amy Beth, c/o 4D PHARMA RESEARCH LIMITED Life Sciences Innovation Building Cornhill Road, Aberdeen, Aberdeenshire AB25 2ZS, GB  
MCCLUSKEY, Seanin Marie, c/o 4D PHARMA RESEARCH LIMITED Life Sciences Innovation Building Cornhill Road, Aberdeen, Aberdeenshire AB25 2ZS, GB  
LENNON, Grainne Clare, c/o 4D PHARMA RESEARCH LIMITED Life Sciences Innovation Building Cornhill Road, Aberdeen, Aberdeenshire AB25 2ZS, GB  
AHMED, Suaad, c/o 4D PHARMA RESEARCH LIMITED Life Sciences Innovation Building Cornhill Road, Aberdeen, Aberdeenshire AB25 2ZS, GB

(51) MKP  
**C12Q 1/68 2018 (97) EP 3647783**  
**G01N 33/50 2006**  
**G01N 33/569 2006**

(96) EP 19204477.4 4/19/2013  
(97) EP 3647783, 2/24/2021 202108, en

(31) 201361808406 P (32) 04.04.2013 (33) US  
201361811321 P 12.04.2013 US  
201361813380 P 18.04.2013 US

(54) IDENTIFYING PATIENT RESPONSE TO S1P RECEPTOR MODULATOR ADMINISTRATION  
(72) BORELL, Hubert, Novartis Pharma AG Postfach, 4002 Basel, CH  
GARDIN, Anne, Novartis Pharma AG Postfach, 4002 Basel, CH  
JIN, Yi, Novartis Pharma AG Postfach, 4002 Basel, CH  
LEGANGNEUX, Eric, Novartis Pharma AG Postfach, 4002 Basel, CH  
UFER, Mike, Hegenheimerweg 40b, 4123 Allschwil, CH

(51) MKP  
**E04F 10/08 2006 (97) EP 3647510**

(96) EP 19206331.1 10/30/2019  
(97) EP 3647510, 3/3/2021 202109, en

(31) 201800009913 (32) 30.10.2018 (33) IT

201962792975 P

16.01.2019

US

- (54) SHADING SYSTEM  
 (71) Eilon, Sali, 16 Hartom St. Har Hachozvim P.O. Box 45225, 9777516 Jerusalem, IL  
 (72) Eilon, Sali, 16 Hartom St. Har Hachozvim P.O. Box 45225, 9777516 Jerusalem, IL
- 

- (51) MKP  
**A61K 39/00 2006 (97) EP 3662931**  
**A61K 39/395 2006**  
**A61P 25/28 2006**  
**C07K 14/47 2006**  
**C07K 16/18 2006**  
**C07K 16/46 2006**  
**C12N 15/02 2006**  
**C12P 21/08 2006**  
 (96) EP 19207405.2 5/30/2013  
 (97) EP 3662931, 1/13/2021 202102, en  
 (31) 2012124336 (32) 31.05.2012 (33) JP  
 (54) THERAPEUTIC AGENT OR PROPHYLACTIC AGENT FOR DEMENTIA  
 (71) Osaka City University, 3-3-138 Sugimoto Sumiyoshi-ku, Osaka-shi, Osaka 558-8585, JP  
 (72) MORI, Hiroshi, c/o Osaka City University 4-3 Asahimachi 1-chome Abeno-ku Osaka-shi, Osaka, Osaka 545-8585, JP  
 TOMIYAMA, Takami, c/o Osaka City University 4-3 Asahimachi 1-chome Abeno-ku Osaka-shi, Osaka, Osaka 545-8585, JP  
 MATSUMOTO, Yoichi, c/o Teijin Pharma Limited Tokyo Research Center 3-2 Asahigaoka 4-chome Hino-shi, Tokyo, Tokyo 191-0065, JP  
 EGUCHI, Hiroshi, c/o Teijin Pharma Limited 2-1 Kasumigaseki 3-chome Chiyoda-ku, Tokyo, Tokyo 100-0013, JP  
 KUNORI, Yuichi, c/o Teijin Pharma Limited Tokyo Research Center 3-2 Asahigaoka 4-chome Hino-shi, Tokyo, Tokyo 191-0065, JP
- 

- (51) MKP  
**A61K 31/7125 2006 (97) EP 3662912**  
**A61P 21/00 2006**  
 (96) EP 19207586.9 3/14/2014  
 (97) EP 3662912, 1/13/2021 202102, en  
 (31) 201361793463 P (32) 15.03.2013 (33) US  
 (54) IMPROVED DOSAGES OF ETEPLIRSEN FOR TREATING DUCHENNE MUSCULAR DYSTROPHY  
 (72) KAYE, Edward, M., c/o Sarepta Therapeutics, Inc. 215 First Street, Cambridge, MA Massachusetts 02142, US
- 

- (51) MKP  
**A61K 31/395 2006 (97) EP 3686190**  
**A61P 35/00 2006**  
**C07D 251/18 2006**  
**C07D 401/04 2006**  
**C07D 403/04 2006**  
**C07D 405/14 2006**  
**C07D 409/04 2006**  
**C07D 417/04 2006**  
 (96) EP 19209249.2 7/10/2014  
 (97) EP 3686190, 3/10/2021 202110, en  
 (31) PCT/CN2013/079200 (32) 11.07.2013 (33) WO  
 (54) SYNTHESIS OF THERAPEUTICALLY ACTIVE COMPOUNDS  
 (72) KONTEATIS, Zenon D., 137 Southern Boulevard, Chatham, NJ 07928, US  
 POPOVICI-MULLER, Janeta, 12 Clarke Farm Road, Windham, NH 03087, US  
 TRAVINS, Jeremy M., 59 Flagg Road, Southborough, MA 01772, US  
 ZAHLER, Robert, 5 East Welling Avenue, Pennington, NJ 08534, US  
 CAI, Zhenwei, 10 Carlton Circle, Princeton, NJ 08540, US  
 ZHOU, Ding, Room 101, Building 27 No. 909 Wangyue Road Xuhui District, Shanghai 220231, CN
- 

- (51) MKP  
**A61P 1/04 2006 (97) EP 3686218**  
**A61P 13/12 2006**  
**C07K 16/28 2006**  
 (96) EP 19209959.6 12/10/2013  
 (97) EP 3686218, 3/3/2021 202109, en  
 (31) 201261735362 P (32) 10.12.2012 (33) US  
 201361763270 P 11.02.2013 US  
 (54) ANTI-BLOOD DENDRITIC CELL ANTIGEN 2 ANTIBODIES AND USES THEREOF

(72) CARAVELLA, Justin A., 121 Sciarappa Street 3, Cambridge, MA 02141, US  
 GARBER STARK, Ellen A., 14 Donnell Street, Cambridge, MA 02138, US  
 RABAH, Dania Mounir, 59 Magazine Street Unit 35, Cambridge, MA 02139, US  
 TAYLOR, Frederick R., 98 Gulliver Street, Milton, MA 02186, US

(51) MKP  
**A61P 37/00 2006 (97) EP 3666796**  
**C07K 16/30 2006**  
 (96) EP 19210903.1 5/6/2013  
 (97) EP 3666796, 1/13/2021 202102, en  
 (31) PCT/EP2012/001991 (32) 09.05.2012 (33) WO  
 (54) ANTIBODIES AGAINST CLAUDIN 18.2 USEFUL IN CANCER DIAGNOSIS  
 (72) SAHIN, Ugur, Philipp-von-Zabern-Platz 1, 55116 Mainz, DE  
 TÜRECI, Özlem, Philipp-von-Zabern-Platz 1, 55116 Mainz, DE  
 MITNACHT-KRAUS, Rita, Taunusstrasse 45, 61169 Friedberg, DE  
 WÖLL, Stefan, Pommardstrasse 22a, 55299 Nackenheim, DE

(51) MKP  
**A61K 39/395 2006 (97) EP 3670537**  
**A61P 35/00 2006**  
**C07K 16/28 2006**  
**C07K 16/30 2006**  
 (96) EP 19210913.0 3/17/2014  
 (97) EP 3670537, 1/20/2021 202103, en  
 (31) PCT/EP2013/000817 (32) 18.03.2013 (33) WO  
 (54) THERAPY INVOLVING ANTIBODIES AGAINST CLAUDIN 18.2 FOR TREATMENT OF CANCER  
 (72) SAHIN, Ugur, Philipp-von-Zabern-Platz 1, 55116 Mainz, DE  
 TÜRECI, Özlem, Philipp-von-Zabern-Platz 1, 55116 Mainz, DE

(51) MKP  
**A61K 31/4184 2006 (97) EP 3702351**  
**A61P 35/00 2006**  
**C07D 235/06 2006**  
 (96) EP 19211405.6 10/18/2013  
 (97) EP 3702351, 4/7/2021 202114, en  
 (31) 201261716169 P (32) 19.10.2012 (33) US  
 (54) FORMULATION COMPRISING A MEK INHIBITOR  
 (72) KRELL, Christoph, Max, In den Ziegelhöfen 153, 4054 Basel, CH  
 MISUN, Marian, Obere Bifangstrasse 17, 79418 Schliengen, DE  
 NIEDERER, Daniel, Andreas, Louiserebenweg 18, 4104 Oberwil, CH  
 PACHINGER, Werner, Heinz, Markgräflerstrasse 75, 4057 Basel, CH  
 WOLF, Marie-Christine, Rue du Rhin 43, 68300 St. Louis, FR  
 ZIMMERMANN, Daniel, St. Johans Ring 16, 4056 Basel, CH  
 LIU, Weidong, c/o Array Biopharma Inc. 3200 Walnut Street, Boulder, CO 80301, US  
 STENGEL, Peter, J., c/o Array Biopharma Inc. 3200 Walnut Street, Boulder, CO 80301, US  
 NICHOLS, Paul, 807 N Salisbury St., West Lafayette, IN 47906, US

(51) MKP  
**A61K 38/28 2006 (97) EP 3660040**  
**A61K 47/60 2017**  
**C07K 14/62 2006**  
 (96) EP 19211793.5 11/19/2015  
 (97) EP 3660040, 3/10/2021 202110, en  
 (31) 201462082857 P (32) 21.11.2014 (33) US  
 201562242503 P 16.10.2015 US  
 (54) INSULIN RECEPTOR PARTIAL AGONISTS  
 (72) Lin, Songnian, 2000 Galloping Hill Road, Kenilworth, New Jersey 07033, US  
 Yan, Lin, 2000 Galloping Hill Road, Kenilworth, New Jersey 07033, US  
 Huo, Pei, 2000 Galloping Hill Road, Kenilworth, New Jersey 07033, US  
 Pissarnitski, Dmitri, 2000 Galloping Hill Road, Kenilworth, New Jersey 07033, US  
 Feng, Danqing, 2000 Galloping Hill Road, Kenilworth, New Jersey 07033, US  
 Nargund, Ravi, 2000 Galloping Hill Road, Kenilworth, New Jersey 07033, US  
 Zhu, Yuping, 2000 Galloping Hill Road, Kenilworth, New Jersey 07033, US

Kekec, Ahmet, 2000 Galloping Hill Road, Kenilworth, New Jersey 07033, US  
 Madsen-Duggan, Christina, B., 2000 Galloping Hill Road, Kenilworth, New Jersey 07033, US  
 Shi, Zhi-Cai, 2000 Galloping Hill Road, Kenilworth, New Jersey 07033, US  
 Wu, Zhicai, 2000 Galloping Hill Road, Kenilworth, New Jersey 07033, US  
 Mu, Yingjun, 2000 Galloping Hill Road, Kenilworth, New Jersey 07033, US

- (51) MKP  
**A61K 38/28 2006 (97) EP 3660041**  
**A61K 47/60 2017**  
**C07K 14/62 2006**
- (96) EP 19211799.2 11/19/2015  
 (97) EP 3660041, 1/13/2021 202102, en
- |      |                |      |            |      |    |
|------|----------------|------|------------|------|----|
| (31) | 201462082857 P | (32) | 21.11.2014 | (33) | US |
|      | 201562242503 P |      | 16.10.2015 |      | US |
- (54) INSULIN RECEPTOR PARTIAL AGONISTS  
 (72) Lin, Songnian, 2000 Galloping Hill Road, Kenilworth, New Jersey 07033, US  
 Yan, Lin, 2000 Galloping Hill Road, Kenilworth, New Jersey 07033, US  
 Huo, Pei, 2000 Galloping Hill Road, Kenilworth, New Jersey 07033, US  
 Pissarnitski, Dmitri, 2000 Galloping Hill Road, Kenilworth, New Jersey 07033, US  
 Feng, Danqing, 2000 Galloping Hill Road, Kenilworth, New Jersey 07033, US  
 Nargund, Ravi, 2000 Galloping Hill Road, Kenilworth, New Jersey 07033, US  
 Zhu, Yuping, 2000 Galloping Hill Road, Kenilworth, New Jersey 07033, US  
 Kekec, Ahmet, 2000 Galloping Hill Road, Kenilworth, New Jersey 07033, US  
 Madsen-Duggan, Christina, B., 2000 Galloping Hill Road, Kenilworth, New Jersey 07033, US  
 Shi, Zhi-Cai, 2000 Galloping Hill Road, Kenilworth, New Jersey 07033, US  
 Wu, Zhicai, 2000 Galloping Hill Road, Kenilworth, New Jersey 07033, US  
 Mu, Yingjun, 2000 Galloping Hill Road, Kenilworth, New Jersey 07033, US

- (51) MKP  
**A61K 38/28 2006 (97) EP 3666792**  
**A61K 47/60 2017**  
**C07K 14/62 2006**
- (96) EP 19211801.6 11/19/2015  
 (97) EP 3666792, 3/10/2021 202110, en
- |      |                |      |            |      |    |
|------|----------------|------|------------|------|----|
| (31) | 201462082857 P | (32) | 21.11.2014 | (33) | US |
|      | 201562242503 P |      | 16.10.2015 |      | US |
- (54) INSULIN RECEPTOR PARTIAL AGONISTS  
 (72) Lin, Songnian, 2000 Galloping Hill Road, Kenilworth, New Jersey 07033, US  
 Yan, Lin, 2000 Galloping Hill Road, Kenilworth, New Jersey 07033, US  
 Huo, Pei, 2000 Galloping Hill Road, Kenilworth, New Jersey 07033, US  
 Pissarnitski, Dmitri, 2000 Galloping Hill Road, Kenilworth, New Jersey 07033, US  
 Feng, Danqing, 2000 Galloping Hill Road, Kenilworth, New Jersey 07033, US  
 Nargund, Ravi, 2000 Galloping Hill Road, Kenilworth, New Jersey 07033, US  
 Zhu, Yuping, 2000 Galloping Hill Road, Kenilworth, New Jersey 07033, US  
 Kekec, Ahmet, 2000 Galloping Hill Road, Kenilworth, New Jersey 07033, US  
 Madsen-Duggan, Christina, B., 2000 Galloping Hill Road, Kenilworth, New Jersey 07033, US  
 Shi, Zhi-Cai, 2000 Galloping Hill Road, Kenilworth, New Jersey 07033, US  
 Wu, Zhicai, 2000 Galloping Hill Road, Kenilworth, New Jersey 07033, US  
 Mu, Yingjun, 2000 Galloping Hill Road, Kenilworth, New Jersey 07033, US

- (51) MKP  
**A61K 47/00 2006 (97) EP 3763738**  
**A61P 35/00 2006**  
**C07K 16/28 2006**
- (96) EP 19213033.4 7/10/2015  
 (97) EP 3763738, 1/13/2021 202102, en
- |      |             |      |            |      |    |
|------|-------------|------|------------|------|----|
| (31) | PA201400380 | (32) | 11.07.2014 | (33) | DK |
|      | PA201400489 |      | 01.09.2014 |      | DK |
|      | PA201400746 |      | 22.12.2014 |      | DK |
|      | PA201500283 |      | 12.05.2015 |      | DK |
- (54) ANTIBODIES BINDING AXL  
 (72) BREIJ, Esther, c/o Genmab B.V. Uppsalalaan 15, NL-3584 CT Utrecht, NL  
 SATIJN, David, c/o Genmab B.V. Uppsalalaan 15, NL-3584 CT Utrecht, NL  
 VAN DEN BRINK, Edward, Norbert, c/o Genmab B. V. Uppsalalaan 15, NL-3584 CT Utrecht, NL

VERZIJL, Dennis, c/o Genmab B.V. Uppsalalaan 15, NL-3584 CT Utrecht, NL  
 DE JONG, Rob, N., c/o Genmab B.V. Uppsalalaan 15, NL-3584 CT Utrecht, NL  
 PARREN, Paul, Werdorperwaard 17, NL-3984 PR Odijk, NL  
 VAN DIJKHUIZEN RADERSMA, Riemke, c/o Genmab B.V. Uppsalalaan 15, NL-3584 CT Utrecht, NL

- (51) MKP  
**A61K 39/00 2006 (97) EP 3685854**  
**A61K 39/395 2006**  
**A61K 47/60 2017**  
**A61K 51/10 2006**  
**A61P 25/28 2006**  
**C07K 16/18 2006**  
**C12N 15/63 2006**  
**G01N 33/68 2006**
- (96) EP 19213625.7 8/15/2013  
 (97) EP 3685854, 3/10/2021 202110, en
- (31) 201261683902 P (32) 16.08.2012 (33) US  
 201361754085 P 18.01.2013 US  
 201361781823 P 14.03.2013 US  
 201361813797 P 19.04.2013 US  
 201361833355 P 10.06.2013 US
- (54) METHODS OF TREATING A TAUOPATHY  
 (72) GRISWOLD-PRENNER, Irene, c/o Bristol-Myers Squibb Company Patent Department Route 206 and Province Line Road, Princeton, NJ 08543-4000, US  
 STAGLIANO, Nancy E., c/o Bristol-Myers Squibb Company Patent Department Route 206 and Province Line Road, Princeton, NJ 08543-4000, US  
 DANG, Vu, c/o Bristol-Myers Squibb Company Patent Department Route 206 and Province Line Road, Princeton, NJ 08543-4000, US

- (51) MKP  
**A61B 5/00 2006 (97) EP 3682798**  
**A61B 5/024 2006**  
**A61B 5/0245 2006**  
**A61B 5/0456 2006**  
**A61B 5/0464 2006**  
**A61B 5/11 2006**  
**A61N 1/36 2006**  
**G16H 40/63 2018**
- (96) EP 19214855.9 2/10/2016  
 (97) EP 3682798, 2/24/2021 202108, en
- (31) 201562114480 P (32) 10.02.2015 (33) US
- (54) TITRATION OF HEART RATE TO IMPROVE STIMULATION THERAPY FOR HEART FAILURE PATIENTS  
 (72) CARLSON, Gerrard Merrill, 100 Cyberonics Blvd., Houston, TX Texas 77058, US  
 SABESAN, Shivkumar, 100 Cyberonics Blvd., Houston, TX Texas 77058, US  
 KENKNIGHT, Bruce H., 100 Cyberonics Blvd., Houston, TX Texas 77058, US  
 LIBBUS, Imad, 100 Cyberonics Blvd., Houston, TX Texas 77058, US  
 AMURTHUR, Badri, 100 Cyberonics Blvd., Houston, TX Texas 77058, US

- (51) MKP  
**A01J 25/12 2006 (97) EP 3679802**  
**A23C 19/068 2006**
- (96) EP 19215297.3 12/11/2019  
 (97) EP 3679802, 1/27/2021 202104, en
- (31) 201900000394 (32) 10.01.2019 (33) IT
- (54) FOOD PRODUCT BASED ON MOZZARELLA STUFFED WITH SMALL MOZZARELLA AND CREAM  
 (71) Azienda Agrobufalina Ponterotto S.r.l. Società Agricola, Via Madre Teresa di Calcutta 11, 81030 Saint' Arpino (CE), IT  
 (72) DI SANTO, Antonio, AZIENDA AGROBUFALINA PONTEROTTO S.R.L. SOCIETÀ AGRICOLA Via Madre Teresa di Calcutta 11, I-81030 SANT'ARPINO (CE), IT  
 DI SANTO, Francesco, AZIENDA AGROBUFALINA PONTEROTTO S.R.L. SOCIETÀ AGRICOLA Via Madre Teresa di Calcutta 11, I-81030 SANT'ARPINO (CE), IT

- (51) MKP  
**A61K 31/4985 2006 (97) EP 3689878**  
**A61P 19/08 2006**

	<b>A61P 29/00</b>	<b>2006</b>					
	<b>A61P 31/00</b>	<b>2006</b>					
	<b>A61P 35/00</b>	<b>2006</b>					
	<b>A61P 37/00</b>	<b>2006</b>					
	<b>C07D 487/04</b>	<b>2006</b>					
	<b>C07D 519/00</b>	<b>2006</b>					
(96)	EP 19215783.2 7/11/2012						
(97)	EP 3689878, 3/10/2021 202110, en						
(31)	201161509397 P		(32)	19.07.2011		(33)	US
	11174578			19.07.2011			EP
(54)	4-IMIDAZOPYRIDAZIN-1-YL-BENZAMIDES AND 4-IMIDAZOTRIAZIN-1-YL-BENZAMIDES AS BTK-INHIBITORS						
(72)	BARF, Tjeerd A., St. Luciastraat 7, 5371 AS Ravenstein, NL						
	JANS, Christiaan Gerardus Johannes Maria, Heggerank 134, 5342 CC Cuijk, NL						
	de MAN, Adrianus Petrus Antonius, N.V. Organon H.W. Van Heelstraat 4, 5327 AH Hurwenen, NL						
	OUBRIE, Arthur A., Saltshof 1106, 6604 EB Wijchen, NL						
	RAAIJMAKERS, Hans C.A., Eikakkerhoven 26, 5242 KK Eindhoven, NL						
	REWINKEL, Johannes Bernardus Maria, Molenweg 16, 5351 EV Berghem, NL						
	STERRENBURG, Jan-Gerard, Grote Omloop 18, 6871 TE Renkum, NL						
	WIJKMANS, Jacobus C.H.M., N.V. Organon OSS, 5345 LR Hurwenen, NL						
<hr/>							
(51)	MKP						
	<b>A61K 31/4965</b>	<b>2006</b>	(97)	<b>EP 3693361</b>			
	<b>A61P 11/00</b>	<b>2006</b>					
	<b>C07D 239/48</b>	<b>2006</b>					
(96)	EP 19217140.3 6/26/2012						
(97)	EP 3693361, 3/24/2021 202112, en						
(31)	201161501687 P		(32)	27.06.2011		(33)	US
	201261635745 P			19.04.2012			US
(54)	3,5-DIAMINO-6-CHLORO-N-(N-(4-(4-(2-(HEXYL(2,3,4,5,6-PENTA-HYDROXYHEXYL)AMINO)ETHOXY)PHENYL)BUTYL)CARBAMIMIDOYL)PYRAZINE-2-CARBOXAMIDE						
(72)	JOHNSON, Michael, Ross, -, deceased, US						
<hr/>							
(51)	MKP						
	<b>A61K 31/7088</b>	<b>2006</b>	(97)	<b>EP 3690049</b>			
	<b>A61K 31/713</b>	<b>2006</b>					
	<b>A61K 47/54</b>	<b>2017</b>					
	<b>A61K 47/59</b>	<b>2017</b>					
	<b>A61P 3/06</b>	<b>2006</b>					
	<b>A61P 25/00</b>	<b>2006</b>					
	<b>A61P 43/00</b>	<b>2006</b>					
	<b>C12N 15/113</b>	<b>2010</b>					
(96)	EP 19217148.6 5/1/2014						
(97)	EP 3690049, 3/17/2021 202111, en						
(31)	201361818442 P		(32)	01.05.2013		(33)	US
	201361823826 P			15.05.2013			US
	201361843887 P			08.07.2013			US
	201361871673 P			29.08.2013			US
	201361880790 P			20.09.2013			US
	201461976991 P			08.04.2014			US
	201461986867 P			30.04.2014			US
(54)	COMPOSITIONS AND METHODS FOR MODULATING APOLIPOPROTEIN C-III EXPRESSION						
(72)	PRAKASH, Thazha, P., 2855 Gazelle Court, Carlsbad, CA 92010, US						
	SETH, Punit, P., 2855 Gazelle Court, Carlsbad, CA 92010, US						
	SWAYZE, Eric, E., 2855 Gazelle Court, Carlsbad, CA 92010, US						
	GRAHAM, Mark, J., 2855 Gazelle Court, Carlsbad, CA 92010, US						
<hr/>							
(51)	MKP						
	<b>A61K 31/407</b>	<b>2006</b>	(97)	<b>EP 3696183</b>			
	<b>A61P 25/16</b>	<b>2006</b>					
	<b>C07D 495/04</b>	<b>2006</b>					
(96)	EP 19217991.9 8/27/2015						
(97)	EP 3696183, 3/31/2021 202113, en						
(31)	14182468		(32)	27.08.2014		(33)	EP
(54)	NOVEL CHROMONE OXIME DERIVATIVE AND ITS USE AS ALLOSTERIC MODULATOR OF METABOTROPIC GLUTAMATE RECEPTORS						



(72) Charvin, Delphine, Prexton Therapeutics SA 14 Chemin des Aulx Plan les Ouates, 1228 Geneva, CH  
 Manteau, Baptiste, Prexton Therapeutics SA 14 Chemin des Aulx Plan les Ouates, 1228 Geneva, CH  
 Pomet, Vincent, Prexton Therapeutics SA 14 Chemin des Aulx Plan les Ouates, 1228 Geneva, CH  
 Conquet, Francois, Prexton Therapeutics SA 14 Chemin des Aulx Plan les Ouates, 1228 Geneva, CH

(51) MKP  
**A61K 9/00 2006 (97) EP 3689344**  
**A61K 9/08 2006**  
**A61K 31/277 2006**  
**A61K 47/12 2006**  
**A61K 47/18 2017**  
**A61K 47/20 2006**  
**A61P 9/00 2006**  
**A61P 9/06 2006**  
**A61P 9/10 2006**  
**A61P 25/06 2006**  
**C07C 255/42 2006**

(96) EP 19218071.9 4/13/2016

(97) EP 3689344, 3/10/2021 202110, en

(31) 201562147427 P (32) 14.04.2015 (33) US

(54) HIGHLY WATER-SOLUBLE SALTS OF A SHORT ACTING PHENYLALKYLAMINE CALCIUM CHANNEL BLOCKER AND USES THEREOF

(72) MAGUIRE, Martin P., 70 US Oval, Apt. 413, Plattsburg, NY 12903, US

(51) MKP  
**A61P 37/06 2006 (97) EP 3696262**  
**C12N 5/0783 2010**

(96) EP 19218118.8 11/20/2012

(97) EP 3696262, 3/31/2021 202113, en

(31) 201161563273 P (32) 23.11.2011 (33) US  
 201161564174 P 28.11.2011 US

(54) USE OF PDL1 EXPRESSING CELLS TO CONVERT T CELLS INTO REGULATORY T CELLS

(72) RILEY, James L., 435 Creekside Drive, Downingtown, PA 19355, US

FOWLER, Daniel H., 5219 Elsmere Avenue, Bethesda, MD 20892, US

AMARNATH, Shoba, 5905 Barbados Place, Apt. 103, North Bethesda, MD 20852, US

(51) MKP  
**G06F 21/32 2013 (97) EP 3671503**  
**G06F 21/62 2013**  
**G06F 21/64 2013**  
**H04L 9/32 2006**  
**H04L 29/06 2006**

(96) EP 19218246.7 12/19/2019

(97) EP 3671503, 1/27/2021 202104, en

(31) 201800020452 (32) 20.12.2018 (33) IT

(54) GRAPHOMETRIC DOCUMENT SIGNING METHOD AND SYSTEM

(71) Olivieri, Benedetto, Via Colle Nuovo, 1, 03043 Cassino (FR), IT

(72) Olivieri, Benedetto, Via Colle Nuovo, 1, 03043 Cassino (FR), IT

(51) MKP  
**A61K 31/00 2006 (97) EP 3693391**  
**A61K 47/68 2017**  
**A61K 51/00 2006**  
**A61P 35/00 2006**  
**A61P 35/02 2006**  
**C07K 16/28 2006**  
**C07K 16/30 2006**

(96) EP 19219511.3 9/11/2015

(97) EP 3693391, 3/24/2021 202112, en

(31) 201462049876 P (32) 12.09.2014 (33) US

(54) ANTI-CLL-1 ANTIBODIES AND IMMUNOCONJUGATES

(72) ZHENG, Bing, C/o Genentech Inc. 1 DNA Way, San Francisco, CA 94080, US

POLSON, Andrew, C/o Genentech Inc. 1 DNA Way, San Francisco, CA 94080, US

CHIU, Cecilia, C/o Genentech Inc. 1 DNA Way, San Francisco, CA 94080, US

LIANG, Wei-Ching, C/o Genentech Inc 1 DNA Way, San Francisco, CA 94080, US  
 WU, Yan, C/o Genentech Inc. 1 DNA Way, San Francisco, CA 94080, US

- (51) MKP  
**A61K 39/395 2006 (97) EP 3693397**  
**A61K 47/65 2017**  
**A61P 35/00 2006**  
**C07K 16/10 2006**  
**C07K 16/46 2006**  
**C12N 15/62 2006**
- (96) EP 19220077.2 7/11/2014  
 (97) EP 3693397, 3/24/2021 202112, en
- (31) 201361845280 P (32) 11.07.2013 (33) US  
 201361845287 P 11.07.2013 US  
 201461925904 P 10.01.2014 US  
 201462017713 P 26.06.2014 US
- (54) COILED COIL IMMUNOGLOBULIN FUSION PROTEINS AND COMPOSITIONS THEREOF  
 (71) The Scripps Research Institute, 10550 North Torrey Pines Road, La Jolla, CA 92037, US  
 (72) WANG, Feng, 6151 Citracado Circle, Carlsbad, CA 92009, US  
 ZHANG, Yong, 6113 Reno Avenue, Temple City, CA 91780, US  
 WANG, Ying, 3871 Camino Lindo, San Diego, CA 92122, US  
 LIU, Yan, 3765 Carmel View Road, 3, San Diego, CA 92130, US  
 SCHULTZ, Peter, G., 1650 La Jolla Rancho Road, La Jolla, CA 92037, US

- (51) MKP  
**A61K 9/00 2006 (97) EP 3630289**  
**A61K 9/20 2006**  
**A61K 31/423 2006**  
**A61K 31/428 2006**  
**A61P 25/00 2006**  
**A61P 25/16 2006**  
**A61P 25/28 2006**  
**A61P 43/00 2006**
- (96) EP 18805392.0 5/23/2018  
 (97) EP 3630289, 3/3/2021 202109, en
- (31) 201762511424 P (32) 26.05.2017 (33) US
- (54) PHARMACEUTICAL COMBINATIONS OF ZONISAMIDE AND PRAXIPEXOLE, AND RELATED METHODS, FOR TREATING  
 SYNUCLEINOPATHIES  
 (72) CHASE, Thomas, N., 1825 K Street NW Suite 520, Washington DC 20006, US  
 CLARENCE-SMITH, Kathleen, E., 1825 K Street NW Suite 520, Washington DC 20006, US

- (51) MKP  
**F03D 5/04 2006 (97) EP 3633187**  
**F03D 7/00 2006**  
**F03D 7/02 2006**
- (96) EP 18805713.7 5/22/2018  
 (97) EP 3633187, 2/24/2021 202108, en
- (31) 2017117569 (32) 22.05.2017 (33) RU
- (54) WIND ENERGY CONVERSION MODULE  
 (72) YAKIMCHUK, Vyacheslav Antonovic, Yakimchuk, Vyacheslav Antonovich Ul. Geroya Rossii Solomatina 1-6 Poselenie Mosrentgen, Moscow 142704, RU

- (51) MKP  
**A61K 31/13 2006 (97) EP 3630772**  
**A61K 31/27 2006**  
**A61K 31/444 2006**  
**C07D 487/04 2006**
- (96) EP 18805780.6 5/25/2018  
 (97) EP 3630772, 1/13/2021 202102, en
- (31) 201762511367 P (32) 26.05.2017 (33) US
- (54) METHODS OF MAKING AND USING PDE9 INHIBITORS  
 (71) Imara Inc., 116 Huntington Avenue, Boston, MA 02116, US

- (72) SVENSTRUP, Niels, 227 Summit Ave Apt E204, Brookline, Massachusetts 02446, US  
 ZHANG, Jun, 12 Taihua Road Tianjin-Economic-Technological Development Area, Tianjin 300000, CN  
 SUN, Jikui, Room 1-2303 7th Building Bin Shang Hua Yuan Jinshan South Road Tianjin-Economic-Technological Development Area, Tianjin 300000, CN  
 CHEN, Yuyin, 4-3-602 Xinyuan Street 15 Haidian, Beijing 100000, CN  
 KONG, Jianshe, 15 Cobblers Circle, Franklin Park, New Jersey 08823, US  
 MA, Rujian, Room 1601 No.12 Lane 403 Guanshengyuan Road Xuhui District, Shanghai 200235, CN  
 ZHANG, Junhua, Room 15-Jia-1604 Feng Lin Ya Du Bei Gang Street Zhonglou District, Changzhou Jiangsu 213000, CN  
 QIN, Liang, Room 2104 Building 5 Feng Huang Ming Cheng Long Hu Tang Street Xinbei District, Changzhou Jiangsu 213000, CN  
 XIAO, Huanming, 6 Tai-He Road BDA, Beijing 100176, CN  
 SUN, Jinxu, 6 Tai-He Road BDA, Beijing 100176, CN  
 MENG, Xiao, 90 Delin Road Waigaoqiao Free Trade Zone, Shanghai 200131, CN  
 SUN, Fenglai, 90 Delin Road Waigaoqiao Free Trade Zone, Shanghai 200131, CN  
 ZHU, Jingyang, 30 Yorktown Road, Monmouth Junction, New Jersey 08852, US

- (51) MKP  
**C07K 14/195 2006 (97) EP 3630962**  
**C07K 14/405 2006**  
**C12N 9/04 2006**  
**C12N 15/00 2006**  
**C12N 15/53 2006**  
**C12N 15/62 2006**
- (96) EP 18806825.8 5/25/2018  
 (97) EP 3630962, 1/20/2021 202103, en
- (31) 201762511194 P (32) 25.05.2017 (33) US  
 201762567417 P 03.10.2017 US
- (54) CBLB ENDONUCLEASE VARIANTS, COMPOSITIONS, AND METHODS OF USE  
 (72) JARJOUR, Jordan, 11014 37th Avenue SW, Seattle, Washington 98146, US  
 HAVENS, Kyle, 711 Bellevue Avenue E Apt. 107, Seattle, Washington 98102, US  
 KROSTAG, Anne-Rachel, 3528 NE 189th Place, Lake Forest Park, Washington 98155, US

- (51) MKP  
**C07C 311/07 2006 (97) EP 3630738**  
**C07D 271/06 2006**
- (96) EP 18806925.6 5/18/2018  
 (97) EP 3630738, 3/10/2021 202110, en
- (31) 1700216 (32) 22.05.2017 (33) HU
- (54) PROCESS FOR THE PRODUCTION OF OZANIMOD  
 (72) PORCS-MAKKAY, Márta, Dorozsmai utca 211-213 6 lph, 1142 Budapest, HU  
 SIMIG, Gyula, Hollósy Simon u. 25., 1126 Budapest, HU  
 MOLNÁR, Eniko, Titkár utca 16., 2030 Érd, HU  
 PETHO, János, Páskomliget u. 51, 1156 Budapest, HU  
 VOLK, Balázs, Pílisi u. 54, 1106 Budapest, HU  
 SZLÁVIK, László, Jász u. 57. II/9, 1135 Budapest, HU  
 SZABÓ, Éva, Menyhért u. 14., 1162 Budapest, HU  
 HALÁSZ, Judit, Erdosor út 11., 1046 Budapest, HU

- (51) MKP  
**C07K 16/28 2006 (97) EP 3674320**  
**C07K 16/46 2006**
- (96) EP 19174712.0 10/26/2012  
 (97) EP 3674320, 3/24/2021 202112, en
- (31) PA201100826 (32) 27.10.2011 (33) DK  
 201161552272 P 27.10.2011 US
- (54) PRODUCTION OF HETERODIMERIC PROTEINS  
 (72) GRAMER, Michael, 484 Linden Lane, Lino Lakes, Minnesota 55014, US  
 KUNDU, Amitava, 6275 Ranier Lane North, Maple Grove, Minnesota 55311, US  
 VAN DEN BREMER, Ewald T J, c/o Genmab B.V. Uppsalalaan 15, 3584 CT Utrecht, NL  
 VAN KAMPEN, Muriel, c/o Genmab B.V. Uppsalalaan 15, 3584 CT Utrecht, NL  
 PRIEM, Patrick, c/o Genmab B.V. Uppsalalaan 15, 3584 CT Utrecht, NL  
 MEESTERS, Joyce I, c/o Genmab B.V. Uppsalalaan 15, 3584 CT Utrecht, NL  
 NEIJSSSEN, Joost J, c/o Genmab B. V. Uppsalalaan 15, 3584 CT Utrecht, NL  
 SCHUURMAN, Janine, c/o Genmab B. V. Uppsalalaan 15, 3584 CT Utrecht, NL  
 PARRIN, Paul, Werdorperwaard 17, 3984 PR Odijk, NL

VAN BERKEL, Patrick, Derde Westerparklaan 321, 3544-NH Utrecht, NL  
 VOS, Werner L, Planetenlaan 100, 3712 XS Huis ter Heide, NL  
 LABRIJN, Aran F, c/o Genmab B. V. Uppsalalaan 15., 3584 CT Utrecht, NL

(51) MKP  
**G06K 9/62 2006 (97) EP 3633549**

(96) EP 18810647.0 3/16/2018  
 (97) EP 3633549, 3/10/2021 202110, en  
 (31) 201710406726 (32) 02.06.2017 (33) CN

(54) FACIAL DETECTION TRAINING METHOD, APPARATUS AND ELECTRONIC DEVICE  
 (72) WANG, Hao, 35/F, Tencent Building Kejizhongyi Road Midwest District of Hi-tech Park Nanshan District, Shenzhen, Guangdong 518057, CN  
 LI, Zhifeng, 35/F, Tencent Building Kejizhongyi Road Midwest District of Hi-tech Park Nanshan District, Shenzhen, Guangdong 518057, CN  
 JI, Xing, 35/F, Tencent Building Kejizhongyi Road Midwest District of Hi-tech Park Nanshan District, Shenzhen, Guangdong 518057, CN  
 JIA, Fan, 35/F, Tencent Building Kejizhongyi Road Midwest District of Hi-tech Park Nanshan District, Shenzhen, Guangdong 518057, CN  
 WANG, Yitong, 35/F, Tencent Building Kejizhongyi Road Midwest District of Hi-tech Park Nanshan District, Shenzhen, Guangdong 518057, CN

(51) MKP  
**A47L 15/42 2006 (97) EP 3631074**  
**D06F 39/00 2020**  
**D06F 39/14 2006**  
**E05B 15/02 2006**  
**E05B 15/04 2006**  
**E05B 47/00 2006**  
**E05C 3/24 2006**  
**E05C 5/02 2006**

(96) EP 18816524.5 5/17/2018  
 (97) EP 3631074, 3/17/2021 202111, en  
 (31) 201707943 (32) 30.05.2017 (33) TR

(54) SELF-ADJUSTING LOCK SYSTEM  
 (71) Serdar Plastik Sanayi Ve Ticaret Anonim Sirketi, Türkmenistan Caddesi No:1-3 OSB, 06395 Sincan/Ankara, TR  
 (72) TÜTEK, Serdar, Türkmenistan Cad No:3 Sincan OSB, Sincan/Ankara, TR

(51) MKP  
**A47L 15/42 2006 (97) EP 3629879**  
**D06F 34/22 2020**

(96) EP 18817006.2 5/17/2018  
 (97) EP 3629879, 3/17/2021 202111, en  
 (31) 201707951 (32) 30.05.2017 (33) TR

(54) POLLUTION MEASURING SENSOR HOUSING  
 (72) TÜTEK, Serdar, Türkmenistan Cad No:3 Sincan OSB, Sincan/Ankara, TR

(51) MKP  
**A47L 15/42 2006 (97) EP 3631253**

(96) EP 18818337.0 5/17/2018  
 (97) EP 3631253, 3/17/2021 202111, en  
 (31) 201707938 (32) 30.05.2017 (33) TR

(54) STATIONARY SEALING GASKET  
 (72) TÜTEK, Serdar, Türkmenistan Cad No:3 OSB, Sincan/Ankara, TR

(51) MKP  
**A45D 19/02 2006 (97) EP 3799553**  
**A61K 8/92 2006**  
**A61Q 5/06 2006**

(96) EP 19755675.6 6/13/2019  
 (97) EP 3799553, 4/7/2021 202114, fr  
 (54) DEVICE IN THE FORM OF A PIECE OF FELT CONTAINING A COMPOSITION FOR INSTANTLY COLOURING WHITE BEARD HAIRS AND WHITE HAIRS  
 (71) Smith, Cédric, 52, rue de la Goutte d'Or, 75018 Paris, FR  
 (72) Smith, Cédric, 52, rue de la Goutte d'Or, 75018 Paris, FR

(51) MKP  
**E01B 29/32 2006 (97) EP 3783151**  
 (96) EP 19192517.1 8/20/2019  
 (97) EP 3783151, 3/10/2021 202110, de  
 (54) DEVICE FOR FIXING AND POSITIONING A RAIL MONITORING ELEMENT AND USE OF SAID DEVICE  
 (72) SCHICKER, Kai, Am Wiesengrund 9, 08539 Mehltheuer, DE  
 OLDEWURTEL, Kassen, Trollingerweg 13, 71706 Markgröningen, DE

---

(51) MKP  
**B61L 3/00 2006 (97) EP 3782869**  
**B61L 27/00 2006**  
 (96) EP 19193069.2 8/22/2019  
 (97) EP 3782869, 3/10/2021 202110, de  
 (54) TRAIN CONTROL SYSTEM AND METHOD FOR CONTROLLING A TRAIN WITHIN A TRAIN CONTROL SYSTEM  
 (72) WIPPLINGER, Gerhard, Lacknergasse 15/38, 1170 Wien, AT  
 DE LA SIERRA APARICIO, Maria de los Ángeles, Calle del Amparo 22, 28012 Madrid, ES

---

(51) MKP  
**C01B 17/765 2006 (97) EP 3792220**  
**C01B 17/775 2006**  
**C01B 17/80 2006**  
**C01B 17/90 2006**  
 (96) EP 19196933.6 9/12/2019  
 (97) EP 3792220, 3/17/2021 202111, de  
 (54) METHOD AND DEVICE FOR OBTAINING SULPHURIC ACID FROM CONTAMINATED SULPHUR-CONTAINING MEDIA  
 (71) P & P Industries AG, Dietrich Keller Strasse 24/7, 8074 Raaba, AT  
 (72) Goritschnig, Peter, Tomscheweg 91, 8301 Lassnitzhöhe, AT

---

(51) MKP  
**E21D 9/00 2006 (97) EP 3795797**  
 (96) EP 19198167.9 9/19/2019  
 (97) EP 3795797, 3/24/2021 202112, en  
 (54) HIGH EFFICIENCY AND LOW ENVIRONMENTAL IMPACT TUNNELING SYSTEM  
 (71) Grasso, Vincenzo, Viale Monza 143, 20125 Milano (MI), IT  
 (72) Grasso, Vincenzo, viale Monza 143, 20125 Milano, IT  
 Micheli, Loris, ST GEORGE S PARK - Paceville - ST JULIANS VERDALA BUILDING, Paceville, STJ 3141, MT

---

(51) MKP  
**A61K 31/506 2006 (97) EP 3659621**  
**A61K 39/395 2006**  
**A61P 35/00 2006**  
**C07K 16/28 2006**  
 (96) EP 19199437.5 9/11/2015  
 (97) EP 3659621, 1/13/2021 202102, en  
 (31) 201462050116 P (32) 13.09.2014 (33) US  
 201462059788 P 03.10.2014 US  
 201562119060 P 20.02.2015 US  
 201562199030 P 30.07.2015 US  
 (54) COMBINATION THERAPIES FOR CANCER  
 (72) LEBWOHL, David, Novartis Pharmaceuticals Corporation One Health Plaza, East Hanover, NJ 07936, US  
 PETERS, Malte, Erstfeldstrasse 74, 4054 Basel, CH

---

(51) MKP  
**A61P 35/00 2006 (97) EP 3660050**  
**C07K 16/28 2006**  
 (96) EP 19201227.6 3/13/2015  
 (97) EP 3660050, 1/13/2021 202102, en  
 (31) 201461953536 P (32) 14.03.2014 (33) US  
 201462059690 P 03.10.2014 US  
 201462094889 P 19.12.2014 US  
 (54) ANTIBODY MOLECULES TO LAG-3 AND USES THEREOF  
 (71) Immutep S.A.S., Parc Club Orsay 2 Rue Jean Rostand, 91893 Orsay, FR

(72) TRIEBEL, Frederic, 10 Rue Saint Louis, F-78000 Versailles, FR  
 BRIGNONE, Chrystelle, 4D rue Leon Martine Batiment D Appartement 02, F-92290 Chatenay-Malabry, FR  
 BLATTLER, Walter A., 197 Mason Terrace, Brookline, MA Massachusetts 02446-2768, US  
 MATARAZA, Jennifer Marie, 250 Massachusetts Avenue, Cambridge, MA Massachusetts 02139, US  
 SABATOS-PEYTON, Catherine Anne, 250 Massachusetts Avenue, Cambridge, MA Massachusetts 02139, US  
 CHANG, Hwai Wen, 1318 Shadow Hills Drive, San Marcos, CA California 92069, US  
 FREY, Gerhard Johann, 13768 Via Cima Bella, San Diego, CA California 92129, US

---

(51) MKP  
**A61B 17/00 2006 (97) EP 3785642**

(96) EP 18916061.7 6/29/2018  
 (97) EP 3785642, 3/3/2021 202109, en  
 (31) 201810371746 (32) 24.04.2018 (33) CN

(54) SPONGE-BASED VARIABLE-STIFFNESS NATURAL ORIFICE SURGERY INSTRUMENT SUPPORT STRUCTURE AND USE METHOD THEREFOR

(72) WANG, Shuxin, No. 135 Yaguan Road, Haihe Education Park, Jinnan District, Tianjin 300354, CN  
 REN, Xuyang, No. 135 Yaguan Road, Haihe Education Park, Jinnan District, Tianjin 300354, CN  
 ZHANG, Guokai, No. 135 Yaguan Road, Haihe Education Park, Jinnan District, Tianjin 300354, CN  
 SHANG, Zufeng, No. 135 Yaguan Road, Haihe Education Park, Jinnan District, Tianjin 300354, CN  
 LI, Jinhua, No. 135 Yaguan Road, Haihe Education Park, Jinnan District, Tianjin 300354, CN

---

(51) MKP  
**H04L 29/06 2006 (97) EP 3793157**

(96) EP 18917855.1 5/9/2018  
 (97) EP 3793157, 3/17/2021 202111, en  
 (54) METHOD AND DEVICE FOR BLOCKCHAIN NODE

(71) Hefei Dappworks Technology Co., Ltd., 10F, Block C, Building J2 The second phase of Innovation Industrial Park No. 2800 Wangjiangxilu Hi-Tech Area, Hefei, Anhui 230031, CN

(72) ZHANG, Yan, 10F, Block C, Building J2, The Second Phase Of Innovation Industrial Park, No. 2800 Wangjiangxilu Hi-Tech Area, Hefei Anhui 230031, CN  
 SHI, Yi, 10F, Block C, Building J2, The Second Phase Of Innovation Industrial Park, No. 2800 Wangjiangxilu Hi-Tech Area, Hefei Anhui 230031, CN

---

(51) MKP  
**H04L 29/06 2006 (97) EP 3793158**

(96) EP 18918012.8 5/9/2018  
 (97) EP 3793158, 3/17/2021 202111, en  
 (54) METHOD AND DEVICE FOR REACHING CONSENSUS IN BLOCKCHAIN

(72) ZHANG, Yan, 10F, Block C, Building J2, the second phase of Innovation Industrial Park No. 2800 Wangjiangxilu, Hi-Tech Area, Hefei, Anhui 230031, CN  
 SHI, Yi, 10F, Block C, Building J2, the second phase of Innovation Industrial Park No. 2800 Wangjiangxilu, Hi-Tech Area, Hefei, Anhui 230031, CN

---

(51) MKP  
**B25J 9/16 2006 (97) EP 3793781**

(96) EP 18918462.5 5/18/2018  
 (97) EP 3793781, 3/24/2021 202112, en  
 (54) SYSTEM AND METHOD FOR CONTROLLING A ROBOTIC WRIST

(72) HARIRI, Alireza, 1415 Berkeley Way, Berkeley, CA 94702, US  
 NIA KOSARI, Sina, 4336 Lombard Avenue, Fremont, CA 94536, US

---

(51) MKP  
**H02G 3/06 2006 (97) EP 3681001**

(96) EP 19000555.3 12/12/2019  
 (97) EP 3681001, 1/27/2021 202104, en  
 (31) 201900007 (32) 09.01.2019 (33) SI

(54) CABLE TRAY CONNECTING DEVICE

(71) Hermi, d.o.o., Trnovije pri Celju Trnoveljska cesta 15, 3000 Celje, SI  
 (72) Stvarnik, Bostjan, Laze 17 c, 3320 Velenje, SI

(51) MKP  
**A01M 15/00 2006 (97) EP 3770498**  
**F23D 14/38 2006**  
**F23D 14/46 2006**  
**F23Q 3/00 2006**  
(96) EP 19425054.4 7/22/2019  
(97) EP 3770498, 1/27/2021 202104, en  
(54) PORTABLE GAS TOOL  
(71) Gnali Bocia S.r.l., Via Brescia 41 M/N, 25065 Lumezzane (Brescia), IT  
(72) Gnali, Luigi, c/o Gnali Bocia S.r.l., via Brescia, 41 M/N, 25065 Lumezzane (BS), IT  
Gnali, Gianbattista, c/o Gnali Bocia S.r.l., via Brescia, 41 M/N, 25065 Lumezzane (BS), IT  
Gnali, Andrea, c/o Gnali Bocia S.r.l., via Brescia, 41 M/N, 25065 Lumezzane (BS), IT

(51) MKP  
**G01K 1/14 2021 (97) EP 3795965**  
**G01K 1/16 2006**  
(96) EP 19425068.4 9/19/2019  
(97) EP 3795965, 3/24/2021 202112, en  
(54) SUPPORT SYSTEM FOR SUPPORTING AN ENVIRONMENTAL TEMPERATURE SENSOR IN RAILWAY SECTOR  
(72) CAVALIERI, Filippo, Via Lazzerà 19/A, 59015 Carmignano (PO), IT

(51) MKP  
**G16H 20/40 2018 (97) EP 3699921**  
**G16H 40/20 2018**  
(96) EP 19464002.5 2/22/2019  
(97) EP 3699921, 4/7/2021 202114, en  
(54) OPTIMIZING CATHETERIZATION LABORATORY THROUGHPUT USING MACHINE LEARNING  
(72) Sharma, Puneet, 12 Stanford Pl., Princeton Junction, NJ 08550, US  
Itu, Lucian Mihai, Str. Mestecanis nr. 3, bl. A35, sc. B, ap. 24, 500294 Brasov, jud. Brasov, RO  
Passerini, Tiziano, 12 S. Linden Lane, Plainsboro, NJ 08536, US

(51) MKP  
**A61L 2/08 2006 (97) EP 3781216**  
**H01J 61/00 2006**  
(96) EP 18836383.2 11/14/2018  
(97) EP 3781216, 2/24/2021 202108, en  
(31) 1800124 (32) 16.04.2018 (33) HU  
(54) EQUIPMENT WITH RADIATION SOURCE FOR FACILITATING KILLING HARMFUL MICROORGANISMS, ESPECIALLY FOR FACILITATION OF CONSERVATION OF FOOD  
(71) MÁTÉ, Viktor, Fenyő u. 18., 3872 Cserszegtomaj, HU  
(72) MÁTÉ, Viktor, Fenyő u. 18., 3872 Cserszegtomaj, HU

(51) MKP  
**A61K 31/517 2006 (97) EP 3762379**  
**A61K 31/519 2006**  
**A61P 35/00 2006**  
**C07D 403/04 2006**  
**C07D 403/14 2006**  
**C07D 407/14 2006**  
**C07D 487/04 2006**  
(96) EP 19707025.3 3/1/2019  
(97) EP 3762379, 1/13/2021 202102, en  
(31) 18160540 (32) 07.03.2018 (33) EP  
(54) IDENTIFICATION AND USE OF ERK5 INHIBITORS  
(72) NGUYEN, Duy, Heinrich-Heine-Straße 27, 10179 Berlin, DE  
WORTMANN, Lars, Kastanienallee 103, 10435 Berlin, DE  
FARIA ALVARES DE LEMOS, Adelaide, Clara, Akazienstrasse 28, 10823 Berlin, DE  
BÖMER, Ulf, Leipziger Str. 49, 16548 Glienicke, DE  
SÜLZLE, Detlev, Otternweg 15, 13465 Berlin, DE  
HOLTON, Simon, Niklasstrasse 14a, 14163 Berlin, DE  
LECHNER, Christian, Levetzowstraße 23d, 10555 Berlin, DE

(51) MKP  
**A61M 5/315 2006 (97) EP 3762074**

(96) EP 19707577.3 2/12/2019  
 (97) EP 3762074, 1/13/2021 202102, en  
 (31) 201862639754 P (32) 07.03.2018 (33) US

(54) CONTROLLED DISPENSE SYRINGE  
 (72) PEREZ-PACHECO, Joel, 739 Arneill Road, Camarillo, CA 93010, US  
 RING, Lawrence, Scott, 370 Jeremiah Drive B, Simi Valley, CA 93065, US

(51) MKP  
**A61K 47/68 2017 (97) EP 3765493**  
**C07K 16/10 2006**  
**C07K 16/28 2006**  
**C07K 16/30 2006**

(96) EP 19710414.4 3/12/2019  
 (97) EP 3765493, 1/20/2021 202103, en  
 (31) 18161293 (32) 12.03.2018 (33) EP  
 18175347 31.05.2018 EP

(54) ANTIBODIES  
 (72) SATIJN, David, c/o Genmab B.V. Uppsalalaan 15, 3584 CT Utrecht, NL  
 BREIJ, Esther, C, W., c/o Genmab B.V. Uppsalalaan 15, 3584 CT Utrecht, NL  
 DE GOEIJ, Bart,E,C,G., c/o Genmab B.V. Uppsalalaan 15, 3584 CT Utrecht, NL  
 KEMPER, Kristel, c/o Genmab B.V. Uppsalalaan 15, 3584 CT Utrecht, NL  
 ENGELBERTS, Patrick, c/o Genmab B.V. Uppsalalaan 15, 3584 CT Utrecht, NL  
 VAN DEN BRINK, Edward,N., c/o Genmab B.V. Uppsalalaan 15, 3584 CT Utrecht, NL  
 RADEMAKER, Rik, c/o Genmab B.V. Uppsalalaan 15, 3584 CT Utrecht, NL  
 VERZIJL, Dennis, c/o Genmab B.V. Uppsalalaan 15, 3584 CT Utrecht, NL  
 HORBACH, Sjeng, Polderkade 1, 5345 RR Oss, NL  
 PARREN, Paul, Werdorperwaard 17, 3984 PR Odijk, NL

(51) MKP  
**A61K 39/395 2006 (97) EP 3765508**  
**A61P 35/00 2006**  
**C07K 16/28 2006**

(96) EP 19710681.8 3/12/2019  
 (97) EP 3765508, 1/20/2021 202103, en  
 (31) 201862642292 P (32) 13.03.2018 (33) US

(54) TREATMENT OF HEAD AND NECK CANCER  
 (72) BOYER-CHAMMARD, Agnès, 82 Boulevard de Nice, 13008 Marseille, FR  
 DODION, Pierre, 69 Memling dreef, 3090 Overijse, BE  
 COHEN, Roger, B, 1531 Amity Road, Jenkintown, PA 19046, US

(51) MKP  
**C07K 16/12 2006 (97) EP 3765495**

(96) EP 19710685.9 3/13/2019  
 (97) EP 3765495, 1/20/2021 202103, en  
 (31) 18161521 (32) 13.03.2018 (33) EP

(54) SINGLE DOMAIN ANTIBODIES BINDING TO TETANUS NEUROTOXIN  
 (71) Smivet B.V., Diemewei 4110, 6605 XC Wijchen, NL  
 (72) DE SMIT, Abraham Johannes, Diemewei 4110, 6605 XC Wijchen, NL  
 HARMSEN, Michaël Marie, Roskamstraat 26, 1381 AM Weesp, NL

(51) MKP  
**C25C 3/08 2006 (97) EP 3765657**  
**C25C 3/16 2006**  
**C25C 7/00 2006**  
**C25C 7/02 2006**

(96) EP 19710746.9 2/14/2019  
 (97) EP 3765657, 1/20/2021 202103, fr  
 (31) 1852129 (32) 12.03.2018 (33) FR



- (54) CATHODE ASSEMBLY FOR ELECTROLYTIC CELL  
 (71) Tokai Carbon Savoie, 30 rue Louis Jouvét, 69200 Venissieux, FR  
 Metsol AG, Europa-Strasse 19a, 8152 Glattbrugg, CH  
 (72) DRAGO DRAGUTIN, Juric, c/o Metsol AG Europa-Strasse 19a, 8152 Glattbrugg, CH  
 RIVOALAND, Loig, c/o CARBONE SAVOIE Notre Dame de Briançon, 73260 Aigueblanche, FR
- 

- (51) MKP  
**A61K 31/7088 2006 (97) EP 3765477**  
**A61K 48/00 2006**  
**C07H 21/02 2006**  
**C12N 5/07 2010**  
**C12N 15/11 2006**  
 (96) EP 19711343.4 3/14/2019  
 (97) EP 3765477, 1/20/2021 202103, en  
 (31) PCT/EP2018/056595 (32) 15.03.2018 (33) WO  
 (54) 5'-CAP-TRINUCLEOTIDE- OR HIGHER OLIGONUCLEOTIDE COMPOUNDS AND THEIR USES IN STABILIZING RNA, EXPRESSING  
 PROTEINS AND IN THERAPY  
 (72) KUHN, Andreas, c/o BioNTech RNA Pharmaceuticals GmbH An der Goldgrube 12, 55131 Mainz, DE  
 MURAMATSU, Hiromi, c/o BioNTech RNA Pharmaceuticals GmbH An der Goldgrube 12, 55131 Mainz, DE  
 KARIKO, Katalin, c/o BioNTech RNA Pharmaceuticals GmbH An der Goldgrube 12, 55131 Mainz, DE  
 FESSER, Stephanie, c/o BioNTech RNA Pharmaceuticals GmbH An der Goldgrube 12, 55131 Mainz, DE  
 SAHIN, Ugur, c/o BioNTech RNA Pharmaceuticals GmbH An der Goldgrube 12, 55131 Mainz, DE
- 

- (51) MKP  
**A61K 31/16 2006 (97) EP 3765439**  
**A61P 37/00 2006**  
**C07C 233/60 2006**  
 (96) EP 19711350.9 3/15/2019  
 (97) EP 3765439, 1/20/2021 202103, en  
 (31) 18162244 (32) 16.03.2018 (33) EP  
 (54) NOVEL CALCIUM SALT POLYMORPHS AS ANTI-INFLAMMATORY, IMMUNOMODULATORY AND ANTI-PROLIFERATORY AGENTS  
 (72) VITT, Daniel, Obere Bahnhofstrasse 7A, 82110 Germering, DE  
 MÜHLER, Andreas, Krüner Strasse 37, 81373 München, DE  
 GRÖPPEL, Manfred, Nägelsbachstr. 29a, 91052 Erlangen, DE  
 KOHLHOF, Hella, Stöhrstrasse 11, 81477 München, DE
- 

- (51) MKP  
**H05K 7/14 2006 (97) EP 3791701**  
**H05K 7/18 2006**  
 (96) EP 19711595.9 3/16/2019  
 (97) EP 3791701, 3/17/2021 202111, de  
 (54) RACK AND SERVER CABINET OR NETWORK CABINET HAVING A RACK  
 (71) EFB-Elektronik GmbH, Striegauer Straße 1, 33719 Bielefeld, DE  
 (72) HARMS, Andreas, An der Hellrüsche 22, 32105 Bad Salzuflen, DE  
 NELLES, Marcus, Riemekestraße 124A, 33102 Paderborn, DE  
 SÖRENSEN, Kim H., Møllemosen 71, 2760 Malov, DK  
 KJAERHOLT SCHMIDT, Kristian, Ryttervaenget 5, 4390 Vipperød, DK
- 

- (51) MKP  
**A61K 31/4025 2006 (97) EP 3762380**  
**A61K 31/4439 2006**  
**A61K 31/506 2006**  
**A61P 9/00 2006**  
**C07D 207/14 2006**  
**C07D 401/10 2006**  
**C07D 401/12 2006**  
**C07D 403/10 2006**  
**C07D 403/12 2006**  
**C07D 405/10 2006**  
**C07D 409/12 2006**  
**C07D 413/10 2006**  
**C07D 413/14 2006**

**C07D 417/10 2006**  
**C07F 9/02 2006**  
(96) EP 19711769.0 3/4/2019  
(97) EP 3762380, 1/13/2021 202102, en  
(31) 201862638556 P (32) 05.03.2018 (33) US  
(54) PHENYLPYRROLIDINONE FORMYL PEPTIDE 2 RECEPTOR AGONISTS  
(72) SHIRUDE, Pravin Sudhakar, c/o Syngene International Limited Biocon Special Economic Zone Biocon Park, Plot No. 2 & 3 Bommasandra Industrial Area IV Phase Jigani Link Road, Bommasandra, Bangalore Karnataka 560 099, IN  
BALIGAR, Vishweshwaraiiah, c/o Syngene International Limited Biocon Special Economic Zone Biocon Park, Plot No. 2 & 3 Bommasandra Industrial Area IV Phase Jigani Link Road, Bommasandra, Bangalore Karnataka 560 099, IN  
SESHADRI, Balaji, c/o Syngene International Limited Biocon Special Economic Zone Biocon Park, Plot No. 2 & 3 Bommasandra Industrial Area IV Phase Jigani Link Road, Bommasandra, Bangalore Karnataka 560 099, IN  
CHATTOPADHYAY, Amit Kumar, c/o Syngene International Limited Biocon Special Economic Zone Biocon Park, Plot No. 2 & 3 Bommasandra Industrial Area IV Phase Jigani Link Road, Bommasandra, Bangalore Karnataka 560 099, IN  
WURTZ, Nicholas R., c/o Bristol-Myers Squibb Company Route 206 and Province Line Road, Princeton, New Jersey 08543, US  
KICK, Ellen K., c/o Bristol-Myers Squibb Company Route 206 and Province Line Road, Princeton, New Jersey 08543, US

(51) MKP  
**A61K 31/5383 2006 (97) EP 3765024**  
**A61P 25/00 2006**  
**C07D 498/04 2006**  
(96) EP 19711866.4 3/13/2019  
(97) EP 3765024, 1/20/2021 202103, en  
(31) 201862642622 P (32) 14.03.2018 (33) US  
(54) NOVEL PHARMACEUTICAL FORMULATION COMPRISING DUAL NK-1/NK-3 RECEPTOR ANTAGONISTS  
(71) KaNDy Therapeutics Limited, 400 South Oak Way, Reading, Berkshire RG2 6AD, GB  
(72) TROWER, Mike, C/O NeRRe Therapeutics Limited Stevenage Bioscience Catalyst Incubator Building Gunnels Wood Road, Stevenage Hertfordshire SG1 2FX, GB  
KERR, Mary, C/O NeRRe Therapeutics Limited Stevenage Bioscience Catalyst Incubator Building Gunnels Wood Road, Stevenage Hertfordshire SG1 2FX, GB  
ELDER, David, 110 Fordwich Rise, Hertford, Hertfordshire SG14 2DE, GB  
LAZARO, Monica, C/O Catalent Pharma Solutions 2725 Scherer Drive, St. Petersburg, Florida 33716, US  
BUSH, Derek, C/O Catalent Pharma Solutions 2725 Scherer Drive, St. Petersburg, Florida 33716, US

(51) MKP  
**C03C 3/087 2006 (97) EP 3762341**  
**C03C 3/095 2006**  
**C03C 3/112 2006**  
**C03C 13/00 2006**  
**C08J 5/08 2006**  
(96) EP 19712096.7 3/5/2019  
(97) EP 3762341, 1/13/2021 202102, en  
(31) 201862639731 P (32) 07.03.2018 (33) US  
(54) GLASS COMPOSITIONS, FIBERIZABLE GLASS COMPOSITIONS, AND GLASS FIBERS MADE THEREFROM  
(71) Electric Glass Fiber America, LLC, 940 Washburn Switch Road, Shelby, NC 28150, US  
(72) LI, Hong, 3205 Rudisill Court, Stanley, North Carolina 28164, US

(51) MKP  
**B26D 1/00 2006 (97) EP 3762195**  
**B26D 1/06 2006**  
**B26D 1/09 2006**  
**B26D 3/08 2006**  
**B26D 5/00 2006**  
**B26D 5/06 2006**  
**B26D 5/08 2006**  
**B26D 7/01 2006**  
**B65D 75/58 2006**  
(96) EP 19712293.0 3/4/2019  
(97) EP 3762195, 1/13/2021 202102, en  
(31) 201800003287 (32) 05.03.2018 (33) IT  
(54) INCISION STATION FOR PACKAGING MACHINE AND RELATIVE INCISION METHOD  
(72) Amato, Rosario, Via Bonfiglioli, 9, I - 40050 Monte San Pietro (BO), IT

(51) MKP  
**A61K 31/4985 2006 (97) EP 3762389**  
**A61P 25/00 2006**  
**C07D 487/04 2006**  
(96) EP 19712427.4 3/7/2019  
(97) EP 3762389, 1/13/2021 202102, en  
(31) 201862639846 P (32) 07.03.2018 (33) US  
(54) CRYSTALLINE FORMS OF AN SGC STIMULATOR  
(72) NTI-ADDAE, Kwame, W., c/o Cycleron Therapeutics, Inc. 301 Binney Street, Cambridge, MA 02142, US  
PRASAD, Leena, Kumari, c/o Cycleron Therapeutics, Inc. 301 Binney Street, Cambridge, MA 02142, US  
STORZ, Thomas, c/o Cycleron Therapeutics, Inc. 301 Binney Street, Cambridge, MA 02142, US

---

(51) MKP  
**A61M 5/14 2006 (97) EP 3762067**  
**A61M 5/142 2006**  
(96) EP 19712484.5 3/8/2019  
(97) EP 3762067, 1/13/2021 202102, en  
(31) 201862640934 P (32) 09.03.2018 (33) US  
(54) BACKFLOW PREVENTION MECHANISM FOR DRUG DELIVERY DEVICE  
(72) RING, Lawrence, Scott, 370 Jeremiah Drive B, Simi Valley, CA 93065, US  
PIRBODAGHI, Tohid, 318 Rindge Ave, 215, Cambridge, MA 02140, US  
AKBARI, Samin, 318 Rindge Ave, 215, Cambridge, MA 02140, US  
GROSZMANN, Daniel, Eduardo, 236 Cross St., Belmont, MA 02478, US  
MOJARRAD, Mehran, 2389 Fountain Crest Lane, 23, Thousand Oaks, CA 91362, US  
GORDON, Mark, Law Department - Patent Operations One Amgen Center Drive, Thousand Oaks, CA 91320-1799, US  
TIKH, Mikhail, 1841 Nevada Ave. S., St. Louis Park, MN 55426, US  
WARD, Jimmie, L., 25984 Gateway Drive, Golden, CO 80459, US  
GIBSON, Scott, R., 12141 Bellando Court, Granada Hills, CA 91344, US  
MOBERG, Sheldon, B., 1030 Chalet Circle, Thousand Oaks, CA 91362, US  
TAMSKY, Joshua, 1015 Sancorn Ave., Los Angeles, CA 90029, US  
FAUCHER, Paul, C/o Novo Engineering 1350 Specialty Drive, Suite A, Vista, CA 92081, US  
LIND, Jeff, c/o Amgen Inc. One Amgen Center Drive Mail Stop 28-5-A, Thousand Oaks, CA 91320-1799, US

---

(51) MKP  
**A61K 31/7088 2006 (97) EP 3765476**  
**A61P 25/28 2006**  
**C07H 21/00 2006**  
**C12N 15/113 2010**  
(96) EP 19712535.4 3/13/2019  
(97) EP 3765476, 1/20/2021 202103, en  
(31) 201862642499 P (32) 13.03.2018 (33) US  
(54) MODIFIED OLIGONUCLEOTIDES FOR USE IN TREATMENT OF TAUOPATHIES  
(72) EBNETH, Andreas, Turnhoutseweg 30, 2340 Beerse, BE  
VAN OUYRYVE D'YDEWALLE, Constantin, Turnhoutseweg 30, 2340 Beerse, BE  
GRYAZNOV, Sergei, 260E.Grand Ave.,2nd Floor South, San Francisco, CA 94080, US  
MARTINEZ MONTERO, Saúl, 260 E.Grand Ave., 2nd Floor, South, San Francisco, CA 94080, US  
RAJWANSHI, Vivek Kumar, 260 E Grand Ave, 2nd Floor South, San Francisco, CA 94080, US  
BEIGELMAN, Leonid, 260 E Grand Ave, 2nd Floor South, San Francisco, CA 94080, US

---

(51) MKP  
**A61K 31/4035 2006 (97) EP 3762365**  
**A61P 1/12 2006**  
**C07D 209/48 2006**  
(96) EP 19712695.6 3/6/2019  
(97) EP 3762365, 1/13/2021 202102, en  
(31) 201862639650 P (32) 07.03.2018 (33) US  
(54) METHODS AND COMPOSITIONS OF ISOINDOLINE-1,3-DIONE AND ISOINDOLE PRODRUGS USEFUL FOR TREATING CANCER,  
ULCERATIVE COLITIS AND RELATED INFLAMMATORY DISEASES  
(71) Amgen (Europe) GmbH, Floor 6-8 Suurstoffi 22, 6343 Risch-Rotkreuz, CH  
(72) BAKER, William R., 4759 171st Ave SE, Bellevue, Washington 98006, US

---

(51) MKP

	<b>C12N 9/22 2006</b>		<b>(97) EP 3768834</b>		
	<b>C12N 15/10 2006</b>				
(96)	EP 19712889.5 3/19/2019				
(97)	EP 3768834, 1/27/2021 202104, en				
(31)	18162683	(32)	19.03.2018	(33)	EP
	18162681		19.03.2018		EP
	18172625		16.05.2018		EP
	18174707		29.05.2018		EP
	18181680		04.07.2018		EP
	201862745246 P		12.10.2018		US
	201862745240 P		12.10.2018		US
	201862745238 P		12.10.2018		US
	201862745239 P		12.10.2018		US
(54)	NOVEL RNA-PROGRAMMABLE ENDONUCLEASE SYSTEMS AND USES THEREOF				
(72)	COHNEN, Andre, c/o Bayer Aktiengesellschaft Kaiser-Wilhelm-Allee, 51368 Leverkusen, DE				
	SCHMIDT, Moritz, c/o Bayer Aktiengesellschaft Kaiser-Wilhelm-Allee, 51368 Leverkusen, DE				
	COCO, Wayne, c/o Bayer Aktiengesellschaft Kaiser-Wilhelm-Allee, 51368 Leverkusen, DE				
	GAMALINDA, Michael, Biag, c/o Bayer Aktiengesellschaft Kaiser-Wilhelm-Allee, 51368 Leverkusen, DE				
	GUPTA, Ashish, c/o Bayer Aktiengesellschaft Kaiser-Wilhelm-Allee, 51368 Leverkusen, DE				
	PITZLER, Christian, c/o Bayer Aktiengesellschaft Kaiser-Wilhelm-Allee, 51368 Leverkusen, DE				
	RICHTER, Florian, c/o Bayer Aktiengesellschaft Kaiser-Wilhelm-Allee, 51368 Leverkusen, DE				
	TEBBE, Jan, c/o Bayer Aktiengesellschaft Kaiser-Wilhelm-Allee, 51368 Leverkusen, DE				
	CHENG, Christopher, c/o Casebia Therapeutics Limited Liability Partnership 455 Mission Bay Boulevard South, San Francisco, CA 94158, US				
	TAKEUCHI, Ryo, c/o Casebia Therapeutics Limited Liability Partnership 455 Mission Bay Boulevard South, San Francisco, CA 94158, US				
	REISS, Caroline, W., c/o Casebia Therapeutics Limited Liability Partnership 455 Mission Bay Boulevard South, San Francisco, CA 94158, US				

(51)	MKP				
	<b>C08L 1/02 2006</b>		<b>(97) EP 3765563</b>		
	<b>C08L 7/02 2006</b>				
	<b>C08L 21/00 2006</b>				
(96)	EP 19713170.9 3/18/2019				
(97)	EP 3765563, 1/20/2021 202103, en				
(31)	201804218	(32)	16.03.2018	(33)	GB
(54)	BIODEGRADABLE COATINGS FOR BIODEGRADABLE SUBSTRATES				
(71)	LONGCROFT, James Henry Stoddart, 18 Chipstead Street, London SW6 3SS, GB				
(72)	LONGCROFT, James Henry Stoddart, 18 Chipstead Street, London SW6 3SS, GB				

(51)	MKP				
	<b>C07K 14/005 2006</b>		<b>(97) EP 3768695</b>		
	<b>C12N 15/864 2006</b>				
(96)	EP 19760152.9 2/27/2019				
(97)	EP 3768695, 1/27/2021 202104, en				
(31)	201862635964 P	(32)	27.02.2018	(33)	US
	201862635968 P		27.02.2018		US
	201862663788 P		27.04.2018		US
	201862663797 P		27.04.2018		US
	201862667587 P		06.05.2018		US
	201862667888 P		07.05.2018		US
	201862667881 P		07.05.2018		US
	201862677471 P		29.05.2018		US
	201862677474 P		29.05.2018		US
	201862667585 P		29.05.2018		US
	201862703670 P		26.07.2018		US
	201862703673 P		26.07.2018		US
	201862722382 P		24.08.2018		US
	201862722388 P		24.08.2018		US
(54)	NOVEL ADENO-ASSOCIATED VIRUS (AAV) VECTORS, AAV VECTORS HAVING REDUCED CAPSID DEAMIDATION AND USES THEREFOR				
(71)	The Trustees of the University of Pennsylvania, 3600 Civic Center Boulevard, 9th Floor, Philadelphia, PA 19104, US				
(72)	WILSON, James, M., 1831 Delancey Street, Philadelphia, PA 19103, US				
	TEPE, April, 10320 Swift Stream Place, Apt. 407, Columbia, MD 21044, US				
	TURNER, Kevin, 124 Beechwood Road, Newtown Square, PA 19073, US				
	SIMS, Joshua, Joyner, 839 S. Hancock Street, Philadelphia, PA 19147, US				
	WANG, Qiang, 228 West Winona Street, Philadelphia, PA 19144, US				

(51) MKP  
**A61K 38/00 2006 (97) EP 3762036**  
**A61K 47/00 2006**  
(96) EP 19763238.3 3/8/2019  
(97) EP 3762036, 1/13/2021 202102, en  
(31) 201862640749 P (32) 09.03.2018 (33) US  
(54) MULTIVALENT PEPTIDE CONJUGATES FOR SUSTAINED INTRA-ARTICULAR TREATMENT OF JOINT INFLAMMATION  
(71) Valitor, Inc., 820 Heinz Avenue, Berkeley, California 94710, US  
(72) JACKSON, Wesley M., 820 Heinz Avenue, Berkeley, California 94710, US  
MOHAMED, Mavish, 820 Heinz Avenue, Berkeley, California 94710, US  
BRIER, Livia W., 820 Heinz Avenue, Berkeley, California 94710, US  
HEALY, Kevin E., 820 Heinz Avenue, Berkeley, California 94710, US

(51) MKP  
**H01B 5/10 2006 (97) EP 3762949**  
**H01B 7/18 2006**  
**H01B 9/00 2006**  
**H01B 13/02 2006**  
(96) EP 19763603.8 3/5/2019  
(97) EP 3762949, 1/13/2021 202102, en  
(31) 201862638436 P (32) 05.03.2018 (33) US  
(54) OVERHEAD ELECTRICAL CABLES AND METHOD FOR FABRICATING SAME  
(72) BOSZE, Eric J., 2026 McGaw Avenue, Irvine, California 92614, US  
WEBB, William, 2026 McGaw Avenue, Irvine, California 92614, US  
PILLING, Douglas A., 2026 McGaw Avenue, Irvine, California 92614, US  
WONG, Christopher, 2026 McGaw Avenue, Irvine, California 92614, US

(51) MKP  
**A61K 39/395 2006 (97) EP 3762400**  
**C07K 7/64 2006**  
**C07K 16/28 2006**  
(96) EP 19763628.5 3/8/2019  
(97) EP 3762400, 1/13/2021 202102, en  
(31) 201862640543 P (32) 08.03.2018 (33) US  
(54) ANTI-CD252 ANTIBODIES, CONJUGATES, AND METHODS OF USE  
(72) BOITANO, Anthony, 27 Evelyn Road, Newton, Massachusetts 02468, US  
COOKE, Michael, 135 University Road, No. 1, Brookline, Massachusetts 02445, US

(51) MKP  
**A61K 35/28 2015 (97) EP 3762505**  
**A61K 48/00 2006**  
**C12Q 1/34 2006**  
(96) EP 19764359.6 3/8/2019  
(97) EP 3762505, 1/13/2021 202102, en  
(31) 201862641012 P (32) 09.03.2018 (33) US  
(54) COMPOSITIONS AND METHODS FOR TREATING PARKINSON'S DISEASE  
(71) Avrobio, Inc., One Kendall Square Bldg 300, 201, Cambridge, MA 02139, US  
(72) MASON, Chris, 23 Sidney Street Apt 413, Cambridge, MA 02139, US  
VAN TIL, Nico, Peter, Wasstraat 72, 2313JK Leiden, NL  
COOPER, Oliver, 206 Chestnut Avenue, Boston, MA 02130, US

(51) MKP  
**C07K 16/18 2006 (97) EP 3762414**  
**G01N 33/53 2006**  
**G01N 33/58 2006**  
(96) EP 19764468.5 3/4/2019  
(97) EP 3762414, 1/13/2021 202102, en  
(31) 201862638524 P (32) 05.03.2018 (33) US  
(54) ASSAYS TO DETECT NEURODEGENERATION

(72) KOLB, Hartmuth Christian, 3210 Merryfield Row, San Diego, California 92121, US  
 TRIANA-BALTZER, Gallen, 3210 Merryfield Row, San Diego, California 92121, US  
 SLEMMON, John Randall, 3210 Merryfield Row, San Diego, California 92121, US

(51) MKP  
**A61K 39/395 2006 (97) EP 3762032**  
**A61P 35/00 2006**  
**C07K 16/28 2006**

(96) EP 19764722.5 3/6/2019

(97) EP 3762032, 1/13/2021 202102, en

(31) 201862639891 P (32) 07.03.2018 (33) US  
 201862736343 P 25.09.2018 US

(54) ANTI-TISSUE FACTOR ANTIBODY-DRUG CONJUGATES AND THEIR USE IN THE TREATMENT OF CANCER

(72) BREIJ, Esther, c/o Genmab B.V. Uppsalalaan 15, 3584 CT Utrecht, NL  
 SATIJN, David, c/o Genmab B.V. Uppsalalaan 15, 3584 CT Utrecht, NL  
 VERPLOEGEN, Sandra, c/o Genmab B.V. Uppsalalaan 15, 3584 CT Utrecht, NL  
 BAKEMA, Jantine, c/o Genmab B.V. Uppsalalaan 15, 3584 CT Utrecht, NL  
 ABIDOYE, Oyewale O., 11012 SE 64th Street, Bellevue, Washington 98006, US  
 NICACIO, Leonardo Viana, 17409 NE 116th Way, Redmond, Washington 98052, US  
 LINGNAU, Andreas, Bad Woerisher Strasse 14b, 87719 Mindelheim, DE  
 RANGWALA, Reshma Abdulla, 7801 Lincoln Drive, Philadelphia, Pennsylvania 19118, US

(51) MKP  
**A61K 38/17 2006 (97) EP 3762015**  
**A61K 39/395 2006**  
**A61P 37/02 2006**  
**C07K 14/54 2006**  
**C07K 16/24 2006**

(96) EP 19764856.1 3/4/2019

(97) EP 3762015, 1/13/2021 202102, en

(31) 201862638624 P (32) 05.03.2018 (33) US

(54) METHODS OF TREATING CROHN'S DISEASE WITH ANTI-IL23 SPECIFIC ANTIBODY

(72) CHAN, Daphne, 1400 McKean Road, Spring House, Pennsylvania 19477, US  
 ADEDOKUN, Omoniyi, 1400 McKean Road, Spring House, Pennsylvania 19477, US  
 CHEN, Yang, 1400 McKean Road, Spring House, Pennsylvania 19477, US  
 SZAPARY, Philippe, 1400 McKean Road, Spring House, Pennsylvania 19477, US

(51) MKP  
**F41A 9/62 2006 (97) EP 3762674**  
**G01D 5/12 2006**

(96) EP 19764892.6 3/8/2019

(97) EP 3762674, 1/13/2021 202102, en

(31) 201862640451 P (32) 08.03.2018 (33) US

(54) FIREARM AMMUNITION AVAILABILITY DETECTION SYSTEM

(71) Maztech Industries, LLC, 35 Peters Canyon Road, Irvine, CA 92606, US  
 MASARIK, David Michael, 35 Peters Canyon Road, Irvine, California 92606, US  
 MASARIK, Michael Raymond, 35 Peters Canyon Road, Irvine, California 92606, US  
 MASARIK, Matthew James, 35 Peters Canyon Road, Irvine, California 92606, US

(51) MKP  
**A61K 31/4375 2006 (97) EP 3761980**  
**C07D 401/12 2006**

(96) EP 19765136.7 3/7/2019

(97) EP 3761980, 1/13/2021 202102, en

(31) 201862639988 P (32) 07.03.2018 (33) US  
 201862690933 P 27.06.2018 US

(54) AMINO ACID COMPOUNDS AND METHODS OF USE

(71) Pliant Therapeutics, Inc., 260 Littlefield Avenue, South San Francisco, CA 94080, US  
 CHA, Jacob, c/o Pliant Therapeutics, Inc. 260 Littlefield Avenue South, San Francisco, California 94080, US  
 DONG, Chengguo, c/o Pliant Therapeutics, Inc. 260 Littlefield Avenue South, San Francisco, California 94080, US  
 HOM, Timothy, c/o Pliant Therapeutics, Inc. 260 Littlefield Avenue South, San Francisco, California 94080, US  
 JIANG, Lan, c/o Pliant Therapeutics, Inc. 260 Littlefield Avenue South, San Francisco, California 94080, US  
 LEFTHERIS, Katerina, c/o Pliant Therapeutics, Inc. 260 Littlefield Avenue South, San Francisco, California 94080, US

LI, Hui, c/o Pliant Therapeutics, Inc. 260 Littlefield Avenue South, San Francisco, California 94080, US  
 MORGANS JR., David J., c/o Pliant Therapeutics, Inc. 260 Littlefield Avenue South, San Francisco, California 94080, US  
 MUNOZ, Manuel, c/o Pliant Therapeutics, Inc. 260 Littlefield Avenue South, San Francisco, California 94080, US  
 REILLY, Maureen, c/o Pliant Therapeutics, Inc. 260 Littlefield Avenue South, San Francisco, California 94080, US  
 ZHENG, Yajun, c/o Pliant Therapeutics, Inc. 260 Littlefield Avenue South, San Francisco, California 94080, US

- (51) MKP  
**A61K 39/395 2006 (97) EP 3794031**  
**A61P 35/00 2006**  
**C07K 16/24 2006**
- (96) EP 19765782.8 5/13/2019  
 (97) EP 3794031, 3/24/2021 202112, en
- |      |          |      |            |      |    |
|------|----------|------|------------|------|----|
| (31) | 18382327 | (32) | 14.05.2018 | (33) | EP |
|      | 18382359 |      | 25.05.2018 |      | EP |
|      | 19382208 |      | 26.03.2019 |      | EP |
|      | 19382331 |      | 03.05.2019 |      | EP |
- (54) ANTIBODIES AGAINST LIF AND DOSAGE FORMS THEREOF  
 (71) Fundació Privada Institut d'Investigació Oncològica de Vall-Hebron, Natzaret, 115-117 Edifici Cellex, 08035 Barcelona, ES  
 Fundació Privada Institució Catalana de Recerca i Estudis Avançats, Passeig Lluís Companys, 23, 08010 Barcelona, ES  
 (72) SEOANE SUAREZ, Joan, Carrer Natzaret, 115-117 Edifici Cellex, 08035 Barcelona, ES  
 ANIDO FOLGUEIRA, Judit, Carrer Natzaret, 115-117 Edifici Cellex, 08035 Barcelona, ES

- (51) MKP  
**A61K 39/395 2006 (97) EP 3765524**  
**A61P 35/02 2006**  
**C07K 16/28 2006**  
**C07K 16/30 2006**
- (96) EP 19766566.4 3/13/2019  
 (97) EP 3765524, 1/20/2021 202103, en
- |      |                |      |            |      |    |
|------|----------------|------|------------|------|----|
| (31) | 201862642938 P | (32) | 14.03.2018 | (33) | US |
|      | 201962803235 P |      | 08.02.2019 |      | US |
- (54) ANTIBODIES THAT BIND CD39 AND USES THEREOF  
 (72) CHAPPEL, Scott, 50 Hampshire Street 8th Floor, Cambridge, Massachusetts 02139, US  
 LAKE, Andrew, 50 Hampshire Street 8th Floor, Cambridge, Massachusetts 02139, US  
 WARREN, Michael, 50 Hampshire Street 8th Floor, Cambridge, Massachusetts 02139, US  
 DULAK, Austin, 50 Hampshire Street 8th Floor, Cambridge, Massachusetts 02139, US  
 DEVEREAUX, Erik, 50 Hampshire Street 8th Floor, Cambridge, Massachusetts 02139, US  
 HOLLAND, Pamela M., 50 Hampshire Street 8th Floor, Cambridge, Massachusetts 02139, US  
 ZAIDI, Tauqeer, 50 Hampshire Street 8th Floor, Cambridge, Massachusetts 02139, US  
 RAUSCH, Matthew, 50 Hampshire Street 8th Floor, Cambridge, Massachusetts 02139, US  
 PRINZ, Bianka, 7 Lucent Drive, Lebanon, New Hampshire 03766, US  
 NIELSON, Nels P., 7 Lucent Drive, Lebanon, New Hampshire 03766, US  
 DAS, Sonia, 50 Hampshire Street 8th Floor, Cambridge, Massachusetts 02139, US

- (51) MKP  
**A61K 31/513 2006 (97) EP 3765023**  
**A61K 48/00 2006**  
**C12N 15/85 2006**
- (96) EP 19766752.0 3/15/2019  
 (97) EP 3765023, 1/20/2021 202103, en
- |      |                |      |            |      |    |
|------|----------------|------|------------|------|----|
| (31) | 201862643336 P | (32) | 15.03.2018 | (33) | US |
|      | 201862749369 P |      | 23.10.2018 |      | US |
- (54) SYNTHETIC DNA VECTORS AND METHODS OF USE  
 (71) Intergalactic Therapeutics, Inc., 40 Guest Street, Brighton, MA 02135, US  
 (72) SCHNEPP, Bruce, C., 1723 Green Valley Road, Havertown, PA 19083, US  
 JOHNSON, Philip, R., 700 Williamson Road, Bryn Mawr, PA 19010, US

- (51) MKP  
**C12Q 1/68 2018 (97) EP 3765630**  
**G01N 33/50 2006**  
**G01N 33/68 2006**
- (96) EP 19767124.1 3/14/2019  
 (97) EP 3765630, 1/20/2021 202103, en

- (31) 201862642789 P (32) 14.03.2018 (33) US  
 (54) PRECISION MEDICINE FOR PAIN: DIAGNOSTIC BIOMARKERS, PHARMACOGENOMICS, AND REPURPOSED DRUGS  
 (71) INDIANA UNIVERSITY RESEARCH AND TECHNOLOGY CORPORATION, 518 Indiana Ave., Indianapolis, IN 46202, US  
 UNITED STATES GOVERNMENT as represented by THE DEPARTMENT OF VETERANS AFFAIRS, 810 Vermont Avenue N.W., Washington, DC 20420, US  
 (72) NICULESCU, Alexander Bogden, c/o Indiana University and Research Technology Corporation 518 Indiana Ave., Indianapolis, IN 46202, US
- 

- (51) MKP  
**A01N 43/76 2006 (97) EP 3766881**  
**A01N 43/90 2006**  
**A01N 47/02 2006**  
**A01P 7/04 2006**  
**A61K 31/506 2006**  
**A61P 33/00 2006**  
**A61P 33/14 2006**  
**C07D 413/04 2006**  
**C07D 413/14 2006**  
**C07D 471/04 2006**  
**C07F 7/10 2006**

- (96) EP 19767181.1 3/8/2019  
 (97) EP 3766881, 1/20/2021 202103, en  
 (31) 2018044222 (32) 12.03.2018 (33) JP  
 (54) HETEROARYL PYRIMIDINE COMPOUND AND PEST CONTROL AGENT  
 (72) SAKANISHI Keita, c/o Odawara Research Center, Nippon Soda Co., Ltd. 345, Takada, Odawara-shi, Kanagawa 250-0280, JP  
 AOYAMA Hikaru, c/o Odawara Research Center, Nippon Soda Co., Ltd. 345, Takada, Odawara-shi, Kanagawa 250-0280, JP  
 SAKIYAMA Norifumi, c/o Odawara Research Center, Nippon Soda Co., Ltd. 345, Takada, Odawara-shi, Kanagawa 250-0280, JP  
 IWASA Takao, c/o Odawara Research Center, Nippon Soda Co., Ltd. 345, Takada, Odawara-shi, Kanagawa 250-0280, JP  
 MATSUI Maki, c/o Odawara Research Center, Nippon Soda Co., Ltd. 345, Takada, Odawara-shi, Kanagawa 250-0280, JP  
 KOBAYASHI Tomomi, c/o Odawara Research Center, Nippon Soda Co., Ltd. 345, Takada, Odawara-shi, Kanagawa 250-0280, JP  
 KITAYAMA Takashi, c/o Odawara Research Center, Nippon Soda Co., Ltd. 345, Takada, Odawara-shi, Kanagawa 250-0280, JP
- 

- (51) MKP  
**A61K 31/7088 2006 (97) EP 3765030**  
**A61K 47/64 2017**

- (96) EP 19767585.3 3/15/2019  
 (97) EP 3765030, 1/20/2021 202103, en  
 (31) 201862644202 P (32) 16.03.2018 (33) US  
 (54) CHIMERIC PEPTIDES FOR ANTISENSE DELIVERY  
 (71) Massachusetts Institute of Technology, 77 Massachusetts Avenue, Cambridge, MA 02139, US  
 (72) PENTELUTE, Bradley L., c/o Massachusetts Institute Of Technology 77 Massachusetts Avenue, Cambridge, MA 02139, US  
 FADZEN, Colin M., c/o Massachusetts Institute Of Technology 77 Massachusetts Avenue, Cambridge, MA 02139, US  
 HOLDEN, Rebecca L., c/o Massachusetts Institute Of Technology 77 Massachusetts Avenue, Cambridge, MA 02139, US  
 USWOLFE, Justin M., c/o Massachusetts Institute Of Technology 77 Massachusetts Avenue, Cambridge, MA 02139, US  
 CHOO, Zi-Ning, c/o Massachusetts Institute Of Technology 77 Massachusetts Avenue, Cambridge, MA 02139, US  
 YAO, Monica, c/o Sarepta Therapeutics, Inc. 215 First Street, Cambridge, MA 02142, US  
 HANSON, Gunnar J., c/o Sarepta Therapeutics, Inc. 215 First Street, Cambridge, MA 02142, US
- 

- (51) MKP  
**A61K 31/495 2006 (97) EP 3765020**  
**A61P 17/00 2006**  
**C07D 295/04 2006**

- (96) EP 19768035.8 3/11/2019  
 (97) EP 3765020, 1/20/2021 202103, en  
 (31) 201862641949 P (32) 12.03.2018 (33) US  
 (54) SPIROCYCLIC ROR-GAMMA MODULATORS  
 (71) Escalier Biosciences B.V., 662 Encinitas Blvd., Suite 250, Encinitas, CA 92024, US  
 (72) MOHAN, Raju, 662 Encinitas Blvd., Suite 250, Encinitas, California 92024, US  
 NUSS, John, 662 Encinitas Blvd., Suite 250, Encinitas, California 92024, US  
 HARRIS, Jason, 662 Encinitas Blvd., Suite 250, Encinitas, California 92024, US  
 YUAN, Shendong, 662 Encinitas Blvd., Suite 250, Encinitas, California 92024, US
- 

- (51) MKP



**A61K 51/04 2006 (97) EP 3766893**  
**A61P 35/00 2006**  
**C07F 13/00 2006**  
 (96) EP 19768668.6 3/7/2019  
 (97) EP 3766893, 1/20/2021 202103, en  
 (31) 2018003175 (32) 14.03.2018 (33) MX  
 (54) 177LU-DOTA-HYNIC-IP SMA AS A THERAPEUTIC RADIOPHARMACEUTICAL TARGETING PROSTATE-SPECIFIC MEMBRANE ANTIGEN  
 (72) FERRO FLORES, Guillermina, Carretera México-Toluca S/N La Marquesa, Ocoyoacac Estado de México 52750, MX  
 OCAMPO GARCÍA, Blanca Eli, Carretera México-Toluca S/N La Marquesa, Ocoyoacac Estado de México 52750, MX  
 LUNA GUTIÉRREZ, Myrna Alejandra, Carretera México-Toluca S/N La Marquesa, Ocoyoacac Estado de México 52750, MX  
 SANTOS CUEVAS, Clara Leticia, Carretera México-Toluca S/N La Marquesa, Ocoyoacac Estado de México 52750, MX  
 AZORÍN VEGA, Erika Patricia, Carretera México-Toluca S/N La Marquesa, Ocoyoacac Estado de México 52750, MX  
 JIMÉNEZ MANCILLA, Nallely Patricia, Carretera México-Toluca S/N La Marquesa, Ocoyoacac Estado de México 52750, MX  
 HERNÁNDEZ JIMÉNEZ, Tania, Carretera México-Toluca S/N La Marquesa, Ocoyoacac Estado de México, 52750, MX  
 RAMÍREZ DE LA CRUZ, Flor de María, Carretera México-Toluca S/N La Marquesa, Ocoyoacac Estado de México 52750, MX

(51) MKP  
**A61K 31/497 2006 (97) EP 3762368**  
**A61P 35/00 2006**  
**C07D 241/20 2006**  
**C07D 241/28 2006**  
**C07D 403/04 2006**  
**C07D 403/08 2006**  
**C07D 403/14 2006**  
**C07D 405/12 2006**  
**C07D 413/04 2006**  
**C07D 413/14 2006**  
**C07D 417/04 2006**  
 (96) EP 19768926.8 3/7/2019  
 (97) EP 3762368, 1/13/2021 202102, en  
 (31) 201862640276 P (32) 08.03.2018 (33) US  
 201862702230 P 23.07.2018 US  
 201862745873 P 15.10.2018 US  
 (54) AMINOPYRAZINE DIOL COMPOUNDS AS PI3K-Y INHIBITORS  
 (72) SHEPARD, Stacey, 1801 Augustine Cut-Off, Wilmington, Delaware 19803, US  
 COMBS, Andrew P., 1801 Augustine Cut-Off, Wilmington, Delaware 19803, US  
 FALAHATPISHEH, Nikoo, 1801 Augustine Cut-Off, Wilmington, Delaware 19803, US  
 SHAO, Lixin, 1801 Augustine Cut-Off, Wilmington, Delaware 19803, US

(51) MKP  
**A01K 47/00 2006 (97) EP 3787398**  
**A01K 47/06 2006**  
 (96) EP 19770165.9 5/2/2019  
 (97) EP 3787398, 3/10/2021 202110, en  
 (31) 1800142 (32) 02.05.2018 (33) HU  
 (54) BEE-MOVEMENT REGULATION DEVICE FOR BEEHIVES  
 (72) Dömöcsök, Béla, Bethlen Gábor u. 44/A, 2051 Biatorbágy, HU

(51) MKP  
**C12N 5/079 2010 (97) EP 3768841**  
**C12N 15/113 2010**  
**C12Q 1/68 2018**  
 (96) EP 19770416.6 3/22/2019  
 (97) EP 3768841, 1/27/2021 202104, en  
 (31) 201862647411 P (32) 23.03.2018 (33) US  
 201862765096 P 17.08.2018 US  
 201862731629 P 14.09.2018 US  
 201862758235 P 09.11.2018 US  
 201962810651 P 26.02.2019 US  
 (54) METHODS OF TREATING TTR AMYLOIDOSIS USING AG10  
 (72) SINHA, Uma, 101 Montgomery street, 25th floor, San francisco, CA 94104, US  
 RAO, Satish, 101 Montgomery street, 25th floor, San francisco, CA 94104, US

(51) MKP  
**A61K 31/4184 2006 (97) EP 3768258**  
**A61K 31/519 2006**  
**A61P 35/00 2006**  
(96) EP 19770484.4 3/20/2019  
(97) EP 3768258, 1/27/2021 202104, en  
(31) 201862646314 P (32) 21.03.2018 (33) US  
(54) COMBINATION THERAPY  
(71) MEI Pharma, Inc., 11455 El Camino Real, Suite 250, San Diego, CA 92130, US  
(72) GOLD, Daniel P., 3611 Valley Centre Drive Suite 500, San Diego, California 92130, US

---

(51) MKP  
**A61K 38/07 2006 (97) EP 3768325**  
**A61K 47/68 2017**  
**A61P 35/00 2006**  
**C07K 16/36 2006**  
(96) EP 19770713.6 3/20/2019  
(97) EP 3768325, 1/27/2021 202104, en  
(31) 201862646256 P (32) 21.03.2018 (33) US  
201862753730 P 31.10.2018 US  
(54) METHODS OF TREATING CANCER WITH A COMBINATION OF A PLATINUM-BASED AGENT AND AN ANTI-TISSUE FACTOR ANTIBODY-  
DRUG CONJUGATE  
(72) BREIJ, Esther C. W., c/o Genmab B.V. Uppsalalaan 15, 3584 CT Utrecht, NL  
VERPLOEGEN, Sandra, c/o Genmab B.V. Uppsalalaan 15, 3584 CT Utrecht, NL  
ABIDOYE, Oyewale O., c/o Seattle Genetics, Inc. 21823 30th Drive S.E., Bothell, Washington 98021, US  
NICACIO, Leonardo Viana, c/o Seattle Genetics, Inc. 21823 30th Drive S.E., Bothell, Washington 98021, US  
RANGWALA, Reshma Abdulla, 7801 Lincoln Drive, Philadelphia, PA 19118, US

---

(51) MKP  
**A61K 39/395 2006 (97) EP 3768314**  
**A61P 29/00 2006**  
**A61P 35/00 2006**  
**A61P 37/06 2006**  
**C07K 16/28 2006**  
(96) EP 19771243.3 3/20/2019  
(97) EP 3768314, 1/27/2021 202104, en  
(31) 201862646210 P (32) 21.03.2018 (33) US  
(54) ANTIBODIES AGAINST SIGNAL-REGULATORY PROTEIN ALPHA AND METHODS OF USE  
(72) PONS, Jaume, c/o ALX ONCOLOGY INC. 866 Malcolm Road, Suite 100, Burlingame, California 94010, US  
SIM, Bang Janet, c/o ALX ONCOLOGY INC. 866 Malcolm Road, Suite 100, Burlingame, California 94010, US  
WAN, Hong, c/o ALX ONCOLOGY INC. 866 Malcolm Road, Suite 100, Burlingame, California 94010, US  
KUO, Tracy Chia-Chien, c/o ALX ONCOLOGY INC. 866 Malcolm Road, Suite 100, Burlingame, California 94010, US

---

(51) MKP  
**A61K 31/495 2006 (97) EP 3768269**  
**C07D 257/02 2006**  
(96) EP 19771620.2 3/22/2019  
(97) EP 3768269, 1/27/2021 202104, en  
(31) 201862647308 P (32) 23.03.2018 (33) US  
(54) COMPOUNDS AND USES THEREOF  
(72) LE BOURDONNEC, Bertrand, 2 Mohican Avenue, Northborough, MA 01532, US  
LUCAS, Matthew, 48 Parker St, Lexington, MA 02421, US  
OZBOYA, Kerem, 11 Ellery St. Apt 1, Cambridge, MA 02138, US  
PANDYA, Bhaumik, 325 Springs Road, Bedford, MA 01730, US  
TARDIFF, Daniel, 48 Newland Road, Arlington, MA 02474, US  
TIVITMAHAISOON, Parcharee, 580 Commonwealth Ave. 606, Boston, MA 02215, US  
WRONA, Iwona, 17 Harding Street, Sharon, MA 02067, US

---

(51) MKP  
**A61K 9/10 2006 (97) EP 3769765**  
**A61K 9/14 2006**  
**A61K 9/16 2006**  
**A61K 9/20 2006**

**A61K 9/48 2006**  
**A61K 31/519 2006**  
**A61K 47/20 2006**  
**A61K 47/26 2006**  
**A61K 47/32 2006**  
**A61K 47/38 2006**  
 (96) EP 19771998.2 3/18/2019  
 (97) EP 3769765, 1/27/2021 202104, en  
 (31) 2018051620 (32) 19.03.2018 (33) JP  
 (54) PHARMACEUTICAL COMPOSITION INCLUDING SODIUM ALKYL SULFATE  
 (72) KUSUMOTO Kenji, c/o Taiho Pharmaceutical Co., Ltd., 224-2, Hiraishiebisuno, Kawauchi-cho, Tokushima-shi, Tokushima 771-0194, JP  
 MIYAMURA Sadahiro, c/o Taiho Pharmaceutical Co., Ltd., 224-2, Hiraishiebisuno, Kawauchi-cho, Tokushima-shi, Tokushima 771-0194, JP

---

(51) MKP  
**A61K 38/20 2006 (97) EP 3768317**  
**A61K 39/395 2006**  
**C07K 14/54 2006**  
**C07K 16/24 2006**  
 (96) EP 19772189.7 3/22/2019  
 (97) EP 3768317, 1/27/2021 202104, en  
 (31) 201862646496 P (32) 22.03.2018 (33) US  
 (54) ANTI-IL-27 ANTIBODIES AND USES THEREOF  
 (72) HILL, Jonathan, 50 Hampshire Street, 8th Floor, Cambridge, Massachusetts 02139, US  
 CHAPPEL, Scott, 50 Hampshire Street, 8th Floor, Cambridge, Massachusetts 02139, US  
 GLADSTONE, Michael, 50 Hampshire Street, 8th Floor, Cambridge, Massachusetts 02139, US  
 PRINZ, Bianka, 7 Lucent Drive, Lebanon, New Hampshire 03766, US  
 LAKE, Andrew, 50 Hampshire Street, 8th Floor, Cambridge, Massachusetts 02139, US  
 MILLER, Christine, 50 Hampshire Street, 8th Floor, Cambridge, Massachusetts 02139, US  
 WHITE, Kerry, 50 Hampshire Street, 8th Floor, Cambridge, Massachusetts 02139, US  
 HUA, Jing, 50 Hampshire Street, 8th Floor, Cambridge, Massachusetts 02139, US  
 HOLLAND, Pamela M., 50 Hampshire Street, 8th Floor, Cambridge, Massachusetts 02139, US  
 RAUSCH, Matthew, 50 Hampshire Street, 8th Floor, Cambridge, Massachusetts 02139, US  
 MOODLEY, Devapregasan, 50 Hampshire Street, 8th Floor, Cambridge, Massachusetts 02139, US

---

(51) MKP  
**B65G 5/00 2006 (97) EP 3768615**  
**E21F 17/16 2006**  
 (96) EP 19772287.9 3/19/2019  
 (97) EP 3768615, 1/27/2021 202104, en  
 (31) 201862644696 P (32) 19.03.2018 (33) US  
 (54) SYSTEM AND METHOD FOR COMPRESSED AIR ENERGY STORAGE  
 (71) Cleantech Geomechanics Inc., 1011 9th Avenue South East, Suite 208, Calgary AB T2G 0H7, CA  
 (72) BILAK, Roman A., 1011 9th Avenue South East, Suite 208, Alberta T2G 0H7, CA  
 DUSSEAULT, Maurice B., 1011 9th Avenue South East, Suite 208, Calgary, Alberta T2G 0H7, CA

---

(51) MKP  
**A61K 39/12 2006 (97) EP 3768330**  
**A61K 48/00 2006**  
**C12N 5/09 2010**  
**C12N 15/86 2006**  
**G01N 33/50 2006**  
**G01N 33/569 2006**  
 (96) EP 19772552.6 3/20/2019  
 (97) EP 3768330, 1/27/2021 202104, en  
 (31) 201862646180 P (32) 21.03.2018 (33) US  
 102018108612 11.04.2018 DE  
 (54) METHODS OF ENHANCING PERSISTENCE OF ADOPTIVELY INFUSED T CELLS  
 (72) ALPERT, Amir, 10722 Shawbrook Drive, Houston, TX 77071, US

---

(51) MKP  
**A61K 31/44 2006 (97) EP 3782986**  
**A61K 31/443 2006**  
**A61K 31/4433 2006**

	<b>A61K 31/4439</b>	<b>2006</b>			
	<b>A61K 31/444</b>	<b>2006</b>			
	<b>A61K 31/4545</b>	<b>2006</b>			
	<b>A61K 31/496</b>	<b>2006</b>			
	<b>A61K 31/497</b>	<b>2006</b>			
	<b>A61K 31/501</b>	<b>2006</b>			
	<b>A61K 31/506</b>	<b>2006</b>			
	<b>A61K 31/517</b>	<b>2006</b>			
	<b>A61K 31/5377</b>	<b>2006</b>			
	<b>A61K 31/5383</b>	<b>2006</b>			
	<b>A61K 31/541</b>	<b>2006</b>			
	<b>A61K 31/55</b>	<b>2006</b>			
	<b>A61K 31/551</b>	<b>2006</b>			
	<b>A61K 31/553</b>	<b>2006</b>			
	<b>A61K 31/554</b>	<b>2006</b>			
	<b>A61P 35/00</b>	<b>2006</b>			
	<b>A61P 43/00</b>	<b>2006</b>			
	<b>C07D 213/85</b>	<b>2006</b>			
(96)	EP 19774394.1	3/28/2019			
(97)	EP 3782986, 2/24/2021	202108, en			
(31)	2018063740		(32)	29.03.2018	(33) JP
(54)	HETEROCYCLIC COMPOUND				
(72)	ONO, Koji, c/o TAKEDA PHARMACEUTICAL COMPANY LIMITED, 26-1, Muraoka-Higashi 2-chome, Fujisawa-shi, Kanagawa 251-0012, JP				
	ITO, Masahiro, c/o TAKEDA PHARMACEUTICAL COMPANY LIMITED, 26-1, Muraoka-Higashi 2-chome, Fujisawa-shi, Kanagawa 251-0012, JP				
	TANAKA, Toshio, c/o TAKEDA PHARMACEUTICAL COMPANY LIMITED, 26-1, Muraoka-Higashi 2-chome, Fujisawa-shi, Kanagawa 251-0012, JP				
	ASANO, Moriteru, c/o TAKEDA PHARMACEUTICAL COMPANY LIMITED, 26-1, Muraoka-Higashi 2-chome, Fujisawa-shi, Kanagawa 251-0012, JP				
	HIRAYAMA, Takaharu, c/o TAKEDA PHARMACEUTICAL COMPANY LIMITED, 26-1, Muraoka-Higashi 2-chome, Fujisawa-shi, Kanagawa 251-0012, JP				
	FUJIMOTO, Jun, c/o TAKEDA PHARMACEUTICAL COMPANY LIMITED, 26-1, Muraoka-Higashi 2-chome, Fujisawa-shi, Kanagawa 251-0012, JP				
	SAKAUCHI, Nobuki, c/o TAKEDA PHARMACEUTICAL COMPANY LIMITED, 26-1, Muraoka-Higashi 2-chome, Fujisawa-shi, Kanagawa 251-0012, JP				
	HIRATA, Yasuhiro, c/o TAKEDA PHARMACEUTICAL COMPANY LIMITED, 26-1, Muraoka-Higashi 2-chome, Fujisawa-shi, Kanagawa 251-0052, JP				
	TOITA, Akinori, c/o TAKEDA PHARMACEUTICAL COMPANY LIMITED, 26-1, Muraoka-Higashi 2-chome, Fujisawa-shi, Kanagawa 251-0012, JP				
	MORISHITA, Nao, c/o TAKEDA PHARMACEUTICAL COMPANY LIMITED, 26-1, Muraoka-Higashi 2-chome, Fujisawa-shi, Kanagawa 251-0012, JP				
	KOKUBO, Hironori, c/o TAKEDA PHARMACEUTICAL COMPANY LIMITED, 26-1, Muraoka-Higashi 2-chome, Fujisawa-shi, Kanagawa 251-0052, JP				
	IMAEDA, Yasuhiro, c/o TAKEDA PHARMACEUTICAL COMPANY LIMITED, 26-1, Muraoka-Higashi 2-chome, Fujisawa-shi, Kanagawa 251-0012, JP				
	MAEZAKI, Hironobu, c/o TAKEDA PHARMACEUTICAL COMPANY LIMITED, 26-1, Muraoka-Higashi 2-chome, Fujisawa-shi, Kanagawa 251-0012, JP				
	CARY, Douglas Robert, c/o TAKEDA PHARMACEUTICAL COMPANY LIMITED, 26-1, Muraoka-Higashi 2-chome, Fujisawa-shi, Kanagawa 251-0012, JP				
	MIZOJIRI, Ryo, c/o TAKEDA PHARMACEUTICAL COMPANY LIMITED, 26-1, Muraoka-Higashi 2-chome, Fujisawa-shi, Kanagawa 251-0012, JP				
	CHO, Nobuo, c/o TAKEDA PHARMACEUTICAL COMPANY LIMITED, 26-1, Muraoka-Higashi 2-chome, Fujisawa-shi, Kanagawa 251-0012, JP				
	BANNO, Hiroshi, c/o Axcelead Drug Discovery Partners, Inc., 26-1, Muraoka-Higashi 2-chome, Fujisawa-shi, Kanagawa 251-0012, JP				
	TOKUHARA, Hidekazu, c/o Axcelead Drug Discovery Partners, Inc., 26-1, Muraoka-Higashi 2-chome, Fujisawa-shi, Kanagawa 251-0012, JP				
	ARIKAWA, Yasuyoshi, c/o Chordia Therapeutics Inc., 26-1, Muraoka-Higashi 2-chome, Fujisawa-shi, Kanagawa 251-0012, JP				
(51)	MKP				
	<b>A61K 35/76</b>	<b>2015</b>	(97)	<b>EP 3789489</b>	
	<b>A61P 35/00</b>	<b>2006</b>			
	<b>C07K 16/22</b>	<b>2006</b>			
	<b>C12N 7/01</b>	<b>2006</b>			
	<b>C12N 15/13</b>	<b>2006</b>			
(96)	EP 19777039.9	3/28/2019			
(97)	EP 3789489, 3/10/2021	202110, en			
(31)	2018068847		(32)	30.03.2018	(33) JP
(54)	SWELLING INHIBITOR-TYPE ONCOLYTIC VIRUS				
(71)	Todo, Tomoki, 2-17-7 Eitai, Koto-ku Tokyo 135-0034, JP				
(72)	Todo, Tomoki, 2-17-7 Eitai, Koto-ku Tokyo 135-0034, JP				

(51) MKP  
**A61K 35/17 2015 (97) EP 3773630**  
**C07K 16/28 2006**  
(96) EP 19780569.0 3/25/2019  
(97) EP 3773630, 4/7/2021 202114, en  
(31) 201862652202 P (32) 03.04.2018 (33) US  
(54) BCMA-CAR-T CELLS  
(71) Promab Biotechnologies, Inc., 2600 Hilltop Drive Suite 320, Richmond, California 94806, US  
Forevertek Biotechnology Co., Ltd, Room A7245, 7 Floor, No.9 Building CEC Software Park Phase I No.39 Jianshan Road Changsha Hi-tech  
Industrial Development Zone, Hunan 410205, CN  
(72) WU, Lijun, 2600 Hilltop Drive, Suite 320, Richmond, California 94806, US  
GOLUBOVSKAYA, Vita, 2600 Hilltop Drive, Suite 320, Richmond, California 94806, US

(51) MKP  
**A61K 31/04 2006 (97) EP 3765029**  
**A61K 31/4025 2006**  
**A61K 31/70 2006**  
(96) EP 19784620.7 4/11/2019  
(97) EP 3765029, 1/20/2021 202103, en  
(31) 201862657313 P (32) 13.04.2018 (33) US  
(54) ROS-RESPONSIVE MICRONEEDLE PATCH FOR ACNE VULGARIS TREATMENT  
(71) North Carolina State University, Office of Research Commercialization Campus Box 8210 1021 Main Campus Drive, Raleigh, NC 27695-8210,  
US  
(72) GU, Zhen, 112 Briarfield, Apex, NC 27502, US  
ZHANG, Yuqi, 1409 Midvale Ave Apt 207, Los Angeles, CA 90024, US

(51) MKP  
**A61K 35/763 2015 (97) EP 3781188**  
**C12N 5/07 2010**  
**C12N 5/10 2006**  
**C12N 7/00 2006**  
(96) EP 19784626.4 4/12/2019  
(97) EP 3781188, 2/24/2021 202108, en  
(31) 201862657388 P (32) 13.04.2018 (33) US  
(54) ADOPTIVE CELLULAR THERAPY  
(72) ROTTMAN, James, Brian, 63 Willis Lake Dr, Sudbury, MA 01776, US

(51) MKP  
**A61K 8/30 2006 (97) EP 3768226**  
**A61K 8/65 2006**  
**A61K 9/06 2006**  
**A61K 31/203 2006**  
**A61K 31/785 2006**  
**A61K 47/69 2017**  
**A61P 17/14 2006**  
(96) EP 19785580.2 4/11/2019  
(97) EP 3768226, 1/27/2021 202104, en  
(31) 201862657423 P (32) 13.04.2018 (33) US  
(54) USE OF MICRONEEDLE PATCH TO PROMOTE HAIR GROWTH  
(72) GU, Zhen, 112 Briarfield, Apex, North Carolina 27502, US  
YANG, Guang, 3520 Ivy Commons Dr. Apt. 202, Raleigh, North Carolina 27606, US

(51) MKP  
**A61K 31/4375 2006 (97) EP 3773573**  
**C07D 207/04 2006**  
**C07D 471/04 2006**  
(96) EP 19785592.7 4/12/2019  
(97) EP 3773573, 4/7/2021 202114, en  
(31) 201862656742 P (32) 12.04.2018 (33) US  
(54) ANTAGONISTS OF HUMAN INTEGRIN (ALPHA4)(BETA7)

- (72) BURSAVICH, Matthew, G., 172 Damon Road, Needham, MA 02494, US  
 TROAST, Dawn, M., 325 Springs Road, Bedford, MA 01730, US  
 HARRISON, Bryce, A., 7 Old Wood Road, Framingham, MA 01701, US  
 LIPPA, Blaise, S., 784 Commonwealth Avenue, Newton, Massachusetts 02459, US  
 ROGERS, Bruce, N., 252 Common Street, Belmont, MA 02478, US  
 KONZE, Kyle, D., 224 E. 70 Street, Apt. 6, New York, NY 10021, US  
 GERASYUTO, Aleksey, I., 20 Skyline Drive, Flemington, NJ 08822, US  
 DAY, Tyler, 520 West 48th Street, Apt 7G, New York, NY 10036, US  
 LIN, Fu-yang, 44 Saxony Drive, Sudbury, MA 01776, US  
 HAHN, Kristopher, N., 32 Webster Street, Medford, MA 02155, US  
 SVENSSON, Mats, A., 160 West 24th Street, Apt. 19c, New York, NY 10011, US  
 KIM, Byungchan, 20 Port Imperial, No. 322, West New York, NJ 07093, US  
 ZHONG, Cheng, 19 Bumham Street, D4, Belmont, MA 02478, US  
 LUGOVSKOY, Alexey, A., 35 Audrey Road, Belmont, MA 02478, US  
 SOSA, Brian, 126 Pearl Street, Cambridge, MA 02139, US

- (51) MKP  
**A61K 31/444 2006 (97) EP 3784671**  
**A61K 31/4545 2006**  
**A61K 31/4745 2006**  
**A61K 31/502 2006**  
**A61P 35/00 2006**  
**C07D 471/10 2006**

(96) EP 19787882.0 4/17/2019

(97) EP 3784671, 3/3/2021 202109, en

(31)	201810359447	(32)	20.04.2018	(33)	CN
	201862665296 P		01.05.2018		US

(54) DUAL ATM AND DNA-PK INHIBITORS FOR USE IN ANTI-TUMOR THERAPY

(71) XRad Therapeutics, Inc., 124 West 23rd Street, Apt. 16A, New York, NY 10011, US

(72) FU, Jianmin, Room 1701, Unit 2 Building 8 8 WenHuaYuan West Rd (Link Park) Daxing District, Beijing 100176, CN

SUN, Yue, Room 403, Unit 1 Bldg 220, Zhujiang Res. QTR. 1st Street Jingsheng North Majuqiao, Tongzhou, Beijing 101102, CN

WU, Guosheng, Room 1917, Building 33, Link Park, BDA, Beijing 100176, CN

LU, Aijun, Room 501, Building 32 FengGuYuan One Fengtai District, Beijing 100078, CN

ZHANG, Shuang, Room 1209, Building 2, Haojingguoji, BDA, Beijing 100176, CN

GOODNOW, Robert, 80 Rollingwood Lane, Concord, Massachusetts 01742, US

GILMER, Tona, 3211 Moores Mill Road, Rougemont, North Carolina 27572, US

KASTAN, Michael, 2707 Forest Creek Road, Chapel Hill, North Carolina 27514, US

KIRSCH, David, 2019 West Club Boulevard, Durham, North Carolina 27705, US

WANG, Yaode, Room 1304, Unit 1, Bldg 221 Zhujiang Res. QTR 1st Street Jingsheng North Majuqiao, Tongzhou, Beijing 101102, CN

- (51) MKP  
**A61K 31/401 2006 (97) EP 3781157**  
**A61P 25/02 2006**

(96) EP 19787899.4 4/12/2019

(97) EP 3781157, 2/24/2021 202108, en

(31)	201862658347 P	(32)	16.04.2018	(33)	US
------	----------------	------	------------	------	----

(54) METHODS OF TREATING NEUROPATHIC PAIN

(72) ZHAO, Yuan, c/o Biogen Inc. 225 Binney Street, Cambridge, MA 02124, US

NAIK, Himanshu, c/o Biogen Inc. 225 Binney Street, Cambridge, MA 02124, US

- (51) MKP  
**B32B 15/092 2006 (97) EP 3783043**  
**C08G 59/32 2006**  
**C08J 5/24 2006**  
**C08K 3/013 2018**  
**C08K 5/13 2006**  
**C08L 63/00 2006**  
**H05K 1/03 2006**  
**H05K 3/46 2006**

(96) EP 19788855.5 4/17/2019

(97) EP 3783043, 2/24/2021 202108, en

(31)	2018081070	(32)	20.04.2018	(33)	JP
------	------------	------	------------	------	----

(54) THERMOSETTING COMPOSITION, PREPREG, LAMINATE, METAL FOIL-CLAD LAMINATE, PRINTED WIRING BOARD, AND MULTILAYER PRINTED WIRING BOARD

- (71) MITSUBISHI GAS CHEMICAL COMPANY, INC., 5-2, Marunouchi 2-chome, Chiyoda-ku Tokyo 100-8324, JP  
 (72) TADOKORO, Hiroaki, c/o Mitsubishi Gas Chemical Company, Inc. Tokyo Techno Park, 1-1, Niijuku 6-chome Katsushika-ku, Tokyo 125-8601, JP  
 YAMAGUCHI, Shohei, c/o Mitsubishi Gas Chemical Company, Inc. Tokyo Techno Park, 1-1, Niijuku 6-chome Katsushika-ku, Tokyo 125-8601, JP  
 TOMIZAWA, Katsuya, c/o Mitsubishi Gas Chemical Company, Inc. Tokyo Techno Park, 1-1, Niijuku 6-chome Katsushika-ku, Tokyo 125-8601, JP  
 KAWAI, Hidetoshi, c/o Mitsubishi Gas Chemical Company, Inc. Tokyo Techno Park, 1-1, Niijuku 6-chome Katsushika-ku, Tokyo 125-8601, JP
- 

- (51) MKP  
**A61K 35/17 2015 (97) EP 3781177**  
**C07K 14/705 2006**  
**C07K 14/715 2006**  
**C07K 14/725 2006**  
**C12N 5/0783 2010**  
**C12N 5/10 2006**  
**C12N 15/10 2006**  
**C12N 15/86 2006**  
**C12N 15/867 2006**  
 (96) EP 19789197.1 4/18/2019  
 (97) EP 3781177, 2/24/2021 202108, en  
 (31) 201862659971 P (32) 19.04.2018 (33) US  
 (54) REPROGRAMMING CD4 T CELLS INTO CYTOTOXIC CD8 CELLS BY FORCED EXPRESSION OF CD8AB AND CLASS 1 RESTRICTED T CELL RECEPTORS  
 (72) ARBER BARTH, Caroline, Eva, 4403 Jonathan Street, Bellaire, TX 77401, US  
 BAJWA, Gagan, 14802 Winterfair Drive, Houston, TX 77082, US  
 BRENNER, Malcolm, K., 4802 Willow, Bellaire, TX 77401, US
- 

- (51) MKP  
**A61K 31/4184 2006 (97) EP 3782648**  
**A61K 31/454 2006**  
**A61K 31/5377 2006**  
**A61K 45/00 2006**  
**A61P 21/00 2006**  
**A61P 43/00 2006**  
 (96) EP 19789246.6 4/18/2019  
 (97) EP 3782648, 2/24/2021 202108, en  
 (31) 2018080834 (32) 19.04.2018 (33) JP  
 2018131371 11.07.2018 JP  
 (54) PREVENTATIVE AND THERAPEUTIC AGENTS FOR SARCOPENIA  
 (71) National University Corporation Tokyo University of Agriculture and Technology, 3-8-1, Harumi-cho Fuchu-shi, Tokyo 183-8538, JP  
 (72) INADA, Masaki, c/o NATIONAL UNIVERSITY CORPORATION TOKYO UNIVERSITY OF AGRICULTURE AND TECHNOLOGY, 3-8-1, Harumi-cho, Fuchu-shi, Tokyo 183-8538, JP  
 KAJIWARA, Daisuke, c/o TAIHO PHARMACEUTICAL CO., LTD., 3, Okubo, Tsukuba-shi, Ibaraki 300-2611, JP
- 

- (51) MKP  
**A61B 6/00 2006 (97) EP 3784132**  
**G01T 1/20 2006**  
**G01T 1/24 2006**  
**H01L 25/065 2006**  
**H01L 27/146 2006**  
 (96) EP 19791718.0 4/26/2019  
 (97) EP 3784132, 3/3/2021 202109, en  
 (31) 201815963377 (32) 26.04.2018 (33) US  
 201815964639 27.04.2018 US  
 (54) IMAGING DEVICES  
 (72) MORF, Daniel, Kirchstrasse 19, 8414 Buch am Irchel, CH  
 STAR-LACK, Josh, 902 Van Auken Circle, Palo Alto, California 94303, US
- 

- (51) MKP  
**A61K 31/422 2006 (97) EP 3784234**  
**A61P 35/00 2006**  
**C07D 263/48 2006**  
 (96) EP 19792116.6 4/24/2019  
 (97) EP 3784234, 3/3/2021 202109, en  
 (31) 201862662673 P (32) 25.04.2018 (33) US

(54) COMPOUNDS AND USES THEREOF  
 (72) WRONA, Iwona, 17 Harding Street, Sharon, MA 02067, US  
 TIVITMAHAISOON, Parcharee, 580 Commonwealth Avenue 606, Boston, MA 02215, US  
 TARDIFF, Daniel, 48 Newland Road, Arlington, MA 02474, US  
 PANDYA, Bhaumik, 325 Springs Road, Bedford, MA 01730, US  
 OZBOYA, Kerem, 11 Ellery Street, Apartment 1, Cambridge, MA 02138, US  
 LUCAS, Matthew, 48 Parker Street, Lexington, MA 02421, US  
 BOURDONNEC, Bertrand Le, 02 Mohican Avenue, Northborough, MA 01532, US

(51) MKP  
**A61K 35/28 2015 (97) EP 3784258**  
**C12N 15/861 2006**  
**C12N 15/88 2006**  
 (96) EP 19792271.9 4/24/2019  
 (97) EP 3784258, 3/3/2021 202109, en  
 (31) 201862662570 P (32) 25.04.2018 (33) US  
 (54) ARTIFICIAL EXOSOME COMPOSITION AND RELATED METHODS  
 (72) HARASZTI, Reka, Agnes, 695 Main Stree, Shrewsbury, MA 01545, US  
 KHVOROVA, Anastasia, 10 Rocklawn Road, Westborough, MA 01581, US  
 ARONIN, Neil, 19 Whittier Road, Newtonville, MA 02460, US

(51) MKP  
**C07K 16/18 2006 (97) EP 3784699**  
**C07K 16/28 2006**  
 (96) EP 19792354.3 4/24/2019  
 (97) EP 3784699, 3/3/2021 202109, en  
 (31) 201862662605 P (32) 25.04.2018 (33) US  
 201862756494 P 06.11.2018 US  
 (54) OPTIMIZED ANTI-TL1A ANTIBODIES  
 (72) WATKINS, Jeffrey D., 9410 Carroll Park Dr., San Diego, CA 92121, US  
 DICKERSON, Cindy T., 9410 Carroll Park Dr., San Diego, CA 92121, US  
 WATKINS, J. Monty, 9410 Carroll Park Dr., San Diego, CA 92121, US  
 MCNEELEY, Patricia, 9410 Carroll Park Dr., San Diego, CA 92121, US

(51) MKP  
**A61K 31/4985 2006 (97) EP 3784241**  
**C07D 487/16 2006**  
 (96) EP 19793407.8 4/22/2019  
 (97) EP 3784241, 3/3/2021 202109, en  
 (31) 201862663377 P (32) 27.04.2018 (33) US  
 201862664527 P 30.04.2018 US  
 (54) TRICYCLIC HETEROCYCLE COMPOUNDS USEFUL AS HIV INTEGRASE INHIBITORS  
 (72) YU, Tao, 2000 Galloping Hill Road, Kenilworth, New Jersey 07033, US  
 APGAR, James, M., 2000 Galloping Hill Road, Kenilworth, New Jersey 07033, US  
 WHITEHEAD, Alan, 126 East Lincoln Avenue, Rahway, New Jersey 07065-0907, US  
 ZHANG, Yonglian, 2000 Galloping Hill Road, Kenilworth, New Jersey 07033, US  
 HU, Zhiyong, 2000 Galloping Hill Road, Kenilworth, New Jersey 07033, US  
 SHURTLEFF, Valerie, W., 770 Sumneytown Pike, West Point, Pennsylvania 19486, US  
 MCCAULEY, John, A., 770 Sumneytown Pike, West Point, Pennsylvania 19486, US  
 RAHEEM, Izzat, T., 770 Sumneytown Pike, West Point, Pennsylvania 19486, US

(51) MKP  
**C07D 239/70 2006 (97) EP 3784657**  
**C07D 401/10 2006**  
**C07D 403/10 2006**  
 (96) EP 19793755.0 4/22/2019  
 (97) EP 3784657, 3/3/2021 202109, en  
 (31) 201862662074 P (32) 24.04.2018 (33) US  
 (54) USE OF NEUTROPHIL ELASTASE INHIBITORS IN LIVER DISEASE  
 (71) pH Pharma Co., Ltd., 9F., The-K Twin Towers A 50 Jongno 1-Gil, Jongno-Gu, Seoul 03142, KR  
 (72) SATYAL, Sanjeev, 965 Buckland Avenue, San Carlos, CA 94070, US  
 ROBERTS, Brian, 38 Sorrento Court, Danville, CA 94526, US  
 WANG, Xueyan, 330 Beach Park Blvd., Foster City, CA 94404, US



SAVAGE, Scott, 307 Madrone Street, Redwood City, CA 94061, US  
 HUH, Hoyoung, 6 Redberry Ridge, Portola Valley, CA 94028, US

- (51) MKP  
**C07K 5/06 2006 (97) EP 3797114**  
**C07K 16/44 2006**
- (96) EP 19793769.1 4/25/2019  
 (97) EP 3797114, 3/31/2021 202113, en
- (31) 18169888 (32) 27.04.2018 (33) EP  
 201862772809 P 29.11.2018 US
- (54) HUMAN-DERIVED ANTI-(POLY-GA) DIPEPTIDE REPEAT (DPR) ANTIBODY  
 (71) Neurimmune AG, Wagistrasse 18, 8952 Schlieren, CH  
 (72) GRIMM, Jan, Neurimmune AG Wagistrasse 13, 8952 Schlieren, CH  
 MONTRASIO, Fabio, Neurimmune AG Wagistrasse 13, 8952 Schlieren, CH  
 DALKILIC-LIDDLE, Isin, Biogen MA Inc. 225 Binney Street, Cambridge, Massachusetts 02142, US  
 RUSHE, Mia Marie, Biogen MA Inc. 225 Binney Street, Cambridge, Massachusetts 02142, US  
 ARNDT, Joseph Walter, Biogen MA Inc. 225 Binney Street, Cambridge, Massachusetts 02142, US

- (51) MKP  
**G06F 21/32 2013 (97) EP 3770780**  
**G06T 7/00 2017**
- (96) EP 19793952.3 3/15/2019  
 (97) EP 3770780, 1/27/2021 202104, en
- (31) 2018083479 (32) 24.04.2018 (33) JP
- (54) IDENTIFICATION SYSTEM, METHOD, AND PROGRAM  
 (71) Cyberware Inc., 42, Kagurazaka 6-chome Shinjuku-ku, Tokyo 162-0825, JP  
 (72) HIRAKA Takafumi, c/o CYBERWARE Inc., 42, Kagurazaka 6-chome, Shinjuku-ku, Tokyo 162-0825, JP  
 GOTOH Masamichi, c/o CYBERWARE Inc., 42, Kagurazaka 6-chome, Shinjuku-ku, Tokyo 162-0825, JP  
 NAGAKUBO Kosuke, c/o CYBERWARE Inc., 42, Kagurazaka 6-chome, Shinjuku-ku, Tokyo 162-0825, JP

- (51) MKP  
**A24D 3/06 2006 (97) EP 3711497**
- (96) EP 19794401.0 4/18/2019  
 (97) EP 3711497, 1/20/2021 202103, en
- (31) 2019006785 (32) 18.01.2019 (33) JP
- (54) SEAMLESS CAPSULE, AND FILTER AND SMOKING DEVICE INCLUDING SAME  
 (71) Sunsho Pharmaceutical Co., Ltd., 1468, Atsuhara Fuji-shi, Shizuoka 419-0201, JP  
 (72) KOYAMA, Kenichi, c/o Sunsho Pharmaceutical Co., Ltd. 533-2, Oiwa, Fujinomiya-shi Shizuoka 418-0013, JP

- (51) MKP  
**E05B 19/18 2006 (97) EP 3789569**  
**E05B 63/00 2006**
- (96) EP 19795904.2 4/15/2019  
 (97) EP 3789569, 3/10/2021 202110, en
- (31) 2018116428 (32) 03.05.2018 (33) RU
- (54) KEY HAVING A CATCH AND A REPLACEABLE BLADE, LOCK, AND OPERATING METHOD THEREOF (VARIANTS)  
 (71) Salimov, Ildar Ibragimovich, ul. Bolshaya Polyanka, 30-289, Moscow, 119180, RU  
 (72) Salimov, Ildar Ibragimovich, ul. Bolshaya Polyanka, 30-289, Moscow, 119180, RU

- (51) MKP  
**B65B 35/30 2006 (97) EP 3787988**  
**B65G 47/08 2006**  
**B65G 47/54 2006**  
**B65G 47/56 2006**  
**B65G 47/57 2006**
- (96) EP 19795919.0 5/6/2019  
 (97) EP 3787988, 3/10/2021 202110, en
- (31) 20185415 (32) 04.05.2018 (33) FI
- (54) GROUPING STATION FOR GROUPING PALLETS  
 (72) PAKKANEN, Jukka, Rusakontie 21, 40900 Säynätsalo, FI

- (51) MKP  
**A61B 18/20 2006 (97) EP 3790492**  
**A61B 34/20 2016**  
**A61C 1/00 2006**  
**A61C 1/02 2006**
- (96) EP 19799193.8 5/9/2019  
(97) EP 3790492, 3/17/2021 202111, en
- (31) 201862669934 P (32) 10.05.2018 (33) US  
201862755989 P 05.11.2018 US  
201962830951 P 08.04.2019 US
- (54) AUTOMATED DENTAL DRILL  
(71) Cyberdotics (USA), Inc., 1750 Vallejo Street, Unit 504, San Francisco, CA 94123, US  
(72) CIRIELLO, Christopher, John, Cyberdotics (USA), INC. 1750 Vallejo Street, Unit 504, San Francisco, California, 94123, US  
JACKSON, James, Cyberdotics (USA), INC. 1750 Vallejo Street, Unit 504, San Francisco, California, 94123, US  
MULLER, Nathan, John, Cyberdotics (USA), INC. 1750 Vallejo Street, Unit 504, San Francisco, California, 94123, US  
KING, Brian, Edward, Cyberdotics (USA), INC. 1750 Vallejo Street, Unit 504, San Francisco, California, 94123, US

- (51) MKP  
**A61K 39/395 2006 (97) EP 3790584**  
**C07K 16/28 2006**  
**C07K 16/36 2006**
- (96) EP 19799339.7 5/7/2019  
(97) EP 3790584, 3/17/2021 202111, en
- (31) 201862668104 P (32) 07.05.2018 (33) US
- (54) METHODS OF TREATING CANCER WITH A COMBINATION OF AN ANTI-PD-1 ANTIBODY AND AN ANTI-TISSUE FACTOR ANTIBODY-DRUG CONJUGATE  
(72) BREIJ, Esther C.W., c/o Genmab B.V. Uppsalalaan 15, 3584 CT Utrecht, NL  
VERPLOEGEN, Sandra, c/o Genmab B.V. Uppsalalaan 15, 3584 CT Utrecht, NL  
ABIDOYE, Oyewale O., c/o Seattle Genetics, Inc. 21823 30th Drive S.E., Bothell, Washington 98021, US  
NICACIO, Leonardo Viana, c/o Seattle Genetics, Inc. 21823 30th Drive S.E., Bothell, Washington 98021, US  
CAO, Anthony, c/o Seattle Genetics, Inc. 21823 30th Drive S.E., Bothell, Washington 98021, US  
GARDAL, Shyra, c/o Seattle Genetics, Inc. 21823 30th Drive S.E., Bothell, Washington 98021, US  
RANGWALA, Reshma Abdulla, 7801 Lincoln Drive, Philadelphia, Pennsylvania 19118, US

- (51) MKP  
**C12N 15/113 2010 (97) EP 3799602**
- (96) EP 19799466.8 5/9/2019  
(97) EP 3799602, 4/7/2021 202114, en
- (31) 201862669238 P (32) 09.05.2018 (33) US
- (54) COMPOUNDS AND METHODS FOR REDUCING ATXN3 EXPRESSION  
(72) FREIER, Susan, M., 2855 Gazelle Ct., Carlsbad, CA 92010, US

- (51) MKP  
**A61K 31/7088 2006 (97) EP 3795688**  
**A61P 37/00 2006**  
**C12N 1/15 2006**  
**C12N 1/19 2006**  
**C12N 1/21 2006**  
**C12N 5/10 2006**  
**C12N 15/12 2006**  
**C12N 15/62 2006**  
**C12N 15/63 2006**
- (96) EP 19799639.0 5/10/2019  
(97) EP 3795688, 3/24/2021 202112, en
- (31) 2018091963 (32) 11.05.2018 (33) JP
- (54) NUCLEIC ACID FOR TREATING MITE ALLERGY  
(72) MARUI, Takanori, c/o Astellas Pharma Inc., 5-1, Nihonbashi-Honcho 2-chome, Chuo-ku, Tokyo 103-8411, JP  
UCHIDA, Masao, c/o Astellas Pharma Inc., 5-1, Nihonbashi-Honcho 2-chome, Chuo-ku, Tokyo 103-8411, JP

- (51) MKP

	<b>A61K 31/7088</b>	<b>2006</b>	<b>(97) EP 3792361</b>				
	<b>A61P 37/08</b>	<b>2006</b>					
	<b>C12N 1/15</b>	<b>2006</b>					
	<b>C12N 1/19</b>	<b>2006</b>					
	<b>C12N 1/21</b>	<b>2006</b>					
	<b>C12N 5/10</b>	<b>2006</b>					
	<b>C12N 15/62</b>	<b>2006</b>					
	<b>C12N 15/63</b>	<b>2006</b>					
(96)	EP 19799640.8	5/10/2019					
(97)	EP 3792361,	3/17/2021	202111,	en			
(31)	2018091989		(32)	11.05.2018	(33)		JP
(54)	NUCLEIC ACID FOR TREATING CRUSTACEAN ALLERGY						
(72)	MARUI, Takanori, c/o Astellas Pharma Inc., 5-1, Nihonbashi-Honcho 2-chome, Chuo-ku, Tokyo 103-8411, JP						
<hr/>							
(51)	MKP						
	<b>A61K 31/506</b>	<b>2006</b>	<b>(97) EP 3790866</b>				
	<b>A61P 31/20</b>	<b>2006</b>					
	<b>C07D 239/20</b>	<b>2006</b>					
	<b>C07D 403/04</b>	<b>2006</b>					
	<b>C07D 417/04</b>	<b>2006</b>					
(96)	EP 19800095.2	5/7/2019					
(97)	EP 3790866,	3/17/2021	202111,	en			
(31)	18171262		(32)	08.05.2018	(33)		EP
(54)	DIHYDROPYRIMIDINE DERIVATIVES AND USES THEREOF IN THE TREATMENT OF HBV INFECTION OR OF HBV-INDUCED DISEASES						
(72)	JIANG, Yimin, Johnson & Johnson (china) Investment Ltd., 2101, No.1 Building, 65 Gui Qing Road, Xuhui District, Shanghai 200233, CN WAN, Zhao-Kui, Johnson & Johnson (china) Investment Ltd., 2101, No.1 Building, 65 Gui Qing Road, Xuhui District, Shanghai 200233, CN CHEUNG, Wing Shun, Johnson & Johnson (china) Investment Ltd., 2101, No.1 Building, 65 Gui Qing Road, Xuhui District, Shanghai 200233, CN LIU, Qian, Johnson & Johnson (china) Investment Ltd., 2101, No.1 Building, 65 Gui Qing Road, Xuhui District, Shanghai 200233, CN DENG, Gang, Johnson & Johnson (china) Investment Ltd., 2101, No.1 Building, 65 Gui Qing Road, Xuhui District, Shanghai 200233, CN LIANG, Chao, Johnson & Johnson (china) Investment Ltd., 2101, No.1 Building, 65 Gui Qing Road, Xuhui District, Shanghai 200233, CN						
<hr/>							
(51)	MKP						
	<b>A61K 31/437</b>	<b>2006</b>	<b>(97) EP 3792260</b>				
	<b>A61K 31/444</b>	<b>2006</b>					
	<b>A61K 31/4545</b>	<b>2006</b>					
	<b>A61K 31/46</b>	<b>2006</b>					
	<b>A61K 31/496</b>	<b>2006</b>					
	<b>A61K 31/497</b>	<b>2006</b>					
	<b>A61K 31/551</b>	<b>2006</b>					
	<b>A61P 3/10</b>	<b>2006</b>					
	<b>A61P 13/02</b>	<b>2006</b>					
	<b>A61P 13/10</b>	<b>2006</b>					
	<b>A61P 27/06</b>	<b>2006</b>					
	<b>A61P 43/00</b>	<b>2006</b>					
	<b>C07D 471/04</b>	<b>2006</b>					
	<b>C07D 519/00</b>	<b>2006</b>					
(96)	EP 19800286.7	5/7/2019					
(97)	EP 3792260,	3/17/2021	202111,	en			
(31)	2018089867		(32)	08.05.2018	(33)		JP
(54)	AZABENZIMIDAZOLE COMPOUNDS AND PHARMACEUTICAL						
(72)	OIKAWA Kouya, c/o NIPPON SHINYAKU CO., LTD., 14, Kisshoin Nishinosho Monguchicho, Minami-ku, Kyoto-shi Kyoto 601-8550, JP HIRAI Sho, c/o NIPPON SHINYAKU CO., LTD., 14, Kisshoin Nishinosho Monguchicho, Minami-ku, Kyoto-shi Kyoto 601-8550, JP WAKITA Kazuhiko, c/o NIPPON SHINYAKU CO., LTD., 14, Kisshoin Nishinosho Monguchicho, Minami-ku, Kyoto-shi Kyoto 601-8550, JP FUJIBAYASHI Akiko, c/o NIPPON SHINYAKU CO., LTD., 14, Kisshoin Nishinosho Monguchicho, Minami-ku, Kyoto-shi Kyoto 601-8550, JP						
<hr/>							
(51)	MKP						
	<b>A61C 1/00</b>	<b>2006</b>	<b>(97) EP 3790493</b>				
	<b>A61C 3/04</b>	<b>2006</b>					
	<b>A61C 5/80</b>	<b>2017</b>					
	<b>A61C 19/00</b>	<b>2006</b>					
(96)	EP 19800428.5	5/9/2019					
(97)	EP 3790493,	3/17/2021	202111,	en			
(31)	201862669934 P		(32)	10.05.2018	(33)		US
	201862727390 P			05.09.2018			US

201862755961 P	05.11.2018	US
201862755989 P	05.11.2018	US
201962830951 P	08.04.2019	US

- (54) APPARATUS AND METHOD FOR DENTAL CLAMPING  
 (71) Cyberdotics Inc., 2900-550 Burrard Street, Vancouver, British Columbia V6C 0A3, CA  
 (72) CIRIELLO, Christopher, John, 2900-550 Burrard Street, Vancouver, British Columbia V6C 0A3, CA  
 JACKSON, James, 2900-550 Burrard Street, Vancouver, British Columbia V6C 0A3, CA  
 MULLER, Nathan, John, 2900-550 Burrard Street, Vancouver, British Columbia V6C 0A3, CA  
 KING, Brian, Edward, 2900-550 Burrard Street, Vancouver, British Columbia V6C 0A3, CA  
 LILLIS, Alec, John, 2900-550 Burrard Street, Vancouver, British Columbia V6C 0A3, CA

- (51) MKP  
**C07K 14/36 2006 (97) EP 3792349**  
**C12N 9/00 2006**  
**C12N 15/52 2006**  
**C12N 15/63 2006**

- (96) EP 19800484.8 4/25/2019  
 (97) EP 3792349, 3/17/2021 202111, en

(31)	2018089287	(32)	07.05.2018	(33)	JP
	2019050797		19.03.2019		JP

- (54) PEPTIDE MACROCYCLASE  
 (71) National University Corporation Hokkaido University, Kita 8-jyo Nishi 5-chome Kita-ku, Sapporo-shi, Hokkaido 060-0808, JP  
 (72) WAKIMOTO, Toshiyuki, c/o NATIONAL UNIVERSITY CORPORATION HOKKAIDO UNIVERSITY, Kita 8-jyo Nishi 5-chome, Kita-ku, Sapporo-shi, Hokkaido 060-0808, JP  
 KURANAGA, Takefumi, c/o NATIONAL UNIVERSITY CORPORATION HOKKAIDO UNIVERSITY, Kita 8-jyo Nishi 5-chome, Kita-ku, Sapporo-shi, Hokkaido 060-0808, JP  
 MATSUDA, Kenichi, c/o NATIONAL UNIVERSITY CORPORATION HOKKAIDO UNIVERSITY, Kita 8-jyo Nishi 5-chome, Kita-ku, Sapporo-shi, Hokkaido 060-0808, JP

- (51) MKP  
**B22F 1/00 2006 (97) EP 3790692**  
**B22F 3/00 2021**  
**B22F 9/08 2006**  
**B33Y 70/00 2020**

- (96) EP 19800578.7 5/10/2019  
 (97) EP 3790692, 3/17/2021 202111, en

(31)	201862670454 P	(32)	11.05.2018	(33)	US
------	----------------	------	------------	------	----

- (54) ADDITIVE MANUFACTURING POWDER AND ADDITIVE MANUFACTURING PART MADE USING SAME  
 (71) Equisperes Inc., 500 Palladium Drive, Suite 4100, Ottawa, ON K2V 1C2, CA  
 (72) CONLON, Martin John, 814-17 Aberdeen Street, Ottawa, Ontario K1S 3J3, CA  
 BROUSE, Douglas Andrew, 807 Fairwinds Terrace, Ottawa, Ontario K1C 2X6, CA  
 DOUTRE, Sean Robert, 1025 Grenon Avenue, Unit 1113, Ottawa, Ontario K2B 8S5, CA  
 YIN, Shengze, 419 Rosingdale Street, Ottawa, Ontario K2M 0L8, CA  
 PHILLIPS, Jonathan, 30041 Hillside Terrace, San Juan Capistrano, California 92675, US

- (51) MKP  
**A61K 31/70 2006 (97) EP 3799604**  
**C12N 15/113 2010**

- (96) EP 19800729.6 5/8/2019  
 (97) EP 3799604, 4/7/2021 202114, en

(31)	201862669280 P	(32)	09.05.2018	(33)	US
	201862699572 P		17.07.2018		US

- (54) COMPOUNDS AND METHODS FOR REDUCING FXI EXPRESSION  
 (72) BUI, Huynh-Hoa, 2855 Gazelle Court, Carlsbad, CA 92010, US

- (51) MKP  
**A61K 39/395 2006 (97) EP 3790587**  
**A61P 25/00 2006**  
**A61P 37/00 2006**  
**C07K 16/24 2006**  
**C12N 15/13 2006**

- (96) EP 19800756.9 5/10/2019  
 (97) EP 3790587, 3/17/2021 202111, en

- (31) 201862670326 P (32) 11.05.2018 (33) US  
 (54) METHODS OF TREATING DEPRESSION USING IL-23 ANTIBODIES  
 (72) DREVETS, Wayne, 3210 Merryfield Row, San Diego, California 92121, US  
 WANG, Dai, 920 US Highway 202 South, Raritan, New Jersey 08869, US  
 WITTENBERG, Gayle, 1125 Trenton-Harbourton Road, Titusville, New Jersey 08560, US
- 
- (51) MKP  
**A61K 31/19 2006 (97) EP 3793974**  
**A61P 25/00 2006**  
**C07C 229/00 2006**  
 (96) EP 19803008.2 5/14/2019  
 (97) EP 3793974, 3/24/2021 202112, en  
 (31) PCT/CN2018/086755 (32) 14.05.2018 (33) WO  
 (54) CRYSTALLINE FORMS OF 1-(ACYLOXY)-ALKYL CARBAMATE DRUG CONJUGATES OF NAPROXEN AND PREGABALIN  
 (71) Xgene Pharmaceutical Inc, Offshore Incorporations (Cayman) Limited Floor 4, Willow House Cricket Square P.O. Box 2804, Grand Cayman KY1-1112, KY  
 (72) XU, Feng, 1981 Middlefield Road, Palo Alto, California 94303, US  
 LI, Weidong, No. 111 North Second Circle, Chengdu, Sichuan 610031, CN  
 CHEN, Li, 3-1701, Hebin Garden Wellington International Community, Hongqiao District, Tianjin 300071, CN  
 AI, Xinmiao, 6 Taihe Road, BDA, Beijing 100176, CN
- 
- (51) MKP  
**A61K 39/395 2006 (97) EP 3793602**  
**A61P 25/00 2006**  
**A61P 25/28 2006**  
**C07K 16/40 2006**  
 (96) EP 19803142.9 5/14/2019  
 (97) EP 3793602, 3/24/2021 202112, en  
 (31) 201862671882 P (32) 15.05.2018 (33) US  
 201862694921 P 06.07.2018 US  
 (54) TREATMENT OF AGING-ASSOCIATED DISEASE WITH MODULATORS OF LEUKOTRIENE A4 HYDROLASE  
 (72) CAMPBELL, Meghan Kerrisk, 125 Shoreway Road, Suite D, San Carlos, California 94070, US  
 CZIRR, Eva, 125 Shoreway Road, Suite D, San Carlos, California 94070, US  
 SZOKE, Balazs, 125 Shoreway Road, Suite D, San Carlos, California 94070, US
- 
- (51) MKP  
**A61K 31/41 2006 (97) EP 3793547**  
**A61K 31/4164 2006**  
**A61K 31/4192 2006**  
 (96) EP 19803143.7 5/14/2019  
 (97) EP 3793547, 3/24/2021 202112, en  
 (31) 201862671985 P (32) 15.05.2018 (33) US  
 (54) MAGL INHIBITORS  
 (72) GRICE, Cheryl A., 10835 Road to the Cure, Suite 250, San Diego, California 92121, US  
 BUZARD, Daniel J., 10835 Road to the Cure, Suite 250, San Diego, California 92121, US  
 SHAGHAFI, Michael B., 10835 Road to the Cure, Suite 250, San Diego, California 92121, US
- 
- (51) MKP  
**C12Q 1/68 2018 (97) EP 3794147**  
**C12Q 1/6806 2018**  
**C12Q 1/6809 2018**  
**C12Q 1/6876 2018**  
**C12Q 1/6888 2018**  
 (96) EP 19803282.3 5/21/2019  
 (97) EP 3794147, 3/24/2021 202112, en  
 (31) 201862673480 P (32) 18.05.2018 (33) US  
 (54) QUALITY CONTROL COMPOSITIONS AND WHOLE ORGANISM CONTROL MATERIALS FOR USE IN NUCLEIC ACID TESTING  
 (71) Microbix Biosystems Inc., 265 Watline Avenue, Mississauga, ON L4Z 1P3, CA  
 (72) LUSCHER, Mark, 63 Durie Street, Toronto, Ontario M6S 3E5, CA  
 HUGHES, Kenneth, 78 Abbott Avenue, Toronto, Ontario M6P 1H6, CA  
 ZHELEV, Pavel, 2 Rean Drive Suite 1212, Toronto, Ontario M2K 3B8, CA  
 GROOME, Cameron, 80 - 1200 Walden Circle, Mississauga, Ontario L5J 4J9, CA

(51) MKP  
**A61K 31/423 2006 (97) EP 3793552**  
**A61K 31/424 2006**  
**A61P 25/28 2006**  
(96) EP 19803323.5 5/14/2019  
(97) EP 3793552, 3/24/2021 202112, en  
(31) 201862671998 P (32) 15.05.2018 (33) US  
(54) ABHD12 INHIBITORS AND METHODS OF MAKING AND USING SAME  
(72) OGASAWARA, Daisuke, 10550 North Torrey Pines Road, La Jolla, California 92037, US  
ICHU, Taka-Aki, 10550 North Torrey Pines Road, La Jolla, California 92037, US  
HULCE, Jonathan, 10550 North Torrey Pines Road, La Jolla, California 92037, US  
CRAVATT, Benjamin F., 10550 North Torrey Pines Road, La Jolla, California 92037, US

(51) MKP  
**C01D 15/02 2006 (97) EP 3793945**  
**C01D 15/08 2006**  
**C22B 3/24 2006**  
(96) EP 19803715.2 5/3/2019  
(97) EP 3793945, 3/24/2021 202112, en  
(31) 201862671489 P (32) 15.05.2018 (33) US  
201816010286 15.06.2018 US  
(54) PROCESS FOR SELECTIVE ADSORPTION AND RECOVERY OF LITHIUM FROM NATURAL AND SYNTHETIC BRINES  
(71) Energysource Minerals LLC, 12250 El Camino Real Suite 280, San Diego, California 92130, US  
(72) MARSTON, Charles R., 12250 El Camino Real, Suite 280, San Diego, California 92130, US  
GARSKA, Michael J., 12250 El Camino Real, Suite 280, San Diego, California 92130, US

(51) MKP  
**A61K 39/395 2006 (97) EP 3793606**  
**A61P 35/00 2006**  
**C07K 16/28 2006**  
**C07K 16/30 2006**  
**C07K 16/46 2006**  
**C07K 19/00 2006**  
(96) EP 19803950.5 5/15/2019  
(97) EP 3793606, 3/24/2021 202112, en  
(31) 201862672222 P (32) 16.05.2018 (33) US  
201862736804 P 26.09.2018 US  
201962842080 P 02.05.2019 US  
(54) METHODS OF TREATING CANCERS AND ENHANCING EFFICACY OF T CELL REDIRECTING THERAPEUTICS  
(72) ADAMS, Homer, 2005 Richland Terrace, Quakertown, Pennsylvania 18951, US  
GAUDET, Francois, 1400 McKean Road, Spring House, Pennsylvania 19477, US  
FRERICHS, Kris, De Boelelaan 1085, 1081 HV Amsterdam, NL  
VAN DE DONK, Niels, De Boelelaan 1085, 1081 HV Amsterdam, NL  
VERLEIJ, Christie C.P.M., De Boelelaan 1085, 1081 HV Amsterdam, NL

(51) MKP  
**A61K 9/00 2006 (97) EP 3793521**  
**A61P 37/06 2006**  
**C07K 16/24 2006**  
**C12Q 1/68 2018**  
**C12Q 1/6883 2018**  
(96) EP 19804426.5 5/17/2019  
(97) EP 3793521, 3/24/2021 202112, en  
(31) 201862673426 P (32) 18.05.2018 (33) US  
(54) SAFE AND EFFECTIVE METHOD OF TREATING LUPUS WITH ANTI-IL12/IL23 ANTIBODY  
(72) CESARONI, Matteo, 1400 McKean Road, Spring House, Pennsylvania 19477, US  
JORDAN, Jarrat, 255 Main Street, Cambridge, Massachusetts 02142, US  
LOZA, Matthew, 1400 McKean Road, Spring House, Pennsylvania 19477, US  
SERIDI, Loqmane, 1400 McKean Road, Spring House, Pennsylvania 19477, US

(51) MKP

- A61K 45/06 2006 (97) EP 3793608**  
**C07D 401/14 2006**  
(96) EP 19804469.5 5/14/2019  
(97) EP 3793608, 3/24/2021 202112, en  
(31) 201862671382 P (32) 14.05.2018 (33) US  
(54) ANTI-CANCER NUCLEAR HORMONE RECEPTOR-TARGETING COMPOUNDS  
(72) PHAM, Son Minh, c/o Sparcbio LLC P.O. Box 318009, San Francisco, California 94131, US  
CHAKRAVARTY, Sarvajit, c/o Sparcbio LLC P.O. Box 318009, San Francisco, California 94131, US  
CHEN, Jiyun, c/o Sparcbio LLC P.O. Box 318009, San Francisco, California 94131, US  
KANKANALA, Jayakanth, c/o Sparcbio LLC P.O. Box 318009, San Francisco, California 94131, US  
BARDE, Anup, c/o Intergral BioSciences, PVT. LTD. C-64 Hosiery Complex, Phase II, Noida, Uttar Pradesh 201306, IN  
NAYAK, Anjan Kumar, c/o Intergral BioSciences, PVT. LTD. C-64 Hosiery Complex, Phase II, Noida, Uttar Pradesh 201306, IN  
HUNG, David, c/o Sheppard Mullin Richter & Hampton LLP Four Embarcadero Center, 17th Floor, San Francisco, California 94111, US
- 
- (51) MKP  
**C12M 1/00 2006 (97) EP 3794349**  
**C12M 3/00 2006**  
**C12N 5/00 2006**  
**C12N 13/00 2006**  
**G01N 33/50 2006**  
(96) EP 19804471.1 5/15/2019  
(97) EP 3794349, 3/24/2021 202112, en  
(31) 201862671661 P (32) 15.05.2018 (33) US  
(54) DEVICES, SYSTEMS AND APPARATUSES FOR GENERATING SELF-SUSTAINING HYPOXIC CONDITIONS AND GASEOUS AND NON-GASEOUS CHEMICAL GRADIENTS FOR IN VITRO CELL CULTURE  
(71) The University of North Carolina at Chapel Hill, Office of Technology Commercialization 109 Church Street, Chapel Hill, NC 27516, US  
(72) ALLBRITTON, Nancy L., 907 Greenwood Road, Chapel Hill, NC 27514, US  
WANG, Yuli, 614 Piper Stream Circle, Cary, NC 27519, US  
KIM, Raehyun, 1521E. Franklin St., Apt C-210, Chapel Hill, NC 27514, US  
ATTAYEK, Peter Joseph, 3312 Swansea St, Durham, NC 27707, US
- 
- (51) MKP  
**A61K 48/00 2006 (97) EP 3799570**  
**C07H 21/02 2006**  
(96) EP 19807789.3 5/21/2019  
(97) EP 3799570, 4/7/2021 202114, en  
(31) 201862674865 P (32) 22.05.2018 (33) US  
(54) MODULATORS OF APOL1 EXPRESSION  
(72) FREIER, Susan, M., c/o Ionis Pharmaceuticals, Inc. 2855 Gazelle Court, Carlsbad, CA 92010, US
- 
- (51) MKP  
**A61K 31/4184 2006 (97) EP 3796914**  
**A61K 31/437 2006**  
**A61K 31/44 2006**  
**A61K 31/4985 2006**  
**A61K 31/5025 2006**  
**A61K 31/517 2006**  
**A61K 31/519 2006**  
**A61K 31/52 2006**  
**A61K 31/55 2006**  
**A61P 35/00 2006**  
**C12Q 1/6809 2018**  
(96) EP 19808414.7 5/22/2019  
(97) EP 3796914, 3/31/2021 202113, en  
(31) 201862675228 P (32) 23.05.2018 (33) US  
(54) METHODS OF TREATING CANCERS CHARACTERIZED BY A HIGH EXPRESSION LEVEL OF SPINDLE AND KINETOCHORE ASSOCIATED COMPLEX SUBUNIT 3 (SKA3) GENE  
(71) University Health Network, 190 Elizabeth Street R. Fraser Elliott Building - Room 1S-417, Toronto, Ontario M5G 2C4, CA  
(72) HAIBE-KAINS, Benjamin, 190 Elizabeth Street R. Fraser Elliott Building Room 1S-417, Toronto, Ontario M5G 2C4, CA  
CESCON, David, 190 Elizabeth Street R. Fraser Elliott Building Room 1S-417, Toronto, Ontario M5G 2C4, CA
- 
- (51) MKP

**C12Q 1/68 2018 (97) EP 3791012**  
**C12Q 1/6827 2018**  
**C12Q 1/6883 2018**  
**C40B 30/00 2006**  
(96) EP 19814209.3 6/6/2019  
(97) EP 3791012, 3/17/2021 202111, en  
(31) 201862681642 P (32) 06.06.2018 (33) US  
(54) METHODS FOR FINGERPRINTING OF BIOLOGICAL SAMPLES  
(71) Lexent Bio, Inc., 1000 Brannan Street, Suite 402, San Francisco, CA 94103, US  
(72) ROBERTSON, Alexander De Jong, 1000 Brannan Street, Suite 402, San Francisco, California 94103, US  
SRIVAS, Rohith Kannappan, 1000 Brannan Street, Suite 402, San Francisco, California 94103, US  
WILSON, Timothy Joseph, 1000 Brannan Street, Suite 402, San Francisco, California 94103, US  
PETERMAN, Neil, 1000 Brannan Street, Suite 402, San Francisco, California 94103, US  
LAMBERT, Nicole Jacinda, 1000 Brannan Street, Suite 402, San Francisco, California 94103, US  
TEZCAN, Haluk, 1000 Brannan Street, Suite 402, San Francisco, California 94103, US

---

(51) MKP  
**C04B 28/04 2006 (97) EP 3781533**  
**C04B 111/00 2006**  
(96) EP 19829709.5 4/17/2019  
(97) EP 3781533, 2/24/2021 202108, en  
(31) 201805562 (32) 18.04.2018 (33) TR  
(54) RADIATION-IMPERMEABLE AND RADON GAS-TIGHT FIBER-REINFORCED CONCRETES  
(71) Fibrobeton Yapi Elemanlari Sanayi Insaat Ve Ticaret Anonim Sirketi, Uzka Is Merkezi Erturk Sokak No:11 Kavacik, 34810 Istanbul, TR  
Plustechno Danismanlik ve Yapi Kimyasallari Ticaret Limited Sirketi, Sanayi Mahallesi Teknopark Bulvarı 1 C- 2C 1/2C 2011 Teknopark Istanbul, 34906 Pendik/Istanbul, TR  
(72) AKALIN, Özlem, Sanayi Mahallesi Teknopark Bulvarı 1 C - 2C 1/2C 2011 Teknopark Istanbul, 34906 Pendik/Istanbul, TR

---

(51) MKP  
**A61K 39/12 2006 (97) EP 3718565**  
**A61P 11/00 2006**  
**C07K 16/10 2006**  
(96) EP 20164728.6 10/21/2016  
(97) EP 3718565, 3/24/2021 202112, en  
(31) 201562245031 P (32) 22.10.2015 (33) US  
201562244813 P 22.10.2015 US  
201562244946 P 22.10.2015 US  
201562244802 P 22.10.2015 US  
201562244837 P 22.10.2015 US  
201562247362 P 28.10.2015 US  
201562247483 P 28.10.2015 US  
201562247394 P 28.10.2015 US  
201562247297 P 28.10.2015 US  
(54) RESPIRATORY VIRUS VACCINES  
(72) CIARAMELLA,, Giuseppe, 1 Hawes Road, Sudbury, MA 01776, US  
HIMANSU,, Sunny, 23 Fernway, Winchester, MA 01890, US

---

(51) MKP  
**A61K 38/09 2006 (97) EP 3701965**  
**A61K 45/06 2006**  
**A61P 5/26 2006**  
**A61P 5/30 2006**  
**A61P 13/00 2006**  
**A61P 13/08 2006**  
**A61P 15/00 2006**  
**A61P 35/00 2006**  
**A61P 43/00 2006**  
(96) EP 20165541.2 1/30/2018  
(97) EP 3701965, 4/7/2021 202114, en  
(31) 201762452096 P (32) 30.01.2017 (33) US  
(54) A COMPOSITION COMPRISING AT LEAST ONE GNRH ANTAGONIST  
(71) Antev Limited, 3rd Floor, 106 New Bond Street, London W1S 1DN, GB  
(72) LARSEN, Finn, 18 Forest Road Bonchester Bridge, Hawick, TD9 8JS, GB



(51) MKP  
**A01D 87/00 2006 (97) EP 3730701**  
**E02F 3/627 2006**  
(96) EP 20166166.7 3/27/2020  
(97) EP 3730701, 3/17/2021 202111, en  
(31) 2019083287 (32) 24.04.2019 (33) JP  
(54) STRUCTURE FOR DETACHABLE FRONT LOADER, DETACHABLE FRONT LOADER, AND WORK VEHICLE  
(71) Kubota Corporation, 2-47 Shikitsuhigashi 1-chome Naniwa-ku Osaka-shi, Osaka 556-8601, JP  
(72) TORII, Shin, c/o Kubota Corporation Sakai Seizosho 64 Ishizukitamachi, Sakai-ku,, Sakai-shi, Osaka 590-0823, JP

(51) MKP  
**A61K 51/00 2006 (97) EP 3696824**  
**A61K 51/12 2006**  
**A61M 36/00 2006**  
**G21G 1/00 2006**  
(96) EP 20166557.7 10/26/2012  
(97) EP 3696824, 3/24/2021 202112, en  
(31) 201261697244 P (32) 05.09.2012 (33) US  
(54) RUBIDIUM ELUTION SYSTEM CONTROL  
(72) LEFORT, Étienne, 132 Niagara, Kirkland, Québec H9J 3B6, CA  
TEOLI, Vincenzo, 10275 Tanguay, Montreal, Québec H3L 3G6, CA  
DEKEMP, Robert A., 92 Ross Avenue, Ottawa, Ontario K1Y 0N5, CA  
KLEIN, Ran, 247 Pleasant Park Road, Ottawa, Ontario K1H 5M4, CA

(51) MKP  
**A61K 31/519 2006 (97) EP 3699181**  
**A61P 35/00 2006**  
**C07D 487/04 2006**  
(96) EP 20169707.5 11/16/2015  
(97) EP 3699181, 4/7/2021 202114, en  
(31) 201462080374 P (32) 16.11.2014 (33) US  
201562169545 P 01.06.2015 US  
(54) CRYSTALLINE FORM OF (S)-N-(5-((R)-2-(2,5-DIFLUOROPHENYL)-PYRROLIDIN-1-YL)-PYRAZOLO[1,5-A]PYRIMIDIN-3-YL)-3-HYDROXYPYRROLIDINE-1-CARBOXAMIDE HYDROGEN SULFATE  
(72) ARRIGO, Alisha B., Array Biopharma, Inc 3200 Walnut Street, Boulder, CO 80301, US  
JUENGST, Derrick, Array Biopharma, Inc. 3200 Walnut Street, Boulder, CO 80301, US  
SHAH, Khalid, 12 Amberwood Circle, South San Francisco, CA 94080, US

(51) MKP  
**A61K 39/00 2006 (97) EP 3725327**  
**A61P 35/00 2006**  
**C07K 14/47 2006**  
**G01N 33/50 2006**  
(96) EP 20175071.8 4/10/2018  
(97) EP 3725327, 1/20/2021 202103, en  
(31) 102017107697 (32) 10.04.2017 (33) DE  
201762483702 P 10.04.2017 US  
(54) PEPTIDES AND COMBINATION THEREOF FOR USE IN THE IMMUNOTHERAPY AGAINST CANCERS  
(72) DI MARCO, Moreno, Memmingerstrasse 18/1, 72072 Tübingen, DE  
HAEN, Sebastian, Brombergstrasse 15, 72070 Tübingen, DE  
KOWALEWSKI, Daniel, Peter-Imhoff-Straße 1, 72138 Kirchentellinsfurt, DE  
LÖFFLER, Markus, Sandgrabenstrasse 20, 72119 Ammerbuch, DE  
NELDE, Annika, Hagellochter Weg 17, 42070 Tuebingen, DE  
RAMMENSEE, Hans-Georg, Sommerhalde 3, 72070 Unterjesingen, DE  
STEVANOVIC, Stefan, Auf der Burg 3, 72074 Tübingen, DE  
TRAUTWEIN, Nico, Pelargusstrasse 2, 70180 Stuttgart, DE  
WALZ, Juliane Sarah, Gartenstrasse 71, 72076 Tübingen, DE

(51) MKP  
**A61K 39/00 2006 (97) EP 3760225**  
**A61P 35/00 2006**

**C07K 14/47 2006**  
**C07K 16/00 2006**  
 (96) EP 20179381.7 4/22/2016  
 (97) EP 3760225, 3/24/2021 202112, en  
 (31) 201507030 (32) 24.04.2015 (33) GB  
 201562152258 P 24.04.2015 US  
 (54) NOVEL PEPTIDES AND COMBINATION OF PEPTIDES FOR USE IN IMMUNOTHERAPY AGAINST LUNG CANCER, INCLUDING NSCLC AND OTHER CANCERS  
 (72) MAHR, Andrea, Horemer 17, 72076 Tübingen, DE  
 WEINSCHENK, Toni, Im Morgenrain 15, 73773 Aichwald, DE  
 SCHOOR, Oliver, Eichhaldenstrasse 19, 72074 Tübingen, DE  
 FRITSCHKE, Jens, Lärchenweg 11, 72144 Dussilingen, DE  
 SINGH, Harpreet, 5122 Morningside Dr. Apt. 525, Houston, TX 77005, US  
 WAGNER, Claudia, Nürtinger Strasse 32, 72074 Tübingen, DE  
 LEIBOLD, Julia, Wiesenweg 1, 6336 Langkampfen, AT  
 SONG, Colette, Willi-Baumeister-Weg 21, 73760 Ostfildern, DE

---

(51) MKP  
**A01N 43/52 2006 (97) EP 3763706**  
**A61K 31/4184 2006**  
**C07D 235/10 2006**  
**C07D 235/18 2006**  
**C07D 235/28 2006**  
 (96) EP 20179838.6 4/18/2013  
 (97) EP 3763706, 1/13/2021 202102, en  
 (31) 201261635961 P (32) 20.04.2012 (33) US  
 (54) PARASITICIDAL COMPOSITIONS COMPRISING BENZIMIDAZOLE DERIVATIVES, METHODS AND USES THEREOF  
 (72) MENG, Charles Q., 7158 Belcrest Drive, Johns Creek, GA 30097, US

---

(51) MKP  
**B21D 28/02 2006 (97) EP 3797893**  
**B21D 28/16 2006**  
**B21D 37/08 2006**  
**B21D 43/14 2006**  
 (96) EP 20180923.3 6/18/2020  
 (97) EP 3797893, 3/31/2021 202113, de  
 (31) 102019125690 (32) 24.09.2019 (33) DE  
 (54) DEVICE FOR THE FINE CUTTING / NORMAL STAMPING OF BLANKS MADE FROM A METAL STRIP AND FOR THE MULTI-STAGE MACHINING OF THE BLANKS BY MEANS OF CUTTING AND MACHINING TOOLS  
 (71) Meteor Umformtechnik GmbH & Co. KG, Talstraße 54-56, 98544 Zella Mehlis, DE  
 (72) Pauer, Stephane, 6, Rue des Sapins, 67580 Mertzwiller, FR  
 Oppermann, Kai, Rosa-Luxemburg-Ring 35, 34253 Lohfelden, DE  
 Peters, Andreas, Am Ringofen 20, 40629 Düsseldorf, DE

---

(51) MKP  
**A61K 31/422 2006 (97) EP 3766491**  
**A61P 33/00 2006**  
 (96) EP 20181238.5 1/31/2013  
 (97) EP 3766491, 1/20/2021 202103, en  
 (31) 201261595463 P (32) 06.02.2012 (33) US  
 (54) PARASITICIDAL ORAL VETERINARY COMPOSITIONS COMPRISING SYSTEMICALLY-ACTING ACTIVE AGENTS, METHODS AND USES THEREOF  
 (72) SOLL, Mark, D., 605 Newport Shore, Alpharetta, GA Georgia 30005, US  
 LARSEN, Diane, 2422 Waybridge Court, Buford, GA Georgia 30519, US  
 CADY, Susan, Mancini, 1501 Revere Road, Yardley, PA Pennsylvania 19067, US  
 CHEIFETZ, Peter, 15 Lynnfield Drive, East Windsor, NJ New Jersey 08520, US  
 GALESKA, Izabela, 1725 Tristen Drive, Newtown, PA Pennsylvania 18940, US  
 GONG, Sajjun, 5 Terrace Lane, Bridgewater, NJ New Jersey 08807, US

---

(51) MKP  
**A61K 38/12 2006 (97) EP 3778622**  
**A61P 37/06 2006**  
**C07K 7/08 2006**

**C07K 7/56 2006**  
**G01N 33/68 2006**  
(96) EP 20182343.2 11/12/2015  
(97) EP 3778622, 3/24/2021 202112, en  
(31) 201462079944 P (32) 14.11.2014 (33) US  
201562111388 P 03.02.2015 US  
201562204689 P 13.08.2015 US  
(54) MACROCYCLIC PEPTIDES USEFUL AS IMMUNOMODULATORS  
(72) Gillman, Kevin W., 80 Bradley Corners Road, Madison, CT 06443, US  
Goodrich, Jason, 332 Rolling Knolls Way, Bridgewater, NJ 08807, US  
Boy, Kenneth M., 10 Ashley Road, Southborough, MA 01772, US  
Zhang, Yunhui, 11 Benjamin Rush LA, Princeton, NJ 08540, US  
Mapelli, Claudio, 465 Briggs Road, Langhorne, Pennsylvania 19047, US  
Poss, Michael A., Bristol-Myers Squibb Company c/o Bristol-Myers Squibb Company Route 206 and Province Line Road, Princeton, New Jersey 08543, US  
Sun, Li-Qiang, 12 Clymer Street, Newton, PA 18940, US  
Zhao, Qian, Bristol-Myers Squibb Company 93 Hintz Drive, Wallingford, Connecticut 06492, US  
Mull, Eric, 173 Cooks Lane, Guilford, CT 06437, US  
Gillis, Eric P., 245 S. Main Street, Cheshire, CT 06410, US  
Scola, Paul Michael, Bristol-Myers Squibb Company c/o Bristol-Myers Squibb Company 5 Research Parkway, Wallingford, Connecticut 06492, US  
Langley, David R., Bristol-Myers Squibb Company c/o Bristol-Myers Squibb Company 5 Research Parkway, Wallingford, Connecticut 06492, US  
Meanwell, M. Nicholas, Bristol-Myers Squibb Company c/o Bristol-Myers Squibb Company Route 206 and Province Line Road, Princeton, New Jersey 08543, US

---

(51) MKP  
**A61K 9/10 2006 (97) EP 3769753**  
**A61K 9/14 2006**  
**A61K 31/56 2006**  
**A61K 47/02 2006**  
**A61K 47/10 2017**  
**A61P 27/00 2006**  
**C07J 31/00 2006**  
**C07J 71/00 2006**  
(96) EP 20186965.8 7/21/2020  
(97) EP 3769753, 4/7/2021 202114, en  
(31) 201962877599 P (32) 23.07.2019 (33) US  
201962942551 P 02.12.2019 US  
(54) PROCESS FOR THE PREPARATION OF STERILE OPHTHALMIC AQUEOUS FLUTICASONE PROPIONATE FORM A NANOCRYSTALS SUSPENSIONS  
(71) Nicox Ophthalmics, Inc., 4721 Emperor Blvd. Suite 260, Durham, NC 27703, US  
(72) BUKOWSKI, Jean-Michel, 347, Avenue Max Camidas, Residence California Park Bat A, 06270 Villeneuve Leubet, FR  
NADKARNI, Akshay, 104, Disraeli Drive, Cary, NC 27513, US  
BOYER, José L., 103 Autumn Lane, Chapel Hill, NC 27516, US  
DUQUESROIX-CHAKROUN, Brigitte, 3 Avenue Saint Exupéry, 06800 Cagnes sur Mer, FR  
NAVRATIL, Tomas, 706 West Main Street, Carrboro, NC 27510, US

---

(51) MKP  
**A61K 39/395 2006 (97) EP 3792281**  
**A61P 17/06 2006**  
**C07K 16/24 2006**  
(96) EP 20187002.9 10/7/2011  
(97) EP 3792281, 3/17/2021 202111, en  
(31) 39138810 P (32) 08.10.2010 (33) US  
(54) METHODS OF TREATING PSORIASIS USING IL-17 ANTAGONISTS  
(72) GUETTNER, Achim, Novartis Pharma AG Postfach, 4002 Basel, CH  
MACHACEK, Matthias, Novartis Pharma AG Postfach, 4002 Basel, CH  
PAPAVASSILIS, Charis, Novartis Pharma AG Postfach, 4002 Basel, CH  
SANDER, Oliver, Novartis Pharma AG Postfach, 4002 Basel, CH

---

(51) MKP  
**A61P 3/00 2006 (97) EP 3763734**  
**A61P 3/04 2006**  
**A61P 3/06 2006**

**A61P 3/08 2006**  
**A61P 3/10 2006**  
**A61P 3/12 2006**  
**A61P 13/12 2006**  
**C07K 14/475 2006**  
**C07K 14/495 2006**  
**C07K 14/765 2006**  
**C12N 15/62 2006**  
 (96) EP 20189041.5 7/31/2014  
 (97) EP 3763734, 1/13/2021 202102, en  
 (31) 201361860723 P (32) 31.07.2013 (33) US  
 (54) GROWTH DIFFERENTIATION FACTOR 15 (GDF-15) CONSTRUCTS  
 (71) Amgen Inc., One Amgen Center Drive, Thousand Oaks CA 91320, US  
 (72) Xiong, YuMei, 2342 Middlefield Rd., Palo Alto, CA 94301, US  
 Zhang, Yi, 5162 Montiano Lane, Dublin, CA 94568, US  
 Sheng, Zeqi, 559 Lone Oak Drive, Thousand Oaks, CA 91362, US  
 Hamburger, Agnes Eva, 3885 Calle Alta Vista, Newbury Park, CA 91320, US  
 Veniant-Ellison, Murielle, 645 Camino Manzanos, Thousand Oaks, CA 91360, US  
 Shimamoto, Grant, 368 Via Colinas, West Lake Village, CA 91362, US  
 Min, Xiaoshan, 2108 Clarice Lane, Burlingame, CA 94010, US  
 Wang, Zhulun, 660 Glenbrook Drive, Palo Alto, CA 94306, US  
 Tang, Jie, 922 Moreno Avenue, Palo Alto, CA 94303, US  
 Kannan, Gunasekaran, 151 Crestview Circle, Daly City, CA 94015, US  
 Mock, Marissa, 229 S Dewey Avenue, Newbury Park, CA 91320, US  
 Walker, Kenneth W., 175 Mesa Avenue, Newbury Park, CA 91320, US

---

(51) MKP  
**A01N 25/00 2006 (97) EP 3788874**  
**A61K 31/42 2006**  
**A61P 33/00 2006**  
 (96) EP 20190542.9 9/12/2012  
 (97) EP 3788874, 3/10/2021 202110, en  
 (31) 201161533308 P (32) 12.09.2011 (33) US  
 (54) PARASITICIDAL COMPOSITIONS COMPRISING AN ISOXAZOLINE ACTIVE AGENT, METHOD AND USES THEREOF  
 (72) SOLL, Mark, D., 605 Newport Shore, Alpharetta, GA Georgia 30005, US  
 ROSENTEL, Joseph, K., 10675 Branham Fields Road, Johns Creek, GA Georgia 30097, US  
 PATE, James, 582 County Road 579, Hampton, NJ New Jersey 08827, US  
 SHUB, Natalya, 2308 S. Front Street, Allentown, PA Pennsylvania 18103, US  
 TEJWANI-MOTWANI, Monica, 47 Putnam Road, Monmouth Junction, NJ New Jersey 08852, US  
 BELANSKY, Carol, 292 West Colfax Ave, Roselle Park, NJ New Jersey 07204, US

---

(51) MKP  
**A61K 31/4192 2006 (97) EP 3766878**  
**A61K 31/553 2006**  
**A61P 9/10 2006**  
**A61P 9/12 2006**  
**A61P 11/00 2006**  
**A61P 11/06 2006**  
**A61P 13/12 2006**  
**A61P 17/00 2006**  
**A61P 25/00 2006**  
**A61P 35/00 2006**  
**A61P 37/00 2006**  
**C07D 267/14 2006**  
**C07D 403/06 2006**  
**C07D 413/06 2006**  
**C07D 413/10 2006**  
**C07D 498/04 2006**  
**C07D 519/00 2006**  
 (96) EP 20192327.3 6/15/2016  
 (97) EP 3766878, 1/20/2021 202103, en  
 (31) 201562175505 P (32) 15.06.2015 (33) US  
 (54) NRF2 REGULATORS  
 (71) Astex Therapeutics Limited, 436 Cambridge Science Park, Milton Road., Cambridge, Cambridgeshire, CB4 0QA, GB

(72) KERNS, Jeffrey K., 709 Swedeland Road, King of Prussia, PA 1406, US  
 YAN, Hongxing, 709 Swedeland Road, King of Prussia, PA 19406, US  
 CALLAHAN, James Francis, 709 Swedeland Road, King of Prussia, PA 19406, US  
 HEIGHTMAN, Thomas Daniel, 436 Cambridge Science Park Milton Road, Cambridge, Cambridgeshire, GB  
 BOEHM, Jeffrey Charles, 709 Swedeland Road, King of Prussia, PA 19406, US  
 WOOLFORD, Alison Jo-Anne, 436 Cambridge Science Park Milton Road, Cambridge, Cambridgeshire, GB

---

(51) MKP  
**A61K 8/04 2006 (97) EP 3799933**  
**A61K 8/34 2006**  
**A61K 8/36 2006**  
**A61K 8/365 2006**  
**A61K 8/60 2006**  
**A61K 8/9789 2017**  
**A61K 9/00 2006**  
**A61K 9/107 2006**  
**A61K 31/047 2006**  
**A61K 36/76 2006**  
**A61K 47/10 2017**  
**A61P 17/10 2006**  
**A61Q 17/04 2006**  
**A61Q 19/00 2006**  
**A61Q 19/10 2006**

(96) EP 20193192.0 2/23/2016  
 (97) EP 3799933, 4/7/2021 202114, en  
 (31) 15000576 (32) 27.02.2015 (33) EP  
 (54) COMPOSITION FOR THE TREATMENT OF ACNE  
 (72) Zanardi, Andrea, via Marcantonio dal Re, 20, 20156 Milano, IT  
 Franco, Gasparri, Via Beccara, 12 40020 Casalfiumanese (BO), Bologna, IT  
 Raffaella, Mantegazza, via Prina, 8 20800 Monza (MB), Monza, IT  
 Beltrandi, Martina, Via Annoni, 2 12084 Mondovi, Mondovi, IT

---

(51) MKP  
**A61K 31/4174 2006 (97) EP 3770146**  
**A61K 31/4439 2006**  
**A61P 21/00 2006**  
**C07D 233/64 2006**  
**C07D 401/04 2006**  
**C07D 405/10 2006**

(96) EP 20193960.0 10/5/2016  
 (97) EP 3770146, 1/27/2021 202104, en  
 (31) 201562238629 P (32) 07.10.2015 (33) US  
 201562243263 P 19.10.2015 US  
 201662352348 P 20.06.2016 US  
 (54) PPAR AGONISTS, COMPOUNDS, PHARMACEUTICAL COMPOSITIONS, AND METHODS OF USE THEREOF  
 (72) DOWNES, Michael, The Salk Institute for Biological Studies 10010 N. Torrey Pines, La Jolla, CA 92037, US  
 EVANS, Ronald, M., The Salk Institute for Biological Studies 10010 N. Torrey Pines Road, La Jolla, CA 92037, US  
 KLUGE, Arthur, P.O. Box 6177, Lincoln, MA 01773, US  
 LAGU, Bharat, 21 Lexington Drive, Acton, MA 01720, US  
 MIURA, Masanori, Miyukigaoka 21, Tsukuba, Ibaraki, JP  
 PANIGRAHI, Sunil Kumar, Bollaram Road Miyapur, 500049 Hyderabad, IN  
 PATANE, Michael, 6 Westwind Road, Andover, MA 01810, US  
 SAMAJDAR, Susanta, Bollaram Road Miyapur, 500049 Hyderabad, IN  
 SENAIAR, Ramesh, Bollaram Road Miyapur, 500049 Hyderabad, IN  
 TAKAHASHI, Taisuke, Miyukigaoka 21, Tsukuba, Ibaraki, JP

---

(51) MKP  
**A61K 31/4174 2006 (97) EP 3795566**  
**A61K 31/4439 2006**  
**A61P 21/00 2006**  
**A61P 25/00 2006**  
**C07D 401/04 2006**

(96) EP 20193962.6 10/5/2016  
 (97) EP 3795566, 3/24/2021 202112, en

(31)	201562238629 P 201562243263 P 201662352348 P	(32)	07.10.2015 19.10.2015 20.06.2016	(33)	US US US
(54)	PPAR AGONISTS, COMPOUNDS, PHARMACEUTICAL COMPOSITIONS, AND METHODS OF USE THEREOF				
(72)	DOWNES, Michael, The Salk Institute for Biological Studies 10010 N. Torrey Pines, La Jolla, CA 92037, US EVANS, Ronald, M., The Salk Institute for Biological Studies 10010 N. Torrey Pines Road, La Jolla, CA 92037, US KLUGE, Arthur, P.O. Box 6177, Lincoln, MA 01773, US LAGU, Bharat, 21 Lexington Drive, Acton, MA 01720, US MIURA, Masanori, Miyukigaoka 21, Tsukuba, Ibaraki, JP PANIGRAHI, Sunil, Kumar, Bollaram Road Miyapur, 500049 Hyderabad, IN PATANE, Michael, 6 Westwind Road, Andover, MA 01810, US SAMAJDAR, Susanta, Bollaram Road Miyapur, 500049 Hyderabad, IN SENAIAR, Ramesh, Bollaram Road Miyapur, 500049 Hyderabad, IN TAKAHASHI, Taisuke, Miyukigaoka 21, Tsukuba, Ibaraki, JP				

---

(51)	MKP <b>A61K 31/4188 2006 (97) EP 3778606</b> <b>C07D 491/052 2006</b>				
(96)	EP 20194823.9 11/16/2012				
(97)	EP 3778606, 3/3/2021 202109, en				
(31)	201161560654 P	(32)	16.11.2011	(33)	US
(54)	CONDENSED IMIDAZOLYLIMIDAZOLES AS ANTIVIRAL COMPOUNDS				
(72)	BACON, Elizabeth, 1218 Floribunda Avenue Apt. 8, Burlingame, CA 94010, US COTTELL, Jeromy, 701 Baltic Circle 719, Redwood City, CA 94065, US KATANA, Ashley Anne, 2201 Bridgepoint Parkway 205, San Mateo, CA 94404, US KATO, Darryl, 223 Connecticut Street, San Francisco, CA 94107, US KRYGOWSKI, Evan, 2231 California Street NW 507, Washington, DC 20008, US LINK, John, 74 Prospect Avenue, San Francisco, CA 94110, US TAYLOR, James, 100 State Street, San Mateo, CA 94401, US TRAN, Chinh Viet, 10322 Baron Drive, San Diego, CA 92126, US MARTIN, Teresa Alejandra Trejo, 3701 Naughton Ave, Belmont, CA 94002, US YANG, Zheng-Yu, 338 El Carmelo Avenue, Palo Alto, CA 94306, US ZIPFEL, Sheila, 22 N. San Mateo Drive Apt. 205, San Mateo, CA 94401, US				

---

(51)	MKP <b>A61K 31/4188 2006 (97) EP 3778606</b> <b>C07D 491/052 2006</b>				
(96)	EP 20194823.9 11/16/2012				
(97)	EP 3778606, 3/3/2021 202109, en				
(31)	201161560654 P	(32)	16.11.2011	(33)	US
(54)	CONDENSED IMIDAZOLYLIMIDAZOLES AS ANTIVIRAL COMPOUNDS				
(72)	BACON, Elizabeth, 1218 Floribunda Avenue Apt. 8, Burlingame, CA 94010, US COTTELL, Jeromy, 701 Baltic Circle 719, Redwood City, CA 94065, US KATANA, Ashley Anne, 2201 Bridgepoint Parkway 205, San Mateo, CA 94404, US KATO, Darryl, 223 Connecticut Street, San Francisco, CA 94107, US KRYGOWSKI, Evan, 2231 California Street NW 507, Washington, DC 20008, US LINK, John, 74 Prospect Avenue, San Francisco, CA 94110, US TAYLOR, James, 100 State Street, San Mateo, CA 94401, US TRAN, Chinh Viet, 10322 Baron Drive, San Diego, CA 92126, US MARTIN, Teresa Alejandra Trejo, 3701 Naughton Ave, Belmont, CA 94002, US YANG, Zheng-Yu, 338 El Carmelo Avenue, Palo Alto, CA 94306, US ZIPFEL, Sheila, 22 N. San Mateo Drive Apt. 205, San Mateo, CA 94401, US				

---

(51)	MKP <b>A01N 43/50 2006 (97) EP 3766871</b> <b>A01P 7/02 2006</b> <b>A01P 7/04 2006</b> <b>A61K 31/4164 2006</b> <b>A61K 31/4439 2006</b> <b>A61P 31/00 2006</b> <b>A61P 33/00 2006</b> <b>A61P 33/10 2006</b> <b>A61P 33/14 2006</b>
------	---

	<b>C07D 233/64</b>	<b>2006</b>					
	<b>C07D 401/04</b>	<b>2006</b>					
(96)	EP 20195605.9 8/11/2015						
(97)	EP 3766871, 1/20/2021 202103, en						
(31)	2014165034		(32)	13.08.2014		(33)	JP
(54)	DIARYLIMIDAZOLE COMPOUND AND PEST CONTROL AGENT						
(72)	AOYAMA, Hikaru, c/o Odawara Research Center, Nippon Soda Co., Ltd., 345, Takada, Odawara-shi, Kanagawa, 250-0280, JP						
	MATSUI, Maki, c/o Odawara Research Center, Nippon Soda Co., Ltd., 345, Takada, Odawara-shi, Kanagawa, 250-0280, JP						
	IWASA, Takao, c/o Odawara Research Center, Nippon Soda Co., Ltd., 345, Takada, Odawara-shi, Kanagawa, 250-0280, JP						
	FUJII, Kazushige, c/o Odawara Research Center, Nippon Soda Co., Ltd., 345, Takada, Odawara-shi, Kanagawa, 250-0280, JP						
	KOBAYASHI, Tomomi, c/o Odawara Research Center, Nippon Soda Co., Ltd., 345, Takada, Odawara-shi, Kanagawa, 250-0280, JP						
	SAKANISHI, Keita, c/o Odawara Research Center, Nippon Soda Co., Ltd., 345, Takada, Odawara-shi, Kanagawa, 250-0280, JP						

(51)	MKP						
	<b>A61K 31/45</b>	<b>2006</b>				<b>(97) EP 3786160</b>	
	<b>A61K 31/501</b>	<b>2006</b>					
	<b>C07D 213/04</b>	<b>2006</b>					
	<b>C07D 401/14</b>	<b>2006</b>					
	<b>C07D 451/02</b>	<b>2006</b>					
	<b>C07D 487/08</b>	<b>2006</b>					
	<b>C07D 498/08</b>	<b>2006</b>					
(96)	EP 20197194.2 10/25/2018						
(97)	EP 3786160, 3/3/2021 202109, en						
(31)	201762577883 P		(32)	27.10.2017		(33)	US
	201862628313 P			09.02.2018			US
(54)	PYRIDINE DERIVATIVES AND THERAPEUTIC USES THEREOF AS TRPC6 INHIBITORS						
(72)	Bouyssou, Thierry, c/o Boehringer Ingelheim International GmbH Corporate Patents Binger Strasse 173, 55216 Ingelheim am Rhein, DE						
	Gottschling, Dirk, c/o Boehringer Ingelheim International GmbH Corporate Patents Binger Strasse 173, 55216 Ingelheim am Rhein, DE						
	Heine, Niklas, c/o Boehringer Ingelheim International GmbH Corporate Patents Binger Strasse 173, 55216 Ingelheim am Rhein, DE						
	Smith Keenan, Lana Louise, 32 Green Street, Poughquag, NY 12570, US						
	Lowe, Michael D., 10 Pleasant Avenue, Pleasantville, NY 10570, US						
	Razavi, Hossein, 94 West Redding Road, Danbury, CT 06810, US						
	Sarko, Christopher Ronald, 6264 Main Branch Road, San Ramon, CA 94582, US						
	Surprenant, Simon, 1087 Chablis, Boisbriand, Québec J7G 2Y9, CA						
	Takahashi, Hidenori, 68 Ehmer Drive, LaGrangeville, NY 12540, US						
	Turner, Michael Robert, 55 Mill Plain Road Unit 5-9, Danbury, CT 06811, US						
	Wu, Xinyuan, 35 Travis Dr., Newton, MA 02467, US						

(51)	MKP						
	<b>A61K 39/095</b>	<b>2006</b>				<b>(97) EP 3782643</b>	
	<b>C07K 14/095</b>	<b>2006</b>					
	<b>C07K 14/22</b>	<b>2006</b>					
(96)	EP 20198399.6 2/27/2015						
(97)	EP 3782643, 2/24/2021 202108, en						
(31)	14157399		(32)	28.02.2014		(33)	EP
	14177566			17.07.2014			EP
(54)	MODIFIED MENINGOCOCCAL FHBP POLYPEPTIDES						
(72)	BOTTOMLEY, Matthew, Novartis Vaccines and Diagnostics S.r.l. Via Fiorentina 1, 53100 Siena, IT						
	MALITO, Enrico, Novartis Vaccines and Diagnostics S.r.l. Via Fiorentina 1, 53100 Siena, IT						
	MARTINELLI, Manuele, Novartis Vaccines and Diagnostics S.r.l. Via Fiorentina 1, 53100 Siena, IT						
	SCARSELLI, Maria, Novartis Vaccines and Diagnostics S.r.l. Via Fiorentina 1, 53100 Siena, IT						

(51)	MKP						
	<b>A61P 25/28</b>	<b>2006</b>				<b>(97) EP 3786182</b>	
	<b>C07K 14/435</b>	<b>2006</b>					
	<b>C07K 16/18</b>	<b>2006</b>					
	<b>G01N 33/53</b>	<b>2006</b>					
(96)	EP 20198475.4 11/18/2015						
(97)	EP 3786182, 3/3/2021 202109, en						
(31)	201462081809 P		(32)	19.11.2014		(33)	US
(54)	HUMANIZED TAU ANTIBODIES IN ALZHEIMER'S DISEASE						
(71)	Axon Neuroscience SE, 4, Arch Makariou & Kalogreon Nicolaidas Sea View City 5th Floor, office 506, 6016 Larnaca, CY						
(72)	NOVAK, Michal, Novosvetska 27, 811 04 BRATISLAVA, SK						
	KONTSEKOVA, Eva, Lichnerova 41, 903 01 SENEC, SK						

KOVACECH, Branislav, Markova 3, 851 01 BRATISLAVA, SK  
 SKRABANA, Rostislav, Novosveska 5, 841 07 BRATISLAVA, SK

- (51) MKP  
**A61K 39/395 2006 (97) EP 3789038**  
**A61P 35/00 2006**  
**A61P 35/02 2006**  
**A61P 37/04 2006**  
**C07K 16/28 2006**  
**C07K 16/46 2006**  
**C12N 5/07 2010**  
**C12N 5/16 2006**  
**C12P 21/08 2006**  
**G01N 33/68 2006**
- (96) EP 20198499.4 5/13/2011  
 (97) EP 3789038, 3/10/2021 202110, en
- (31) 39565210 P (32) 14.05.2010 (33) US
- (54) HUMANIZED AND CHIMERIC MONOCLONAL ANTIBODIES TO CD47  
 (72) LIU, Jie, 3119 Stockton Place, Palo Alto, CA 94303, US  
 WEISSMAN, Irving L., 747 Santa Ynez Street, Stanford, CA 94305, US  
 MAJETI, Ravindra, Stanford Institute for Stem Cell Bio and Regenerative Medicine 1050 Arastradero Road Building A, Stanford, CA 94304, US

- (51) MKP  
**A61K 31/5365 2006 (97) EP 3782996**  
**A61P 9/00 2006**  
**A61P 11/00 2006**  
**A61P 25/00 2006**  
**A61P 27/00 2006**  
**A61P 35/00 2006**  
**A61P 37/00 2006**  
**C07C 15/16 2006**  
**C07D 249/04 2006**  
**C07D 249/18 2006**  
**C07D 403/10 2006**  
**C07D 417/10 2006**
- (96) EP 20200207.7 6/15/2016  
 (97) EP 3782996, 2/24/2021 202108, en
- (31) 201562175510 P (32) 15.06.2015 (33) US
- (54) NRF2 REGULATORS  
 (72) KERNS, Jeffrey K, GlaxoSmithKline 709 Swedeland Road, King of Prussia, PA 19406, US  
 CALLAHAN, James Francis, GlaxoSmithKline 709 Swedeland Road, King of Prussia, PA 19406, US  
 YAN, Hongxing, GlaxoSmithKline 709 Swedeland Road, King of Prussia, PA 19406, US  
 HEIGHTMAN, Thomas Daniel, Astex Therapeutics Limited 436 Cambridge Science Park Milton Road, Cambridge, Cambridgeshire, GB  
 GRIFFITHS-JONES, Charlotte Mary, Astex Therapeutics Limited 436 Cambridge Science Park Milton Road, Cambridge, Cambridgeshire, GB  
 WOOLFORD, Alison Jo-Anne, Astex Therapeutics Limited 436 Cambridge Science Park Milton Road, Cambridge, Cambridgeshire, GB  
 LI, Tindy, GlaxoSmithKline 709 Swedeland Road, King of Prussia, PA 19406, US  
 LAKDAWALA SHAH, Ami, GlaxoSmithKline 709 Swedeland Road, King of Prussia, PA 19406, US  
 DAVIS, Roderick S., GlaxoSmithKline 709 Swedeland Road, King of Prussia, PA 19406, US  
 NORTON, David, Astex Therapeutics Limited 436 Cambridge Science Park Milton Road, Cambridge, Cambridgeshire, GB  
 GOODWIN, Nicole Cathleen, GlaxoSmithKline 709 Swedeland Road, King of Prussia, PA 19406, US  
 JIN, Yun, GlaxoSmithKline (China) R&D Co. Ltd. Building 3 898 Halei Road Zhangjiang Hi-Tech Park, Shanghai, 201203, CN  
 HAMILTON, Paris L., 826 Allison Circle, Anderson, SC 29625, US  
 BOEHM, Jeffrey Charles, 709 Swedeland Road, King of Prussia, PA 19406, US

- (51) MKP  
**A61K 31/53 2006 (97) EP 3785717**  
**A61K 31/664 2006**  
**A61K 31/675 2006**  
**A61K 31/683 2006**  
**A61K 31/685 2006**  
**A61P 31/12 2006**
- (96) EP 20201732.3 9/16/2016  
 (97) EP 3785717, 3/3/2021 202109, en
- (31) 201562219302 P (32) 16.09.2015 (33) US



201562239696 P

09.10.2015

US

- (54) METHODS FOR TREATING CORONAVIRIDAE INFECTIONS  
 (72) CLARKE, Michael O'Neil Hanrahan, c/o Gilead Sciences Inc 333 Lakeside Drive, Foster City, CA 94404, US  
 FENG, Joy Yang, c/o Gilead Sciences Inc 333 Lakeside Drive, Foster City, CA 94404, US  
 JORDAN, Robert, c/o Gilead Sciences Inc 333 Lakeside Drive, Foster City, CA 94404, US  
 MACKMAN, Richard L., c/o Gilead Sciences Inc 333 Lakeside Drive, Foster City, CA 94404, US  
 RAY, Adrian S., c/o Gilead Sciences Inc 333 Lakeside Drive, Foster City, CA 94404, US  
 SIEGEL, Dustin, c/o Gilead Sciences Inc 333 Lakeside Drive, Foster City, CA 94404, US
- 

- (51) MKP  
**G06F 9/54 2006 (97) EP 3783576**  
**G06F 13/00 2006**  
**G07F 17/32 2006**  
 (96) EP 20401012.8 2/18/2020  
 (97) EP 3783576, 4/7/2021 202114, de  
 (31) 102019122577 (32) 22.08.2019 (33) DE  
 (54) METHOD FOR DETECTING AND ANALYSING DATA DISPLAYED ON A DISPLAY SCREEN OF AN AUTOMATIC COIN-OPERATED GAMING MACHINE  
 (72) Bewersdorff, Jörg, Josef-Mehlhaus-Straße 8, 65549 Limburg, DE  
 Schröer, Werner, Adenauerallee 79, 46399 Bocholt, DE
- 

- (51) MKP  
**C07D 487/04 2006 (97) EP 3762390**  
 (96) EP 19713257.4 3/7/2019  
 (97) EP 3762390, 1/13/2021 202102, en  
 (31) 201862639642 P (32) 07.03.2018 (33) US  
 (54) PROCESS FOR PREPARING SOLUBLE GUANYLATE CYCLASE STIMULATORS  
 (72) STORZ, Thomas, c/o Cycleron Therapeutics, Inc. 301 Binney Street, Cambridge, MA 02142, US
- 

- (51) MKP  
**C08J 11/12 2006 (97) EP 3765559**  
**C08J 11/14 2006**  
**C08L 67/02 2006**  
 (96) EP 19713676.5 3/11/2019  
 (97) EP 3765559, 1/20/2021 202103, en  
 (31) 201812000 U (32) 12.03.2018 (33) CZ  
 (54) METHOD OF OBTAINING TEREPHTHALIC ACID FROM WASTE POLYETHYLENE TEREPHTHALATE  
 (71) JBPV s.r.o., U Hriste 346, 798 48 Protivanov, CZ  
 (72) SRAMEK, Jaromir, Rovná 380 190 15 Praha 9, Satalice, CZ  
 TRZEWICZEK, Michal, ul. Wojska Polskiego 45 Miedzylesie 57-530, PL  
 TRAVNICEK, Karel, .p. 15 798 52 Ochoz, CZ
- 

- (51) MKP  
**A61K 31/427 2006 (97) EP 3765458**  
**A61K 31/445 2006**  
**A61P 25/28 2006**  
**C07D 417/06 2006**  
**C07D 417/14 2006**  
**C07D 495/04 2006**  
 (96) EP 19713945.4 3/13/2019  
 (97) EP 3765458, 1/20/2021 202103, en  
 (31) 201862642932 P (32) 14.03.2018 (33) US  
 201862690536 P 27.06.2018 US  
 201862699443 P 17.07.2018 US  
 (54) O-GLYCOPROTEIN-2-ACETAMIDO-2-DEOXY-3-D-GLYCOPYRANOSIDASE INHIBITORS  
 (72) GENUUNG, Nathan, c/o Biogen MA Inc. 225 Binney Street, Cambridge, MA 02142, US  
 GUCKIAN, Kevin M., c/o Biogen MA Inc. 225 Binney Street, Cambridge, MA 02142, US  
 VESSELS, Jeffrey, c/o Biogen MA Inc. 225 Binney Street, Cambridge, MA 02142, US  
 ZHANG, Lei, c/o Biogen MA Inc. 225 Binney Street, Cambridge, MA 02142, US  
 GIANATASSIO, Ryan, c/o Biogen MA Inc. 225 Binney Street, Cambridge, MA 02142, US  
 LIN, Edward Yin Shiang, c/o Biogen MA Inc. 225 Binney Street, Cambridge, MA 02142, US  
 XIN, Zhili, c/o Biogen MA Inc. 225 Binney Street, Cambridge, MA 02142, US

(51) MKP  
**A61K 31/519 2006 (97) EP 3765461**  
**A61P 35/00 2006**  
**C07D 487/04 2006**  
**C07D 519/00 2006**

(96) EP 19714002.3 3/14/2019  
(97) EP 3765461, 1/20/2021 202103, en

(31)	201862642727 P	(32)	14.03.2018	(33)	US
	201862666726 P		04.05.2018		US
	201862742048 P		05.10.2018		US

(54) SELECTIVE INHIBITORS OF PROTEIN ARGININE METHYLTRANSFERASE 5 (PRMT5)  
(72) LUENGO, Juan, 50 Amherst Ct., Phoenixville, PA 19460, US  
LIN, Hong, 11 Fairwind Lane, Exton, PA 19341, US  
HAWKINS, Michael, 318 Heckler St., Ambler, PA 19002, US  
SHETTY, Rupa, 712 Amberley Drive, Blue Bell, PA 19422, US  
PITIS, Philip, 108 Sunrise Drive, North Wales, PA 19454, US  
SABORIT VILLARROYA, Gisela, 13 Passatge Manent, 08330 Premia De Mar, ES

(51) MKP  
**A61P 35/00 2006 (97) EP 3768711**  
**C07K 16/28 2006**

(96) EP 19714024.7 3/15/2019  
(97) EP 3768711, 1/27/2021 202104, en

(31)	201862647016 P	(32)	23.03.2018	(33)	US
------	----------------	------	------------	------	----

(54) ANTI-CD137 ANTIBODIES FOR COMBINATION WITH ANTI-PD-L1 ANTIBODIES  
(72) CARPENITO, Carmine, c/o Eli Lilly and Company P.O. Box 6288, Indianapolis, Indiana 46206-6288, US  
LI, Yiwon, c/o Eli Lilly and Company P.O. Box 6288, Indianapolis, Indiana 46206-6288, US

(51) MKP  
**A61K 39/00 2006 (97) EP 3768712**  
**A61P 35/00 2006**  
**C07K 16/28 2006**

(96) EP 19714025.4 3/15/2019  
(97) EP 3768712, 1/27/2021 202104, en

(31)	201862647046 P	(32)	23.03.2018	(33)	US
------	----------------	------	------------	------	----

(54) ANTI-CD137 ANTIBODIES FOR COMBINATION WITH ANTI-PD-1 ANTIBODIES  
(72) KALOS, Michael Dewain, c/o ELI LILLY AND COMPANY P.O. Box 6288, Indianapolis, Indiana 46206-6288, US

(51) MKP  
**C12M 1/34 2006 (97) EP 3765846**  
**G01N 33/50 2006**

(96) EP 19714056.9 3/15/2019  
(97) EP 3765846, 1/20/2021 202103, en

(31)	201862644339 P	(32)	16.03.2018	(33)	US
	201862645755 P		20.03.2018		US

(54) METHODS FOR IMPROVING CELL VIABILITY IN A PRODUCTION BIOREACTOR  
(72) WANG, Jonathan, c/o Sanofi U.S. 55 Corporate Drive Mail-Code: 55A- 525, Bridgewater, New Jersey 08807, US  
SHAH, Neha, c/o Sanofi U.S. 55 Corporate Drive Mail-Code: 55A- 525, Bridgewater, New Jersey 08807, US  
WALTHER, Jason, c/o Sanofi U.S. 55 Corporate Drive Mail-Code: 55A- 525, Bridgewater, New Jersey 08807, US  
LU, Jiuyi, c/o Sanofi U.S. 55 Corporate Drive Mail-Code: 55A- 525, Bridgewater, New Jersey 08807, US  
JOHNSON, Timothy, c/o Sanofi U.S. 55 Corporate Drive Mail-Code: 55A- 525, Bridgewater, New Jersey 08807, US  
REN, Yukun, c/o Sanofi U.S. 55 Corporate Drive Mail-Code: 55A- 525, Bridgewater, New Jersey 08807, US  
MCLARTY, Jean, c/o Sanofi U.S. 55 Corporate Drive Mail-Code: 55A- 525, Bridgewater, New Jersey 08807, US

(51) MKP  
**A61K 35/744 2015 (97) EP 3768284**  
**A61K 38/16 2006**  
**A61K 48/00 2006**  
**A61P 35/00 2006**  
**A61P 37/04 2006**  
**C07K 14/315 2006**

(96)	EP 19714132.8	3/19/2019			
(97)	EP 3768284,	1/27/2021	202104,	en	
(31)	201804384	(32)	19.03.2018	(33)	GB
	201809953		18.06.2018		GB
	18178350		18.06.2018		EP
	201811900		20.07.2018		GB
	201812378		30.07.2018		GB
	201813423		17.08.2018		GB
	201813444		17.08.2018		GB
	201816834		16.10.2018		GB
	201817641		29.10.2018		GB
	201901199		29.01.2019		GB
	201901218		29.01.2019		GB
	201901993		13.02.2019		GB
	201901992		13.02.2019		GB
(54)	COMPOSITIONS				
(72)	MULDER, Imke Elisabeth, C/O 4D PHARMA RESEARCH LIMITED Life Sciences Innovation Building Cornhill Road, Aberdeen AB25 2ZS, GB				
	RAFTIS, Emma, C/O 4D PHARMA RESEARCH LIMITED Life Sciences Innovation Building Cornhill Road, Aberdeen AB25 2ZS, GB				
	HENNESSY, Emma Elizabeth Clare, C/O 4D PHARMA RESEARCH LIMITED Life Sciences Innovation Building Cornhill Road, Aberdeen AB25 2ZS, GB				
	LAUTE-CALY, Delphine Louise Claudette, C/O 4D PHARMA RESEARCH LIMITED Life Sciences Innovation Building Cornhill Road, Aberdeen AB25 2ZS, GB				
	COWIE, Philip, C/O 4D PHARMA RESEARCH LIMITED Life Sciences Innovation Building Cornhill Road, Aberdeen AB25 2ZS, GB				

(51)	MKP				
	<b>B01J 23/02</b>	<b>2006</b>	<b>(97) EP 3768419</b>		
	<b>B01J 35/02</b>	<b>2006</b>			
	<b>B01J 35/10</b>	<b>2006</b>			
	<b>B01J 37/08</b>	<b>2006</b>			
	<b>C01F 1/00</b>	<b>2006</b>			
	<b>C01F 11/06</b>	<b>2006</b>			
	<b>C01F 11/18</b>	<b>2006</b>			
	<b>C07C 67/03</b>	<b>2006</b>			
	<b>C10L 1/02</b>	<b>2006</b>			
	<b>C10L 3/00</b>	<b>2006</b>			
	<b>C10L 3/10</b>	<b>2006</b>			
(96)	EP 19714134.4	3/19/2019			
(97)	EP 3768419,	1/27/2021	202104,	en	
(31)	18163580	(32)	23.03.2018	(33)	EP
(54)	METHOD FOR TRANSESTERIFICATION OF CARBOXYLIC ACID ESTERS				
(72)	FTOUNI, Jamal, Vordere Hauptgasse 86, 4800 Zofingen, CH				
	WELKER, Matthias, 11 Rue des Rossignols, 68220 Héisingue, FR				
	RENTSCH, Samuel, Gurtengartenstrasse 1, 3095 Spiegel bei Bern, CH				

(51)	MKP				
	<b>A23L 33/135</b>	<b>2016</b>	<b>(97) EP 3768285</b>		
	<b>A61K 35/744</b>	<b>2015</b>			
	<b>A61K 38/16</b>	<b>2006</b>			
	<b>A61P 37/04</b>	<b>2006</b>			
(96)	EP 19714136.9	3/19/2019			
(97)	EP 3768285,	1/27/2021	202104,	en	
(31)	201804384	(32)	19.03.2018	(33)	GB
	201809953		18.06.2018		GB
	18178350		18.06.2018		EP
	201811900		20.07.2018		GB
	201812378		30.07.2018		GB
	201813423		17.08.2018		GB
	201813444		17.08.2018		GB
	201816834		16.10.2018		GB
	201817641		29.10.2018		GB
	201901199		29.01.2019		GB
	201901218		29.01.2019		GB
	201901993		13.02.2019		GB
	201901992		13.02.2019		GB
(54)	COMPOSITIONS COMPRISING BACTERIAL STRAINS				

- (72) PANZICA, Domenico, c/o 4D Pharma Research Limited Life Sciences Innovation Building Cornhill Road Aberdeen, Aberdeenshire AB25 2ZS, GB  
 HOLT, Amy Beth, c/o 4D Pharma Research Limited Life Sciences Innovation Building Cornhill Road Aberdeen, Aberdeenshire AB25 2ZS, GB  
 AHMED, Suaad, c/o 4D Pharma Research Limited Life Sciences Innovation Building Cornhill Road Aberdeen, Aberdeenshire AB25 2ZS, GB  
 ETTORRE, Anna, c/o 4D Pharma Research Limited Life Sciences Innovation Building Cornhill Road Aberdeen, Aberdeenshire AB25 2ZS, GB  
 MULDER, Imke Elisabeth, c/o 4D Pharma Research Limited Life Sciences Innovation Building Cornhill Road Aberdeen, Aberdeenshire AB25 2ZS, GB  
 COWIE, Philip, c/o 4D Pharma Research Limited Life Sciences Innovation Building Cornhill Road Aberdeen, Aberdeenshire AB25 2ZS, GB  
 RAFTIS, Emma, c/o 4D Pharma Research Limited Life Sciences Innovation Building Cornhill Road Aberdeen, Aberdeenshire AB25 2ZS, GB  
 HENNESSY, Emma Elizabeth Clare, c/o 4D Pharma Research Limited Life Sciences Innovation Building Cornhill Road Aberdeen, Aberdeenshire AB25 2ZS, GB  
 LAUTE-CALY, Delphine Louise Claudette, c/o 4D Pharma Research Limited Life Sciences Innovation Building Cornhill Road Aberdeen, Aberdeenshire AB25 2ZS, GB  
 COUTURIER-MAILLARD, Aurélie Pascale Patricia, c/o 4D Pharma Research Limited Life Sciences Innovation Building Cornhill Road Aberdeen, Aberdeenshire AB25 2ZS, GB  
 DELDAY, Margaret Inkster, 1 ENZEAN COTTAGE MONYMUSK Kemnay Scotland AB51 5LQ, kemnay Scotland AB51 5LQ, GB  
 ADRIANI, Marsilio, c/o 4D Pharma Research Limited Life Sciences Innovation Building Cornhill Road Aberdeen, Aberdeenshire AB25 2ZS, GB  
 CHRISTOFI, Maria, c/o 4D Pharma Research Limited Life Sciences Innovation Building Cornhill Road Aberdeen, Aberdeenshire AB25 2ZS, GB

- (51) MKP  
**A61K 6/00 2020 (97) EP 3768224**  
**A61K 8/04 2006**  
**A61K 8/19 2006**  
**A61K 8/20 2006**  
**A61K 8/22 2006**  
**A61K 8/37 2006**  
**A61K 8/43 2006**  
**A61K 8/73 2006**  
**A61K 8/81 2006**  
**A61K 31/155 2006**  
**A61K 31/192 2006**  
**A61K 31/616 2006**  
**A61P 1/02 2006**  
**A61Q 11/00 2006**  
**A61Q 11/02 2006**
- (96) EP 19714246.6 3/8/2019  
 (97) EP 3768224, 1/27/2021 202104, en  
 (31) 201800003872 (32) 22.03.2018 (33) IT  
 (54) ANTISEPTIC AND/OR ANTI-INFLAMMATORY GEL FOR TREATMENT OF ORAL CAVITY DISEASES COMPRISING POLYVINYL ALCOHOL AND POLYACIDS  
 (71) DTech - Società a Responsabilità Limitata, Via Mangionello 12, 73024 Maglie (LE), IT  
 (72) CHIARELLI, Piero, c/o Dtech - Società A Responsabilità Limitata Via Mangionello 12, 73024 Maglie (LE), IT

- (51) MKP  
**A61K 31/553 2006 (97) EP 3762393**  
**A61P 35/00 2006**  
**C07D 498/10 2006**  
**C07D 498/20 2006**  
**C07D 498/22 2006**
- (96) EP 19714512.1 3/4/2019  
 (97) EP 3762393, 1/13/2021 202102, en  
 (31) 201862638846 P (32) 05.03.2018 (33) US  
 (54) ALPHA-HYDROXY PHENYLACETIC ACID PHARMACOPHORE OR BIOISOSTERE MCL-1 PROTEIN ANTAGONISTS  
 (72) RESCOURIO, Gwenaella, Law Department - Patent Operations One Amgen Center Drive, Thousand Oaks, California 91320, US  
 GONZALEZ BUENROSTRO, Ana, Law Department - Patent Operations One Amgen Center Drive, Thousand Oaks, California 91320, US  
 BROWN, Sean P., Law Department - Patent Operations One Amgen Center Drive, Thousand Oaks, California 91320, US  
 LIZARZABURU, Mike, Law Department - Patent Operations One Amgen Center Drive, Thousand Oaks, California 91320, US  
 MEDINA, Julio C., Law Department - Patent Operations One Amgen Center Drive, Thousand Oaks, California 91320, US  
 JABRI, Salman Yojiro, Law Department - Patent Operations One Amgen Center Drive, Thousand Oaks, California 91320, US  
 SUN, Daqing, Law Department - Patent Operations One Amgen Center Drive, Thousand Oaks, California 91320, US  
 SIMONOVICH, Scott Preston, Law Department - Patent Operations One Amgen Center Drive, Thousand Oaks, California 91320, US  
 YAN, Xuelei, Law Department - Patent Operations One Amgen Center Drive, Thousand Oaks, California 91320, US  
 LI, Yihong, Law Department - Patent Operations One Amgen Center Drive, Thousand Oaks, California 91320, US  
 REW, Yosup, Law Department - Patent Operations One Amgen Center Drive, Thousand Oaks, California 91320, US

(51) MKP  
**A61K 31/519 2006 (97) EP 3761987**  
**A61K 31/7068 2006**  
**A61K 45/06 2006**  
**A61P 25/28 2006**  
(96) EP 19714549.3 3/7/2019  
(97) EP 3761987, 1/13/2021 202102, en  
(31) 18305245 (32) 07.03.2018 (33) EP  
(54) COMPOUNDS FOR TREATING ALZHEIMER'S DISEASE  
(71) Amabiotics, 47, rue de Montmorency, 75003 Paris, FR  
(72) GARNIER, Patrice, San Polo 1865, 30125 Venezia, IT  
DANCHIN, Antoine, 86 rue Brillat-Savarin, 75003 Paris, FR

---

(51) MKP  
**B02C 17/16 2006 (97) EP 3781321**  
(96) EP 19714675.6 4/4/2019  
(97) EP 3781321, 2/24/2021 202108, en  
(31) 18167551 (32) 16.04.2018 (33) EP  
(54) HYBRID DISC  
(72) MASSAFRA, Francesco, Sundgauerstrasse 74, 4106 Therwil, CH  
RÖGELS, Christoph, Schloss-Strasse 15e, 79541 Lörrach, DE

---

(51) MKP  
**A61K 31/4468 2006 (97) EP 3768265**  
**A61P 9/00 2006**  
**A61P 25/00 2006**  
**A61P 25/02 2006**  
**A61P 25/04 2006**  
**A61P 25/16 2006**  
**A61P 25/28 2006**  
(96) EP 19715003.0 3/14/2019  
(97) EP 3768265, 1/27/2021 202104, en  
(31) 18163425 (32) 22.03.2018 (33) EP  
(54) NEW CENTRALLY-ACTIVE GHRELIN AGONIST AND MEDICAL USES THEREOF  
(72) GIULIANO, Claudio, Via Pian Scairolo 9, 6912 Lugano-Pazzallo, CH  
PIETRA, Claudio, Via Pian Scairolo 9, 6912 Lugano-Pazzallo, CH  
GARCIA RUBIO, Silvina, 7 Bellflower Ct., Princeton, New Jersey 08540, US  
GUAINAZZI, Angelo, 52 West 120th St. Apt. 3, New York, New York 10027, US  
MARTINEZ-LOI, Marielle, Via Industria 24, 6710 Biasca, CH

---

(51) MKP  
**A61K 31/395 2006 (97) EP 3765447**  
**A61K 31/675 2006**  
**C07D 255/02 2006**  
(96) EP 19715609.4 3/15/2019  
(97) EP 3765447, 1/20/2021 202103, en  
(31) 201862643931 P (32) 16.03.2018 (33) US  
201962803704 P 11.02.2019 US  
(54) TRIAZACYCLODODECANSULFONAMIDE ("TCD")-BASED PROTEIN SECRETION INHIBITORS  
(72) JOHNSON, Henry, 360 Hazel Avenue, San Bruno, CA 94066, US

---

(51) MKP  
**A61K 39/395 2006 (97) EP 3768311**  
**A61P 43/00 2006**  
**C07K 16/18 2006**  
**C07K 16/28 2006**  
(96) EP 19715723.3 3/22/2019  
(97) EP 3768311, 1/27/2021 202104, en  
(31) 201862647341 P (32) 23.03.2018 (33) US  
(54) TREATMENT AND PROPHYLAXIS OF AMYLOIDOSIS

(72) NIJJAR, Tarlochan, 712 Ironbark Court, Orinda, California 94563, US  
 DOLAN III, Philip J., 622 Edgewater Blvd. 303, Foster City, California 94404, US  
 BARBOUR, Robin, 250 Normandy Lane, Walnut Creek, California 94598, US

(51) MKP  
**A61P 35/00 2006 (97) EP 3768715**  
**C07K 16/28 2006**

(96) EP 19715768.8 3/22/2019

(97) EP 3768715, 1/27/2021 202104, en

(31) 201862647556 P (32) 23.03.2018 (33) US  
 201862667170 P 04.05.2018 US

(54) ANTIBODIES AGAINST MICA AND/OR MICB AND USES THEREOF

(72) KUHNE; Michelle Renee, 2368 21st Avenue, San Francisco California 94116, US  
 KORMAN, Alan J., 1207 Oakland Avenue, Piedmont California 94611, US  
 HUANG, Haichun, 2425 Sueno Way, Fremont California 94539, US  
 YIN, Yiming, 11 Ashford Lane, Andover Massachusetts 01810, US  
 GRAZIANO, Robert F., 26 Kingsridge Road, Frenchtown New Jersey 08825, US  
 BEZMAN, Natalie A., 700 Bay Road, Redwood City California 94063, US  
 STROP, Pavel, 700 Bay Road, Redwood City California 94063, US  
 HUANG, Richard Y., Route 206 and Province Line road, Princeton New Jersey 08543, US  
 CHEN, Guodong, Route 206 and Province Line road, Princeton New Jersey 08543, US  
 SRINIVASAN, Mohan, 10358 Glenview Ave., Cupertino California 95014, US  
 LEE, Peter Sung Keun, 700 Bay Road, Redwood City California 94063, US  
 CAMDERE, Gamze Ozlem, 1948 Milburn St, Camarillo, California 93010-6305, US

(51) MKP  
**A47B 7/00 2006 (97) EP 3761830**  
**A47B 13/02 2006**

(96) EP 19716585.5 3/8/2019

(97) EP 3761830, 1/13/2021 202102, en

(31) 201800003386 (32) 08.03.2018 (33) IT

(54) FURNISHING COMPONENT AND PRODUCTION METHOD

(71) Natisa S.r.l., Via della Stazione, SN, 33040 Moimacco, IT  
 (72) IACUZZI, Roberto, Via dei Gelsi, 17, 33040 Moimacco, IT  
 BUSOLINI, Mauro, Via della Scuola, 13, 33043 Cividale del Friuli, IT

(51) MKP  
**A61K 39/00 2006 (97) EP 3765069**  
**A61K 39/385 2006**  
**G01N 33/68 2006**

(96) EP 19716631.7 3/18/2019

(97) EP 3765069, 1/20/2021 202103, en

(31) 201862643921 P (32) 16.03.2018 (33) US

(54) PEPTIDE VACCINES AGAINST INTERLEUKIN-31

(72) BAMMERT, Gary, Francis, c/o Zoetis Services LLC 333 Portage Street, Kalamazoo, MI 49007, US  
 DUNHAM, Steven, Alan, c/o Zoetis Services LLC 333 Portage Street, Kalamazoo, MI 49007, US

(51) MKP  
**C12Q 1/06 2006 (97) EP 3768850**  
**C12Q 1/24 2006**

(96) EP 19717023.6 3/22/2019

(97) EP 3768850, 1/27/2021 202104, en

(31) 201862646588 P (32) 22.03.2018 (33) US

(54) METHODS FOR MEASURING BACTERIA IN BIOLOGICAL SAMPLES

(72) FARACE, Giosi, 98 Knubble Road, Georgetown, ME 04548, US  
 BRAFF, Jon, 7 Cushman Street, Portland, ME 04102, US  
 YERRAMILI, Murthy VSN, 7 Old Oak Way, Falmouth, ME 04105, US

(51) MKP  
**A61K 31/165 2006 (97) EP 3768660**  
**A61K 31/397 2006**  
**A61K 31/438 2006**

**A61P 25/00 2006**  
**A61P 35/00 2006**  
**C07D 205/12 2006**  
**C07D 207/09 2006**  
**C07D 209/52 2006**  
**C07D 211/58 2006**  
**C07D 211/74 2006**  
**C07D 215/12 2006**  
**C07D 221/20 2006**  
**C07D 233/32 2006**  
**C07D 271/10 2006**  
**C07D 277/68 2006**  
**C07D 311/66 2006**  
**C07D 401/04 2006**  
**C07D 401/12 2006**  
**C07D 403/04 2006**  
**C07D 413/04 2006**

(96) EP 19717024.4 3/22/2019

(97) EP 3768660, 1/27/2021 202104, en

(31)	201862647345 P	(32)	23.03.2018	(33)	US
	201962802128 P		06.02.2019		US

(54) MODULATORS OF EUKARYOTIC INITIATION FACTOR 2

(72) CRAIG, Robert A., II, c/o Denali Therapeutics Inc. 161 Oyster Point Blvd., South San Francisco, California 94080, US  
 DE VICENTE FIDALGO, Javier, c/o Denali Therapeutics Inc. 161 Oyster Point Blvd., South San Francisco, California 94080, US  
 ESTRADA, Anthony A., c/o Denali Therapeutics Inc. 161 Oyster Point Blvd., South San Francisco, California 94080, US  
 FENG, Jianwen A., c/o Denali Therapeutics Inc. 161 Oyster Point Blvd., South San Francisco, California 94080, US  
 FOX, Brian M., c/o Denali Therapeutics Inc. 161 Oyster Point Blvd., South San Francisco, California 94080, US  
 LEXA, Katrina W., c/o Denali Therapeutics Inc. 161 Oyster Point Blvd., South San Francisco, California 94080, US  
 OSIPOV, Maksim, c/o Denali Therapeutics Inc. 161 Oyster Point Blvd., South San Francisco, California 94080, US  
 SWEENEY, Zachary K., c/o Denali Therapeutics Inc. 161 Oyster Point Blvd., South San Francisco, California 94080, US  
 THOTTUMKARA, Arun, c/o Denali Therapeutics Inc. 161 Oyster Point Blvd., South San Francisco, California 94080, US

(51) MKP

**A61P 35/00 2006 (97) EP 3765474**  
**C07H 19/213 2006**

(96) EP 19717149.9 3/12/2019

(97) EP 3765474, 1/20/2021 202103, en

(31)	201862643467 P	(32)	15.03.2018	(33)	US
	201862666204 P		03.05.2018		US
	201862742532 P		08.10.2018		US
	201962809990 P		25.02.2019		US

(54) CYCLOPENTANE-BASED MODULATORS OF STING (STIMULATOR OF INTERFERON GENES)

(72) WYTHES, Martin James, c/o Pfizer Inc. 10777 Science Center Drive, San Diego, California 92121, US  
 MCALPINE, Indrawan James, c/o Pfizer Inc. 10777 Science Center Drive, San Diego, California 92121, US  
 PATMAN, Ryan, c/o Pfizer Inc. 10777 Science Center Drive, San Diego, California 92121, US  
 RUI, Eugene Yuanjin, c/o Pfizer Inc. 10777 Science Center Drive, San Diego, California 92121, US  
 FENSOME, Andrew, c/o Pfizer Inc. 610 Main Street, Cambridge, Massachusetts 02139, US  
 MADERNA, Andreas, c/o Pfizer Inc. 10777 Science Center Drive, San Diego, California 92121, US  
 JALAIIE, Mehran, c/o Pfizer Inc. 10777 Science Center Drive, San Diego, California 92121, US  
 GAJIWALA, Ketan S., c/o Pfizer Inc. 10777 Science Center Drive, San Diego, California 92121, US

(51) MKP

**G01N 33/68 2006 (97) EP 3765856**

(96) EP 19717387.5 3/12/2019

(97) EP 3765856, 1/20/2021 202103, en

(31)	201862642444 P	(32)	13.03.2018	(33)	US
------	----------------	------	------------	------	----

(54) METHODS FOR THE PREPARATION OF TRYPSIN-RESISTANT POLYPEPTIDES FOR MASS SPECTROMETRIC ANALYSIS

(72) BENCHHAAR, Sabrina Amelle, c/o Amgen Inc. One Amgen Center Drive Law Department-Patent Operations Mail Stop 28-5-A, Thousand Oaks, California 91320-1799, US  
 DYKSTRA, Andrew, c/o Amgen Inc. One Amgen Center Drive Law Department-Patent Operations Mail Stop 28-5-A, Thousand Oaks, California 91320-1799, US

(51) MKP

	<b>C01D 15/02</b>	<b>2006</b>	<b>(97) EP 3793943</b>				
	<b>C01D 15/08</b>	<b>2006</b>					
	<b>C22B 26/12</b>	<b>2006</b>					
(96)	EP 19717505.2 4/5/2019						
(97)	EP 3793943, 3/24/2021 202112, en						
(31)	PCT/FI2018/050377		(32)	18.05.2018		(33)	WO
(54)	METHOD FOR RECOVERING LITHIUM HYDROXIDE						
(71)	OUTOTEC (FINLAND) OY, Rauhalanpuisto 9, 02230 Espoo, FI						
(72)	TIIHONEN, Marika, Nuolitie 16 A, 02240 Espoo, FI HAAVANLAMMI, Liisa, Lyhdekuja 1 D, 02200 Espoo, FI KOLEHMAINEN, Eero, Rentukantie 11 as 5, 28660 Pori, FI KINNUNEN, Sami, Teljänkuja 2 as 18, 28130 Pori, FI SAVIKANGAS, Juho, Roihutie 3 as 2, 28220 Pori, FI						
(51)	MKP		<b>(97) EP 3762288</b>				
	<b>B63B 22/00</b>	<b>2006</b>					
	<b>B63B 35/00</b>	<b>2020</b>					
	<b>B63B 35/44</b>	<b>2006</b>					
	<b>G01S 7/00</b>	<b>2006</b>					
(96)	EP 19717601.9 3/4/2019						
(97)	EP 3762288, 1/13/2021 202102, en						
(31)	20180100110		(32)	08.03.2018		(33)	GR
(54)	FLOATING PLATFORM FOR MARITIME SURVEILLANCE						
(71)	Etme: Peppas Kai Synergates E.E., Sinopsis Str. 43, 11527 Athens, GR						
(72)	PEPPAS, Antonios, 6 Orvylon Str., 14561 Kifisia Athens, GR						
(51)	MKP		<b>(97) EP 3793592</b>				
	<b>A61K 39/00</b>	<b>2006</b>					
	<b>C07K 14/47</b>	<b>2006</b>					
	<b>C07K 14/74</b>	<b>2006</b>					
(96)	EP 19717884.1 4/12/2019						
(97)	EP 3793592, 3/24/2021 202112, en						
(31)	102018111819		(32)	16.05.2018		(33)	DE
	201862672411 P			16.05.2018			US
(54)	PEPTIDES FOR USE IN IMMUNOTHERAPY AGAINST CANCERS						
(72)	SONG, Colette, Willi-Baumeister-Weg 21, 73760 Ostfildern, DE HOFFGAARD, Franziska, Schwärzlocher Strasse 64, 72070 Tübingen, DE KOWALEWSKI, Daniel, Denzenbergerstrasse 29, 72074 Tübingen, DE SCHOOR, Oliver, Eichhaldenstrasse 19, 72074 Tübingen, DE FRITSCHKE, Jens, Lärchenweg 11, 72144 Dusslingen, DE WEINSCHENK, Toni, Im Morgenrain 15, 73773 Aichwald, DE SINGH, Harpreet, Heckscherstraße 25a, 80804 München, DE						
(51)	MKP		<b>(97) EP 3765857</b>				
	<b>G01N 33/68</b>	<b>2006</b>					
(96)	EP 19717990.6 3/13/2019						
(97)	EP 3765857, 1/20/2021 202103, en						
(31)	201862642549 P		(32)	13.03.2018		(33)	US
(54)	SEQUENTIAL DIGESTION OF POLYPEPTIDES FOR MASS SPECTROMETRIC ANALYSIS						
(72)	REN, Da, 2489 Seacrest Court, Thousand Oaks, California 91362, US SATO, Melissa, 1128 10th Street, 10, Santa Monica, California 90403, US						
(51)	MKP		<b>(97) EP 3768716</b>				
	<b>A61K 39/395</b>	<b>2006</b>					
	<b>C07K 16/28</b>	<b>2006</b>					
(96)	EP 19718001.1 3/19/2019						
(97)	EP 3768716, 1/27/2021 202104, en						
(31)	201862646344 P		(32)	21.03.2018		(33)	US
	201862696597 P			11.07.2018			US
	201862733462 P			19.09.2018			US
(54)	ANTIBODIES BINDING TO VISTA AT ACIDIC PH						



(72) JOHNSTON, Robert J., Rte. 206 & Province Line Road P.O. Box 4000, Princeton, New Jersey 08543, US  
 RAJPAL, Arvind, Rte. 206 & Province Line Road P.O. Box 4000, Princeton, New Jersey 08543, US  
 SHEPPARD, Paul O., Rte. 206 & Province Line Road P.O. Box 4000, Princeton, New Jersey 08543, US  
 BORGES, Luis, 111 Oyster Point Blvd. South, San Francisco, California 94080, US  
 RANKIN, Andrew, 111 Oyster Point Blvd. South, San Francisco, California 94080, US  
 BAHJAT, Keith Sadoon, Rte. 206 & Province Line Road P.O. Box 4000, Princeton, New Jersey 94080, US  
 KORMAN, Alan J., Rte. 206 & Province Line Road P.O. Box 4000, Princeton, New Jersey 08543, US  
 DENG, Xiaodi, Rte. 206 & Province Line Road P.O. Box 4000, Princeton, New Jersey 08543, US  
 SU, Lin Hui, Rte. 206 & Province Line Road P.O. Box 4000, Princeton, New Jersey 08543, US  
 RAKESTRAW, Ginger, Rte. 206 & Province Line Road P.O. Box 4000, Princeton, New Jersey 08543, US  
 PINCKNEY, Jason R., Rte. 206 & Province Line Road P.O. Box 4000, Princeton, New Jersey 08543, US  
 CRITTON, David A., Rte. 206 & Province Line Road P.O. Box 4000, Princeton, New Jersey 08543, US  
 CHEN, Guodong, Rte. 206 & Province Line Road P.O. Box 4000, Princeton, New Jersey 08543, US  
 HUANG, Richard Y., Rte. 206 & Province Line Road P.O. Box 4000, Princeton, New Jersey 08543, US  
 DEYANOVA, Ekaterina G., Rte. 206 & Province Line Road P.O. Box 4000, Princeton, New Jersey 08543, US

(51) MKP  
**A61K 9/00 2006 (97) EP 3784209**  
**A61P 7/06 2006**  
**A61P 37/04 2006**  
**A61P 37/06 2006**  
**G01N 15/02 2006**  
**G01N 15/10 2006**

(96) EP 19718214.0 4/2/2019

(97) EP 3784209, 3/3/2021 202109, en

(31) 201862661929 P (32) 24.04.2018 (33) US

(54) METHOD FOR MAKING INJECTABLE PHARMACEUTICAL COMPOSITIONS

(72) SPASOFF, Andrew Phillip, 7105 Old Gate Road, Rockville, Maryland 20852, US  
 ATKINSON, Susanne Therese, 4 Rathmichael Woods Shankill, Dublin, D18C7P2, IE  
 BENNIS, Adrian, 48 Ballyroan Crescent Rathfarnham, Dublin, 16, IE  
 FREUND, Erwin, 12059 Pradera Road, Camarillo, California 93012, US

(51) MKP  
**C09C 1/02 2006 (97) EP 3784736**  
**D21H 17/67 2006**

(96) EP 19718670.3 4/16/2019

(97) EP 3784736, 3/3/2021 202109, en

(31) 18168806 (32) 23.04.2018 (33) EP

(54) USE OF ADDITIVES CONTAINING PRIMARY ALKANOLAMINES IN AQUEOUS MINERAL SUSPENSIONS

(72) BURI, Matthias, Mätteliweg 20, 4852 Rothrist, CH  
 RENTSCH, Samuel, Gurtengartenstrasse 1, 3095 Spiegel bei Bern, CH  
 IPPOLITO, Fabio, Kührainweg 12, 4803 Vordemwald, CH

(51) MKP  
**A61K 31/437 2006 (97) EP 3784667**  
**A61P 31/16 2006**  
**C07D 471/04 2006**

(96) EP 19718707.3 4/19/2019

(97) EP 3784667, 3/3/2021 202109, en

(31) 18168671 (32) 23.04.2018 (33) EP

(54) HETEROAROMATIC COMPOUNDS HAVING ACTIVITY AGAINST RSV

(72) LANÇOIS, David Francis Alain, c/o Janssen-Cilag 1 rue Camille Desmoulin, TSA 91003, 92787 Issy-les-Moulineaux Cedex 9, FR  
 GUILLEMONT, Jérôme Émile Georges, c/o Janssen-Cilag 1 rue Camille Desmoulin, TSA 91003, 92787 Issy-les-Moulineaux Cedex 9, FR  
 RABOISSON, Pierre Jean-Marie Bernard, Avenue Denis Diderot 5, 1300 Wavre, BE  
 RIGAUX, Peter, c/o Janssen Pharmaceutica NV Turnhoutseweg 30, 2340 Beerse, BE  
 MICHAUT, Antoine Benjamin, c/o NovAliX SAS BioParc Boulevard Sébastien Brant BP 30170, 67405 Illkirch Cedex, FR  
 QUATREVAUX, Sabrina Dany France, c/o Janssen-Cilag 1 rue Camille Desmoulin, TSA 91003, 92787 Issy-les-Moulineaux Cedex 9, FR  
 CHAO, Sovy, c/o Janssen-Cilag 1 rue Camille Desmoulin, TSA 91003, 92787 Issy-les-Moulineaux Cedex 9, FR  
 ROYMANS, Dirk André Emmy, c/o Janssen Pharmaceutica NV Turnhoutseweg 30, 2340 Beerse, BE

(51) MKP  
**H04L 12/28 2006 (97) EP 3769473**

(96) EP 19718925.1 3/18/2019

(97) EP 3769473, 1/27/2021 202104, en  
 (31) 201800003706 (32) 19.03.2018 (33) IT  
 (54) MULTI USER DSL METHOD AND SYSTEM FOR THE STATISTICAL MULTIPLEXING OF COPPER LINES  
 (71) Krupter SRL, Via Bruxelles, 59, 00198 Roma (RM), IT  
 (72) VATALARO, Francesco, Via Piediluco, 9, 00199 ROMA (RM), IT  
 MAZZENGA, Franco, Via Costantino, 116B, 00145 ROMA (RM), IT  
 GIULIANO, Romeo, Via Nicola Stame, 127Q, 00128 ROMA (RM), IT

---

(51) MKP  
**A61F 5/058 2006 (97) EP 3781219**  
**A61L 15/08 2006**  
**A61L 15/12 2006**  
**A61L 15/14 2006**  
 (96) EP 19719455.8 4/15/2019  
 (97) EP 3781219, 2/24/2021 202108, en  
 (31) 20180613 (32) 17.04.2018 (33) HR  
 20190683 10.04.2019 HR  
 (54) A KIT FOR IN SITU IMMOBILIZATION WITH ANTIFUNGAL AND ANTIMICROBIAL EFFECTS  
 (71) MP Lumber d.o.o., Drage Ivanisevica 10b, 10000 Zagreb, HR  
 Doctors & Co. d.o.o., Andrije Kacica Miosica 19, 43000 Bjelovar, HR  
 (72) KODVANJ, Janos, Marice Baric 17, 10000 Zagreb, HR  
 CURIC, Stjepan, Antuna Gustava Matosa 3, 32214 Tordinci, HR

---

(51) MKP  
**A01H 1/04 2006 (97) EP 3784030**  
**C12N 9/14 2006**  
**C12N 15/82 2006**  
**C12Q 1/68 2018**  
 (96) EP 19719505.0 4/24/2019  
 (97) EP 3784030, 3/3/2021 202109, en  
 (31) 18169122 (32) 24.04.2018 (33) EP  
 (54) PLANTS WITH IMPROVED DIGESTIBILITY AND MARKER HAPLOTYPES  
 (71) KWS SAAT SE & Co. KGaA, Grimsehlstraße 31, 37574 Einbeck, DE  
 (72) KLOIBER-MAITZ, Monika, Im Pohlschen Bock 2, 37574 Einbeck, DE  
 BOLDUAN, Therese, An der Opperworth 1, 37574 Einbeck, DE  
 OUZUNOVA, Milena, Max-Born-Ring 2c, 37077 Göttingen, DE  
 MEYER, Nina, Schrammstraße 9, 37574 Einbeck, DE  
 LOPEZ-DURAN, Carolina, Negenborner Weg 55, 37574 Einbeck, DE

---

(51) MKP  
**G10L 19/02 2013 (97) EP 3785260**  
**G10L 19/24 2013**  
**G10L 21/0388 2013**  
 (96) EP 19719519.1 4/25/2019  
 (97) EP 3785260, 3/3/2021 202109, en  
 (31) 18169156 (32) 25.04.2018 (33) EP  
 (54) INTEGRATION OF HIGH FREQUENCY AUDIO RECONSTRUCTION TECHNIQUES  
 (72) KJOERLING, Kristofer, c/o Dolby Sweden AB Gävlegatan 12A, 113 30 Stockholm, SE  
 VILLEMoes, Lars, c/o Dolby Sweden AB Gävlegatan 12A, 113 30 Stockholm, SE  
 PURNHAGEN, Heiko, c/o Dolby Sweden AB Gävlegatan 12A, 113 30 Stockholm, SE  
 EKSTRAND, Per, c/o Dolby Sweden AB Gävlegatan 12 A, 113 30 Stockholm, SE

---

(51) MKP  
**A61K 38/18 2006 (97) EP 3784691**  
**C07K 14/48 2006**  
 (96) EP 19719523.3 4/26/2019  
 (97) EP 3784691, 3/3/2021 202109, en  
 (31) 18169859 (32) 27.04.2018 (33) EP  
 (54) PRODUCTION OF NERVE GROWTH FACTOR (NGF) AND OF MUTEINS THEREOF  
 (72) IMBIMBO, Bruno Pietro, c/o Chiesi Farmaceutici SpA Via Palermo 26/A, 43122 Parma, IT

---

(51) MKP

- A61P 25/16 2006 (97) EP 3781560**  
**A61P 25/28 2006**  
**C07D 401/04 2006**  
**C07D 405/14 2006**
- (96) EP 19720352.4 4/17/2019  
(97) EP 3781560, 2/24/2021 202108, en  
(31) 201862660622 P (32) 20.04.2018 (33) US  
(54) PYRAZO-TETRAHYDROISOQUINOLINE DERIVATIVES AS DOPAMINE D1 RECEPTOR POSITIVE MODULATORS  
(72) COATES, David Andrew, c/o ELI LILLY AND COMPANY P.O. Box 6288, Indianapolis, Indiana 46206-6288, US  
HAO, Junliang, c/o ELI LILLY AND COMPANY P.O. Box 6288, Indianapolis, Indiana 46206-6288, US  
HILLIARD, Darryl Wayne, c/o ELI LILLY AND COMPANY P.O. Box 6288, Indianapolis, Indiana 46206-6288, US
- 
- (51) MKP  
**A61K 9/00 2006 (97) EP 3784212**  
**A61P 11/06 2006**
- (96) EP 19720469.6 4/16/2019  
(97) EP 3784212, 3/3/2021 202109, en  
(31) 201862661245 P (32) 23.04.2018 (33) US  
201862751830 P 29.10.2018 US  
(54) A THERAPEUTIC COMBINATION COMPRISING A PULMONARY SURFACTANT AND A STEROID FOR THE PROPHYLAXIS OF BPD  
(71) Children's Hospital Medical Center, 3333 Burnet Avenue, Cincinnati, Ohio 45229-3029, US  
(72) JOBE, Alan, c/o CHIESI FARMACEUTICI S.p.A. Via Palermo, 26/A, 43122 PARMA, IT  
SCHMIDT, Augusto Santos, c/o CHIESI FARMACEUTICI S.p.A. Via Palermo, 26/A, PARMA 43122, IT  
HILLMAN, Noah, c/o CHIESI FARMACEUTICI S.p.A. Via Palermo, 26/A, 43122 PARMA, IT  
KEMP, Matthew, c/o CHIESI FARMACEUTICI S.p.A. Via Palermo, 26/A, 43122 PARMA, IT
- 
- (51) MKP  
**A61M 5/315 2006 (97) EP 3765131**
- (96) EP 19721023.0 3/13/2019  
(97) EP 3765131, 1/20/2021 202103, en  
(31) PCT/IB2018/000426 (32) 14.03.2018 (33) WO  
(54) DOSE CONTROL DEVICE FOR INJECTABLE-DRUG DELIVERY DEVICES  
(72) MARCOZ, Alain, Espinasse Haut, 63160 Montmorin, FR  
PEREIRA, Alexandre, 14 rue Saint Exupéry, 63170 Perignat-les-Sarlieve, FR  
POLLARD, Mathieu, 3 allée des Coches d'Eau, 63430 Pont du Chateau, FR
- 
- (51) MKP  
**B65D 81/38 2006 (97) EP 3765381**
- (96) EP 19721129.5 4/3/2019  
(97) EP 3765381, 1/20/2021 202103, en  
(31) 201800004924 (32) 27.04.2018 (33) IT  
(54) THERMAL CONTAINER  
(71) Cartotecnica G. Arici S.r.l., Via Enrico Mattei 21, 25060 Collebeato (BS), IT  
(72) CORSINI, Massimo, c/o CARTOTECNICA G. ARICI S.R.L. Via Enrico Mattei 21, 25060 Collebeato (BS), IT
- 
- (51) MKP  
**A61K 31/454 2006 (97) EP 3790873**  
**A61K 31/4545 2006**  
**A61P 3/00 2006**  
**A61P 25/00 2006**  
**A61P 29/00 2006**  
**A61P 35/00 2006**  
**C07D 405/12 2006**  
**C07D 405/14 2006**  
**C07D 409/12 2006**  
**C07D 409/14 2006**
- (96) EP 19721295.4 5/6/2019  
(97) EP 3790873, 3/17/2021 202111, en  
(31) 18171084 (32) 07.05.2018 (33) EP  
(54) 1H-INDAZOLE-3-CARBOXAMIDE COMPOUNDS AS GLYCOGEN SYNTHASE KINASE 3 BETA INHIBITORS  
(72) FURLOTTI, Guido, Via Ferdinando Palasciano, 96, 00151 Roma, IT  
CAVARISCHIA, Claudia, Via Livorno, 36, 00162 Roma, IT

BUONFIGLIO, Rosa, Via Pasubio, 24, 40131 Bologna, IT  
 OMBRATO, Rosella, Via Abigaille Zanetta, 68, 00143 Roma, IT  
 IACOANGELI, Tommaso, Via Baldassarre Orero, 54, 00159 Roma, IT

(51) MKP  
**C12N 5/079 2010 (97) EP 3781674**

(96) EP 19721476.0 4/16/2019  
 (97) EP 3781674, 2/24/2021 202108, en

(31) 201862658901 P (32) 17.04.2018 (33) US  
 201862700472 P 19.07.2018 US

(54) INDUCTION OF MYELINATING OLIGODENDROCYTES IN HUMAN CORTICAL SPHEROIDS  
 (71) Case Western Reserve University, 10900 Euclid Avenue, Cleveland, OH 44106, US  
 (72) TESAR, Paul, 30386 Bridle Path Trail, Wickliffe, OH 44092, US  
 MADHAVAN, Mayur, 26551 Bernwood Road, Beachwood, OH 44122, US  
 NEVIN, Zachary, 2578 Kingston Road, Cleveland Heights, OH 44118, US

(51) MKP  
**A61K 9/28 2006 (97) EP 3787605**  
**A61K 9/50 2006**  
**A61K 31/00 2006**

(96) EP 19721627.8 5/6/2019  
 (97) EP 3787605, 3/10/2021 202110, en

(31) 18170938 (32) 04.05.2018 (33) EP

(54) STABLE PHARMACEUTICAL FORMULATION  
 (71) Oryzon Genomics, S.A., Carrera de San Jerónimo 15, 2nd Floor, 28014 Madrid, ES  
 (72) MAURER, Reto, c/o Oryzon Genomics SA Sant Ferran 74, 08940 Cornellà de Llobregat, Barcelona, ES  
 BUSSON, Patrick, c/o Oryzon Genomics SA Sant Ferran 74, 08940 Cornellà de Llobregat, Barcelona, ES  
 HUMMEL, Georg, c/o Oryzon Genomics SA Sant Ferran 74, 08940 Cornellà de Llobregat, Barcelona, ES

(51) MKP  
**A61P 35/00 2006 (97) EP 3781265**  
**C07K 16/28 2006**

(96) EP 19722361.3 4/17/2019  
 (97) EP 3781265, 2/24/2021 202108, en

(31) 201862658899 P (32) 17.04.2018 (33) US  
 201962826091 P 29.03.2019 US

(54) ANTI-CD27 AND ANTI-PD-L1 ANTIBODIES AND BISPECIFIC CONSTRUCTS  
 (71) Celldex Therapeutics, Inc., 53 Frontage Road, Suite 220, Hampton, NJ 08827, US  
 (72) KELER, Tibor, 53 Frontage Road, Suite 220, Hampton, NJ 08827, US  
 GOLDSTEIN, Joel, 53 Frontage Road, Suite 220, Hampton, NJ 08827, US  
 VITALE, Laura A., 53 Frontage Road, Suite 220, Hampton, NJ 08827, US  
 HE, Lizhen, 53 Frontage Road, Suite 220, Hampton, NJ 08827, US

(51) MKP  
**A61K 31/44 2006 (97) EP 3781561**  
**A61P 35/00 2006**  
**C07D 405/12 2006**  
**C07D 405/14 2006**

(96) EP 19722363.9 4/17/2019  
 (97) EP 3781561, 2/24/2021 202108, en

(31) 201862659408 P (32) 18.04.2018 (33) US

(54) MODULATORS OF METHYL MODIFYING ENZYMES, COMPOSITIONS AND USES THEREOF  
 (72) CÔTÉ, Alexandre, 399 Broadway Street Apt. 11, Cambridge, MA 02139, US  
 GEHLING, Victor, S., 10 Ware Street Rear Unit, Somerville, MA 02144, US  
 KHANNA, Avinash, 63 Hurley Street Apt. 1L, Cambridge, MA 02141, US  
 MOINE, Ludivine, 15 York Place 4, Cambridge, MA 02141, US  
 STUCKEY, Jacob, I., 2 Claudette Circle, Framingham, MA 01701, US

(51) MKP

**C07K 14/195 2006 (97) EP 3781692**  
**C07K 14/325 2006**  
**C12N 15/82 2006**  
 (96) EP 19722384.5 4/18/2019  
 (97) EP 3781692, 2/24/2021 202108, en  
 (31) 201862660502 P (32) 20.04.2018 (33) US  
 201862774515 P 03.12.2018 US  
 (54) PESTICIDAL PROTEINS AND METHODS OF USE  
 (71) Agbiome, Inc., P.O. Box 14069, Durham NC 27709, US  
 (72) PARKS, Jessica, 115 Little Gem Lane, Apex, North Carolina 27560, US  
 ROBERTS, Kira Bulazel, 1357 John Jones Road, Bahama, North Carolina 27503, US  
 THAYER, Rebecca E., 100 Hammond Wood Place, Morrisville, North Carolina 27560, US

---

(51) MKP  
**A61K 38/17 2006 (97) EP 3781596**  
**A61K 38/20 2006**  
**A61P 35/00 2006**  
**C07K 14/54 2006**  
**C07K 14/715 2006**  
**C07K 16/28 2006**  
 (96) EP 19722385.2 4/18/2019  
 (97) EP 3781596, 2/24/2021 202108, en  
 (31) 201862659563 P (32) 18.04.2018 (33) US  
 201862684143 P 12.06.2018 US  
 201862724396 P 29.08.2018 US  
 201862756800 P 07.11.2018 US  
 (54) IL-15/IL-15RA HETERODIMERIC FC FUSION PROTEINS AND USES THEREOF  
 (72) BERNETT, Matthew, c/o Xencor, Inc 111 West Lemon Avenue, Monrovia, CA 91016, US  
 DESJARLAIS, John, c/o Xencor, Inc 111 West Lemon Avenue, Monrovia, CA 91016, US  
 RASHID, Rumana, c/o Xencor, Inc 111 West Lemon Avenue, Monrovia, CA 91016, US  
 VARMA, Rajat, c/o Xencor, Inc 111 West Lemon Avenue, Monrovia, CA 91016, US  
 BONZON, Christine, c/o Xencor, Inc 111 West Lemon Avenue, Monrovia, CA 91016, US

---

(51) MKP  
**A61K 35/17 2015 (97) EP 3784254**  
**C12N 5/09 2010**  
**C12N 15/90 2006**  
 (96) EP 19722433.0 4/26/2019  
 (97) EP 3784254, 3/3/2021 202109, en  
 (31) 201862663885 P (32) 27.04.2018 (33) US  
 201862680821 P 05.06.2018 US  
 (54) CLOSED PROCESS FOR EXPANSION AND GENE EDITING OF TUMOR INFILTRATING LYMPHOCYTES AND USES OF SAME IN IMMUNOTHERAPY  
 (72) CHARTIER-COURTAUD, Cecile, 1357 Cowper Street, Palo Alto, CA 94301, US  
 RITTHIPICHAJ, Krit, 14605 N. 42nd Street, Apt. 60, Tampa, FL 33613, US

---

(51) MKP  
**A61K 38/46 2006 (97) EP 3784272**  
**A61K 39/00 2006**  
**A61K 48/00 2006**  
**A61P 35/00 2006**  
**C07K 14/725 2006**  
**C07K 16/28 2006**  
**C12N 5/0783 2010**  
**C12N 9/22 2006**  
**C12N 15/90 2006**  
 (96) EP 19722478.5 4/26/2019  
 (97) EP 3784272, 3/3/2021 202109, en  
 (31) 201862663974 P (32) 27.04.2018 (33) US  
 201862773058 P 29.11.2018 US  
 (54) ANTI-BCMA CAR-T-CELLS FOR PLASMA CELL DEPLETION  
 (72) COST, Gregory, c/o Casebia Therapeutics Limited Liability Partnership 455 Mission Bay Boulevard South, San Francisco, CA 94158, US

---

- (51) MKP  
**A61K 31/438 2006 (97) EP 3788043**  
**A61K 31/439 2006**  
**A61K 31/444 2006**  
**A61K 31/501 2006**  
**A61K 31/506 2006**  
**A61P 25/00 2006**  
**C07D 401/04 2006**  
**C07D 413/04 2006**  
**C07D 413/14 2006**  
**C07D 417/04 2006**  
**C07D 417/14 2006**  
**C07D 471/04 2006**  
**C07D 471/08 2006**  
**C07D 487/04 2006**  
**C07D 513/04 2006**
- (96) EP 19722488.4 4/29/2019  
(97) EP 3788043, 3/10/2021 202110, en
- (31) 201862665091 P (32) 01.05.2018 (33) US
- (54) SPIROPIPERIDINE ALLOSTERIC MODULATORS OF NICOTINIC ACETYLCHOLINE RECEPTORS  
(72) CROWLEY, Brendan, M., 770 Sumneytown Pike, West Point, Pennsylvania 19486, US  
CAMPBELL, Brian, T., 770 Sumneytown Pike, West Point, Pennsylvania 19486, US  
CHOBANIAN, Harry, R., 2000 Galloping Hill Road, Kenilworth, New Jersey 07033, US  
FELLS, James, I., 770 Sumneytown Pike, West Point, Pennsylvania 19486, US  
GUIADEEN, Deodial, G., 2000 Galloping Hill Road, Kenilworth, New Jersey 07033, US  
GRESHOCK, Thomas, J., 650 Gateway Boulevard, South San Francisco, California 94080, US  
LEAVITT, Kenneth, J., 127 Union Mill Terrace, Mount Laurel, New Jersey 08054, US  
RADA, Vanessa, L., 770 Sumneytown Pike, West Point, Pennsylvania 19486, US  
BELL, Ian, M., 770 Sumneytown Pike, West Point, Pennsylvania 19486, US
- 

- (51) MKP  
**A61K 9/00 2006 (97) EP 3781126**  
**A61K 9/14 2006**  
**A61K 31/198 2006**  
**A61K 47/26 2006**
- (96) EP 19722514.7 4/10/2019  
(97) EP 3781126, 2/24/2021 202108, en
- (31) 18167617 (32) 16.04.2018 (33) EP  
19386017 22.03.2019 EP
- (54) A PHARMACEUTICAL DRY POWDER COMPOSITION FOR INHALATION COMPRISING A THYROID HORMONE  
(71) Tseti, Ioulia, 13 Pavlou Mela Street, 145 61 Kifissia Attikis, GR  
(72) Tseti, Ioulia, 13 Pavlou Mela Street, 145 61 Kifissia Attikis, GR
- 

- (51) MKP  
**A61K 31/55 2006 (97) EP 3781170**  
**A61K 31/565 2006**  
**A61K 31/57 2006**  
**A61K 31/585 2006**  
**A61P 5/30 2006**
- (96) EP 19722528.7 4/19/2019  
(97) EP 3781170, 2/24/2021 202108, en
- (31) 18168336 (32) 19.04.2018 (33) EP  
18174982 30.05.2018 EP  
19150423 04.01.2019 EP
- (54) COMPOUNDS AND THEIR USES FOR ALLEVIATING MENOPAUSE-ASSOCIATED SYMPTOMS  
(72) TAZIAUX, Melanie, Rue Saint-Georges, 5, 4000 Liège, BE  
RAUSIN, Glwadys, Rue Saint-Georges, 5, 4000 Liège, BE  
JOST, Maud, Rue Saint-Georges, 5, 4000 Liège, BE  
MAWET, Marie, Rue Saint-Georges, 5, 4000 Liège, BE
- 

- (51) MKP  
**A61K 31/55 2006 (97) EP 3781171**  
**A61K 31/565 2006**  
**A61K 31/57 2006**

	<b>A61K 31/585</b>	<b>2006</b>				
	<b>A61P 5/30</b>	<b>2006</b>				
(96)	EP 19722529.5 4/19/2019					
(97)	EP 3781171, 2/24/2021 202108, en					
(31)	18168234		(32)	19.04.2018	(33)	EP
	18174985			30.05.2018		EP
	19150421			04.01.2019		EP
(54)	COMPOUNDS AND THEIR USES FOR ALLEVIATING MENOPAUSE-ASSOCIATED SYMPTOMS					
(72)	TAZIAUX, Melanie, Rue Saint-Georges, 5, 4000 Liège, BE					
	RAUSIN, Glwadys, Rue Saint-Georges, 5, 4000 Liège, BE					
	JOST, Maud, Rue Saint-Georges, 5, 4000 Liège, BE					
	MAWET, Marie, Rue Saint-Georges, 5, 4000 Liège, BE					

---

(51)	MKP					
	<b>H01L 31/0224</b>	<b>2006</b>	<b>(97) EP 3790060</b>			
	<b>H01L 31/042</b>	<b>2014</b>				
	<b>H01L 31/05</b>	<b>2014</b>				
	<b>H01L 31/068</b>	<b>2012</b>				
(96)	EP 19883328.7 8/23/2019					
(97)	EP 3790060, 3/10/2021 202110, en					
(31)	201910454083		(32)	28.05.2019	(33)	CN
	201920785516 U			28.05.2019		CN
(54)	PHOTOVOLTAIC CELL ARRAY AND PHOTOVOLTAIC ASSEMBLY					
(71)	Zhejiang Jinko Solar Co., Ltd., No. 58, Yuan Xi Road Technical Functional Zone Yuan Hua Town, Haining, Zhejiang 314416, CN					
(72)	WANG, Juan, No. 58 Yuan Xi Road Technical Functional Zone Yuan Hua Town Haining, Zhejiang 314416, CN					
	GUO, Zhiqiu, No. 58 Yuan Xi Road Technical Functional Zone Yuan Hua Town Haining, Zhejiang 314416, CN					
	SUN, Changzhen, No. 58 Yuan Xi Road Technical Functional Zone Yuan Hua Town Haining, Zhejiang 314416, CN					
	JIN, Hao, No. 58 Yuan Xi Road Technical Functional Zone Yuan Hua Town Haining, Zhejiang 314416, CN					

---

(51)	MKP					
	<b>A61M 5/168</b>	<b>2006</b>	<b>(97) EP 3695864</b>			
	<b>A61M 5/20</b>	<b>2006</b>				
	<b>A61M 5/315</b>	<b>2006</b>				
	<b>A61M 5/32</b>	<b>2006</b>				
	<b>A61M 5/42</b>	<b>2006</b>				
	<b>A61M 5/48</b>	<b>2006</b>				
	<b>A61M 5/50</b>	<b>2006</b>				
(96)	EP 20150601.1 3/10/2014					
(97)	EP 3695864, 3/31/2021 202113, en					
(31)	201313833978		(32)	15.03.2013	(33)	US
(54)	PALM ACTIVATED DRUG DELIVERY DEVICE					
(72)	OLSON, Lorin, 1230 Mount Herman Road, Scotts Valley, CA 95066, US					
	VOJAN, Vaclav, Sokolovska 137, 322300 Plzen, CZ					
	PFRANG, Juergen E., Josef-Miller Str. 7, 93183 Kallmuenz, DE					
	KRULEVITCH, Peter, 1122 Division Street, Pleasanton, CA 94566, US					
	WANG, Jingli, 6102 Rainbow Drive, San Jose, CA 95129, US					
	FOLEY, Nicholas, 6 Afton Place, Edinburgh, EH5 3RB, GB					
	ZHAO, Mingqi, 1304 Payette Court, San Jose, CA 95129, US					
	TASHJIAN, Paul, 1396 Nathan Hale Drive, Phoenixville, PA 19460, US					

---

(51)	MKP					
	<b>A61K 39/00</b>	<b>2006</b>	<b>(97) EP 3689911</b>			
	<b>A61K 39/395</b>	<b>2006</b>				
	<b>A61P 1/04</b>	<b>2006</b>				
	<b>A61P 1/16</b>	<b>2006</b>				
	<b>A61P 1/18</b>	<b>2006</b>				
	<b>A61P 11/00</b>	<b>2006</b>				
	<b>A61P 13/10</b>	<b>2006</b>				
	<b>A61P 13/12</b>	<b>2006</b>				
	<b>A61P 15/00</b>	<b>2006</b>				
	<b>A61P 17/00</b>	<b>2006</b>				
	<b>A61P 21/00</b>	<b>2006</b>				
	<b>A61P 25/00</b>	<b>2006</b>				
	<b>A61P 35/00</b>	<b>2006</b>				

	<b>A61P 35/04</b>	<b>2006</b>					
	<b>C07K 14/705</b>	<b>2006</b>					
	<b>C07K 16/28</b>	<b>2006</b>					
	<b>C07K 16/30</b>	<b>2006</b>					
(96)	EP 20151560.8 11/11/2010						
(97)	EP 3689911, 3/10/2021 202110, en						
(31)	09014136		(32)	11.11.2009	(33)		EP
	26020209 P			11.11.2009			US
	10006956			06.07.2010			EP
	36161810 P			06.07.2010			US
(54)	ANTIBODIES SPECIFIC FOR CLAUDIN 6 (CLDN6)						
(72)	SAHIN, Ugur, Philipp-von-Zabern-Platz 1, 55116 Mainz, DE						
	TÜRECI, Özlem, Philipp-von-Zabern-Platz 1, 55116 Mainz, DE						
	KOSLOWSKI, Michael, Am Ried 23, 85764 Oberschleissheim, DE						
	WALTER, Korden, Hüglerstrasse 3, 65203 Wiesbaden, DE						
	WÖLL, Stefan, Pommardstrasse 22a, 55299 Nackenheim, DE						
	KREUZBERG, Maria, Freiherr-vom-Stein-Strasse 1, 55131 Mainz, DE						
	HUBNER, Bernd, Thelottstrasse 14, 80933 München, DE						
	ERDELJAN, Michael, Freiherr-vom-Stein-Strasse 11, 55131 Mainz, DE						
<hr/>							
(51)	MKP						
	<b>A61P 37/06</b>	<b>2006</b>	(97)	<b>EP 3693393</b>			
	<b>C07K 16/28</b>	<b>2006</b>					
(96)	EP 20151834.7 9/16/2016						
(97)	EP 3693393, 3/24/2021 202112, en						
(31)	201562220442 P		(32)	18.09.2015	(33)		US
(54)	ANTIBODIES THAT SPECIFICALLY BIND TO TL1A						
(72)	POULTON, Lynn, Dorothy, Level 2 37 Epping Road, Macquarie Park, New South Wales 2113, AU						
	POLLARD, Matthew, 60 Summerland Place, Pullenvale, Queensland 4069, AU						
	DOYLE, Anthony, G., Level 2 37 Epping Road, Macquarie Park, New South Wales 2113, AU						
	COOKSEY, Bridget, Ann, Level 2 37 Epping Road, Macquarie Park, New South Wales 2113, AU						
	PANDE, Vanya, Level 2 37 Epping Road, Macquarie Park, New South Wales 2113, AU						
	CLARKE, Adam, William, Level 2 37 Epping Road, Macquarie Park, New South Wales 2113, AU						
<hr/>							
(51)	MKP						
	<b>A61K 31/506</b>	<b>2006</b>	(97)	<b>EP 3698795</b>			
	<b>A61K 31/519</b>	<b>2006</b>					
	<b>A61P 21/00</b>	<b>2006</b>					
	<b>A61P 21/04</b>	<b>2006</b>					
	<b>A61P 25/02</b>	<b>2006</b>					
	<b>C07D 239/42</b>	<b>2006</b>					
	<b>C07D 239/48</b>	<b>2006</b>					
	<b>C07D 401/04</b>	<b>2006</b>					
	<b>C07D 401/12</b>	<b>2006</b>					
	<b>C07D 401/14</b>	<b>2006</b>					
	<b>C07D 403/04</b>	<b>2006</b>					
	<b>C07D 403/10</b>	<b>2006</b>					
	<b>C07D 403/14</b>	<b>2006</b>					
	<b>C07D 413/14</b>	<b>2006</b>					
	<b>C07D 417/14</b>	<b>2006</b>					
	<b>C07D 471/04</b>	<b>2006</b>					
(96)	EP 20153402.1 4/22/2011						
(97)	EP 3698795, 4/7/2021 202114, en						
(31)	32759710 P		(32)	23.04.2010	(33)		US
	41229910 P			10.11.2010			US
(54)	CERTAIN AMINO-PYRIMIDINES, COMPOSITIONS THEREOF, AND METHODS FOR THEIR USE						
(72)	WARRINGTON, Jeffrey, 1936 Playa Street, San Mateo, CA 94403, US						
	ROMERO, Antonio, 1309 Newbridge Avenue, San Mateo, CA 94401, US						
	YANG, Zhe, c/o Cytokinetics, Inc. 280 East Grand Avenue, South San Francisco, CA 94080, US						
	MUCI, Alex R., c/o Cytokinetics, Inc. 280 East Grand Avenue, South San Francisco, CA 94080, US						
	BERGNES, Gustave, c/o Cytokinetics, Inc. 280 East Grand Avenue, South San Francisco, CA 94080, US						
	MORGAN, Bradley P., c/o Cytokinetics, Inc. 280 East Grand Avenue, South San Francisco, CA 94080, US						
	CHUANG, Chihyuan, c/o Cytokinetics, Inc. 280 East Grand Avenue, South San Francisco, CA 94080, US						
	COLLIBLEE, Scott, c/o Cytokinetics, Inc. 280 East Grand Avenue, South San Francisco, CA 94080, US						



QIAN, Xiangping, c/o Cytokinetics, Inc. 280 East Grand Avenue, South San Francisco, CA 94080, US  
 LU, Pu-Ping, c/o Cytokinetics, Inc. 280 East Grand Avenue, South San Francisco, CA 94080, US

- (51) MKP  
**A61K 31/202 2006 (97) EP 3692986**
- (96) EP 20153902.0 6/4/2015  
 (97) EP 3692986, 3/24/2021 202112, en
- (31) 201462007752 P (32) 04.06.2014 (33) US  
 201462058469 P 01.10.2014 US
- (54) PHARMACEUTICAL COMPOSITIONS COMPRISING DGLA AND USE OF SAME  
 (72) MANKU, Mehar, 21 Bollywood Drive West Midlands, Birmingham, B47 5PS, GB  
 COUGHLAN, David, c/o Trintech Building South County Business Park Leopardstown, Dublin, Dublin 18, IE  
 CLIMAX, John, c/o Trintech Building South County Business Park Leopardstown, Dublin, Dublin 18, IE  
 DUNNE, James, c/o Trintech Building South County Business Park Leopardstown, Dublin, Dublin 18, IE

- (51) MKP  
**B01J 31/02 2006 (97) EP 3680240**  
**C07D 453/04 2006**
- (96) EP 20154142.2 3/13/2013  
 (97) EP 3680240, 2/24/2021 202108, en
- (31) 201261610746 P (32) 14.03.2012 (33) US
- (54) ASYMMETRIC PHASE TRANSFER CATALYSIS  
 (72) Xiang, Bangping, 126 East Lincoln Avenue, Rahway, New Jersey 07065-0907, US  
 Yasuda, Nobuyoshi, 126 East Lincoln Avenue, Rahway, New Jersey 07065-0907, US

- (51) MKP  
**C12Q 1/6886 2018 (97) EP 3693476**
- (96) EP 20154250.3 2/22/2013  
 (97) EP 3693476, 3/24/2021 202112, en
- (31) 201261604290 P (32) 28.02.2012 (33) US
- (54) CANCER PATIENT SELECTION FOR ADMINISTRATION OF WNT SIGNALING INHIBITORS USING RNF43 MUTATION STATUS  
 (72) CONG, Feng, Novartis Institutes for BioMedical Research, Inc. 250 Massachusetts Avenue, Cambridge, MA 02139, US  
 HAO, Huaixiang, Novartis Institutes for BioMedical Research, Inc. 250 Massachusetts Avenue, Cambridge, MA 02139, US  
 HSIEH, Hsin-i, Genomics Institute of the Novartis Research Foundation 10675 John Jay Hopkins Drive, San Diego, CA 92121, US  
 LIU, Jun, Genomics Institute of the Novartis Research Foundation 10675 John Jay Hopkins Drive, San Diego, CA 92121, US  
 NG, Nicholas, Genomics Institute of the Novartis Research Foundation 10675 John Jay Hopkins Drive, San Diego, CA 92121, US  
 JIANG, Xiaomo, Novartis Institutes for BioMedical Research, Inc. 250 Massachusetts Avenue, Cambridge, MA 02139, US

- (51) MKP  
**G01N 21/03 2006 (97) EP 3690511**  
**G01N 21/25 2006**  
**G01N 21/64 2006**  
**G01N 21/76 2006**  
**G02B 21/00 2006**
- (96) EP 20154680.1 1/30/2020  
 (97) EP 3690511, 3/17/2021 202111, en
- (31) 201962800372 P (32) 01.02.2019 (33) US  
 201962801025 P 04.02.2019 US
- (54) MICROSCOPE FOR IMAGING WELLS COMPRISING A DISPENSER AND TEMPERATURE-CONTROLLED ENCLOSURE  
 (72) SARICH, Brandon Zachary, c/o Amgen Inc. One Amgen Center Drive Mail Stop 28-5-A, Thousand Oaks, CA California 91320-1799, US  
 BERKE, Michael R., c/o Amgen Inc. One Amgen Center Drive Mail Stop 28-5-A, Thousand Oaks, CA California 91320-1799, US  
 LI, Chuck Z., c/o Amgen Inc. One Amgen Center Drive Mail Stop 28-5-A, Thousand Oaks, CA California 91320-1799, US  
 PEARSON, Thomas Clark, c/o Amgen Inc. One Amgen Center Drive Mail Stop 28-5-A, Thousand Oaks, CA California 91320-1799, US

- (51) MKP  
**A61K 31/513 2006 (97) EP 3702352**  
**A61P 9/00 2006**  
**A61P 9/04 2006**  
**A61P 9/10 2006**  
**A61P 9/12 2006**  
**C07D 239/545 2006**

- (96) EP 20155100.9 6/19/2014  
 (97) EP 3702352, 4/7/2021 202114, en
- |      |                |      |            |      |    |
|------|----------------|------|------------|------|----|
| (31) | 201361838088 P | (32) | 21.06.2013 | (33) | US |
|      | 201461939655 P |      | 13.02.2014 |      | US |
|      | 201461981366 P |      | 18.04.2014 |      | US |
- (54) PYRIMIDINEDIONE COMPOUND AGAINST CARDIAC CONDITIONS  
 (72) OSLOB, Johan, c/o MyoKardia, Inc. 333 Allerton Avenue, South San Francisco, CA 94080, US  
 ANDERSON, Robert, c/o MyoKardia, Inc. 333 Allerton Avenue, South San Francisco, CA 94080, US  
 AUBELE, Danielle, c/o MyoKardia, Inc. 333 Allerton Avenue, South San Francisco, CA 94080, US  
 EVANCHIK, Marc, c/o MyoKardia, Inc. 333 Allerton Avenue, South San Francisco, CA 94080, US  
 FOX, Jonathan Charles, c/o MyoKardia, Inc. 333 Allerton Avenue, South San Francisco, CA 94080, US  
 KANE, Brian, c/o MyoKardia, Inc. 333 Allerton Avenue, South San Francisco, CA 94080, US  
 LU, Puping, c/o MyoKardia, Inc. 333 Allerton Avenue, South San Francisco, CA 94080, US  
 MCDOWELL, Robert, c/o MyoKardia, Inc. 333 Allerton Avenue, South San Francisco, CA 94080, US  
 RODRIGUEZ, Hector, c/o MyoKardia, Inc. 333 Allerton Avenue, South San Francisco, CA 94080, US  
 SONG, Yonghong, c/o MyoKardia, Inc. 333 Allerton Avenue, South San Francisco, CA 94080, US  
 SRAN, Arvinder, c/o MyoKardia, Inc. 333 Allerton Avenue, South San Francisco, CA 94080, US
- 

- (51) MKP  
**A61K 31/4745 2006 (97) EP 3683220**  
**A61P 25/28 2006**  
**A61P 35/00 2006**  
**C07D 471/04 2006**
- (96) EP 20156172.7 9/15/2016  
 (97) EP 3683220, 3/3/2021 202109, en
- |      |           |      |            |      |    |
|------|-----------|------|------------|------|----|
| (31) | 201516504 | (32) | 17.09.2015 | (33) | GB |
|------|-----------|------|------------|------|----|
- (54) 8-[6-[3-(AMINO)PROPOXY]-3-PYRIDYL]-1-ISOPROPYL-IMIDAZO[4,5-C]QUINOLIN-2-ONE DERIVATIVES AS SELECTIVE MODULATORS OF ATAXIA TELANGIECTASIA MUTATED (ATM) KINASE FOR THE TREATMENT OF HUNTINGTON'S DISEASE  
 (72) PIKE, Kurt, Gordon, AstraZeneca Darwin Building Cambridge Science Park Milton Road, Cambridge CB4 0WG, GB  
 BARLAAM, Bernard Christophe, AstraZeneca Darwin Building Cambridge Science Park Milton Road, Cambridge Cambridgeshire CB4 0WG, GB  
 HUNT, Thomas Anthony, AstraZeneca Darwin Building Cambridge Science Park Milton Road, Cambridge Cambridgeshire CB4 0WG, GB  
 EATHERTON, Andrew John, AstraZeneca Hodgkin Building Chesterford Research Park, Little Chesterford Essex CB10 1XL, GB
- 

- (51) MKP  
**A61K 31/4355 2006 (97) EP 3670506**  
**A61K 31/4365 2006**  
**A61K 31/4427 2006**  
**A61K 31/4709 2006**  
**A61K 31/497 2006**  
**A61P 35/00 2006**  
**C07D 401/14 2006**  
**C07D 417/14 2006**  
**C07D 471/04 2006**  
**C07D 491/048 2006**  
**C07D 495/04 2006**
- (96) EP 20156411.9 1/14/2014  
 (97) EP 3670506, 1/13/2021 202102, en
- |      |                |      |            |      |    |
|------|----------------|------|------------|------|----|
| (31) | 201361752897 P | (32) | 15.01.2013 | (33) | US |
|      | 201361790952 P |      | 15.03.2013 |      | US |
|      | 201361859118 P |      | 26.07.2013 |      | US |
- (54) THIAZOLECARBOXAMIDES AND PYRIDINECARBOXAMIDE COMPOUNDS USEFUL AS PIM KINASE INHIBITORS  
 (72) XUE, Chu-Biao, 307 Wellspring Court, Hockessin, DE Delaware 19707, US  
 LI, Yun-Long, 1 Pin Oak Drive, Chadds Ford, PA Pennsylvania 19317, US  
 FENG, Hao, 600 Christopher Lane, Aston, PA Pennsylvania 19014, US  
 PAN, Jun, 1295 N. Providence Road A-101, Media, PA Pennsylvania 19063, US  
 WANG, Anlai, 102 Bunting Drive, Wilmington, DE Delaware 19808, US  
 ZHANG, Ke, 45 Hayloft Circle, Wilmington, DE Delaware 19808, US  
 YAO, Wenqing, 45 Magnolia Way, Chadds Ford, PA Pennsylvania 19317, US  
 ZHANG, Fenglei, 309 Daniel Drive, Ambler, PA Pennsylvania 19002, US  
 ZHUO, Jincong, 17 Forwood Drive, Garnet Valley, PA Pennsylvania 19060, US
- 

- (51) MKP  
**A61K 31/437 2006 (97) EP 3674302**  
**A61P 9/10 2006**

**A61P 11/06 2006**  
**A61P 25/24 2006**  
**A61P 25/28 2006**  
**A61P 31/00 2006**  
**A61P 33/00 2006**  
**A61P 35/00 2006**  
**A61P 37/00 2006**  
**C07D 471/04 2006**

(96) EP 20156599.1 4/22/2015

(97) EP 3674302, 1/27/2021 202104, en

(31) 201461983289 P (32) 23.04.2014 (33) US

(54) 1H-PYRROLO[2,3-C]PYRIDIN-7(6H)-ONES AND PYRAZOLO[3,4-C]PYRIDIN-7(6H)-ONES AS INHIBITORS OF BET PROTEINS

(72) COMBS, Andrew, P., 329 East Doe Run Road, Kennett Square, PA Pennsylvania 19348, US

MADUSKUJE, Thomas, P., Jr., c/o Incyte Corporation 1801 Augustine Cut-Off, Wilmington, Delaware 19803, US

FALAHATPISHEH, Nikoo, 1822 Foulk Road, Wilmington, DE Delaware 19810, US

(51) MKP

**A61J 7/00 2006 (97) EP 3682915**

**A61M 1/02 2006**

**A61M 1/14 2006**

**A61M 1/16 2006**

**A61M 1/18 2006**

**A61M 5/307 2006**

**A61M 5/315 2006**

(96) EP 20156766.6 10/28/2016

(97) EP 3682915, 3/3/2021 202109, en

(31) 201562248837 P (32) 30.10.2015 (33) US

(54) APPARATUS AND METHODS FOR DISPENSING ORAL TRANSMUCOSAL DOSAGE FORMS

(72) DOMINGO, Casidy, 617 H Woodside Way, San Mateo, CA 94401, US

CHIU, Edmond, 1672 Funston Avenue, San Francisco, CA 94122, US

BLACKWOOD, Bradley, 1910 Jeneane Marie Circle, San Jose, CA 95122, US

(51) MKP

**E04F 13/00 2006 (97) EP 3699371**

**E04F 13/06 2006**

**E06B 1/62 2006**

(96) EP 20156899.5 2/12/2020

(97) EP 3699371, 3/17/2021 202111, de

(31) 501282019 (32) 19.02.2019 (33) AT

(54) CONNECTION PROFILE FOR COMPONENTS BORDERING PLASTER

(71) K-Uni Kunststoffproduktions- und Handels-GmbH, Triglavstrasse 16, 9500 Villach, AT

(72) PESSENTHEINER, Sandro, Dr. Albin-Thaler-Weg 468, 9710 Feistritz an der Drau, AT

(51) MKP

**C07K 14/00 2006 (97) EP 3693383**

**C07K 14/735 2006**

**C12N 15/85 2006**

(96) EP 20156988.6 4/8/2015

(97) EP 3693383, 3/24/2021 202112, en

(31) 201461977037 P (32) 08.04.2014 (33) US

(54) MOUSE-HUMAN FC-GAMMA-RI PROTEINS AND ENCODING DNA

(72) MURPHY, Andrew, J, c/o Regeneron Pharmaceuticals, Inc. 777 Old Saw Mill River Road, Tarrytown, NY 10591, US

MACDONALD, Lynn, c/o Regeneron Pharmaceuticals, Inc. 777 Old Saw Mill River Road, Tarrytown, NY 10591, US

GURER, Cagan, c/o Regeneron Pharmaceuticals, Inc. 777 Old Saw Mill River Road, Tarrytown, NY 10591, US

MEAGHER, Karolina, A, c/o Regeneron Pharmaceuticals, Inc. 777 Old Saw Mill River Road, Tarrytown, NY 10591, US

TU, Naxin, c/o Regeneron Pharmaceuticals, Inc. 777 Old Saw Mill River Road, Tarrytown, NY 10591, US

(51) MKP

**A61K 31/437 2006 (97) EP 3686193**

**A61K 31/506 2006**

**A61P 35/00 2006**

**C07D 401/02 2006**

**C07D 471/04 2006**

(96) EP 20157798.8 7/25/2012  
 (97) EP 3686193, 3/10/2021 202110, en  
 (31) 201161512061 P (32) 27.07.2011 (33) US  
 201261591363 P 27.01.2012 US  
 (54) 2-(2,4,5-SUBSTITUTED-ANILINO)PYRIMIDINE COMPOUNDS  
 (72) BUTTERWORTH, Sam, c/o AstraZeneca Intellectual Property, AstraZeneca Alderley Park, Macclesfield, Cheshire SK10 4TG, GB  
 WARD, Richard Andrew, AstraZeneca, Intellectual Property Darwin Building Cambridge Science Park, Milton Road, Cambridge, Cambridgeshire  
 CB4 0WG, GB  
 FINLAY, Maurice Raymond Verschoyle, AstraZeneca, Intellectual Property Darwin Building, Cambridge Science Park Milton Road, Cambridge,  
 CB4 0WG, GB  
 KADAMBAR, Vasantha, Krishna, AstraZeneca, Intellectual Property Alderley Park, Macclesfield, Cheshire SK10 4TG, GB  
 CHINTAKUNTLA, Chandrasekhara, Reddy, AstraZeneca, Intellectual Property Alderley Park, Macclesfield, Cheshire SK10 4TG, GB  
 MURUGAN, Andiappan, AstraZeneca, Intellectual Property Alderley Park, Macclesfield, Cheshire SK10 4TG, GB  
 CHUAQUI, Claudio, Edmundo, AstraZeneca 35 Gatehouse Drive, Waltham, MA 02451, US  
 REDFEARN, Heather, Marie, AstraZeneca Charter Way, Macclesfield, Cheshire SK10 2NA, GB

(51) MKP  
**A61K 31/437 2006 (97) EP 3686194**  
**A61K 31/506 2006**  
**A61P 35/00 2006**  
**C07D 401/02 2006**  
**C07D 471/04 2006**  
 (96) EP 20157927.3 7/25/2012  
 (97) EP 3686194, 3/10/2021 202110, en  
 (31) 201161512061 P (32) 27.07.2011 (33) US  
 201261591363 P 27.01.2012 US  
 (54) 2-(2,4,5-SUBSTITUTED-ANILINO)PYRIMIDINE COMPOUNDS  
 (72) BUTTERWORTH, Sam, c/o AstraZeneca Intellectual Property, AstraZeneca Alderley Park, Macclesfield, Cheshire SK10 4TG, GB  
 WARD, Richard Andrew, AstraZeneca, Intellectual Property Darwin Building Cambridge Science Park, Milton Road, Cambridge, Cambridgeshire  
 CB4 0WG, GB  
 FINLAY, Maurice Raymond Verschoyle, AstraZeneca, Intellectual Property Darwin Building, Cambridge Science Park Milton Road, Cambridge,  
 CB4 0WG, GB  
 KADAMBAR, Vasantha, Krishna, AstraZeneca, Intellectual Property Alderley Park, Macclesfield, Cheshire SK10 4TG, GB  
 CHINTAKUNTLA, Chandrasekhara, Reddy, AstraZeneca, Intellectual Property Alderley Park, Macclesfield, Cheshire SK10 4TG, GB  
 MURUGAN, Andiappan, AstraZeneca, Intellectual Property Alderley Park, Macclesfield, Cheshire SK10 4TG, GB  
 CHUAQUI, Claudio, Edmundo, AstraZeneca 35 Gatehouse Drive, Waltham, MA 02451, US  
 REDFEARN, Heather, Marie, AstraZeneca Charter Way, Macclesfield, Cheshire SK10 2NA, GB

(51) MKP  
**A61K 31/52 2006 (97) EP 3797797**  
**A61K 47/68 2017**  
**A61P 35/00 2006**  
**C07D 487/04 2006**  
**C07H 15/26 2006**  
 (96) EP 20158359.8 10/25/2016  
 (97) EP 3797797, 3/31/2021 202113, en  
 (31) 201562247896 P (32) 29.10.2015 (33) US  
 (54) ANTIBODY CONJUGATES COMPRISING TOLL-LIKE RECEPTOR AGONIST  
 (72) CORTEZ, Alex, Novartis Institute for Functional Genomics Inc., dba Genomics Institute of the Novartis Research Foundation 10675 John Jay  
 Hopkins Drive, San Diego, California 92121, US  
 GEIERSTANGER, Bernhard Hubert, 482 Santa Cecelia, Solana Beach, CA 92075, US  
 HOFFMAN, Timothy Z., Novartis Institute for Functional Genomics Inc., dba Genomics Institute of the Novartis Research Foundation 10675 John  
 Jay Hopkins Drive, San Diego, California 92121, US  
 KASIBHATLA, Shailaja, 13073 Dressage Lane, San Diego, CA 92130, US  
 UNO, Tetsuo, Novartis Institute for Functional Genomics Inc., dba Genomics Institute of the Novartis Research Foundation 10675 John Jay  
 Hopkins Drive, San Diego, California 92121, US  
 WANG, Xing, Novartis Institute for Functional Genomics Inc., dba Genomics Institute of the Novartis Research Foundation 10675 John Jay  
 Hopkins Drive, San Diego, California 92121, US  
 WU, Tom Yao-Hsiang, 17570 Teal Stone Court, San Diego, CA 92127, US

(51) MKP  
**A61K 31/4162 2006 (97) EP 3689874**  
**A61K 31/437 2006**  
**A61K 31/4745 2006**

	<b>A61P 25/00</b>	<b>2006</b>					
	<b>A61P 25/14</b>	<b>2006</b>					
	<b>A61P 25/16</b>	<b>2006</b>					
	<b>A61P 25/18</b>	<b>2006</b>					
	<b>A61P 25/22</b>	<b>2006</b>					
	<b>A61P 25/24</b>	<b>2006</b>					
	<b>A61P 25/28</b>	<b>2006</b>					
	<b>A61P 43/00</b>	<b>2006</b>					
	<b>C07D 305/06</b>	<b>2006</b>					
	<b>C07D 401/04</b>	<b>2006</b>					
	<b>C07D 413/04</b>	<b>2006</b>					
	<b>C07D 471/04</b>	<b>2006</b>					
(96)	EP 20158664.1 6/30/2017						
(97)	EP 3689874, 3/17/2021 202111, en						
(31)	PA201600397		(32)	04.07.2016		(33)	DK
	PA201600612			11.10.2016			DK
	PA201700236			04.04.2017			DK
(54)	1H-PYRAZOLO[4,3-B]PYRIDINES AS PDE1 INHIBITORS						
(72)	KEHLER, Jan, c/o H. Lundbeck A/S Ottiliavej 9, 2500 Valby, DK JUHL, Karsten, c/o H. Lundbeck A/S Ottiliavej 9, 2500 Valby, DK MARIGO, Mauro, c/o H. Lundbeck A/S Ottiliavej 9, 2500 Valby, DK VITAL, Paulo, Jorge, Vieira, c/o H. Lundbeck A/S Ottiliavej 9, 2500 Valby, DK JESSING, Mikkel, c/o H. Lundbeck A/S Ottiliavej 9, 2500 Valby, DK LANGGÅRD, Morten, c/o H. Lundbeck A/S Ottiliavej 9, 2500 Valby, DK RASMUSSEN, Lars Kyhn, c/o H. Lundbeck A/S Ottiliavej 9, 2500 Valby, DK CLEMENTSON, Carl, Martin, Sebastian, c/o H. Lundbeck A/S Ottiliavej 9, 2500 Valby, DK						
<hr/>							
(51)	MKP						
	<b>C07K 16/24</b>	<b>2006</b>	(97)	<b>EP 3683235</b>			
(96)	EP 20159871.1 3/12/2014						
(97)	EP 3683235, 3/3/2021 202109, en						
(31)	201361778687 P		(32)	13.03.2013		(33)	US
	201361819018 P			03.05.2013			US
(54)	ANTI-IL-33 ANTIBODIES AND USES THEREOF						
(72)	MURPHY, Andrew, J., 10 Newton Court, Croton-on-Hudson, NY 10520, US PAPADOPOULOS, Nicholas, J., 59 Heritage Lane, Lagrangeville, NY 12540, US ORENGO, Jamie, M., 17 Maple Moor Lane, Cortlandt Manor, NY 10567, US						
<hr/>							
(51)	MKP						
	<b>A61K 35/26</b>	<b>2015</b>	(97)	<b>EP 3708579</b>			
	<b>A61P 35/00</b>	<b>2006</b>					
	<b>C07K 14/47</b>	<b>2006</b>					
	<b>C07K 14/725</b>	<b>2006</b>					
(96)	EP 20160141.6 3/30/2015						
(97)	EP 3708579, 4/7/2021 202114, en						
(31)	PCT/EP2014/000868		(32)	01.04.2014		(33)	WO
	PCT/EP2014/072864			24.10.2014			WO
(54)	CLAUDIN-6-SPECIFIC IMMUNORECEPTORS AND T CELL EPITOPES						
(72)	SAHIN, Ugur, Philipp-von-Zabern-Platz 1, 55116 Mainz, DE TÜRECI, Özlem, Philipp-von-Zabern-Platz 1, 55116 Mainz, DE OEHM, Petra, Silvanerstrasse 33A, 55129 Mainz, DE OMOKOKO, Tana, Franz-Werfel-Str. 20, 55116 Mainz, DE HOFF, Holger, Tieckstrasse 22, 10115 Berlin, DE VOSS, Ralf-Holger, Lotharstrasse 32, 55218 Ingelheim, DE BREITKREUZ, Andrea, Trifelsstrasse 47, 67551 Worms, DE HOBOHM, Kathleen, Johann-Strauss-Str. 18, 65779 Kelkheim i. Ts., DE MROZ, Karolina Anna, c/o BioNTech Cell & Gene Therapies GmbH An der Goldgrube 12, 55131 Mainz, DE						
<hr/>							
(51)	MKP						
	<b>A61B 17/00</b>	<b>2006</b>	(97)	<b>EP 3679869</b>			
	<b>A61B 17/072</b>	<b>2006</b>					
	<b>A61B 17/29</b>	<b>2006</b>					

	<b>A61B 90/00</b>	<b>2016</b>				
	<b>A61B 90/98</b>	<b>2016</b>				
(96)	EP 20160626.6	9/28/2016				
(97)	EP 3679869, 2/24/2021	202108, en				
(31)	201514868718		(32)	29.09.2015	(33)	US
(54)	SURGICAL STAPLING INSTRUMENT WITH SHAFT RELEASE					
(72)	LEIMBACH, Richard L., 4545 Creek Road, Cincinnati, OH 45242, US					
	SIEBEL, Tony, 4545 Creek Road, Cincinnati, OH 45242, US					
	SWENSGARD, Brett E., 4545 Creek Road, Cincinnati, OH 45242, US					
	OVERMYER, Mark D., 4545 Creek Road, Cincinnati, OH 45242, US					
	MORGAN, Joshua, 4545 Creek Road, Cincinnati, OH 45242, US					
	ADAMS, Shane, 4545 Creek Road, Cincinnati, OH 45242, US					
	SCHINGS, Brian, 4545 Creek Road, Cincinnati, OH 45242, US					
	POSADA, Sol, 4545 Creek Road, Cincinnati, OH 45242, US					
	HANSEN, Bryce, 220 West 4th Street, Suite 1140, Cincinnati, OH 45202, US					

---

(51)	MKP					
	<b>A61K 39/00</b>	<b>2006</b>	<b>(97) EP 3693395</b>			
	<b>A61P 1/04</b>	<b>2006</b>				
	<b>A61P 7/00</b>	<b>2006</b>				
	<b>A61P 9/00</b>	<b>2006</b>				
	<b>A61P 11/00</b>	<b>2006</b>				
	<b>A61P 11/02</b>	<b>2006</b>				
	<b>A61P 17/00</b>	<b>2006</b>				
	<b>A61P 17/02</b>	<b>2006</b>				
	<b>A61P 19/02</b>	<b>2006</b>				
	<b>A61P 19/08</b>	<b>2006</b>				
	<b>A61P 25/00</b>	<b>2006</b>				
	<b>A61P 27/16</b>	<b>2006</b>				
	<b>A61P 29/00</b>	<b>2006</b>				
	<b>A61P 31/04</b>	<b>2006</b>				
	<b>A61P 35/00</b>	<b>2006</b>				
	<b>A61P 37/00</b>	<b>2006</b>				
	<b>A61P 37/02</b>	<b>2006</b>				
	<b>A61P 37/06</b>	<b>2006</b>				
	<b>A61P 37/08</b>	<b>2006</b>				
	<b>A61P 43/00</b>	<b>2006</b>				
	<b>C07K 16/28</b>	<b>2006</b>				
(96)	EP 20160953.4	5/17/2013				
(97)	EP 3693395, 3/17/2021	202111, en				
(31)	201261649147 P		(32)	18.05.2012	(33)	US
	201361792619 P			15.03.2013		US
(54)	ST2 ANTIGEN BINDING PROTEINS					
(72)	SMITH, Dirk E, 11633 Meadowmeer Circle NE, Bainbridge Island, WA 98110, US					
	FOLTZ, Ian, 2108 Knightswood Place, Burnaby, CA California BC V5A 4B9, US					
	KING, Chadwick T., 1325 Moody Avenue, North Vancouver, CA California BC V7L 3T5, US					
	LIM, Ai Ching, 7105 82nd Avenue SE, Mercer Island, WA 98040, US					
	CLARK, Rutilio, 5335 Old Mill Road NE, Bainbridge Island, WA 98110, US					
	COMEAU, Michael, 1044 High School Road NE, Bainbridge Island, WA 98110, US					
	KETCHEM, Randal R., 6332 152nd Street SE, Snohomish, WA 98296, US					
	SHI, Donghui, 3198 Rickey Court, Thousand Oaks, CA 91362, US					
	MIN, Xiaoshan, 2108 Clarice Lane, Burlingame, CA 94010, US					
	WANG, Zhulun, 660 Glenbrook Drive, Palo Alto, CA 94306, US					

---

(51)	MKP					
	<b>A61K 31/445</b>	<b>2006</b>	<b>(97) EP 3682879</b>			
	<b>C07D 211/60</b>	<b>2006</b>				
(96)	EP 20160995.5	9/28/2015				
(97)	EP 3682879, 2/24/2021	202108, en				
(31)	201462057107 P		(32)	29.09.2014	(33)	US
(54)	PROCESSES AND INTERMEDIATES IN THE PREPARATION OF C5AR ANTAGONISTS					
(72)	FAN, Pingchen, 2157 Kalenda Commons, Fremont, CA 94539, US					
	KALISIAK, Jaroslaw, 1031 Crestview Drive Apt. 104, Mountain View, 94040, US					
	KRASINSKI, Antoni, 4125 De Mille Drive, San Jose, CA 95117, US					
	LUI, Rebecca, 3901 Lick Mill Boulevard 346, Santa Clara, CA 95054, US					

POWERS, Jay, 745 Rockaway Beach Avenue, Pacifica, CA 94044, US  
 PUNNA, Sreenivas, 1240 Vicente Drive Apt. E, Sunnyvale, CA 94086, US  
 TANAKA, Hiroko, 815 Catamaran Street 1, Foster City, CA 94404, US  
 ZHANG, Penglie, 1036 Jamaica Street, Foster City, CA 94404, US

(51) MKP  
**F02D 11/10 2006 (97) EP 3708813**  
**F02D 41/14 2006**  
 (96) EP 20161040.9 3/4/2020  
 (97) EP 3708813, 4/7/2021 202114, en  
 (31) 2019043601 (32) 11.03.2019 (33) JP  
 (54) ELECTRONICALLY CONTROLLED THROTTLE CONTROL DEVICE  
 (71) Nikki Co., Ltd., 3029 Kamiechi Atsugi-shi, Kanagawa-ken 243-0801, JP  
 (72) INO, Takuya, c/o Nikki Co., Ltd. 3029 Kamiechi, Atsugi, Kanagawa 243-0801, JP  
 OGURO, Ryuichi, c/o Nikki Co., Ltd. 3029 Kamiechi, Atsugi, Kanagawa 243-0801, JP

(51) MKP  
**G05B 19/418 2006 (97) EP 3709113**  
**G06F 21/64 2013**  
**H04L 9/32 2006**  
 (96) EP 20161877.4 3/9/2020  
 (97) EP 3709113, 4/7/2021 202114, de  
 (31) 2992019 (32) 12.03.2019 (33) CH  
 10972019 30.08.2019 CH  
 (54) DATA INTEGRITY TESTING METHOD  
 (71) Fr. Sauter AG, Im Surinam 55, 4016 Basel, CH  
 (72) Gassmann, Felix, 28 rue du stade, 68220 Leymen, FR

(51) MKP  
**C12N 5/02 2006 (97) EP 3683316**  
**C12P 21/02 2006**  
 (96) EP 20162652.0 1/29/2015  
 (97) EP 3683316, 2/24/2021 202108, en  
 (31) 201461933665 P (32) 30.01.2014 (33) US  
 (54) PERFUSION MEDIA  
 (71) Coherus Biosciences, Inc., 333 Twin Dolphin Drive Suite 600, Redwood City, CA 94065, US  
 (72) PUCHACZ, Ela, 2607 Rasmussen Ct, Pleasanton, CA 94588, US  
 GROVE, James, Russell, 1152 Barbara Avenue, Mountain View, CA 94040, US

(51) MKP  
**A61K 9/48 2006 (97) EP 3689380**  
**A61K 31/047 2006**  
**A61K 47/14 2017**  
**A61P 1/00 2006**  
**A61P 1/04 2006**  
**A61P 3/02 2006**  
**A61P 3/12 2006**  
**A61P 3/14 2006**  
**A61P 5/18 2006**  
**A61P 7/00 2006**  
**A61P 13/12 2006**  
**A61P 19/00 2006**  
**A61P 19/02 2006**  
**A61P 19/08 2006**  
**A61P 19/10 2006**  
**A61P 43/00 2006**  
 (96) EP 20163569.5 2/5/2016  
 (97) EP 3689380, 3/10/2021 202110, en  
 (31) 15382042 (32) 06.02.2015 (33) EP  
 (54) CALCIFEDIOL SOFT CAPSULES  
 (72) SUÑÉ NEGRE, Josep Maria, UNIVERSITAT DE BARCELONA, Facultat de Farmàcia Juan XXIII, s/n, Edificio A, Escalera A, planta baja, E-08028 Barcelona, Catalunya, ES  
 ORTEGA AZPITARTE, Ignacio, FAES FARMA, S.A. Autonomía, 10, E-48940 Leioa, Vizcaya, ES

DEL ARENAL BARRIOS, Pepa, FAES FARMA, S.A. Autonomía, 10, E-48940 Leioa, Vizcaya, ES  
 HERNÁNDEZ HERRERO, Gonzalo, FAES FARMA, S.A. Autonomía, 10, E-48940 Leioa, Vizcaya, ES

- (51) MKP  
**A61K 31/27 2006 (97) EP 3698782**  
**A61K 31/325 2006**  
**C07C 269/00 2006**  
**C07C 271/00 2006**  
**C07C 271/62 2006**  
**C07D 203/20 2006**
- (96) EP 20164236.0 1/7/2013  
 (97) EP 3698782, 3/17/2021 202111, en
- (31) 201261631558 P (32) 06.01.2012 (33) US
- (54) CARBAMATE COMPOUNDS FOR USE IN THERAPY  
 (72) CISAR, Justin S., 13409 Tiverton Road, San Diego, California 92130, US  
 GRICE, Cheryl A., 924 Springwood Lane, Encinitas, California 92024, US  
 JONES, Todd K., 546, Marview Drive, Solana Beach, California 92075, US  
 NIPHAKIS, Micah J., 7911 Camino Kiosco, San Diego, California 92122, US  
 CHANG, Jae Won, 9175 Judicial Dr., Apt. 6111, San Diego, California 92122, US  
 LUM, Kenneth M., 8929 Lombard Place, Apt. 132, San Diego, California 92122, US  
 CRAVATT, Benjamin F., 415 Camino De La Costa, La Jolla, California 92037, US

- (51) MKP  
**C09K 11/56 2006 (97) EP 3788120**  
**C09K 11/88 2006**  
**G01N 21/64 2006**
- (96) EP 19723033.7 4/29/2019  
 (97) EP 3788120, 3/10/2021 202110, en
- (31) 18170123 (32) 30.04.2018 (33) EP
- (54) NANO ENCODING TECHNOLOGY FOR THE TRACKING OF INFORMATION IN LIQUID SAMPLES  
 (71) Institut Pasteur de Dakar, 36, Avenue Pasteur, BP 220 Dakar, SN  
 Berthet, François Xavier, Ronda Mitre, 126, 08021 Barcelona, ES  
 (72) SALL, Amadou Alpha, Institut Pasteur de Dakar 36, Avenue Pasteur, Dakar, BP 220, SN  
 BERTHET, François Xavier, Ronda Mitre, 126, 08021 Barcelona, ES

- (51) MKP  
**A61K 39/00 2006 (97) EP 3788074**  
**A61P 35/00 2006**  
**C07K 16/28 2006**  
**C07K 16/46 2006**
- (96) EP 19723054.3 5/3/2019  
 (97) EP 3788074, 3/10/2021 202110, en
- (31) PA201800195 (32) 03.05.2018 (33) DK  
 PA201800644 26.09.2018 DK
- (54) ANTIBODY VARIANT COMBINATIONS AND USES THEREOF  
 (72) DE JONG, Rob, c/o Genmab B.V. Uppsalalaan 15, 3584 CT Utrecht, NL  
 BEURSKENS, Frank, c/o Genmab B.V. Uppsalalaan 15, 3584 CT Utrecht, NL  
 OOSTINDIE, Simone, c/o Genmab B.V. Uppsalalaan 15, 3584 CT Utrecht, NL  
 LABRIJN, Aran, Frank, c/o Genmab B.V. Uppsalalaan 15, 3584 CT Utrecht, NL  
 STRUMANE, Kristin, c/o Genmab B.V. Uppsalalaan 15, 3584 CT Utrecht, NL  
 SCHUURMAN, Janine, c/o Genmab B.V. Uppsalalaan 15, 3584 CT Utrecht, NL  
 DE KREUK, Bart-Jan, c/o Genmab B.V. Uppsalalaan 15, 3584 CT Utrecht, NL

- (51) MKP  
**A61K 31/427 2006 (97) EP 3793553**  
**A61P 9/04 2006**  
**A61P 9/10 2006**  
**A61P 9/12 2006**  
**A61P 25/28 2006**
- (96) EP 19723125.1 5/14/2019  
 (97) EP 3793553, 3/24/2021 202112, en
- (31) 18172405 (32) 15.05.2018 (33) EP



- (54) 1,3-THIAZOL-2-YL SUBSTITUTED BENZAMIDES FOR THE TREATMENT OF DISEASES ASSOCIATED WITH NERVE FIBER SENSITIZATION  
 (72) HOFMEISTER, Lucas, Hudson, Aue 80, 42103 Wuppertal, DE  
 FISCHER, Oliver, Martin, Brester Ring 4, 13127 Berlin, DE

- (51) MKP  
**C07D 401/12 2006 (97) EP 3788040**  
**C07D 401/14 2006**  
**C07D 403/04 2006**  
**C07D 403/12 2006**  
**C07D 405/14 2006**  
**C07D 413/14 2006**  
**C07D 417/12 2006**  
**C07D 417/14 2006**  
**C07D 451/02 2006**  
**C07D 471/04 2006**  
**C07D 471/08 2006**  
**C07D 471/10 2006**  
**C07D 487/04 2006**  
**C07D 487/08 2006**  
**C07D 487/10 2006**

- (96) EP 19723272.1 4/29/2019  
 (97) EP 3788040, 3/10/2021 202110, en  
 (31) 201862664544 P (32) 30.04.2018 (33) US  
 (54) PYRIDAZINONES AS PARP7 INHIBITORS  
 (72) VASBINDER, Melissa Marie, 7 Beecher Place, Newton, Massachusetts 02459, US  
 SCHENKEL, Laurie B., 17 Hammond St. 1, Somerville, Massachusetts 02143, US  
 SWINGER, Keren Kalai, 9 Chase Ave., Lexington, Massachusetts 02421, US  
 KUNTZ, Kevin Wayne, 8 New Village Rd, Woburn, Massachusetts 01801, US

- (51) MKP  
**C12Q 1/6886 2018 (97) EP 3784804**

- (96) EP 19723326.5 4/23/2019  
 (97) EP 3784804, 3/3/2021 202109, en  
 (31) 201862661930 P (32) 24.04.2018 (33) US  
 (54) SELECTING PATIENTS FOR THERAPY WITH ADENOSINE SIGNALING INHIBITORS  
 (72) LINGHU, Bolan, AstraZeneca R&D Boston 35 Gatehouse Drive, Waltham, MA 02451, US  
 MERCHANT, Melinda, AstraZeneca R&D Boston 35 Gatehouse Drive, Waltham, MA 02451, US  
 SACHSENMEIER, Kris, AstraZeneca R&D Boston 35 Gatehouse Drive, Waltham, MA 02451, US  
 XIE, Mingchao, AstraZeneca R&D Boston 35 Gatehouse Drive, Waltham, MA 02451, US

- (51) MKP  
**A61K 31/55 2006 (97) EP 3790884**  
**A61P 35/00 2006**  
**C07D 498/14 2006**

- (96) EP 19723368.7 5/7/2019  
 (97) EP 3790884, 3/17/2021 202111, en  
 (31) 201862668321 P (32) 08.05.2018 (33) US  
 201862754814 P 02.11.2018 US  
 (54) TETRACYCLIC HETEROARYL COMPOUNDS  
 (72) KETTLE, Jason, Grant, 1 Francis Crick Avenue Cambridge Biomedical Campus Cambridge, Cambridgeshire CB2 0AA, GB  
 BAGAL, Sharanjeet, Kaur, 1 Francis Crick Avenue Cambridge Biomedical Campus Cambridge, Cambridgeshire CB2 0AA, GB  
 EATHERTON, Andrew, John, 1 Francis Crick Avenue Cambridge Biomedical Campus Cambridge, Cambridgeshire CB2 0AA, GB  
 FILLERY, Shaun, Michael, 1 Francis Crick Avenue Cambridge Biomedical Campus Cambridge, Cambridgeshire CB2 0AA, GB  
 ROBB, Graeme, Richard, 1 Francis Crick Avenue Cambridge Biomedical Campus Cambridge, Cambridgeshire CB2 0AA, GB  
 LAMONT, Scott, Gibson, 1 Francis Crick Avenue Cambridge Biomedical Campus Cambridge, Cambridgeshire CB2 0AA, GB  
 KEMMITT, Paul, David, 1 Francis Crick Avenue Cambridge Biomedical Campus Cambridge, Cambridgeshire CB2 0AA, GB  
 GOLDBERG, Frederick, Woolf, 1 Francis Crick Avenue Cambridge Biomedical Campus Cambridge, Cambridgeshire CB2 0AA, GB

- (51) MKP  
**A61K 47/54 2017 (97) EP 3790590**  
**A61K 47/58 2017**  
**A61K 47/64 2017**

	<b>A61K 47/65</b>	<b>2017</b>					
	<b>A61K 47/68</b>	<b>2017</b>					
	<b>A61K 51/06</b>	<b>2006</b>					
	<b>A61K 51/10</b>	<b>2006</b>					
	<b>A61P 35/00</b>	<b>2006</b>					
(96)	EP 19723370.3 5/8/2019						
(97)	EP 3790590, 3/17/2021 202111, en						
(31)	201862762549 P		(32)	10.05.2018		(33)	US
(54)	BIOCOMPATIBLE COPOLYMER CONTAINING MULTIPLE ACTIVE AGENT MOLECULES						
(71)	CIS Pharma AG, Hauptstrasse 159, 4416 Bubendorf, CH						
(72)	GERATHS, Christian, Friedrichplatz 5, 79618 Rheinfelden, DE						
	THOMMEN, Christophe, 19C Rue de la Vallée, 68640 Muespach-Le-Haut, FR						
	HACKEBEIL, Michael, Niederwihl 42, 79733 Görwihl, DE						
	PANIGHETTI, Davide, Baselstrasse 28, 4142 Münchenstein, CH						
	HITZ, Hans, Blauenrainstrasse 25, 4422 Arisdorf, CH						
<hr/>							
(51)	MKP						
	<b>G01N 33/68</b>	<b>2006</b>	(97)	<b>EP 3794355</b>			
(96)	EP 19723441.2 5/16/2019						
(97)	EP 3794355, 3/24/2021 202112, en						
(31)	18305600		(32)	16.05.2018		(33)	EP
(54)	BLOOD BIOMARKERS OF STROKE						
(71)	Centre Hospitalier Régional et Universitaire de Brest, 2 avenue Foch, 29609 Brest Cedex, FR						
	Etablissement Français du Sang, 20, Avenue Stade de France Saint Denis, 93210 La Plaine Saint Denis, FR						
	Institut National de la Santé et de la Recherche Médicale (INSERM), 101 rue de Tolbiac, 75654 Paris Cedex 13, FR						
	Université de Bretagne Occidentale, 3, rue des Archives, 29238 Brest, FR						
(72)	TIMSIT, Serge, 22 rue de Lyon, 29200 Brest, FR						
	GENIN, Emmanuelle, 14 rue de la Fontaine Blanche, 29470 Plougastel-Daoulas, FR						
<hr/>							
(51)	MKP						
	<b>A61P 3/00</b>	<b>2006</b>	(97)	<b>EP 3788037</b>			
	<b>A61P 9/00</b>	<b>2006</b>					
	<b>A61P 13/12</b>	<b>2006</b>					
	<b>C07D 239/545</b>	<b>2006</b>					
	<b>C07D 401/12</b>	<b>2006</b>					
	<b>C07D 401/14</b>	<b>2006</b>					
	<b>C07D 403/14</b>	<b>2006</b>					
	<b>C07D 405/14</b>	<b>2006</b>					
(96)	EP 19723581.5 4/30/2019						
(97)	EP 3788037, 3/10/2021 202110, en						
(31)	201862665244 P		(32)	01.05.2018		(33)	US
(54)	SUBSTITUTED PYRIMIDINONES AS AGONISTS OF THE APJ RECEPTOR						
(72)	PATTAROPONG, Vatee, 74 South Road, Bedford, Massachusetts 01730, US						
	RAMSDEN, Philip Dean, 20 Alexandra Way, Acton, Massachusetts 01720, US						
<hr/>							
(51)	MKP						
	<b>A61K 31/427</b>	<b>2006</b>	(97)	<b>EP 3793554</b>			
	<b>A61P 11/00</b>	<b>2006</b>					
	<b>A61P 11/06</b>	<b>2006</b>					
	<b>A61P 11/14</b>	<b>2006</b>					
	<b>A61P 25/28</b>	<b>2006</b>					
(96)	EP 19723792.8 5/14/2019						
(97)	EP 3793554, 3/24/2021 202112, en						
(31)	18172409		(32)	15.05.2018		(33)	EP
(54)	1,3-THIAZOL-2-YL SUBSTITUTED BENZAMIDES FOR THE TREATMENT OF DISEASES ASSOCIATED WITH NERVE FIBER SENSITIZATION						
(72)	FRIEDRICH, Christian, Altstädtische Fischerstrasse 17, 14770 Brandenburg, DE						
	GASHAW, Isabella, Kiefheider Weg 66, 13503 Berlin, DE						
	BROCKSCHNIEDER, Damian, Kaiserstr. 48c, 42781 Haan, DE						
	FISCHER, Oliver, Martin, Brester Ring 4, 13127 Berlin, DE						
<hr/>							
(51)	MKP						

	<b>A61K 31/537</b>	<b>2006</b>	<b>(97) EP 3784676</b>				
	<b>A61P 31/18</b>	<b>2006</b>					
	<b>C07D 498/18</b>	<b>2006</b>					
(96)	EP 19723888.4 4/25/2019						
(97)	EP 3784676, 3/3/2021 202109, en						
(31)	201841015814		(32)	26.04.2018	(33)		IN
	201841020810			04.06.2018			IN
	201841034008			10.09.2018			IN
(54)	POLYMORPHIC FORMS OF BICTEGRAVIR AND ITS SODIUM SALT						
(72)	JETTI, Ramakoteswara Rao, Mylan Laboratories Ltd Plot No 564/A/22, Road No 92 Jubilee Hills, Hyderabad 500033, IN BHATRAJU, Daveedu, Mylan Laboratories Ltd Plot No 564/A/22, Road No 92 Jubilee Hills, Hyderabad 500033, IN DANDALA, Subramanyam, Mylan Laboratories Ltd Plot No 564/A/22, Road No 92 Jubilee Hills, Hyderabad 500033, IN BOMMAREDDY, Aggi Ramireddy, Mylan Laboratories Ltd Plot No 564/A/22, Road No 92 Jubilee Hills, Hyderabad 500033, IN MULAMALLA, Rajendar Reddy, Mylan Laboratories Ltd Plot No 564/A/22, Road No 92 Jubilee Hills, Hyderabad 500033, IN TAILOR, Sridhar, Mylan Laboratories Ltd Plot No 564/A/22, Road No 92 Jubilee Hills, Hyderabad 500033, IN JAYACHANDRA, Sureshbabu, Mylan Laboratories Ltd Plot No 564/A/22, Road No 92 Jubilee Hills, Hyderabad 500033, IN						
(51)	MKP						
	<b>C08G 64/02</b>	<b>2006</b>	<b>(97) EP 3781609</b>				
	<b>C08G 64/42</b>	<b>2006</b>					
	<b>C08L 69/00</b>	<b>2006</b>					
(96)	EP 19723928.8 4/18/2019						
(97)	EP 3781609, 2/24/2021 202108, en						
(31)	201862659684 P		(32)	18.04.2018	(33)		US
	201862711318 P			27.07.2018			US
(54)	END-GROUP ISOMERIZATION OF POLY(ALKYLENE CARBONATE) POLYMERS						
(71)	SAUDI ARAMCO TECHNOLOGIES COMPANY, P.O. Box 62, Dhahran 31311, SA						
(72)	EAGAN, James, c/o Aramco Performance Materials LLC 950 Danby Road, Suite 198 Ithaca, New York 14850, US SIMONEAU, Christopher A., c/o Aramco Performance Materials LLC 950 Danby Road, Suite 198 Ithaca, New York 14850, US FARMER, Jay J., c/o Aramco Performance Materials LLC 950 Danby Road, Suite 198 Ithaca, New York 14850, US						
(51)	MKP						
	<b>A61K 31/553</b>	<b>2006</b>	<b>(97) EP 3788044</b>				
	<b>A61P 29/00</b>	<b>2006</b>					
	<b>A61P 37/02</b>	<b>2006</b>					
	<b>C07D 413/12</b>	<b>2006</b>					
	<b>C07D 413/14</b>	<b>2006</b>					
(96)	EP 19724048.4 5/2/2019						
(97)	EP 3788044, 3/10/2021 202110, en						
(31)	201862666462 P		(32)	03.05.2018	(33)		US
(54)	RIP1 INHIBITORY COMPOUNDS AND METHODS FOR MAKING AND USING THE SAME						
(72)	MASUDA, Esteban, 232 Oakhurst Place, Menlo Park, CA 94025, US SHAW, Simon, 1232 19th Street, Unit 10,, Oakland, CA 94607, US TAYLOR, Vanessa, 564 29th Avenue,, San Francisco, CA 94121, US BHAMIDIPATI, Somasekhar, 878 Andromeda Lane, Foster City, CA 94404, US						
(51)	MKP						
	<b>A61K 39/395</b>	<b>2006</b>	<b>(97) EP 3788076</b>				
	<b>C07K 16/28</b>	<b>2006</b>					
(96)	EP 19724307.4 4/30/2019						
(97)	EP 3788076, 3/10/2021 202110, en						
(31)	201862665045 P		(32)	01.05.2018	(33)		US
(54)	ANTIBODIES WITH MODULATED GLYCAN PROFILES						
(72)	CROWELL, Christopher, Kenyon, c/o Amgen Inc. One Amgen Center Drive Mail Stop 28-5-A, Thousand Oaks, California 91320-1799, US WU, Jian, c/o Amgen Inc. One Amgen Center Drive Mail Stop 28-5-A, Thousand Oaks, California 91320-1799, US NAGI, Athena, Denise, c/o Amgen Inc. One Amgen Center Drive Mail Stop 28-5-A, Thousand Oaks, California 91320-1799, US KITCHEN, Neil, Anthony, c/o Amgen Inc. One Amgen Center Drive Mail Stop 28-5-A, Thousand Oaks, California 91320-1799, US GILLESPIE, Alison, Jean, c/o Amgen Inc. One Amgen Center Drive Mail Stop 28-5-A, Thousand Oaks, California 91320-1799, US PETROVAN, Simina, Crina, c/o Amgen Inc. One Amgen Center Drive Mail Stop 28-5-A, Thousand Oaks, California 91320-1799, US BRANDENSTEIN, Michael, Charles, c/o Amgen Inc. One Amgen Center Drive Mail Stop 28-5-A, Thousand Oaks, California 91320-1799, US						
(51)	MKP						

	<b>C02F 1/04</b>	<b>2006</b>	<b>(97) EP 3781523</b>			
	<b>C02F 3/28</b>	<b>2006</b>				
	<b>C02F 11/04</b>	<b>2006</b>				
(96)	EP 19724562.4	4/17/2019				
(97)	EP 3781523, 2/24/2021	202108, en				
(31)	201806382		(32)	19.04.2018	(33)	GB
(54)	WASTEWATER TREATMENT APPARATUS AND METHOD					
(71)	Kanu, Ifeyinwa Rita, 10 Harlaw March, Balerno Edinburgh EH14 7BJ, GB					
(72)	Kanu, Ifeyinwa Rita, 10 Harlaw March, Balerno Edinburgh EH14 7BJ, GB					
<hr/>						
(51)	MKP					
	<b>A61K 31/553</b>	<b>2006</b>	<b>(97) EP 3788045</b>			
	<b>A61P 29/00</b>	<b>2006</b>				
	<b>A61P 37/02</b>	<b>2006</b>				
	<b>C07D 413/12</b>	<b>2006</b>				
	<b>C07D 413/14</b>	<b>2006</b>				
(96)	EP 19724662.2	5/2/2019				
(97)	EP 3788045, 3/10/2021	202110, en				
(31)	201862666452 P		(32)	03.05.2018	(33)	US
(54)	RIP1 INHIBITORY COMPOUNDS AND METHODS FOR MAKING AND USING THE SAME					
(72)	DARWISH, Ihab, 4 Azalea Ln, San Carlos, California 94070, US					
	YU, Jiaxin, 475 Nantucket Street, Foster City, California 94404, US					
	CHEN, Yan, 178 Albacore Ln., Foster City, California 94404, US					
	MASUDA, Esteban, 232 Oakhurst Place, Menlo Park, California 94025, US					
	TAYLOR, Vanessa, 564 29th Avenue, San Francisco, California 94121, US					
<hr/>						
(51)	MKP					
	<b>A61K 31/519</b>	<b>2006</b>	<b>(97) EP 3788046</b>			
	<b>A61P 35/00</b>	<b>2006</b>				
	<b>C07D 471/14</b>	<b>2006</b>				
(96)	EP 19724670.5	5/3/2019				
(97)	EP 3788046, 3/10/2021	202110, en				
(31)	201862667040 P		(32)	04.05.2018	(33)	US
(54)	SALTS OF AN FGFR INHIBITOR					
(72)	JIA, Zhongjiang, 1801 Augustine Cut-Off, Wilmington, Delaware 19803, US					
	ZHOU, Jiacheng, 1801 Augustine Cut-Off, Wilmington, Delaware 19803, US					
	LI, Qun, 1801 Augustine Cut-Off, Wilmington, Delaware 19803, US					
<hr/>						
(51)	MKP					
	<b>A61K 31/519</b>	<b>2006</b>	<b>(97) EP 3788047</b>			
	<b>A61P 35/00</b>	<b>2006</b>				
	<b>C07D 471/14</b>	<b>2006</b>				
(96)	EP 19724676.2	5/3/2019				
(97)	EP 3788047, 3/10/2021	202110, en				
(31)	201862667166 P		(32)	04.05.2018	(33)	US
	201962815539 P			08.03.2019		US
(54)	SOLID FORMS OF AN FGFR INHIBITOR AND PROCESSES FOR PREPARING THE SAME					
(72)	BURN, Timothy C., 1801 Augustine Cut-Off, Wilmington, Delaware 19803, US					
	LIU, Phillip C., 1801 Augustine Cut-Off, Wilmington, Delaware 19803, US					
	FRIETZE, William, 1801 Augustine Cut-Off, Wilmington, Delaware 19803, US					
	JIA, Zhongjiang, 1801 Augustine Cut-Off, Wilmington, Delaware 19803, US					
	TAO, Ming, 1801 Augustine Cut-Off, Wilmington, Delaware 19803, US					
	WANG, Dengjin, 1801 Augustine Cut-Off, Wilmington, Delaware 19803, US					
	ZHOU, Jiacheng, 1801 Augustine Cut-Off, Wilmington, Delaware 19803, US					
	LI, Qun, 1801 Augustine Cut-Off, Wilmington, Delaware 19803, US					
<hr/>						
(51)	MKP					
	<b>A61K 9/12</b>	<b>2006</b>	<b>(97) EP 3787599</b>			
	<b>A61K 9/51</b>	<b>2006</b>				
	<b>A61K 31/454</b>	<b>2006</b>				
(96)	EP 19724894.1	5/3/2019				
(97)	EP 3787599, 3/10/2021	202110, en				
(31)	201807286		(32)	03.05.2018	(33)	GB

- (54) NEW TREATMENT OF INTERSTITIAL LUNG DISEASES  
 (71) INIM PHARMA AB, Kornhamstorg 53, 111 27 Stockholm, SE  
 (72) DALSGAARD, Carl-Johan, HealthCap AB Engelbrektsplan 1, 114 34 Stockholm, SE  
 FEILER, Adam, Valfrid Brodds Väg 36, 165 71 Hässelby, SE  
 ZHOU, Chunfang, Frejgatan 22, 113 49 Stockholm, SE  
 PASZKIEWICZ, Paulina, Sveavägen 164N, 113 46 Stockholm, SE  
 XIA, Xin, Gällerstagränd 32, 124 76 Bandhagen, SE

- (51) MKP  
**A23L 33/135 2016 (97) EP 3790564**  
**A61K 35/74 2015**  
**A61P 1/00 2006**  
**A61P 3/10 2006**  
**A61P 11/06 2006**  
**A61P 17/06 2006**  
**A61P 19/02 2006**  
**A61P 35/00 2006**  
**A61P 37/00 2006**  
**A61P 43/00 2006**

(96) EP 19725067.3 5/13/2019

(97) EP 3790564, 3/17/2021 202111, en

(31)	18171893	(32)	11.05.2018	(33)	EP
	18178136		15.06.2018		EP
	201810386		25.06.2018		GB
	201813460		17.08.2018		GB
	201817642		29.10.2018		GB
	201820264		12.12.2018		GB
	201820256		12.12.2018		GB

(54) COMPOSITIONS COMPRISING BACTERIAL STRAINS

- (72) MULDER, Imke Elisabeth, c/o 4D Pharma Research Limited Life Sciences Innovation Building Cornhill Road, Aberdeen Aberdeenshire AB25 2ZS, GB  
 AHMED, Suaad, c/o 4D Pharma Research Limited Life Sciences Innovation Building Cornhill Road, Aberdeen Aberdeenshire AB25 2ZS, GB  
 ETTORRE, Anna, c/o 4D Pharma Research Limited Life Sciences Innovation Building Cornhill Road, Aberdeen Aberdeenshire AB25 2ZS, GB  
 REID, Sarah Anne, c/o 4D Pharma Research Limited Life Sciences Innovation Building Cornhill Road, Aberdeen Aberdeenshire AB25 2ZS, GB  
 DINAN, Ted, Merton French's Walk, Cobh County Cork, IE  
 CRYAN, John, Sunday's Well, Cork, IE

- (51) MKP  
**A61K 31/4985 2006 (97) EP 3793559**  
**A61P 7/00 2006**  
**A61P 27/02 2006**  
**C07D 487/04 2006**

(96) EP 19725298.4 5/10/2019

(97) EP 3793559, 3/24/2021 202112, en

(31)	PCT/CN2018/087249	(32)	17.05.2018	(33)	WO
------	-------------------	------	------------	------	----

(54) SUBSTITUTED DIHYDROPIRAZOLO PYRAZINE CARBOXAMIDE DERIVATIVES

- (72) MÜLLER, Steffen, Mühlenfeld 106, 45472 Mülheim an der Ruhr, DE  
 SCHOHE-LOOP, Rudolf, Arndtstr.10a, 42327 Wuppertal, DE  
 ORTEGA, HERNANDEZ, Nuria, Horather Schanze 6, 42281 Wuppertal, DE  
 SÜSSMEIER, Frank, Baubergerstr.5, 80992 München, DE  
 JIMENEZ NUNEZ, Eloisa, Mozartstrasse 12, 79104 Freiburg im Breisgau, DE  
 BRUMBY, Thomas, Lepsiusstr. 60, 12163 Berlin, DE  
 LINDNER, Niels, Bodelschwingweg 4, 42115 Wuppertal, DE  
 GERDES, Christoph, Düsseldorfer Str. 75, 51063 Köln, DE  
 POOK, Elisabeth, Im Lehmbruch 24, 42109 Wuppertal, DE  
 BUCHMÜLLER, Anja, Baderweg 72a, 45259 Essen, DE  
 GAUGAZ, Fabienne, Zdenka, Ymergatan 26C, 75325 Uppsala, SE  
 LANG, Dieter, Wimmersberger Str.60, 42553 Velbert, DE  
 ZIMMERMANN, Stefanie, Lindenstrasse 125, 40233 Düsseldorf, DE  
 EHRMANN, Alexander, Helmut, Michael, 20 Michaelchris Drive, Waltham, MA 02452, US  
 GERISCH, Michael, Schlieffenstrasse 88, 42329 Wuppertal, DE  
 LEHMANN, Lutz, Gartenstraße 3, 10115 Berlin, DE  
 TIMMERMANN, Andreas, Hebbelstraße 7, 40237 Düsseldorf, DE  
 SCHÄFER, Martina, Gurnemanzpfad 77, 13465 Berlin, DE  
 SCHMIDT, Georg, Wülfrather Str. 36, 42105 Wuppertal, DE

SCHLEMMER, Karl-Heinz, Wildsteig 22 a, 42113 Wuppertal, DE  
 FOLLMANN, Markus, Rosmarinweg 28, 50859 Köln, DE  
 KERSTEN, Elisabeth, Sattlerstr. 21, 42105 Wuppertal, DE  
 WANG, Vivian, 6 Taihe Road, BDA, Beijing, 100176, CN  
 GAO, Xiang, 6 Taihe Road, BDA, Beijing, 100176, CN  
 WANG, Yafeng, 6 Taihe Road, BDA, Beijing, 100176, CN

- (51) MKP  
**A61K 31/553 2006 (97) EP 3788053**  
**A61K 45/06 2006**  
**C07F 9/6561 2006**
- (96) EP 19725457.6 5/3/2019  
 (97) EP 3788053, 3/10/2021 202110, en
- (31) 201862667314 P (32) 04.05.2018 (33) US
- (54) KRAS G12C INHIBITORS AND METHODS OF USING THE SAME  
 (71) AMGEN INC., One Amgen Center Drive, Thousand Oaks, CA 91320-1799, US  
 (72) WURZ, Ryan Paul, One Amgen Center Drive, Thousand Oaks, CA 91320, US  
 CEE, Victor, J., One Amgen Center Drive, Thousand Oaks, CA 91320, US  
 AMEGADZIE, Albert, One Amgen Center Drive, Thousand Oaks, CA 91320, US  
 CHEN, Ning, One Amgen Center Drive, Thousand Oaks, CA 91320, US  
 LANMAN, Brian, Alan, One Amgen Center Drive, Thousand Oaks, CA 91320, US  
 BARTBERGER, Michael, D., One Amgen Center Drive, Thousand Oaks, CA 91320, US

- (51) MKP  
**A61K 31/7125 2006 (97) EP 3790972**  
**A61P 31/14 2006**  
**C12N 15/113 2010**
- (96) EP 19725507.8 5/7/2019  
 (97) EP 3790972, 3/17/2021 202111, en
- (31) 201862668467 P (32) 08.05.2018 (33) US
- (54) GALNAC CONJUGATED MODIFIED OLIGONUCLEOTIDE AS MIR-122 INHIBITOR HAVING HCV ANTIVIRAL ACTIVITY WITH REDUCED HYPERBILIRUBINEMIA SIDE-EFFECT  
 (71) Regulus Therapeutics Inc., 10628 Science Center Drive Suite 225, San Diego CA 92121, US  
 (72) ALLERSON, Charles R., 10628 Science Center Drive Suite 100, San Diego, California 92121, US  
 NEBEN, Steven S., 10628 Science Center Drive Suite 100, San Diego, California 92121, US  
 WRIGHT, Timothy, 10628 Science Center Drive Suite 100, San Diego, California 92121, US

- (51) MKP  
**A61K 47/68 2017 (97) EP 3790899**  
**C07K 16/28 2006**
- (96) EP 19725564.9 5/8/2019  
 (97) EP 3790899, 3/17/2021 202111, en
- (31) 201862669276 P (32) 09.05.2018 (33) US  
 201862678200 P 30.05.2018 US  
 201862769946 P 20.11.2018 US  
 201962789987 P 08.01.2019 US  
 201962821362 P 20.03.2019 US
- (54) ANTI-MSR1 ANTIBODIES AND METHODS OF USE THEREOF  
 (72) KYRATSOUS, Christos, c/o Regeneron Pharmaceuticals, Inc. 777 Old Saw Mill River Road, Tarrytown, New York 10591-6707, US  
 NITTOLI, Thomas, c/o Regeneron Pharmaceuticals, Inc. 777 Old Saw Mill River Road, Tarrytown, New York 10591-6707, US  
 ZUMSTEG, Anna, c/o Regeneron Pharmaceuticals, Inc. 777 Old Saw Mill River Road, Tarrytown, New York 10591-6707, US  
 GROMADA, Jesper, c/o Regeneron Pharmaceuticals, Inc. 777 Old Saw Mill River Road, Tarrytown, New York 10591-6707, US  
 GUSAROVA, Viktoria, c/o Regeneron Pharmaceuticals, Inc. 777 Old Saw Mill River Road, Tarrytown, New York 10591-6707, US  
 HAN, Amy, c/o Regeneron Pharmaceuticals, Inc. 777 Old Saw Mill River Road, Tarrytown, New York 10591-670, US  
 HAXHINASTO, Sokol, c/o Regeneron Pharmaceuticals, Inc. 777 Old Saw Mill River Road, Tarrytown, New York 10591-6707, US  
 MURPHY, Andrew J., c/o Regeneron Pharmaceuticals, Inc. 777 Old Saw Mill River Road, Tarrytown, New York 10591-6707, US  
 OLSON, William, c/o Regeneron Pharmaceuticals, Inc. 777 Old Saw Mill River Road, Tarrytown, New York 10591-6707, US  
 SLEEMAN, Matthew, c/o Regeneron Pharmaceuticals, Inc. 777 Old Saw Mill River Road, Tarrytown, New York 10591-6707, US

- (51) MKP  
**A61K 31/549 2006 (97) EP 3790886**  
**A61P 35/00 2006**  
**C07D 513/04 2006**

(96) EP 19725595.3 5/9/2019  
 (97) EP 3790886, 3/17/2021 202111, en  
 (31) 201862669723 P (32) 10.05.2018 (33) US  
 (54) KRAS G12C INHIBITORS FOR THE TREATMENT OF CANCER  
 (72) MINATTI, Ana Elena, One Amgen Center Drive, Thousand Oaks, California 91320, US  
 LOW, Jonathan D., One Amgen Center Drive, Thousand Oaks, California 91320, US  
 WURZ, Ryan Paul, One Amgen Center Drive, Thousand Oaks, California 91320, US  
 LANMAN, Brian Alan, One Amgen Center Drive, Thousand Oaks, California 91320, US  
 CEE, Victor J., One Amgen Center Drive, Thousand Oaks, California 91320, US  
 BARTBERGER, Michael D., One Amgen Center Drive, Thousand Oaks, California 91320, US  
 CHU-MOYER, Margaret, One Amgen Center Drive, Thousand Oaks, California 91320, US

---

(51) MKP  
**A61K 31/437 2006 (97) EP 3790877**  
**A61P 35/00 2006**  
**A61P 37/00 2006**  
**C07D 471/04 2006**  
 (96) EP 19725627.4 5/10/2019  
 (97) EP 3790877, 3/17/2021 202111, en  
 (31) 201862670249 P (32) 11.05.2018 (33) US  
 201862688164 P 21.06.2018 US  
 (54) TETRAHYDRO-IMIDAZO[4,5-C]PYRIDINE DERIVATIVES AS PD-L1 IMMUNOMODULATORS  
 (72) WU, Liangxing, 1801 Augustine Cut-Off, Wilmington, Delaware 19803, US  
 XIAO, Kaijiong, 1801 Augustine Cut-Off, Wilmington, Delaware 19803, US  
 YAO, Wenqing, 1801 Augustine Cut-Off, Wilmington, Delaware 19803, US

---

(51) MKP  
**A61P 27/02 2006 (97) EP 3790897**  
**C07K 16/18 2006**  
 (96) EP 19725880.9 4/1/2019  
 (97) EP 3790897, 3/17/2021 202111, en  
 (31) 201862652253 P (32) 03.04.2018 (33) US  
 (54) C3-BINDING AGENTS AND METHODS OF USE THEREOF  
 (72) DUEY, Dana Yen Mei, 333 Oyster Point Boulevard South, San Francisco, California 94080, US  
 LIU, Zhonghao, 333 Oyster Point Boulevard South, San Francisco, California 94080, US  
 TANG, Jie, 333 Oyster Point Boulevard South, San Francisco, California 94080, US  
 WANG, Yan, 333 Oyster Point Boulevard South, San Francisco, California 94080, US  
 YIN, Yiyuan, 333 Oyster Point Boulevard South, San Francisco, California 94080, US  
 ZHAI, Wenwu, 333 Oyster Point Boulevard South, San Francisco, California 94080, US  
 HIGBEE, Jared Martin, 333 Oyster Point Boulevard South, San Francisco, California 94080, US

---

(51) MKP  
**B32B 27/36 2006 (97) EP 3797134**  
**C08J 5/18 2006**  
**C08K 9/02 2006**  
**C08K 9/04 2006**  
**C08K 9/06 2006**  
**C09C 1/02 2006**  
 (96) EP 19725953.4 5/15/2019  
 (97) EP 3797134, 3/31/2021 202113, en  
 (31) 18173894 (32) 23.05.2018 (33) EP  
 (54) SURFACE-TREATED FILLERS FOR POLYESTER FILMS  
 (72) KNERR, Michael, Wolfbachring 20, 4665 Oftringen, CH  
 FORNERA, Tazio, Innere Altachen 12, 4800 Zofingen, CH  
 BLANCHARD, Pierre, 63 Chemin de Budron, 01600 Reyrieux, FR  
 SCHULZ, Karsten Udo, Houelbachstrasse 44, 6010 Kriens, CH  
 BRUNNER, Martin, Rosenstrasse 5, 4323 Wallbach, CH  
 ZENDELI, Sulejman, Turbinenstrasse 16, 8400 Winterthur, CH  
 WELKER, Matthias, 11 Rue des Rossignols, 68220 Héisingue, FR

---

(51) MKP  
**E01F 9/588 2016 (97) EP 3781746**

(96) EP 19726152.2 4/18/2019  
 (97) EP 3781746, 2/24/2021 202108, en  
 (31) 201800004701 (32) 19.04.2018 (33) IT  
 (54) IMPROVED LANE SEPARATOR FOR CYCLE PATHS  
 (71) Cognigni, Walter, Via Del Sole 3, 63836 Monte Vidon Corrado (FM), IT  
 (72) Cognigni, Walter, Via Del Sole 3, 63836 Monte Vidon Corrado (FM), IT

---

(51) MKP  
**A61K 31/454 2006 (97) EP 3784663**  
**A61P 35/00 2006**  
**C07D 401/04 2006**  
**C07D 401/14 2006**  
**C07D 417/14 2006**  
**C07D 491/08 2006**  
**C07D 491/10 2006**  
 (96) EP 19726225.6 4/22/2019  
 (97) EP 3784663, 3/3/2021 202109, en  
 (31) 201862661525 P (32) 23.04.2018 (33) US  
 (54) SUBSTITUTED 4-AMINOISOINDOLINE-1,3-DIONE COMPOUNDS AND THEIR USE FOR TREATING LYMPHOMA  
 (72) ALEXANDER, Matthew, D., 10300 Campus Point Drive, Suite 100, San Diego, CA 92121, US  
 CARRANCIO, Soraya, 10300 Campus Point Drive, Suite 100, San Diego, CA 92121, US  
 CORREA, Matthew, D., 10300 Campus Point Drive, Suite 100, San Diego, CA 92121, US  
 GRANT, Virginia Heather, Sharron, 10300 Campus Point Drive, Suite 100, San Diego, CA 92121, US  
 HANSEN, Joshua, 10300 Campus Point Drive, Suite 100, San Diego, CA 92121, US  
 HARRIS, Roy, L., 10300 Campus Point Drive, Suite 100, San Diego, CA 92121, US  
 HUANG, Dehua, 10300 Campus Point Drive, Suite 100, San Diego, CA 92121, US  
 KERCHER, Timothy, S., 10300 Campus Point Drive, Suite 100, San Diego, CA 92121, US  
 LOPEZ-GIRONA, Antonia, 10300 Campus Point Drive, Suite 100, San Diego, CA 92121, US  
 NAGY, Mark, A., 10300 Campus Point Drive, Suite 100, San Diego, CA 92121, US  
 PLANTEVIN-KRENITSKY, Veronique, 10300 Campus Point Drive, Suite 100, San Diego, CA 92121, US

---

(51) MKP  
**A61K 31/553 2006 (97) EP 3784666**  
**A61P 35/00 2006**  
**C07D 403/04 2006**  
**C07D 409/14 2006**  
**C07D 413/04 2006**  
**C07D 413/14 2006**  
 (96) EP 19726792.5 4/23/2019  
 (97) EP 3784666, 3/3/2021 202109, en  
 (31) 201862661719 P (32) 24.04.2018 (33) US  
 (54) ANTIPROLIFERATION COMPOUNDS AND USES THEREOF  
 (71) Merck Patent GmbH, Frankfurter Strasse 250, 64293 Darmstadt, DE  
 (72) YU, Henry, c/o Merck Patent GmbH Frankfurter Strasse 250, 64293 Darmstadt, DE  
 CLARK, Michael, c/o Vertex Pharmaceuticals Incorporated 50 Northern Avenue, Boston, MA 02210, US  
 BEMIS, Guy, c/o Vertex Pharmaceuticals Incorporated 50 Northern Avenue, Boston, MA 02210, US  
 BOYD, Michael, c/o Vertex Pharmaceuticals Incorporated 50 Northern Avenue, Boston, MA 02210, US  
 CHANDUPATLA, Kishan, c/o Vertex Pharmaceuticals Incorporated 50 Northern Avenue, Boston, MA 02210, US  
 COLLIER, Philip, c/o Vertex Pharmaceuticals Incorporated 50 Northern Avenue, Boston, MA 02210, US  
 DENG, Hongbo, 178 Woodland Road, Southborough, MA 01772, US  
 DONG, Huijun, 157 Woodside Lane, Arlington, MA 02474, US  
 DORSCH, Warren, c/o Vertex Pharmaceuticals Incorporated 50 Northern Avenue, Boston, MA 02210, US  
 HOOVER, Russell, R., 17 Simon Atherton Row, Harvard, MA 01451, US  
 JOHNSON, Mac, Arthur, JR., 4 Stoneleigh Drive, Derry, NH 03038, US  
 KUKAMI, Shashank, 1309 Stearns Hill Road, Waltham, MA 02451, US  
 PENNEY, Marina, 11 Putnam Road, Acton, MA 01720, US  
 RONKIN, Steven, c/o Vertex Pharmaceuticals Incorporated 50 Northern Avenue, Boston, MA 02210, US  
 TAKEMOTO, Darin, 91 Channing Road, Belmont, MA 02478, US  
 TANG, Qing, 6 Westside Drive, Acton, MA 01720, US  
 WAAL, Nathan, D., 295 Cardinal Medeiros Avenue, Cambridge, MA 02141, US  
 WANG, Tiansheng, 50 Sarah Way, Concord, MA 01742, US  
 LAUFFER, David J., 254 Taylor Road, Stow, MA 01775, US  
 LI, Pan, 3 Malt Lane, Lexington, MA 02421, US

---



(51) MKP  
**A61K 39/00 2006 (97) EP 3784694**  
**A61P 37/06 2006**  
**C07K 14/725 2006**  
**C07K 14/74 2006**  
**C12N 15/113 2010**  
(96) EP 19726802.2 4/26/2019  
(97) EP 3784694, 3/3/2021 202109, en  
(31) 201862663966 P (32) 27.04.2018 (33) US  
(54) METHODS AND COMPOSITIONS OF CYTOTOXIC T CELL DEPLETION  
(72) STANKOVICH, Basha, c/o Casebia Therapeutics Limited Liability Partnership 455 Mission Bay Boulevard South, San Francisco, CA 94158, US

---

(51) MKP  
**A61K 31/4015 2006 (97) EP 3790859**  
**A61K 31/497 2006**  
**A61P 25/00 2006**  
**C07D 207/20 2006**  
**C07D 209/96 2006**  
**C07D 401/06 2006**  
**C07D 401/12 2006**  
**C07D 471/10 2006**  
**C07D 487/04 2006**  
(96) EP 19726837.8 5/10/2019  
(97) EP 3790859, 3/17/2021 202111, en  
(31) 201862670116 P (32) 11.05.2018 (33) US  
(54) NOVEL FUNCTIONALIZED LACTAMS AS MODULATORS OF THE 5-HYDROXYTRYPTAMINE RECEPTOR 7 AND THEIR METHOD OF USE  
(71) Temple University - Of The Commonwealth System of Higher Education, Broad&Montgomery Avenue, Philadelphia, PA 19122, US  
(72) CANNEY, Daniel, J., 7 Carey Drive, Ambler, PA 19002, US  
BLASS, Benjamin, E., 1029 Clark Hill Drive, Eagleville, PA 19403, US  
BLATTNER, Kevin, M., 116 Cherry Lane, Folsom, PA 19033, US  
PIPPIN, Douglas, A., 6 Phillips Lane, Chester Springs, PA 19425, US

---

(51) MKP  
**A61K 31/472 2006 (97) EP 3790548**  
**A61P 25/08 2006**  
(96) EP 19727216.4 5/10/2019  
(97) EP 3790548, 3/17/2021 202111, en  
(31) 201862670253 P (32) 11.05.2018 (33) US  
(54) METHODS FOR ENHANCING THE BIOAVAILABILITY AND EXPOSURE OF A VOLTAGE-GATED POTASSIUM CHANNEL OPENER  
(72) BEATCH, Gregory N., 6994 Hycroft Road West, Vancouver, British Columbia V7W 2H8, CA

---

(51) MKP  
**A61K 9/00 2006 (97) EP 3790532**  
**A61K 9/08 2006**  
**A61K 38/17 2006**  
**A61K 47/22 2006**  
**A61K 47/26 2006**  
**A61P 27/02 2006**  
(96) EP 19727219.8 5/10/2019  
(97) EP 3790532, 3/17/2021 202111, en  
(31) 201862669506 P (32) 10.05.2018 (33) US  
201862752127 P 29.10.2018 US  
201862769876 P 20.11.2018 US  
201962813882 P 05.03.2019 US  
(54) HIGH CONCENTRATION VEGF RECEPTOR FUSION PROTEIN CONTAINING FORMULATIONS  
(72) GRAHAM, Kenneth S., 218 Robbout Road, Pleasant Valley, NY 12569, US  
WADHWA, Saurabh, 19 Rinne Road, Nanuet, NY 10954, US

---

(51) MKP  
**A61K 38/09 2006 (97) EP 3784346**  
**A61P 5/30 2006**  
(96) EP 19727289.1 4/25/2019  
(97) EP 3784346, 3/3/2021 202109, en

(31) 18169419 (32) 26.04.2018 (33) EP  
 (54) A COMPOSITION FOR TREATING ONE OR MORE ESTROGEN RELATED DISEASES  
 (72) LARSEN, Finn, 18 Forest Road Bronchester Bridge, Hawick TD9 8JS, GB  
 MACLEAN, Carol Marion, 25 Balmuir Avenue West Lothian, Bathgate EH48 4BW, GB

---

(51) MKP  
**A61P 35/00 2006 (97) EP 3784664**  
**C07D 401/14 2006**  
**C07D 405/14 2006**  
**C07D 487/04 2006**  
**C07D 498/04 2006**

(96) EP 19727502.7 4/22/2019

(97) EP 3784664, 3/3/2021 202109, en

(31) 201862663096 P (32) 26.04.2018 (33) US  
 201862750454 P 25.10.2018 US  
 201962826609 P 29.03.2019 US

(54) 2-AMINO-PYRIDINE OR 2-AMINO-PYRIMIDINE DERIVATIVES AS CYCLIN DEPENDENT KINASE INHIBITORS

(72) CHEN, Ping, c/o Pfizer Inc. 10777 Science Center Drive, San Diego, CA 92121, US  
 CHO-SCHULTZ, Sujin, c/o Pfizer Inc. 10777 Science Center Drive, San Diego, CA 92121, US  
 DEAL, Judith Gail, c/o Pfizer Inc. 10777 Science Center Drive, San Diego, CA 92121, US  
 GALLEGO, Gary Michael, c/o Pfizer Inc. 10777 Science Center Drive, San Diego, CA 92121, US  
 JALAI, Mehran, c/o Pfizer Inc. 10777 Science Center Drive, San Diego, CA 92121, US  
 KANIA, Robert Steven, c/o Pfizer Inc. 10777 Science Center Drive, San Diego, CA 92121, US  
 NAIR, Sajiv Krishnan, c/o Pfizer Inc. 10777 Science Center Drive, San Diego, CA 92121, US  
 NINKOVIC, Sacha, c/o Pfizer Inc. 10777 Science Center Drive, San Diego, CA 92121, US  
 ORR, Suvi Tuula Marjukka, c/o Pfizer Inc. 10777 Science Center Drive, San Diego, CA 92121, US  
 PALMER, Cynthia Louise, c/o Pfizer Inc. 10777 Science Center Drive, San Diego, CA 92121, US

---

(51) MKP  
**A61K 35/17 2015 (97) EP 3787751**  
**A61K 39/00 2006**  
**A61P 35/00 2006**

(96) EP 19727541.5 4/30/2019

(97) EP 3787751, 3/10/2021 202110, en

(31) 201862666653 P (32) 03.05.2018 (33) US

(54) COMBINATION THERAPY OF A CHIMERIC ANTIGEN RECEPTOR (CAR) T CELL THERAPY AND A KINASE INHIBITOR

(72) FRANKEL, Stanley, R., 86 Morris Avenue, Summit, New Jersey 07901, US  
 HASSKARL, Jens, Route de Perreux 1, 2017 Boudry, CH  
 DUBOVSKY, Jason A., 400 Dexter Ave. N. Suite 1200, Seattle, Washington 98109, US

---

(51) MKP  
**C07K 16/18 2006 (97) EP 3790904**  
**C07K 16/24 2006**  
**C07K 16/28 2006**  
**C07K 16/46 2006**

(96) EP 19727555.5 5/8/2019

(97) EP 3790904, 3/17/2021 202111, en

(31) 201862668626 P (32) 08.05.2018 (33) US

(54) BISPECIFIC ANTIBODIES WITH CLEAVABLE C-TERMINAL CHARGE-PAIRED TAGS

(72) KAWOONYA, John K, c/o Amgen Inc. One Amgen Center Drive, Thousand Oaks, California 91320-1799, US  
 JACOBITZ, Alex W, c/o Amgen Inc. One Amgen Center Drive, Thousand Oaks, California 91320-1799, US  
 MOHR, Christopher, c/o Amgen Inc. One Amgen Center Drive, Thousand Oaks, California 91320-1799, US  
 SMITH, Stephen, c/o Amgen Inc. One Amgen Center Drive, Thousand Oaks, California 91320-1799, US  
 GRAHAM, Kevin, c/o Amgen Inc. One Amgen Center Drive, Thousand Oaks, California 91320-1799, US  
 LOW, Ray Lih Yoon, c/o Amgen Inc. One Amgen Center Drive, Thousand Oaks, California 91320-1799, US  
 THIEL, Oliver, c/o Amgen Inc. One Amgen Center Drive, Thousand Oaks, California 91320-1799, US  
 ROMANINI, Dante, c/o Amgen Inc. One Amgen Center Drive, Thousand Oaks, California 91320-1799, US  
 WAGNER, Victoria, c/o Amgen Inc. One Amgen Center Drive, Thousand Oaks, California 91320-1799, US  
 AGRAWAL, Neeraj J, c/o Amgen Inc. One Amgen Center Drive, Thousand Oaks, California 91320-1799, US

---

(51) MKP  
**A61K 31/137 2006 (97) EP 3789020**  
**A61K 31/167 2006**

(96) EP 19727583.7 5/3/2019  
 (97) EP 3789020, 3/10/2021 202110, en  
 (31) 20180037 (32) 03.05.2018 (33) CU  
 (54) FIXED DOSE COMPOSITION OF PARACETAMOL: AMITRIPTYLINE AND METHOD FOR THE TREATMENT OF MIXED CANCER PAIN  
 (71) Centro de Investigación y Desarrollo de Medicamentos (CIDEM), Calle 26, No. 1605 entre Boyeros y Puentes Grandes, Nuevo Vedado Plaza de la Revolución, La Habana 10600, CU  
 (72) GARRIDO SUÁREZ, Bárbara Beatriz, Calle 10 No. 15033 altos entre 7ma y D., Reparto Altabana, Boyeros La Habana 10800, CU  
 BELLMA MENÉNDEZ, Addis, Calle Jovellar No. 160 apto 3-13 e/San Francisco y Espada Cayo Hueso, Centro Habana La Habana 10200, CU  
 GONZÁLEZ CORTEZÓN, Ania, Calle 21 No. 802 e/ 2 y 4 apto. 4 Vedado Plaza de la Revolución, La Habana, CU  
 DE LA PAZ MARTÍN-VIAÑA, Nilia, Calle Castanedo No. 168A entre Romay y Venus Guanabacoa, La Habana, CU  
 BÁRZAGA FERNÁNDEZ, Pedro Gilberto, Calle Rosales Edificio 54 Apto. 18 e/ 4ta y 5ta, Reparto Eléctrico. Arroyo Naranjo La Habana 10900, CU  
 PERDOMO MORALES, Rolando, Avenida Porvenir No. 563 Apto. D entre Avenida Dolores y Lawton, Reparto Lawton, 10 de Octubre La Habana 10700, CU  
 PADRÓN YAQUIS, Alejandro Saúl, Calle 174 No. BBC piso 4 apartamento 8 entre Avenida 1ra y Avenida 3ra Playa, La Habana, CU

(51) MKP  
**A61K 31/519 2006 (97) EP 3784670**  
**A61P 35/00 2006**  
**C07D 471/04 2006**  
**C07D 498/04 2006**  
**C07D 513/04 2006**  
**C07D 519/00 2006**  
 (96) EP 19727780.9 4/24/2019  
 (97) EP 3784670, 3/3/2021 202109, en  
 (31) 201862662240 P (32) 25.04.2018 (33) US  
 201862764818 P 16.08.2018 US  
 201962825044 P 28.03.2019 US  
 (54) NLRP3 MODULATORS  
 (72) ZHANG, Yong, c/o Bristol-Myers Squibb Company Route 206 and Province Line Road, Princeton, NJ 08543, US  
 GAVAI, Ashvinikumar V., c/o Bristol-Myers Squibb Company Route 206 and Province Line Road, Princeton, NJ 08543, US  
 DONNELL, Andrew F., c/o Bristol-Myers Squibb Company Route 206 and Province Line Road, Princeton, NJ 08543, US  
 GHOSH, Shomir, 134 Sewall Avenue, Unit 3, Brookline, MA 02446, US  
 ROUSH, William R., 1013 Town Hall Avenue, Jupiter, FL 33458, US  
 SIVAPRAKASAM, Prasanna, c/o Bristol-Myers Squibb Company Route 206 and Province Line Road, Princeton, NJ 08543, US  
 SEITZ, Steven P., 333 Haverford Place, Swarthmore, PA 19081, US  
 MARKWALDER, Jay A., c/o Bristol-Myers Squibb Company Route 206 and Province Line Road, Princeton, NJ 08543, US

(51) MKP  
**A24D 1/14 2006 (97) EP 3790417**  
**A24F 1/30 2006**  
 (96) EP 19727845.0 5/13/2019  
 (97) EP 3790417, 3/17/2021 202111, fr  
 (31) 1853988 (32) 11.05.2018 (33) FR  
 1858022 06.09.2018 FR  
 (54) DEVICE FOR SMOKING A SMOKEABLE MATERIAL  
 (72) SARIAN, Sarkis, C/o ARIES 2095 rue de la Belle Meunière, 26500 BOURG-LES-VALENCE, FR

(51) MKP  
**A24D 1/14 2006 (97) EP 3790415**  
 (96) EP 19727846.8 5/13/2019  
 (97) EP 3790415, 3/17/2021 202111, fr  
 (31) 1853988 (32) 11.05.2018 (33) FR  
 (54) DEVICE FOR SMOKING A SMOKEABLE MATERIAL  
 (71) ARIES, 2095 rue de la Belle Meunière, 26500 Bourg-les-Valence, FR  
 (72) SARIAN, Sarkis, C/o ARIES 2095 rue de la Belle Meunière, 26500 BOURG-LES-VALENCE, FR

(51) MKP  
**B65H 35/00 2006 (97) EP 3781505**  
 (96) EP 19728108.2 5/17/2019  
 (97) EP 3781505, 2/24/2021 202108, en  
 (31) 201808073 (32) 18.05.2018 (33) GB

- (54) DISPENSER APPARATUS FOR ADHESIVE TAPE  
 (71) Xtaper Limited, 1 Michigan Drive, Tongwell Milton Keynes Buckinghamshire MK15 8HQ, GB  
 (72) MAGEE, Marcus, 1 Michigan Drive Tongwell, Milton Keynes Buckinghamshire MK15 8HQ, GB

- (51) MKP  
**A61K 9/127 2006 (97) EP 3794008**  
**A61K 47/26 2006**  
**C07H 13/06 2006**  
**C07H 13/12 2006**  
**C07H 15/04 2006**  
**C07H 15/10 2006**  
**C07H 15/26 2006**

- (96) EP 19728235.3 5/15/2019  
 (97) EP 3794008, 3/24/2021 202112, en

(31)	201862672194 P	(32)	16.05.2018	(33)	US
	201862740095 P		02.10.2018		US
	201862749442 P		23.10.2018		US

- (54) RIBOSE CATIONIC LIPIDS  
 (72) DEROSA, Frank, c/o Translate Bio, Inc. 29 Hartwell Avenue, Lexington, MA 02421, US  
 KARVE, Shrirang, c/o Translate Bio, Inc. 29 Hartwell Avenue, Lexington, MA 02421, US  
 ZHANG, Yi, c/o Translate Bio, Inc. 29 Hartwell Avenue, Lexington, MA 02421, US  
 HEARTLEIN, Michael, c/o Translate Bio, Inc. 29 Hartwell Avenue, Lexington, MA 02421, US

- (51) MKP  
**A61K 38/47 2006 (97) EP 3793591**  
**A61P 43/00 2006**  
**C07K 16/28 2006**  
**C12N 9/34 2006**

- (96) EP 19728288.2 5/17/2019  
 (97) EP 3793591, 3/24/2021 202112, en

(31)	201862673098 P	(32)	17.05.2018	(33)	US
	201862681563 P		06.06.2018		US
	201862777592 P		10.12.2018		US

- (54) ANTI-CD63 ANTIBODIES, CONJUGATES, AND USES THEREOF  
 (72) CYGNAR, Katherine, c/o Regeneron Pharmaceuticals, Inc. 777 Old Saw Mill River Road, Tarrytown, New York 10591, US  
 BAIK, Andrew, c/o Regeneron Pharmaceuticals, Inc. 777 Old Saw Mill River Road, Tarrytown, New York 10591, US  
 SCHOENHERR, Christopher, c/o Regeneron Pharmaceuticals, Inc. 777 Old Saw Mill River Road, Tarrytown, New York 10591, US  
 MURPHY, Andrew J., c/o Regeneron Pharmaceuticals, Inc. 777 Old Saw Mill River Road, Tarrytown, New York 10591, US

- (51) MKP  
**A61K 39/395 2006 (97) EP 3793607**  
**A61K 45/06 2006**  
**A61P 35/00 2006**

- (96) EP 19728320.3 5/14/2019  
 (97) EP 3793607, 3/24/2021 202112, en

(31)	201862671521 P	(32)	15.05.2018	(33)	US
------	----------------	------	------------	------	----

- (54) TREATMENT OF CANCER  
 (72) ABDULLAH, Shaad, Essa, MedImmune, LLC, One MedImmune Way, Gaithersburg, MD 20878, US  
 GUPTA, Ashok, Kumar, MedImmune, LLC, One MedImmune Way, Gaithersburg, MD 20878, US  
 SONG, Xuyang, MedImmune, LLC, One MedImmune Way, Gaithersburg, MD 20878, US

- (51) MKP  
**A61K 31/40 2006 (97) EP 3765011**  
**A61K 31/454 2006**  
**A61K 45/06 2006**

- (96) EP 19729347.5 3/13/2019  
 (97) EP 3765011, 1/20/2021 202103, en

(31)	201862642997 P	(32)	14.03.2018	(33)	US
------	----------------	------	------------	------	----

- (54) CAPSID ASSEMBLY MODULATOR DOSING REGIMEN  
 (72) LENZ, Oliver, c/o Janssen Pharmaceutica NV, Turnhoutseweg 30, 2340 Beerse, BE  
 BALMAIN, Claire Elisabeth, c/o Janssen Pharmaceutica NV, Turnhoutseweg 30, 2340 Beerse, BE  
 SNOEYS, Jan, c/o Janssen Pharmaceutica NV, Turnhoutseweg 30, 2340 Beerse, BE  
 VANDENBOSSCHE, Joris Jozef, c/o Janssen Pharmaceutica NV, Turnhoutseweg 30, 2340 Beerse, BE

VERSTRAETE, Dominique Josiane W., c/o Janssen Pharmaceutica NV, Turnhoutseweg 30, 2340 Beerse, BE  
 YOGARATNAM, Jeysen Zivan, c/o Janssen BioPharma, Inc. 260 E. Grand Avenue, 2nd Floor, South San Francisco, CA 94080, US  
 JANSENS, Maria, c/o Janssen Pharmaceutica NV, Turnhoutseweg 30, 2340 Beerse, BE  
 VANDYCK, Koen, c/o Janssen Pharmaceutica NV, Turnhoutseweg 30, 2340 Beerse, BE  
 VAN DYCKE, Frederic, c/o Janssen Pharmaceutica NV, Turnhoutseweg 30, 2340 Beerse, BE

(51) MKP  
**A61K 31/4162 2006 (97) EP 3787620**  
**A61K 31/4985 2006**  
**A61P 35/00 2006**  
**A61P 35/02 2006**  
 (96) EP 19729355.8 4/29/2019  
 (97) EP 3787620, 3/10/2021 202110, en  
 (31) 201862664356 P (32) 30.04.2018 (33) US  
 (54) COMBINATIONS FOR TREATING CANCER  
 (72) BOIKO, Scott, Astrazeneca Pharmaceuticals LP 1800 Concord Pike, Wilmington, Delaware 19850-5437, US  
 CIDADO, Justin, Astrazeneca Pharmaceuticals LP 1800 Concord Pike, Wilmington, Delaware 19850-5437, US  
 DREW, Lisa, Astrazeneca Pharmaceuticals LP 1800 Concord Pike, Wilmington, Delaware 19850-5437, US  
 PROIA, Theresa, Astrazeneca Pharmaceuticals LP 1800 Concord Pike, Wilmington, Delaware 19850-5437, US  
 SAN MARTIN, Maryann, Astrazeneca Pharmaceuticals LP 1800 Concord Pike, Wilmington, Delaware 19850-5437, US

(51) MKP  
**A61K 47/68 2017 (97) EP 3796942**  
**A61P 35/00 2006**  
**C07K 16/28 2006**  
 (96) EP 19729452.3 5/22/2019  
 (97) EP 3796942, 3/31/2021 202113, en  
 (31) 201808507 (32) 23.05.2018 (33) GB  
 201813067 10.08.2018 GB  
 201818152 07.11.2018 GB  
 (54) MOLECULAR ADJUVANT  
 (71) ADC Therapeutics SA, Biopôle Route de la Corniche 3B, 1066 Epalinges, CH  
 (72) VAN BERKEL, Patrick Hendrikus Cornelis, c/o ADC Therapeutics (UK) Ltd. Queen Mary BioEnterprises Innovation Centre 42 New Road, London E1 2AX, GB  
 FEINGOLD, Jay Marshall, c/o ADC Therapeutics America Inc. 430 Mountain View, 4th Floor, Murray Hill, NJ 07974, US  
 WUERTHNER, Jens, c/o ADC Therapeutics SA Biopôle Route de la Corniche 3B, 1066 Epalinges, CH  
 ADAMS, James, c/o ADC Therapeutics America Inc. 430 Mountain View, 4th Floor, Murray Hill, NJ 07974, US

(51) MKP  
**A61K 9/00 2006 (97) EP 3796889**  
**A61K 9/19 2006**  
**A61K 31/4178 2006**  
**A61K 47/10 2017**  
 (96) EP 19729994.4 5/21/2019  
 (97) EP 3796889, 3/31/2021 202113, en  
 (31) 201862674394 P (32) 21.05.2018 (33) US  
 (54) DANTROLENE FORMULATIONS AND METHODS OF THEIR USE  
 (72) WESCOTT, Charles, c/o Eagle Pharmaceuticals, Inc. 50 Tice Boulevard, Suite 315, Woodcliff Lake, NJ 07677, US  
 COGHLAN, Jill, 23 Village Way, Duxbury, MA 02332, US

(51) MKP  
**G06T 7/136 2017 (97) EP 3791361**  
**G06T 7/143 2017**  
 (96) EP 19730217.7 5/8/2019  
 (97) EP 3791361, 3/17/2021 202111, en  
 (31) 201800005163 (32) 08.05.2018 (33) IT  
 (54) TUMORAL MASS DETECTION SYSTEM BASED ON MAGNETIC RESONANCE IMAGING  
 (71) Università Degli Studi Di Torino, Via Verdi 8, 10124 Torino, IT  
 Fondazione del Piemonte Per L'Oncologia, Strada Provinciale 142 - Km. 3.95, 10060 Candiolo (TO), IT  
 (72) GIANNINI, Valentina, c/o Università Degli Studi Di Torino Via Verdi, 8, 10124 Torino, IT  
 MAZZETTI, Simone, c/o Università Degli Studi Di Torino Via Verdi, 8, 10124 Torino, IT  
 REGGE, Daniele, c/o Università Degli Studi Di Torino Via Verdi, 8, 10124 Torino, IT

(51) MKP  
**A41D 31/00 2019 (97) EP 3796802**  
**D03D 1/00 2006**  
**D03D 11/00 2006**  
**D03D 13/00 2006**  
**D03D 15/00 2021**  
**D03D 15/08 2006**  
**D03D 15/10 2006**

(96) EP 19730549.3 5/17/2019  
(97) EP 3796802, 3/31/2021 202113, en

(31) PCT/IB2018/053519 (32) 18.05.2018 (33) WO

(54) TEXTILE ARTICLE FOR MOTORCYCLIST PROTECTIVE CLOTHING  
(71) Manifattura Pri.Ma.Tex S.r.l., Via Tourcoing 21, 59100 Prato, IT  
(72) PRIAMI, Christian, Via di Lucigliano, 13, 50038 Scarperia E San Pietro, IT  
SCHIOCCHETTO, Simone, Via San Martino in Campo, 4, 50050 Capraia E Limite, IT

(51) MKP  
**A61K 9/127 2006 (97) EP 3796893**  
**A61K 9/51 2006**  
**A61K 31/7088 2006**

(96) EP 19730605.3 5/21/2019  
(97) EP 3796893, 3/31/2021 202113, en

(31) 201862675487 P (32) 23.05.2018 (33) US

(54) DELIVERY OF DNA  
(72) DIMITROV, Stoil, ModernaTX, Inc. 200 Technology Square, Cambridge, Massachusetts 02139, US  
HUANG, Eric, ModernaTX, Inc. 200 Technology Square, Cambridge, Massachusetts 02139, US

(51) MKP  
**A61K 31/519 2006 (97) EP 3788038**  
**A61P 35/00 2006**  
**C07D 403/04 2006**  
**C07D 403/14 2006**  
**C07D 471/04 2006**  
**C07D 487/04 2006**

(96) EP 19731372.9 5/3/2019  
(97) EP 3788038, 3/10/2021 202110, en

(31) 201862667282 P (32) 04.05.2018 (33) US

(54) KRAS G12C INHIBITORS AND METHODS OF USING THE SAME  
(72) ALLEN, John Gordon, One Amgen Center Drive, Thousand Oaks, California 91320, US  
ALLEN, Jennifer Rebecca, One Amgen Center Drive, Thousand Oaks, California 91320, US  
MINATTI, Ana Elena, One Amgen Center Drive, Thousand Oaks, California 91320, US  
XUE, Qiufen, One Amgen Center Drive, Thousand Oaks, California 91320, US  
WURZ, Ryan Paul, One Amgen Center Drive, Thousand Oaks, California 91320, US  
TEGLEY, Christopher M., One Amgen Center Drive, Thousand Oaks, California 91320, US  
PICKRELL, Alexander J., One Amgen Center Drive, Thousand Oaks, California 91320, US  
NGUYEN, Thomas T., One Amgen Center Drive, Thousand Oaks, California 91320, US  
MA, Vu Van, One Amgen Center Drive, Thousand Oaks, California 91320, US  
LOPEZ, Patricia, One Amgen Center Drive, Thousand Oaks, California 91320, US  
LIU, Longbin, One Amgen Center Drive, Thousand Oaks, California 91320, US  
KOPECKY, David John, One Amgen Center Drive, Thousand Oaks, California 91320, US  
FROHN, Michael J., One Amgen Center Drive, Thousand Oaks, California 91320, US  
CHEN, Ning, One Amgen Center Drive, Thousand Oaks, California 91320, US  
CHEN, Jian Jeffrey, One Amgen Center Drive, Thousand Oaks, California 91320, US  
SIEGMUND, Aaron C., One Amgen Center Drive, Thousand Oaks, California 91320, US  
AMEGADZIE, Albert, One Amgen Center Drive, Thousand Oaks, California 91320, US  
TAMAYO, Nuria A., One Amgen Center Drive, Thousand Oaks, California 91320, US  
BOOKER, Shon, One Amgen Center Drive, Thousand Oaks, California 91320, US  
GOODMAN, Clifford, One Amgen Center Drive, Thousand Oaks, California 91320, US  
WALTON, Mary, One Amgen Center Drive, Thousand Oaks, California 91320, US  
NISHIMURA, Nobuko, One Amgen Center Drive, Thousand Oaks, California 91320, US  
SHIN, Youngsook, One Amgen Center Drive, Thousand Oaks, California 91320, US  
LOW, Jonathan D., One Amgen Center Drive, Thousand Oaks, California 91320, US  
CEE, Victor J., One Amgen Center Drive, Thousand Oaks, California 91320, US

REED, Anthony B., One Amgen Center Drive, Thousand Oaks, California 91320, US  
 WANG, Hui-Ling, One Amgen Center Drive, Thousand Oaks, California 91320, US  
 LANMAN, Brian Alan, One Amgen Center Drive, Thousand Oaks, California 91320, US

(51) MKP  
**C07D 211/02 2006 (97) EP 3784655**  
**C07D 211/34 2006**  
 (96) EP 19731448.7 5/29/2019  
 (97) EP 3784655, 3/3/2021 202109, en  
 (31) 201862679586 P (32) 01.06.2018 (33) US  
 (54) PROCESS FOR PREPARING 2-(1-(TERT-BUTOXYCARBONYL)PIPERIDINE-4-YL)BENZOIC ACID  
 (72) RAPTA, Miroslav, 1240 Highland Court, San Carlos, California 94070, US  
 FILIPOV, Dimitar, 6 Megan Drive, San Francisco, California 94134, US

(51) MKP  
**A61K 31/496 2006 (97) EP 3784239**  
**A61K 39/395 2006**  
**A61K 47/68 2017**  
**C07K 16/28 2006**  
**C07K 16/30 2006**  
 (96) EP 19731672.2 6/13/2019  
 (97) EP 3784239, 3/3/2021 202109, en  
 (31) 201809746 (32) 14.06.2018 (33) GB  
 (54) PHARMACEUTICAL COMBINATIONS  
 (72) MERLINO, Giuseppe, Menarini Ricerche SPA via Tito Speri 10, 00071 Pomezia (RM), IT  
 BIGIONI, Mario, Menarini Ricerche SPA via Tito Speri 10, 00071 Pomezia (RM), IT  
 BINASCHI, Monica, Menarini Ricerche SPA via Tito Speri 10, 00071 Pomezia (RM), IT  
 PELLACANI, Andrea, Menarini Ricerche SPA Via dei Sette Santi, 1, 50131 Firenze, IT

(51) MKP  
**G01N 33/50 2006 (97) EP 3785029**  
 (96) EP 19732149.0 4/25/2019  
 (97) EP 3785029, 3/3/2021 202109, en  
 (31) 201862663363 P (32) 27.04.2018 (33) US  
 (54) COMPOSITIONS AND METHODS FOR EVALUATING POTENCY OF LISTERIA-BASED IMMUNOTHERAPEUTICS  
 (72) WALLECHA, Anu, 201 Wildflower Circle, Yardley, Pennsylvania 19067, US  
 GRACE, Mike, c/o Advaxis, Inc. 305 College Road East, Princeton, New Jersey 08540, US

(51) MKP  
**A61K 39/00 2006 (97) EP 3784688**  
**C07K 14/005 2006**  
**C07K 14/19 2006**  
**C07K 14/47 2006**  
 (96) EP 19732758.8 4/25/2019  
 (97) EP 3784688, 3/3/2021 202109, en  
 (31) 201862663083 P (32) 26.04.2018 (33) US  
 201862692009 P 29.06.2018 US  
 (54) HEAT SHOCK PROTEIN-BINDING PEPTIDE COMPOSITIONS AND METHODS OF USE THEREOF  
 (72) FINDEIS, Mark Arthur, 431 School Street, Belmont, Massachusetts 02478, US  
 MORIN, Benjamin Maxime, 18 Gorham Street, Apt. 2, Somerville, Massachusetts 02144, US  
 JOSHI, Bishnu, 9 Captain Parker Arms, Apt. 02, Lexington, Massachusetts 02421, US

(51) MKP  
**A61K 31/53 2006 (97) EP 3793994**  
**A61K 31/55 2006**  
**A61P 37/00 2006**  
**C07D 403/14 2006**  
**C07D 405/14 2006**  
**C07D 413/14 2006**  
 (96) EP 19732766.1 5/13/2019  
 (97) EP 3793994, 3/24/2021 202112, en

(31) 201862671053 P (32) 14.05.2018 (33) US  
 (54) INHIBITING AGENTS FOR BRUTON'S TYROSINE KINASE  
 (72) HOPKINS, Brian, T., c/o Biogen MA Inc. 225 Binney Street, Cambridge, MA 02142, US  
 MA, Bin, c/o Biogen MA Inc. 225 Binney Street, Cambridge, MA 02142, US  
 PRINCE, Robin, c/o Biogen MA Inc. 225 Binney Street, Cambridge, MA 02142, US  
 MARX, Isaac, c/o Biogen MA Inc. 225 Binney Street, Cambridge, MA 02142, US  
 SCHULZ, Jürgen, c/o Biogen MA Inc. 225 Binney Street, Cambridge, MA 02142, US  
 NEVALAINEN, Marta, c/o Biogen MA Inc. 225 Binney Street, Cambridge, MA 02142, US  
 DECHANTSREITER, Michael, c/o Biogen MA Inc. 225 Binney Street, Cambridge, MA 02142, US

---

(51) MKP  
**A61K 31/7034 2006 (97) EP 3794009**  
**A61P 3/10 2006**  
**A61P 25/02 2006**  
**C07D 309/06 2006**  
**C07H 1/00 2006**  
**C07H 15/203 2006**

(96) EP 19732770.3 5/14/2019  
 (97) EP 3794009, 3/24/2021 202112, en

(31) 201862671047 P (32) 14.05.2018 (33) US  
 (54) BIARYL AMIDES WITH MODIFIED SUGAR GROUPS FOR TREATMENT OF DISEASES ASSOCIATED WITH HEAT SHOCK PROTEIN PATHWAY  
 (72) JIANG, Xin, c/o Reata Pharmaceuticals, Inc. 2801 Gateway Drive, Suite 150, Irving, TX 75083-2648, US  
 VISNICK, Melean, c/o Reata Pharmaceuticals, Inc. 2801 Gateway Drive, Suite 150, Irving, TX 75063-2648, US  
 BENDER, Christopher, F., c/o Reata Pharmaceuticals, Inc. 2801 Gateway Drive, Suite 150, Irving, TX 75063-2648, US  
 BOLTON, Gary, c/o Reata Pharmaceuticals, Inc. 2801 Gateway Drive, Suite 150, Irving, TX 75063-2648, US  
 CAPRATHE, Bradley, c/o Reata Pharmaceuticals, Inc. 2801 Gateway Drive, Suite 150, Irving, TX 75063-2648, US  
 LEE, Chitase, c/o Reata Pharmaceuticals, Inc. 2801 Gateway Drive, Suite 150, Irving, TX 75063-2648, US

---

(51) MKP  
**A61K 38/36 2006 (97) EP 3793588**  
**A61K 38/37 2006**  
**A61P 7/04 2006**

(96) EP 19732781.0 5/17/2019  
 (97) EP 3793588, 3/24/2021 202112, en

(31) 201862673670 P (32) 18.05.2018 (33) US  
 201862712880 P 31.07.2018 US  
 201862773785 P 30.11.2018 US  
 201962801576 P 05.02.2019 US

(54) METHODS OF TREATING HEMOPHILIA A  
 (72) INNES, Alison, c/o Bioverativ Therapeutics Inc. 225 Second Avenue, Waltham, Massachusetts 02451, US  
 KATRAGADDA, Suresh, c/o Bioverativ Therapeutics Inc. 225 Second Avenue, Waltham, Massachusetts 02451, US  
 RICE, Kara, c/o Bioverativ Therapeutics Inc. 225 Second Avenue, Waltham, Massachusetts 02451, US  
 RUDIN, Dan, c/o Bioverativ Therapeutics Inc. 225 Second Avenue, Waltham, Massachusetts 02451, US  
 SETH CHHABRA, Ekta, 1550 Worcester Road, Unit 128, Framingham, Massachusetts 01702, US  
 WONG, Nancy, c/o Bioverativ Therapeutics Inc. 225 Second Avenue, Waltham, Massachusetts 02451, US

---

(51) MKP  
**A61K 47/60 2017 (97) EP 3796940**  
**A61P 37/00 2006**

(96) EP 19732788.5 5/20/2019  
 (97) EP 3796940, 3/31/2021 202113, en

(31) 201862674244 P (32) 21.05.2018 (33) US  
 (54) SELECTIVE TREG STIMULATOR RUR20KD-IL-2 AND RELATED COMPOSITIONS  
 (72) KIRK, Peter Benedict, 55 High Street Drayton, Abingdon Oxfordshire OX14 4JW, GB  
 LANGOWSKI, John L, 22 Piedmont Court, Piedmont, California 94611, US  
 ZALEVSKY, Jonathan, 34 Oak Ridge Lane, Orinda, California 94563, US

---

(51) MKP  
**A61K 38/51 2006 (97) EP 3794126**  
**A61K 48/00 2006**  
**C12N 15/62 2006**  
**C12N 15/86 2006**



(96)	EP 19733578.9	5/15/2019					
(97)	EP 3794126,	3/24/2021	202112,	en			
(31)	201862671944 P		(32)	15.05.2018	(33)	US	
	201862681891 P			07.06.2018		US	
	201862684384 P			13.06.2018		US	
	201862691748 P			29.06.2018		US	
	201862698419 P			16.07.2018		US	
	201862703137 P			25.07.2018		US	
	201862741021 P			04.10.2018		US	
	201862748119 P			19.10.2018		US	
	201862756897 P			07.11.2018		US	
	201962789909 P			08.01.2019		US	
	201962831400 P			09.04.2019		US	
(54)	COMPOSITIONS AND METHODS FOR THE TREATMENT OF PARKINSON'S DISEASE						
(72)	RAVINA, Bernard, 8 Meadowbrook Road, Newton, Massachusetts 02459, US KELLS, Adrian Philip, 2583 Chester Rd., Upper Arlington, Ohio 43221, US						

(51)	MKP						
	<b>B29C 64/106</b>	<b>2017</b>	<b>(97) EP 3784472</b>				
	<b>B29C 64/118</b>	<b>2017</b>					
	<b>B29C 64/245</b>	<b>2017</b>					
	<b>B29C 64/379</b>	<b>2017</b>					
	<b>B29C 64/40</b>	<b>2017</b>					
	<b>B33Y 10/00</b>	<b>2015</b>					
	<b>B33Y 70/00</b>	<b>2020</b>					
(96)	EP 19734940.0	4/23/2019					
(97)	EP 3784472,	3/3/2021	202109,	en			
(31)	201862661553 P		(32)	23.04.2018	(33)	US	
	201862661903 P			24.04.2018		US	
(54)	METHOD AND APPARATUS FOR ADDITIVE MANUFACTURING						
(72)	RIHA, David, 3003 Pinex Lane, Knoxville, Tennessee 37921, US FIECHTER, Alexis, 1636 N. Wilbur, Mesa, Arizona 85201, US BEDSOLE, Robert, 112 S. Gay St 403, Knoxville, Tennessee 37902, US HILL, Charles, 122 Hardin Drive, Tipton, North Carolina 28781, US NOVIKOV, Timofei, 1006 Dawn Drive, Friendsville, Tennessee 37737, US ROWE, Kyle, 6516 Pine Grove Road, Knoxville, Tennessee 37914, US						

(51)	MKP						
	<b>A61K 39/00</b>	<b>2006</b>	<b>(97) EP 3793599</b>				
	<b>A61K 39/395</b>	<b>2006</b>					
	<b>A61K 45/06</b>	<b>2006</b>					
	<b>C07K 16/28</b>	<b>2006</b>					
	<b>C07K 16/30</b>	<b>2006</b>					
(96)	EP 19739378.8	5/15/2019					
(97)	EP 3793599,	3/24/2021	202112,	en			
(31)	201862672222 P		(32)	16.05.2018	(33)	US	
	201862736804 P			26.09.2018		US	
	201962842080 P			02.05.2019		US	
(54)	BCMA/CD3 AND GPRDC5D/CD3 BISPECIFIC ANTIBODIES FOR USE IN CANCER THERAPY						
(72)	ADAMS, Homer, 1400 McKean Road, Spring House, PA 19477, US GAUDET, Francois, 1400 McKean Road, Spring House, PA 19477, US FRERICHS, Kris, De Boelelaan 1085, 1081 HV Amsterdam, NL VAN DE DONK, Niels, De Boelelaan 1085, 1081 HV Amsterdam, NL VERKLEIJ, Christie, De Boelelaan 1085, 1081 HV Amsterdam, NL						

(51)	MKP						
	<b>A01N 25/10</b>	<b>2006</b>	<b>(97) EP 3793358</b>				
	<b>A01N 25/34</b>	<b>2006</b>					
	<b>A01N 35/04</b>	<b>2006</b>					
	<b>A01N 37/24</b>	<b>2006</b>					
	<b>A01N 65/12</b>	<b>2009</b>					
	<b>A01N 65/20</b>	<b>2009</b>					
	<b>A01N 65/48</b>	<b>2009</b>					
	<b>A01P 1/00</b>	<b>2006</b>					

**A61K 9/20 2006**  
**A61K 31/11 2006**  
**A61K 31/167 2006**  
**A61K 36/28 2006**  
**A61K 36/484 2006**  
**A61K 36/9062 2006**

- (96) EP 19739727.6 5/17/2019  
 (97) EP 3793358, 3/24/2021 202112, en  
 (31) 2018118348 (32) 18.05.2018 (33) RU  
 (54) ANTIMICROBIAL COMPOSITION BASED ON POLYPHENOLS AND POLYSACCHARIDES, METHOD FOR PREPARING THEREOF AND USE OF THE SAME  
 (72) NESTERENKO, Vladimir Georgievich, Kamergersky per., 2-35, Moscow, 125009, RU  
 SUSLOV, Anatoly Petrovich, ul. Berzarina, 28A-3-118, Moscow, 123060, RU  
 TSYRULNIKOV, Sergey Alexandrovich, ul. Generala Glagoleva, 30-4-497, Moscow, 123154, RU  
 NENASHEV, Mikhail Nikolaevich, ul. Mitinskaya, 40-1-197, Moscow, 125430, RU  
 KISELEVA, Irina Vladislavovna, ul. Molodezhnaya8 -116 Moscow reg., Odintsovsky r-n, Lesnoy Gorodok dp, 143080, RU  
 KUZNETSOV, Vitaly Vladimirovich, ul. Klyazminskaya, 4-30, Moscow, 125412, RU  
 KONOPLEVA, Maria Veniaminovna, Borovskoe sh., 19-285, Moscow, 119633, RU

- (51) MKP  
**A61K 31/365 2006 (97) EP 3790545**  
**A61K 31/551 2006**  
**A61K 45/06 2006**  
 (96) EP 19742516.8 7/17/2019  
 (97) EP 3790545, 3/17/2021 202111, en  
 (54) METHODS AND COMPOSITIONS FOR THE TREATMENT OF SICKLE CELL DISEASES AND THALASSEMIA  
 (71) EMMAUS MEDICAL, INC., 21250 Hawthorne Blvd., Suite 800, Torrance CA 90503, US  
 (72) NIIHARA, Yutaka, 24 Covered Wagon Lane, Rolling Hills Estates CA 90274, US

- (51) MKP  
**A61P 3/00 2006 (97) EP 3787746**  
**C07K 16/28 2006**  
 (96) EP 19742647.1 4/29/2019  
 (97) EP 3787746, 3/10/2021 202110, en  
 (31) 201862664882 P (32) 30.04.2018 (33) US  
 (54) CANNABINOID RECEPTOR TYPE 1 (CB1) BINDING PROTEINS AND USES THEREOF  
 (71) Takeda Pharmaceutical Company Limited, 1-1, Doshomachi 4-chome Chuo-ku, Osaka-shi, Osaka 541-0045, JP  
 (72) BANERJEE, Antara, 10410 Science Center Drive, San Diego, CA 92121, US  
 FANJUL, Andrea, 10410 Science Center Drive, San Diego, CA 92121, US  
 HOEY, Robert, J., 10410 Science Center Drive, San Diego, CA 92121, US  
 SACHEN, Kacey, 10410 Science Center Drive, San Diego, CA 92121, US  
 SUSLOV, Nikolai, 10410 Science Center Drive, San Diego, CA 92121, US

- (51) MKP  
**A61K 9/28 2006 (97) EP 3662900**  
**A61K 31/606 2006**  
 (96) EP 18211141.9 12/7/2018  
 (97) EP 3662900, 1/20/2021 202103, en  
 (54) COLONIC DRUG DELIVERY FORMULATION  
 (72) VARUM, Felipe, c/o Tillotts Pharma AG Baslerstrasse 15, 4310 Rheinfelden, CH  
 BRAVO GONZALEZ, Roberto Carlos, c/o Tillotts Pharma AG Baslerstrasse 15, 4310 Rheinfelden, CH

- (51) MKP  
**A61K 9/20 2006 (97) EP 3662898**  
**A61K 9/28 2006**  
**A61K 31/606 2006**  
 (96) EP 18211145.0 12/7/2018  
 (97) EP 3662898, 1/20/2021 202103, en  
 (54) SOLID COMPOSITION COMPRISING MESALAZINE  
 (72) BUSER, Thomas, Gempenstrasse 19, CH-4412 Nuglar, CH  
 CETINKAYA-COSKUN, Yalcin, c/o Tillotts Pharma AG Baslerstrasse 15, 4310 Rheinfelden, CH  
 BRAVO GONZÁLEZ, Roberto Carlos, c/o Tillotts Pharma AG Baslerstrasse 15, 4310 Rheinfelden, CH

- (51) MKP  
**A61K 9/16 2006 (97) EP 3662895**  
**A61K 9/20 2006**  
**A61K 31/606 2006**
- (96) EP 18211148.4 12/7/2018  
(97) EP 3662895, 1/20/2021 202103, en
- (54) A PROCESS FOR MANUFACTURING REDUCING SUGAR-FREE 5-ASA TABLET CORES
- (72) BRUNO, Cristina, c/o Tillotts Pharma AG Baslerstrasse 15, 4310 Rheinfelden, CH  
VARUM, Felipe, c/o Tillotts Pharma AG Baslerstrasse 15, 4310 Rheinfelden, CH  
BUSER, Thomas, Gempenstrasse 19, CH-4412 Nuglar, CH  
CETINKAYA-COSKUN, Yalcin, c/o Tillotts Pharma AG Baslerstrasse 15, 4310 Rheinfelden, CH  
BRAVO GONZÁLEZ, Roberto Carlos, c/o Tillotts Pharma AG Baslerstrasse 15, 4310 Rheinfelden, CH
- 

- (51) MKP  
**A61K 9/20 2006 (97) EP 3662901**  
**A61K 9/28 2006**  
**A61K 9/48 2006**  
**A61K 31/606 2006**
- (96) EP 18211152.6 12/7/2018  
(97) EP 3662901, 1/20/2021 202103, en
- (54) DELAYED RELEASE DRUG FORMULATION COMPRISING AN OUTERLAYER WITH AN ENZYMATICAALY DEGRADABLE POLYMER, ITS COMPOSITION AND ITS METHOD OF MANUFACTURING
- (72) VARUM, Felipe, c/o Tillotts Pharma AG Baslerstrasse 15, 4310 Rheinfelden, CH  
VON ROCHOW, Laetitia, c/o Tillotts Pharma AG Baslerstrasse 15, 4310 Rheinfelden, CH  
FÜLLER, Carsten Markus, c/o Tillotts Pharma AG Baslerstrasse 15, 4310 Rheinfelden, CH  
BRAVO GONZÁLEZ, Roberto Carlos, c/o Tillotts Pharma AG Baslerstrasse 15, 4310 Rheinfelden, CH
- 

- (51) MKP  
**A61K 9/28 2006 (97) EP 3662902**
- (96) EP 18211154.2 12/7/2018  
(97) EP 3662902, 1/13/2021 202102, en
- (54) COLONIC DRUG DELIVERY FORMULATION
- (72) VARUM, Felipe, c/o Tillotts Pharma AG Baslerstrasse 15, 4310 Rheinfelden, CH  
BRAVO GONZÁLEZ, Roberto Carlos, c/o Tillotts Pharma AG Baslerstrasse 15, 4310 Rheinfelden, CH
- 

- (51) MKP  
**F04C 18/02 2006 (97) EP 3667086**  
**F04C 27/00 2006**  
**F04C 29/00 2006**
- (96) EP 18212076.6 12/12/2018  
(97) EP 3667086, 1/27/2021 202104, de
- (54) SPIRAL-TYPE DISPLACEMENT MACHINE, IN PARTICULAR A DISPLACEMENT MACHINE FOR A VEHICLE AIR-CONDITIONING SYSTEM
- (72) RYMA, Dennis, Am Bremig 11, 97228 Rottendorf, DE.

**INDEKS BROJEVA ZAHTJEVA ZA PROŠIRENJE EVROPSKIH PRIJAVA PATENTA**  
**Index on number of requests for extension on european patent application**  
**Indeks brojeva zahtjeva za proširenje evropskih prijava patenta**

Broj objave evropske prijava patenta (97)	MKP (51)
3162362	<b>A61K 9/20</b> (2006.01) <b>A61K 9/28</b> (2006.01) <b>A61K 31/606</b> (2006.01)
3153124	<b>A61B 18/00</b> (2006.01) <b>A61B 18/02</b> (2006.01) <b>A61B 18/14</b> (2006.01)
3250052	<b>A23L 2/52</b> (2006.01) <b>A23L 2/60</b> (2006.01) <b>A23L 27/12</b> (2016.01)
3250053	<b>A23L 2/52</b> (2006.01) <b>A23L 2/60</b> (2006.01) <b>A23L 27/12</b> (2016.01)
3644620	<b>G10K 11/178</b> (2006.01) <b>H04R</b> (2006.01) <b>H04R 1/10</b> (2006.01) <b>H04R 1/28</b> (2006.01)
3679949	<b>A61K 39/395</b> (2006.01) <b>A61P 19/02</b> (2006.01) <b>A61P 29/00</b> (2006.01) <b>C07K 16/28</b> (2006.01) <b>C12Q 1/48</b> (2006.01) <b>G01N 33/564</b> (2006.01)
3686524	<b>F25D 3/12</b> (2006.01) <b>F25D 11/00</b> (2006.01) <b>F25D 17/06</b> (2006.01) <b>F25D 29/00</b> (2006.01)
3536342	<b>A61K 39/395</b> (2006.01) <b>A61P 31/16</b> (2006.01)
3693652	<b>F17C 6/00</b> (2006.01)
3696188	<b>A01H 5/06</b> (2018.01) <b>A01H 6/02</b> (2018.01) <b>C07K 14/415</b> (2006.01) <b>C12N 15/82</b> (2006.01)
3629719	<b>A01K 67/027</b> (2006.01) <b>C12N 9/02</b> (2006.01) <b>C12N 15/10</b> (2006.01) <b>C12N 15/90</b> (2006.01)
3761965	<b>A61K 9/16</b> (2006.01) <b>A61K 9/20</b> (2006.01)
3762336	<b>C02F 1/34</b> (2006.01)

Broj objave evropske prijave patenta (97)	MKP (51)
3781777	<b>E21B 7/04</b> (2006.01) <b>E21B 7/06</b> (2006.01)
3794210	<b>E21B 23/04</b> (2006.01) <b>E21B 43/10</b> (2006.01)
3781781	<b>E21B 33/12</b> (2006.01) <b>E21B 33/122</b> (2006.01) <b>E21B 33/124</b> (2006.01) <b>E21B 37/02</b> (2006.01) <b>E21B 49/00</b> (2006.01)
3765791	<b>F23B 80/04</b> (2006.01) <b>F23G 5/027</b> (2006.01) <b>F23G 5/16</b> (2006.01)
3781782	<b>E21B 43/12</b> (2006.01) <b>E21B 43/14</b> (2006.01) <b>E21B 43/32</b> (2006.01) <b>E21B 47/10</b> (2012.01) <b>E21B 47/12</b> (2012.01)
3586867	<b>A61K 38/18</b> (2006.01) <b>A61P 21/00</b> (2006.01) <b>C07K 14/515</b> (2006.01)
3631012	<b>C12Q 1/6855</b> (2018.01)
3794211	<b>E21B 7/14</b> (2006.01) <b>E21B 7/15</b> (2006.01) <b>E21B 43/11</b> (2006.01)
3797080	<b>B65G 5/00</b> (2006.01) <b>E21B 43/12</b> (2006.01)
3797209	<b>E21B 43/26</b> (2006.01)
3770066	<b>B64C 39/02</b> (2006.01)
3775165	<b>A01N 1/02</b> (2006.01) <b>A61K 35/17</b> (2015.01) <b>C12M 3/00</b> (2006.01) <b>C12N 5/0783</b> (2010.01)
3699322	<b>C25B 1/04</b> (2006.01) <b>C25B 9/06</b> (2006.01) <b>C25B 11/02</b> (2006.01) <b>C25B 15/08</b> (2006.01) <b>F02B 43/10</b> (2006.01) <b>F02M 25/12</b> (2006.01)
3534343	<b>G08B 5/36</b> (2006.01) <b>G08B 5/38</b> (2006.01)
3617227	<b>A61K 39/40</b> (2006.01) <b>A61P 31/04</b> (2006.01) <b>C07K 16/12</b> (2006.01)

Broj objave evropske prijava patenta (97)	MKP (51)
3536712	<b>A61P 3/06</b> (2006.01) <b>C07K 16/40</b> (2006.01)
3708990	<b>B61L 23/04</b> (2006.01) <b>G01L 1/24</b> (2006.01) <b>G01L 19/06</b> (2006.01) <b>G01M 5/00</b> (2006.01)
3788231	<b>E21B 36/00</b> (2006.01) <b>E21B 43/26</b> (2006.01)
3797206	<b>E21B 28/00</b> (2006.01) <b>E21B 43/00</b> (2006.01) <b>E21B 43/11</b> (2006.01) <b>E21B 43/26</b> (2006.01)
3797290	<b>G01N 27/74</b> (2006.01) <b>G01N 33/28</b> (2006.01) <b>G01V 3/10</b> (2006.01)
3791177	<b>G01N 22/00</b> (2006.01) <b>G01N 33/18</b> (2006.01) <b>G01N 33/24</b> (2006.01) <b>G01N 33/28</b> (2006.01)
3691996	<b>C01D 3/06</b> (2006.01) <b>C02F 1/26</b> (2006.01)
3699194	<b>A61K 39/395</b> (2006.01) <b>A61K 47/68</b> (2017.01) <b>A61P 35/00</b> (2006.01) <b>C07K 16/28</b> (2006.01) <b>C07K 16/30</b> (2006.01) <b>C07K 16/46</b> (2006.01)
3689873	<b>A61K 31/437</b> (2006.01) <b>A61K 31/501</b> (2006.01) <b>A61K 31/506</b> (2006.01) <b>A61P 35/00</b> (2006.01) <b>C07D 471/04</b> (2006.01)
3660010	<b>A61K 31/55</b> (2006.01) <b>A61P 25/00</b> (2006.01) <b>C07D 211/34</b> (2006.01) <b>C07D 211/60</b> (2006.01) <b>C07D 211/62</b> (2006.01) <b>C07D 401/06</b> (2006.01) <b>C07D 405/12</b> (2006.01)
3659613	<b>A61K 35/74</b> (2015.01) <b>A61P 29/00</b> (2006.01) <b>A61P 35/00</b> (2006.01)
3647783	<b>C12Q 1/68</b> (2018.01) <b>G01N 33/50</b> (2006.01) <b>G01N 33/569</b> (2006.01)
3647510	<b>E04F 10/08</b> (2006.01)
3662931	<b>A61K 39/00</b> (2006.01) <b>A61K 39/395</b> (2006.01) <b>A61P 25/28</b> (2006.01)

Broj objave evropske prijava patenta (97)	MKP (51)
	<b>C07K 14/47</b> (2006.01) <b>C07K 16/18</b> (2006.01) <b>C07K 16/46</b> (2006.01) <b>C12N 15/02</b> (2006.01) <b>C12P 21/08</b> (2006.01)
3662912	<b>A61K 31/7125</b> (2006.01) <b>A61P 21/00</b> (2006.01)
3686190	<b>A61K 31/395</b> (2006.01) <b>A61P 35/00</b> (2006.01) <b>C07D 251/18</b> (2006.01) <b>C07D 401/04</b> (2006.01) <b>C07D 403/04</b> (2006.01) <b>C07D 405/14</b> (2006.01) <b>C07D 409/04</b> (2006.01) <b>C07D 417/04</b> (2006.01)
3686218	<b>A61P 1/04</b> (2006.01) <b>A61P 13/12</b> (2006.01) <b>C07K 16/28</b> (2006.01)
3666796	<b>A61P 37/00</b> (2006.01) <b>C07K 16/30</b> (2006.01)
3670537	<b>A61K 39/395</b> (2006.01) <b>A61P 35/00</b> (2006.01) <b>C07K 16/28</b> (2006.01) <b>C07K 16/30</b> (2006.01)
3702351	<b>A61K 31/4184</b> (2006.01) <b>A61P 35/00</b> (2006.01) <b>C07D 235/06</b> (2006.01)
3660040	<b>A61K 38/28</b> (2006.01) <b>A61K 47/60</b> (2017.01) <b>C07K 14/62</b> (2006.01)
3660041	<b>A61K 38/28</b> (2006.01) <b>A61K 47/60</b> (2017.01) <b>C07K 14/62</b> (2006.01)
3666792	<b>A61K 38/28</b> (2006.01) <b>A61K 47/60</b> (2017.01) <b>C07K 14/62</b> (2006.01)
3763738	<b>A61K 47/00</b> (2006.01) <b>A61P 35/00</b> (2006.01) <b>C07K 16/28</b> (2006.01)
3685854	<b>A61K 39/00</b> (2006.01) <b>A61K 39/395</b> (2006.01) <b>A61K 47/60</b> (2017.01) <b>A61K 51/10</b> (2006.01) <b>A61P 25/28</b> (2006.01) <b>C07K 16/18</b> (2006.01) <b>C12N 15/63</b> (2006.01) <b>G01N 33/68</b> (2006.01)
3682798	<b>A61B 5/00</b> (2006.01) <b>A61B 5/024</b> (2006.01) <b>A61B 5/0245</b> (2006.01)

Broj objave evropske prijava patenta (97)	MKP (51)
	<b>A61B 5/0456</b> (2006.01) <b>A61B 5/0464</b> (2006.01) <b>A61B 5/11</b> (2006.01) <b>A61N 1/36</b> (2006.01) <b>G16H 40/63</b> (2018.01)
3679802	<b>A01J 25/12</b> (2006.01) <b>A23C 19/068</b> (2006.01)
3689878	<b>A61K 31/4985</b> (2006.01) <b>A61P 19/08</b> (2006.01) <b>A61P 29/00</b> (2006.01) <b>A61P 31/00</b> (2006.01) <b>A61P 35/00</b> (2006.01) <b>A61P 37/00</b> (2006.01) <b>C07D 487/04</b> (2006.01) <b>C07D 519/00</b> (2006.01)
3693361	<b>A61K 31/4965</b> (2006.01) <b>A61P 11/00</b> (2006.01) <b>C07D 239/48</b> (2006.01)
3690049	<b>A61K 31/7088</b> (2006.01) <b>A61K 31/713</b> (2006.01) <b>A61K 47/54</b> (2017.01) <b>A61K 47/59</b> (2017.01) <b>A61P 3/06</b> (2006.01) <b>A61P 25/00</b> (2006.01) <b>A61P 43/00</b> (2006.01) <b>C12N 15/113</b> (2010.01)
3696183	<b>A61K 31/407</b> (2006.01) <b>A61P 25/16</b> (2006.01) <b>C07D 495/04</b> (2006.01)
3689344	<b>A61K 9/00</b> (2006.01) <b>A61K 9/08</b> (2006.01) <b>A61K 31/277</b> (2006.01) <b>A61K 47/12</b> (2006.01) <b>A61K 47/18</b> (2017.01) <b>A61K 47/20</b> (2006.01) <b>A61P 9/00</b> (2006.01) <b>A61P 9/06</b> (2006.01) <b>A61P 9/10</b> (2006.01) <b>A61P 25/06</b> (2006.01) <b>C07C 255/42</b> (2006.01)
3696262	<b>A61P 37/06</b> (2006.01) <b>C12N 5/0783</b> (2010.01)
3671503	<b>G06F 21/32</b> (2013.01) <b>G06F 21/62</b> (2013.01) <b>G06F 21/64</b> (2013.01) <b>H04L 9/32</b> (2006.01) <b>H04L 29/06</b> (2006.01)
3693391	<b>A61K 31/00</b> (2006.01) <b>A61K 47/68</b> (2017.01) <b>A61K 51/00</b> (2006.01) <b>A61P 35/00</b> (2006.01) <b>A61P 35/02</b> (2006.01) <b>C07K 16/28</b> (2006.01)



Broj objave evropske prijave patenta (97)	MKP (51)
	<b>C07K 16/30</b> (2006.01)
3693397	<b>A61K 39/395</b> (2006.01) <b>A61K 47/65</b> (2017.01) <b>A61P 35/00</b> (2006.01) <b>C07K 16/10</b> (2006.01) <b>C07K 16/46</b> (2006.01) <b>C12N 15/62</b> (2006.01)
3630289	<b>A61K 9/00</b> (2006.01) <b>A61K 9/20</b> (2006.01) <b>A61K 31/423</b> (2006.01) <b>A61K 31/428</b> (2006.01) <b>A61P 25/00</b> (2006.01) <b>A61P 25/16</b> (2006.01) <b>A61P 25/28</b> (2006.01) <b>A61P 43/00</b> (2006.01)
3633187	<b>F03D 5/04</b> (2006.01) <b>F03D 7/00</b> (2006.01) <b>F03D 7/02</b> (2006.01)
3630772	<b>A61K 31/13</b> (2006.01) <b>A61K 31/27</b> (2006.01) <b>A61K 31/444</b> (2006.01) <b>C07D 487/04</b> (2006.01)
3630962	<b>C07K 14/195</b> (2006.01) <b>C07K 14/405</b> (2006.01) <b>C12N 9/04</b> (2006.01) <b>C12N 15/00</b> (2006.01) <b>C12N 15/53</b> (2006.01) <b>C12N 15/62</b> (2006.01)
3630738	<b>C07C 311/07</b> (2006.01) <b>C07D 271/06</b> (2006.01)
3674320	<b>C07K 16/28</b> (2006.01) <b>C07K 16/46</b> (2006.01)
3633549	<b>G06K 9/62</b> (2006.01)
3631074	<b>A47L 15/42</b> (2006.01) <b>D06F 39/00</b> (2020.01) <b>D06F 39/14</b> (2006.01) <b>E05B 15/02</b> (2006.01) <b>E05B 15/04</b> (2006.01) <b>E05B 47/00</b> (2006.01) <b>E05C 3/24</b> (2006.01) <b>E05C 5/02</b> (2006.01)
3629879	<b>A47L 15/42</b> (2006.01) <b>D06F 34/22</b> (2020.01)
3631253	<b>A47L 15/42</b> (2006.01)
3799553	<b>A45D 19/02</b> (2006.01) <b>A61K 8/92</b> (2006.01) <b>A61Q 5/06</b> (2006.01)

---

Broj objave evropske prijava patenta (97)	MKP (51)
3783151	<b>E01B 29/32</b> (2006.01)
3782869	<b>B61L 3/00</b> (2006.01) <b>B61L 27/00</b> (2006.01)
3792220	<b>C01B 17/765</b> (2006.01) <b>C01B 17/775</b> (2006.01) <b>C01B 17/80</b> (2006.01) <b>C01B 17/90</b> (2006.01)
3795797	<b>E21D 9/00</b> (2006.01)
3659621	<b>A61K 31/506</b> (2006.01) <b>A61K 39/395</b> (2006.01) <b>A61P 35/00</b> (2006.01) <b>C07K 16/28</b> (2006.01)
3660050	<b>A61P 35/00</b> (2006.01) <b>C07K 16/28</b> (2006.01)
3785642	<b>A61B 17/00</b> (2006.01)
3793157	<b>H04L 29/06</b> (2006.01)
3793158	<b>H04L 29/06</b> (2006.01)
3793781	<b>B25J 9/16</b> (2006.01)
3681001	<b>H02G 3/06</b> (2006.01)
3770498	<b>A01M 15/00</b> (2006.01) <b>F23D 14/38</b> (2006.01) <b>F23D 14/46</b> (2006.01) <b>F23Q 3/00</b> (2006.01)
3795965	<b>G01K 1/14</b> (2021.01) <b>G01K 1/16</b> (2006.01)
3699921	<b>G16H 20/40</b> (2018.01) <b>G16H 40/20</b> (2018.01)
3781216	<b>A61L 2/08</b> (2006.01) <b>H01J 61/00</b> (2006.01)
3762379	<b>A61K 31/517</b> (2006.01) <b>A61K 31/519</b> (2006.01) <b>A61P 35/00</b> (2006.01) <b>C07D 403/04</b> (2006.01) <b>C07D 403/14</b> (2006.01) <b>C07D 407/14</b> (2006.01) <b>C07D 487/04</b> (2006.01)
3762074	<b>A61M 5/315</b> (2006.01)
3765493	<b>A61K 47/68</b> (2017.01) <b>C07K 16/10</b> (2006.01) <b>C07K 16/28</b> (2006.01) <b>C07K 16/30</b> (2006.01)

---

Broj objave evropske prijave patenta (97)	MKP (51)
3765508	<b>A61K 39/395</b> (2006.01) <b>A61P 35/00</b> (2006.01) <b>C07K 16/28</b> (2006.01)
3765495	<b>C07K 16/12</b> (2006.01)
3765657	<b>C25C 3/08</b> (2006.01) <b>C25C 3/16</b> (2006.01) <b>C25C 7/00</b> (2006.01) <b>C25C 7/02</b> (2006.01)
3765477	<b>A61K 31/7088</b> (2006.01) <b>A61K 48/00</b> (2006.01) <b>C07H 21/02</b> (2006.01) <b>C12N 5/07</b> (2010.01) <b>C12N 15/11</b> (2006.01)
3765439	<b>A61K 31/16</b> (2006.01) <b>A61P 37/00</b> (2006.01) <b>C07C 233/60</b> (2006.01)
3791701	<b>H05K 7/14</b> (2006.01) <b>H05K 7/18</b> (2006.01)
3762380	<b>A61K 31/4025</b> (2006.01) <b>A61K 31/4439</b> (2006.01) <b>A61K 31/506</b> (2006.01) <b>A61P 9/00</b> (2006.01) <b>C07D 207/14</b> (2006.01) <b>C07D 401/10</b> (2006.01) <b>C07D 401/12</b> (2006.01) <b>C07D 403/10</b> (2006.01) <b>C07D 403/12</b> (2006.01) <b>C07D 405/10</b> (2006.01) <b>C07D 409/12</b> (2006.01) <b>C07D 413/10</b> (2006.01) <b>C07D 413/14</b> (2006.01) <b>C07D 417/10</b> (2006.01) <b>C07F 9/02</b> (2006.01)
3765024	<b>A61K 31/5383</b> (2006.01) <b>A61P 25/00</b> (2006.01) <b>C07D 498/04</b> (2006.01)
3762341	<b>C03C 3/087</b> (2006.01) <b>C03C 3/095</b> (2006.01) <b>C03C 3/112</b> (2006.01) <b>C03C 13/00</b> (2006.01) <b>C08J 5/08</b> (2006.01)
3762195	<b>B26D 1/00</b> (2006.01) <b>B26D 1/06</b> (2006.01) <b>B26D 1/09</b> (2006.01) <b>B26D 3/08</b> (2006.01) <b>B26D 5/00</b> (2006.01) <b>B26D 5/06</b> (2006.01) <b>B26D 5/08</b> (2006.01) <b>B26D 7/01</b> (2006.01) <b>B65D 75/58</b> (2006.01)
3762389	<b>A61K 31/4985</b> (2006.01) <b>A61P 25/00</b> (2006.01)

---

Broj objave evropske prijava patenta (97)	MKP (51)
	<b>C07D 487/04</b> (2006.01)
3762067	<b>A61M 5/14</b> (2006.01) <b>A61M 5/142</b> (2006.01)
3765476	<b>A61K 31/7088</b> (2006.01) <b>A61P 25/28</b> (2006.01) <b>C07H 21/00</b> (2006.01) <b>C12N 15/113</b> (2010.01)
3762365	<b>A61K 31/4035</b> (2006.01) <b>A61P 1/12</b> (2006.01) <b>C07D 209/48</b> (2006.01)
3768834	<b>C12N 9/22</b> (2006.01) <b>C12N 15/10</b> (2006.01)
3765563	<b>C08L 1/02</b> (2006.01) <b>C08L 7/02</b> (2006.01) <b>C08L 21/00</b> (2006.01)
3768695	<b>C07K 14/005</b> (2006.01) <b>C12N 15/864</b> (2006.01)
3762036	<b>A61K 38/00</b> (2006.01) <b>A61K 47/00</b> (2006.01)
3762949	<b>H01B 5/10</b> (2006.01) <b>H01B 7/18</b> (2006.01) <b>H01B 9/00</b> (2006.01) <b>H01B 13/02</b> (2006.01)
3762400	<b>A61K 39/395</b> (2006.01) <b>C07K 7/64</b> (2006.01) <b>C07K 16/28</b> (2006.01)
3762505	<b>A61K 35/28</b> (2015.01) <b>A61K 48/00</b> (2006.01) <b>C12Q 1/34</b> (2006.01)
3762414	<b>C07K 16/18</b> (2006.01) <b>G01N 33/53</b> (2006.01) <b>G01N 33/58</b> (2006.01)
3762032	<b>A61K 39/395</b> (2006.01) <b>A61P 35/00</b> (2006.01) <b>C07K 16/28</b> (2006.01)
3762015	<b>A61K 38/17</b> (2006.01) <b>A61K 39/395</b> (2006.01) <b>A61P 37/02</b> (2006.01) <b>C07K 14/54</b> (2006.01) <b>C07K 16/24</b> (2006.01)
3762674	<b>F41A 9/62</b> (2006.01) <b>G01D 5/12</b> (2006.01)
3761980	<b>A61K 31/4375</b> (2006.01) <b>C07D 401/12</b> (2006.01)

---

Broj objave evropske prijave patenta (97)	MKP (51)
3794031	<b>A61K 39/395</b> (2006.01) <b>A61P 35/00</b> (2006.01) <b>C07K 16/24</b> (2006.01)
3765524	<b>A61K 39/395</b> (2006.01) <b>A61P 35/02</b> (2006.01) <b>C07K 16/28</b> (2006.01) <b>C07K 16/30</b> (2006.01)
3765023	<b>A61K 31/513</b> (2006.01) <b>A61K 48/00</b> (2006.01) <b>C12N 15/85</b> (2006.01)
3765630	<b>C12Q 1/68</b> (2018.01) <b>G01N 33/50</b> (2006.01) <b>G01N 33/68</b> (2006.01)
3766881	<b>A01N 43/76</b> (2006.01) <b>A01N 43/90</b> (2006.01) <b>A01N 47/02</b> (2006.01) <b>A01P 7/04</b> (2006.01) <b>A61K 31/506</b> (2006.01) <b>A61P 33/00</b> (2006.01) <b>A61P 33/14</b> (2006.01) <b>C07D 413/04</b> (2006.01) <b>C07D 413/14</b> (2006.01) <b>C07D 471/04</b> (2006.01) <b>C07F 7/10</b> (2006.01)
3765030	<b>A61K 31/7088</b> (2006.01) <b>A61K 47/64</b> (2017.01)
3765020	<b>A61K 31/495</b> (2006.01) <b>A61P 17/00</b> (2006.01) <b>C07D 295/04</b> (2006.01)
3766893	<b>A61K 51/04</b> (2006.01) <b>A61P 35/00</b> (2006.01) <b>C07F 13/00</b> (2006.01)
3762368	<b>A61K 31/497</b> (2006.01) <b>A61P 35/00</b> (2006.01) <b>C07D 241/20</b> (2006.01) <b>C07D 241/28</b> (2006.01) <b>C07D 403/04</b> (2006.01) <b>C07D 403/08</b> (2006.01) <b>C07D 403/14</b> (2006.01) <b>C07D 405/12</b> (2006.01) <b>C07D 413/04</b> (2006.01) <b>C07D 413/14</b> (2006.01) <b>C07D 417/04</b> (2006.01)
3787398	<b>A01K 47/00</b> (2006.01) <b>A01K 47/06</b> (2006.01)
3768841	<b>C12N 5/079</b> (2010.01) <b>C12N 15/113</b> (2010.01) <b>C12Q 1/68</b> (2018.01)
3768258	<b>A61K 31/4184</b> (2006.01) <b>A61K 31/519</b> (2006.01)

Broj objave evropske prijava patenta (97)	MKP (51)
	<b>A61P 35/00</b> (2006.01)
3768325	<b>A61K 38/07</b> (2006.01) <b>A61K 47/68</b> (2017.01) <b>A61P 35/00</b> (2006.01) <b>C07K 16/36</b> (2006.01)
3768314	<b>A61K 39/395</b> (2006.01) <b>A61P 29/00</b> (2006.01) <b>A61P 35/00</b> (2006.01) <b>A61P 37/06</b> (2006.01) <b>C07K 16/28</b> (2006.01)
3768269	<b>A61K 31/495</b> (2006.01) <b>C07D 257/02</b> (2006.01)
3769765	<b>A61K 9/10</b> (2006.01) <b>A61K 9/14</b> (2006.01) <b>A61K 9/16</b> (2006.01) <b>A61K 9/20</b> (2006.01) <b>A61K 9/48</b> (2006.01) <b>A61K 31/519</b> (2006.01) <b>A61K 47/20</b> (2006.01) <b>A61K 47/26</b> (2006.01) <b>A61K 47/32</b> (2006.01) <b>A61K 47/38</b> (2006.01)
3768317	<b>A61K 38/20</b> (2006.01) <b>A61K 39/395</b> (2006.01) <b>C07K 14/54</b> (2006.01) <b>C07K 16/24</b> (2006.01)
3768615	<b>B65G 5/00</b> (2006.01) <b>E21F 17/16</b> (2006.01)
3768330	<b>A61K 39/12</b> (2006.01) <b>A61K 48/00</b> (2006.01) <b>C12N 5/09</b> (2010.01) <b>C12N 15/86</b> (2006.01) <b>G01N 33/50</b> (2006.01) <b>G01N 33/569</b> (2006.01)
3782986	<b>A61K 31/44</b> (2006.01) <b>A61K 31/443</b> (2006.01) <b>A61K 31/4433</b> (2006.01) <b>A61K 31/4439</b> (2006.01) <b>A61K 31/444</b> (2006.01) <b>A61K 31/4545</b> (2006.01) <b>A61K 31/496</b> (2006.01) <b>A61K 31/497</b> (2006.01) <b>A61K 31/501</b> (2006.01) <b>A61K 31/506</b> (2006.01) <b>A61K 31/517</b> (2006.01) <b>A61K 31/5377</b> (2006.01) <b>A61K 31/5383</b> (2006.01) <b>A61K 31/541</b> (2006.01) <b>A61K 31/55</b> (2006.01) <b>A61K 31/551</b> (2006.01) <b>A61K 31/553</b> (2006.01) <b>A61K 31/554</b> (2006.01) <b>A61P 35/00</b> (2006.01) <b>A61P 43/00</b> (2006.01)

Broj objave evropske prijave patenta (97)	MKP (51)
	<b>C07D 213/85</b> (2006.01)
3789489	<b>A61K 35/76</b> (2015.01) <b>A61P 35/00</b> (2006.01) <b>C07K 16/22</b> (2006.01) <b>C12N 7/01</b> (2006.01) <b>C12N 15/13</b> (2006.01)
3773630	<b>A61K 35/17</b> (2015.01) <b>C07K 16/28</b> (2006.01)
3765029	<b>A61K 31/04</b> (2006.01) <b>A61K 31/4025</b> (2006.01) <b>A61K 31/70</b> (2006.01)
3781188	<b>A61K 35/763</b> (2015.01) <b>C12N 5/07</b> (2010.01) <b>C12N 5/10</b> (2006.01) <b>C12N 7/00</b> (2006.01)
3768226	<b>A61K 8/30</b> (2006.01) <b>A61K 8/65</b> (2006.01) <b>A61K 9/06</b> (2006.01) <b>A61K 31/203</b> (2006.01) <b>A61K 31/785</b> (2006.01) <b>A61K 47/69</b> (2017.01) <b>A61P 17/14</b> (2006.01)
3773573	<b>A61K 31/4375</b> (2006.01) <b>C07D 207/04</b> (2006.01) <b>C07D 471/04</b> (2006.01)
3784671	<b>A61K 31/444</b> (2006.01) <b>A61K 31/4545</b> (2006.01) <b>A61K 31/4745</b> (2006.01) <b>A61K 31/502</b> (2006.01) <b>A61P 35/00</b> (2006.01) <b>C07D 471/10</b> (2006.01)
3781157	<b>A61K 31/401</b> (2006.01) <b>A61P 25/02</b> (2006.01)
3783043	<b>B32B 15/092</b> (2006.01) <b>C08G 59/32</b> (2006.01) <b>C08J 5/24</b> (2006.01) <b>C08K 3/013</b> (2018.01) <b>C08K 5/13</b> (2006.01) <b>C08L 63/00</b> (2006.01) <b>H05K 1/03</b> (2006.01) <b>H05K 3/46</b> (2006.01)
3781177	<b>A61K 35/17</b> (2015.01) <b>C07K 14/705</b> (2006.01) <b>C07K 14/715</b> (2006.01) <b>C07K 14/725</b> (2006.01) <b>C12N 5/0783</b> (2010.01) <b>C12N 5/10</b> (2006.01) <b>C12N 15/10</b> (2006.01) <b>C12N 15/86</b> (2006.01) <b>C12N 15/867</b> (2006.01)

Broj objave evropske prijave patenta (97)	MKP (51)
3782648	<b>A61K 31/4184</b> (2006.01) <b>A61K 31/454</b> (2006.01) <b>A61K 31/5377</b> (2006.01) <b>A61K 45/00</b> (2006.01) <b>A61P 21/00</b> (2006.01) <b>A61P 43/00</b> (2006.01)
3784132	<b>A61B 6/00</b> (2006.01) <b>G01T 1/20</b> (2006.01) <b>G01T 1/24</b> (2006.01) <b>H01L 25/065</b> (2006.01) <b>H01L 27/146</b> (2006.01)
3784234	<b>A61K 31/422</b> (2006.01) <b>A61P 35/00</b> (2006.01) <b>C07D 263/48</b> (2006.01)
3784258	<b>A61K 35/28</b> (2015.01) <b>C12N 15/861</b> (2006.01) <b>C12N 15/88</b> (2006.01)
3784699	<b>C07K 16/18</b> (2006.01) <b>C07K 16/28</b> (2006.01)
3784241	<b>A61K 31/4985</b> (2006.01) <b>C07D 487/16</b> (2006.01)
3784657	<b>C07D 239/70</b> (2006.01) <b>C07D 401/10</b> (2006.01) <b>C07D 403/10</b> (2006.01)
3797114	<b>C07K 5/06</b> (2006.01) <b>C07K 16/44</b> (2006.01)
3770780	<b>G06F 21/32</b> (2013.01) <b>G06T 7/00</b> (2017.01)
3711497	<b>A24D 3/06</b> (2006.01)
3789569	<b>E05B 19/18</b> (2006.01) <b>E05B 63/00</b> (2006.01)
3787988	<b>B65B 35/30</b> (2006.01) <b>B65G 47/08</b> (2006.01) <b>B65G 47/54</b> (2006.01) <b>B65G 47/56</b> (2006.01) <b>B65G 47/57</b> (2006.01)
3790492	<b>A61B 18/20</b> (2006.01) <b>A61B 34/20</b> (2016.01) <b>A61C 1/00</b> (2006.01) <b>A61C 1/02</b> (2006.01)
3790584	<b>A61K 39/395</b> (2006.01) <b>C07K 16/28</b> (2006.01) <b>C07K 16/36</b> (2006.01)
3799602	<b>C12N 15/113</b> (2010.01)
3795688	<b>A61K 31/7088</b> (2006.01) <b>A61P 37/00</b> (2006.01)



Broj objave evropske prijave patenta (97)	MKP (51)
	<b>C12N 1/15</b> (2006.01) <b>C12N 1/19</b> (2006.01) <b>C12N 1/21</b> (2006.01) <b>C12N 5/10</b> (2006.01) <b>C12N 15/12</b> (2006.01) <b>C12N 15/62</b> (2006.01) <b>C12N 15/63</b> (2006.01)
3792361	<b>A61K 31/7088</b> (2006.01) <b>A61P 37/08</b> (2006.01) <b>C12N 1/15</b> (2006.01) <b>C12N 1/19</b> (2006.01) <b>C12N 1/21</b> (2006.01) <b>C12N 5/10</b> (2006.01) <b>C12N 15/62</b> (2006.01) <b>C12N 15/63</b> (2006.01)
3790866	<b>A61K 31/506</b> (2006.01) <b>A61P 31/20</b> (2006.01) <b>C07D 239/20</b> (2006.01) <b>C07D 403/04</b> (2006.01) <b>C07D 417/04</b> (2006.01)
3792260	<b>A61K 31/437</b> (2006.01) <b>A61K 31/444</b> (2006.01) <b>A61K 31/4545</b> (2006.01) <b>A61K 31/46</b> (2006.01) <b>A61K 31/496</b> (2006.01) <b>A61K 31/497</b> (2006.01) <b>A61K 31/551</b> (2006.01) <b>A61P 3/10</b> (2006.01) <b>A61P 13/02</b> (2006.01) <b>A61P 13/10</b> (2006.01) <b>A61P 27/06</b> (2006.01) <b>A61P 43/00</b> (2006.01) <b>C07D 471/04</b> (2006.01) <b>C07D 519/00</b> (2006.01)
3790493	<b>A61C 1/00</b> (2006.01) <b>A61C 3/04</b> (2006.01) <b>A61C 5/80</b> (2017.01) <b>A61C 19/00</b> (2006.01)
3792349	<b>C07K 14/36</b> (2006.01) <b>C12N 9/00</b> (2006.01) <b>C12N 15/52</b> (2006.01) <b>C12N 15/63</b> (2006.01)
3790692	<b>B22F 1/00</b> (2006.01) <b>B22F 3/00</b> (2021.01) <b>B22F 9/08</b> (2006.01) <b>B33Y 70/00</b> (2020.01)
3799604	<b>A61K 31/70</b> (2006.01) <b>C12N 15/113</b> (2010.01)
3790587	<b>A61K 39/395</b> (2006.01) <b>A61P 25/00</b> (2006.01) <b>A61P 37/00</b> (2006.01) <b>C07K 16/24</b> (2006.01) <b>C12N 15/13</b> (2006.01)

Broj objave evropske prijava patenta (97)	MKP (51)
3793974	<b>A61K 31/19</b> (2006.01) <b>A61P 25/00</b> (2006.01) <b>C07C 229/00</b> (2006.01)
3793602	<b>A61K 39/395</b> (2006.01) <b>A61P 25/00</b> (2006.01) <b>A61P 25/28</b> (2006.01) <b>C07K 16/40</b> (2006.01)
3793547	<b>A61K 31/41</b> (2006.01) <b>A61K 31/4164</b> (2006.01) <b>A61K 31/4192</b> (2006.01)
3794147	<b>C12Q 1/68</b> (2018.01) <b>C12Q 1/6806</b> (2018.01) <b>C12Q 1/6809</b> (2018.01) <b>C12Q 1/6876</b> (2018.01) <b>C12Q 1/6888</b> (2018.01)
3793552	<b>A61K 31/423</b> (2006.01) <b>A61K 31/424</b> (2006.01) <b>A61P 25/28</b> (2006.01)
3793945	<b>C01D 15/02</b> (2006.01) <b>C01D 15/08</b> (2006.01) <b>C22B 3/24</b> (2006.01)
3793606	<b>A61K 39/395</b> (2006.01) <b>A61P 35/00</b> (2006.01) <b>C07K 16/28</b> (2006.01) <b>C07K 16/30</b> (2006.01) <b>C07K 16/46</b> (2006.01) <b>C07K 19/00</b> (2006.01)
3793521	<b>A61K 9/00</b> (2006.01) <b>A61P 37/06</b> (2006.01) <b>C07K 16/24</b> (2006.01) <b>C12Q 1/68</b> (2018.01) <b>C12Q 1/6883</b> (2018.01)
3793608	<b>A61K 45/06</b> (2006.01) <b>C07D 401/14</b> (2006.01)
3794349	<b>C12M 1/00</b> (2006.01) <b>C12M 3/00</b> (2006.01) <b>C12N 5/00</b> (2006.01) <b>C12N 13/00</b> (2006.01) <b>G01N 33/50</b> (2006.01)
3799570	<b>A61K 48/00</b> (2006.01) <b>C07H 21/02</b> (2006.01)
3796914	<b>A61K 31/4184</b> (2006.01) <b>A61K 31/437</b> (2006.01) <b>A61K 31/44</b> (2006.01) <b>A61K 31/4985</b> (2006.01) <b>A61K 31/5025</b> (2006.01) <b>A61K 31/517</b> (2006.01) <b>A61K 31/519</b> (2006.01) <b>A61K 31/52</b> (2006.01) <b>A61K 31/55</b> (2006.01) <b>A61P 35/00</b> (2006.01)

Broj objave evropske prijava patenta (97)	MKP (51)
	<b>C12Q 1/6809</b> (2018.01)
3791012	<b>C12Q 1/68</b> (2018.01) <b>C12Q 1/6827</b> (2018.01) <b>C12Q 1/6883</b> (2018.01) <b>C40B 30/00</b> (2006.01)
3781533	<b>C04B 28/04</b> (2006.01) <b>C04B 111/00</b> (2006.01)
3718565	<b>A61K 39/12</b> (2006.01) <b>A61P 11/00</b> (2006.01) <b>C07K 16/10</b> (2006.01)
3701965	<b>A61K 38/09</b> (2006.01) <b>A61K 45/06</b> (2006.01) <b>A61P 5/26</b> (2006.01) <b>A61P 5/30</b> (2006.01) <b>A61P 13/00</b> (2006.01) <b>A61P 13/08</b> (2006.01) <b>A61P 15/00</b> (2006.01) <b>A61P 35/00</b> (2006.01) <b>A61P 43/00</b> (2006.01)
3730701	<b>A01D 87/00</b> (2006.01) <b>E02F 3/627</b> (2006.01)
3696824	<b>A61K 51/00</b> (2006.01) <b>A61K 51/12</b> (2006.01) <b>A61M 36/00</b> (2006.01) <b>G21G 1/00</b> (2006.01)
3699181	<b>A61K 31/519</b> (2006.01) <b>A61P 35/00</b> (2006.01) <b>C07D 487/04</b> (2006.01)
3725327	<b>A61K 39/00</b> (2006.01) <b>A61P 35/00</b> (2006.01) <b>C07K 14/47</b> (2006.01) <b>G01N 33/50</b> (2006.01)
3760225	<b>A61K 39/00</b> (2006.01) <b>A61P 35/00</b> (2006.01) <b>C07K 14/47</b> (2006.01) <b>C07K 16/00</b> (2006.01)
3763706	<b>A01N 43/52</b> (2006.01) <b>A61K 31/4184</b> (2006.01) <b>C07D 235/10</b> (2006.01) <b>C07D 235/18</b> (2006.01) <b>C07D 235/28</b> (2006.01)
3797893	<b>B21D 28/02</b> (2006.01) <b>B21D 28/16</b> (2006.01) <b>B21D 37/08</b> (2006.01) <b>B21D 43/14</b> (2006.01)
3766491	<b>A61K 31/422</b> (2006.01) <b>A61P 33/00</b> (2006.01)
3778622	<b>A61K 38/12</b> (2006.01) <b>A61P 37/06</b> (2006.01)

Broj objave evropske prijava patenta (97)	MKP (51)
	<b>C07K 7/08</b> (2006.01) <b>C07K 7/56</b> (2006.01) <b>G01N 33/68</b> (2006.01)
3769753	<b>A61K 9/10</b> (2006.01) <b>A61K 9/14</b> (2006.01) <b>A61K 31/56</b> (2006.01) <b>A61K 47/02</b> (2006.01) <b>A61K 47/10</b> (2017.01) <b>A61P 27/00</b> (2006.01) <b>C07J 31/00</b> (2006.01) <b>C07J 71/00</b> (2006.01)
3792281	<b>A61K 39/395</b> (2006.01) <b>A61P 17/06</b> (2006.01) <b>C07K 16/24</b> (2006.01)
3763734	<b>A61P 3/00</b> (2006.01) <b>A61P 3/04</b> (2006.01) <b>A61P 3/06</b> (2006.01) <b>A61P 3/08</b> (2006.01) <b>A61P 3/10</b> (2006.01) <b>A61P 3/12</b> (2006.01) <b>A61P 13/12</b> (2006.01) <b>C07K 14/475</b> (2006.01) <b>C07K 14/495</b> (2006.01) <b>C07K 14/765</b> (2006.01) <b>C12N 15/62</b> (2006.01)
3788874	<b>A01N 25/00</b> (2006.01) <b>A61K 31/42</b> (2006.01) <b>A61P 33/00</b> (2006.01)
3766878	<b>A61K 31/4192</b> (2006.01) <b>A61K 31/553</b> (2006.01) <b>A61P 9/10</b> (2006.01) <b>A61P 9/12</b> (2006.01) <b>A61P 11/00</b> (2006.01) <b>A61P 11/06</b> (2006.01) <b>A61P 13/12</b> (2006.01) <b>A61P 17/00</b> (2006.01) <b>A61P 25/00</b> (2006.01) <b>A61P 35/00</b> (2006.01) <b>A61P 37/00</b> (2006.01) <b>C07D 267/14</b> (2006.01) <b>C07D 403/06</b> (2006.01) <b>C07D 413/06</b> (2006.01) <b>C07D 413/10</b> (2006.01) <b>C07D 498/04</b> (2006.01) <b>C07D 519/00</b> (2006.01)
3799933	<b>A61K 8/04</b> (2006.01) <b>A61K 8/34</b> (2006.01) <b>A61K 8/36</b> (2006.01) <b>A61K 8/365</b> (2006.01) <b>A61K 8/60</b> (2006.01) <b>A61K 8/9789</b> (2017.01) <b>A61K 9/00</b> (2006.01) <b>A61K 9/107</b> (2006.01) <b>A61K 31/047</b> (2006.01) <b>A61K 36/76</b> (2006.01) <b>A61K 47/10</b> (2017.01) <b>A61P 17/10</b> (2006.01) <b>A61Q 17/04</b> (2006.01) <b>A61Q 19/00</b> (2006.01)

Broj objave evropske prijave patenta (97)	MKP (51)
	<b>A61Q 19/10</b> (2006.01)
3770146	<b>A61K 31/4174</b> (2006.01) <b>A61K 31/4439</b> (2006.01) <b>A61P 21/00</b> (2006.01) <b>C07D 233/64</b> (2006.01) <b>C07D 401/04</b> (2006.01) <b>C07D 405/10</b> (2006.01)
3795566	<b>A61K 31/4174</b> (2006.01) <b>A61K 31/4439</b> (2006.01) <b>A61P 21/00</b> (2006.01) <b>A61P 25/00</b> (2006.01) <b>C07D 401/04</b> (2006.01)
3778606	<b>A61K 31/4188</b> (2006.01) <b>C07D 491/052</b> (2006.01)
3778606	<b>A61K 31/4188</b> (2006.01) <b>C07D 491/052</b> (2006.01)
3766871	<b>A01N 43/50</b> (2006.01) <b>A01P 7/02</b> (2006.01) <b>A01P 7/04</b> (2006.01) <b>A61K 31/4164</b> (2006.01) <b>A61K 31/4439</b> (2006.01) <b>A61P 31/00</b> (2006.01) <b>A61P 33/00</b> (2006.01) <b>A61P 33/10</b> (2006.01) <b>A61P 33/14</b> (2006.01) <b>C07D 233/64</b> (2006.01) <b>C07D 401/04</b> (2006.01)
3786160	<b>A61K 31/45</b> (2006.01) <b>A61K 31/501</b> (2006.01) <b>C07D 213/04</b> (2006.01) <b>C07D 401/14</b> (2006.01) <b>C07D 451/02</b> (2006.01) <b>C07D 487/08</b> (2006.01) <b>C07D 498/08</b> (2006.01)
3782643	<b>A61K 39/095</b> (2006.01) <b>C07K 14/095</b> (2006.01) <b>C07K 14/22</b> (2006.01)
3786182	<b>A61P 25/28</b> (2006.01) <b>C07K 14/435</b> (2006.01) <b>C07K 16/18</b> (2006.01) <b>G01N 33/53</b> (2006.01)
3789038	<b>A61K 39/395</b> (2006.01) <b>A61P 35/00</b> (2006.01) <b>A61P 35/02</b> (2006.01) <b>A61P 37/04</b> (2006.01) <b>C07K 16/28</b> (2006.01) <b>C07K 16/46</b> (2006.01) <b>C12N 5/07</b> (2010.01) <b>C12N 5/16</b> (2006.01) <b>C12P 21/08</b> (2006.01) <b>G01N 33/68</b> (2006.01)
3782996	<b>A61K 31/5365</b> (2006.01) <b>A61P 9/00</b> (2006.01)

Broj objave evropske prijave patenta (97)	MKP (51)
	<b>A61P 11/00</b> (2006.01) <b>A61P 25/00</b> (2006.01) <b>A61P 27/00</b> (2006.01) <b>A61P 35/00</b> (2006.01) <b>A61P 37/00</b> (2006.01) <b>C07C 15/16</b> (2006.01) <b>C07D 249/04</b> (2006.01) <b>C07D 249/18</b> (2006.01) <b>C07D 403/10</b> (2006.01) <b>C07D 417/10</b> (2006.01)
3785717	<b>A61K 31/53</b> (2006.01) <b>A61K 31/664</b> (2006.01) <b>A61K 31/675</b> (2006.01) <b>A61K 31/683</b> (2006.01) <b>A61K 31/685</b> (2006.01) <b>A61P 31/12</b> (2006.01)
3783576	<b>G06F 9/54</b> (2006.01) <b>G06F 13/00</b> (2006.01) <b>G07F 17/32</b> (2006.01)
3762390	<b>C07D 487/04</b> (2006.01)
3765559	<b>C08J 11/12</b> (2006.01) <b>C08J 11/14</b> (2006.01) <b>C08L 67/02</b> (2006.01)
3765458	<b>A61K 31/427</b> (2006.01) <b>A61K 31/445</b> (2006.01) <b>A61P 25/28</b> (2006.01) <b>C07D 417/06</b> (2006.01) <b>C07D 417/14</b> (2006.01) <b>C07D 495/04</b> (2006.01)
3765461	<b>A61K 31/519</b> (2006.01) <b>A61P 35/00</b> (2006.01) <b>C07D 487/04</b> (2006.01) <b>C07D 519/00</b> (2006.01)
3768711	<b>A61P 35/00</b> (2006.01) <b>C07K 16/28</b> (2006.01)
3768712	<b>A61K 39/00</b> (2006.01) <b>A61P 35/00</b> (2006.01) <b>C07K 16/28</b> (2006.01)
3765846	<b>C12M 1/34</b> (2006.01) <b>G01N 33/50</b> (2006.01)
3768284	<b>A61K 35/744</b> (2015.01) <b>A61K 38/16</b> (2006.01) <b>A61K 48/00</b> (2006.01) <b>A61P 35/00</b> (2006.01) <b>A61P 37/04</b> (2006.01) <b>C07K 14/315</b> (2006.01)
3768419	<b>B01J 23/02</b> (2006.01) <b>B01J 35/02</b> (2006.01) <b>B01J 35/10</b> (2006.01) <b>B01J 37/08</b> (2006.01) <b>C01F 1/00</b> (2006.01)

Broj objave evropske prijava patenta (97)	MKP (51)
	<b>C01F 11/06</b> (2006.01) <b>C01F 11/18</b> (2006.01) <b>C07C 67/03</b> (2006.01) <b>C10L 1/02</b> (2006.01) <b>C10L 3/00</b> (2006.01) <b>C10L 3/10</b> (2006.01)
3768285	<b>A23L 33/135</b> (2016.01) <b>A61K 35/744</b> (2015.01) <b>A61K 38/16</b> (2006.01) <b>A61P 37/04</b> (2006.01)
3768224	<b>A61K 6/00</b> (2020.01) <b>A61K 8/04</b> (2006.01) <b>A61K 8/19</b> (2006.01) <b>A61K 8/20</b> (2006.01) <b>A61K 8/22</b> (2006.01) <b>A61K 8/37</b> (2006.01) <b>A61K 8/43</b> (2006.01) <b>A61K 8/73</b> (2006.01) <b>A61K 8/81</b> (2006.01) <b>A61K 31/155</b> (2006.01) <b>A61K 31/192</b> (2006.01) <b>A61K 31/616</b> (2006.01) <b>A61P 1/02</b> (2006.01) <b>A61Q 11/00</b> (2006.01) <b>A61Q 11/02</b> (2006.01)
3762393	<b>A61K 31/553</b> (2006.01) <b>A61P 35/00</b> (2006.01) <b>C07D 498/10</b> (2006.01) <b>C07D 498/20</b> (2006.01) <b>C07D 498/22</b> (2006.01)
3761987	<b>A61K 31/519</b> (2006.01) <b>A61K 31/7068</b> (2006.01) <b>A61K 45/06</b> (2006.01) <b>A61P 25/28</b> (2006.01)
3781321	<b>B02C 17/16</b> (2006.01)
3768265	<b>A61K 31/4468</b> (2006.01) <b>A61P 9/00</b> (2006.01) <b>A61P 25/00</b> (2006.01) <b>A61P 25/02</b> (2006.01) <b>A61P 25/04</b> (2006.01) <b>A61P 25/16</b> (2006.01) <b>A61P 25/28</b> (2006.01)
3765447	<b>A61K 31/395</b> (2006.01) <b>A61K 31/675</b> (2006.01) <b>C07D 255/02</b> (2006.01)
3768311	<b>A61K 39/395</b> (2006.01) <b>A61P 43/00</b> (2006.01) <b>C07K 16/18</b> (2006.01) <b>C07K 16/28</b> (2006.01)
3768715	<b>A61P 35/00</b> (2006.01) <b>C07K 16/28</b> (2006.01)

Broj objave evropske prijave patenta (97)	MKP (51)
3761830	<b>A47B 7/00</b> (2006.01) <b>A47B 13/02</b> (2006.01)
3765069	<b>A61K 39/00</b> (2006.01) <b>A61K 39/385</b> (2006.01) <b>G01N 33/68</b> (2006.01)
3768850	<b>C12Q 1/06</b> (2006.01) <b>C12Q 1/24</b> (2006.01)
3768660	<b>A61K 31/165</b> (2006.01) <b>A61K 31/397</b> (2006.01) <b>A61K 31/438</b> (2006.01) <b>A61P 25/00</b> (2006.01) <b>A61P 35/00</b> (2006.01) <b>C07D 205/12</b> (2006.01) <b>C07D 207/09</b> (2006.01) <b>C07D 209/52</b> (2006.01) <b>C07D 211/58</b> (2006.01) <b>C07D 211/74</b> (2006.01) <b>C07D 215/12</b> (2006.01) <b>C07D 221/20</b> (2006.01) <b>C07D 233/32</b> (2006.01) <b>C07D 271/10</b> (2006.01) <b>C07D 277/68</b> (2006.01) <b>C07D 311/66</b> (2006.01) <b>C07D 401/04</b> (2006.01) <b>C07D 401/12</b> (2006.01) <b>C07D 403/04</b> (2006.01) <b>C07D 413/04</b> (2006.01)
3765474	<b>A61P 35/00</b> (2006.01) <b>C07H 19/213</b> (2006.01)
3765856	<b>G01N 33/68</b> (2006.01)
3793943	<b>C01D 15/02</b> (2006.01) <b>C01D 15/08</b> (2006.01) <b>C22B 26/12</b> (2006.01)
3762288	<b>B63B 22/00</b> (2006.01) <b>B63B 35/00</b> (2020.01) <b>B63B 35/44</b> (2006.01) <b>G01S 7/00</b> (2006.01)
3793592	<b>A61K 39/00</b> (2006.01) <b>C07K 14/47</b> (2006.01) <b>C07K 14/74</b> (2006.01)
3765857	<b>G01N 33/68</b> (2006.01)
3768716	<b>A61K 39/395</b> (2006.01) <b>C07K 16/28</b> (2006.01)
3784209	<b>A61K 9/00</b> (2006.01) <b>A61P 7/06</b> (2006.01) <b>A61P 37/04</b> (2006.01) <b>A61P 37/06</b> (2006.01) <b>G01N 15/02</b> (2006.01) <b>G01N 15/10</b> (2006.01)



Broj objave evropske prijava patenta (97)	MKP (51)
3784736	<b>C09C 1/02</b> (2006.01) <b>D21H 17/67</b> (2006.01)
3784667	<b>A61K 31/437</b> (2006.01) <b>A61P 31/16</b> (2006.01) <b>C07D 471/04</b> (2006.01)
3769473	<b>H04L 12/28</b> (2006.01)
3781219	<b>A61F 5/058</b> (2006.01) <b>A61L 15/08</b> (2006.01) <b>A61L 15/12</b> (2006.01) <b>A61L 15/14</b> (2006.01)
3784030	<b>A01H 1/04</b> (2006.01) <b>C12N 9/14</b> (2006.01) <b>C12N 15/82</b> (2006.01) <b>C12Q 1/68</b> (2018.01)
3785260	<b>G10L 19/02</b> (2013.01) <b>G10L 19/24</b> (2013.01) <b>G10L 21/0388</b> (2013.01)
3784691	<b>A61K 38/18</b> (2006.01) <b>C07K 14/48</b> (2006.01)
3781560	<b>A61P 25/16</b> (2006.01) <b>A61P 25/28</b> (2006.01) <b>C07D 401/04</b> (2006.01) <b>C07D 405/14</b> (2006.01)
3784212	<b>A61K 9/00</b> (2006.01) <b>A61P 11/06</b> (2006.01)
3765131	<b>A61M 5/315</b> (2006.01)
3765381	<b>B65D 81/38</b> (2006.01)
3790873	<b>A61K 31/454</b> (2006.01) <b>A61K 31/4545</b> (2006.01) <b>A61P 3/00</b> (2006.01) <b>A61P 25/00</b> (2006.01) <b>A61P 29/00</b> (2006.01) <b>A61P 35/00</b> (2006.01) <b>C07D 405/12</b> (2006.01) <b>C07D 405/14</b> (2006.01) <b>C07D 409/12</b> (2006.01) <b>C07D 409/14</b> (2006.01)
3781674	<b>C12N 5/079</b> (2010.01)
3787605	<b>A61K 9/28</b> (2006.01) <b>A61K 9/50</b> (2006.01) <b>A61K 31/00</b> (2006.01)
3781265	<b>A61P 35/00</b> (2006.01) <b>C07K 16/28</b> (2006.01)
3781561	<b>A61K 31/44</b> (2006.01) <b>A61P 35/00</b> (2006.01) <b>C07D 405/12</b> (2006.01)

Broj objave evropske prijave patenta (97)	MKP (51)
	<b>C07D 405/14</b> (2006.01)
3781692	<b>C07K 14/195</b> (2006.01) <b>C07K 14/325</b> (2006.01) <b>C12N 15/82</b> (2006.01)
3781596	<b>A61K 38/17</b> (2006.01) <b>A61K 38/20</b> (2006.01) <b>A61P 35/00</b> (2006.01) <b>C07K 14/54</b> (2006.01) <b>C07K 14/715</b> (2006.01) <b>C07K 16/28</b> (2006.01)
3784254	<b>A61K 35/17</b> (2015.01) <b>C12N 5/09</b> (2010.01) <b>C12N 15/90</b> (2006.01)
3784272	<b>A61K 38/46</b> (2006.01) <b>A61K 39/00</b> (2006.01) <b>A61K 48/00</b> (2006.01) <b>A61P 35/00</b> (2006.01) <b>C07K 14/725</b> (2006.01) <b>C07K 16/28</b> (2006.01) <b>C12N 5/0783</b> (2010.01) <b>C12N 9/22</b> (2006.01) <b>C12N 15/90</b> (2006.01)
3788043	<b>A61K 31/438</b> (2006.01) <b>A61K 31/439</b> (2006.01) <b>A61K 31/444</b> (2006.01) <b>A61K 31/501</b> (2006.01) <b>A61K 31/506</b> (2006.01) <b>A61P 25/00</b> (2006.01) <b>C07D 401/04</b> (2006.01) <b>C07D 413/04</b> (2006.01) <b>C07D 413/14</b> (2006.01) <b>C07D 417/04</b> (2006.01) <b>C07D 417/14</b> (2006.01) <b>C07D 471/04</b> (2006.01) <b>C07D 471/08</b> (2006.01) <b>C07D 487/04</b> (2006.01) <b>C07D 513/04</b> (2006.01)
3781126	<b>A61K 9/00</b> (2006.01) <b>A61K 9/14</b> (2006.01) <b>A61K 31/198</b> (2006.01) <b>A61K 47/26</b> (2006.01)
3781170	<b>A61K 31/55</b> (2006.01) <b>A61K 31/565</b> (2006.01) <b>A61K 31/57</b> (2006.01) <b>A61K 31/585</b> (2006.01) <b>A61P 5/30</b> (2006.01)
3781171	<b>A61K 31/55</b> (2006.01) <b>A61K 31/565</b> (2006.01) <b>A61K 31/57</b> (2006.01) <b>A61K 31/585</b> (2006.01) <b>A61P 5/30</b> (2006.01)
3790060	<b>H01L 31/0224</b> (2006.01) <b>H01L 31/042</b> (2014.01) <b>H01L 31/05</b> (2014.01)

Broj objave evropske prijava patenta (97)	MKP (51)
	<b>H01L 31/068</b> (2012.01)
3695864	<b>A61M 5/168</b> (2006.01) <b>A61M 5/20</b> (2006.01) <b>A61M 5/315</b> (2006.01) <b>A61M 5/32</b> (2006.01) <b>A61M 5/42</b> (2006.01) <b>A61M 5/48</b> (2006.01) <b>A61M 5/50</b> (2006.01)
3689911	<b>A61K 39/00</b> (2006.01) <b>A61K 39/395</b> (2006.01) <b>A61P 1/04</b> (2006.01) <b>A61P 1/16</b> (2006.01) <b>A61P 1/18</b> (2006.01) <b>A61P 11/00</b> (2006.01) <b>A61P 13/10</b> (2006.01) <b>A61P 13/12</b> (2006.01) <b>A61P 15/00</b> (2006.01) <b>A61P 17/00</b> (2006.01) <b>A61P 21/00</b> (2006.01) <b>A61P 25/00</b> (2006.01) <b>A61P 35/00</b> (2006.01) <b>A61P 35/04</b> (2006.01) <b>C07K 14/705</b> (2006.01) <b>C07K 16/28</b> (2006.01) <b>C07K 16/30</b> (2006.01)
3693393	<b>A61P 37/06</b> (2006.01) <b>C07K 16/28</b> (2006.01)
3698795	<b>A61K 31/506</b> (2006.01) <b>A61K 31/519</b> (2006.01) <b>A61P 21/00</b> (2006.01) <b>A61P 21/04</b> (2006.01) <b>A61P 25/02</b> (2006.01) <b>C07D 239/42</b> (2006.01) <b>C07D 239/48</b> (2006.01) <b>C07D 401/04</b> (2006.01) <b>C07D 401/12</b> (2006.01) <b>C07D 401/14</b> (2006.01) <b>C07D 403/04</b> (2006.01) <b>C07D 403/10</b> (2006.01) <b>C07D 403/14</b> (2006.01) <b>C07D 413/14</b> (2006.01) <b>C07D 417/14</b> (2006.01) <b>C07D 471/04</b> (2006.01)
3692986	<b>A61K 31/202</b> (2006.01)
3680240	<b>B01J 31/02</b> (2006.01) <b>C07D 453/04</b> (2006.01)
3693476	<b>C12Q 1/6886</b> (2018.01)
3690511	<b>G01N 21/03</b> (2006.01) <b>G01N 21/25</b> (2006.01) <b>G01N 21/64</b> (2006.01) <b>G01N 21/76</b> (2006.01) <b>G02B 21/00</b> (2006.01)
3702352	<b>A61K 31/513</b> (2006.01) <b>A61P 9/00</b> (2006.01)

Broj objave evropske prijava patenta (97)	MKP (51)
	<b>A61P 9/04</b> (2006.01) <b>A61P 9/10</b> (2006.01) <b>A61P 9/12</b> (2006.01) <b>C07D 239/545</b> (2006.01)
3683220	<b>A61K 31/4745</b> (2006.01) <b>A61P 25/28</b> (2006.01) <b>A61P 35/00</b> (2006.01) <b>C07D 471/04</b> (2006.01)
3670506	<b>A61K 31/4355</b> (2006.01) <b>A61K 31/4365</b> (2006.01) <b>A61K 31/4427</b> (2006.01) <b>A61K 31/4709</b> (2006.01) <b>A61K 31/497</b> (2006.01) <b>A61P 35/00</b> (2006.01) <b>C07D 401/14</b> (2006.01) <b>C07D 417/14</b> (2006.01) <b>C07D 471/04</b> (2006.01) <b>C07D 491/048</b> (2006.01) <b>C07D 495/04</b> (2006.01)
3674302	<b>A61K 31/437</b> (2006.01) <b>A61P 9/10</b> (2006.01) <b>A61P 11/06</b> (2006.01) <b>A61P 25/24</b> (2006.01) <b>A61P 25/28</b> (2006.01) <b>A61P 31/00</b> (2006.01) <b>A61P 33/00</b> (2006.01) <b>A61P 35/00</b> (2006.01) <b>A61P 37/00</b> (2006.01) <b>C07D 471/04</b> (2006.01)
3682915	<b>A61J 7/00</b> (2006.01) <b>A61M 1/02</b> (2006.01) <b>A61M 1/14</b> (2006.01) <b>A61M 1/16</b> (2006.01) <b>A61M 1/18</b> (2006.01) <b>A61M 5/307</b> (2006.01) <b>A61M 5/315</b> (2006.01)
3699371	<b>E04F 13/00</b> (2006.01) <b>E04F 13/06</b> (2006.01) <b>E06B 1/62</b> (2006.01)
3693383	<b>C07K 14/00</b> (2006.01) <b>C07K 14/735</b> (2006.01) <b>C12N 15/85</b> (2006.01)
3686193	<b>A61K 31/437</b> (2006.01) <b>A61K 31/506</b> (2006.01) <b>A61P 35/00</b> (2006.01) <b>C07D 401/02</b> (2006.01) <b>C07D 471/04</b> (2006.01)
3686194	<b>A61K 31/437</b> (2006.01) <b>A61K 31/506</b> (2006.01) <b>A61P 35/00</b> (2006.01) <b>C07D 401/02</b> (2006.01) <b>C07D 471/04</b> (2006.01)
3797797	<b>A61K 31/52</b> (2006.01) <b>A61K 47/68</b> (2017.01)

Broj objave evropske prijava patenta (97)	MKP (51)
	<b>A61P 35/00</b> (2006.01) <b>C07D 487/04</b> (2006.01) <b>C07H 15/26</b> (2006.01)
3689874	<b>A61K 31/4162</b> (2006.01) <b>A61K 31/437</b> (2006.01) <b>A61K 31/4745</b> (2006.01) <b>A61P 25/00</b> (2006.01) <b>A61P 25/14</b> (2006.01) <b>A61P 25/16</b> (2006.01) <b>A61P 25/18</b> (2006.01) <b>A61P 25/22</b> (2006.01) <b>A61P 25/24</b> (2006.01) <b>A61P 25/28</b> (2006.01) <b>A61P 43/00</b> (2006.01) <b>C07D 305/06</b> (2006.01) <b>C07D 401/04</b> (2006.01) <b>C07D 413/04</b> (2006.01) <b>C07D 471/04</b> (2006.01)
3683235	<b>C07K 16/24</b> (2006.01)
3708579	<b>A61K 35/26</b> (2015.01) <b>A61P 35/00</b> (2006.01) <b>C07K 14/47</b> (2006.01) <b>C07K 14/725</b> (2006.01)
3679869	<b>A61B 17/00</b> (2006.01) <b>A61B 17/072</b> (2006.01) <b>A61B 17/29</b> (2006.01) <b>A61B 90/00</b> (2016.01) <b>A61B 90/98</b> (2016.01)
3693395	<b>A61K 39/00</b> (2006.01) <b>A61P 1/04</b> (2006.01) <b>A61P 7/00</b> (2006.01) <b>A61P 9/00</b> (2006.01) <b>A61P 11/00</b> (2006.01) <b>A61P 11/02</b> (2006.01) <b>A61P 17/00</b> (2006.01) <b>A61P 17/02</b> (2006.01) <b>A61P 19/02</b> (2006.01) <b>A61P 19/08</b> (2006.01) <b>A61P 25/00</b> (2006.01) <b>A61P 27/16</b> (2006.01) <b>A61P 29/00</b> (2006.01) <b>A61P 31/04</b> (2006.01) <b>A61P 35/00</b> (2006.01) <b>A61P 37/00</b> (2006.01) <b>A61P 37/02</b> (2006.01) <b>A61P 37/06</b> (2006.01) <b>A61P 37/08</b> (2006.01) <b>A61P 43/00</b> (2006.01) <b>C07K 16/28</b> (2006.01)
3682879	<b>A61K 31/445</b> (2006.01) <b>C07D 211/60</b> (2006.01)
3708813	<b>F02D 11/10</b> (2006.01) <b>F02D 41/14</b> (2006.01)
3709113	<b>G05B 19/418</b> (2006.01) <b>G06F 21/64</b> (2013.01)

Broj objave evropske prijava patenta (97)	MKP (51)
	<b>H04L 9/32</b> (2006.01)
3683316	<b>C12N 5/02</b> (2006.01) <b>C12P 21/02</b> (2006.01)
3689380	<b>A61K 9/48</b> (2006.01) <b>A61K 31/047</b> (2006.01) <b>A61K 47/14</b> (2017.01) <b>A61P 1/00</b> (2006.01) <b>A61P 1/04</b> (2006.01) <b>A61P 3/02</b> (2006.01) <b>A61P 3/12</b> (2006.01) <b>A61P 3/14</b> (2006.01) <b>A61P 5/18</b> (2006.01) <b>A61P 7/00</b> (2006.01) <b>A61P 13/12</b> (2006.01) <b>A61P 19/00</b> (2006.01) <b>A61P 19/02</b> (2006.01) <b>A61P 19/08</b> (2006.01) <b>A61P 19/10</b> (2006.01) <b>A61P 43/00</b> (2006.01)
3698782	<b>A61K 31/27</b> (2006.01) <b>A61K 31/325</b> (2006.01) <b>C07C 269/00</b> (2006.01) <b>C07C 271/00</b> (2006.01) <b>C07C 271/62</b> (2006.01) <b>C07D 203/20</b> (2006.01)
3788120	<b>C09K 11/56</b> (2006.01) <b>C09K 11/88</b> (2006.01) <b>G01N 21/64</b> (2006.01)
3788074	<b>A61K 39/00</b> (2006.01) <b>A61P 35/00</b> (2006.01) <b>C07K 16/28</b> (2006.01) <b>C07K 16/46</b> (2006.01)
3793553	<b>A61K 31/427</b> (2006.01) <b>A61P 9/04</b> (2006.01) <b>A61P 9/10</b> (2006.01) <b>A61P 9/12</b> (2006.01) <b>A61P 25/28</b> (2006.01)
3788040	<b>C07D 401/12</b> (2006.01) <b>C07D 401/14</b> (2006.01) <b>C07D 403/04</b> (2006.01) <b>C07D 403/12</b> (2006.01) <b>C07D 405/14</b> (2006.01) <b>C07D 413/14</b> (2006.01) <b>C07D 417/12</b> (2006.01) <b>C07D 417/14</b> (2006.01) <b>C07D 451/02</b> (2006.01) <b>C07D 471/04</b> (2006.01) <b>C07D 471/08</b> (2006.01) <b>C07D 471/10</b> (2006.01) <b>C07D 487/04</b> (2006.01) <b>C07D 487/08</b> (2006.01) <b>C07D 487/10</b> (2006.01)
3784804	<b>C12Q 1/6886</b> (2018.01)

Broj objave evropske prijave patenta (97)	MKP (51)
3790884	<b>A61K 31/55</b> (2006.01) <b>A61P 35/00</b> (2006.01) <b>C07D 498/14</b> (2006.01)
3790590	<b>A61K 47/54</b> (2017.01) <b>A61K 47/58</b> (2017.01) <b>A61K 47/64</b> (2017.01) <b>A61K 47/65</b> (2017.01) <b>A61K 47/68</b> (2017.01) <b>A61K 51/06</b> (2006.01) <b>A61K 51/10</b> (2006.01) <b>A61P 35/00</b> (2006.01)
3794355	<b>G01N 33/68</b> (2006.01)
3788037	<b>A61P 3/00</b> (2006.01) <b>A61P 9/00</b> (2006.01) <b>A61P 13/12</b> (2006.01) <b>C07D 239/545</b> (2006.01) <b>C07D 401/12</b> (2006.01) <b>C07D 401/14</b> (2006.01) <b>C07D 403/14</b> (2006.01) <b>C07D 405/14</b> (2006.01)
3793554	<b>A61K 31/427</b> (2006.01) <b>A61P 11/00</b> (2006.01) <b>A61P 11/06</b> (2006.01) <b>A61P 11/14</b> (2006.01) <b>A61P 25/28</b> (2006.01)
3784676	<b>A61K 31/537</b> (2006.01) <b>A61P 31/18</b> (2006.01) <b>C07D 498/18</b> (2006.01)
3781609	<b>C08G 64/02</b> (2006.01) <b>C08G 64/42</b> (2006.01) <b>C08L 69/00</b> (2006.01)
3788044	<b>A61K 31/553</b> (2006.01) <b>A61P 29/00</b> (2006.01) <b>A61P 37/02</b> (2006.01) <b>C07D 413/12</b> (2006.01) <b>C07D 413/14</b> (2006.01)
3788076	<b>A61K 39/395</b> (2006.01) <b>C07K 16/28</b> (2006.01)
3781523	<b>C02F 1/04</b> (2006.01) <b>C02F 3/28</b> (2006.01) <b>C02F 11/04</b> (2006.01)
3788045	<b>A61K 31/553</b> (2006.01) <b>A61P 29/00</b> (2006.01) <b>A61P 37/02</b> (2006.01) <b>C07D 413/12</b> (2006.01) <b>C07D 413/14</b> (2006.01)
3788046	<b>A61K 31/519</b> (2006.01) <b>A61P 35/00</b> (2006.01) <b>C07D 471/14</b> (2006.01)

Broj objave evropske prijave patenta (97)	MKP (51)
3788047	<b>A61K 31/519</b> (2006.01) <b>A61P 35/00</b> (2006.01) <b>C07D 471/14</b> (2006.01)
3787599	<b>A61K 9/12</b> (2006.01) <b>A61K 9/51</b> (2006.01) <b>A61K 31/454</b> (2006.01)
3790564	<b>A23L 33/135</b> (2016.01) <b>A61K 35/74</b> (2015.01) <b>A61P 1/00</b> (2006.01) <b>A61P 3/10</b> (2006.01) <b>A61P 11/06</b> (2006.01) <b>A61P 17/06</b> (2006.01) <b>A61P 19/02</b> (2006.01) <b>A61P 35/00</b> (2006.01) <b>A61P 37/00</b> (2006.01) <b>A61P 43/00</b> (2006.01)
3793559	<b>A61K 31/4985</b> (2006.01) <b>A61P 7/00</b> (2006.01) <b>A61P 27/02</b> (2006.01) <b>C07D 487/04</b> (2006.01)
3788053	<b>A61K 31/553</b> (2006.01) <b>A61K 45/06</b> (2006.01) <b>C07F 9/6561</b> (2006.01)
3790972	<b>A61K 31/7125</b> (2006.01) <b>A61P 31/14</b> (2006.01) <b>C12N 15/113</b> (2010.01)
3790899	<b>A61K 47/68</b> (2017.01) <b>C07K 16/28</b> (2006.01)
3790886	<b>A61K 31/549</b> (2006.01) <b>A61P 35/00</b> (2006.01) <b>C07D 513/04</b> (2006.01)
3790877	<b>A61K 31/437</b> (2006.01) <b>A61P 35/00</b> (2006.01) <b>A61P 37/00</b> (2006.01) <b>C07D 471/04</b> (2006.01)
3790897	<b>A61P 27/02</b> (2006.01) <b>C07K 16/18</b> (2006.01)
3797134	<b>B32B 27/36</b> (2006.01) <b>C08J 5/18</b> (2006.01) <b>C08K 9/02</b> (2006.01) <b>C08K 9/04</b> (2006.01) <b>C08K 9/06</b> (2006.01) <b>C09C 1/02</b> (2006.01)
3781746	<b>E01F 9/588</b> (2016.01)
3784663	<b>A61K 31/454</b> (2006.01) <b>A61P 35/00</b> (2006.01) <b>C07D 401/04</b> (2006.01) <b>C07D 401/14</b> (2006.01) <b>C07D 417/14</b> (2006.01) <b>C07D 491/08</b> (2006.01)



Broj objave evropske prijava patenta (97)	MKP (51)
	<b>C07D 491/10</b> (2006.01)
3784666	<b>A61K 31/553</b> (2006.01) <b>A61P 35/00</b> (2006.01) <b>C07D 403/04</b> (2006.01) <b>C07D 409/14</b> (2006.01) <b>C07D 413/04</b> (2006.01) <b>C07D 413/14</b> (2006.01)
3784694	<b>A61K 39/00</b> (2006.01) <b>A61P 37/06</b> (2006.01) <b>C07K 14/725</b> (2006.01) <b>C07K 14/74</b> (2006.01) <b>C12N 15/113</b> (2010.01)
3790859	<b>A61K 31/4015</b> (2006.01) <b>A61K 31/497</b> (2006.01) <b>A61P 25/00</b> (2006.01) <b>C07D 207/20</b> (2006.01) <b>C07D 209/96</b> (2006.01) <b>C07D 401/06</b> (2006.01) <b>C07D 401/12</b> (2006.01) <b>C07D 471/10</b> (2006.01) <b>C07D 487/04</b> (2006.01)
3790548	<b>A61K 31/472</b> (2006.01) <b>A61P 25/08</b> (2006.01)
3790532	<b>A61K 9/00</b> (2006.01) <b>A61K 9/08</b> (2006.01) <b>A61K 38/17</b> (2006.01) <b>A61K 47/22</b> (2006.01) <b>A61K 47/26</b> (2006.01) <b>A61P 27/02</b> (2006.01)
3784346	<b>A61K 38/09</b> (2006.01) <b>A61P 5/30</b> (2006.01)
3784664	<b>A61P 35/00</b> (2006.01) <b>C07D 401/14</b> (2006.01) <b>C07D 405/14</b> (2006.01) <b>C07D 487/04</b> (2006.01) <b>C07D 498/04</b> (2006.01)
3787751	<b>A61K 35/17</b> (2015.01) <b>A61K 39/00</b> (2006.01) <b>A61P 35/00</b> (2006.01)
3790904	<b>C07K 16/18</b> (2006.01) <b>C07K 16/24</b> (2006.01) <b>C07K 16/28</b> (2006.01) <b>C07K 16/46</b> (2006.01)
3789020	<b>A61K 31/137</b> (2006.01) <b>A61K 31/167</b> (2006.01)
3784670	<b>A61K 31/519</b> (2006.01) <b>A61P 35/00</b> (2006.01) <b>C07D 471/04</b> (2006.01) <b>C07D 498/04</b> (2006.01) <b>C07D 513/04</b> (2006.01)

Broj objave evropske prijava patenta (97)	MKP (51)
	<b>C07D 519/00</b> (2006.01)
3790417	<b>A24D 1/14</b> (2006.01) <b>A24F 1/30</b> (2006.01)
3790415	<b>A24D 1/14</b> (2006.01)
3781505	<b>B65H 35/00</b> (2006.01)
3794008	<b>A61K 9/127</b> (2006.01) <b>A61K 47/26</b> (2006.01) <b>C07H 13/06</b> (2006.01) <b>C07H 13/12</b> (2006.01) <b>C07H 15/04</b> (2006.01) <b>C07H 15/10</b> (2006.01) <b>C07H 15/26</b> (2006.01)
3793591	<b>A61K 38/47</b> (2006.01) <b>A61P 43/00</b> (2006.01) <b>C07K 16/28</b> (2006.01) <b>C12N 9/34</b> (2006.01)
3793607	<b>A61K 39/395</b> (2006.01) <b>A61K 45/06</b> (2006.01) <b>A61P 35/00</b> (2006.01)
3765011	<b>A61K 31/40</b> (2006.01) <b>A61K 31/454</b> (2006.01) <b>A61K 45/06</b> (2006.01)
3787620	<b>A61K 31/4162</b> (2006.01) <b>A61K 31/4985</b> (2006.01) <b>A61P 35/00</b> (2006.01) <b>A61P 35/02</b> (2006.01)
3796942	<b>A61K 47/68</b> (2017.01) <b>A61P 35/00</b> (2006.01) <b>C07K 16/28</b> (2006.01)
3796889	<b>A61K 9/00</b> (2006.01) <b>A61K 9/19</b> (2006.01) <b>A61K 31/4178</b> (2006.01) <b>A61K 47/10</b> (2017.01)
3791361	<b>G06T 7/136</b> (2017.01) <b>G06T 7/143</b> (2017.01)
3796802	<b>A41D 31/00</b> (2019.01) <b>D03D 1/00</b> (2006.01) <b>D03D 11/00</b> (2006.01) <b>D03D 13/00</b> (2006.01) <b>D03D 15/00</b> (2021.01) <b>D03D 15/08</b> (2006.01) <b>D03D 15/10</b> (2006.01)
3796893	<b>A61K 9/127</b> (2006.01) <b>A61K 9/51</b> (2006.01) <b>A61K 31/7088</b> (2006.01)
3788038	<b>A61K 31/519</b> (2006.01) <b>A61P 35/00</b> (2006.01)

Broj objave evropske prijave patenta (97)	MKP (51)
	<b>C07D 403/04</b> (2006.01) <b>C07D 403/14</b> (2006.01) <b>C07D 471/04</b> (2006.01) <b>C07D 487/04</b> (2006.01)
3784655	<b>C07D 211/02</b> (2006.01) <b>C07D 211/34</b> (2006.01)
3784239	<b>A61K 31/496</b> (2006.01) <b>A61K 39/395</b> (2006.01) <b>A61K 47/68</b> (2017.01) <b>C07K 16/28</b> (2006.01) <b>C07K 16/30</b> (2006.01)
3785029	<b>G01N 33/50</b> (2006.01)
3784688	<b>A61K 39/00</b> (2006.01) <b>C07K 14/005</b> (2006.01) <b>C07K 14/19</b> (2006.01) <b>C07K 14/47</b> (2006.01)
3793994	<b>A61K 31/53</b> (2006.01) <b>A61K 31/55</b> (2006.01) <b>A61P 37/00</b> (2006.01) <b>C07D 403/14</b> (2006.01) <b>C07D 405/14</b> (2006.01) <b>C07D 413/14</b> (2006.01)
3794009	<b>A61K 31/7034</b> (2006.01) <b>A61P 3/10</b> (2006.01) <b>A61P 25/02</b> (2006.01) <b>C07D 309/06</b> (2006.01) <b>C07H 1/00</b> (2006.01) <b>C07H 15/203</b> (2006.01)
3793588	<b>A61K 38/36</b> (2006.01) <b>A61K 38/37</b> (2006.01) <b>A61P 7/04</b> (2006.01)
3796940	<b>A61K 47/60</b> (2017.01) <b>A61P 37/00</b> (2006.01)
3794126	<b>A61K 38/51</b> (2006.01) <b>A61K 48/00</b> (2006.01) <b>C12N 15/62</b> (2006.01) <b>C12N 15/86</b> (2006.01)
3784472	<b>B29C 64/106</b> (2017.01) <b>B29C 64/118</b> (2017.01) <b>B29C 64/245</b> (2017.01) <b>B29C 64/379</b> (2017.01) <b>B29C 64/40</b> (2017.01) <b>B33Y 10/00</b> (2015.01) <b>B33Y 70/00</b> (2020.01)
3793599	<b>A61K 39/00</b> (2006.01) <b>A61K 39/395</b> (2006.01) <b>A61K 45/06</b> (2006.01) <b>C07K 16/28</b> (2006.01) <b>C07K 16/30</b> (2006.01)

---

Broj objave evropske prijava patenta (97)	MKP (51)
3793358	<b>A01N 25/10</b> (2006.01) <b>A01N 25/34</b> (2006.01) <b>A01N 35/04</b> (2006.01) <b>A01N 37/24</b> (2006.01) <b>A01N 65/12</b> (2009.01) <b>A01N 65/20</b> (2009.01) <b>A01N 65/48</b> (2009.01) <b>A01P 1/00</b> (2006.01) <b>A61K 9/20</b> (2006.01) <b>A61K 31/11</b> (2006.01) <b>A61K 31/167</b> (2006.01) <b>A61K 36/28</b> (2006.01) <b>A61K 36/484</b> (2006.01) <b>A61K 36/9062</b> (2006.01)
3790545	<b>A61K 31/365</b> (2006.01) <b>A61K 31/551</b> (2006.01) <b>A61K 45/06</b> (2006.01)
3787746	<b>A61P 3/00</b> (2006.01) <b>C07K 16/28</b> (2006.01)
3662900	<b>A61K 9/28</b> (2006.01) <b>A61K 31/606</b> (2006.01)
3662898	<b>A61K 9/20</b> (2006.01) <b>A61K 9/28</b> (2006.01) <b>A61K 31/606</b> (2006.01)
3662895	<b>A61K 9/16</b> (2006.01) <b>A61K 9/20</b> (2006.01) <b>A61K 31/606</b> (2006.01)
3662901	<b>A61K 9/20</b> (2006.01) <b>A61K 9/28</b> (2006.01) <b>A61K 9/48</b> (2006.01) <b>A61K 31/606</b> (2006.01)
3662902	<b>A61K 9/28</b> (2006.01)
3667086	<b>F04C 18/02</b> (2006.01) <b>F04C 27/00</b> (2006.01) <b>F04C 29/00</b> (2006.01)

---

**INDEKS KLASIFIKACIONIH OZNAKA ZAHTJEVA ZA PROŠIRENJE EVROPSKIH  
PRIJAVA PATENTA PREMA MEĐUNARODNOJ KLASIFIKACIJI PATENATA  
Index on classification marks on requests for extension of european patent  
application in accordance with the international patent classification**

MKP (51)	Broj objave evropske prijava patenta (97)	Naziv pronalaska (54)
<b>A61K 9/20</b> (2006.01)	3162362	OPTIMIZED HIGH-DOSE TABLET OF MESALAZINE
<b>A61K 9/28</b> (2006.01)	3162362	OPTIMIZED HIGH-DOSE TABLET OF MESALAZINE
<b>A61K 31/606</b> (2006.01)	3162362	OPTIMIZED HIGH-DOSE TABLET OF MESALAZINE
<b>A61B 18/00</b> (2006.01)	3153124	CATHETER WITH MEMBRANED SPINES FOR PULMONARY VEIN ISOLATION
<b>A61B 18/02</b> (2006.01)	3153124	CATHETER WITH MEMBRANED SPINES FOR PULMONARY VEIN ISOLATION
<b>A61B 18/14</b> (2006.01)	3153124	CATHETER WITH MEMBRANED SPINES FOR PULMONARY VEIN ISOLATION
<b>A23L 2/52</b> (2006.01)	3250052	A NATURAL SWEETENING COMPOSITION OF LUO HAN GUO
<b>A23L 2/60</b> (2006.01)	3250052	A NATURAL SWEETENING COMPOSITION OF LUO HAN GUO
<b>A23L 27/12</b> (2016.01)	3250052	A NATURAL SWEETENING COMPOSITION OF LUO HAN GUO
<b>A23L 2/52</b> (2006.01)	3250053	A Natural Sweetener
<b>A23L 2/60</b> (2006.01)	3250053	A Natural Sweetener
<b>A23L 27/12</b> (2016.01)	3250053	A Natural Sweetener
<b>G10K 11/178</b> (2006.01)	3644620	IN-EAR ANC EARPHONE
<b>H04R</b> (2006.01)	3644620	IN-EAR ANC EARPHONE
<b>H04R 1/10</b> (2006.01)	3644620	IN-EAR ANC EARPHONE
<b>H04R 1/28</b> (2006.01)	3644620	IN-EAR ANC EARPHONE
<b>A61K 39/395</b> (2006.01)	3679949	METHODS OF TREATING CONDITIONS WITH ANTIBODIES THAT BIND COLONY STIMULATING FACTOR 1 RECEPTOR (CSF1R)
<b>A61P 19/02</b> (2006.01)	3679949	METHODS OF TREATING CONDITIONS WITH ANTIBODIES THAT BIND COLONY STIMULATING FACTOR 1 RECEPTOR (CSF1R)
<b>A61P 29/00</b> (2006.01)	3679949	METHODS OF TREATING CONDITIONS WITH ANTIBODIES THAT BIND COLONY STIMULATING FACTOR 1 RECEPTOR (CSF1R)
<b>C07K 16/28</b> (2006.01)	3679949	METHODS OF TREATING CONDITIONS WITH ANTIBODIES THAT BIND COLONY STIMULATING FACTOR 1 RECEPTOR (CSF1R)
<b>C12Q 1/48</b> (2006.01)	3679949	METHODS OF TREATING CONDITIONS WITH ANTIBODIES THAT BIND COLONY STIMULATING FACTOR 1 RECEPTOR (CSF1R)
<b>G01N 33/564</b> (2006.01)	3679949	METHODS OF TREATING CONDITIONS WITH ANTIBODIES THAT BIND COLONY STIMULATING FACTOR 1 RECEPTOR (CSF1R)
<b>F25D 3/12</b> (2006.01)	3686524	COOLING SYSTEM FOR STORING AND COOLING PRODUCTS DURING TRANSPORT ON A REFRIGERATED TRANSPORT VEHICLE
<b>F25D 11/00</b> (2006.01)	3686524	COOLING SYSTEM FOR STORING AND COOLING PRODUCTS DURING TRANSPORT ON A REFRIGERATED TRANSPORT VEHICLE
<b>F25D 17/06</b> (2006.01)	3686524	COOLING SYSTEM FOR STORING AND COOLING PRODUCTS DURING TRANSPORT ON A REFRIGERATED TRANSPORT VEHICLE
<b>F25D 29/00</b> (2006.01)	3686524	COOLING SYSTEM FOR STORING AND COOLING PRODUCTS DURING TRANSPORT ON A REFRIGERATED TRANSPORT VEHICLE
<b>A61K 39/395</b> (2006.01)	3536342	METHODS FOR TREATING OR PREVENTING INFLUENZA VIRUS INFECTION BY ADMINISTERING A SERINE PROTEASE INHIBITOR
<b>A61P 31/16</b> (2006.01)	3536342	METHODS FOR TREATING OR PREVENTING INFLUENZA VIRUS INFECTION BY ADMINISTERING A SERINE PROTEASE INHIBITOR
<b>F17C 6/00</b> (2006.01)	3693652	FILLING STATION FOR GAS BOTTLES AND MOTOR VEHICLES
<b>A01H 5/06</b> (2018.01)	3696188	GENE FOR RESISTANCE TO PLANT DISEASE
<b>A01H 6/02</b> (2018.01)	3696188	GENE FOR RESISTANCE TO PLANT DISEASE
<b>C07K 14/415</b> (2006.01)	3696188	GENE FOR RESISTANCE TO PLANT DISEASE
<b>C12N 15/82</b> (2006.01)	3696188	GENE FOR RESISTANCE TO PLANT DISEASE
<b>A01K 67/027</b> (2006.01)	3629719	METHODS FOR GENDER DETERMINATION OF AVIAN EMBRYOS IN UNHATCHED EGGS AND MEANS THEREOF
<b>C12N 9/02</b> (2006.01)	3629719	METHODS FOR GENDER DETERMINATION OF AVIAN EMBRYOS IN UNHATCHED EGGS AND MEANS THEREOF
<b>C12N 15/10</b> (2006.01)	3629719	METHODS FOR GENDER DETERMINATION OF AVIAN EMBRYOS IN UNHATCHED EGGS AND MEANS THEREOF

MKP (51)	Broj objave evropske prijava patenta (97)	Naziv pronalaska (54)
<b>C12N 15/90</b> (2006.01)	3629719	METHODS FOR GENDER DETERMINATION OF AVIAN EMBRYOS IN UNHATCHED EGGS AND MEANS THEREOF
<b>A61K 9/16</b> (2006.01)	3761965	TICAGRELOR-CONTAINING TABLET FORMULATION
<b>A61K 9/20</b> (2006.01)	3761965	TICAGRELOR-CONTAINING TABLET FORMULATION
<b>C02F 1/34</b> (2006.01)	3762336	METHOD FOR THE CAVITATION CLEANING OF WATER-BASED SUBSTANCES AND EQUIPMENT FOR THE IMPLEMENTATION OF THE METHOD
<b>E21B 7/04</b> (2006.01)	3781777	MONITORING OPERATING CONDITIONS OF A ROTARY STEERABLE SYSTEM
<b>E21B 7/06</b> (2006.01)	3781777	MONITORING OPERATING CONDITIONS OF A ROTARY STEERABLE SYSTEM
<b>E21B 23/04</b> (2006.01)	3794210	LINER HANGER SYSTEM
<b>E21B 43/10</b> (2006.01)	3794210	LINER HANGER SYSTEM
<b>E21B 33/12</b> (2006.01)	3781781	TOOL FOR TESTING WITHIN A WELLBORE
<b>E21B 33/122</b> (2006.01)	3781781	TOOL FOR TESTING WITHIN A WELLBORE
<b>E21B 33/124</b> (2006.01)	3781781	TOOL FOR TESTING WITHIN A WELLBORE
<b>E21B 37/02</b> (2006.01)	3781781	TOOL FOR TESTING WITHIN A WELLBORE
<b>E21B 49/00</b> (2006.01)	3781781	TOOL FOR TESTING WITHIN A WELLBORE
<b>F23B 80/04</b> (2006.01)	3765791	PROCESS AND DEVICE FOR IMPROVING OF SYNTHESIS AND/OR FLUE GAS VELOCITY FIELD FOR REFUSE DERIVED FUEL APPLICATIONS
<b>F23G 5/027</b> (2006.01)	3765791	PROCESS AND DEVICE FOR IMPROVING OF SYNTHESIS AND/OR FLUE GAS VELOCITY FIELD FOR REFUSE DERIVED FUEL APPLICATIONS
<b>F23G 5/16</b> (2006.01)	3765791	PROCESS AND DEVICE FOR IMPROVING OF SYNTHESIS AND/OR FLUE GAS VELOCITY FIELD FOR REFUSE DERIVED FUEL APPLICATIONS
<b>E21B 43/12</b> (2006.01)	3781782	CONTROLLING WATER INFLOW IN A WELLBORE
<b>E21B 43/14</b> (2006.01)	3781782	CONTROLLING WATER INFLOW IN A WELLBORE
<b>E21B 43/32</b> (2006.01)	3781782	CONTROLLING WATER INFLOW IN A WELLBORE
<b>E21B 47/10</b> (2012.01)	3781782	CONTROLLING WATER INFLOW IN A WELLBORE
<b>E21B 47/12</b> (2012.01)	3781782	CONTROLLING WATER INFLOW IN A WELLBORE
<b>A61K 38/18</b> (2006.01)	3586867	PLACENTA GROWTH FACTOR IN TREATING DUCHENNE MUSCULAR DYSTROPHY
<b>A61P 21/00</b> (2006.01)	3586867	PLACENTA GROWTH FACTOR IN TREATING DUCHENNE MUSCULAR DYSTROPHY
<b>C07K 14/515</b> (2006.01)	3586867	PLACENTA GROWTH FACTOR IN TREATING DUCHENNE MUSCULAR DYSTROPHY
<b>C12Q 1/6855</b> (2018.01)	3631012	HIGH-THROUGHPUT POLYNUCLEOTIDE LIBRARY SEQUENCING AND TRANSCRIPTOME ANALYSIS
<b>E21B 7/14</b> (2006.01)	3794211	LASER TOOL
<b>E21B 7/15</b> (2006.01)	3794211	LASER TOOL
<b>E21B 43/11</b> (2006.01)	3794211	LASER TOOL
<b>B65G 5/00</b> (2006.01)	3797080	MANAGING STORAGE OF WATER
<b>E21B 43/12</b> (2006.01)	3797080	MANAGING STORAGE OF WATER
<b>E21B 43/26</b> (2006.01)	3797209	DOWNHOLE TOOL FOR FRACTURING A FORMATION CONTAINING HYDROCARBONS
<b>B64C 39/02</b> (2006.01)	3770066	DRONE FOR LOW-NOISE DELIVERY OF OBJECTS
<b>A01N 1/02</b> (2006.01)	3775165	PROCESSES FOR PRODUCTION OF TUMOR INFILTRATING LYMPHOCYTES AND USES OF SAME IN IMMUNOTHERAPY
<b>A61K 35/17</b> (2015.01)	3775165	PROCESSES FOR PRODUCTION OF TUMOR INFILTRATING LYMPHOCYTES AND USES OF SAME IN IMMUNOTHERAPY
<b>C12M 3/00</b> (2006.01)	3775165	PROCESSES FOR PRODUCTION OF TUMOR INFILTRATING LYMPHOCYTES AND USES OF SAME IN IMMUNOTHERAPY
<b>C12N 5/0783</b> (2010.01)	3775165	PROCESSES FOR PRODUCTION OF TUMOR INFILTRATING LYMPHOCYTES AND USES OF SAME IN IMMUNOTHERAPY
<b>C25B 1/04</b> (2006.01)	3699322	ELECTROLYTIC CELL
<b>C25B 9/06</b> (2006.01)	3699322	ELECTROLYTIC CELL
<b>C25B 11/02</b> (2006.01)	3699322	ELECTROLYTIC CELL
<b>C25B 15/08</b> (2006.01)	3699322	ELECTROLYTIC CELL
<b>F02B 43/10</b> (2006.01)	3699322	ELECTROLYTIC CELL
<b>F02M 25/12</b> (2006.01)	3699322	ELECTROLYTIC CELL
<b>G08B 5/36</b> (2006.01)	3534343	LIGHT SIGNALING DEVICE APPLICABLE TO ACCESS PASSAGES
<b>G08B 5/38</b> (2006.01)	3534343	LIGHT SIGNALING DEVICE APPLICABLE TO ACCESS PASSAGES
<b>A61K 39/40</b> (2006.01)	3617227	NEUTRALISING ANTIBODIES TO THE MAJOR EXOTOXIN TCDA OF CLOSTRIDIUM DIFFICILE
<b>A61P 31/04</b> (2006.01)	3617227	NEUTRALISING ANTIBODIES TO THE MAJOR EXOTOXIN TCDA OF CLOSTRIDIUM DIFFICILE

MKP	Broj objave evropske prijave patenta (97)	Naziv pronalaska (54)
(51)		(54)
<b>C07K 16/12</b> (2006.01)	3617227	NEUTRALISING ANTIBODIES TO THE MAJOR EXOTOXIN TCDA OF CLOSTRIDIUM DIFFICILE
<b>A61P 3/06</b> (2006.01)	3536712	METHODS FOR REDUCING LIPOPROTEIN(A) LEVELS BY ADMINISTERING AN INHIBITOR OF PROPROTEIN CONVERTASE SUBTILISIN KEXIN-9 (PCSK9)
<b>C07K 16/40</b> (2006.01)	3536712	METHODS FOR REDUCING LIPOPROTEIN(A) LEVELS BY ADMINISTERING AN INHIBITOR OF PROPROTEIN CONVERTASE SUBTILISIN KEXIN-9 (PCSK9)
<b>B61L 23/04</b> (2006.01)	3708990	FIBER OPTIC SENSOR UNIT, OPTICAL MEASURING SYSTEM, AXLE-COUNTING DEVICE AXLE-COUNTING METHOD
<b>G01L 1/24</b> (2006.01)	3708990	FIBER OPTIC SENSOR UNIT, OPTICAL MEASURING SYSTEM, AXLE-COUNTING DEVICE AXLE-COUNTING METHOD
<b>G01L 19/06</b> (2006.01)	3708990	FIBER OPTIC SENSOR UNIT, OPTICAL MEASURING SYSTEM, AXLE-COUNTING DEVICE AXLE-COUNTING METHOD
<b>G01M 5/00</b> (2006.01)	3708990	FIBER OPTIC SENSOR UNIT, OPTICAL MEASURING SYSTEM, AXLE-COUNTING DEVICE AXLE-COUNTING METHOD
<b>E21B 36/00</b> (2006.01)	3788231	CREATING FRACTURES IN A FORMATION USING ELECTROMAGNETIC SIGNALS
<b>E21B 43/26</b> (2006.01)	3788231	CREATING FRACTURES IN A FORMATION USING ELECTROMAGNETIC SIGNALS
<b>E21B 28/00</b> (2006.01)	3797206	LASER-INDUCED PLASMA TOOL
<b>E21B 43/00</b> (2006.01)	3797206	LASER-INDUCED PLASMA TOOL
<b>E21B 43/11</b> (2006.01)	3797206	LASER-INDUCED PLASMA TOOL
<b>E21B 43/26</b> (2006.01)	3797206	LASER-INDUCED PLASMA TOOL
<b>G01N 27/74</b> (2006.01)	3797290	DETECTING SATURATION LEVELS OF A CORE SAMPLE USING MAGNETIC FIELDS
<b>G01N 33/28</b> (2006.01)	3797290	DETECTING SATURATION LEVELS OF A CORE SAMPLE USING MAGNETIC FIELDS
<b>G01V 3/10</b> (2006.01)	3797290	DETECTING SATURATION LEVELS OF A CORE SAMPLE USING MAGNETIC FIELDS
<b>G01N 22/00</b> (2006.01)	3791177	IDENTIFYING CONTENT IN A CONDUIT
<b>G01N 33/18</b> (2006.01)	3791177	IDENTIFYING CONTENT IN A CONDUIT
<b>G01N 33/24</b> (2006.01)	3791177	IDENTIFYING CONTENT IN A CONDUIT
<b>G01N 33/28</b> (2006.01)	3791177	IDENTIFYING CONTENT IN A CONDUIT
<b>C01D 3/06</b> (2006.01)	3691996	A SALT RECOVERY SOLUTION AND PROCESSES OF USE THEREOF
<b>C02F 1/26</b> (2006.01)	3691996	A SALT RECOVERY SOLUTION AND PROCESSES OF USE THEREOF
<b>A61K 39/395</b> (2006.01)	3699194	ANTIBODY CONSTRUCTS FOR CDH19 AND CD3
<b>A61K 47/68</b> (2017.01)	3699194	ANTIBODY CONSTRUCTS FOR CDH19 AND CD3
<b>A61P 35/00</b> (2006.01)	3699194	ANTIBODY CONSTRUCTS FOR CDH19 AND CD3
<b>C07K 16/28</b> (2006.01)	3699194	ANTIBODY CONSTRUCTS FOR CDH19 AND CD3
<b>C07K 16/30</b> (2006.01)	3699194	ANTIBODY CONSTRUCTS FOR CDH19 AND CD3
<b>C07K 16/46</b> (2006.01)	3699194	ANTIBODY CONSTRUCTS FOR CDH19 AND CD3
<b>A61K 31/437</b> (2006.01)	3689873	ESTROGEN RECEPTOR MODULATORS
<b>A61K 31/501</b> (2006.01)	3689873	ESTROGEN RECEPTOR MODULATORS
<b>A61K 31/506</b> (2006.01)	3689873	ESTROGEN RECEPTOR MODULATORS
<b>A61P 35/00</b> (2006.01)	3689873	ESTROGEN RECEPTOR MODULATORS
<b>C07D 471/04</b> (2006.01)	3689873	ESTROGEN RECEPTOR MODULATORS
<b>A61K 31/55</b> (2006.01)	3660010	S1P MODULATING AGENTS
<b>A61P 25/00</b> (2006.01)	3660010	S1P MODULATING AGENTS
<b>C07D 211/34</b> (2006.01)	3660010	S1P MODULATING AGENTS
<b>C07D 211/60</b> (2006.01)	3660010	S1P MODULATING AGENTS
<b>C07D 211/62</b> (2006.01)	3660010	S1P MODULATING AGENTS
<b>C07D 401/06</b> (2006.01)	3660010	S1P MODULATING AGENTS
<b>C07D 405/12</b> (2006.01)	3660010	S1P MODULATING AGENTS
<b>A61K 35/74</b> (2015.01)	3659613	COMPOSITIONS COMPRISING BACTERIAL STRAINS
<b>A61P 29/00</b> (2006.01)	3659613	COMPOSITIONS COMPRISING BACTERIAL STRAINS
<b>A61P 35/00</b> (2006.01)	3659613	COMPOSITIONS COMPRISING BACTERIAL STRAINS
<b>C12Q 1/68</b> (2018.01)	3647783	IDENTIFYING PATIENT RESPONSE TO S1P RECEPTOR MODULATOR ADMINISTRATION
<b>G01N 33/50</b> (2006.01)	3647783	IDENTIFYING PATIENT RESPONSE TO S1P RECEPTOR MODULATOR ADMINISTRATION
<b>G01N 33/569</b> (2006.01)	3647783	IDENTIFYING PATIENT RESPONSE TO S1P RECEPTOR MODULATOR ADMINISTRATION
<b>E04F 10/08</b> (2006.01)	3647510	SHADING SYSTEM
<b>A61K 39/00</b> (2006.01)	3662931	THERAPEUTIC AGENT OR PROPHYLACTIC AGENT FOR DEMENTIA

MKP (51)	Broj objave evropske prijava patenta (97)	Naziv pronalaska (54)
<b>A61K 39/395</b> (2006.01)	3662931	THERAPEUTIC AGENT OR PROPHYLACTIC AGENT FOR DEMENTIA
<b>A61P 25/28</b> (2006.01)	3662931	THERAPEUTIC AGENT OR PROPHYLACTIC AGENT FOR DEMENTIA
<b>C07K 14/47</b> (2006.01)	3662931	THERAPEUTIC AGENT OR PROPHYLACTIC AGENT FOR DEMENTIA
<b>C07K 16/18</b> (2006.01)	3662931	THERAPEUTIC AGENT OR PROPHYLACTIC AGENT FOR DEMENTIA
<b>C07K 16/46</b> (2006.01)	3662931	THERAPEUTIC AGENT OR PROPHYLACTIC AGENT FOR DEMENTIA
<b>C12N 15/02</b> (2006.01)	3662931	THERAPEUTIC AGENT OR PROPHYLACTIC AGENT FOR DEMENTIA
<b>C12P 21/08</b> (2006.01)	3662931	THERAPEUTIC AGENT OR PROPHYLACTIC AGENT FOR DEMENTIA
<b>A61K 31/7125</b> (2006.01)	3662912	IMPROVED DOSAGES OF ETEPLIRSEN FOR TREATING DUCHENNE MUSCULAR DYSTROPHY
<b>A61P 21/00</b> (2006.01)	3662912	IMPROVED DOSAGES OF ETEPLIRSEN FOR TREATING DUCHENNE MUSCULAR DYSTROPHY
<b>A61K 31/395</b> (2006.01)	3686190	SYNTHESIS OF THERAPEUTICALLY ACTIVE COMPOUNDS
<b>A61P 35/00</b> (2006.01)	3686190	SYNTHESIS OF THERAPEUTICALLY ACTIVE COMPOUNDS
<b>C07D 251/18</b> (2006.01)	3686190	SYNTHESIS OF THERAPEUTICALLY ACTIVE COMPOUNDS
<b>C07D 401/04</b> (2006.01)	3686190	SYNTHESIS OF THERAPEUTICALLY ACTIVE COMPOUNDS
<b>C07D 403/04</b> (2006.01)	3686190	SYNTHESIS OF THERAPEUTICALLY ACTIVE COMPOUNDS
<b>C07D 405/14</b> (2006.01)	3686190	SYNTHESIS OF THERAPEUTICALLY ACTIVE COMPOUNDS
<b>C07D 409/04</b> (2006.01)	3686190	SYNTHESIS OF THERAPEUTICALLY ACTIVE COMPOUNDS
<b>C07D 417/04</b> (2006.01)	3686190	SYNTHESIS OF THERAPEUTICALLY ACTIVE COMPOUNDS
<b>A61P 1/04</b> (2006.01)	3686218	ANTI-BLOOD DENDRITIC CELL ANTIGEN 2 ANTIBODIES AND USES THEREOF
<b>A61P 13/12</b> (2006.01)	3686218	ANTI-BLOOD DENDRITIC CELL ANTIGEN 2 ANTIBODIES AND USES THEREOF
<b>C07K 16/28</b> (2006.01)	3686218	ANTI-BLOOD DENDRITIC CELL ANTIGEN 2 ANTIBODIES AND USES THEREOF
<b>A61P 37/00</b> (2006.01)	3666796	ANTIBODIES AGAINST CLAUDIN 18.2 USEFUL IN CANCER DIAGNOSIS
<b>C07K 16/30</b> (2006.01)	3666796	ANTIBODIES AGAINST CLAUDIN 18.2 USEFUL IN CANCER DIAGNOSIS
<b>A61K 39/395</b> (2006.01)	3670537	THERAPY INVOLVING ANTIBODIES AGAINST CLAUDIN 18.2 FOR TREATMENT OF CANCER
<b>A61P 35/00</b> (2006.01)	3670537	THERAPY INVOLVING ANTIBODIES AGAINST CLAUDIN 18.2 FOR TREATMENT OF CANCER
<b>C07K 16/28</b> (2006.01)	3670537	THERAPY INVOLVING ANTIBODIES AGAINST CLAUDIN 18.2 FOR TREATMENT OF CANCER
<b>C07K 16/30</b> (2006.01)	3670537	THERAPY INVOLVING ANTIBODIES AGAINST CLAUDIN 18.2 FOR TREATMENT OF CANCER
<b>A61K 31/4184</b> (2006.01)	3702351	FORMULATION COMPRISING A MEK INHIBITOR
<b>A61P 35/00</b> (2006.01)	3702351	FORMULATION COMPRISING A MEK INHIBITOR
<b>C07D 235/06</b> (2006.01)	3702351	FORMULATION COMPRISING A MEK INHIBITOR
<b>A61K 38/28</b> (2006.01)	3660040	INSULIN RECEPTOR PARTIAL AGONISTS
<b>A61K 47/60</b> (2017.01)	3660040	INSULIN RECEPTOR PARTIAL AGONISTS
<b>C07K 14/62</b> (2006.01)	3660040	INSULIN RECEPTOR PARTIAL AGONISTS
<b>A61K 38/28</b> (2006.01)	3660041	INSULIN RECEPTOR PARTIAL AGONISTS
<b>A61K 47/60</b> (2017.01)	3660041	INSULIN RECEPTOR PARTIAL AGONISTS
<b>C07K 14/62</b> (2006.01)	3660041	INSULIN RECEPTOR PARTIAL AGONISTS
<b>A61K 38/28</b> (2006.01)	3666792	INSULIN RECEPTOR PARTIAL AGONISTS
<b>A61K 47/60</b> (2017.01)	3666792	INSULIN RECEPTOR PARTIAL AGONISTS
<b>C07K 14/62</b> (2006.01)	3666792	INSULIN RECEPTOR PARTIAL AGONISTS
<b>A61K 47/00</b> (2006.01)	3763738	ANTIBODIES BINDING AXL
<b>A61P 35/00</b> (2006.01)	3763738	ANTIBODIES BINDING AXL
<b>C07K 16/28</b> (2006.01)	3763738	ANTIBODIES BINDING AXL
<b>A61K 39/00</b> (2006.01)	3685854	METHODS OF TREATING A TAUOPATHY
<b>A61K 39/395</b> (2006.01)	3685854	METHODS OF TREATING A TAUOPATHY
<b>A61K 47/60</b> (2017.01)	3685854	METHODS OF TREATING A TAUOPATHY
<b>A61K 51/10</b> (2006.01)	3685854	METHODS OF TREATING A TAUOPATHY
<b>A61P 25/28</b> (2006.01)	3685854	METHODS OF TREATING A TAUOPATHY
<b>C07K 16/18</b> (2006.01)	3685854	METHODS OF TREATING A TAUOPATHY
<b>C12N 15/63</b> (2006.01)	3685854	METHODS OF TREATING A TAUOPATHY
<b>G01N 33/68</b> (2006.01)	3685854	METHODS OF TREATING A TAUOPATHY



MKP (51)	Broj objave evropske prijava patenta (97)	Naziv pronalaska (54)
<b>A61B 5/00</b> (2006.01)	3682798	TITRATION OF HEART RATE TO IMPROVE STIMULATION THERAPY FOR HEART FAILURE PATIENTS
<b>A61B 5/024</b> (2006.01)	3682798	TITRATION OF HEART RATE TO IMPROVE STIMULATION THERAPY FOR HEART FAILURE PATIENTS
<b>A61B 5/0245</b> (2006.01)	3682798	TITRATION OF HEART RATE TO IMPROVE STIMULATION THERAPY FOR HEART FAILURE PATIENTS
<b>A61B 5/0456</b> (2006.01)	3682798	TITRATION OF HEART RATE TO IMPROVE STIMULATION THERAPY FOR HEART FAILURE PATIENTS
<b>A61B 5/0464</b> (2006.01)	3682798	TITRATION OF HEART RATE TO IMPROVE STIMULATION THERAPY FOR HEART FAILURE PATIENTS
<b>A61B 5/11</b> (2006.01)	3682798	TITRATION OF HEART RATE TO IMPROVE STIMULATION THERAPY FOR HEART FAILURE PATIENTS
<b>A61N 1/36</b> (2006.01)	3682798	TITRATION OF HEART RATE TO IMPROVE STIMULATION THERAPY FOR HEART FAILURE PATIENTS
<b>G16H 40/63</b> (2018.01)	3682798	TITRATION OF HEART RATE TO IMPROVE STIMULATION THERAPY FOR HEART FAILURE PATIENTS
<b>A01J 25/12</b> (2006.01)	3679802	FOOD PRODUCT BASED ON MOZZARELLA STUFFED WITH SMALL MOZZARELLA AND CREAM
<b>A23C 19/068</b> (2006.01)	3679802	FOOD PRODUCT BASED ON MOZZARELLA STUFFED WITH SMALL MOZZARELLA AND CREAM
<b>A61K 31/4985</b> (2006.01)	3689878	4-IMIDAZOPYRIDAZIN-1-YL-BENZAMIDES AND 4-IMIDAZOTRIAZIN-1-YL-BENZAMIDES AS BTK-INHIBITORS
<b>A61P 19/08</b> (2006.01)	3689878	4-IMIDAZOPYRIDAZIN-1-YL-BENZAMIDES AND 4-IMIDAZOTRIAZIN-1-YL-BENZAMIDES AS BTK-INHIBITORS
<b>A61P 29/00</b> (2006.01)	3689878	4-IMIDAZOPYRIDAZIN-1-YL-BENZAMIDES AND 4-IMIDAZOTRIAZIN-1-YL-BENZAMIDES AS BTK-INHIBITORS
<b>A61P 31/00</b> (2006.01)	3689878	4-IMIDAZOPYRIDAZIN-1-YL-BENZAMIDES AND 4-IMIDAZOTRIAZIN-1-YL-BENZAMIDES AS BTK-INHIBITORS
<b>A61P 35/00</b> (2006.01)	3689878	4-IMIDAZOPYRIDAZIN-1-YL-BENZAMIDES AND 4-IMIDAZOTRIAZIN-1-YL-BENZAMIDES AS BTK-INHIBITORS
<b>A61P 37/00</b> (2006.01)	3689878	4-IMIDAZOPYRIDAZIN-1-YL-BENZAMIDES AND 4-IMIDAZOTRIAZIN-1-YL-BENZAMIDES AS BTK-INHIBITORS
<b>C07D 487/04</b> (2006.01)	3689878	4-IMIDAZOPYRIDAZIN-1-YL-BENZAMIDES AND 4-IMIDAZOTRIAZIN-1-YL-BENZAMIDES AS BTK-INHIBITORS
<b>C07D 519/00</b> (2006.01)	3689878	4-IMIDAZOPYRIDAZIN-1-YL-BENZAMIDES AND 4-IMIDAZOTRIAZIN-1-YL-BENZAMIDES AS BTK-INHIBITORS
<b>A61K 31/4965</b> (2006.01)	3693361	3,5-DIAMINO-6-CHLORO-N-(N-(4-(4-(2-(HEXYL(2,3,4,5,6-PENTAHYDROXYHEXYL)AMINO)ETHOXY)PHENYL)BUTYL)CARBAMIMIDOYL)PYRAZINE-2-CARBOXAMIDE
<b>A61P 11/00</b> (2006.01)	3693361	3,5-DIAMINO-6-CHLORO-N-(N-(4-(4-(2-(HEXYL(2,3,4,5,6-PENTAHYDROXYHEXYL)AMINO)ETHOXY)PHENYL)BUTYL)CARBAMIMIDOYL)PYRAZINE-2-CARBOXAMIDE
<b>C07D 239/48</b> (2006.01)	3693361	3,5-DIAMINO-6-CHLORO-N-(N-(4-(4-(2-(HEXYL(2,3,4,5,6-PENTAHYDROXYHEXYL)AMINO)ETHOXY)PHENYL)BUTYL)CARBAMIMIDOYL)PYRAZINE-2-CARBOXAMIDE
<b>A61K 31/7088</b> (2006.01)	3690049	COMPOSITIONS AND METHODS FOR MODULATING APOLIPOPROTEIN C-III EXPRESSION
<b>A61K 31/713</b> (2006.01)	3690049	COMPOSITIONS AND METHODS FOR MODULATING APOLIPOPROTEIN C-III EXPRESSION
<b>A61K 47/54</b> (2017.01)	3690049	COMPOSITIONS AND METHODS FOR MODULATING APOLIPOPROTEIN C-III EXPRESSION
<b>A61K 47/59</b> (2017.01)	3690049	COMPOSITIONS AND METHODS FOR MODULATING APOLIPOPROTEIN C-III EXPRESSION
<b>A61P 3/06</b> (2006.01)	3690049	COMPOSITIONS AND METHODS FOR MODULATING APOLIPOPROTEIN C-III EXPRESSION
<b>A61P 25/00</b> (2006.01)	3690049	COMPOSITIONS AND METHODS FOR MODULATING APOLIPOPROTEIN C-III EXPRESSION
<b>A61P 43/00</b> (2006.01)	3690049	COMPOSITIONS AND METHODS FOR MODULATING APOLIPOPROTEIN C-III EXPRESSION
<b>C12N 15/113</b> (2010.01)	3690049	COMPOSITIONS AND METHODS FOR MODULATING APOLIPOPROTEIN C-III EXPRESSION
<b>A61K 31/407</b> (2006.01)	3696183	NOVEL CHROMONE OXIME DERIVATIVE AND ITS USE AS ALLOSTERIC MODULATOR OF METABOTROPIC GLUTAMATE RECEPTORS
<b>A61P 25/16</b> (2006.01)	3696183	NOVEL CHROMONE OXIME DERIVATIVE AND ITS USE AS ALLOSTERIC MODULATOR OF METABOTROPIC GLUTAMATE RECEPTORS

MKP (51)	Broj objave evropske prijava patenta (97)	Naziv pronalaska (54)
<b>C07D 495/04</b> (2006.01)	3696183	NOVEL CHROMONE OXIME DERIVATIVE AND ITS USE AS ALLOSTERIC MODULATOR OF METABOTROPIC GLUTAMATE RECEPTORS
<b>A61K 9/00</b> (2006.01)	3689344	HIGHLY WATER-SOLUBLE SALTS OF A SHORT ACTING PHENYLALKYLAMINE CALCIUM CHANNEL BLOCKER AND USES THEREOF
<b>A61K 9/08</b> (2006.01)	3689344	HIGHLY WATER-SOLUBLE SALTS OF A SHORT ACTING PHENYLALKYLAMINE CALCIUM CHANNEL BLOCKER AND USES THEREOF
<b>A61K 31/277</b> (2006.01)	3689344	HIGHLY WATER-SOLUBLE SALTS OF A SHORT ACTING PHENYLALKYLAMINE CALCIUM CHANNEL BLOCKER AND USES THEREOF
<b>A61K 47/12</b> (2006.01)	3689344	HIGHLY WATER-SOLUBLE SALTS OF A SHORT ACTING PHENYLALKYLAMINE CALCIUM CHANNEL BLOCKER AND USES THEREOF
<b>A61K 47/18</b> (2017.01)	3689344	HIGHLY WATER-SOLUBLE SALTS OF A SHORT ACTING PHENYLALKYLAMINE CALCIUM CHANNEL BLOCKER AND USES THEREOF
<b>A61K 47/20</b> (2006.01)	3689344	HIGHLY WATER-SOLUBLE SALTS OF A SHORT ACTING PHENYLALKYLAMINE CALCIUM CHANNEL BLOCKER AND USES THEREOF
<b>A61P 9/00</b> (2006.01)	3689344	HIGHLY WATER-SOLUBLE SALTS OF A SHORT ACTING PHENYLALKYLAMINE CALCIUM CHANNEL BLOCKER AND USES THEREOF
<b>A61P 9/06</b> (2006.01)	3689344	HIGHLY WATER-SOLUBLE SALTS OF A SHORT ACTING PHENYLALKYLAMINE CALCIUM CHANNEL BLOCKER AND USES THEREOF
<b>A61P 9/10</b> (2006.01)	3689344	HIGHLY WATER-SOLUBLE SALTS OF A SHORT ACTING PHENYLALKYLAMINE CALCIUM CHANNEL BLOCKER AND USES THEREOF
<b>A61P 25/06</b> (2006.01)	3689344	HIGHLY WATER-SOLUBLE SALTS OF A SHORT ACTING PHENYLALKYLAMINE CALCIUM CHANNEL BLOCKER AND USES THEREOF
<b>C07C 255/42</b> (2006.01)	3689344	HIGHLY WATER-SOLUBLE SALTS OF A SHORT ACTING PHENYLALKYLAMINE CALCIUM CHANNEL BLOCKER AND USES THEREOF
<b>A61P 37/06</b> (2006.01)	3696262	USE OF PDL1 EXPRESSING CELLS TO CONVERT T CELLS INTO REGULATORY T CELLS
<b>C12N 5/0783</b> (2010.01)	3696262	USE OF PDL1 EXPRESSING CELLS TO CONVERT T CELLS INTO REGULATORY T CELLS
<b>G06F 21/32</b> (2013.01)	3671503	GRAPHOMETRIC DOCUMENT SIGNING METHOD AND SYSTEM
<b>G06F 21/62</b> (2013.01)	3671503	GRAPHOMETRIC DOCUMENT SIGNING METHOD AND SYSTEM
<b>G06F 21/64</b> (2013.01)	3671503	GRAPHOMETRIC DOCUMENT SIGNING METHOD AND SYSTEM
<b>H04L 9/32</b> (2006.01)	3671503	GRAPHOMETRIC DOCUMENT SIGNING METHOD AND SYSTEM
<b>H04L 29/06</b> (2006.01)	3671503	GRAPHOMETRIC DOCUMENT SIGNING METHOD AND SYSTEM
<b>A61K 31/00</b> (2006.01)	3693391	ANTI-CLL-1 ANTIBODIES AND IMMUNOCONJUGATES
<b>A61K 47/68</b> (2017.01)	3693391	ANTI-CLL-1 ANTIBODIES AND IMMUNOCONJUGATES
<b>A61K 51/00</b> (2006.01)	3693391	ANTI-CLL-1 ANTIBODIES AND IMMUNOCONJUGATES
<b>A61P 35/00</b> (2006.01)	3693391	ANTI-CLL-1 ANTIBODIES AND IMMUNOCONJUGATES
<b>A61P 35/02</b> (2006.01)	3693391	ANTI-CLL-1 ANTIBODIES AND IMMUNOCONJUGATES
<b>C07K 16/28</b> (2006.01)	3693391	ANTI-CLL-1 ANTIBODIES AND IMMUNOCONJUGATES
<b>C07K 16/30</b> (2006.01)	3693391	ANTI-CLL-1 ANTIBODIES AND IMMUNOCONJUGATES
<b>A61K 39/395</b> (2006.01)	3693397	COILED COIL IMMUNOGLOBULIN FUSION PROTEINS AND COMPOSITIONS THEREOF
<b>A61K 47/65</b> (2017.01)	3693397	COILED COIL IMMUNOGLOBULIN FUSION PROTEINS AND COMPOSITIONS THEREOF
<b>A61P 35/00</b> (2006.01)	3693397	COILED COIL IMMUNOGLOBULIN FUSION PROTEINS AND COMPOSITIONS THEREOF
<b>C07K 16/10</b> (2006.01)	3693397	COILED COIL IMMUNOGLOBULIN FUSION PROTEINS AND COMPOSITIONS THEREOF
<b>C07K 16/46</b> (2006.01)	3693397	COILED COIL IMMUNOGLOBULIN FUSION PROTEINS AND COMPOSITIONS THEREOF
<b>C12N 15/62</b> (2006.01)	3693397	COILED COIL IMMUNOGLOBULIN FUSION PROTEINS AND COMPOSITIONS THEREOF
<b>A61K 9/00</b> (2006.01)	3630289	PHARMACEUTICAL COMBINATIONS OF ZONISAMIDE AND PRAXIPEXOLE, AND RELATED METHODS, FOR TREATING SYNUCLEINOPATHIES

MKP (51)	Broj objave evropske prijava patenta (97)	Naziv pronalaska (54)
<b>A61K 9/20</b> (2006.01)	3630289	PHARMACEUTICAL COMBINATIONS OF ZONISAMIDE AND PRAXIPEXOLE, AND RELATED METHODS, FOR TREATING SYNUCLEINOPATHIES
<b>A61K 31/423</b> (2006.01)	3630289	PHARMACEUTICAL COMBINATIONS OF ZONISAMIDE AND PRAXIPEXOLE, AND RELATED METHODS, FOR TREATING SYNUCLEINOPATHIES
<b>A61K 31/428</b> (2006.01)	3630289	PHARMACEUTICAL COMBINATIONS OF ZONISAMIDE AND PRAXIPEXOLE, AND RELATED METHODS, FOR TREATING SYNUCLEINOPATHIES
<b>A61P 25/00</b> (2006.01)	3630289	PHARMACEUTICAL COMBINATIONS OF ZONISAMIDE AND PRAXIPEXOLE, AND RELATED METHODS, FOR TREATING SYNUCLEINOPATHIES
<b>A61P 25/16</b> (2006.01)	3630289	PHARMACEUTICAL COMBINATIONS OF ZONISAMIDE AND PRAXIPEXOLE, AND RELATED METHODS, FOR TREATING SYNUCLEINOPATHIES
<b>A61P 25/28</b> (2006.01)	3630289	PHARMACEUTICAL COMBINATIONS OF ZONISAMIDE AND PRAXIPEXOLE, AND RELATED METHODS, FOR TREATING SYNUCLEINOPATHIES
<b>A61P 43/00</b> (2006.01)	3630289	PHARMACEUTICAL COMBINATIONS OF ZONISAMIDE AND PRAXIPEXOLE, AND RELATED METHODS, FOR TREATING SYNUCLEINOPATHIES
<b>F03D 5/04</b> (2006.01)	3633187	WIND ENERGY CONVERSION MODULE
<b>F03D 7/00</b> (2006.01)	3633187	WIND ENERGY CONVERSION MODULE
<b>F03D 7/02</b> (2006.01)	3633187	WIND ENERGY CONVERSION MODULE
<b>A61K 31/13</b> (2006.01)	3630772	METHODS OF MAKING AND USING PDE9 INHIBITORS
<b>A61K 31/27</b> (2006.01)	3630772	METHODS OF MAKING AND USING PDE9 INHIBITORS
<b>A61K 31/444</b> (2006.01)	3630772	METHODS OF MAKING AND USING PDE9 INHIBITORS
<b>C07D 487/04</b> (2006.01)	3630772	METHODS OF MAKING AND USING PDE9 INHIBITORS
<b>C07K 14/195</b> (2006.01)	3630962	CBLB ENDONUCLEASE VARIANTS, COMPOSITIONS, AND METHODS OF USE
<b>C07K 14/405</b> (2006.01)	3630962	CBLB ENDONUCLEASE VARIANTS, COMPOSITIONS, AND METHODS OF USE
<b>C12N 9/04</b> (2006.01)	3630962	CBLB ENDONUCLEASE VARIANTS, COMPOSITIONS, AND METHODS OF USE
<b>C12N 15/00</b> (2006.01)	3630962	CBLB ENDONUCLEASE VARIANTS, COMPOSITIONS, AND METHODS OF USE
<b>C12N 15/53</b> (2006.01)	3630962	CBLB ENDONUCLEASE VARIANTS, COMPOSITIONS, AND METHODS OF USE
<b>C12N 15/62</b> (2006.01)	3630962	CBLB ENDONUCLEASE VARIANTS, COMPOSITIONS, AND METHODS OF USE
<b>C07C 311/07</b> (2006.01)	3630738	PROCESS FOR THE PRODUCTION OF OZANIMOD
<b>C07D 271/06</b> (2006.01)	3630738	PROCESS FOR THE PRODUCTION OF OZANIMOD
<b>C07K 16/28</b> (2006.01)	3674320	PRODUCTION OF HETERODIMERIC PROTEINS
<b>C07K 16/46</b> (2006.01)	3674320	PRODUCTION OF HETERODIMERIC PROTEINS
<b>G06K 9/62</b> (2006.01)	3633549	FACIAL DETECTION TRAINING METHOD, APPARATUS AND ELECTRONIC DEVICE
<b>A47L 15/42</b> (2006.01)	3631074	SELF-ADJUSTING LOCK SYSTEM
<b>D06F 39/00</b> (2020.01)	3631074	SELF-ADJUSTING LOCK SYSTEM
<b>D06F 39/14</b> (2006.01)	3631074	SELF-ADJUSTING LOCK SYSTEM
<b>E05B 15/02</b> (2006.01)	3631074	SELF-ADJUSTING LOCK SYSTEM
<b>E05B 15/04</b> (2006.01)	3631074	SELF-ADJUSTING LOCK SYSTEM
<b>E05B 47/00</b> (2006.01)	3631074	SELF-ADJUSTING LOCK SYSTEM
<b>E05C 3/24</b> (2006.01)	3631074	SELF-ADJUSTING LOCK SYSTEM
<b>E05C 5/02</b> (2006.01)	3631074	SELF-ADJUSTING LOCK SYSTEM
<b>A47L 15/42</b> (2006.01)	3629879	POLLUTION MEASURING SENSOR HOUSING
<b>D06F 34/22</b> (2020.01)	3629879	POLLUTION MEASURING SENSOR HOUSING
<b>A47L 15/42</b> (2006.01)	3631253	STATIONARY SEALING GASKET
<b>A45D 19/02</b> (2006.01)	3799553	DEVICE IN THE FORM OF A PIECE OF FELT CONTAINING A COMPOSITION FOR INSTANTLY COLOURING WHITE BEARD HAIRS AND WHITE HAIRS
<b>A61K 8/92</b> (2006.01)	3799553	DEVICE IN THE FORM OF A PIECE OF FELT CONTAINING A COMPOSITION FOR INSTANTLY COLOURING WHITE BEARD HAIRS AND WHITE HAIRS
<b>A61Q 5/06</b> (2006.01)	3799553	DEVICE IN THE FORM OF A PIECE OF FELT CONTAINING A COMPOSITION FOR INSTANTLY COLOURING WHITE BEARD HAIRS AND WHITE HAIRS
<b>E01B 29/32</b> (2006.01)	3783151	DEVICE FOR FIXING AND POSITIONING A RAIL MONITORING ELEMENT AND USE OF SAID DEVICE

MKP	Broj objave evropske prijave patenta (97)	Naziv pronalaska (54)
(51)		
<b>B61L 3/00</b> (2006.01)	3782869	TRAIN CONTROL SYSTEM AND METHOD FOR CONTROLLING A TRAIN WITHIN A TRAIN CONTROL SYSTEM
<b>B61L 27/00</b> (2006.01)	3782869	TRAIN CONTROL SYSTEM AND METHOD FOR CONTROLLING A TRAIN WITHIN A TRAIN CONTROL SYSTEM
<b>C01B 17/765</b> (2006.01)	3792220	METHOD AND DEVICE FOR OBTAINING SULPHURIC ACID FROM CONTAMINATED SULPHUR-CONTAINING MEDIA
<b>C01B 17/775</b> (2006.01)	3792220	METHOD AND DEVICE FOR OBTAINING SULPHURIC ACID FROM CONTAMINATED SULPHUR-CONTAINING MEDIA
<b>C01B 17/80</b> (2006.01)	3792220	METHOD AND DEVICE FOR OBTAINING SULPHURIC ACID FROM CONTAMINATED SULPHUR-CONTAINING MEDIA
<b>C01B 17/90</b> (2006.01)	3792220	METHOD AND DEVICE FOR OBTAINING SULPHURIC ACID FROM CONTAMINATED SULPHUR-CONTAINING MEDIA
<b>E21D 9/00</b> (2006.01)	3795797	HIGH EFFICIENCY AND LOW ENVIRONMENTAL IMPACT TUNNELING SYSTEM
<b>A61K 31/506</b> (2006.01)	3659621	COMBINATION THERAPIES FOR CANCER
<b>A61K 39/395</b> (2006.01)	3659621	COMBINATION THERAPIES FOR CANCER
<b>A61P 35/00</b> (2006.01)	3659621	COMBINATION THERAPIES FOR CANCER
<b>C07K 16/28</b> (2006.01)	3659621	COMBINATION THERAPIES FOR CANCER
<b>A61P 35/00</b> (2006.01)	3660050	ANTIBODY MOLECULES TO LAG-3 AND USES THEREOF
<b>C07K 16/28</b> (2006.01)	3660050	ANTIBODY MOLECULES TO LAG-3 AND USES THEREOF
<b>A61B 17/00</b> (2006.01)	3785642	SPONGE-BASED VARIABLE-STIFFNESS NATURAL ORIFICE SURGERY INSTRUMENT SUPPORT STRUCTURE AND USE METHOD THEREFOR
<b>H04L 29/06</b> (2006.01)	3793157	METHOD AND DEVICE FOR BLOCKCHAIN NODE
<b>H04L 29/06</b> (2006.01)	3793158	METHOD AND DEVICE FOR REACHING CONSENSUS IN BLOCKCHAIN
<b>B25J 9/16</b> (2006.01)	3793781	SYSTEM AND METHOD FOR CONTROLLING A ROBOTIC WRIST
<b>H02G 3/06</b> (2006.01)	3681001	CABLE TRAY CONNECTING DEVICE
<b>A01M 15/00</b> (2006.01)	3770498	PORTABLE GAS TOOL
<b>F23D 14/38</b> (2006.01)	3770498	PORTABLE GAS TOOL
<b>F23D 14/46</b> (2006.01)	3770498	PORTABLE GAS TOOL
<b>F23Q 3/00</b> (2006.01)	3770498	PORTABLE GAS TOOL
<b>G01K 1/14</b> (2021.01)	3795965	SUPPORT SYSTEM FOR SUPPORTING AN ENVIRONMENTAL TEMPERATURE SENSOR IN RAILWAY SECTOR
<b>G01K 1/16</b> (2006.01)	3795965	SUPPORT SYSTEM FOR SUPPORTING AN ENVIRONMENTAL TEMPERATURE SENSOR IN RAILWAY SECTOR
<b>G16H 20/40</b> (2018.01)	3699921	OPTIMIZING CATHETERIZATION LABORATORY THROUGHPUT USING MACHINE LEARNING
<b>G16H 40/20</b> (2018.01)	3699921	OPTIMIZING CATHETERIZATION LABORATORY THROUGHPUT USING MACHINE LEARNING
<b>A61L 2/08</b> (2006.01)	3781216	EQUIPMENT WITH RADIATION SOURCE FOR FACILITATING KILLING HARMFUL MICROORGANISMS, ESPECIALLY FOR FACILITATION OF CONSERVATION OF FOOD
<b>H01J 61/00</b> (2006.01)	3781216	EQUIPMENT WITH RADIATION SOURCE FOR FACILITATING KILLING HARMFUL MICROORGANISMS, ESPECIALLY FOR FACILITATION OF CONSERVATION OF FOOD
<b>A61K 31/517</b> (2006.01)	3762379	IDENTIFICATION AND USE OF ERK5 INHIBITORS
<b>A61K 31/519</b> (2006.01)	3762379	IDENTIFICATION AND USE OF ERK5 INHIBITORS
<b>A61P 35/00</b> (2006.01)	3762379	IDENTIFICATION AND USE OF ERK5 INHIBITORS
<b>C07D 403/04</b> (2006.01)	3762379	IDENTIFICATION AND USE OF ERK5 INHIBITORS
<b>C07D 403/14</b> (2006.01)	3762379	IDENTIFICATION AND USE OF ERK5 INHIBITORS
<b>C07D 407/14</b> (2006.01)	3762379	IDENTIFICATION AND USE OF ERK5 INHIBITORS
<b>C07D 487/04</b> (2006.01)	3762379	IDENTIFICATION AND USE OF ERK5 INHIBITORS
<b>A61M 5/315</b> (2006.01)	3762074	CONTROLLED DISPENSE SYRINGE
<b>A61K 47/68</b> (2017.01)	3765493	ANTIBODIES
<b>C07K 16/10</b> (2006.01)	3765493	ANTIBODIES
<b>C07K 16/28</b> (2006.01)	3765493	ANTIBODIES
<b>C07K 16/30</b> (2006.01)	3765493	ANTIBODIES
<b>A61K 39/395</b> (2006.01)	3765508	TREATMENT OF HEAD AND NECK CANCER
<b>A61P 35/00</b> (2006.01)	3765508	TREATMENT OF HEAD AND NECK CANCER
<b>C07K 16/28</b> (2006.01)	3765508	TREATMENT OF HEAD AND NECK CANCER
<b>C07K 16/12</b> (2006.01)	3765495	SINGLE DOMAIN ANTIBODIES BINDING TO TETANUS NEUROTOXIN
<b>C25C 3/08</b> (2006.01)	3765657	CATHODE ASSEMBLY FOR ELECTROLYTIC CELL
<b>C25C 3/16</b> (2006.01)	3765657	CATHODE ASSEMBLY FOR ELECTROLYTIC CELL
<b>C25C 7/00</b> (2006.01)	3765657	CATHODE ASSEMBLY FOR ELECTROLYTIC CELL
<b>C25C 7/02</b> (2006.01)	3765657	CATHODE ASSEMBLY FOR ELECTROLYTIC CELL

MKP (51)	Broj objave evropske prijava patenta (97)	Naziv pronalaska (54)
<b>A61K 31/7088</b> (2006.01)	3765477	5'-CAP-TRINUCLEOTIDE- OR HIGHER OLIGONUCLEOTIDE COMPOUNDS AND THEIR USES IN STABILIZING RNA, EXPRESSING PROTEINS AND IN THERAPY
<b>A61K 48/00</b> (2006.01)	3765477	5'-CAP-TRINUCLEOTIDE- OR HIGHER OLIGONUCLEOTIDE COMPOUNDS AND THEIR USES IN STABILIZING RNA, EXPRESSING PROTEINS AND IN THERAPY
<b>C07H 21/02</b> (2006.01)	3765477	5'-CAP-TRINUCLEOTIDE- OR HIGHER OLIGONUCLEOTIDE COMPOUNDS AND THEIR USES IN STABILIZING RNA, EXPRESSING PROTEINS AND IN THERAPY
<b>C12N 5/07</b> (2010.01)	3765477	5'-CAP-TRINUCLEOTIDE- OR HIGHER OLIGONUCLEOTIDE COMPOUNDS AND THEIR USES IN STABILIZING RNA, EXPRESSING PROTEINS AND IN THERAPY
<b>C12N 15/11</b> (2006.01)	3765477	5'-CAP-TRINUCLEOTIDE- OR HIGHER OLIGONUCLEOTIDE COMPOUNDS AND THEIR USES IN STABILIZING RNA, EXPRESSING PROTEINS AND IN THERAPY
<b>A61K 31/16</b> (2006.01)	3765439	NOVEL CALCIUM SALT POLYMORPHS AS ANTI-INFLAMMATORY, IMMUNOMODULATORY AND ANTI-PROLIFERATORY AGENTS
<b>A61P 37/00</b> (2006.01)	3765439	NOVEL CALCIUM SALT POLYMORPHS AS ANTI-INFLAMMATORY, IMMUNOMODULATORY AND ANTI-PROLIFERATORY AGENTS
<b>C07C 233/60</b> (2006.01)	3765439	NOVEL CALCIUM SALT POLYMORPHS AS ANTI-INFLAMMATORY, IMMUNOMODULATORY AND ANTI-PROLIFERATORY AGENTS
<b>H05K 7/14</b> (2006.01)	3791701	RACK AND SERVER CABINET OR NETWORK CABINET HAVING A RACK
<b>H05K 7/18</b> (2006.01)	3791701	RACK AND SERVER CABINET OR NETWORK CABINET HAVING A RACK
<b>A61K 31/4025</b> (2006.01)	3762380	PHENYLPYRROLIDINONE FORMYL PEPTIDE 2 RECEPTOR AGONISTS
<b>A61K 31/4439</b> (2006.01)	3762380	PHENYLPYRROLIDINONE FORMYL PEPTIDE 2 RECEPTOR AGONISTS
<b>A61K 31/506</b> (2006.01)	3762380	PHENYLPYRROLIDINONE FORMYL PEPTIDE 2 RECEPTOR AGONISTS
<b>A61P 9/00</b> (2006.01)	3762380	PHENYLPYRROLIDINONE FORMYL PEPTIDE 2 RECEPTOR AGONISTS
<b>C07D 207/14</b> (2006.01)	3762380	PHENYLPYRROLIDINONE FORMYL PEPTIDE 2 RECEPTOR AGONISTS
<b>C07D 401/10</b> (2006.01)	3762380	PHENYLPYRROLIDINONE FORMYL PEPTIDE 2 RECEPTOR AGONISTS
<b>C07D 401/12</b> (2006.01)	3762380	PHENYLPYRROLIDINONE FORMYL PEPTIDE 2 RECEPTOR AGONISTS
<b>C07D 403/10</b> (2006.01)	3762380	PHENYLPYRROLIDINONE FORMYL PEPTIDE 2 RECEPTOR AGONISTS
<b>C07D 403/12</b> (2006.01)	3762380	PHENYLPYRROLIDINONE FORMYL PEPTIDE 2 RECEPTOR AGONISTS
<b>C07D 405/10</b> (2006.01)	3762380	PHENYLPYRROLIDINONE FORMYL PEPTIDE 2 RECEPTOR AGONISTS
<b>C07D 409/12</b> (2006.01)	3762380	PHENYLPYRROLIDINONE FORMYL PEPTIDE 2 RECEPTOR AGONISTS
<b>C07D 413/10</b> (2006.01)	3762380	PHENYLPYRROLIDINONE FORMYL PEPTIDE 2 RECEPTOR AGONISTS
<b>C07D 413/14</b> (2006.01)	3762380	PHENYLPYRROLIDINONE FORMYL PEPTIDE 2 RECEPTOR AGONISTS
<b>C07D 417/10</b> (2006.01)	3762380	PHENYLPYRROLIDINONE FORMYL PEPTIDE 2 RECEPTOR AGONISTS
<b>C07F 9/02</b> (2006.01)	3762380	PHENYLPYRROLIDINONE FORMYL PEPTIDE 2 RECEPTOR AGONISTS
<b>A61K 31/5383</b> (2006.01)	3765024	NOVEL PHARMACEUTICAL FORMULATION COMPRISING DUAL NK-1/NK-3 RECEPTOR ANTAGONISTS
<b>A61P 25/00</b> (2006.01)	3765024	NOVEL PHARMACEUTICAL FORMULATION COMPRISING DUAL NK-1/NK-3 RECEPTOR ANTAGONISTS
<b>C07D 498/04</b> (2006.01)	3765024	NOVEL PHARMACEUTICAL FORMULATION COMPRISING DUAL NK-1/NK-3 RECEPTOR ANTAGONISTS
<b>C03C 3/087</b> (2006.01)	3762341	GLASS COMPOSITIONS, FIBERIZABLE GLASS COMPOSITIONS, AND GLASS FIBERS MADE THEREFROM
<b>C03C 3/095</b> (2006.01)	3762341	GLASS COMPOSITIONS, FIBERIZABLE GLASS COMPOSITIONS, AND GLASS FIBERS MADE THEREFROM
<b>C03C 3/112</b> (2006.01)	3762341	GLASS COMPOSITIONS, FIBERIZABLE GLASS COMPOSITIONS, AND GLASS FIBERS MADE THEREFROM

MKP (51)	Broj objave evropske prijava patenta (97)	Naziv pronalaska (54)
<b>C03C 13/00</b> (2006.01)	3762341	GLASS COMPOSITIONS, FIBERIZABLE GLASS COMPOSITIONS, AND GLASS FIBERS MADE THEREFROM
<b>C08J 5/08</b> (2006.01)	3762341	GLASS COMPOSITIONS, FIBERIZABLE GLASS COMPOSITIONS, AND GLASS FIBERS MADE THEREFROM
<b>B26D 1/00</b> (2006.01)	3762195	INCISION STATION FOR PACKAGING MACHINE AND RELATIVE INCISION METHOD
<b>B26D 1/06</b> (2006.01)	3762195	INCISION STATION FOR PACKAGING MACHINE AND RELATIVE INCISION METHOD
<b>B26D 1/09</b> (2006.01)	3762195	INCISION STATION FOR PACKAGING MACHINE AND RELATIVE INCISION METHOD
<b>B26D 3/08</b> (2006.01)	3762195	INCISION STATION FOR PACKAGING MACHINE AND RELATIVE INCISION METHOD
<b>B26D 5/00</b> (2006.01)	3762195	INCISION STATION FOR PACKAGING MACHINE AND RELATIVE INCISION METHOD
<b>B26D 5/06</b> (2006.01)	3762195	INCISION STATION FOR PACKAGING MACHINE AND RELATIVE INCISION METHOD
<b>B26D 5/08</b> (2006.01)	3762195	INCISION STATION FOR PACKAGING MACHINE AND RELATIVE INCISION METHOD
<b>B26D 7/01</b> (2006.01)	3762195	INCISION STATION FOR PACKAGING MACHINE AND RELATIVE INCISION METHOD
<b>B65D 75/58</b> (2006.01)	3762195	INCISION STATION FOR PACKAGING MACHINE AND RELATIVE INCISION METHOD
<b>A61K 31/4985</b> (2006.01)	3762389	CRYSTALLINE FORMS OF AN SGC STIMULATOR
<b>A61P 25/00</b> (2006.01)	3762389	CRYSTALLINE FORMS OF AN SGC STIMULATOR
<b>C07D 487/04</b> (2006.01)	3762389	CRYSTALLINE FORMS OF AN SGC STIMULATOR
<b>A61M 5/14</b> (2006.01)	3762067	BACKFLOW PREVENTION MECHANISM FOR DRUG DELIVERY DEVICE
<b>A61M 5/142</b> (2006.01)	3762067	BACKFLOW PREVENTION MECHANISM FOR DRUG DELIVERY DEVICE
<b>A61K 31/7088</b> (2006.01)	3765476	MODIFIED OLIGONUCLEOTIDES FOR USE IN TREATMENT OF TAUOPATHIES
<b>A61P 25/28</b> (2006.01)	3765476	MODIFIED OLIGONUCLEOTIDES FOR USE IN TREATMENT OF TAUOPATHIES
<b>C07H 21/00</b> (2006.01)	3765476	MODIFIED OLIGONUCLEOTIDES FOR USE IN TREATMENT OF TAUOPATHIES
<b>C12N 15/113</b> (2010.01)	3765476	MODIFIED OLIGONUCLEOTIDES FOR USE IN TREATMENT OF TAUOPATHIES
<b>A61K 31/4035</b> (2006.01)	3762365	METHODS AND COMPOSITIONS OF ISOINDOLINE-1,3-DIONE AND ISOINDOLE PRODRUGS USEFUL FOR TREATING CANCER, ULCERATIVE COLITIS AND RELATED INFLAMMATORY DISEASES
<b>A61P 1/12</b> (2006.01)	3762365	METHODS AND COMPOSITIONS OF ISOINDOLINE-1,3-DIONE AND ISOINDOLE PRODRUGS USEFUL FOR TREATING CANCER, ULCERATIVE COLITIS AND RELATED INFLAMMATORY DISEASES
<b>C07D 209/48</b> (2006.01)	3762365	METHODS AND COMPOSITIONS OF ISOINDOLINE-1,3-DIONE AND ISOINDOLE PRODRUGS USEFUL FOR TREATING CANCER, ULCERATIVE COLITIS AND RELATED INFLAMMATORY DISEASES
<b>C12N 9/22</b> (2006.01)	3768834	NOVEL RNA-PROGRAMMABLE ENDONUCLEASE SYSTEMS AND USES THEREOF
<b>C12N 15/10</b> (2006.01)	3768834	NOVEL RNA-PROGRAMMABLE ENDONUCLEASE SYSTEMS AND USES THEREOF
<b>C08L 1/02</b> (2006.01)	3765563	BIODEGRADABLE COATINGS FOR BIODEGRADABLE SUBSTRATES
<b>C08L 7/02</b> (2006.01)	3765563	BIODEGRADABLE COATINGS FOR BIODEGRADABLE SUBSTRATES
<b>C08L 21/00</b> (2006.01)	3765563	BIODEGRADABLE COATINGS FOR BIODEGRADABLE SUBSTRATES
<b>C07K 14/005</b> (2006.01)	3768695	NOVEL ADENO-ASSOCIATED VIRUS (AAV) VECTORS, AAV VECTORS HAVING REDUCED CAPSID DEAMIDATION AND USES THEREFOR
<b>C12N 15/864</b> (2006.01)	3768695	NOVEL ADENO-ASSOCIATED VIRUS (AAV) VECTORS, AAV VECTORS HAVING REDUCED CAPSID DEAMIDATION AND USES THEREFOR
<b>A61K 38/00</b> (2006.01)	3762036	MULTIVALENT PEPTIDE CONJUGATES FOR SUSTAINED INTRA-ARTICULAR TREATMENT OF JOINT INFLAMMATION
<b>A61K 47/00</b> (2006.01)	3762036	MULTIVALENT PEPTIDE CONJUGATES FOR SUSTAINED INTRA-ARTICULAR TREATMENT OF JOINT INFLAMMATION
<b>H01B 5/10</b> (2006.01)	3762949	OVERHEAD ELECTRICAL CABLES AND METHOD FOR FABRICATING SAME

MKP (51)	Broj objave evropske prijave patenta (97)	Naziv pronalaska (54)
<b>H01B 7/18</b> (2006.01)	3762949	OVERHEAD ELECTRICAL CABLES AND METHOD FOR FABRICATING SAME
<b>H01B 9/00</b> (2006.01)	3762949	OVERHEAD ELECTRICAL CABLES AND METHOD FOR FABRICATING SAME
<b>H01B 13/02</b> (2006.01)	3762949	OVERHEAD ELECTRICAL CABLES AND METHOD FOR FABRICATING SAME
<b>A61K 39/395</b> (2006.01)	3762400	ANTI-CD252 ANTIBODIES, CONJUGATES, AND METHODS OF USE
<b>C07K 7/64</b> (2006.01)	3762400	ANTI-CD252 ANTIBODIES, CONJUGATES, AND METHODS OF USE
<b>C07K 16/28</b> (2006.01)	3762400	ANTI-CD252 ANTIBODIES, CONJUGATES, AND METHODS OF USE
<b>A61K 35/28</b> (2015.01)	3762505	COMPOSITIONS AND METHODS FOR TREATING PARKINSON'S DISEASE
<b>A61K 48/00</b> (2006.01)	3762505	COMPOSITIONS AND METHODS FOR TREATING PARKINSON'S DISEASE
<b>C12Q 1/34</b> (2006.01)	3762505	COMPOSITIONS AND METHODS FOR TREATING PARKINSON'S DISEASE
<b>C07K 16/18</b> (2006.01)	3762414	ASSAYS TO DETECT NEURODEGENERATION
<b>G01N 33/53</b> (2006.01)	3762414	ASSAYS TO DETECT NEURODEGENERATION
<b>G01N 33/58</b> (2006.01)	3762414	ASSAYS TO DETECT NEURODEGENERATION
<b>A61K 39/395</b> (2006.01)	3762032	ANTI-TISSUE FACTOR ANTIBODY-DRUG CONJUGATES AND THEIR USE IN THE TREATMENT OF CANCER
<b>A61P 35/00</b> (2006.01)	3762032	ANTI-TISSUE FACTOR ANTIBODY-DRUG CONJUGATES AND THEIR USE IN THE TREATMENT OF CANCER
<b>C07K 16/28</b> (2006.01)	3762032	ANTI-TISSUE FACTOR ANTIBODY-DRUG CONJUGATES AND THEIR USE IN THE TREATMENT OF CANCER
<b>A61K 38/17</b> (2006.01)	3762015	METHODS OF TREATING CROHN'S DISEASE WITH ANTI-IL23 SPECIFIC ANTIBODY
<b>A61K 39/395</b> (2006.01)	3762015	METHODS OF TREATING CROHN'S DISEASE WITH ANTI-IL23 SPECIFIC ANTIBODY
<b>A61P 37/02</b> (2006.01)	3762015	METHODS OF TREATING CROHN'S DISEASE WITH ANTI-IL23 SPECIFIC ANTIBODY
<b>C07K 14/54</b> (2006.01)	3762015	METHODS OF TREATING CROHN'S DISEASE WITH ANTI-IL23 SPECIFIC ANTIBODY
<b>C07K 16/24</b> (2006.01)	3762015	METHODS OF TREATING CROHN'S DISEASE WITH ANTI-IL23 SPECIFIC ANTIBODY
<b>F41A 9/62</b> (2006.01)	3762674	FIREARM AMMUNITION AVAILABILITY DETECTION SYSTEM
<b>G01D 5/12</b> (2006.01)	3762674	FIREARM AMMUNITION AVAILABILITY DETECTION SYSTEM
<b>A61K 31/4375</b> (2006.01)	3761980	AMINO ACID COMPOUNDS AND METHODS OF USE
<b>C07D 401/12</b> (2006.01)	3761980	AMINO ACID COMPOUNDS AND METHODS OF USE
<b>A61K 39/395</b> (2006.01)	3794031	ANTIBODIES AGAINST LIF AND DOSAGE FORMS THEREOF
<b>A61P 35/00</b> (2006.01)	3794031	ANTIBODIES AGAINST LIF AND DOSAGE FORMS THEREOF
<b>C07K 16/24</b> (2006.01)	3794031	ANTIBODIES AGAINST LIF AND DOSAGE FORMS THEREOF
<b>A61K 39/395</b> (2006.01)	3765524	ANTIBODIES THAT BIND CD39 AND USES THEREOF
<b>A61P 35/02</b> (2006.01)	3765524	ANTIBODIES THAT BIND CD39 AND USES THEREOF
<b>C07K 16/28</b> (2006.01)	3765524	ANTIBODIES THAT BIND CD39 AND USES THEREOF
<b>C07K 16/30</b> (2006.01)	3765524	ANTIBODIES THAT BIND CD39 AND USES THEREOF
<b>A61K 31/513</b> (2006.01)	3765023	SYNTHETIC DNA VECTORS AND METHODS OF USE
<b>A61K 48/00</b> (2006.01)	3765023	SYNTHETIC DNA VECTORS AND METHODS OF USE
<b>C12N 15/85</b> (2006.01)	3765023	SYNTHETIC DNA VECTORS AND METHODS OF USE
<b>C12Q 1/68</b> (2018.01)	3765630	PRECISION MEDICINE FOR PAIN: DIAGNOSTIC BIOMARKERS, PHARMACOGENOMICS, AND REPURPOSED DRUGS
<b>G01N 33/50</b> (2006.01)	3765630	PRECISION MEDICINE FOR PAIN: DIAGNOSTIC BIOMARKERS, PHARMACOGENOMICS, AND REPURPOSED DRUGS
<b>G01N 33/68</b> (2006.01)	3765630	PRECISION MEDICINE FOR PAIN: DIAGNOSTIC BIOMARKERS, PHARMACOGENOMICS, AND REPURPOSED DRUGS
<b>A01N 43/76</b> (2006.01)	3766881	HETEROARYL PYRIMIDINE COMPOUND AND PEST CONTROL AGENT
<b>A01N 43/90</b> (2006.01)	3766881	HETEROARYL PYRIMIDINE COMPOUND AND PEST CONTROL AGENT
<b>A01N 47/02</b> (2006.01)	3766881	HETEROARYL PYRIMIDINE COMPOUND AND PEST CONTROL AGENT
<b>A01P 7/04</b> (2006.01)	3766881	HETEROARYL PYRIMIDINE COMPOUND AND PEST CONTROL AGENT
<b>A61K 31/506</b> (2006.01)	3766881	HETEROARYL PYRIMIDINE COMPOUND AND PEST CONTROL AGENT
<b>A61P 33/00</b> (2006.01)	3766881	HETEROARYL PYRIMIDINE COMPOUND AND PEST CONTROL AGENT
<b>A61P 33/14</b> (2006.01)	3766881	HETEROARYL PYRIMIDINE COMPOUND AND PEST CONTROL AGENT

MKP	Broj objave evropske prijave patenta (97)	Naziv pronalaska (54)
(51)		(54)
<b>C07D 413/04</b> (2006.01)	3766881	HETEROARYL PYRIMIDINE COMPOUND AND PEST CONTROL AGENT
<b>C07D 413/14</b> (2006.01)	3766881	HETEROARYL PYRIMIDINE COMPOUND AND PEST CONTROL AGENT
<b>C07D 471/04</b> (2006.01)	3766881	HETEROARYL PYRIMIDINE COMPOUND AND PEST CONTROL AGENT
<b>C07F 7/10</b> (2006.01)	3766881	HETEROARYL PYRIMIDINE COMPOUND AND PEST CONTROL AGENT
<b>A61K 31/7088</b> (2006.01)	3765030	CHIMERIC PEPTIDES FOR ANTISENSE DELIVERY
<b>A61K 47/64</b> (2017.01)	3765030	CHIMERIC PEPTIDES FOR ANTISENSE DELIVERY
<b>A61K 31/495</b> (2006.01)	3765020	SPIROCYCLIC ROR-GAMMA MODULATORS
<b>A61P 17/00</b> (2006.01)	3765020	SPIROCYCLIC ROR-GAMMA MODULATORS
<b>C07D 295/04</b> (2006.01)	3765020	SPIROCYCLIC ROR-GAMMA MODULATORS
<b>A61K 51/04</b> (2006.01)	3766893	177LU-DOTA-HYNIC-IPSMA AS A THERAPEUTIC RADIOPHARMACEUTICAL TARGETING PROSTATE-SPECIFIC MEMBRANE ANTIGEN
<b>A61P 35/00</b> (2006.01)	3766893	177LU-DOTA-HYNIC-IPSMA AS A THERAPEUTIC RADIOPHARMACEUTICAL TARGETING PROSTATE-SPECIFIC MEMBRANE ANTIGEN
<b>C07F 13/00</b> (2006.01)	3766893	177LU-DOTA-HYNIC-IPSMA AS A THERAPEUTIC RADIOPHARMACEUTICAL TARGETING PROSTATE-SPECIFIC MEMBRANE ANTIGEN
<b>A61K 31/497</b> (2006.01)	3762368	AMINOPYRAZINE DIOL COMPOUNDS AS PI3K-Y INHIBITORS
<b>A61P 35/00</b> (2006.01)	3762368	AMINOPYRAZINE DIOL COMPOUNDS AS PI3K-Y INHIBITORS
<b>C07D 241/20</b> (2006.01)	3762368	AMINOPYRAZINE DIOL COMPOUNDS AS PI3K-Y INHIBITORS
<b>C07D 241/28</b> (2006.01)	3762368	AMINOPYRAZINE DIOL COMPOUNDS AS PI3K-Y INHIBITORS
<b>C07D 403/04</b> (2006.01)	3762368	AMINOPYRAZINE DIOL COMPOUNDS AS PI3K-Y INHIBITORS
<b>C07D 403/08</b> (2006.01)	3762368	AMINOPYRAZINE DIOL COMPOUNDS AS PI3K-Y INHIBITORS
<b>C07D 403/14</b> (2006.01)	3762368	AMINOPYRAZINE DIOL COMPOUNDS AS PI3K-Y INHIBITORS
<b>C07D 405/12</b> (2006.01)	3762368	AMINOPYRAZINE DIOL COMPOUNDS AS PI3K-Y INHIBITORS
<b>C07D 413/04</b> (2006.01)	3762368	AMINOPYRAZINE DIOL COMPOUNDS AS PI3K-Y INHIBITORS
<b>C07D 413/14</b> (2006.01)	3762368	AMINOPYRAZINE DIOL COMPOUNDS AS PI3K-Y INHIBITORS
<b>C07D 417/04</b> (2006.01)	3762368	AMINOPYRAZINE DIOL COMPOUNDS AS PI3K-Y INHIBITORS
<b>A01K 47/00</b> (2006.01)	3787398	BEE-MOVEMENT REGULATION DEVICE FOR BEEHIVES
<b>A01K 47/06</b> (2006.01)	3787398	BEE-MOVEMENT REGULATION DEVICE FOR BEEHIVES
<b>C12N 5/079</b> (2010.01)	3768841	METHODS OF TREATING TTR AMYLOIDOSIS USING AG10
<b>C12N 15/113</b> (2010.01)	3768841	METHODS OF TREATING TTR AMYLOIDOSIS USING AG10
<b>C12Q 1/68</b> (2018.01)	3768841	METHODS OF TREATING TTR AMYLOIDOSIS USING AG10
<b>A61K 31/4184</b> (2006.01)	3768258	COMBINATION THERAPY
<b>A61K 31/519</b> (2006.01)	3768258	COMBINATION THERAPY
<b>A61P 35/00</b> (2006.01)	3768258	COMBINATION THERAPY
<b>A61K 38/07</b> (2006.01)	3768325	METHODS OF TREATING CANCER WITH A COMBINATION OF A PLATINUM-BASED AGENT AND AN ANTI-TISSUE FACTOR ANTIBODY-DRUG CONJUGATE
<b>A61K 47/68</b> (2017.01)	3768325	METHODS OF TREATING CANCER WITH A COMBINATION OF A PLATINUM-BASED AGENT AND AN ANTI-TISSUE FACTOR ANTIBODY-DRUG CONJUGATE
<b>A61P 35/00</b> (2006.01)	3768325	METHODS OF TREATING CANCER WITH A COMBINATION OF A PLATINUM-BASED AGENT AND AN ANTI-TISSUE FACTOR ANTIBODY-DRUG CONJUGATE
<b>C07K 16/36</b> (2006.01)	3768325	METHODS OF TREATING CANCER WITH A COMBINATION OF A PLATINUM-BASED AGENT AND AN ANTI-TISSUE FACTOR ANTIBODY-DRUG CONJUGATE
<b>A61K 39/395</b> (2006.01)	3768314	ANTIBODIES AGAINST SIGNAL-REGULATORY PROTEIN ALPHA AND METHODS OF USE
<b>A61P 29/00</b> (2006.01)	3768314	ANTIBODIES AGAINST SIGNAL-REGULATORY PROTEIN ALPHA AND METHODS OF USE
<b>A61P 35/00</b> (2006.01)	3768314	ANTIBODIES AGAINST SIGNAL-REGULATORY PROTEIN ALPHA AND METHODS OF USE
<b>A61P 37/06</b> (2006.01)	3768314	ANTIBODIES AGAINST SIGNAL-REGULATORY PROTEIN ALPHA AND METHODS OF USE
<b>C07K 16/28</b> (2006.01)	3768314	ANTIBODIES AGAINST SIGNAL-REGULATORY PROTEIN ALPHA AND METHODS OF USE
<b>A61K 31/495</b> (2006.01)	3768269	COMPOUNDS AND USES THEREOF
<b>C07D 257/02</b> (2006.01)	3768269	COMPOUNDS AND USES THEREOF
<b>A61K 9/10</b> (2006.01)	3769765	PHARMACEUTICAL COMPOSITION INCLUDING SODIUM ALKYL SULFATE



MKP (51)	Broj objave evropske prijava patenta (97)	Naziv pronalaska (54)
<b>A61K 9/14</b> (2006.01)	3769765	PHARMACEUTICAL COMPOSITION INCLUDING SODIUM ALKYL SULFATE
<b>A61K 9/16</b> (2006.01)	3769765	PHARMACEUTICAL COMPOSITION INCLUDING SODIUM ALKYL SULFATE
<b>A61K 9/20</b> (2006.01)	3769765	PHARMACEUTICAL COMPOSITION INCLUDING SODIUM ALKYL SULFATE
<b>A61K 9/48</b> (2006.01)	3769765	PHARMACEUTICAL COMPOSITION INCLUDING SODIUM ALKYL SULFATE
<b>A61K 31/519</b> (2006.01)	3769765	PHARMACEUTICAL COMPOSITION INCLUDING SODIUM ALKYL SULFATE
<b>A61K 47/20</b> (2006.01)	3769765	PHARMACEUTICAL COMPOSITION INCLUDING SODIUM ALKYL SULFATE
<b>A61K 47/26</b> (2006.01)	3769765	PHARMACEUTICAL COMPOSITION INCLUDING SODIUM ALKYL SULFATE
<b>A61K 47/32</b> (2006.01)	3769765	PHARMACEUTICAL COMPOSITION INCLUDING SODIUM ALKYL SULFATE
<b>A61K 47/38</b> (2006.01)	3769765	PHARMACEUTICAL COMPOSITION INCLUDING SODIUM ALKYL SULFATE
<b>A61K 38/20</b> (2006.01)	3768317	ANTI-IL-27 ANTIBODIES AND USES THEREOF
<b>A61K 39/395</b> (2006.01)	3768317	ANTI-IL-27 ANTIBODIES AND USES THEREOF
<b>C07K 14/54</b> (2006.01)	3768317	ANTI-IL-27 ANTIBODIES AND USES THEREOF
<b>C07K 16/24</b> (2006.01)	3768317	ANTI-IL-27 ANTIBODIES AND USES THEREOF
<b>B65G 5/00</b> (2006.01)	3768615	SYSTEM AND METHOD FOR COMPRESSED AIR ENERGY STORAGE
<b>E21F 17/16</b> (2006.01)	3768615	SYSTEM AND METHOD FOR COMPRESSED AIR ENERGY STORAGE
<b>A61K 39/12</b> (2006.01)	3768330	METHODS OF ENHANCING PERSISTENCE OF ADOPTIVELY INFUSED T CELLS
<b>A61K 48/00</b> (2006.01)	3768330	METHODS OF ENHANCING PERSISTENCE OF ADOPTIVELY INFUSED T CELLS
<b>C12N 5/09</b> (2010.01)	3768330	METHODS OF ENHANCING PERSISTENCE OF ADOPTIVELY INFUSED T CELLS
<b>C12N 15/86</b> (2006.01)	3768330	METHODS OF ENHANCING PERSISTENCE OF ADOPTIVELY INFUSED T CELLS
<b>G01N 33/50</b> (2006.01)	3768330	METHODS OF ENHANCING PERSISTENCE OF ADOPTIVELY INFUSED T CELLS
<b>G01N 33/569</b> (2006.01)	3768330	METHODS OF ENHANCING PERSISTENCE OF ADOPTIVELY INFUSED T CELLS
<b>A61K 31/44</b> (2006.01)	3782986	HETEROCYCLIC COMPOUND
<b>A61K 31/443</b> (2006.01)	3782986	HETEROCYCLIC COMPOUND
<b>A61K 31/4433</b> (2006.01)	3782986	HETEROCYCLIC COMPOUND
<b>A61K 31/4439</b> (2006.01)	3782986	HETEROCYCLIC COMPOUND
<b>A61K 31/444</b> (2006.01)	3782986	HETEROCYCLIC COMPOUND
<b>A61K 31/4545</b> (2006.01)	3782986	HETEROCYCLIC COMPOUND
<b>A61K 31/496</b> (2006.01)	3782986	HETEROCYCLIC COMPOUND
<b>A61K 31/497</b> (2006.01)	3782986	HETEROCYCLIC COMPOUND
<b>A61K 31/501</b> (2006.01)	3782986	HETEROCYCLIC COMPOUND
<b>A61K 31/506</b> (2006.01)	3782986	HETEROCYCLIC COMPOUND
<b>A61K 31/517</b> (2006.01)	3782986	HETEROCYCLIC COMPOUND
<b>A61K 31/5377</b> (2006.01)	3782986	HETEROCYCLIC COMPOUND
<b>A61K 31/5383</b> (2006.01)	3782986	HETEROCYCLIC COMPOUND
<b>A61K 31/541</b> (2006.01)	3782986	HETEROCYCLIC COMPOUND
<b>A61K 31/55</b> (2006.01)	3782986	HETEROCYCLIC COMPOUND
<b>A61K 31/551</b> (2006.01)	3782986	HETEROCYCLIC COMPOUND
<b>A61K 31/553</b> (2006.01)	3782986	HETEROCYCLIC COMPOUND
<b>A61K 31/554</b> (2006.01)	3782986	HETEROCYCLIC COMPOUND
<b>A61P 35/00</b> (2006.01)	3782986	HETEROCYCLIC COMPOUND
<b>A61P 43/00</b> (2006.01)	3782986	HETEROCYCLIC COMPOUND
<b>C07D 213/85</b> (2006.01)	3782986	HETEROCYCLIC COMPOUND
<b>A61K 35/76</b> (2015.01)	3789489	SWELLING INHIBITOR-TYPE ONCOLYTIC VIRUS
<b>A61P 35/00</b> (2006.01)	3789489	SWELLING INHIBITOR-TYPE ONCOLYTIC VIRUS
<b>C07K 16/22</b> (2006.01)	3789489	SWELLING INHIBITOR-TYPE ONCOLYTIC VIRUS
<b>C12N 7/01</b> (2006.01)	3789489	SWELLING INHIBITOR-TYPE ONCOLYTIC VIRUS
<b>C12N 15/13</b> (2006.01)	3789489	SWELLING INHIBITOR-TYPE ONCOLYTIC VIRUS
<b>A61K 35/17</b> (2015.01)	3773630	BCMA-CAR-T CELLS
<b>C07K 16/28</b> (2006.01)	3773630	BCMA-CAR-T CELLS
<b>A61K 31/04</b> (2006.01)	3765029	ROS-RESPONSIVE MICRONEEDLE PATCH FOR ACNE VULGARIS TREATMENT

MKP (51)	Broj objave evropske prijava patenta (97)	Naziv pronalaska (54)
<b>A61K 31/4025</b> (2006.01)	3765029	ROS-RESPONSIVE MICRONEEDLE PATCH FOR ACNE VULGARIS TREATMENT
<b>A61K 31/70</b> (2006.01)	3765029	ROS-RESPONSIVE MICRONEEDLE PATCH FOR ACNE VULGARIS TREATMENT
<b>A61K 35/763</b> (2015.01)	3781188	ADOPTIVE CELLULAR THERAPY
<b>C12N 5/07</b> (2010.01)	3781188	ADOPTIVE CELLULAR THERAPY
<b>C12N 5/10</b> (2006.01)	3781188	ADOPTIVE CELLULAR THERAPY
<b>C12N 7/00</b> (2006.01)	3781188	ADOPTIVE CELLULAR THERAPY
<b>A61K 8/30</b> (2006.01)	3768226	USE OF MICRONEEDLE PATCH TO PROMOTE HAIR GROWTH
<b>A61K 8/65</b> (2006.01)	3768226	USE OF MICRONEEDLE PATCH TO PROMOTE HAIR GROWTH
<b>A61K 9/06</b> (2006.01)	3768226	USE OF MICRONEEDLE PATCH TO PROMOTE HAIR GROWTH
<b>A61K 31/203</b> (2006.01)	3768226	USE OF MICRONEEDLE PATCH TO PROMOTE HAIR GROWTH
<b>A61K 31/785</b> (2006.01)	3768226	USE OF MICRONEEDLE PATCH TO PROMOTE HAIR GROWTH
<b>A61K 47/69</b> (2017.01)	3768226	USE OF MICRONEEDLE PATCH TO PROMOTE HAIR GROWTH
<b>A61P 17/14</b> (2006.01)	3768226	USE OF MICRONEEDLE PATCH TO PROMOTE HAIR GROWTH
<b>A61K 31/4375</b> (2006.01)	3773573	ANTAGONISTS OF HUMAN INTEGRIN (ALPHA4)(BETA7)
<b>C07D 207/04</b> (2006.01)	3773573	ANTAGONISTS OF HUMAN INTEGRIN (ALPHA4)(BETA7)
<b>C07D 471/04</b> (2006.01)	3773573	ANTAGONISTS OF HUMAN INTEGRIN (ALPHA4)(BETA7)
<b>A61K 31/444</b> (2006.01)	3784671	DUAL ATM AND DNA-PK INHIBITORS FOR USE IN ANTI-TUMOR THERAPY
<b>A61K 31/4545</b> (2006.01)	3784671	DUAL ATM AND DNA-PK INHIBITORS FOR USE IN ANTI-TUMOR THERAPY
<b>A61K 31/4745</b> (2006.01)	3784671	DUAL ATM AND DNA-PK INHIBITORS FOR USE IN ANTI-TUMOR THERAPY
<b>A61K 31/502</b> (2006.01)	3784671	DUAL ATM AND DNA-PK INHIBITORS FOR USE IN ANTI-TUMOR THERAPY
<b>A61P 35/00</b> (2006.01)	3784671	DUAL ATM AND DNA-PK INHIBITORS FOR USE IN ANTI-TUMOR THERAPY
<b>C07D 471/10</b> (2006.01)	3784671	DUAL ATM AND DNA-PK INHIBITORS FOR USE IN ANTI-TUMOR THERAPY
<b>A61K 31/401</b> (2006.01)	3781157	METHODS OF TREATING NEUROPATHIC PAIN
<b>A61P 25/02</b> (2006.01)	3781157	METHODS OF TREATING NEUROPATHIC PAIN
<b>B32B 15/092</b> (2006.01)	3783043	THERMOSETTING COMPOSITION, PREPREG, LAMINATE, METAL FOIL-CLAD LAMINATE, PRINTED WIRING BOARD, AND MULTILAYER PRINTED WIRING BOARD
<b>C08G 59/32</b> (2006.01)	3783043	THERMOSETTING COMPOSITION, PREPREG, LAMINATE, METAL FOIL-CLAD LAMINATE, PRINTED WIRING BOARD, AND MULTILAYER PRINTED WIRING BOARD
<b>C08J 5/24</b> (2006.01)	3783043	THERMOSETTING COMPOSITION, PREPREG, LAMINATE, METAL FOIL-CLAD LAMINATE, PRINTED WIRING BOARD, AND MULTILAYER PRINTED WIRING BOARD
<b>C08K 3/013</b> (2018.01)	3783043	THERMOSETTING COMPOSITION, PREPREG, LAMINATE, METAL FOIL-CLAD LAMINATE, PRINTED WIRING BOARD, AND MULTILAYER PRINTED WIRING BOARD
<b>C08K 5/13</b> (2006.01)	3783043	THERMOSETTING COMPOSITION, PREPREG, LAMINATE, METAL FOIL-CLAD LAMINATE, PRINTED WIRING BOARD, AND MULTILAYER PRINTED WIRING BOARD
<b>C08L 63/00</b> (2006.01)	3783043	THERMOSETTING COMPOSITION, PREPREG, LAMINATE, METAL FOIL-CLAD LAMINATE, PRINTED WIRING BOARD, AND MULTILAYER PRINTED WIRING BOARD
<b>H05K 1/03</b> (2006.01)	3783043	THERMOSETTING COMPOSITION, PREPREG, LAMINATE, METAL FOIL-CLAD LAMINATE, PRINTED WIRING BOARD, AND MULTILAYER PRINTED WIRING BOARD
<b>H05K 3/46</b> (2006.01)	3783043	THERMOSETTING COMPOSITION, PREPREG, LAMINATE, METAL FOIL-CLAD LAMINATE, PRINTED WIRING BOARD, AND MULTILAYER PRINTED WIRING BOARD
<b>A61K 35/17</b> (2015.01)	3781177	REPROGRAMMING CD4 T CELLS INTO CYTOTOXIC CD8 CELLS BY FORCED EXPRESSION OF CD8AB AND CLASS 1 RESTRICTED T CELL RECEPTORS
<b>C07K 14/705</b> (2006.01)	3781177	REPROGRAMMING CD4 T CELLS INTO CYTOTOXIC CD8 CELLS BY FORCED EXPRESSION OF CD8AB AND CLASS 1 RESTRICTED T CELL RECEPTORS
<b>C07K 14/715</b> (2006.01)	3781177	REPROGRAMMING CD4 T CELLS INTO CYTOTOXIC CD8 CELLS BY FORCED EXPRESSION OF CD8AB AND CLASS 1 RESTRICTED T CELL RECEPTORS
<b>C07K 14/725</b> (2006.01)	3781177	REPROGRAMMING CD4 T CELLS INTO CYTOTOXIC CD8 CELLS BY FORCED EXPRESSION OF CD8AB AND CLASS 1 RESTRICTED T CELL RECEPTORS

MKP (51)	Broj objave evropske prijava patenta (97)	Naziv pronalaska (54)
<b>C12N 5/0783</b> (2010.01)	3781177	REPROGRAMMING CD4 T CELLS INTO CYTOTOXIC CD8 CELLS BY FORCED EXPRESSION OF CD8AB AND CLASS 1 RESTRICTED T CELL RECEPTORS
<b>C12N 5/10</b> (2006.01)	3781177	REPROGRAMMING CD4 T CELLS INTO CYTOTOXIC CD8 CELLS BY FORCED EXPRESSION OF CD8AB AND CLASS 1 RESTRICTED T CELL RECEPTORS
<b>C12N 15/10</b> (2006.01)	3781177	REPROGRAMMING CD4 T CELLS INTO CYTOTOXIC CD8 CELLS BY FORCED EXPRESSION OF CD8AB AND CLASS 1 RESTRICTED T CELL RECEPTORS
<b>C12N 15/86</b> (2006.01)	3781177	REPROGRAMMING CD4 T CELLS INTO CYTOTOXIC CD8 CELLS BY FORCED EXPRESSION OF CD8AB AND CLASS 1 RESTRICTED T CELL RECEPTORS
<b>C12N 15/867</b> (2006.01)	3781177	REPROGRAMMING CD4 T CELLS INTO CYTOTOXIC CD8 CELLS BY FORCED EXPRESSION OF CD8AB AND CLASS 1 RESTRICTED T CELL RECEPTORS
<b>A61K 31/4184</b> (2006.01)	3782648	PREVENTATIVE AND THERAPEUTIC AGENTS FOR SARCOPENIA
<b>A61K 31/454</b> (2006.01)	3782648	PREVENTATIVE AND THERAPEUTIC AGENTS FOR SARCOPENIA
<b>A61K 31/5377</b> (2006.01)	3782648	PREVENTATIVE AND THERAPEUTIC AGENTS FOR SARCOPENIA
<b>A61K 45/00</b> (2006.01)	3782648	PREVENTATIVE AND THERAPEUTIC AGENTS FOR SARCOPENIA
<b>A61P 21/00</b> (2006.01)	3782648	PREVENTATIVE AND THERAPEUTIC AGENTS FOR SARCOPENIA
<b>A61P 43/00</b> (2006.01)	3782648	PREVENTATIVE AND THERAPEUTIC AGENTS FOR SARCOPENIA
<b>A61B 6/00</b> (2006.01)	3784132	IMAGING DEVICES
<b>G01T 1/20</b> (2006.01)	3784132	IMAGING DEVICES
<b>G01T 1/24</b> (2006.01)	3784132	IMAGING DEVICES
<b>H01L 25/065</b> (2006.01)	3784132	IMAGING DEVICES
<b>H01L 27/146</b> (2006.01)	3784132	IMAGING DEVICES
<b>A61K 31/422</b> (2006.01)	3784234	COMPOUNDS AND USES THEREOF
<b>A61P 35/00</b> (2006.01)	3784234	COMPOUNDS AND USES THEREOF
<b>C07D 263/48</b> (2006.01)	3784234	COMPOUNDS AND USES THEREOF
<b>A61K 35/28</b> (2015.01)	3784258	ARTIFICIAL EXOSOME COMPOSITION AND RELATED METHODS
<b>C12N 15/861</b> (2006.01)	3784258	ARTIFICIAL EXOSOME COMPOSITION AND RELATED METHODS
<b>C12N 15/88</b> (2006.01)	3784258	ARTIFICIAL EXOSOME COMPOSITION AND RELATED METHODS
<b>C07K 16/18</b> (2006.01)	3784699	OPTIMIZED ANTI-TL1A ANTIBODIES
<b>C07K 16/28</b> (2006.01)	3784699	OPTIMIZED ANTI-TL1A ANTIBODIES
<b>A61K 31/4985</b> (2006.01)	3784241	TRICYCLIC HETEROCYCLE COMPOUNDS USEFUL AS HIV INTEGRASE INHIBITORS
<b>C07D 487/16</b> (2006.01)	3784241	TRICYCLIC HETEROCYCLE COMPOUNDS USEFUL AS HIV INTEGRASE INHIBITORS
<b>C07D 239/70</b> (2006.01)	3784657	USE OF NEUTROPHIL ELASTASE INHIBITORS IN LIVER DISEASE
<b>C07D 401/10</b> (2006.01)	3784657	USE OF NEUTROPHIL ELASTASE INHIBITORS IN LIVER DISEASE
<b>C07D 403/10</b> (2006.01)	3784657	USE OF NEUTROPHIL ELASTASE INHIBITORS IN LIVER DISEASE
<b>C07K 5/06</b> (2006.01)	3797114	HUMAN-DERIVED ANTI-(POLY-GA) DIPEPTIDE REPEAT (DPR) ANTIBODY
<b>C07K 16/44</b> (2006.01)	3797114	HUMAN-DERIVED ANTI-(POLY-GA) DIPEPTIDE REPEAT (DPR) ANTIBODY
<b>G06F 21/32</b> (2013.01)	3770780	IDENTIFICATION SYSTEM, METHOD, AND PROGRAM
<b>G06T 7/00</b> (2017.01)	3770780	IDENTIFICATION SYSTEM, METHOD, AND PROGRAM
<b>A24D 3/06</b> (2006.01)	3711497	SEAMLESS CAPSULE, AND FILTER AND SMOKING DEVICE INCLUDING SAME
<b>E05B 19/18</b> (2006.01)	3789569	KEY HAVING A CATCH AND A REPLACEABLE BLADE, LOCK, AND OPERATING METHOD THEREOF (VARIANTS)
<b>E05B 63/00</b> (2006.01)	3789569	KEY HAVING A CATCH AND A REPLACEABLE BLADE, LOCK, AND OPERATING METHOD THEREOF (VARIANTS)
<b>B65B 35/30</b> (2006.01)	3787988	GROUPING STATION FOR GROUPING PALLETS
<b>B65G 47/08</b> (2006.01)	3787988	GROUPING STATION FOR GROUPING PALLETS
<b>B65G 47/54</b> (2006.01)	3787988	GROUPING STATION FOR GROUPING PALLETS
<b>B65G 47/56</b> (2006.01)	3787988	GROUPING STATION FOR GROUPING PALLETS
<b>B65G 47/57</b> (2006.01)	3787988	GROUPING STATION FOR GROUPING PALLETS
<b>A61B 18/20</b> (2006.01)	3790492	AUTOMATED DENTAL DRILL
<b>A61B 34/20</b> (2016.01)	3790492	AUTOMATED DENTAL DRILL
<b>A61C 1/00</b> (2006.01)	3790492	AUTOMATED DENTAL DRILL
<b>A61C 1/02</b> (2006.01)	3790492	AUTOMATED DENTAL DRILL
<b>A61K 39/395</b> (2006.01)	3790584	METHODS OF TREATING CANCER WITH A COMBINATION OF AN ANTI-PD-1 ANTIBODY AND AN ANTI-TISSUE FACTOR ANTIBODY-DRUG CONJUGATE
<b>C07K 16/28</b> (2006.01)	3790584	METHODS OF TREATING CANCER WITH A COMBINATION OF AN ANTI-PD-1 ANTIBODY AND AN ANTI-TISSUE FACTOR ANTIBODY-DRUG CONJUGATE

MKP	Broj objave evropske prijave patenta (97)	Naziv pronalaska (54)
(51)		(54)
<b>C07K 16/36</b> (2006.01)	3790584	METHODS OF TREATING CANCER WITH A COMBINATION OF AN ANTI-PD-1 ANTIBODY AND AN ANTI-TISSUE FACTOR ANTIBODY-DRUG CONJUGATE
<b>C12N 15/113</b> (2010.01)	3799602	COMPOUNDS AND METHODS FOR REDUCING ATXN3 EXPRESSION
<b>A61K 31/7088</b> (2006.01)	3795688	NUCLEIC ACID FOR TREATING MITE ALLERGY
<b>A61P 37/00</b> (2006.01)	3795688	NUCLEIC ACID FOR TREATING MITE ALLERGY
<b>C12N 1/15</b> (2006.01)	3795688	NUCLEIC ACID FOR TREATING MITE ALLERGY
<b>C12N 1/19</b> (2006.01)	3795688	NUCLEIC ACID FOR TREATING MITE ALLERGY
<b>C12N 1/21</b> (2006.01)	3795688	NUCLEIC ACID FOR TREATING MITE ALLERGY
<b>C12N 5/10</b> (2006.01)	3795688	NUCLEIC ACID FOR TREATING MITE ALLERGY
<b>C12N 15/12</b> (2006.01)	3795688	NUCLEIC ACID FOR TREATING MITE ALLERGY
<b>C12N 15/62</b> (2006.01)	3795688	NUCLEIC ACID FOR TREATING MITE ALLERGY
<b>C12N 15/63</b> (2006.01)	3795688	NUCLEIC ACID FOR TREATING MITE ALLERGY
<b>A61K 31/7088</b> (2006.01)	3792361	NUCLEIC ACID FOR TREATING CRUSTACEAN ALLERGY
<b>A61P 37/08</b> (2006.01)	3792361	NUCLEIC ACID FOR TREATING CRUSTACEAN ALLERGY
<b>C12N 1/15</b> (2006.01)	3792361	NUCLEIC ACID FOR TREATING CRUSTACEAN ALLERGY
<b>C12N 1/19</b> (2006.01)	3792361	NUCLEIC ACID FOR TREATING CRUSTACEAN ALLERGY
<b>C12N 1/21</b> (2006.01)	3792361	NUCLEIC ACID FOR TREATING CRUSTACEAN ALLERGY
<b>C12N 5/10</b> (2006.01)	3792361	NUCLEIC ACID FOR TREATING CRUSTACEAN ALLERGY
<b>C12N 15/62</b> (2006.01)	3792361	NUCLEIC ACID FOR TREATING CRUSTACEAN ALLERGY
<b>C12N 15/63</b> (2006.01)	3792361	NUCLEIC ACID FOR TREATING CRUSTACEAN ALLERGY
<b>A61K 31/506</b> (2006.01)	3790866	DIHYDROPYRIMIDINE DERIVATIVES AND USES THEREOF IN THE TREATMENT OF HBV INFECTION OR OF HBV-INDUCED DISEASES
<b>A61P 31/20</b> (2006.01)	3790866	DIHYDROPYRIMIDINE DERIVATIVES AND USES THEREOF IN THE TREATMENT OF HBV INFECTION OR OF HBV-INDUCED DISEASES
<b>C07D 239/20</b> (2006.01)	3790866	DIHYDROPYRIMIDINE DERIVATIVES AND USES THEREOF IN THE TREATMENT OF HBV INFECTION OR OF HBV-INDUCED DISEASES
<b>C07D 403/04</b> (2006.01)	3790866	DIHYDROPYRIMIDINE DERIVATIVES AND USES THEREOF IN THE TREATMENT OF HBV INFECTION OR OF HBV-INDUCED DISEASES
<b>C07D 417/04</b> (2006.01)	3790866	DIHYDROPYRIMIDINE DERIVATIVES AND USES THEREOF IN THE TREATMENT OF HBV INFECTION OR OF HBV-INDUCED DISEASES
<b>A61K 31/437</b> (2006.01)	3792260	AZABENZIMIDAZOLE COMPOUNDS AND PHARMACEUTICAL
<b>A61K 31/444</b> (2006.01)	3792260	AZABENZIMIDAZOLE COMPOUNDS AND PHARMACEUTICAL
<b>A61K 31/4545</b> (2006.01)	3792260	AZABENZIMIDAZOLE COMPOUNDS AND PHARMACEUTICAL
<b>A61K 31/46</b> (2006.01)	3792260	AZABENZIMIDAZOLE COMPOUNDS AND PHARMACEUTICAL
<b>A61K 31/496</b> (2006.01)	3792260	AZABENZIMIDAZOLE COMPOUNDS AND PHARMACEUTICAL
<b>A61K 31/497</b> (2006.01)	3792260	AZABENZIMIDAZOLE COMPOUNDS AND PHARMACEUTICAL
<b>A61K 31/551</b> (2006.01)	3792260	AZABENZIMIDAZOLE COMPOUNDS AND PHARMACEUTICAL
<b>A61P 3/10</b> (2006.01)	3792260	AZABENZIMIDAZOLE COMPOUNDS AND PHARMACEUTICAL
<b>A61P 13/02</b> (2006.01)	3792260	AZABENZIMIDAZOLE COMPOUNDS AND PHARMACEUTICAL
<b>A61P 13/10</b> (2006.01)	3792260	AZABENZIMIDAZOLE COMPOUNDS AND PHARMACEUTICAL
<b>A61P 27/06</b> (2006.01)	3792260	AZABENZIMIDAZOLE COMPOUNDS AND PHARMACEUTICAL
<b>A61P 43/00</b> (2006.01)	3792260	AZABENZIMIDAZOLE COMPOUNDS AND PHARMACEUTICAL
<b>C07D 471/04</b> (2006.01)	3792260	AZABENZIMIDAZOLE COMPOUNDS AND PHARMACEUTICAL
<b>C07D 519/00</b> (2006.01)	3792260	AZABENZIMIDAZOLE COMPOUNDS AND PHARMACEUTICAL
<b>A61C 1/00</b> (2006.01)	3790493	APPARATUS AND METHOD FOR DENTAL CLAMPING
<b>A61C 3/04</b> (2006.01)	3790493	APPARATUS AND METHOD FOR DENTAL CLAMPING
<b>A61C 5/80</b> (2017.01)	3790493	APPARATUS AND METHOD FOR DENTAL CLAMPING
<b>A61C 19/00</b> (2006.01)	3790493	APPARATUS AND METHOD FOR DENTAL CLAMPING
<b>C07K 14/36</b> (2006.01)	3792349	PEPTIDE MACROCYCLASE
<b>C12N 9/00</b> (2006.01)	3792349	PEPTIDE MACROCYCLASE
<b>C12N 15/52</b> (2006.01)	3792349	PEPTIDE MACROCYCLASE
<b>C12N 15/63</b> (2006.01)	3792349	PEPTIDE MACROCYCLASE
<b>B22F 1/00</b> (2006.01)	3790692	ADDITIVE MANUFACTURING POWDER AND ADDITIVE MANUFACTURING PART MADE USING SAME
<b>B22F 3/00</b> (2021.01)	3790692	ADDITIVE MANUFACTURING POWDER AND ADDITIVE MANUFACTURING PART MADE USING SAME
<b>B22F 9/08</b> (2006.01)	3790692	ADDITIVE MANUFACTURING POWDER AND ADDITIVE MANUFACTURING PART MADE USING SAME
<b>B33Y 70/00</b> (2020.01)	3790692	ADDITIVE MANUFACTURING POWDER AND ADDITIVE MANUFACTURING PART MADE USING SAME
<b>A61K 31/70</b> (2006.01)	3799604	COMPOUNDS AND METHODS FOR REDUCING FXI EXPRESSION
<b>C12N 15/113</b> (2010.01)	3799604	COMPOUNDS AND METHODS FOR REDUCING FXI EXPRESSION
<b>A61K 39/395</b> (2006.01)	3790587	METHODS OF TREATING DEPRESSION USING IL-23 ANTIBODIES
<b>A61P 25/00</b> (2006.01)	3790587	METHODS OF TREATING DEPRESSION USING IL-23 ANTIBODIES
<b>A61P 37/00</b> (2006.01)	3790587	METHODS OF TREATING DEPRESSION USING IL-23 ANTIBODIES
<b>C07K 16/24</b> (2006.01)	3790587	METHODS OF TREATING DEPRESSION USING IL-23 ANTIBODIES

MKP (51)	Broj objave evropske prijava patenta (97)	Naziv pronalaska (54)
<b>C12N 15/13</b> (2006.01)	3790587	METHODS OF TREATING DEPRESSION USING IL-23 ANTIBODIES
<b>A61K 31/19</b> (2006.01)	3793974	CRYSTALLINE FORMS OF 1-(ACYLOXY)-ALKYL CARBAMATE DRUG CONJUGATES OF NAPROXEN AND PREGABALIN
<b>A61P 25/00</b> (2006.01)	3793974	CRYSTALLINE FORMS OF 1-(ACYLOXY)-ALKYL CARBAMATE DRUG CONJUGATES OF NAPROXEN AND PREGABALIN
<b>C07C 229/00</b> (2006.01)	3793974	CRYSTALLINE FORMS OF 1-(ACYLOXY)-ALKYL CARBAMATE DRUG CONJUGATES OF NAPROXEN AND PREGABALIN
<b>A61K 39/395</b> (2006.01)	3793602	TREATMENT OF AGING-ASSOCIATED DISEASE WITH MODULATORS OF LEUKOTRIENE A4 HYDROLASE
<b>A61P 25/00</b> (2006.01)	3793602	TREATMENT OF AGING-ASSOCIATED DISEASE WITH MODULATORS OF LEUKOTRIENE A4 HYDROLASE
<b>A61P 25/28</b> (2006.01)	3793602	TREATMENT OF AGING-ASSOCIATED DISEASE WITH MODULATORS OF LEUKOTRIENE A4 HYDROLASE
<b>C07K 16/40</b> (2006.01)	3793602	TREATMENT OF AGING-ASSOCIATED DISEASE WITH MODULATORS OF LEUKOTRIENE A4 HYDROLASE
<b>A61K 31/41</b> (2006.01)	3793547	MAGL INHIBITORS
<b>A61K 31/4164</b> (2006.01)	3793547	MAGL INHIBITORS
<b>A61K 31/4192</b> (2006.01)	3793547	MAGL INHIBITORS
<b>C12Q 1/68</b> (2018.01)	3794147	QUALITY CONTROL COMPOSITIONS AND WHOLE ORGANISM CONTROL MATERIALS FOR USE IN NUCLEIC ACID TESTING
<b>C12Q 1/6806</b> (2018.01)	3794147	QUALITY CONTROL COMPOSITIONS AND WHOLE ORGANISM CONTROL MATERIALS FOR USE IN NUCLEIC ACID TESTING
<b>C12Q 1/6809</b> (2018.01)	3794147	QUALITY CONTROL COMPOSITIONS AND WHOLE ORGANISM CONTROL MATERIALS FOR USE IN NUCLEIC ACID TESTING
<b>C12Q 1/6876</b> (2018.01)	3794147	QUALITY CONTROL COMPOSITIONS AND WHOLE ORGANISM CONTROL MATERIALS FOR USE IN NUCLEIC ACID TESTING
<b>C12Q 1/6888</b> (2018.01)	3794147	QUALITY CONTROL COMPOSITIONS AND WHOLE ORGANISM CONTROL MATERIALS FOR USE IN NUCLEIC ACID TESTING
<b>A61K 31/423</b> (2006.01)	3793552	ABHD12 INHIBITORS AND METHODS OF MAKING AND USING SAME
<b>A61K 31/424</b> (2006.01)	3793552	ABHD12 INHIBITORS AND METHODS OF MAKING AND USING SAME
<b>A61P 25/28</b> (2006.01)	3793552	ABHD12 INHIBITORS AND METHODS OF MAKING AND USING SAME
<b>C01D 15/02</b> (2006.01)	3793945	PROCESS FOR SELECTIVE ADSORPTION AND RECOVERY OF LITHIUM FROM NATURAL AND SYNTHETIC BRINES
<b>C01D 15/08</b> (2006.01)	3793945	PROCESS FOR SELECTIVE ADSORPTION AND RECOVERY OF LITHIUM FROM NATURAL AND SYNTHETIC BRINES
<b>C22B 3/24</b> (2006.01)	3793945	PROCESS FOR SELECTIVE ADSORPTION AND RECOVERY OF LITHIUM FROM NATURAL AND SYNTHETIC BRINES
<b>A61K 39/395</b> (2006.01)	3793606	METHODS OF TREATING CANCERS AND ENHANCING EFFICACY OF T CELL REDIRECTING THERAPEUTICS
<b>A61P 35/00</b> (2006.01)	3793606	METHODS OF TREATING CANCERS AND ENHANCING EFFICACY OF T CELL REDIRECTING THERAPEUTICS
<b>C07K 16/28</b> (2006.01)	3793606	METHODS OF TREATING CANCERS AND ENHANCING EFFICACY OF T CELL REDIRECTING THERAPEUTICS
<b>C07K 16/30</b> (2006.01)	3793606	METHODS OF TREATING CANCERS AND ENHANCING EFFICACY OF T CELL REDIRECTING THERAPEUTICS
<b>C07K 16/46</b> (2006.01)	3793606	METHODS OF TREATING CANCERS AND ENHANCING EFFICACY OF T CELL REDIRECTING THERAPEUTICS
<b>C07K 19/00</b> (2006.01)	3793606	METHODS OF TREATING CANCERS AND ENHANCING EFFICACY OF T CELL REDIRECTING THERAPEUTICS
<b>A61K 9/00</b> (2006.01)	3793521	SAFE AND EFFECTIVE METHOD OF TREATING LUPUS WITH ANTI- IL12/IL23 ANTIBODY
<b>A61P 37/06</b> (2006.01)	3793521	SAFE AND EFFECTIVE METHOD OF TREATING LUPUS WITH ANTI- IL12/IL23 ANTIBODY
<b>C07K 16/24</b> (2006.01)	3793521	SAFE AND EFFECTIVE METHOD OF TREATING LUPUS WITH ANTI- IL12/IL23 ANTIBODY
<b>C12Q 1/68</b> (2018.01)	3793521	SAFE AND EFFECTIVE METHOD OF TREATING LUPUS WITH ANTI- IL12/IL23 ANTIBODY
<b>C12Q 1/6883</b> (2018.01)	3793521	SAFE AND EFFECTIVE METHOD OF TREATING LUPUS WITH ANTI- IL12/IL23 ANTIBODY
<b>A61K 45/06</b> (2006.01)	3793608	ANTI-CANCER NUCLEAR HORMONE RECEPTOR-TARGETING COMPOUNDS
<b>C07D 401/14</b> (2006.01)	3793608	ANTI-CANCER NUCLEAR HORMONE RECEPTOR-TARGETING COMPOUNDS
<b>C12M 1/00</b> (2006.01)	3794349	DEVICES, SYSTEMS AND APPARATUSES FOR GENERATING SELF-SUSTAINING HYPOXIC CONDITIONS AND GASEOUS AND

MKP (51)	Broj objave evropske prijava patenta (97)	Naziv pronalaska (54)
<b>C12M 3/00</b> (2006.01)	3794349	NON-GASEOUS CHEMICAL GRADIENTS FOR IN VITRO CELL CULTURE DEVICES, SYSTEMS AND APPARATUSES FOR GENERATING SELF-SUSTAINING HYPOXIC CONDITIONS AND GASEOUS AND NON-GASEOUS CHEMICAL GRADIENTS FOR IN VITRO CELL CULTURE
<b>C12N 5/00</b> (2006.01)	3794349	DEVICES, SYSTEMS AND APPARATUSES FOR GENERATING SELF-SUSTAINING HYPOXIC CONDITIONS AND GASEOUS AND NON-GASEOUS CHEMICAL GRADIENTS FOR IN VITRO CELL CULTURE
<b>C12N 13/00</b> (2006.01)	3794349	DEVICES, SYSTEMS AND APPARATUSES FOR GENERATING SELF-SUSTAINING HYPOXIC CONDITIONS AND GASEOUS AND NON-GASEOUS CHEMICAL GRADIENTS FOR IN VITRO CELL CULTURE
<b>G01N 33/50</b> (2006.01)	3794349	DEVICES, SYSTEMS AND APPARATUSES FOR GENERATING SELF-SUSTAINING HYPOXIC CONDITIONS AND GASEOUS AND NON-GASEOUS CHEMICAL GRADIENTS FOR IN VITRO CELL CULTURE
<b>A61K 48/00</b> (2006.01)	3799570	MODULATORS OF APOL1 EXPRESSION
<b>C07H 21/02</b> (2006.01)	3799570	MODULATORS OF APOL1 EXPRESSION
<b>A61K 31/4184</b> (2006.01)	3796914	METHODS OF TREATING CANCERS CHARACTERIZED BY A HIGH EXPRESSION LEVEL OF SPINDLE AND KINETOCHORE ASSOCIATED COMPLEX SUBUNIT 3 (SKA3) GENE
<b>A61K 31/437</b> (2006.01)	3796914	METHODS OF TREATING CANCERS CHARACTERIZED BY A HIGH EXPRESSION LEVEL OF SPINDLE AND KINETOCHORE ASSOCIATED COMPLEX SUBUNIT 3 (SKA3) GENE
<b>A61K 31/44</b> (2006.01)	3796914	METHODS OF TREATING CANCERS CHARACTERIZED BY A HIGH EXPRESSION LEVEL OF SPINDLE AND KINETOCHORE ASSOCIATED COMPLEX SUBUNIT 3 (SKA3) GENE
<b>A61K 31/4985</b> (2006.01)	3796914	METHODS OF TREATING CANCERS CHARACTERIZED BY A HIGH EXPRESSION LEVEL OF SPINDLE AND KINETOCHORE ASSOCIATED COMPLEX SUBUNIT 3 (SKA3) GENE
<b>A61K 31/5025</b> (2006.01)	3796914	METHODS OF TREATING CANCERS CHARACTERIZED BY A HIGH EXPRESSION LEVEL OF SPINDLE AND KINETOCHORE ASSOCIATED COMPLEX SUBUNIT 3 (SKA3) GENE
<b>A61K 31/517</b> (2006.01)	3796914	METHODS OF TREATING CANCERS CHARACTERIZED BY A HIGH EXPRESSION LEVEL OF SPINDLE AND KINETOCHORE ASSOCIATED COMPLEX SUBUNIT 3 (SKA3) GENE
<b>A61K 31/519</b> (2006.01)	3796914	METHODS OF TREATING CANCERS CHARACTERIZED BY A HIGH EXPRESSION LEVEL OF SPINDLE AND KINETOCHORE ASSOCIATED COMPLEX SUBUNIT 3 (SKA3) GENE
<b>A61K 31/52</b> (2006.01)	3796914	METHODS OF TREATING CANCERS CHARACTERIZED BY A HIGH EXPRESSION LEVEL OF SPINDLE AND KINETOCHORE ASSOCIATED COMPLEX SUBUNIT 3 (SKA3) GENE
<b>A61K 31/55</b> (2006.01)	3796914	METHODS OF TREATING CANCERS CHARACTERIZED BY A HIGH EXPRESSION LEVEL OF SPINDLE AND KINETOCHORE ASSOCIATED COMPLEX SUBUNIT 3 (SKA3) GENE
<b>A61P 35/00</b> (2006.01)	3796914	METHODS OF TREATING CANCERS CHARACTERIZED BY A HIGH EXPRESSION LEVEL OF SPINDLE AND KINETOCHORE ASSOCIATED COMPLEX SUBUNIT 3 (SKA3) GENE
<b>C12Q 1/6809</b> (2018.01)	3796914	METHODS OF TREATING CANCERS CHARACTERIZED BY A HIGH EXPRESSION LEVEL OF SPINDLE AND KINETOCHORE ASSOCIATED COMPLEX SUBUNIT 3 (SKA3) GENE
<b>C12Q 1/68</b> (2018.01)	3791012	METHODS FOR FINGERPRINTING OF BIOLOGICAL SAMPLES
<b>C12Q 1/6827</b> (2018.01)	3791012	METHODS FOR FINGERPRINTING OF BIOLOGICAL SAMPLES
<b>C12Q 1/6883</b> (2018.01)	3791012	METHODS FOR FINGERPRINTING OF BIOLOGICAL SAMPLES
<b>C40B 30/00</b> (2006.01)	3791012	METHODS FOR FINGERPRINTING OF BIOLOGICAL SAMPLES
<b>C04B 28/04</b> (2006.01)	3781533	RADIATION-IMPERMEABLE AND RADON GAS-TIGHT FIBER-REINFORCED CONCRETES
<b>C04B 111/00</b> (2006.01)	3781533	RADIATION-IMPERMEABLE AND RADON GAS-TIGHT FIBER-REINFORCED CONCRETES
<b>A61K 39/12</b> (2006.01)	3718565	RESPIRATORY VIRUS VACCINES
<b>A61P 11/00</b> (2006.01)	3718565	RESPIRATORY VIRUS VACCINES
<b>C07K 16/10</b> (2006.01)	3718565	RESPIRATORY VIRUS VACCINES
<b>A61K 38/09</b> (2006.01)	3701965	A COMPOSITION COMPRISING AT LEAST ONE GNRH ANTAGONIST
<b>A61K 45/06</b> (2006.01)	3701965	A COMPOSITION COMPRISING AT LEAST ONE GNRH ANTAGONIST

MKP (51)	Broj objave evropske prijava patenta (97)	Naziv pronalaska (54)
<b>A61P 5/26</b> (2006.01)	3701965	A COMPOSITION COMPRISING AT LEAST ONE GNRH ANTAGONIST
<b>A61P 5/30</b> (2006.01)	3701965	A COMPOSITION COMPRISING AT LEAST ONE GNRH ANTAGONIST
<b>A61P 13/00</b> (2006.01)	3701965	A COMPOSITION COMPRISING AT LEAST ONE GNRH ANTAGONIST
<b>A61P 13/08</b> (2006.01)	3701965	A COMPOSITION COMPRISING AT LEAST ONE GNRH ANTAGONIST
<b>A61P 15/00</b> (2006.01)	3701965	A COMPOSITION COMPRISING AT LEAST ONE GNRH ANTAGONIST
<b>A61P 35/00</b> (2006.01)	3701965	A COMPOSITION COMPRISING AT LEAST ONE GNRH ANTAGONIST
<b>A61P 43/00</b> (2006.01)	3701965	A COMPOSITION COMPRISING AT LEAST ONE GNRH ANTAGONIST
<b>A01D 87/00</b> (2006.01)	3730701	STRUCTURE FOR DETACHABLE FRONT LOADER, DETACHABLE FRONT LOADER, AND WORK VEHICLE
<b>E02F 3/627</b> (2006.01)	3730701	STRUCTURE FOR DETACHABLE FRONT LOADER, DETACHABLE FRONT LOADER, AND WORK VEHICLE
<b>A61K 51/00</b> (2006.01)	3696824	RUBIDIUM ELUTION SYSTEM CONTROL
<b>A61K 51/12</b> (2006.01)	3696824	RUBIDIUM ELUTION SYSTEM CONTROL
<b>A61M 36/00</b> (2006.01)	3696824	RUBIDIUM ELUTION SYSTEM CONTROL
<b>G21G 1/00</b> (2006.01)	3696824	RUBIDIUM ELUTION SYSTEM CONTROL
<b>A61K 31/519</b> (2006.01)	3699181	CRYSTALLINE FORM OF (S)-N-(5-((R)-2-(2,5-DIFLUOROPHENYL)-PYRROLIDIN-1-YL)-PYRAZOLO[1,5-A]PYRIMIDIN-3-YL)-3-HYDROXYPYRROLIDINE-1-CARBOXAMIDE HYDROGEN SULFATE
<b>A61P 35/00</b> (2006.01)	3699181	CRYSTALLINE FORM OF (S)-N-(5-((R)-2-(2,5-DIFLUOROPHENYL)-PYRROLIDIN-1-YL)-PYRAZOLO[1,5-A]PYRIMIDIN-3-YL)-3-HYDROXYPYRROLIDINE-1-CARBOXAMIDE HYDROGEN SULFATE
<b>C07D 487/04</b> (2006.01)	3699181	CRYSTALLINE FORM OF (S)-N-(5-((R)-2-(2,5-DIFLUOROPHENYL)-PYRROLIDIN-1-YL)-PYRAZOLO[1,5-A]PYRIMIDIN-3-YL)-3-HYDROXYPYRROLIDINE-1-CARBOXAMIDE HYDROGEN SULFATE
<b>A61K 39/00</b> (2006.01)	3725327	PEPTIDES AND COMBINATION THEREOF FOR USE IN THE IMMUNOTHERAPY AGAINST CANCERS
<b>A61P 35/00</b> (2006.01)	3725327	PEPTIDES AND COMBINATION THEREOF FOR USE IN THE IMMUNOTHERAPY AGAINST CANCERS
<b>C07K 14/47</b> (2006.01)	3725327	PEPTIDES AND COMBINATION THEREOF FOR USE IN THE IMMUNOTHERAPY AGAINST CANCERS
<b>G01N 33/50</b> (2006.01)	3725327	PEPTIDES AND COMBINATION THEREOF FOR USE IN THE IMMUNOTHERAPY AGAINST CANCERS
<b>A61K 39/00</b> (2006.01)	3760225	NOVEL PEPTIDES AND COMBINATION OF PEPTIDES FOR USE IN IMMUNOTHERAPY AGAINST LUNG CANCER, INCLUDING NSCLC AND OTHER CANCERS
<b>A61P 35/00</b> (2006.01)	3760225	NOVEL PEPTIDES AND COMBINATION OF PEPTIDES FOR USE IN IMMUNOTHERAPY AGAINST LUNG CANCER, INCLUDING NSCLC AND OTHER CANCERS
<b>C07K 14/47</b> (2006.01)	3760225	NOVEL PEPTIDES AND COMBINATION OF PEPTIDES FOR USE IN IMMUNOTHERAPY AGAINST LUNG CANCER, INCLUDING NSCLC AND OTHER CANCERS
<b>C07K 16/00</b> (2006.01)	3760225	NOVEL PEPTIDES AND COMBINATION OF PEPTIDES FOR USE IN IMMUNOTHERAPY AGAINST LUNG CANCER, INCLUDING NSCLC AND OTHER CANCERS
<b>A01N 43/52</b> (2006.01)	3763706	PARASITICIDAL COMPOSITIONS COMPRISING BENZIMIDAZOLE DERIVATIVES, METHODS AND USES THEREOF
<b>A61K 31/4184</b> (2006.01)	3763706	PARASITICIDAL COMPOSITIONS COMPRISING BENZIMIDAZOLE DERIVATIVES, METHODS AND USES THEREOF
<b>C07D 235/10</b> (2006.01)	3763706	PARASITICIDAL COMPOSITIONS COMPRISING BENZIMIDAZOLE DERIVATIVES, METHODS AND USES THEREOF
<b>C07D 235/18</b> (2006.01)	3763706	PARASITICIDAL COMPOSITIONS COMPRISING BENZIMIDAZOLE DERIVATIVES, METHODS AND USES THEREOF
<b>C07D 235/28</b> (2006.01)	3763706	PARASITICIDAL COMPOSITIONS COMPRISING BENZIMIDAZOLE DERIVATIVES, METHODS AND USES THEREOF
<b>B21D 28/02</b> (2006.01)	3797893	DEVICE FOR THE FINE CUTTING / NORMAL STAMPING OF BLANKS MADE FROM A METAL STRIP AND FOR THE MULTI-STAGE MACHINING OF THE BLANKS BY MEANS OF CUTTING AND MACHINING TOOLS
<b>B21D 28/16</b> (2006.01)	3797893	DEVICE FOR THE FINE CUTTING / NORMAL STAMPING OF BLANKS MADE FROM A METAL STRIP AND FOR THE MULTI-

MKP (51)	Broj objave evropske prijava patenta (97)	Naziv pronalaska (54)
<b>B21D 37/08</b> (2006.01)	3797893	STAGE MACHINING OF THE BLANKS BY MEANS OF CUTTING AND MACHINING TOOLS DEVICE FOR THE FINE CUTTING / NORMAL STAMPING OF BLANKS MADE FROM A METAL STRIP AND FOR THE MULTI-STAGE MACHINING OF THE BLANKS BY MEANS OF CUTTING AND MACHINING TOOLS
<b>B21D 43/14</b> (2006.01)	3797893	DEVICE FOR THE FINE CUTTING / NORMAL STAMPING OF BLANKS MADE FROM A METAL STRIP AND FOR THE MULTI-STAGE MACHINING OF THE BLANKS BY MEANS OF CUTTING AND MACHINING TOOLS
<b>A61K 31/422</b> (2006.01)	3766491	PARASITICIDAL ORAL VETERINARY COMPOSITIONS COMPRISING SYSTEMICALLY-ACTING ACTIVE AGENTS, METHODS AND USES THEREOF
<b>A61P 33/00</b> (2006.01)	3766491	PARASITICIDAL ORAL VETERINARY COMPOSITIONS COMPRISING SYSTEMICALLY-ACTING ACTIVE AGENTS, METHODS AND USES THEREOF
<b>A61K 38/12</b> (2006.01)	3778622	MACROCYCLIC PEPTIDES USEFUL AS IMMUNOMODULATORS
<b>A61P 37/06</b> (2006.01)	3778622	MACROCYCLIC PEPTIDES USEFUL AS IMMUNOMODULATORS
<b>C07K 7/08</b> (2006.01)	3778622	MACROCYCLIC PEPTIDES USEFUL AS IMMUNOMODULATORS
<b>C07K 7/56</b> (2006.01)	3778622	MACROCYCLIC PEPTIDES USEFUL AS IMMUNOMODULATORS
<b>G01N 33/68</b> (2006.01)	3778622	MACROCYCLIC PEPTIDES USEFUL AS IMMUNOMODULATORS
<b>A61K 9/10</b> (2006.01)	3769753	PROCESS FOR THE PREPARATION OF STERILE OPHTHALMIC AQUEOUS FLUTICASONE PROPIONATE FORM A NANOCRYSTALS SUSPENSIONS
<b>A61K 9/14</b> (2006.01)	3769753	PROCESS FOR THE PREPARATION OF STERILE OPHTHALMIC AQUEOUS FLUTICASONE PROPIONATE FORM A NANOCRYSTALS SUSPENSIONS
<b>A61K 31/56</b> (2006.01)	3769753	PROCESS FOR THE PREPARATION OF STERILE OPHTHALMIC AQUEOUS FLUTICASONE PROPIONATE FORM A NANOCRYSTALS SUSPENSIONS
<b>A61K 47/02</b> (2006.01)	3769753	PROCESS FOR THE PREPARATION OF STERILE OPHTHALMIC AQUEOUS FLUTICASONE PROPIONATE FORM A NANOCRYSTALS SUSPENSIONS
<b>A61K 47/10</b> (2017.01)	3769753	PROCESS FOR THE PREPARATION OF STERILE OPHTHALMIC AQUEOUS FLUTICASONE PROPIONATE FORM A NANOCRYSTALS SUSPENSIONS
<b>A61P 27/00</b> (2006.01)	3769753	PROCESS FOR THE PREPARATION OF STERILE OPHTHALMIC AQUEOUS FLUTICASONE PROPIONATE FORM A NANOCRYSTALS SUSPENSIONS
<b>C07J 31/00</b> (2006.01)	3769753	PROCESS FOR THE PREPARATION OF STERILE OPHTHALMIC AQUEOUS FLUTICASONE PROPIONATE FORM A NANOCRYSTALS SUSPENSIONS
<b>C07J 71/00</b> (2006.01)	3769753	PROCESS FOR THE PREPARATION OF STERILE OPHTHALMIC AQUEOUS FLUTICASONE PROPIONATE FORM A NANOCRYSTALS SUSPENSIONS
<b>A61K 39/395</b> (2006.01)	3792281	METHODS OF TREATING PSORIASIS USING IL-17 ANTAGONISTS
<b>A61P 17/06</b> (2006.01)	3792281	METHODS OF TREATING PSORIASIS USING IL-17 ANTAGONISTS
<b>C07K 16/24</b> (2006.01)	3792281	METHODS OF TREATING PSORIASIS USING IL-17 ANTAGONISTS
<b>A61P 3/00</b> (2006.01)	3763734	GROWTH DIFFERENTIATION FACTOR 15 (GDF-15) CONSTRUCTS
<b>A61P 3/04</b> (2006.01)	3763734	GROWTH DIFFERENTIATION FACTOR 15 (GDF-15) CONSTRUCTS
<b>A61P 3/06</b> (2006.01)	3763734	GROWTH DIFFERENTIATION FACTOR 15 (GDF-15) CONSTRUCTS
<b>A61P 3/08</b> (2006.01)	3763734	GROWTH DIFFERENTIATION FACTOR 15 (GDF-15) CONSTRUCTS
<b>A61P 3/10</b> (2006.01)	3763734	GROWTH DIFFERENTIATION FACTOR 15 (GDF-15) CONSTRUCTS
<b>A61P 3/12</b> (2006.01)	3763734	GROWTH DIFFERENTIATION FACTOR 15 (GDF-15) CONSTRUCTS
<b>A61P 13/12</b> (2006.01)	3763734	GROWTH DIFFERENTIATION FACTOR 15 (GDF-15) CONSTRUCTS
<b>C07K 14/475</b> (2006.01)	3763734	GROWTH DIFFERENTIATION FACTOR 15 (GDF-15) CONSTRUCTS
<b>C07K 14/495</b> (2006.01)	3763734	GROWTH DIFFERENTIATION FACTOR 15 (GDF-15) CONSTRUCTS
<b>C07K 14/765</b> (2006.01)	3763734	GROWTH DIFFERENTIATION FACTOR 15 (GDF-15) CONSTRUCTS
<b>C12N 15/62</b> (2006.01)	3763734	GROWTH DIFFERENTIATION FACTOR 15 (GDF-15) CONSTRUCTS
<b>A01N 25/00</b> (2006.01)	3788874	PARASITICIDAL COMPOSITIONS COMPRISING AN ISOXAZOLINE ACTIVE AGENT, METHOD AND USES THEREOF
<b>A61K 31/42</b> (2006.01)	3788874	PARASITICIDAL COMPOSITIONS COMPRISING AN ISOXAZOLINE ACTIVE AGENT, METHOD AND USES THEREOF
<b>A61P 33/00</b> (2006.01)	3788874	PARASITICIDAL COMPOSITIONS COMPRISING AN ISOXAZOLINE ACTIVE AGENT, METHOD AND USES THEREOF
<b>A61K 31/4192</b> (2006.01)	3766878	NRF2 REGULATORS
<b>A61K 31/553</b> (2006.01)	3766878	NRF2 REGULATORS
<b>A61P 9/10</b> (2006.01)	3766878	NRF2 REGULATORS



MKP	Broj objave evropske prijave patenta	Naziv pronalaska
(51)	(97)	(54)
A61P 9/12 (2006.01)	3766878	NRF2 REGULATORS
A61P 11/00 (2006.01)	3766878	NRF2 REGULATORS
A61P 11/06 (2006.01)	3766878	NRF2 REGULATORS
A61P 13/12 (2006.01)	3766878	NRF2 REGULATORS
A61P 17/00 (2006.01)	3766878	NRF2 REGULATORS
A61P 25/00 (2006.01)	3766878	NRF2 REGULATORS
A61P 35/00 (2006.01)	3766878	NRF2 REGULATORS
A61P 37/00 (2006.01)	3766878	NRF2 REGULATORS
C07D 267/14 (2006.01)	3766878	NRF2 REGULATORS
C07D 403/06 (2006.01)	3766878	NRF2 REGULATORS
C07D 413/06 (2006.01)	3766878	NRF2 REGULATORS
C07D 413/10 (2006.01)	3766878	NRF2 REGULATORS
C07D 498/04 (2006.01)	3766878	NRF2 REGULATORS
C07D 519/00 (2006.01)	3766878	NRF2 REGULATORS
A61K 8/04 (2006.01)	3799933	COMPOSITION FOR THE TREATMENT OF ACNE
A61K 8/34 (2006.01)	3799933	COMPOSITION FOR THE TREATMENT OF ACNE
A61K 8/36 (2006.01)	3799933	COMPOSITION FOR THE TREATMENT OF ACNE
A61K 8/365 (2006.01)	3799933	COMPOSITION FOR THE TREATMENT OF ACNE
A61K 8/60 (2006.01)	3799933	COMPOSITION FOR THE TREATMENT OF ACNE
A61K 8/9789 (2017.01)	3799933	COMPOSITION FOR THE TREATMENT OF ACNE
A61K 9/00 (2006.01)	3799933	COMPOSITION FOR THE TREATMENT OF ACNE
A61K 9/107 (2006.01)	3799933	COMPOSITION FOR THE TREATMENT OF ACNE
A61K 31/047 (2006.01)	3799933	COMPOSITION FOR THE TREATMENT OF ACNE
A61K 36/76 (2006.01)	3799933	COMPOSITION FOR THE TREATMENT OF ACNE
A61K 47/10 (2017.01)	3799933	COMPOSITION FOR THE TREATMENT OF ACNE
A61P 17/10 (2006.01)	3799933	COMPOSITION FOR THE TREATMENT OF ACNE
A61Q 17/04 (2006.01)	3799933	COMPOSITION FOR THE TREATMENT OF ACNE
A61Q 19/00 (2006.01)	3799933	COMPOSITION FOR THE TREATMENT OF ACNE
A61Q 19/10 (2006.01)	3799933	COMPOSITION FOR THE TREATMENT OF ACNE
A61K 31/4174 (2006.01)	3770146	PPAR AGONISTS, COMPOUNDS, PHARMACEUTICAL COMPOSITIONS, AND METHODS OF USE THEREOF
A61K 31/4439 (2006.01)	3770146	PPAR AGONISTS, COMPOUNDS, PHARMACEUTICAL COMPOSITIONS, AND METHODS OF USE THEREOF
A61P 21/00 (2006.01)	3770146	PPAR AGONISTS, COMPOUNDS, PHARMACEUTICAL COMPOSITIONS, AND METHODS OF USE THEREOF
C07D 233/64 (2006.01)	3770146	PPAR AGONISTS, COMPOUNDS, PHARMACEUTICAL COMPOSITIONS, AND METHODS OF USE THEREOF
C07D 401/04 (2006.01)	3770146	PPAR AGONISTS, COMPOUNDS, PHARMACEUTICAL COMPOSITIONS, AND METHODS OF USE THEREOF
C07D 405/10 (2006.01)	3770146	PPAR AGONISTS, COMPOUNDS, PHARMACEUTICAL COMPOSITIONS, AND METHODS OF USE THEREOF
A61K 31/4174 (2006.01)	3795566	PPAR AGONISTS, COMPOUNDS, PHARMACEUTICAL COMPOSITIONS, AND METHODS OF USE THEREOF
A61K 31/4439 (2006.01)	3795566	PPAR AGONISTS, COMPOUNDS, PHARMACEUTICAL COMPOSITIONS, AND METHODS OF USE THEREOF
A61P 21/00 (2006.01)	3795566	PPAR AGONISTS, COMPOUNDS, PHARMACEUTICAL COMPOSITIONS, AND METHODS OF USE THEREOF
A61P 25/00 (2006.01)	3795566	PPAR AGONISTS, COMPOUNDS, PHARMACEUTICAL COMPOSITIONS, AND METHODS OF USE THEREOF
C07D 401/04 (2006.01)	3795566	PPAR AGONISTS, COMPOUNDS, PHARMACEUTICAL COMPOSITIONS, AND METHODS OF USE THEREOF
A61K 31/4188 (2006.01)	3778606	CONDENSED IMIDAZOLYLIMIDAZOLES AS ANTIVIRAL COMPOUNDS
C07D 491/052 (2006.01)	3778606	CONDENSED IMIDAZOLYLIMIDAZOLES AS ANTIVIRAL COMPOUNDS
A61K 31/4188 (2006.01)	3778606	CONDENSED IMIDAZOLYLIMIDAZOLES AS ANTIVIRAL COMPOUNDS
C07D 491/052 (2006.01)	3778606	CONDENSED IMIDAZOLYLIMIDAZOLES AS ANTIVIRAL COMPOUNDS
A01N 43/50 (2006.01)	3766871	DIARYLIMIDAZOLE COMPOUND AND PEST CONTROL AGENT
A01P 7/02 (2006.01)	3766871	DIARYLIMIDAZOLE COMPOUND AND PEST CONTROL AGENT
A01P 7/04 (2006.01)	3766871	DIARYLIMIDAZOLE COMPOUND AND PEST CONTROL AGENT
A61K 31/4164 (2006.01)	3766871	DIARYLIMIDAZOLE COMPOUND AND PEST CONTROL AGENT
A61K 31/4439 (2006.01)	3766871	DIARYLIMIDAZOLE COMPOUND AND PEST CONTROL AGENT
A61P 31/00 (2006.01)	3766871	DIARYLIMIDAZOLE COMPOUND AND PEST CONTROL AGENT
A61P 33/00 (2006.01)	3766871	DIARYLIMIDAZOLE COMPOUND AND PEST CONTROL AGENT
A61P 33/10 (2006.01)	3766871	DIARYLIMIDAZOLE COMPOUND AND PEST CONTROL AGENT
A61P 33/14 (2006.01)	3766871	DIARYLIMIDAZOLE COMPOUND AND PEST CONTROL AGENT

MKP	Broj objave evropske prijave patenta (97)	Naziv pronalaska (54)
(51)		(54)
<b>C07D 233/64</b> (2006.01)	3766871	DIARYLIMIDAZOLE COMPOUND AND PEST CONTROL AGENT
<b>C07D 401/04</b> (2006.01)	3766871	DIARYLIMIDAZOLE COMPOUND AND PEST CONTROL AGENT
<b>A61K 31/45</b> (2006.01)	3786160	PYRIDINE DERIVATIVES AND THERAPEUTIC USES THEREOF AS TRPC6 INHIBITORS
<b>A61K 31/501</b> (2006.01)	3786160	PYRIDINE DERIVATIVES AND THERAPEUTIC USES THEREOF AS TRPC6 INHIBITORS
<b>C07D 213/04</b> (2006.01)	3786160	PYRIDINE DERIVATIVES AND THERAPEUTIC USES THEREOF AS TRPC6 INHIBITORS
<b>C07D 401/14</b> (2006.01)	3786160	PYRIDINE DERIVATIVES AND THERAPEUTIC USES THEREOF AS TRPC6 INHIBITORS
<b>C07D 451/02</b> (2006.01)	3786160	PYRIDINE DERIVATIVES AND THERAPEUTIC USES THEREOF AS TRPC6 INHIBITORS
<b>C07D 487/08</b> (2006.01)	3786160	PYRIDINE DERIVATIVES AND THERAPEUTIC USES THEREOF AS TRPC6 INHIBITORS
<b>C07D 498/08</b> (2006.01)	3786160	PYRIDINE DERIVATIVES AND THERAPEUTIC USES THEREOF AS TRPC6 INHIBITORS
<b>A61K 39/095</b> (2006.01)	3782643	MODIFIED MENINGOCOCCAL FHBP POLYPEPTIDES
<b>C07K 14/095</b> (2006.01)	3782643	MODIFIED MENINGOCOCCAL FHBP POLYPEPTIDES
<b>C07K 14/22</b> (2006.01)	3782643	MODIFIED MENINGOCOCCAL FHBP POLYPEPTIDES
<b>A61P 25/28</b> (2006.01)	3786182	HUMANIZED TAU ANTIBODIES IN ALZHEIMER'S DISEASE
<b>C07K 14/435</b> (2006.01)	3786182	HUMANIZED TAU ANTIBODIES IN ALZHEIMER'S DISEASE
<b>C07K 16/18</b> (2006.01)	3786182	HUMANIZED TAU ANTIBODIES IN ALZHEIMER'S DISEASE
<b>G01N 33/53</b> (2006.01)	3786182	HUMANIZED TAU ANTIBODIES IN ALZHEIMER'S DISEASE
<b>A61K 39/395</b> (2006.01)	3789038	HUMANIZED AND CHIMERIC MONOCLONAL ANTIBODIES TO CD47
<b>A61P 35/00</b> (2006.01)	3789038	HUMANIZED AND CHIMERIC MONOCLONAL ANTIBODIES TO CD47
<b>A61P 35/02</b> (2006.01)	3789038	HUMANIZED AND CHIMERIC MONOCLONAL ANTIBODIES TO CD47
<b>A61P 37/04</b> (2006.01)	3789038	HUMANIZED AND CHIMERIC MONOCLONAL ANTIBODIES TO CD47
<b>C07K 16/28</b> (2006.01)	3789038	HUMANIZED AND CHIMERIC MONOCLONAL ANTIBODIES TO CD47
<b>C07K 16/46</b> (2006.01)	3789038	HUMANIZED AND CHIMERIC MONOCLONAL ANTIBODIES TO CD47
<b>C12N 5/07</b> (2010.01)	3789038	HUMANIZED AND CHIMERIC MONOCLONAL ANTIBODIES TO CD47
<b>C12N 5/16</b> (2006.01)	3789038	HUMANIZED AND CHIMERIC MONOCLONAL ANTIBODIES TO CD47
<b>C12P 21/08</b> (2006.01)	3789038	HUMANIZED AND CHIMERIC MONOCLONAL ANTIBODIES TO CD47
<b>G01N 33/68</b> (2006.01)	3789038	HUMANIZED AND CHIMERIC MONOCLONAL ANTIBODIES TO CD47
<b>A61K 31/5365</b> (2006.01)	3782996	NRF2 REGULATORS
<b>A61P 9/00</b> (2006.01)	3782996	NRF2 REGULATORS
<b>A61P 11/00</b> (2006.01)	3782996	NRF2 REGULATORS
<b>A61P 25/00</b> (2006.01)	3782996	NRF2 REGULATORS
<b>A61P 27/00</b> (2006.01)	3782996	NRF2 REGULATORS
<b>A61P 35/00</b> (2006.01)	3782996	NRF2 REGULATORS
<b>A61P 37/00</b> (2006.01)	3782996	NRF2 REGULATORS
<b>C07C 15/16</b> (2006.01)	3782996	NRF2 REGULATORS
<b>C07D 249/04</b> (2006.01)	3782996	NRF2 REGULATORS
<b>C07D 249/18</b> (2006.01)	3782996	NRF2 REGULATORS
<b>C07D 403/10</b> (2006.01)	3782996	NRF2 REGULATORS
<b>C07D 417/10</b> (2006.01)	3782996	NRF2 REGULATORS
<b>A61K 31/53</b> (2006.01)	3785717	METHODS FOR TREATING CORONAVIRIDAE INFECTIONS
<b>A61K 31/664</b> (2006.01)	3785717	METHODS FOR TREATING CORONAVIRIDAE INFECTIONS
<b>A61K 31/675</b> (2006.01)	3785717	METHODS FOR TREATING CORONAVIRIDAE INFECTIONS
<b>A61K 31/683</b> (2006.01)	3785717	METHODS FOR TREATING CORONAVIRIDAE INFECTIONS
<b>A61K 31/685</b> (2006.01)	3785717	METHODS FOR TREATING CORONAVIRIDAE INFECTIONS
<b>A61P 31/12</b> (2006.01)	3785717	METHODS FOR TREATING CORONAVIRIDAE INFECTIONS
<b>G06F 9/54</b> (2006.01)	3783576	METHOD FOR DETECTING AND ANALYSING DATA DISPLAYED ON A DISPLAY SCREEN OF AN AUTOMATIC COIN-OPERATED GAMING MACHINE
<b>G06F 13/00</b> (2006.01)	3783576	METHOD FOR DETECTING AND ANALYSING DATA DISPLAYED ON A DISPLAY SCREEN OF AN AUTOMATIC COIN-OPERATED GAMING MACHINE
<b>G07F 17/32</b> (2006.01)	3783576	METHOD FOR DETECTING AND ANALYSING DATA DISPLAYED ON A DISPLAY SCREEN OF AN AUTOMATIC COIN-OPERATED GAMING MACHINE
<b>C07D 487/04</b> (2006.01)	3762390	PROCESS FOR PREPARING SOLUBLE GUANYLATE CYCLASE STIMULATORS
<b>C08J 11/12</b> (2006.01)	3765559	METHOD OF OBTAINING TEREPHTHALIC ACID FROM WASTE POLYETHYLENE TEREPHTHALATE
<b>C08J 11/14</b> (2006.01)	3765559	METHOD OF OBTAINING TEREPHTHALIC ACID FROM WASTE POLYETHYLENE TEREPHTHALATE
<b>C08L 67/02</b> (2006.01)	3765559	METHOD OF OBTAINING TEREPHTHALIC ACID FROM WASTE POLYETHYLENE TEREPHTHALATE

MKP (51)	Broj objave evropske prijave patenta (97)	Naziv pronalaska (54)
<b>A61K 31/427</b> (2006.01)	3765458	O-GLYCOPROTEIN-2-ACETAMIDO-2-DEOXY-3-D-GLYCOPYRANOSIDASE INHIBITORS
<b>A61K 31/445</b> (2006.01)	3765458	O-GLYCOPROTEIN-2-ACETAMIDO-2-DEOXY-3-D-GLYCOPYRANOSIDASE INHIBITORS
<b>A61P 25/28</b> (2006.01)	3765458	O-GLYCOPROTEIN-2-ACETAMIDO-2-DEOXY-3-D-GLYCOPYRANOSIDASE INHIBITORS
<b>C07D 417/06</b> (2006.01)	3765458	O-GLYCOPROTEIN-2-ACETAMIDO-2-DEOXY-3-D-GLYCOPYRANOSIDASE INHIBITORS
<b>C07D 417/14</b> (2006.01)	3765458	O-GLYCOPROTEIN-2-ACETAMIDO-2-DEOXY-3-D-GLYCOPYRANOSIDASE INHIBITORS
<b>C07D 495/04</b> (2006.01)	3765458	O-GLYCOPROTEIN-2-ACETAMIDO-2-DEOXY-3-D-GLYCOPYRANOSIDASE INHIBITORS
<b>A61K 31/519</b> (2006.01)	3765461	SELECTIVE INHIBITORS OF PROTEIN ARGININE METHYLTRANSFERASE 5 (PRMT5)
<b>A61P 35/00</b> (2006.01)	3765461	SELECTIVE INHIBITORS OF PROTEIN ARGININE METHYLTRANSFERASE 5 (PRMT5)
<b>C07D 487/04</b> (2006.01)	3765461	SELECTIVE INHIBITORS OF PROTEIN ARGININE METHYLTRANSFERASE 5 (PRMT5)
<b>C07D 519/00</b> (2006.01)	3765461	SELECTIVE INHIBITORS OF PROTEIN ARGININE METHYLTRANSFERASE 5 (PRMT5)
<b>A61P 35/00</b> (2006.01)	3768711	ANTI-CD137 ANTIBODIES FOR COMBINATION WITH ANTI-PD-L1 ANTIBODIES
<b>C07K 16/28</b> (2006.01)	3768711	ANTI-CD137 ANTIBODIES FOR COMBINATION WITH ANTI-PD-L1 ANTIBODIES
<b>A61K 39/00</b> (2006.01)	3768712	ANTI-CD137 ANTIBODIES FOR COMBINATION WITH ANTI-PD-1 ANTIBODIES
<b>A61P 35/00</b> (2006.01)	3768712	ANTI-CD137 ANTIBODIES FOR COMBINATION WITH ANTI-PD-1 ANTIBODIES
<b>C07K 16/28</b> (2006.01)	3768712	ANTI-CD137 ANTIBODIES FOR COMBINATION WITH ANTI-PD-1 ANTIBODIES
<b>C12M 1/34</b> (2006.01)	3765846	METHODS FOR IMPROVING CELL VIABILITY IN A PRODUCTION BIOREACTOR
<b>G01N 33/50</b> (2006.01)	3765846	METHODS FOR IMPROVING CELL VIABILITY IN A PRODUCTION BIOREACTOR
<b>A61K 35/744</b> (2015.01)	3768284	COMPOSITIONS
<b>A61K 38/16</b> (2006.01)	3768284	COMPOSITIONS
<b>A61K 48/00</b> (2006.01)	3768284	COMPOSITIONS
<b>A61P 35/00</b> (2006.01)	3768284	COMPOSITIONS
<b>A61P 37/04</b> (2006.01)	3768284	COMPOSITIONS
<b>C07K 14/315</b> (2006.01)	3768284	COMPOSITIONS
<b>B01J 23/02</b> (2006.01)	3768419	METHOD FOR TRANSESTERIFICATION OF CARBOXYLIC ACID ESTERS
<b>B01J 35/02</b> (2006.01)	3768419	METHOD FOR TRANSESTERIFICATION OF CARBOXYLIC ACID ESTERS
<b>B01J 35/10</b> (2006.01)	3768419	METHOD FOR TRANSESTERIFICATION OF CARBOXYLIC ACID ESTERS
<b>B01J 37/08</b> (2006.01)	3768419	METHOD FOR TRANSESTERIFICATION OF CARBOXYLIC ACID ESTERS
<b>C01F 1/00</b> (2006.01)	3768419	METHOD FOR TRANSESTERIFICATION OF CARBOXYLIC ACID ESTERS
<b>C01F 11/06</b> (2006.01)	3768419	METHOD FOR TRANSESTERIFICATION OF CARBOXYLIC ACID ESTERS
<b>C01F 11/18</b> (2006.01)	3768419	METHOD FOR TRANSESTERIFICATION OF CARBOXYLIC ACID ESTERS
<b>C07C 67/03</b> (2006.01)	3768419	METHOD FOR TRANSESTERIFICATION OF CARBOXYLIC ACID ESTERS
<b>C10L 1/02</b> (2006.01)	3768419	METHOD FOR TRANSESTERIFICATION OF CARBOXYLIC ACID ESTERS
<b>C10L 3/00</b> (2006.01)	3768419	METHOD FOR TRANSESTERIFICATION OF CARBOXYLIC ACID ESTERS
<b>C10L 3/10</b> (2006.01)	3768419	METHOD FOR TRANSESTERIFICATION OF CARBOXYLIC ACID ESTERS
<b>A23L 33/135</b> (2016.01)	3768285	COMPOSITIONS COMPRISING BACTERIAL STRAINS
<b>A61K 35/744</b> (2015.01)	3768285	COMPOSITIONS COMPRISING BACTERIAL STRAINS
<b>A61K 38/16</b> (2006.01)	3768285	COMPOSITIONS COMPRISING BACTERIAL STRAINS
<b>A61P 37/04</b> (2006.01)	3768285	COMPOSITIONS COMPRISING BACTERIAL STRAINS

MKP (51)	Broj objave evropske prijava patenta (97)	Naziv pronalaska (54)
<b>A61K 6/00</b> (2020.01)	3768224	ANTISEPTIC AND/OR ANTI-INFLAMMATORY GEL FOR TREATMENT OF ORAL CAVITY DISEASES COMPRISING POLYVINYL ALCOHOL AND POLYACIDS
<b>A61K 8/04</b> (2006.01)	3768224	ANTISEPTIC AND/OR ANTI-INFLAMMATORY GEL FOR TREATMENT OF ORAL CAVITY DISEASES COMPRISING POLYVINYL ALCOHOL AND POLYACIDS
<b>A61K 8/19</b> (2006.01)	3768224	ANTISEPTIC AND/OR ANTI-INFLAMMATORY GEL FOR TREATMENT OF ORAL CAVITY DISEASES COMPRISING POLYVINYL ALCOHOL AND POLYACIDS
<b>A61K 8/20</b> (2006.01)	3768224	ANTISEPTIC AND/OR ANTI-INFLAMMATORY GEL FOR TREATMENT OF ORAL CAVITY DISEASES COMPRISING POLYVINYL ALCOHOL AND POLYACIDS
<b>A61K 8/22</b> (2006.01)	3768224	ANTISEPTIC AND/OR ANTI-INFLAMMATORY GEL FOR TREATMENT OF ORAL CAVITY DISEASES COMPRISING POLYVINYL ALCOHOL AND POLYACIDS
<b>A61K 8/37</b> (2006.01)	3768224	ANTISEPTIC AND/OR ANTI-INFLAMMATORY GEL FOR TREATMENT OF ORAL CAVITY DISEASES COMPRISING POLYVINYL ALCOHOL AND POLYACIDS
<b>A61K 8/43</b> (2006.01)	3768224	ANTISEPTIC AND/OR ANTI-INFLAMMATORY GEL FOR TREATMENT OF ORAL CAVITY DISEASES COMPRISING POLYVINYL ALCOHOL AND POLYACIDS
<b>A61K 8/73</b> (2006.01)	3768224	ANTISEPTIC AND/OR ANTI-INFLAMMATORY GEL FOR TREATMENT OF ORAL CAVITY DISEASES COMPRISING POLYVINYL ALCOHOL AND POLYACIDS
<b>A61K 8/81</b> (2006.01)	3768224	ANTISEPTIC AND/OR ANTI-INFLAMMATORY GEL FOR TREATMENT OF ORAL CAVITY DISEASES COMPRISING POLYVINYL ALCOHOL AND POLYACIDS
<b>A61K 31/155</b> (2006.01)	3768224	ANTISEPTIC AND/OR ANTI-INFLAMMATORY GEL FOR TREATMENT OF ORAL CAVITY DISEASES COMPRISING POLYVINYL ALCOHOL AND POLYACIDS
<b>A61K 31/192</b> (2006.01)	3768224	ANTISEPTIC AND/OR ANTI-INFLAMMATORY GEL FOR TREATMENT OF ORAL CAVITY DISEASES COMPRISING POLYVINYL ALCOHOL AND POLYACIDS
<b>A61K 31/616</b> (2006.01)	3768224	ANTISEPTIC AND/OR ANTI-INFLAMMATORY GEL FOR TREATMENT OF ORAL CAVITY DISEASES COMPRISING POLYVINYL ALCOHOL AND POLYACIDS
<b>A61P 1/02</b> (2006.01)	3768224	ANTISEPTIC AND/OR ANTI-INFLAMMATORY GEL FOR TREATMENT OF ORAL CAVITY DISEASES COMPRISING POLYVINYL ALCOHOL AND POLYACIDS
<b>A61Q 11/00</b> (2006.01)	3768224	ANTISEPTIC AND/OR ANTI-INFLAMMATORY GEL FOR TREATMENT OF ORAL CAVITY DISEASES COMPRISING POLYVINYL ALCOHOL AND POLYACIDS
<b>A61Q 11/02</b> (2006.01)	3768224	ANTISEPTIC AND/OR ANTI-INFLAMMATORY GEL FOR TREATMENT OF ORAL CAVITY DISEASES COMPRISING POLYVINYL ALCOHOL AND POLYACIDS
<b>A61K 31/553</b> (2006.01)	3762393	ALPHA-HYDROXY PHENYLACETIC ACID PHARMACOPHORE OR BIOISOSTERE MCL-1 PROTEIN ANTAGONISTS
<b>A61P 35/00</b> (2006.01)	3762393	ALPHA-HYDROXY PHENYLACETIC ACID PHARMACOPHORE OR BIOISOSTERE MCL-1 PROTEIN ANTAGONISTS
<b>C07D 498/10</b> (2006.01)	3762393	ALPHA-HYDROXY PHENYLACETIC ACID PHARMACOPHORE OR BIOISOSTERE MCL-1 PROTEIN ANTAGONISTS
<b>C07D 498/20</b> (2006.01)	3762393	ALPHA-HYDROXY PHENYLACETIC ACID PHARMACOPHORE OR BIOISOSTERE MCL-1 PROTEIN ANTAGONISTS
<b>C07D 498/22</b> (2006.01)	3762393	ALPHA-HYDROXY PHENYLACETIC ACID PHARMACOPHORE OR BIOISOSTERE MCL-1 PROTEIN ANTAGONISTS
<b>A61K 31/519</b> (2006.01)	3761987	COMPOUNDS FOR TREATING ALZHEIMER'S DISEASE
<b>A61K 31/7068</b> (2006.01)	3761987	COMPOUNDS FOR TREATING ALZHEIMER'S DISEASE
<b>A61K 45/06</b> (2006.01)	3761987	COMPOUNDS FOR TREATING ALZHEIMER'S DISEASE
<b>A61P 25/28</b> (2006.01)	3761987	COMPOUNDS FOR TREATING ALZHEIMER'S DISEASE
<b>B02C 17/16</b> (2006.01)	3781321	HYBRID DISC
<b>A61K 31/4468</b> (2006.01)	3768265	NEW CENTRALLY-ACTIVE GHRELIN AGONIST AND MEDICAL USES THEREOF
<b>A61P 9/00</b> (2006.01)	3768265	NEW CENTRALLY-ACTIVE GHRELIN AGONIST AND MEDICAL USES THEREOF
<b>A61P 25/00</b> (2006.01)	3768265	NEW CENTRALLY-ACTIVE GHRELIN AGONIST AND MEDICAL USES THEREOF
<b>A61P 25/02</b> (2006.01)	3768265	NEW CENTRALLY-ACTIVE GHRELIN AGONIST AND MEDICAL USES THEREOF

MKP	Broj objave evropske prijave patenta (97)	Naziv pronalaska (54)
(51)		(54)
<b>A61P 25/04</b> (2006.01)	3768265	NEW CENTRALLY-ACTIVE GHRELIN AGONIST AND MEDICAL USES THEREOF
<b>A61P 25/16</b> (2006.01)	3768265	NEW CENTRALLY-ACTIVE GHRELIN AGONIST AND MEDICAL USES THEREOF
<b>A61P 25/28</b> (2006.01)	3768265	NEW CENTRALLY-ACTIVE GHRELIN AGONIST AND MEDICAL USES THEREOF
<b>A61K 31/395</b> (2006.01)	3765447	TRIAZACYCLODODECANSULFONAMIDE ("TCD")-BASED PROTEIN SECRETION INHIBITORS
<b>A61K 31/675</b> (2006.01)	3765447	TRIAZACYCLODODECANSULFONAMIDE ("TCD")-BASED PROTEIN SECRETION INHIBITORS
<b>C07D 255/02</b> (2006.01)	3765447	TRIAZACYCLODODECANSULFONAMIDE ("TCD")-BASED PROTEIN SECRETION INHIBITORS
<b>A61K 39/395</b> (2006.01)	3768311	TREATMENT AND PROPHYLAXIS OF AMYLOIDOSIS
<b>A61P 43/00</b> (2006.01)	3768311	TREATMENT AND PROPHYLAXIS OF AMYLOIDOSIS
<b>C07K 16/18</b> (2006.01)	3768311	TREATMENT AND PROPHYLAXIS OF AMYLOIDOSIS
<b>C07K 16/28</b> (2006.01)	3768311	TREATMENT AND PROPHYLAXIS OF AMYLOIDOSIS
<b>A61P 35/00</b> (2006.01)	3768715	ANTIBODIES AGAINST MICA AND/OR MICB AND USES THEREOF
<b>C07K 16/28</b> (2006.01)	3768715	ANTIBODIES AGAINST MICA AND/OR MICB AND USES THEREOF
<b>A47B 7/00</b> (2006.01)	3761830	FURNISHING COMPONENT AND PRODUCTION METHOD
<b>A47B 13/02</b> (2006.01)	3761830	FURNISHING COMPONENT AND PRODUCTION METHOD
<b>A61K 39/00</b> (2006.01)	3765069	PEPTIDE VACCINES AGAINST INTERLEUKIN-31
<b>A61K 39/385</b> (2006.01)	3765069	PEPTIDE VACCINES AGAINST INTERLEUKIN-31
<b>G01N 33/68</b> (2006.01)	3765069	PEPTIDE VACCINES AGAINST INTERLEUKIN-31
<b>C12Q 1/06</b> (2006.01)	3768850	METHODS FOR MEASURING BACTERIA IN BIOLOGICAL SAMPLES
<b>C12Q 1/24</b> (2006.01)	3768850	METHODS FOR MEASURING BACTERIA IN BIOLOGICAL SAMPLES
<b>A61K 31/165</b> (2006.01)	3768660	MODULATORS OF EUKARYOTIC INITIATION FACTOR 2
<b>A61K 31/397</b> (2006.01)	3768660	MODULATORS OF EUKARYOTIC INITIATION FACTOR 2
<b>A61K 31/438</b> (2006.01)	3768660	MODULATORS OF EUKARYOTIC INITIATION FACTOR 2
<b>A61P 25/00</b> (2006.01)	3768660	MODULATORS OF EUKARYOTIC INITIATION FACTOR 2
<b>A61P 35/00</b> (2006.01)	3768660	MODULATORS OF EUKARYOTIC INITIATION FACTOR 2
<b>C07D 205/12</b> (2006.01)	3768660	MODULATORS OF EUKARYOTIC INITIATION FACTOR 2
<b>C07D 207/09</b> (2006.01)	3768660	MODULATORS OF EUKARYOTIC INITIATION FACTOR 2
<b>C07D 209/52</b> (2006.01)	3768660	MODULATORS OF EUKARYOTIC INITIATION FACTOR 2
<b>C07D 211/58</b> (2006.01)	3768660	MODULATORS OF EUKARYOTIC INITIATION FACTOR 2
<b>C07D 211/74</b> (2006.01)	3768660	MODULATORS OF EUKARYOTIC INITIATION FACTOR 2
<b>C07D 215/12</b> (2006.01)	3768660	MODULATORS OF EUKARYOTIC INITIATION FACTOR 2
<b>C07D 221/20</b> (2006.01)	3768660	MODULATORS OF EUKARYOTIC INITIATION FACTOR 2
<b>C07D 233/32</b> (2006.01)	3768660	MODULATORS OF EUKARYOTIC INITIATION FACTOR 2
<b>C07D 271/10</b> (2006.01)	3768660	MODULATORS OF EUKARYOTIC INITIATION FACTOR 2
<b>C07D 277/68</b> (2006.01)	3768660	MODULATORS OF EUKARYOTIC INITIATION FACTOR 2
<b>C07D 311/66</b> (2006.01)	3768660	MODULATORS OF EUKARYOTIC INITIATION FACTOR 2
<b>C07D 401/04</b> (2006.01)	3768660	MODULATORS OF EUKARYOTIC INITIATION FACTOR 2
<b>C07D 401/12</b> (2006.01)	3768660	MODULATORS OF EUKARYOTIC INITIATION FACTOR 2
<b>C07D 403/04</b> (2006.01)	3768660	MODULATORS OF EUKARYOTIC INITIATION FACTOR 2
<b>C07D 413/04</b> (2006.01)	3768660	MODULATORS OF EUKARYOTIC INITIATION FACTOR 2
<b>A61P 35/00</b> (2006.01)	3765474	CYCLOPENTANE-BASED MODULATORS OF STING (STIMULATOR OF INTERFERON GENES)
<b>C07H 19/213</b> (2006.01)	3765474	CYCLOPENTANE-BASED MODULATORS OF STING (STIMULATOR OF INTERFERON GENES)
<b>G01N 33/68</b> (2006.01)	3765856	METHODS FOR THE PREPARATION OF TRYPSIN-RESISTANT POLYPEPTIDES FOR MASS SPECTROMETRIC ANALYSIS
<b>C01D 15/02</b> (2006.01)	3793943	METHOD FOR RECOVERING LITHIUM HYDROXIDE
<b>C01D 15/08</b> (2006.01)	3793943	METHOD FOR RECOVERING LITHIUM HYDROXIDE
<b>C22B 26/12</b> (2006.01)	3793943	METHOD FOR RECOVERING LITHIUM HYDROXIDE
<b>B63B 22/00</b> (2006.01)	3762288	FLOATING PLATFORM FOR MARITIME SURVEILLANCE
<b>B63B 35/00</b> (2020.01)	3762288	FLOATING PLATFORM FOR MARITIME SURVEILLANCE
<b>B63B 35/44</b> (2006.01)	3762288	FLOATING PLATFORM FOR MARITIME SURVEILLANCE
<b>G01S 7/00</b> (2006.01)	3762288	FLOATING PLATFORM FOR MARITIME SURVEILLANCE
<b>A61K 39/00</b> (2006.01)	3793592	PEPTIDES FOR USE IN IMMUNOTHERAPY AGAINST CANCERS
<b>C07K 14/47</b> (2006.01)	3793592	PEPTIDES FOR USE IN IMMUNOTHERAPY AGAINST CANCERS
<b>C07K 14/74</b> (2006.01)	3793592	PEPTIDES FOR USE IN IMMUNOTHERAPY AGAINST CANCERS
<b>G01N 33/68</b> (2006.01)	3765857	SEQUENTIAL DIGESTION OF POLYPEPTIDES FOR MASS SPECTROMETRIC ANALYSIS
<b>A61K 39/395</b> (2006.01)	3768716	ANTIBODIES BINDING TO VISTA AT ACIDIC PH
<b>C07K 16/28</b> (2006.01)	3768716	ANTIBODIES BINDING TO VISTA AT ACIDIC PH
<b>A61K 9/00</b> (2006.01)	3784209	METHOD FOR MAKING INJECTABLE PHARMACEUTICAL COMPOSITIONS

MKP (51)	Broj objave evropske prijava patenta (97)	Naziv pronalaska (54)
<b>A61P 7/06</b> (2006.01)	3784209	METHOD FOR MAKING INJECTABLE PHARMACEUTICAL COMPOSITIONS
<b>A61P 37/04</b> (2006.01)	3784209	METHOD FOR MAKING INJECTABLE PHARMACEUTICAL COMPOSITIONS
<b>A61P 37/06</b> (2006.01)	3784209	METHOD FOR MAKING INJECTABLE PHARMACEUTICAL COMPOSITIONS
<b>G01N 15/02</b> (2006.01)	3784209	METHOD FOR MAKING INJECTABLE PHARMACEUTICAL COMPOSITIONS
<b>G01N 15/10</b> (2006.01)	3784209	METHOD FOR MAKING INJECTABLE PHARMACEUTICAL COMPOSITIONS
<b>C09C 1/02</b> (2006.01)	3784736	USE OF ADDITIVES CONTAINING PRIMARY ALKANOLAMINES IN AQUEOUS MINERAL SUSPENSIONS
<b>D21H 17/67</b> (2006.01)	3784736	USE OF ADDITIVES CONTAINING PRIMARY ALKANOLAMINES IN AQUEOUS MINERAL SUSPENSIONS
<b>A61K 31/437</b> (2006.01)	3784667	HETEROAROMATIC COMPOUNDS HAVING ACTIVITY AGAINST RSV
<b>A61P 31/16</b> (2006.01)	3784667	HETEROAROMATIC COMPOUNDS HAVING ACTIVITY AGAINST RSV
<b>C07D 471/04</b> (2006.01)	3784667	HETEROAROMATIC COMPOUNDS HAVING ACTIVITY AGAINST RSV
<b>H04L 12/28</b> (2006.01)	3769473	MULTI USER DSL METHOD AND SYSTEM FOR THE STATISTICAL MULTIPLEXING OF COPPER LINES
<b>A61F 5/058</b> (2006.01)	3781219	A KIT FOR IN SITU IMMOBILIZATION WITH ANTIFUNGAL AND ANTIMICROBIAL EFFECTS
<b>A61L 15/08</b> (2006.01)	3781219	A KIT FOR IN SITU IMMOBILIZATION WITH ANTIFUNGAL AND ANTIMICROBIAL EFFECTS
<b>A61L 15/12</b> (2006.01)	3781219	A KIT FOR IN SITU IMMOBILIZATION WITH ANTIFUNGAL AND ANTIMICROBIAL EFFECTS
<b>A61L 15/14</b> (2006.01)	3781219	A KIT FOR IN SITU IMMOBILIZATION WITH ANTIFUNGAL AND ANTIMICROBIAL EFFECTS
<b>A01H 1/04</b> (2006.01)	3784030	PLANTS WITH IMPROVED DIGESTIBILITY AND MARKER HAPLOTYPES
<b>C12N 9/14</b> (2006.01)	3784030	PLANTS WITH IMPROVED DIGESTIBILITY AND MARKER HAPLOTYPES
<b>C12N 15/82</b> (2006.01)	3784030	PLANTS WITH IMPROVED DIGESTIBILITY AND MARKER HAPLOTYPES
<b>C12Q 1/68</b> (2018.01)	3784030	PLANTS WITH IMPROVED DIGESTIBILITY AND MARKER HAPLOTYPES
<b>G10L 19/02</b> (2013.01)	3785260	INTEGRATION OF HIGH FREQUENCY AUDIO RECONSTRUCTION TECHNIQUES
<b>G10L 19/24</b> (2013.01)	3785260	INTEGRATION OF HIGH FREQUENCY AUDIO RECONSTRUCTION TECHNIQUES
<b>G10L 21/0388</b> (2013.01)	3785260	INTEGRATION OF HIGH FREQUENCY AUDIO RECONSTRUCTION TECHNIQUES
<b>A61K 38/18</b> (2006.01)	3784691	PRODUCTION OF NERVE GROWTH FACTOR (NGF) AND OF MUTEINS THEREOF
<b>C07K 14/48</b> (2006.01)	3784691	PRODUCTION OF NERVE GROWTH FACTOR (NGF) AND OF MUTEINS THEREOF
<b>A61P 25/16</b> (2006.01)	3781560	PYRAZO-TETRAHYDROISOQUINOLINE DERIVATIVES AS DOPAMINE D1 RECEPTOR POSITIVE MODULATORS
<b>A61P 25/28</b> (2006.01)	3781560	PYRAZO-TETRAHYDROISOQUINOLINE DERIVATIVES AS DOPAMINE D1 RECEPTOR POSITIVE MODULATORS
<b>C07D 401/04</b> (2006.01)	3781560	PYRAZO-TETRAHYDROISOQUINOLINE DERIVATIVES AS DOPAMINE D1 RECEPTOR POSITIVE MODULATORS
<b>C07D 405/14</b> (2006.01)	3781560	PYRAZO-TETRAHYDROISOQUINOLINE DERIVATIVES AS DOPAMINE D1 RECEPTOR POSITIVE MODULATORS
<b>A61K 9/00</b> (2006.01)	3784212	A THERAPEUTIC COMBINATION COMPRISING A PULMONARY SURFACTANT AND A STEROID FOR THE PROPHYLAXIS OF BPD
<b>A61P 11/06</b> (2006.01)	3784212	A THERAPEUTIC COMBINATION COMPRISING A PULMONARY SURFACTANT AND A STEROID FOR THE PROPHYLAXIS OF BPD
<b>A61M 5/315</b> (2006.01)	3765131	DOSE CONTROL DEVICE FOR INJECTABLE-DRUG DELIVERY DEVICES
<b>B65D 81/38</b> (2006.01)	3765381	THERMAL CONTAINER
<b>A61K 31/454</b> (2006.01)	3790873	1H-INDAZOLE-3-CARBOXAMIDE COMPOUNDS AS GLYCOGEN SYNTHASE KINASE 3 BETA INHIBITORS
<b>A61K 31/4545</b> (2006.01)	3790873	1H-INDAZOLE-3-CARBOXAMIDE COMPOUNDS AS GLYCOGEN SYNTHASE KINASE 3 BETA INHIBITORS

MKP	Broj objave evropske prijave patenta (97)	Naziv pronalaska (54)
(51)		(54)
<b>A61P 3/00</b> (2006.01)	3790873	1H-INDAZOLE-3-CARBOXAMIDE COMPOUNDS AS GLYCOGEN SYNTHASE KINASE 3 BETA INHIBITORS
<b>A61P 25/00</b> (2006.01)	3790873	1H-INDAZOLE-3-CARBOXAMIDE COMPOUNDS AS GLYCOGEN SYNTHASE KINASE 3 BETA INHIBITORS
<b>A61P 29/00</b> (2006.01)	3790873	1H-INDAZOLE-3-CARBOXAMIDE COMPOUNDS AS GLYCOGEN SYNTHASE KINASE 3 BETA INHIBITORS
<b>A61P 35/00</b> (2006.01)	3790873	1H-INDAZOLE-3-CARBOXAMIDE COMPOUNDS AS GLYCOGEN SYNTHASE KINASE 3 BETA INHIBITORS
<b>C07D 405/12</b> (2006.01)	3790873	1H-INDAZOLE-3-CARBOXAMIDE COMPOUNDS AS GLYCOGEN SYNTHASE KINASE 3 BETA INHIBITORS
<b>C07D 405/14</b> (2006.01)	3790873	1H-INDAZOLE-3-CARBOXAMIDE COMPOUNDS AS GLYCOGEN SYNTHASE KINASE 3 BETA INHIBITORS
<b>C07D 409/12</b> (2006.01)	3790873	1H-INDAZOLE-3-CARBOXAMIDE COMPOUNDS AS GLYCOGEN SYNTHASE KINASE 3 BETA INHIBITORS
<b>C07D 409/14</b> (2006.01)	3790873	1H-INDAZOLE-3-CARBOXAMIDE COMPOUNDS AS GLYCOGEN SYNTHASE KINASE 3 BETA INHIBITORS
<b>C12N 5/079</b> (2010.01)	3781674	INDUCTION OF MYELINATING OLIGODENDROCYTES IN HUMAN CORTICAL SPHEROIDS
<b>A61K 9/28</b> (2006.01)	3787605	STABLE PHARMACEUTICAL FORMULATION
<b>A61K 9/50</b> (2006.01)	3787605	STABLE PHARMACEUTICAL FORMULATION
<b>A61K 31/00</b> (2006.01)	3787605	STABLE PHARMACEUTICAL FORMULATION
<b>A61P 35/00</b> (2006.01)	3781265	ANTI-CD27 AND ANTI-PD-L1 ANTIBODIES AND BISPECIFIC CONSTRUCTS
<b>C07K 16/28</b> (2006.01)	3781265	ANTI-CD27 AND ANTI-PD-L1 ANTIBODIES AND BISPECIFIC CONSTRUCTS
<b>A61K 31/44</b> (2006.01)	3781561	MODULATORS OF METHYL MODIFYING ENZYMES, COMPOSITIONS AND USES THEREOF
<b>A61P 35/00</b> (2006.01)	3781561	MODULATORS OF METHYL MODIFYING ENZYMES, COMPOSITIONS AND USES THEREOF
<b>C07D 405/12</b> (2006.01)	3781561	MODULATORS OF METHYL MODIFYING ENZYMES, COMPOSITIONS AND USES THEREOF
<b>C07D 405/14</b> (2006.01)	3781561	MODULATORS OF METHYL MODIFYING ENZYMES, COMPOSITIONS AND USES THEREOF
<b>C07K 14/195</b> (2006.01)	3781692	PESTICIDAL PROTEINS AND METHODS OF USE
<b>C07K 14/325</b> (2006.01)	3781692	PESTICIDAL PROTEINS AND METHODS OF USE
<b>C12N 15/82</b> (2006.01)	3781692	PESTICIDAL PROTEINS AND METHODS OF USE
<b>A61K 38/17</b> (2006.01)	3781596	IL-15/IL-15RA HETERODIMERIC FC FUSION PROTEINS AND USES THEREOF
<b>A61K 38/20</b> (2006.01)	3781596	IL-15/IL-15RA HETERODIMERIC FC FUSION PROTEINS AND USES THEREOF
<b>A61P 35/00</b> (2006.01)	3781596	IL-15/IL-15RA HETERODIMERIC FC FUSION PROTEINS AND USES THEREOF
<b>C07K 14/54</b> (2006.01)	3781596	IL-15/IL-15RA HETERODIMERIC FC FUSION PROTEINS AND USES THEREOF
<b>C07K 14/715</b> (2006.01)	3781596	IL-15/IL-15RA HETERODIMERIC FC FUSION PROTEINS AND USES THEREOF
<b>C07K 16/28</b> (2006.01)	3781596	IL-15/IL-15RA HETERODIMERIC FC FUSION PROTEINS AND USES THEREOF
<b>A61K 35/17</b> (2015.01)	3784254	CLOSED PROCESS FOR EXPANSION AND GENE EDITING OF TUMOR INFILTRATING LYMPHOCYTES AND USES OF SAME IN IMMUNOTHERAPY
<b>C12N 5/09</b> (2010.01)	3784254	CLOSED PROCESS FOR EXPANSION AND GENE EDITING OF TUMOR INFILTRATING LYMPHOCYTES AND USES OF SAME IN IMMUNOTHERAPY
<b>C12N 15/90</b> (2006.01)	3784254	CLOSED PROCESS FOR EXPANSION AND GENE EDITING OF TUMOR INFILTRATING LYMPHOCYTES AND USES OF SAME IN IMMUNOTHERAPY
<b>A61K 38/46</b> (2006.01)	3784272	ANTI-BCMA CAR-T-CELLS FOR PLASMA CELL DEPLETION
<b>A61K 39/00</b> (2006.01)	3784272	ANTI-BCMA CAR-T-CELLS FOR PLASMA CELL DEPLETION
<b>A61K 48/00</b> (2006.01)	3784272	ANTI-BCMA CAR-T-CELLS FOR PLASMA CELL DEPLETION
<b>A61P 35/00</b> (2006.01)	3784272	ANTI-BCMA CAR-T-CELLS FOR PLASMA CELL DEPLETION
<b>C07K 14/725</b> (2006.01)	3784272	ANTI-BCMA CAR-T-CELLS FOR PLASMA CELL DEPLETION
<b>C07K 16/28</b> (2006.01)	3784272	ANTI-BCMA CAR-T-CELLS FOR PLASMA CELL DEPLETION
<b>C12N 5/0783</b> (2010.01)	3784272	ANTI-BCMA CAR-T-CELLS FOR PLASMA CELL DEPLETION
<b>C12N 9/22</b> (2006.01)	3784272	ANTI-BCMA CAR-T-CELLS FOR PLASMA CELL DEPLETION
<b>C12N 15/90</b> (2006.01)	3784272	ANTI-BCMA CAR-T-CELLS FOR PLASMA CELL DEPLETION
<b>A61K 31/438</b> (2006.01)	3788043	SPIROPIPERIDINE ALLOSTERIC MODULATORS OF NICOTINIC ACETYLCHOLINE RECEPTORS

MKP	Broj objave evropske prijave patenta	Naziv pronalaska
(51)	(97)	(54)
<b>A61K 31/439</b> (2006.01)	3788043	SPIROPIPERIDINE ALLOSTERIC MODULATORS OF NICOTINIC ACETYLCHOLINE RECEPTORS
<b>A61K 31/444</b> (2006.01)	3788043	SPIROPIPERIDINE ALLOSTERIC MODULATORS OF NICOTINIC ACETYLCHOLINE RECEPTORS
<b>A61K 31/501</b> (2006.01)	3788043	SPIROPIPERIDINE ALLOSTERIC MODULATORS OF NICOTINIC ACETYLCHOLINE RECEPTORS
<b>A61K 31/506</b> (2006.01)	3788043	SPIROPIPERIDINE ALLOSTERIC MODULATORS OF NICOTINIC ACETYLCHOLINE RECEPTORS
<b>A61P 25/00</b> (2006.01)	3788043	SPIROPIPERIDINE ALLOSTERIC MODULATORS OF NICOTINIC ACETYLCHOLINE RECEPTORS
<b>C07D 401/04</b> (2006.01)	3788043	SPIROPIPERIDINE ALLOSTERIC MODULATORS OF NICOTINIC ACETYLCHOLINE RECEPTORS
<b>C07D 413/04</b> (2006.01)	3788043	SPIROPIPERIDINE ALLOSTERIC MODULATORS OF NICOTINIC ACETYLCHOLINE RECEPTORS
<b>C07D 413/14</b> (2006.01)	3788043	SPIROPIPERIDINE ALLOSTERIC MODULATORS OF NICOTINIC ACETYLCHOLINE RECEPTORS
<b>C07D 417/04</b> (2006.01)	3788043	SPIROPIPERIDINE ALLOSTERIC MODULATORS OF NICOTINIC ACETYLCHOLINE RECEPTORS
<b>C07D 417/14</b> (2006.01)	3788043	SPIROPIPERIDINE ALLOSTERIC MODULATORS OF NICOTINIC ACETYLCHOLINE RECEPTORS
<b>C07D 471/04</b> (2006.01)	3788043	SPIROPIPERIDINE ALLOSTERIC MODULATORS OF NICOTINIC ACETYLCHOLINE RECEPTORS
<b>C07D 471/08</b> (2006.01)	3788043	SPIROPIPERIDINE ALLOSTERIC MODULATORS OF NICOTINIC ACETYLCHOLINE RECEPTORS
<b>C07D 487/04</b> (2006.01)	3788043	SPIROPIPERIDINE ALLOSTERIC MODULATORS OF NICOTINIC ACETYLCHOLINE RECEPTORS
<b>C07D 513/04</b> (2006.01)	3788043	SPIROPIPERIDINE ALLOSTERIC MODULATORS OF NICOTINIC ACETYLCHOLINE RECEPTORS
<b>A61K 9/00</b> (2006.01)	3781126	A PHARMACEUTICAL DRY POWDER COMPOSITION FOR INHALATION COMPRISING A THYROID HORMONE
<b>A61K 9/14</b> (2006.01)	3781126	A PHARMACEUTICAL DRY POWDER COMPOSITION FOR INHALATION COMPRISING A THYROID HORMONE
<b>A61K 31/198</b> (2006.01)	3781126	A PHARMACEUTICAL DRY POWDER COMPOSITION FOR INHALATION COMPRISING A THYROID HORMONE
<b>A61K 47/26</b> (2006.01)	3781126	A PHARMACEUTICAL DRY POWDER COMPOSITION FOR INHALATION COMPRISING A THYROID HORMONE
<b>A61K 31/55</b> (2006.01)	3781170	COMPOUNDS AND THEIR USES FOR ALLEVIATING MENOPAUSE-ASSOCIATED SYMPTOMS
<b>A61K 31/565</b> (2006.01)	3781170	COMPOUNDS AND THEIR USES FOR ALLEVIATING MENOPAUSE-ASSOCIATED SYMPTOMS
<b>A61K 31/57</b> (2006.01)	3781170	COMPOUNDS AND THEIR USES FOR ALLEVIATING MENOPAUSE-ASSOCIATED SYMPTOMS
<b>A61K 31/585</b> (2006.01)	3781170	COMPOUNDS AND THEIR USES FOR ALLEVIATING MENOPAUSE-ASSOCIATED SYMPTOMS
<b>A61P 5/30</b> (2006.01)	3781170	COMPOUNDS AND THEIR USES FOR ALLEVIATING MENOPAUSE-ASSOCIATED SYMPTOMS
<b>A61K 31/55</b> (2006.01)	3781171	COMPOUNDS AND THEIR USES FOR ALLEVIATING MENOPAUSE-ASSOCIATED SYMPTOMS
<b>A61K 31/565</b> (2006.01)	3781171	COMPOUNDS AND THEIR USES FOR ALLEVIATING MENOPAUSE-ASSOCIATED SYMPTOMS
<b>A61K 31/57</b> (2006.01)	3781171	COMPOUNDS AND THEIR USES FOR ALLEVIATING MENOPAUSE-ASSOCIATED SYMPTOMS
<b>A61K 31/585</b> (2006.01)	3781171	COMPOUNDS AND THEIR USES FOR ALLEVIATING MENOPAUSE-ASSOCIATED SYMPTOMS
<b>A61P 5/30</b> (2006.01)	3781171	COMPOUNDS AND THEIR USES FOR ALLEVIATING MENOPAUSE-ASSOCIATED SYMPTOMS
<b>H01L 31/0224</b> (2006.01)	3790060	PHOTOVOLTAIC CELL ARRAY AND PHOTOVOLTAIC ASSEMBLY
<b>H01L 31/042</b> (2014.01)	3790060	PHOTOVOLTAIC CELL ARRAY AND PHOTOVOLTAIC ASSEMBLY
<b>H01L 31/05</b> (2014.01)	3790060	PHOTOVOLTAIC CELL ARRAY AND PHOTOVOLTAIC ASSEMBLY
<b>H01L 31/068</b> (2012.01)	3790060	PHOTOVOLTAIC CELL ARRAY AND PHOTOVOLTAIC ASSEMBLY
<b>A61M 5/168</b> (2006.01)	3695864	PALM ACTIVATED DRUG DELIVERY DEVICE
<b>A61M 5/20</b> (2006.01)	3695864	PALM ACTIVATED DRUG DELIVERY DEVICE
<b>A61M 5/315</b> (2006.01)	3695864	PALM ACTIVATED DRUG DELIVERY DEVICE
<b>A61M 5/32</b> (2006.01)	3695864	PALM ACTIVATED DRUG DELIVERY DEVICE
<b>A61M 5/42</b> (2006.01)	3695864	PALM ACTIVATED DRUG DELIVERY DEVICE
<b>A61M 5/48</b> (2006.01)	3695864	PALM ACTIVATED DRUG DELIVERY DEVICE
<b>A61M 5/50</b> (2006.01)	3695864	PALM ACTIVATED DRUG DELIVERY DEVICE
<b>A61K 39/00</b> (2006.01)	3689911	ANTIBODIES SPECIFIC FOR CLAUDIN 6 (CLDN6)



MKP (51)	Broj objave evropske prijava patenta (97)	Naziv pronalaska (54)
<b>A61K 39/395</b> (2006.01)	3689911	ANTIBODIES SPECIFIC FOR CLAUDIN 6 (CLDN6)
<b>A61P 1/04</b> (2006.01)	3689911	ANTIBODIES SPECIFIC FOR CLAUDIN 6 (CLDN6)
<b>A61P 1/16</b> (2006.01)	3689911	ANTIBODIES SPECIFIC FOR CLAUDIN 6 (CLDN6)
<b>A61P 1/18</b> (2006.01)	3689911	ANTIBODIES SPECIFIC FOR CLAUDIN 6 (CLDN6)
<b>A61P 11/00</b> (2006.01)	3689911	ANTIBODIES SPECIFIC FOR CLAUDIN 6 (CLDN6)
<b>A61P 13/10</b> (2006.01)	3689911	ANTIBODIES SPECIFIC FOR CLAUDIN 6 (CLDN6)
<b>A61P 13/12</b> (2006.01)	3689911	ANTIBODIES SPECIFIC FOR CLAUDIN 6 (CLDN6)
<b>A61P 15/00</b> (2006.01)	3689911	ANTIBODIES SPECIFIC FOR CLAUDIN 6 (CLDN6)
<b>A61P 17/00</b> (2006.01)	3689911	ANTIBODIES SPECIFIC FOR CLAUDIN 6 (CLDN6)
<b>A61P 21/00</b> (2006.01)	3689911	ANTIBODIES SPECIFIC FOR CLAUDIN 6 (CLDN6)
<b>A61P 25/00</b> (2006.01)	3689911	ANTIBODIES SPECIFIC FOR CLAUDIN 6 (CLDN6)
<b>A61P 35/00</b> (2006.01)	3689911	ANTIBODIES SPECIFIC FOR CLAUDIN 6 (CLDN6)
<b>A61P 35/04</b> (2006.01)	3689911	ANTIBODIES SPECIFIC FOR CLAUDIN 6 (CLDN6)
<b>C07K 14/705</b> (2006.01)	3689911	ANTIBODIES SPECIFIC FOR CLAUDIN 6 (CLDN6)
<b>C07K 16/28</b> (2006.01)	3689911	ANTIBODIES SPECIFIC FOR CLAUDIN 6 (CLDN6)
<b>C07K 16/30</b> (2006.01)	3689911	ANTIBODIES SPECIFIC FOR CLAUDIN 6 (CLDN6)
<b>A61P 37/06</b> (2006.01)	3693393	ANTIBODIES THAT SPECIFICALLY BIND TO TL1A
<b>C07K 16/28</b> (2006.01)	3693393	ANTIBODIES THAT SPECIFICALLY BIND TO TL1A
<b>A61K 31/506</b> (2006.01)	3698795	CERTAIN AMINO-PYRIMIDINES, COMPOSITIONS THEREOF, AND METHODS FOR THEIR USE
<b>A61K 31/519</b> (2006.01)	3698795	CERTAIN AMINO-PYRIMIDINES, COMPOSITIONS THEREOF, AND METHODS FOR THEIR USE
<b>A61P 21/00</b> (2006.01)	3698795	CERTAIN AMINO-PYRIMIDINES, COMPOSITIONS THEREOF, AND METHODS FOR THEIR USE
<b>A61P 21/04</b> (2006.01)	3698795	CERTAIN AMINO-PYRIMIDINES, COMPOSITIONS THEREOF, AND METHODS FOR THEIR USE
<b>A61P 25/02</b> (2006.01)	3698795	CERTAIN AMINO-PYRIMIDINES, COMPOSITIONS THEREOF, AND METHODS FOR THEIR USE
<b>C07D 239/42</b> (2006.01)	3698795	CERTAIN AMINO-PYRIMIDINES, COMPOSITIONS THEREOF, AND METHODS FOR THEIR USE
<b>C07D 239/48</b> (2006.01)	3698795	CERTAIN AMINO-PYRIMIDINES, COMPOSITIONS THEREOF, AND METHODS FOR THEIR USE
<b>C07D 401/04</b> (2006.01)	3698795	CERTAIN AMINO-PYRIMIDINES, COMPOSITIONS THEREOF, AND METHODS FOR THEIR USE
<b>C07D 401/12</b> (2006.01)	3698795	CERTAIN AMINO-PYRIMIDINES, COMPOSITIONS THEREOF, AND METHODS FOR THEIR USE
<b>C07D 401/14</b> (2006.01)	3698795	CERTAIN AMINO-PYRIMIDINES, COMPOSITIONS THEREOF, AND METHODS FOR THEIR USE
<b>C07D 403/04</b> (2006.01)	3698795	CERTAIN AMINO-PYRIMIDINES, COMPOSITIONS THEREOF, AND METHODS FOR THEIR USE
<b>C07D 403/10</b> (2006.01)	3698795	CERTAIN AMINO-PYRIMIDINES, COMPOSITIONS THEREOF, AND METHODS FOR THEIR USE
<b>C07D 403/14</b> (2006.01)	3698795	CERTAIN AMINO-PYRIMIDINES, COMPOSITIONS THEREOF, AND METHODS FOR THEIR USE
<b>C07D 413/14</b> (2006.01)	3698795	CERTAIN AMINO-PYRIMIDINES, COMPOSITIONS THEREOF, AND METHODS FOR THEIR USE
<b>C07D 417/14</b> (2006.01)	3698795	CERTAIN AMINO-PYRIMIDINES, COMPOSITIONS THEREOF, AND METHODS FOR THEIR USE
<b>C07D 471/04</b> (2006.01)	3698795	CERTAIN AMINO-PYRIMIDINES, COMPOSITIONS THEREOF, AND METHODS FOR THEIR USE
<b>A61K 31/202</b> (2006.01)	3692986	PHARMACEUTICAL COMPOSITIONS COMPRISING DGLA AND USE OF SAME
<b>B01J 31/02</b> (2006.01)	3680240	ASYMMETRIC PHASE TRANSFER CATALYSIS
<b>C07D 453/04</b> (2006.01)	3680240	ASYMMETRIC PHASE TRANSFER CATALYSIS
<b>C12Q 1/6886</b> (2018.01)	3693476	CANCER PATIENT SELECTION FOR ADMINISTRATION OF WNT SIGNALING INHIBITORS USING RNF43 MUTATION STATUS
<b>G01N 21/03</b> (2006.01)	3690511	MICROSCOPE FOR IMAGING WELLS COMPRISING A DISPENSER AND TEMPERATURE-CONTROLLED ENCLOSURE
<b>G01N 21/25</b> (2006.01)	3690511	MICROSCOPE FOR IMAGING WELLS COMPRISING A DISPENSER AND TEMPERATURE-CONTROLLED ENCLOSURE
<b>G01N 21/64</b> (2006.01)	3690511	MICROSCOPE FOR IMAGING WELLS COMPRISING A DISPENSER AND TEMPERATURE-CONTROLLED ENCLOSURE
<b>G01N 21/76</b> (2006.01)	3690511	MICROSCOPE FOR IMAGING WELLS COMPRISING A DISPENSER AND TEMPERATURE-CONTROLLED ENCLOSURE
<b>G02B 21/00</b> (2006.01)	3690511	MICROSCOPE FOR IMAGING WELLS COMPRISING A DISPENSER AND TEMPERATURE-CONTROLLED ENCLOSURE
<b>A61K 31/513</b> (2006.01)	3702352	PYRIMIDINEDIONE COMPOUND AGAINST CARDIAC CONDITIONS
<b>A61P 9/00</b> (2006.01)	3702352	PYRIMIDINEDIONE COMPOUND AGAINST CARDIAC CONDITIONS

MKP	Broj objave evropske prijave patenta (97)	Naziv pronalaska (54)
(51)		(54)
<b>A61P 9/04</b> (2006.01)	3702352	PYRIMIDINEDIONE COMPOUND AGAINST CARDIAC CONDITIONS
<b>A61P 9/10</b> (2006.01)	3702352	PYRIMIDINEDIONE COMPOUND AGAINST CARDIAC CONDITIONS
<b>A61P 9/12</b> (2006.01)	3702352	PYRIMIDINEDIONE COMPOUND AGAINST CARDIAC CONDITIONS
<b>C07D 239/545</b> (2006.01)	3702352	PYRIMIDINEDIONE COMPOUND AGAINST CARDIAC CONDITIONS
<b>A61K 31/4745</b> (2006.01)	3683220	8-[6-[3-(AMINO)PROPOXY]-3-PYRIDYL]-1-ISOPROPYL-IMIDAZO[4,5-C]QUINOLIN-2-ONE DERIVATIVES AS SELECTIVE MODULATORS OF ATAXIA TELANGIECTASIA MUTATED (ATM) KINASE FOR THE TREATMENT OF HUNTINGTON'S DISEASE
<b>A61P 25/28</b> (2006.01)	3683220	8-[6-[3-(AMINO)PROPOXY]-3-PYRIDYL]-1-ISOPROPYL-IMIDAZO[4,5-C]QUINOLIN-2-ONE DERIVATIVES AS SELECTIVE MODULATORS OF ATAXIA TELANGIECTASIA MUTATED (ATM) KINASE FOR THE TREATMENT OF HUNTINGTON'S DISEASE
<b>A61P 35/00</b> (2006.01)	3683220	8-[6-[3-(AMINO)PROPOXY]-3-PYRIDYL]-1-ISOPROPYL-IMIDAZO[4,5-C]QUINOLIN-2-ONE DERIVATIVES AS SELECTIVE MODULATORS OF ATAXIA TELANGIECTASIA MUTATED (ATM) KINASE FOR THE TREATMENT OF HUNTINGTON'S DISEASE
<b>C07D 471/04</b> (2006.01)	3683220	8-[6-[3-(AMINO)PROPOXY]-3-PYRIDYL]-1-ISOPROPYL-IMIDAZO[4,5-C]QUINOLIN-2-ONE DERIVATIVES AS SELECTIVE MODULATORS OF ATAXIA TELANGIECTASIA MUTATED (ATM) KINASE FOR THE TREATMENT OF HUNTINGTON'S DISEASE
<b>A61K 31/4355</b> (2006.01)	3670506	THIAZOLECARBOXAMIDES AND PYRIDINECARBOXAMIDE COMPOUNDS USEFUL AS PIM KINASE INHIBITORS
<b>A61K 31/4365</b> (2006.01)	3670506	THIAZOLECARBOXAMIDES AND PYRIDINECARBOXAMIDE COMPOUNDS USEFUL AS PIM KINASE INHIBITORS
<b>A61K 31/4427</b> (2006.01)	3670506	THIAZOLECARBOXAMIDES AND PYRIDINECARBOXAMIDE COMPOUNDS USEFUL AS PIM KINASE INHIBITORS
<b>A61K 31/4709</b> (2006.01)	3670506	THIAZOLECARBOXAMIDES AND PYRIDINECARBOXAMIDE COMPOUNDS USEFUL AS PIM KINASE INHIBITORS
<b>A61K 31/497</b> (2006.01)	3670506	THIAZOLECARBOXAMIDES AND PYRIDINECARBOXAMIDE COMPOUNDS USEFUL AS PIM KINASE INHIBITORS
<b>A61P 35/00</b> (2006.01)	3670506	THIAZOLECARBOXAMIDES AND PYRIDINECARBOXAMIDE COMPOUNDS USEFUL AS PIM KINASE INHIBITORS
<b>C07D 401/14</b> (2006.01)	3670506	THIAZOLECARBOXAMIDES AND PYRIDINECARBOXAMIDE COMPOUNDS USEFUL AS PIM KINASE INHIBITORS
<b>C07D 417/14</b> (2006.01)	3670506	THIAZOLECARBOXAMIDES AND PYRIDINECARBOXAMIDE COMPOUNDS USEFUL AS PIM KINASE INHIBITORS
<b>C07D 471/04</b> (2006.01)	3670506	THIAZOLECARBOXAMIDES AND PYRIDINECARBOXAMIDE COMPOUNDS USEFUL AS PIM KINASE INHIBITORS
<b>C07D 491/048</b> (2006.01)	3670506	THIAZOLECARBOXAMIDES AND PYRIDINECARBOXAMIDE COMPOUNDS USEFUL AS PIM KINASE INHIBITORS
<b>C07D 495/04</b> (2006.01)	3670506	THIAZOLECARBOXAMIDES AND PYRIDINECARBOXAMIDE COMPOUNDS USEFUL AS PIM KINASE INHIBITORS
<b>A61K 31/437</b> (2006.01)	3674302	1H-PYRROLO[2,3-C]PYRIDIN-7(6H)-ONES AND PYRAZOLO[3,4-C]PYRIDIN-7(6H)-ONES AS INHIBITORS OF BET PROTEINS
<b>A61P 9/10</b> (2006.01)	3674302	1H-PYRROLO[2,3-C]PYRIDIN-7(6H)-ONES AND PYRAZOLO[3,4-C]PYRIDIN-7(6H)-ONES AS INHIBITORS OF BET PROTEINS
<b>A61P 11/06</b> (2006.01)	3674302	1H-PYRROLO[2,3-C]PYRIDIN-7(6H)-ONES AND PYRAZOLO[3,4-C]PYRIDIN-7(6H)-ONES AS INHIBITORS OF BET PROTEINS
<b>A61P 25/24</b> (2006.01)	3674302	1H-PYRROLO[2,3-C]PYRIDIN-7(6H)-ONES AND PYRAZOLO[3,4-C]PYRIDIN-7(6H)-ONES AS INHIBITORS OF BET PROTEINS
<b>A61P 25/28</b> (2006.01)	3674302	1H-PYRROLO[2,3-C]PYRIDIN-7(6H)-ONES AND PYRAZOLO[3,4-C]PYRIDIN-7(6H)-ONES AS INHIBITORS OF BET PROTEINS
<b>A61P 31/00</b> (2006.01)	3674302	1H-PYRROLO[2,3-C]PYRIDIN-7(6H)-ONES AND PYRAZOLO[3,4-C]PYRIDIN-7(6H)-ONES AS INHIBITORS OF BET PROTEINS
<b>A61P 33/00</b> (2006.01)	3674302	1H-PYRROLO[2,3-C]PYRIDIN-7(6H)-ONES AND PYRAZOLO[3,4-C]PYRIDIN-7(6H)-ONES AS INHIBITORS OF BET PROTEINS
<b>A61P 35/00</b> (2006.01)	3674302	1H-PYRROLO[2,3-C]PYRIDIN-7(6H)-ONES AND PYRAZOLO[3,4-C]PYRIDIN-7(6H)-ONES AS INHIBITORS OF BET PROTEINS
<b>A61P 37/00</b> (2006.01)	3674302	1H-PYRROLO[2,3-C]PYRIDIN-7(6H)-ONES AND PYRAZOLO[3,4-C]PYRIDIN-7(6H)-ONES AS INHIBITORS OF BET PROTEINS
<b>C07D 471/04</b> (2006.01)	3674302	1H-PYRROLO[2,3-C]PYRIDIN-7(6H)-ONES AND PYRAZOLO[3,4-C]PYRIDIN-7(6H)-ONES AS INHIBITORS OF BET PROTEINS
<b>A61J 7/00</b> (2006.01)	3682915	APPARATUS AND METHODS FOR DISPENSING ORAL TRANSMUCOSAL DOSAGE FORMS
<b>A61M 1/02</b> (2006.01)	3682915	APPARATUS AND METHODS FOR DISPENSING ORAL TRANSMUCOSAL DOSAGE FORMS
<b>A61M 1/14</b> (2006.01)	3682915	APPARATUS AND METHODS FOR DISPENSING ORAL TRANSMUCOSAL DOSAGE FORMS

MKP	Broj objave evropske prijave patenta (97)	Naziv pronalaska (54)
(51)		(54)
<b>A61M 1/16</b> (2006.01)	3682915	APPARATUS AND METHODS FOR DISPENSING ORAL TRANSMUCOSAL DOSAGE FORMS
<b>A61M 1/18</b> (2006.01)	3682915	APPARATUS AND METHODS FOR DISPENSING ORAL TRANSMUCOSAL DOSAGE FORMS
<b>A61M 5/307</b> (2006.01)	3682915	APPARATUS AND METHODS FOR DISPENSING ORAL TRANSMUCOSAL DOSAGE FORMS
<b>A61M 5/315</b> (2006.01)	3682915	APPARATUS AND METHODS FOR DISPENSING ORAL TRANSMUCOSAL DOSAGE FORMS
<b>E04F 13/00</b> (2006.01)	3699371	CONNECTION PROFILE FOR COMPONENTS BORDERING PLASTER
<b>E04F 13/06</b> (2006.01)	3699371	CONNECTION PROFILE FOR COMPONENTS BORDERING PLASTER
<b>E06B 1/62</b> (2006.01)	3699371	CONNECTION PROFILE FOR COMPONENTS BORDERING PLASTER
<b>C07K 14/00</b> (2006.01)	3693383	MOUSE-HUMAN FC-GAMMA-RI PROTEINS AND ENCODING DNA
<b>C07K 14/735</b> (2006.01)	3693383	MOUSE-HUMAN FC-GAMMA-RI PROTEINS AND ENCODING DNA
<b>C12N 15/85</b> (2006.01)	3693383	MOUSE-HUMAN FC-GAMMA-RI PROTEINS AND ENCODING DNA
<b>A61K 31/437</b> (2006.01)	3686193	2-(2,4,5-SUBSTITUTED-ANILINO)PYRIMIDINE COMPOUNDS
<b>A61K 31/506</b> (2006.01)	3686193	2-(2,4,5-SUBSTITUTED-ANILINO)PYRIMIDINE COMPOUNDS
<b>A61P 35/00</b> (2006.01)	3686193	2-(2,4,5-SUBSTITUTED-ANILINO)PYRIMIDINE COMPOUNDS
<b>C07D 401/02</b> (2006.01)	3686193	2-(2,4,5-SUBSTITUTED-ANILINO)PYRIMIDINE COMPOUNDS
<b>C07D 471/04</b> (2006.01)	3686193	2-(2,4,5-SUBSTITUTED-ANILINO)PYRIMIDINE COMPOUNDS
<b>A61K 31/437</b> (2006.01)	3686194	2-(2,4,5-SUBSTITUTED-ANILINO)PYRIMIDINE COMPOUNDS
<b>A61K 31/506</b> (2006.01)	3686194	2-(2,4,5-SUBSTITUTED-ANILINO)PYRIMIDINE COMPOUNDS
<b>A61P 35/00</b> (2006.01)	3686194	2-(2,4,5-SUBSTITUTED-ANILINO)PYRIMIDINE COMPOUNDS
<b>C07D 401/02</b> (2006.01)	3686194	2-(2,4,5-SUBSTITUTED-ANILINO)PYRIMIDINE COMPOUNDS
<b>C07D 471/04</b> (2006.01)	3686194	2-(2,4,5-SUBSTITUTED-ANILINO)PYRIMIDINE COMPOUNDS
<b>A61K 31/52</b> (2006.01)	3797797	ANTIBODY CONJUGATES COMPRISING TOLL-LIKE RECEPTOR AGONIST
<b>A61K 47/68</b> (2017.01)	3797797	ANTIBODY CONJUGATES COMPRISING TOLL-LIKE RECEPTOR AGONIST
<b>A61P 35/00</b> (2006.01)	3797797	ANTIBODY CONJUGATES COMPRISING TOLL-LIKE RECEPTOR AGONIST
<b>C07D 487/04</b> (2006.01)	3797797	ANTIBODY CONJUGATES COMPRISING TOLL-LIKE RECEPTOR AGONIST
<b>C07H 15/26</b> (2006.01)	3797797	ANTIBODY CONJUGATES COMPRISING TOLL-LIKE RECEPTOR AGONIST
<b>A61K 31/4162</b> (2006.01)	3689874	1H-PYRAZOLO[4,3-B]PYRIDINES AS PDE1 INHIBITORS
<b>A61K 31/437</b> (2006.01)	3689874	1H-PYRAZOLO[4,3-B]PYRIDINES AS PDE1 INHIBITORS
<b>A61K 31/4745</b> (2006.01)	3689874	1H-PYRAZOLO[4,3-B]PYRIDINES AS PDE1 INHIBITORS
<b>A61P 25/00</b> (2006.01)	3689874	1H-PYRAZOLO[4,3-B]PYRIDINES AS PDE1 INHIBITORS
<b>A61P 25/14</b> (2006.01)	3689874	1H-PYRAZOLO[4,3-B]PYRIDINES AS PDE1 INHIBITORS
<b>A61P 25/16</b> (2006.01)	3689874	1H-PYRAZOLO[4,3-B]PYRIDINES AS PDE1 INHIBITORS
<b>A61P 25/18</b> (2006.01)	3689874	1H-PYRAZOLO[4,3-B]PYRIDINES AS PDE1 INHIBITORS
<b>A61P 25/22</b> (2006.01)	3689874	1H-PYRAZOLO[4,3-B]PYRIDINES AS PDE1 INHIBITORS
<b>A61P 25/24</b> (2006.01)	3689874	1H-PYRAZOLO[4,3-B]PYRIDINES AS PDE1 INHIBITORS
<b>A61P 25/28</b> (2006.01)	3689874	1H-PYRAZOLO[4,3-B]PYRIDINES AS PDE1 INHIBITORS
<b>A61P 43/00</b> (2006.01)	3689874	1H-PYRAZOLO[4,3-B]PYRIDINES AS PDE1 INHIBITORS
<b>C07D 305/06</b> (2006.01)	3689874	1H-PYRAZOLO[4,3-B]PYRIDINES AS PDE1 INHIBITORS
<b>C07D 401/04</b> (2006.01)	3689874	1H-PYRAZOLO[4,3-B]PYRIDINES AS PDE1 INHIBITORS
<b>C07D 413/04</b> (2006.01)	3689874	1H-PYRAZOLO[4,3-B]PYRIDINES AS PDE1 INHIBITORS
<b>C07D 471/04</b> (2006.01)	3689874	1H-PYRAZOLO[4,3-B]PYRIDINES AS PDE1 INHIBITORS
<b>C07K 16/24</b> (2006.01)	3683235	ANTI-IL-33 ANTIBODIES AND USES THEREOF
<b>A61K 35/26</b> (2015.01)	3708579	CLAUDIN-6-SPECIFIC IMMUNORECEPTORS AND T CELL EPITOPES
<b>A61P 35/00</b> (2006.01)	3708579	CLAUDIN-6-SPECIFIC IMMUNORECEPTORS AND T CELL EPITOPES
<b>C07K 14/47</b> (2006.01)	3708579	CLAUDIN-6-SPECIFIC IMMUNORECEPTORS AND T CELL EPITOPES
<b>C07K 14/725</b> (2006.01)	3708579	CLAUDIN-6-SPECIFIC IMMUNORECEPTORS AND T CELL EPITOPES
<b>A61B 17/00</b> (2006.01)	3679869	SURGICAL STAPLING INSTRUMENT WITH SHAFT RELEASE
<b>A61B 17/072</b> (2006.01)	3679869	SURGICAL STAPLING INSTRUMENT WITH SHAFT RELEASE
<b>A61B 17/29</b> (2006.01)	3679869	SURGICAL STAPLING INSTRUMENT WITH SHAFT RELEASE
<b>A61B 90/00</b> (2016.01)	3679869	SURGICAL STAPLING INSTRUMENT WITH SHAFT RELEASE
<b>A61B 90/98</b> (2016.01)	3679869	SURGICAL STAPLING INSTRUMENT WITH SHAFT RELEASE
<b>A61K 39/00</b> (2006.01)	3693395	ST2 ANTIGEN BINDING PROTEINS
<b>A61P 1/04</b> (2006.01)	3693395	ST2 ANTIGEN BINDING PROTEINS

MKP	Broj objave evropske prijave patenta (97)	Naziv pronalaska (54)
(51)		(54)
<b>A61P 7/00</b> (2006.01)	3693395	ST2 ANTIGEN BINDING PROTEINS
<b>A61P 9/00</b> (2006.01)	3693395	ST2 ANTIGEN BINDING PROTEINS
<b>A61P 11/00</b> (2006.01)	3693395	ST2 ANTIGEN BINDING PROTEINS
<b>A61P 11/02</b> (2006.01)	3693395	ST2 ANTIGEN BINDING PROTEINS
<b>A61P 17/00</b> (2006.01)	3693395	ST2 ANTIGEN BINDING PROTEINS
<b>A61P 17/02</b> (2006.01)	3693395	ST2 ANTIGEN BINDING PROTEINS
<b>A61P 19/02</b> (2006.01)	3693395	ST2 ANTIGEN BINDING PROTEINS
<b>A61P 19/08</b> (2006.01)	3693395	ST2 ANTIGEN BINDING PROTEINS
<b>A61P 25/00</b> (2006.01)	3693395	ST2 ANTIGEN BINDING PROTEINS
<b>A61P 27/16</b> (2006.01)	3693395	ST2 ANTIGEN BINDING PROTEINS
<b>A61P 29/00</b> (2006.01)	3693395	ST2 ANTIGEN BINDING PROTEINS
<b>A61P 31/04</b> (2006.01)	3693395	ST2 ANTIGEN BINDING PROTEINS
<b>A61P 35/00</b> (2006.01)	3693395	ST2 ANTIGEN BINDING PROTEINS
<b>A61P 37/00</b> (2006.01)	3693395	ST2 ANTIGEN BINDING PROTEINS
<b>A61P 37/02</b> (2006.01)	3693395	ST2 ANTIGEN BINDING PROTEINS
<b>A61P 37/06</b> (2006.01)	3693395	ST2 ANTIGEN BINDING PROTEINS
<b>A61P 37/08</b> (2006.01)	3693395	ST2 ANTIGEN BINDING PROTEINS
<b>A61P 43/00</b> (2006.01)	3693395	ST2 ANTIGEN BINDING PROTEINS
<b>C07K 16/28</b> (2006.01)	3693395	ST2 ANTIGEN BINDING PROTEINS
<b>A61K 31/445</b> (2006.01)	3682879	PROCESSES AND INTERMEDIATES IN THE PREPARATION OF C5AR ANTAGONISTS
<b>C07D 211/60</b> (2006.01)	3682879	PROCESSES AND INTERMEDIATES IN THE PREPARATION OF C5AR ANTAGONISTS
<b>F02D 11/10</b> (2006.01)	3708813	ELECTRONICALLY CONTROLLED THROTTLE CONTROL DEVICE
<b>F02D 41/14</b> (2006.01)	3708813	ELECTRONICALLY CONTROLLED THROTTLE CONTROL DEVICE
<b>G05B 19/418</b> (2006.01)	3709113	DATA INTEGRITY TESTING METHOD
<b>G06F 21/64</b> (2013.01)	3709113	DATA INTEGRITY TESTING METHOD
<b>H04L 9/32</b> (2006.01)	3709113	DATA INTEGRITY TESTING METHOD
<b>C12N 5/02</b> (2006.01)	3683316	PERFUSION MEDIA
<b>C12P 21/02</b> (2006.01)	3683316	PERFUSION MEDIA
<b>A61K 9/48</b> (2006.01)	3689380	CALCIFEDIOL SOFT CAPSULES
<b>A61K 31/047</b> (2006.01)	3689380	CALCIFEDIOL SOFT CAPSULES
<b>A61K 47/14</b> (2017.01)	3689380	CALCIFEDIOL SOFT CAPSULES
<b>A61P 1/00</b> (2006.01)	3689380	CALCIFEDIOL SOFT CAPSULES
<b>A61P 1/04</b> (2006.01)	3689380	CALCIFEDIOL SOFT CAPSULES
<b>A61P 3/02</b> (2006.01)	3689380	CALCIFEDIOL SOFT CAPSULES
<b>A61P 3/12</b> (2006.01)	3689380	CALCIFEDIOL SOFT CAPSULES
<b>A61P 3/14</b> (2006.01)	3689380	CALCIFEDIOL SOFT CAPSULES
<b>A61P 5/18</b> (2006.01)	3689380	CALCIFEDIOL SOFT CAPSULES
<b>A61P 7/00</b> (2006.01)	3689380	CALCIFEDIOL SOFT CAPSULES
<b>A61P 13/12</b> (2006.01)	3689380	CALCIFEDIOL SOFT CAPSULES
<b>A61P 19/00</b> (2006.01)	3689380	CALCIFEDIOL SOFT CAPSULES
<b>A61P 19/02</b> (2006.01)	3689380	CALCIFEDIOL SOFT CAPSULES
<b>A61P 19/08</b> (2006.01)	3689380	CALCIFEDIOL SOFT CAPSULES
<b>A61P 19/10</b> (2006.01)	3689380	CALCIFEDIOL SOFT CAPSULES
<b>A61P 43/00</b> (2006.01)	3689380	CALCIFEDIOL SOFT CAPSULES
<b>A61K 31/27</b> (2006.01)	3698782	CARBAMATE COMPOUNDS FOR USE IN THERAPY
<b>A61K 31/325</b> (2006.01)	3698782	CARBAMATE COMPOUNDS FOR USE IN THERAPY
<b>C07C 269/00</b> (2006.01)	3698782	CARBAMATE COMPOUNDS FOR USE IN THERAPY
<b>C07C 271/00</b> (2006.01)	3698782	CARBAMATE COMPOUNDS FOR USE IN THERAPY
<b>C07C 271/62</b> (2006.01)	3698782	CARBAMATE COMPOUNDS FOR USE IN THERAPY
<b>C07D 203/20</b> (2006.01)	3698782	CARBAMATE COMPOUNDS FOR USE IN THERAPY
<b>C09K 11/56</b> (2006.01)	3788120	NANO ENCODING TECHNOLOGY FOR THE TRACKING OF INFORMATION IN LIQUID SAMPLES
<b>C09K 11/88</b> (2006.01)	3788120	NANO ENCODING TECHNOLOGY FOR THE TRACKING OF INFORMATION IN LIQUID SAMPLES
<b>G01N 21/64</b> (2006.01)	3788120	NANO ENCODING TECHNOLOGY FOR THE TRACKING OF INFORMATION IN LIQUID SAMPLES
<b>A61K 39/00</b> (2006.01)	3788074	ANTIBODY VARIANT COMBINATIONS AND USES THEREOF
<b>A61P 35/00</b> (2006.01)	3788074	ANTIBODY VARIANT COMBINATIONS AND USES THEREOF
<b>C07K 16/28</b> (2006.01)	3788074	ANTIBODY VARIANT COMBINATIONS AND USES THEREOF
<b>C07K 16/46</b> (2006.01)	3788074	ANTIBODY VARIANT COMBINATIONS AND USES THEREOF
<b>A61K 31/427</b> (2006.01)	3793553	1,3-THIAZOL-2-YL SUBSTITUTED BENZAMIDES FOR THE TREATMENT OF DISEASES ASSOCIATED WITH NERVE FIBER SENSITIZATION
<b>A61P 9/04</b> (2006.01)	3793553	1,3-THIAZOL-2-YL SUBSTITUTED BENZAMIDES FOR THE TREATMENT OF DISEASES ASSOCIATED WITH NERVE FIBER SENSITIZATION

MKP	Broj objave evropske prijave patenta (97)	Naziv pronalaska (54)
(51)		
<b>A61P 9/10</b> (2006.01)	3793553	1,3-THIAZOL-2-YL SUBSTITUTED BENZAMIDES FOR THE TREATMENT OF DISEASES ASSOCIATED WITH NERVE FIBER SENSITIZATION
<b>A61P 9/12</b> (2006.01)	3793553	1,3-THIAZOL-2-YL SUBSTITUTED BENZAMIDES FOR THE TREATMENT OF DISEASES ASSOCIATED WITH NERVE FIBER SENSITIZATION
<b>A61P 25/28</b> (2006.01)	3793553	1,3-THIAZOL-2-YL SUBSTITUTED BENZAMIDES FOR THE TREATMENT OF DISEASES ASSOCIATED WITH NERVE FIBER SENSITIZATION
<b>C07D 401/12</b> (2006.01)	3788040	PYRIDAZINONES AS PARP7 INHIBITORS
<b>C07D 401/14</b> (2006.01)	3788040	PYRIDAZINONES AS PARP7 INHIBITORS
<b>C07D 403/04</b> (2006.01)	3788040	PYRIDAZINONES AS PARP7 INHIBITORS
<b>C07D 403/12</b> (2006.01)	3788040	PYRIDAZINONES AS PARP7 INHIBITORS
<b>C07D 405/14</b> (2006.01)	3788040	PYRIDAZINONES AS PARP7 INHIBITORS
<b>C07D 413/14</b> (2006.01)	3788040	PYRIDAZINONES AS PARP7 INHIBITORS
<b>C07D 417/12</b> (2006.01)	3788040	PYRIDAZINONES AS PARP7 INHIBITORS
<b>C07D 417/14</b> (2006.01)	3788040	PYRIDAZINONES AS PARP7 INHIBITORS
<b>C07D 451/02</b> (2006.01)	3788040	PYRIDAZINONES AS PARP7 INHIBITORS
<b>C07D 471/04</b> (2006.01)	3788040	PYRIDAZINONES AS PARP7 INHIBITORS
<b>C07D 471/08</b> (2006.01)	3788040	PYRIDAZINONES AS PARP7 INHIBITORS
<b>C07D 471/10</b> (2006.01)	3788040	PYRIDAZINONES AS PARP7 INHIBITORS
<b>C07D 487/04</b> (2006.01)	3788040	PYRIDAZINONES AS PARP7 INHIBITORS
<b>C07D 487/08</b> (2006.01)	3788040	PYRIDAZINONES AS PARP7 INHIBITORS
<b>C07D 487/10</b> (2006.01)	3788040	PYRIDAZINONES AS PARP7 INHIBITORS
<b>C12Q 1/6886</b> (2018.01)	3784804	SELECTING PATIENTS FOR THERAPY WITH ADENOSINE SIGNALING INHIBITORS
<b>A61K 31/55</b> (2006.01)	3790884	TETRACYCLIC HETEROARYL COMPOUNDS
<b>A61P 35/00</b> (2006.01)	3790884	TETRACYCLIC HETEROARYL COMPOUNDS
<b>C07D 498/14</b> (2006.01)	3790884	TETRACYCLIC HETEROARYL COMPOUNDS
<b>A61K 47/54</b> (2017.01)	3790590	BIOCOMPATIBLE COPOLYMER CONTAINING MULTIPLE ACTIVE AGENT MOLECULES
<b>A61K 47/58</b> (2017.01)	3790590	BIOCOMPATIBLE COPOLYMER CONTAINING MULTIPLE ACTIVE AGENT MOLECULES
<b>A61K 47/64</b> (2017.01)	3790590	BIOCOMPATIBLE COPOLYMER CONTAINING MULTIPLE ACTIVE AGENT MOLECULES
<b>A61K 47/65</b> (2017.01)	3790590	BIOCOMPATIBLE COPOLYMER CONTAINING MULTIPLE ACTIVE AGENT MOLECULES
<b>A61K 47/68</b> (2017.01)	3790590	BIOCOMPATIBLE COPOLYMER CONTAINING MULTIPLE ACTIVE AGENT MOLECULES
<b>A61K 51/06</b> (2006.01)	3790590	BIOCOMPATIBLE COPOLYMER CONTAINING MULTIPLE ACTIVE AGENT MOLECULES
<b>A61K 51/10</b> (2006.01)	3790590	BIOCOMPATIBLE COPOLYMER CONTAINING MULTIPLE ACTIVE AGENT MOLECULES
<b>A61P 35/00</b> (2006.01)	3790590	BIOCOMPATIBLE COPOLYMER CONTAINING MULTIPLE ACTIVE AGENT MOLECULES
<b>G01N 33/68</b> (2006.01)	3794355	BLOOD BIOMARKERS OF STROKE
<b>A61P 3/00</b> (2006.01)	3788037	SUBSTITUTED PYRIMIDINONES AS AGONISTS OF THE APJ RECEPTOR
<b>A61P 9/00</b> (2006.01)	3788037	SUBSTITUTED PYRIMIDINONES AS AGONISTS OF THE APJ RECEPTOR
<b>A61P 13/12</b> (2006.01)	3788037	SUBSTITUTED PYRIMIDINONES AS AGONISTS OF THE APJ RECEPTOR
<b>C07D 239/545</b> (2006.01)	3788037	SUBSTITUTED PYRIMIDINONES AS AGONISTS OF THE APJ RECEPTOR
<b>C07D 401/12</b> (2006.01)	3788037	SUBSTITUTED PYRIMIDINONES AS AGONISTS OF THE APJ RECEPTOR
<b>C07D 401/14</b> (2006.01)	3788037	SUBSTITUTED PYRIMIDINONES AS AGONISTS OF THE APJ RECEPTOR
<b>C07D 403/14</b> (2006.01)	3788037	SUBSTITUTED PYRIMIDINONES AS AGONISTS OF THE APJ RECEPTOR
<b>C07D 405/14</b> (2006.01)	3788037	SUBSTITUTED PYRIMIDINONES AS AGONISTS OF THE APJ RECEPTOR
<b>A61K 31/427</b> (2006.01)	3793554	1,3-THIAZOL-2-YL SUBSTITUTED BENZAMIDES FOR THE TREATMENT OF DISEASES ASSOCIATED WITH NERVE FIBER SENSITIZATION
<b>A61P 11/00</b> (2006.01)	3793554	1,3-THIAZOL-2-YL SUBSTITUTED BENZAMIDES FOR THE TREATMENT OF DISEASES ASSOCIATED WITH NERVE FIBER SENSITIZATION

MKP (51)	Broj objave evropske prijava patenta (97)	Naziv pronalaska (54)
<b>A61P 11/06</b> (2006.01)	3793554	1,3-THIAZOL-2-YL SUBSTITUTED BENZAMIDES FOR THE TREATMENT OF DISEASES ASSOCIATED WITH NERVE FIBER SENSITIZATION
<b>A61P 11/14</b> (2006.01)	3793554	1,3-THIAZOL-2-YL SUBSTITUTED BENZAMIDES FOR THE TREATMENT OF DISEASES ASSOCIATED WITH NERVE FIBER SENSITIZATION
<b>A61P 25/28</b> (2006.01)	3793554	1,3-THIAZOL-2-YL SUBSTITUTED BENZAMIDES FOR THE TREATMENT OF DISEASES ASSOCIATED WITH NERVE FIBER SENSITIZATION
<b>A61K 31/537</b> (2006.01)	3784676	POLYMORPHIC FORMS OF BICTEGRAVIR AND ITS SODIUM SALT
<b>A61P 31/18</b> (2006.01)	3784676	POLYMORPHIC FORMS OF BICTEGRAVIR AND ITS SODIUM SALT
<b>C07D 498/18</b> (2006.01)	3784676	POLYMORPHIC FORMS OF BICTEGRAVIR AND ITS SODIUM SALT
<b>C08G 64/02</b> (2006.01)	3781609	END-GROUP ISOMERIZATION OF POLY(ALKYLENE CARBONATE) POLYMERS
<b>C08G 64/42</b> (2006.01)	3781609	END-GROUP ISOMERIZATION OF POLY(ALKYLENE CARBONATE) POLYMERS
<b>C08L 69/00</b> (2006.01)	3781609	END-GROUP ISOMERIZATION OF POLY(ALKYLENE CARBONATE) POLYMERS
<b>A61K 31/553</b> (2006.01)	3788044	RIP1 INHIBITORY COMPOUNDS AND METHODS FOR MAKING AND USING THE SAME
<b>A61P 29/00</b> (2006.01)	3788044	RIP1 INHIBITORY COMPOUNDS AND METHODS FOR MAKING AND USING THE SAME
<b>A61P 37/02</b> (2006.01)	3788044	RIP1 INHIBITORY COMPOUNDS AND METHODS FOR MAKING AND USING THE SAME
<b>C07D 413/12</b> (2006.01)	3788044	RIP1 INHIBITORY COMPOUNDS AND METHODS FOR MAKING AND USING THE SAME
<b>C07D 413/14</b> (2006.01)	3788044	RIP1 INHIBITORY COMPOUNDS AND METHODS FOR MAKING AND USING THE SAME
<b>A61K 39/395</b> (2006.01)	3788076	ANTIBODIES WITH MODULATED GLYCAN PROFILES
<b>C07K 16/28</b> (2006.01)	3788076	ANTIBODIES WITH MODULATED GLYCAN PROFILES
<b>C02F 1/04</b> (2006.01)	3781523	WASTEWATER TREATMENT APPARATUS AND METHOD
<b>C02F 3/28</b> (2006.01)	3781523	WASTEWATER TREATMENT APPARATUS AND METHOD
<b>C02F 11/04</b> (2006.01)	3781523	WASTEWATER TREATMENT APPARATUS AND METHOD
<b>A61K 31/553</b> (2006.01)	3788045	RIP1 INHIBITORY COMPOUNDS AND METHODS FOR MAKING AND USING THE SAME
<b>A61P 29/00</b> (2006.01)	3788045	RIP1 INHIBITORY COMPOUNDS AND METHODS FOR MAKING AND USING THE SAME
<b>A61P 37/02</b> (2006.01)	3788045	RIP1 INHIBITORY COMPOUNDS AND METHODS FOR MAKING AND USING THE SAME
<b>C07D 413/12</b> (2006.01)	3788045	RIP1 INHIBITORY COMPOUNDS AND METHODS FOR MAKING AND USING THE SAME
<b>C07D 413/14</b> (2006.01)	3788045	RIP1 INHIBITORY COMPOUNDS AND METHODS FOR MAKING AND USING THE SAME
<b>A61K 31/519</b> (2006.01)	3788046	SALTS OF AN FGFR INHIBITOR
<b>A61P 35/00</b> (2006.01)	3788046	SALTS OF AN FGFR INHIBITOR
<b>C07D 471/14</b> (2006.01)	3788046	SALTS OF AN FGFR INHIBITOR
<b>A61K 31/519</b> (2006.01)	3788047	SOLID FORMS OF AN FGFR INHIBITOR AND PROCESSES FOR PREPARING THE SAME
<b>A61P 35/00</b> (2006.01)	3788047	SOLID FORMS OF AN FGFR INHIBITOR AND PROCESSES FOR PREPARING THE SAME
<b>C07D 471/14</b> (2006.01)	3788047	SOLID FORMS OF AN FGFR INHIBITOR AND PROCESSES FOR PREPARING THE SAME
<b>A61K 9/12</b> (2006.01)	3787599	NEW TREATMENT OF INTERSTITIAL LUNG DISEASES
<b>A61K 9/51</b> (2006.01)	3787599	NEW TREATMENT OF INTERSTITIAL LUNG DISEASES
<b>A61K 31/454</b> (2006.01)	3787599	NEW TREATMENT OF INTERSTITIAL LUNG DISEASES
<b>A23L 33/135</b> (2016.01)	3790564	COMPOSITIONS COMPRISING BACTERIAL STRAINS
<b>A61K 35/74</b> (2015.01)	3790564	COMPOSITIONS COMPRISING BACTERIAL STRAINS
<b>A61P 1/00</b> (2006.01)	3790564	COMPOSITIONS COMPRISING BACTERIAL STRAINS
<b>A61P 3/10</b> (2006.01)	3790564	COMPOSITIONS COMPRISING BACTERIAL STRAINS
<b>A61P 11/06</b> (2006.01)	3790564	COMPOSITIONS COMPRISING BACTERIAL STRAINS
<b>A61P 17/06</b> (2006.01)	3790564	COMPOSITIONS COMPRISING BACTERIAL STRAINS
<b>A61P 19/02</b> (2006.01)	3790564	COMPOSITIONS COMPRISING BACTERIAL STRAINS
<b>A61P 35/00</b> (2006.01)	3790564	COMPOSITIONS COMPRISING BACTERIAL STRAINS
<b>A61P 37/00</b> (2006.01)	3790564	COMPOSITIONS COMPRISING BACTERIAL STRAINS
<b>A61P 43/00</b> (2006.01)	3790564	COMPOSITIONS COMPRISING BACTERIAL STRAINS
<b>A61K 31/4985</b> (2006.01)	3793559	SUBSTITUTED DIHYDROPYRAZOLO PYRAZINE CARBOXAMIDE DERIVATIVES

MKP	Broj objave evropske prijave patenta (97)	Naziv pronalaska (54)
(51)		(54)
<b>A61P 7/00</b> (2006.01)	3793559	SUBSTITUTED DIHYDROPYRAZOLO PYRAZINE CARBOXAMIDE DERIVATIVES
<b>A61P 27/02</b> (2006.01)	3793559	SUBSTITUTED DIHYDROPYRAZOLO PYRAZINE CARBOXAMIDE DERIVATIVES
<b>C07D 487/04</b> (2006.01)	3793559	SUBSTITUTED DIHYDROPYRAZOLO PYRAZINE CARBOXAMIDE DERIVATIVES
<b>A61K 31/553</b> (2006.01)	3788053	KRAS G12C INHIBITORS AND METHODS OF USING THE SAME
<b>A61K 45/06</b> (2006.01)	3788053	KRAS G12C INHIBITORS AND METHODS OF USING THE SAME
<b>C07F 9/6561</b> (2006.01)	3788053	KRAS G12C INHIBITORS AND METHODS OF USING THE SAME
<b>A61K 31/7125</b> (2006.01)	3790972	GALNAC CONJUGATED MODIFIED OLIGONUCLEOTIDE AS MIR-122 INHIBITOR HAVING HCV ANTIVIRAL ACTIVITY WITH REDUCED HYPERBILIRUBINEMIA SIDE-EFFECT
<b>A61P 31/14</b> (2006.01)	3790972	GALNAC CONJUGATED MODIFIED OLIGONUCLEOTIDE AS MIR-122 INHIBITOR HAVING HCV ANTIVIRAL ACTIVITY WITH REDUCED HYPERBILIRUBINEMIA SIDE-EFFECT
<b>C12N 15/113</b> (2010.01)	3790972	GALNAC CONJUGATED MODIFIED OLIGONUCLEOTIDE AS MIR-122 INHIBITOR HAVING HCV ANTIVIRAL ACTIVITY WITH REDUCED HYPERBILIRUBINEMIA SIDE-EFFECT
<b>A61K 47/68</b> (2017.01)	3790899	ANTI-MSR1 ANTIBODIES AND METHODS OF USE THEREOF
<b>C07K 16/28</b> (2006.01)	3790899	ANTI-MSR1 ANTIBODIES AND METHODS OF USE THEREOF
<b>A61K 31/549</b> (2006.01)	3790886	KRAS G12C INHIBITORS FOR THE TREATMENT OF CANCER
<b>A61P 35/00</b> (2006.01)	3790886	KRAS G12C INHIBITORS FOR THE TREATMENT OF CANCER
<b>C07D 513/04</b> (2006.01)	3790886	KRAS G12C INHIBITORS FOR THE TREATMENT OF CANCER
<b>A61K 31/437</b> (2006.01)	3790877	TETRAHYDRO-IMIDAZO[4,5-C]PYRIDINE DERIVATIVES AS PD-L1 IMMUNOMODULATORS
<b>A61P 35/00</b> (2006.01)	3790877	TETRAHYDRO-IMIDAZO[4,5-C]PYRIDINE DERIVATIVES AS PD-L1 IMMUNOMODULATORS
<b>A61P 37/00</b> (2006.01)	3790877	TETRAHYDRO-IMIDAZO[4,5-C]PYRIDINE DERIVATIVES AS PD-L1 IMMUNOMODULATORS
<b>C07D 471/04</b> (2006.01)	3790877	TETRAHYDRO-IMIDAZO[4,5-C]PYRIDINE DERIVATIVES AS PD-L1 IMMUNOMODULATORS
<b>A61P 27/02</b> (2006.01)	3790897	C3-BINDING AGENTS AND METHODS OF USE THEREOF
<b>C07K 16/18</b> (2006.01)	3790897	C3-BINDING AGENTS AND METHODS OF USE THEREOF
<b>B32B 27/36</b> (2006.01)	3797134	SURFACE-TREATED FILLERS FOR POLYESTER FILMS
<b>C08J 5/18</b> (2006.01)	3797134	SURFACE-TREATED FILLERS FOR POLYESTER FILMS
<b>C08K 9/02</b> (2006.01)	3797134	SURFACE-TREATED FILLERS FOR POLYESTER FILMS
<b>C08K 9/04</b> (2006.01)	3797134	SURFACE-TREATED FILLERS FOR POLYESTER FILMS
<b>C08K 9/06</b> (2006.01)	3797134	SURFACE-TREATED FILLERS FOR POLYESTER FILMS
<b>C09C 1/02</b> (2006.01)	3797134	SURFACE-TREATED FILLERS FOR POLYESTER FILMS
<b>E01F 9/588</b> (2016.01)	3781746	IMPROVED LANE SEPARATOR FOR CYCLE PATHS
<b>A61K 31/454</b> (2006.01)	3784663	SUBSTITUTED 4-AMINOISOINDOLINE-1,3-DIONE COMPOUNDS AND THEIR USE FOR TREATING LYMPHOMA
<b>A61P 35/00</b> (2006.01)	3784663	SUBSTITUTED 4-AMINOISOINDOLINE-1,3-DIONE COMPOUNDS AND THEIR USE FOR TREATING LYMPHOMA
<b>C07D 401/04</b> (2006.01)	3784663	SUBSTITUTED 4-AMINOISOINDOLINE-1,3-DIONE COMPOUNDS AND THEIR USE FOR TREATING LYMPHOMA
<b>C07D 401/14</b> (2006.01)	3784663	SUBSTITUTED 4-AMINOISOINDOLINE-1,3-DIONE COMPOUNDS AND THEIR USE FOR TREATING LYMPHOMA
<b>C07D 417/14</b> (2006.01)	3784663	SUBSTITUTED 4-AMINOISOINDOLINE-1,3-DIONE COMPOUNDS AND THEIR USE FOR TREATING LYMPHOMA
<b>C07D 491/08</b> (2006.01)	3784663	SUBSTITUTED 4-AMINOISOINDOLINE-1,3-DIONE COMPOUNDS AND THEIR USE FOR TREATING LYMPHOMA
<b>C07D 491/10</b> (2006.01)	3784663	SUBSTITUTED 4-AMINOISOINDOLINE-1,3-DIONE COMPOUNDS AND THEIR USE FOR TREATING LYMPHOMA
<b>A61K 31/553</b> (2006.01)	3784666	ANTIPROLIFERATION COMPOUNDS AND USES THEREOF
<b>A61P 35/00</b> (2006.01)	3784666	ANTIPROLIFERATION COMPOUNDS AND USES THEREOF
<b>C07D 403/04</b> (2006.01)	3784666	ANTIPROLIFERATION COMPOUNDS AND USES THEREOF
<b>C07D 409/14</b> (2006.01)	3784666	ANTIPROLIFERATION COMPOUNDS AND USES THEREOF
<b>C07D 413/04</b> (2006.01)	3784666	ANTIPROLIFERATION COMPOUNDS AND USES THEREOF
<b>C07D 413/14</b> (2006.01)	3784666	ANTIPROLIFERATION COMPOUNDS AND USES THEREOF
<b>A61K 39/00</b> (2006.01)	3784694	METHODS AND COMPOSITIONS OF CYTOTOXIC T CELL DEPLETION
<b>A61P 37/06</b> (2006.01)	3784694	METHODS AND COMPOSITIONS OF CYTOTOXIC T CELL DEPLETION
<b>C07K 14/725</b> (2006.01)	3784694	METHODS AND COMPOSITIONS OF CYTOTOXIC T CELL DEPLETION
<b>C07K 14/74</b> (2006.01)	3784694	METHODS AND COMPOSITIONS OF CYTOTOXIC T CELL DEPLETION

MKP (51)	Broj objave evropske prijava patenta (97)	Naziv pronalaska (54)
<b>C12N 15/113</b> (2010.01)	3784694	METHODS AND COMPOSITIONS OF CYTOTOXIC T CELL DEPLETION
<b>A61K 31/4015</b> (2006.01)	3790859	NOVEL FUNCTIONALIZED LACTAMS AS MODULATORS OF THE 5-HYDROXYTRYPTAMINE RECEPTOR 7 AND THEIR METHOD OF USE
<b>A61K 31/497</b> (2006.01)	3790859	NOVEL FUNCTIONALIZED LACTAMS AS MODULATORS OF THE 5-HYDROXYTRYPTAMINE RECEPTOR 7 AND THEIR METHOD OF USE
<b>A61P 25/00</b> (2006.01)	3790859	NOVEL FUNCTIONALIZED LACTAMS AS MODULATORS OF THE 5-HYDROXYTRYPTAMINE RECEPTOR 7 AND THEIR METHOD OF USE
<b>C07D 207/20</b> (2006.01)	3790859	NOVEL FUNCTIONALIZED LACTAMS AS MODULATORS OF THE 5-HYDROXYTRYPTAMINE RECEPTOR 7 AND THEIR METHOD OF USE
<b>C07D 209/96</b> (2006.01)	3790859	NOVEL FUNCTIONALIZED LACTAMS AS MODULATORS OF THE 5-HYDROXYTRYPTAMINE RECEPTOR 7 AND THEIR METHOD OF USE
<b>C07D 401/06</b> (2006.01)	3790859	NOVEL FUNCTIONALIZED LACTAMS AS MODULATORS OF THE 5-HYDROXYTRYPTAMINE RECEPTOR 7 AND THEIR METHOD OF USE
<b>C07D 401/12</b> (2006.01)	3790859	NOVEL FUNCTIONALIZED LACTAMS AS MODULATORS OF THE 5-HYDROXYTRYPTAMINE RECEPTOR 7 AND THEIR METHOD OF USE
<b>C07D 471/10</b> (2006.01)	3790859	NOVEL FUNCTIONALIZED LACTAMS AS MODULATORS OF THE 5-HYDROXYTRYPTAMINE RECEPTOR 7 AND THEIR METHOD OF USE
<b>C07D 487/04</b> (2006.01)	3790859	NOVEL FUNCTIONALIZED LACTAMS AS MODULATORS OF THE 5-HYDROXYTRYPTAMINE RECEPTOR 7 AND THEIR METHOD OF USE
<b>A61K 31/472</b> (2006.01)	3790548	METHODS FOR ENHANCING THE BIOAVAILABILITY AND EXPOSURE OF A VOLTAGE-GATED POTASSIUM CHANNEL OPENER
<b>A61P 25/08</b> (2006.01)	3790548	METHODS FOR ENHANCING THE BIOAVAILABILITY AND EXPOSURE OF A VOLTAGE-GATED POTASSIUM CHANNEL OPENER
<b>A61K 9/00</b> (2006.01)	3790532	HIGH CONCENTRATION VEGF RECEPTOR FUSION PROTEIN CONTAINING FORMULATIONS
<b>A61K 9/08</b> (2006.01)	3790532	HIGH CONCENTRATION VEGF RECEPTOR FUSION PROTEIN CONTAINING FORMULATIONS
<b>A61K 38/17</b> (2006.01)	3790532	HIGH CONCENTRATION VEGF RECEPTOR FUSION PROTEIN CONTAINING FORMULATIONS
<b>A61K 47/22</b> (2006.01)	3790532	HIGH CONCENTRATION VEGF RECEPTOR FUSION PROTEIN CONTAINING FORMULATIONS
<b>A61K 47/26</b> (2006.01)	3790532	HIGH CONCENTRATION VEGF RECEPTOR FUSION PROTEIN CONTAINING FORMULATIONS
<b>A61P 27/02</b> (2006.01)	3790532	HIGH CONCENTRATION VEGF RECEPTOR FUSION PROTEIN CONTAINING FORMULATIONS
<b>A61K 38/09</b> (2006.01)	3784346	A COMPOSITION FOR TREATING ONE OR MORE ESTROGEN RELATED DISEASES
<b>A61P 5/30</b> (2006.01)	3784346	A COMPOSITION FOR TREATING ONE OR MORE ESTROGEN RELATED DISEASES
<b>A61P 35/00</b> (2006.01)	3784664	2-AMINO-PYRIDINE OR 2-AMINO-PYRIMIDINE DERIVATIVES AS CYCLIN DEPENDENT KINASE INHIBITORS
<b>C07D 401/14</b> (2006.01)	3784664	2-AMINO-PYRIDINE OR 2-AMINO-PYRIMIDINE DERIVATIVES AS CYCLIN DEPENDENT KINASE INHIBITORS
<b>C07D 405/14</b> (2006.01)	3784664	2-AMINO-PYRIDINE OR 2-AMINO-PYRIMIDINE DERIVATIVES AS CYCLIN DEPENDENT KINASE INHIBITORS
<b>C07D 487/04</b> (2006.01)	3784664	2-AMINO-PYRIDINE OR 2-AMINO-PYRIMIDINE DERIVATIVES AS CYCLIN DEPENDENT KINASE INHIBITORS
<b>C07D 498/04</b> (2006.01)	3784664	2-AMINO-PYRIDINE OR 2-AMINO-PYRIMIDINE DERIVATIVES AS CYCLIN DEPENDENT KINASE INHIBITORS
<b>A61K 35/17</b> (2015.01)	3787751	COMBINATION THERAPY OF A CHIMERIC ANTIGEN RECEPTOR (CAR) T CELL THERAPY AND A KINASE INHIBITOR
<b>A61K 39/00</b> (2006.01)	3787751	COMBINATION THERAPY OF A CHIMERIC ANTIGEN RECEPTOR (CAR) T CELL THERAPY AND A KINASE INHIBITOR
<b>A61P 35/00</b> (2006.01)	3787751	COMBINATION THERAPY OF A CHIMERIC ANTIGEN RECEPTOR (CAR) T CELL THERAPY AND A KINASE INHIBITOR



MKP (51)	Broj objave evropske prijava patenta (97)	Naziv pronalaska (54)
<b>C07K 16/18</b> (2006.01)	3790904	BISPECIFIC ANTIBODIES WITH CLEAVABLE C-TERMINAL CHARGE-PAIRED TAGS
<b>C07K 16/24</b> (2006.01)	3790904	BISPECIFIC ANTIBODIES WITH CLEAVABLE C-TERMINAL CHARGE-PAIRED TAGS
<b>C07K 16/28</b> (2006.01)	3790904	BISPECIFIC ANTIBODIES WITH CLEAVABLE C-TERMINAL CHARGE-PAIRED TAGS
<b>C07K 16/46</b> (2006.01)	3790904	BISPECIFIC ANTIBODIES WITH CLEAVABLE C-TERMINAL CHARGE-PAIRED TAGS
<b>A61K 31/137</b> (2006.01)	3789020	FIXED DOSE COMPOSITION OF PARACETAMOL: AMITRIPTYLINE AND METHOD FOR THE TREATMENT OF MIXED CANCER PAIN
<b>A61K 31/167</b> (2006.01)	3789020	FIXED DOSE COMPOSITION OF PARACETAMOL: AMITRIPTYLINE AND METHOD FOR THE TREATMENT OF MIXED CANCER PAIN
<b>A61K 31/519</b> (2006.01)	3784670	NLRP3 MODULATORS
<b>A61P 35/00</b> (2006.01)	3784670	NLRP3 MODULATORS
<b>C07D 471/04</b> (2006.01)	3784670	NLRP3 MODULATORS
<b>C07D 498/04</b> (2006.01)	3784670	NLRP3 MODULATORS
<b>C07D 513/04</b> (2006.01)	3784670	NLRP3 MODULATORS
<b>C07D 519/00</b> (2006.01)	3784670	NLRP3 MODULATORS
<b>A24D 1/14</b> (2006.01)	3790417	DEVICE FOR SMOKING A SMOKEABLE MATERIAL
<b>A24F 1/30</b> (2006.01)	3790417	DEVICE FOR SMOKING A SMOKEABLE MATERIAL
<b>A24D 1/14</b> (2006.01)	3790415	DEVICE FOR SMOKING A SMOKEABLE MATERIAL
<b>B65H 35/00</b> (2006.01)	3781505	DISPENSER APPARATUS FOR ADHESIVE TAPE
<b>A61K 9/127</b> (2006.01)	3794008	RIBOSE CATIONIC LIPIDS
<b>A61K 47/26</b> (2006.01)	3794008	RIBOSE CATIONIC LIPIDS
<b>C07H 13/06</b> (2006.01)	3794008	RIBOSE CATIONIC LIPIDS
<b>C07H 13/12</b> (2006.01)	3794008	RIBOSE CATIONIC LIPIDS
<b>C07H 15/04</b> (2006.01)	3794008	RIBOSE CATIONIC LIPIDS
<b>C07H 15/10</b> (2006.01)	3794008	RIBOSE CATIONIC LIPIDS
<b>C07H 15/26</b> (2006.01)	3794008	RIBOSE CATIONIC LIPIDS
<b>A61K 38/47</b> (2006.01)	3793591	ANTI-CD63 ANTIBODIES, CONJUGATES, AND USES THEREOF
<b>A61P 43/00</b> (2006.01)	3793591	ANTI-CD63 ANTIBODIES, CONJUGATES, AND USES THEREOF
<b>C07K 16/28</b> (2006.01)	3793591	ANTI-CD63 ANTIBODIES, CONJUGATES, AND USES THEREOF
<b>C12N 9/34</b> (2006.01)	3793591	ANTI-CD63 ANTIBODIES, CONJUGATES, AND USES THEREOF
<b>A61K 39/395</b> (2006.01)	3793607	TREATMENT OF CANCER
<b>A61K 45/06</b> (2006.01)	3793607	TREATMENT OF CANCER
<b>A61P 35/00</b> (2006.01)	3793607	TREATMENT OF CANCER
<b>A61K 31/40</b> (2006.01)	3765011	CAPSID ASSEMBLY MODULATOR DOSING REGIMEN
<b>A61K 31/454</b> (2006.01)	3765011	CAPSID ASSEMBLY MODULATOR DOSING REGIMEN
<b>A61K 45/06</b> (2006.01)	3765011	CAPSID ASSEMBLY MODULATOR DOSING REGIMEN
<b>A61K 31/4162</b> (2006.01)	3787620	COMBINATIONS FOR TREATING CANCER
<b>A61K 31/4985</b> (2006.01)	3787620	COMBINATIONS FOR TREATING CANCER
<b>A61P 35/00</b> (2006.01)	3787620	COMBINATIONS FOR TREATING CANCER
<b>A61P 35/02</b> (2006.01)	3787620	COMBINATIONS FOR TREATING CANCER
<b>A61K 47/68</b> (2017.01)	3796942	MOLECULAR ADJUVANT
<b>A61P 35/00</b> (2006.01)	3796942	MOLECULAR ADJUVANT
<b>C07K 16/28</b> (2006.01)	3796942	MOLECULAR ADJUVANT
<b>A61K 9/00</b> (2006.01)	3796889	DANTROLENE FORMULATIONS AND METHODS OF THEIR USE
<b>A61K 9/19</b> (2006.01)	3796889	DANTROLENE FORMULATIONS AND METHODS OF THEIR USE
<b>A61K 31/4178</b> (2006.01)	3796889	DANTROLENE FORMULATIONS AND METHODS OF THEIR USE
<b>A61K 47/10</b> (2017.01)	3796889	DANTROLENE FORMULATIONS AND METHODS OF THEIR USE
<b>G06T 7/136</b> (2017.01)	3791361	TUMORAL MASS DETECTION SYSTEM BASED ON MAGNETIC RESONANCE IMAGING
<b>G06T 7/143</b> (2017.01)	3791361	TUMORAL MASS DETECTION SYSTEM BASED ON MAGNETIC RESONANCE IMAGING
<b>A41D 31/00</b> (2019.01)	3796802	TEXTILE ARTICLE FOR MOTORCYCLIST PROTECTIVE CLOTHING
<b>D03D 1/00</b> (2006.01)	3796802	TEXTILE ARTICLE FOR MOTORCYCLIST PROTECTIVE CLOTHING
<b>D03D 11/00</b> (2006.01)	3796802	TEXTILE ARTICLE FOR MOTORCYCLIST PROTECTIVE CLOTHING
<b>D03D 13/00</b> (2006.01)	3796802	TEXTILE ARTICLE FOR MOTORCYCLIST PROTECTIVE CLOTHING
<b>D03D 15/00</b> (2021.01)	3796802	TEXTILE ARTICLE FOR MOTORCYCLIST PROTECTIVE CLOTHING
<b>D03D 15/08</b> (2006.01)	3796802	TEXTILE ARTICLE FOR MOTORCYCLIST PROTECTIVE CLOTHING
<b>D03D 15/10</b> (2006.01)	3796802	TEXTILE ARTICLE FOR MOTORCYCLIST PROTECTIVE CLOTHING
<b>A61K 9/127</b> (2006.01)	3796893	DELIVERY OF DNA
<b>A61K 9/51</b> (2006.01)	3796893	DELIVERY OF DNA
<b>A61K 31/7088</b> (2006.01)	3796893	DELIVERY OF DNA
<b>A61K 31/519</b> (2006.01)	3788038	KRAS G12C INHIBITORS AND METHODS OF USING THE SAME
<b>A61P 35/00</b> (2006.01)	3788038	KRAS G12C INHIBITORS AND METHODS OF USING THE SAME
<b>C07D 403/04</b> (2006.01)	3788038	KRAS G12C INHIBITORS AND METHODS OF USING THE SAME
<b>C07D 403/14</b> (2006.01)	3788038	KRAS G12C INHIBITORS AND METHODS OF USING THE SAME

MKP (51)	Broj objave evropske prijava patenta (97)	Naziv pronalaska (54)
<b>C07D 471/04</b> (2006.01)	3788038	KRAS G12C INHIBITORS AND METHODS OF USING THE SAME
<b>C07D 487/04</b> (2006.01)	3788038	KRAS G12C INHIBITORS AND METHODS OF USING THE SAME
<b>C07D 211/02</b> (2006.01)	3784655	PROCESS FOR PREPARING 2-(1-(TERT-BUTOXYCARBONYL)PIPERIDINE-4-YL)BENZOIC ACID
<b>C07D 211/34</b> (2006.01)	3784655	PROCESS FOR PREPARING 2-(1-(TERT-BUTOXYCARBONYL)PIPERIDINE-4-YL)BENZOIC ACID
<b>A61K 31/496</b> (2006.01)	3784239	PHARMACEUTICAL COMBINATIONS
<b>A61K 39/395</b> (2006.01)	3784239	PHARMACEUTICAL COMBINATIONS
<b>A61K 47/68</b> (2017.01)	3784239	PHARMACEUTICAL COMBINATIONS
<b>C07K 16/28</b> (2006.01)	3784239	PHARMACEUTICAL COMBINATIONS
<b>C07K 16/30</b> (2006.01)	3784239	PHARMACEUTICAL COMBINATIONS
<b>G01N 33/50</b> (2006.01)	3785029	COMPOSITIONS AND METHODS FOR EVALUATING POTENCY OF LISTERIA-BASED IMMUNOTHERAPEUTICS
<b>A61K 39/00</b> (2006.01)	3784688	HEAT SHOCK PROTEIN-BINDING PEPTIDE COMPOSITIONS AND METHODS OF USE THEREOF
<b>C07K 14/005</b> (2006.01)	3784688	HEAT SHOCK PROTEIN-BINDING PEPTIDE COMPOSITIONS AND METHODS OF USE THEREOF
<b>C07K 14/19</b> (2006.01)	3784688	HEAT SHOCK PROTEIN-BINDING PEPTIDE COMPOSITIONS AND METHODS OF USE THEREOF
<b>C07K 14/47</b> (2006.01)	3784688	HEAT SHOCK PROTEIN-BINDING PEPTIDE COMPOSITIONS AND METHODS OF USE THEREOF
<b>A61K 31/53</b> (2006.01)	3793994	INHIBITING AGENTS FOR BRUTON'S TYROSINE KINASE
<b>A61K 31/55</b> (2006.01)	3793994	INHIBITING AGENTS FOR BRUTON'S TYROSINE KINASE
<b>A61P 37/00</b> (2006.01)	3793994	INHIBITING AGENTS FOR BRUTON'S TYROSINE KINASE
<b>C07D 403/14</b> (2006.01)	3793994	INHIBITING AGENTS FOR BRUTON'S TYROSINE KINASE
<b>C07D 405/14</b> (2006.01)	3793994	INHIBITING AGENTS FOR BRUTON'S TYROSINE KINASE
<b>C07D 413/14</b> (2006.01)	3793994	INHIBITING AGENTS FOR BRUTON'S TYROSINE KINASE
<b>A61K 31/7034</b> (2006.01)	3794009	BIARYL AMIDES WITH MODIFIED SUGAR GROUPS FOR TREATMENT OF DISEASES ASSOCIATED WITH HEAT SHOCK PROTEIN PATHWAY
<b>A61P 3/10</b> (2006.01)	3794009	BIARYL AMIDES WITH MODIFIED SUGAR GROUPS FOR TREATMENT OF DISEASES ASSOCIATED WITH HEAT SHOCK PROTEIN PATHWAY
<b>A61P 25/02</b> (2006.01)	3794009	BIARYL AMIDES WITH MODIFIED SUGAR GROUPS FOR TREATMENT OF DISEASES ASSOCIATED WITH HEAT SHOCK PROTEIN PATHWAY
<b>C07D 309/06</b> (2006.01)	3794009	BIARYL AMIDES WITH MODIFIED SUGAR GROUPS FOR TREATMENT OF DISEASES ASSOCIATED WITH HEAT SHOCK PROTEIN PATHWAY
<b>C07H 1/00</b> (2006.01)	3794009	BIARYL AMIDES WITH MODIFIED SUGAR GROUPS FOR TREATMENT OF DISEASES ASSOCIATED WITH HEAT SHOCK PROTEIN PATHWAY
<b>C07H 15/203</b> (2006.01)	3794009	BIARYL AMIDES WITH MODIFIED SUGAR GROUPS FOR TREATMENT OF DISEASES ASSOCIATED WITH HEAT SHOCK PROTEIN PATHWAY
<b>A61K 38/36</b> (2006.01)	3793588	METHODS OF TREATING HEMOPHILIA A
<b>A61K 38/37</b> (2006.01)	3793588	METHODS OF TREATING HEMOPHILIA A
<b>A61P 7/04</b> (2006.01)	3793588	METHODS OF TREATING HEMOPHILIA A
<b>A61K 47/60</b> (2017.01)	3796940	SELECTIVE TREG STIMULATOR RUR20KD-IL-2 AND RELATED COMPOSITIONS
<b>A61P 37/00</b> (2006.01)	3796940	SELECTIVE TREG STIMULATOR RUR20KD-IL-2 AND RELATED COMPOSITIONS
<b>A61K 38/51</b> (2006.01)	3794126	COMPOSITIONS AND METHODS FOR THE TREATMENT OF PARKINSON'S DISEASE
<b>A61K 48/00</b> (2006.01)	3794126	COMPOSITIONS AND METHODS FOR THE TREATMENT OF PARKINSON'S DISEASE
<b>C12N 15/62</b> (2006.01)	3794126	COMPOSITIONS AND METHODS FOR THE TREATMENT OF PARKINSON'S DISEASE
<b>C12N 15/86</b> (2006.01)	3794126	COMPOSITIONS AND METHODS FOR THE TREATMENT OF PARKINSON'S DISEASE
<b>B29C 64/106</b> (2017.01)	3784472	METHOD AND APPARATUS FOR ADDITIVE MANUFACTURING
<b>B29C 64/118</b> (2017.01)	3784472	METHOD AND APPARATUS FOR ADDITIVE MANUFACTURING
<b>B29C 64/245</b> (2017.01)	3784472	METHOD AND APPARATUS FOR ADDITIVE MANUFACTURING
<b>B29C 64/379</b> (2017.01)	3784472	METHOD AND APPARATUS FOR ADDITIVE MANUFACTURING
<b>B29C 64/40</b> (2017.01)	3784472	METHOD AND APPARATUS FOR ADDITIVE MANUFACTURING
<b>B33Y 10/00</b> (2015.01)	3784472	METHOD AND APPARATUS FOR ADDITIVE MANUFACTURING
<b>B33Y 70/00</b> (2020.01)	3784472	METHOD AND APPARATUS FOR ADDITIVE MANUFACTURING

MKP (51)	Broj objave evropske prijava patenta (97)	Naziv pronalaska (54)
<b>A61K 39/00</b> (2006.01)	3793599	BCMA/CD3 AND GPRDC5D/CD3 BISPECIFIC ANTIBODIES FOR USE IN CANCER THERAPY
<b>A61K 39/395</b> (2006.01)	3793599	BCMA/CD3 AND GPRDC5D/CD3 BISPECIFIC ANTIBODIES FOR USE IN CANCER THERAPY
<b>A61K 45/06</b> (2006.01)	3793599	BCMA/CD3 AND GPRDC5D/CD3 BISPECIFIC ANTIBODIES FOR USE IN CANCER THERAPY
<b>C07K 16/28</b> (2006.01)	3793599	BCMA/CD3 AND GPRDC5D/CD3 BISPECIFIC ANTIBODIES FOR USE IN CANCER THERAPY
<b>C07K 16/30</b> (2006.01)	3793599	BCMA/CD3 AND GPRDC5D/CD3 BISPECIFIC ANTIBODIES FOR USE IN CANCER THERAPY
<b>A01N 25/10</b> (2006.01)	3793358	ANTIMICROBIAL COMPOSITION BASED ON POLYPHENOLS AND POLYSACCHARIDES, METHOD FOR PREPARING THEREOF AND USE OF THE SAME
<b>A01N 25/34</b> (2006.01)	3793358	ANTIMICROBIAL COMPOSITION BASED ON POLYPHENOLS AND POLYSACCHARIDES, METHOD FOR PREPARING THEREOF AND USE OF THE SAME
<b>A01N 35/04</b> (2006.01)	3793358	ANTIMICROBIAL COMPOSITION BASED ON POLYPHENOLS AND POLYSACCHARIDES, METHOD FOR PREPARING THEREOF AND USE OF THE SAME
<b>A01N 37/24</b> (2006.01)	3793358	ANTIMICROBIAL COMPOSITION BASED ON POLYPHENOLS AND POLYSACCHARIDES, METHOD FOR PREPARING THEREOF AND USE OF THE SAME
<b>A01N 65/12</b> (2009.01)	3793358	ANTIMICROBIAL COMPOSITION BASED ON POLYPHENOLS AND POLYSACCHARIDES, METHOD FOR PREPARING THEREOF AND USE OF THE SAME
<b>A01N 65/20</b> (2009.01)	3793358	ANTIMICROBIAL COMPOSITION BASED ON POLYPHENOLS AND POLYSACCHARIDES, METHOD FOR PREPARING THEREOF AND USE OF THE SAME
<b>A01N 65/48</b> (2009.01)	3793358	ANTIMICROBIAL COMPOSITION BASED ON POLYPHENOLS AND POLYSACCHARIDES, METHOD FOR PREPARING THEREOF AND USE OF THE SAME
<b>A01P 1/00</b> (2006.01)	3793358	ANTIMICROBIAL COMPOSITION BASED ON POLYPHENOLS AND POLYSACCHARIDES, METHOD FOR PREPARING THEREOF AND USE OF THE SAME
<b>A61K 9/20</b> (2006.01)	3793358	ANTIMICROBIAL COMPOSITION BASED ON POLYPHENOLS AND POLYSACCHARIDES, METHOD FOR PREPARING THEREOF AND USE OF THE SAME
<b>A61K 31/11</b> (2006.01)	3793358	ANTIMICROBIAL COMPOSITION BASED ON POLYPHENOLS AND POLYSACCHARIDES, METHOD FOR PREPARING THEREOF AND USE OF THE SAME
<b>A61K 31/167</b> (2006.01)	3793358	ANTIMICROBIAL COMPOSITION BASED ON POLYPHENOLS AND POLYSACCHARIDES, METHOD FOR PREPARING THEREOF AND USE OF THE SAME
<b>A61K 36/28</b> (2006.01)	3793358	ANTIMICROBIAL COMPOSITION BASED ON POLYPHENOLS AND POLYSACCHARIDES, METHOD FOR PREPARING THEREOF AND USE OF THE SAME
<b>A61K 36/484</b> (2006.01)	3793358	ANTIMICROBIAL COMPOSITION BASED ON POLYPHENOLS AND POLYSACCHARIDES, METHOD FOR PREPARING THEREOF AND USE OF THE SAME
<b>A61K 36/9062</b> (2006.01)	3793358	ANTIMICROBIAL COMPOSITION BASED ON POLYPHENOLS AND POLYSACCHARIDES, METHOD FOR PREPARING THEREOF AND USE OF THE SAME
<b>A61K 31/365</b> (2006.01)	3790545	METHODS AND COMPOSITIONS FOR THE TREATMENT OF SICKLE CELL DISEASES AND THALASSEMIA
<b>A61K 31/551</b> (2006.01)	3790545	METHODS AND COMPOSITIONS FOR THE TREATMENT OF SICKLE CELL DISEASES AND THALASSEMIA
<b>A61K 45/06</b> (2006.01)	3790545	METHODS AND COMPOSITIONS FOR THE TREATMENT OF SICKLE CELL DISEASES AND THALASSEMIA
<b>A61P 3/00</b> (2006.01)	3787746	CANNABINOID RECEPTOR TYPE 1 (CB1) BINDING PROTEINS AND USES THEREOF
<b>C07K 16/28</b> (2006.01)	3787746	CANNABINOID RECEPTOR TYPE 1 (CB1) BINDING PROTEINS AND USES THEREOF
<b>A61K 9/28</b> (2006.01)	3662900	COLONIC DRUG DELIVERY FORMULATION
<b>A61K 31/606</b> (2006.01)	3662900	COLONIC DRUG DELIVERY FORMULATION
<b>A61K 9/20</b> (2006.01)	3662898	SOLID COMPOSITION COMPRISING MESALAZINE
<b>A61K 9/28</b> (2006.01)	3662898	SOLID COMPOSITION COMPRISING MESALAZINE
<b>A61K 31/606</b> (2006.01)	3662898	SOLID COMPOSITION COMPRISING MESALAZINE

MKP (51)	Broj objave evropske prijave patenta (97)	Naziv pronalaska (54)
<b>A61K 9/16</b> (2006.01)	3662895	A PROCESS FOR MANUFACTURING REDUCING SUGAR-FREE 5-ASA TABLET CORES
<b>A61K 9/20</b> (2006.01)	3662895	A PROCESS FOR MANUFACTURING REDUCING SUGAR-FREE 5-ASA TABLET CORES
<b>A61K 31/606</b> (2006.01)	3662895	A PROCESS FOR MANUFACTURING REDUCING SUGAR-FREE 5-ASA TABLET CORES
<b>A61K 9/20</b> (2006.01)	3662901	DELAYED RELEASE DRUG FORMULATION COMPRISING AN OUTERLAYER WITH AN ENZYMATICYAALY DEGRADABLE POLYMER, ITS COMPOSITION AND ITS METHOD OF MANUFACTURING
<b>A61K 9/28</b> (2006.01)	3662901	DELAYED RELEASE DRUG FORMULATION COMPRISING AN OUTERLAYER WITH AN ENZYMATICYAALY DEGRADABLE POLYMER, ITS COMPOSITION AND ITS METHOD OF MANUFACTURING
<b>A61K 9/48</b> (2006.01)	3662901	DELAYED RELEASE DRUG FORMULATION COMPRISING AN OUTERLAYER WITH AN ENZYMATICYAALY DEGRADABLE POLYMER, ITS COMPOSITION AND ITS METHOD OF MANUFACTURING
<b>A61K 31/606</b> (2006.01)	3662901	DELAYED RELEASE DRUG FORMULATION COMPRISING AN OUTERLAYER WITH AN ENZYMATICYAALY DEGRADABLE POLYMER, ITS COMPOSITION AND ITS METHOD OF MANUFACTURING
<b>A61K 9/28</b> (2006.01)	3662902	COLONIC DRUG DELIVERY FORMULATION
<b>F04C 18/02</b> (2006.01)	3667086	SPIRAL-TYPE DISPLACEMENT MACHINE, IN PARTICULAR A DISPLACEMENT MACHINE FOR A VEHICLE AIR-CONDITIONING SYSTEM
<b>F04C 27/00</b> (2006.01)	3667086	SPIRAL-TYPE DISPLACEMENT MACHINE, IN PARTICULAR A DISPLACEMENT MACHINE FOR A VEHICLE AIR-CONDITIONING SYSTEM
<b>F04C 29/00</b> (2006.01)	3667086	SPIRAL-TYPE DISPLACEMENT MACHINE, IN PARTICULAR A DISPLACEMENT MACHINE FOR A VEHICLE AIR-CONDITIONING SYSTEM

**INDEKS PODNOSILACA ZAHTJEVA ZA PROŠIRENJE EVROPSKIH PRIJAVA  
PATENTA**

**Index on number of applications for extension of european patent application**

Podnosilac evropske prijave patenta (71)	MKP (51)	Broj objave evropske prijave patenta (97)	Naziv pronalaska (54)
	<b>A61K 9/20</b> (2006.01)	3162362	OPTIMIZED HIGH-DOSE TABLET OF MESALAZINE
	<b>A61K 9/28</b> (2006.01)		
	<b>A61K 31/606</b> (2006.01)		
	<b>A61B 18/00</b> (2006.01)	3153124	CATHETER WITH MEMBRANED SPINES FOR PULMONARY VEIN ISOLATION
	<b>A61B 18/02</b> (2006.01)		
	<b>A61B 18/14</b> (2006.01)		
	<b>A23L 2/52</b> (2006.01)	3250052	A NATURAL SWEETENING COMPOSITION OF LUO HAN GUO
	<b>A23L 2/60</b> (2006.01)		
	<b>A23L 27/12</b> (2016.01)		
	<b>A23L 2/52</b> (2006.01)	3250053	A Natural Sweetener
	<b>A23L 2/60</b> (2006.01)		
	<b>A23L 27/12</b> (2016.01)		
	<b>G10K 11/178</b> (2006.01)	3644620	IN-EAR ANC EARPHONE
	<b>H04R</b> (2006.01)		
	<b>H04R 1/10</b> (2006.01)		
	<b>H04R 1/28</b> (2006.01)		
	<b>A61K 39/395</b> (2006.01)	3679949	METHODS OF TREATING CONDITIONS WITH ANTIBODIES THAT BIND COLONY STIMULATING FACTOR 1 RECEPTOR (CSF1R)
	<b>A61P 19/02</b> (2006.01)		
	<b>A61P 29/00</b> (2006.01)		
	<b>C07K 16/28</b> (2006.01)		
	<b>C12Q 1/48</b> (2006.01)		
	<b>G01N 33/564</b> (2006.01)		
Frappa	<b>F25D 3/12</b> (2006.01)	3686524	COOLING SYSTEM FOR STORING AND COOLING PRODUCTS DURING TRANSPORT ON A REFRIGERATED TRANSPORT VEHICLE
	<b>F25D 11/00</b> (2006.01)		
	<b>F25D 17/06</b> (2006.01)		
	<b>F25D 29/00</b> (2006.01)		
	<b>A61K 39/395</b> (2006.01)	3536342	METHODS FOR TREATING OR PREVENTING INFLUENZA VIRUS INFECTION BY ADMINISTERING A SERINE PROTEASE INHIBITOR
	<b>A61P 31/16</b> (2006.01)		
	<b>F17C 6/00</b> (2006.01)	3693652	FILLING STATION FOR GAS BOTTLES AND MOTOR VEHICLES
	<b>A01H 5/06</b> (2018.01)	3696188	GENE FOR RESISTANCE TO PLANT DISEASE
	<b>A01H 6/02</b> (2018.01)		
	<b>C07K 14/415</b> (2006.01)		
	<b>C12N 15/82</b> (2006.01)		
Eggxyt Ltd	<b>A01K 67/027</b> (2006.01)	3629719	METHODS FOR GENDER DETERMINATION OF AVIAN EMBRYOS IN UNHATCHED EGGS AND MEANS THEREOF
	<b>C12N 9/02</b> (2006.01)		
	<b>C12N 15/10</b>		

Podnosilac evropske prijave patenta (71)	MKP (51)	Broj objave evropske prijave patenta (97)	Naziv pronalaska (54)
	(2006.01)		
	<b>C12N 15/90</b>		
	(2006.01)		
Pharmaceutical Oriented Services Ltd	<b>A61K 9/16</b>	3761965	TICAGRELOR-CONTAINING TABLET FORMULATION
Rontis Hellas S.A.	(2006.01)		
	<b>A61K 9/20</b>		
	(2006.01)		
Celttech-Paper Kft.	<b>C02F 1/34</b>	3762336	METHOD FOR THE CAVITATION CLEANING OF WATER-BASED SUBSTANCES AND EQUIPMENT FOR THE IMPLEMENTATION OF THE METHOD
	(2006.01)		MONITORING OPERATING CONDITIONS OF A ROTARY STEERABLE SYSTEM
	<b>E21B 7/04</b>	3781777	
	(2006.01)		
	<b>E21B 7/06</b>		
	(2006.01)		
	<b>E21B 23/04</b>	3794210	LINER HANGER SYSTEM
	(2006.01)		
	<b>E21B 43/10</b>		
	(2006.01)		
	<b>E21B 33/12</b>	3781781	TOOL FOR TESTING WITHIN A WELLBORE
	(2006.01)		
	<b>E21B 33/122</b>		
	(2006.01)		
	<b>E21B 33/124</b>		
	(2006.01)		
	<b>E21B 37/02</b>		
	(2006.01)		
	<b>E21B 49/00</b>		
	(2006.01)		
Kreca, Ivo	<b>F23B 80/04</b>	3765791	PROCESS AND DEVICE FOR IMPROVING OF SYNTHESIS AND/OR FLUE GAS VELOCITY FIELD FOR REFUSE DERIVED FUEL APPLICATIONS
	(2006.01)		
	<b>F23G 5/027</b>		
	(2006.01)		
	<b>F23G 5/16</b>		
	(2006.01)		
	<b>E21B 43/12</b>	3781782	CONTROLLING WATER INFLOW IN A WELLBORE
	(2006.01)		
	<b>E21B 43/14</b>		
	(2006.01)		
	<b>E21B 43/32</b>		
	(2006.01)		
	<b>E21B 47/10</b>		
	(2012.01)		
	<b>E21B 47/12</b>		
	(2012.01)		
	<b>A61K 38/18</b>	3586867	PLACENTA GROWTH FACTOR IN TREATING DUCHENNE MUSCULAR DYSTROPHY
	(2006.01)		
	<b>A61P 21/00</b>		
	(2006.01)		
	<b>C07K 14/515</b>		
	(2006.01)		
AbVitro LLC	<b>C12Q 1/6855</b>	3631012	HIGH-THROUGHPUT POLYNUCLEOTIDE LIBRARY SEQUENCING AND TRANSCRIPTOME ANALYSIS
	(2018.01)		
	<b>E21B 7/14</b>	3794211	LASER TOOL
	(2006.01)		
	<b>E21B 7/15</b>		
	(2006.01)		
	<b>E21B 43/11</b>		
	(2006.01)		
	<b>B65G 5/00</b>	3797080	MANAGING STORAGE OF WATER
	(2006.01)		
	<b>E21B 43/12</b>		
	(2006.01)		
	<b>E21B 43/26</b>	3797209	DOWNHOLE TOOL FOR FRACTURING A FORMATION CONTAINING HYDROCARBONS
	(2006.01)		
DELIVERY EAGLE AG	<b>B64C 39/02</b>	3770066	DRONE FOR LOW-NOISE DELIVERY OF OBJECTS
	(2006.01)		
	<b>A01N 1/02</b>	3775165	PROCESSES FOR PRODUCTION OF TUMOR INFILTRATING LYMPHOCYTES AND USES OF SAME IN IMMUNOTHERAPY
	(2006.01)		
	<b>A61K 35/17</b>		
	(2015.01)		

Podnosilac evropske prijave patenta (71)	MKP (51)	Broj objave evropske prijave patenta (97)	Naziv pronalaska (54)
Glöck Ökeenergie	<b>C12M 3/00</b> (2006.01)	3699322	ELECTROLYTIC CELL
	<b>C12N 5/0783</b> (2010.01)		
	<b>C25B 1/04</b> (2006.01)		
	<b>C25B 9/06</b> (2006.01)		
	<b>C25B 11/02</b> (2006.01)		
	<b>C25B 15/08</b> (2006.01)		
	<b>F02B 43/10</b> (2006.01)		
Came Go S.r.l.	<b>F02M 25/12</b> (2006.01)	3534343	LIGHT SIGNALING DEVICE APPLICABLE TO ACCESS PASSAGES
	<b>G08B 5/36</b> (2006.01)		
	<b>G08B 5/38</b> (2006.01)		
	<b>A61K 39/40</b> (2006.01)	3617227	NEUTRALISING ANTIBODIES TO THE MAJOR EXOTOXIN TCDA OF CLOSTRIDIUM DIFFICILE
	<b>A61P 31/04</b> (2006.01)	3536712	METHODS FOR REDUCING LIPOPROTEIN(A) LEVELS BY ADMINISTERING AN INHIBITOR OF PROPROTEIN CONVERTASE SUBTILISIN KEXIN-9 (PCSK9)
	<b>C07K 16/12</b> (2006.01)		
	<b>A61P 3/06</b> (2006.01)		
	<b>C07K 16/40</b> (2006.01)	3708990	FIBER OPTIC SENSOR UNIT, OPTICAL MEASURING SYSTEM, AXLE-COUNTING DEVICE AXLE-COUNTING METHOD
	<b>B61L 23/04</b> (2006.01)		
	<b>G01L 1/24</b> (2006.01)		
	<b>G01L 19/06</b> (2006.01)	3788231	CREATING FRACTURES IN A FORMATION USING ELECTROMAGNETIC SIGNALS
	<b>G01M 5/00</b> (2006.01)		
	<b>E21B 36/00</b> (2006.01)		
	<b>E21B 43/26</b> (2006.01)	3797206	LASER-INDUCED PLASMA TOOL
	<b>E21B 28/00</b> (2006.01)		
<b>E21B 43/00</b> (2006.01)			
<b>E21B 43/11</b> (2006.01)			
<b>E21B 43/26</b> (2006.01)			
<b>G01N 27/74</b> (2006.01)	3797290	DETECTING SATURATION LEVELS OF A CORE SAMPLE USING MAGNETIC FIELDS	
<b>G01N 33/28</b> (2006.01)			
King Abdullah University of Science and Technology	<b>G01V 3/10</b> (2006.01)	3791177	IDENTIFYING CONTENT IN A CONDUIT
	<b>G01N 22/00</b> (2006.01)		
	<b>G01N 33/18</b> (2006.01)		
	<b>G01N 33/24</b> (2006.01)		
	<b>G01N 33/28</b> (2006.01)		
Aquafortus Technologies Limited	<b>C01D 3/06</b> (2006.01)	3691996	A SALT RECOVERY SOLUTION AND PROCESSES OF USE THEREOF
	<b>C02F 1/26</b> (2006.01)	3699194	ANTIBODY CONSTRUCTS FOR CDH19 AND CD3
	<b>A61K 39/395</b> (2006.01)		



Podnosilac evropske prijave patenta (71)	MKP (51)	Broj objave evropske prijave patenta (97)	Naziv pronalaska (54)
	<b>A61K 47/68</b> (2017.01)		
	<b>A61P 35/00</b> (2006.01)		
	<b>C07K 16/28</b> (2006.01)		
	<b>C07K 16/30</b> (2006.01)		
	<b>C07K 16/46</b> (2006.01)		
	<b>A61K 31/437</b> (2006.01)	3689873	ESTROGEN RECEPTOR MODULATORS
	<b>A61K 31/501</b> (2006.01)		
	<b>A61K 31/506</b> (2006.01)		
	<b>A61P 35/00</b> (2006.01)		
	<b>C07D 471/04</b> (2006.01)		
	<b>A61K 31/55</b> (2006.01)	3660010	S1P MODULATING AGENTS
	<b>A61P 25/00</b> (2006.01)		
	<b>C07D 211/34</b> (2006.01)		
	<b>C07D 211/60</b> (2006.01)		
	<b>C07D 211/62</b> (2006.01)		
	<b>C07D 401/06</b> (2006.01)		
	<b>C07D 405/12</b> (2006.01)		
	<b>A61K 35/74</b> (2015.01)	3659613	COMPOSITIONS COMPRISING BACTERIAL STRAINS
	<b>A61P 29/00</b> (2006.01)		
	<b>A61P 35/00</b> (2006.01)		
	<b>C12Q 1/68</b> (2018.01)	3647783	IDENTIFYING PATIENT RESPONSE TO S1P RECEPTOR MODULATOR ADMINISTRATION
	<b>G01N 33/50</b> (2006.01)		
	<b>G01N 33/569</b> (2006.01)		
Eilon, Sali	<b>E04F 10/08</b> (2006.01)	3647510	SHADING SYSTEM
Osaka City University	<b>A61K 39/00</b> (2006.01)	3662931	THERAPEUTIC AGENT OR PROPHYLACTIC AGENT FOR DEMENTIA
	<b>A61K 39/395</b> (2006.01)		
	<b>A61P 25/28</b> (2006.01)		
	<b>C07K 14/47</b> (2006.01)		
	<b>C07K 16/18</b> (2006.01)		
	<b>C07K 16/46</b> (2006.01)		
	<b>C12N 15/02</b> (2006.01)		
	<b>C12P 21/08</b> (2006.01)		
	<b>A61K 31/7125</b> (2006.01)	3662912	IMPROVED DOSAGES OF ETEPLIRSEN FOR TREATING DUCHENNE MUSCULAR DYSTROPHY
	<b>A61P 21/00</b> (2006.01)		
	<b>A61K 31/395</b> (2006.01)	3686190	SYNTHESIS OF THERAPEUTICALLY ACTIVE COMPOUNDS

Podnosilac evropske prijave patenta (71)	MKP (51)	Broj objave evropske prijave patenta (97)	Naziv pronalaska (54)
	<b>A61P 35/00</b> (2006.01)		
	<b>C07D 251/18</b> (2006.01)		
	<b>C07D 401/04</b> (2006.01)		
	<b>C07D 403/04</b> (2006.01)		
	<b>C07D 405/14</b> (2006.01)		
	<b>C07D 409/04</b> (2006.01)		
	<b>C07D 417/04</b> (2006.01)		
	<b>A61P 1/04</b> (2006.01)	3686218	ANTI-BLOOD DENDRITIC CELL ANTIGEN 2 ANTIBODIES AND USES THEREOF
	<b>A61P 13/12</b> (2006.01)		
	<b>C07K 16/28</b> (2006.01)		
	<b>A61P 37/00</b> (2006.01)	3666796	ANTIBODIES AGAINST CLAUDIN 18.2 USEFUL IN CANCER DIAGNOSIS
	<b>C07K 16/30</b> (2006.01)		
	<b>A61K 39/395</b> (2006.01)	3670537	THERAPY INVOLVING ANTIBODIES AGAINST CLAUDIN 18.2 FOR TREATMENT OF CANCER
	<b>A61P 35/00</b> (2006.01)		
	<b>C07K 16/28</b> (2006.01)		
	<b>C07K 16/30</b> (2006.01)		
	<b>A61K 31/4184</b> (2006.01)	3702351	FORMULATION COMPRISING A MEK INHIBITOR
	<b>A61P 35/00</b> (2006.01)		
	<b>C07D 235/06</b> (2006.01)		
	<b>A61K 38/28</b> (2006.01)	3660040	INSULIN RECEPTOR PARTIAL AGONISTS
	<b>A61K 47/60</b> (2017.01)		
	<b>C07K 14/62</b> (2006.01)		
	<b>A61K 38/28</b> (2006.01)	3660041	INSULIN RECEPTOR PARTIAL AGONISTS
	<b>A61K 47/60</b> (2017.01)		
	<b>C07K 14/62</b> (2006.01)		
	<b>A61K 38/28</b> (2006.01)	3666792	INSULIN RECEPTOR PARTIAL AGONISTS
	<b>A61K 47/60</b> (2017.01)		
	<b>C07K 14/62</b> (2006.01)		
	<b>A61K 47/00</b> (2006.01)	3763738	ANTIBODIES BINDING AXL
	<b>A61P 35/00</b> (2006.01)		
	<b>C07K 16/28</b> (2006.01)		
	<b>A61K 39/00</b> (2006.01)	3685854	METHODS OF TREATING A TAUOPATHY
	<b>A61K 39/395</b> (2006.01)		
	<b>A61K 47/60</b> (2017.01)		
	<b>A61K 51/10</b> (2006.01)		

Podnosilac evropske prijave patenta (71)	MKP (51)	Broj objave evropske prijave patenta (97)	Naziv pronalaska (54)
Azienda Agrobufalina Ponterotto S.r.l. Società Agricola	<b>A61P 25/28</b> (2006.01)	3682798	TITRATION OF HEART RATE TO IMPROVE STIMULATION THERAPY FOR HEART FAILURE PATIENTS
	<b>C07K 16/18</b> (2006.01)		
	<b>C12N 15/63</b> (2006.01)		
	<b>G01N 33/68</b> (2006.01)		
	<b>A61B 5/00</b> (2006.01)		
	<b>A61B 5/024</b> (2006.01)		
	<b>A61B 5/0245</b> (2006.01)		
	<b>A61B 5/0456</b> (2006.01)		
	<b>A61B 5/0464</b> (2006.01)		
	<b>A61B 5/11</b> (2006.01)		
	<b>A61N 1/36</b> (2006.01)	3679802	FOOD PRODUCT BASED ON MOZZARELLA STUFFED WITH SMALL MOZZARELLA AND CREAM
	<b>G16H 40/63</b> (2018.01)		
	<b>A01J 25/12</b> (2006.01)	3689878	4-IMIDAZOPYRIDAZIN-1-YL-BENZAMIDES AND 4-IMIDAZOTRIAZIN-1-YL-BENZAMIDES AS BTK-INHIBITORS
	<b>A23C 19/068</b> (2006.01)		
	<b>A61K 31/4985</b> (2006.01)		
	<b>A61P 19/08</b> (2006.01)		
	<b>A61P 29/00</b> (2006.01)		
	<b>A61P 31/00</b> (2006.01)		
	<b>A61P 35/00</b> (2006.01)		
	<b>A61P 37/00</b> (2006.01)		
	<b>C07D 487/04</b> (2006.01)		
	<b>C07D 519/00</b> (2006.01)		
	<b>A61K 31/4965</b> (2006.01)	3693361	3,5-DIAMINO-6-CHLORO-N-(N-(4-(4-(2-(HEXYL(2,3,4,5,6-PENTA-HYDROXYHEXYL)AMINO)ETHOXY)PHENYL)BUTYL)CARBAMIMIDOYL)PYRAZINE-2-CARBOXAMIDE
	<b>A61P 11/00</b> (2006.01)		
	<b>C07D 239/48</b> (2006.01)	3690049	COMPOSITIONS AND METHODS FOR MODULATING APOLIPOPROTEIN C-III EXPRESSION
	<b>A61K 31/7088</b> (2006.01)		
	<b>A61K 31/713</b> (2006.01)		
<b>A61K 47/54</b> (2017.01)			
<b>A61K 47/59</b> (2017.01)			
<b>A61P 3/06</b> (2006.01)			
<b>A61P 25/00</b> (2006.01)			
<b>A61P 43/00</b> (2006.01)			
<b>C12N 15/113</b> (2010.01)			
<b>A61K 31/407</b> (2006.01)	3696183		
<b>A61P 25/16</b> (2006.01)			

Podnosilac evropske prijave patenta (71)	MKP (51)	Broj objave evropske prijave patenta (97)	Naziv pronalaska (54)		
Olivieri, Benedetto	<b>C07D 495/04</b> (2006.01)	3689344	HIGHLY WATER-SOLUBLE SALTS OF A SHORT ACTING PHENYLALKYLAMINE CALCIUM CHANNEL BLOCKER AND USES THEREOF		
	<b>A61K 9/00</b> (2006.01)				
	<b>A61K 9/08</b> (2006.01)				
	<b>A61K 31/277</b> (2006.01)				
	<b>A61K 47/12</b> (2006.01)				
	<b>A61K 47/18</b> (2017.01)				
	<b>A61K 47/20</b> (2006.01)				
	<b>A61P 9/00</b> (2006.01)				
	<b>A61P 9/06</b> (2006.01)				
	<b>A61P 9/10</b> (2006.01)				
	<b>A61P 25/06</b> (2006.01)				
	<b>C07C 255/42</b> (2006.01)				
	<b>A61P 37/06</b> (2006.01)			3696262	USE OF PDL1 EXPRESSING CELLS TO CONVERT T CELLS INTO REGULATORY T CELLS
	<b>C12N 5/0783</b> (2010.01)			3671503	GRAPHOMETRIC DOCUMENT SIGNING METHOD AND SYSTEM
	<b>G06F 21/32</b> (2013.01)				
<b>G06F 21/62</b> (2013.01)					
<b>G06F 21/64</b> (2013.01)	3693391	ANTI-CLL-1 ANTIBODIES AND IMMUNOCONJUGATES			
<b>H04L 9/32</b> (2006.01)					
<b>H04L 29/06</b> (2006.01)					
<b>A61K 31/00</b> (2006.01)					
<b>A61K 47/68</b> (2017.01)					
<b>A61K 51/00</b> (2006.01)					
<b>A61P 35/00</b> (2006.01)					
<b>A61P 35/02</b> (2006.01)					
<b>C07K 16/28</b> (2006.01)					
<b>C07K 16/30</b> (2006.01)					
The Scripps Research Institute	<b>A61K 39/395</b> (2006.01)	3693397	COILED COIL IMMUNOGLOBULIN FUSION PROTEINS AND COMPOSITIONS THEREOF		
	<b>A61K 47/65</b> (2017.01)				
	<b>A61P 35/00</b> (2006.01)				
	<b>C07K 16/10</b> (2006.01)				
	<b>C07K 16/46</b> (2006.01)				
	<b>C12N 15/62</b> (2006.01)				
	<b>A61K 9/00</b> (2006.01)			3630289	PHARMACEUTICAL COMBINATIONS OF ZONISAMIDE AND PRAXIPEXOLE, AND RELATED METHODS, FOR TREATING SYNUCLEINOPATHIES
<b>A61K 9/20</b> (2006.01)					
<b>A61K 31/423</b> (2006.01)					

Podnosilac evropske prijave patenta (71)	MKP (51)	Broj objave evropske prijave patenta (97)	Naziv pronalaska (54)		
Imara Inc.	<b>A61K 31/428</b> (2006.01)	3633187	WIND ENERGY CONVERSION MODULE		
	<b>A61P 25/00</b> (2006.01)				
	<b>A61P 25/16</b> (2006.01)				
	<b>A61P 25/28</b> (2006.01)				
	<b>A61P 43/00</b> (2006.01)				
	<b>F03D 5/04</b> (2006.01)				
	<b>F03D 7/00</b> (2006.01)				
	<b>F03D 7/02</b> (2006.01)				
	<b>A61K 31/13</b> (2006.01)			3630772	METHODS OF MAKING AND USING PDE9 INHIBITORS
	<b>A61K 31/27</b> (2006.01)				
	<b>A61K 31/444</b> (2006.01)				
	<b>C07D 487/04</b> (2006.01)			3630962	CBLB ENDONUCLEASE VARIANTS, COMPOSITIONS, AND METHODS OF USE
	<b>C07K 14/195</b> (2006.01)				
	<b>C07K 14/405</b> (2006.01)				
<b>C12N 9/04</b> (2006.01)					
<b>C12N 15/00</b> (2006.01)					
<b>C12N 15/53</b> (2006.01)					
<b>C12N 15/62</b> (2006.01)					
<b>C07C 311/07</b> (2006.01)	3630738	PROCESS FOR THE PRODUCTION OF OZANIMOD			
<b>C07D 271/06</b> (2006.01)	3674320	PRODUCTION OF HETERODIMERIC PROTEINS			
<b>C07K 16/28</b> (2006.01)					
<b>C07K 16/46</b> (2006.01)	3633549	FACIAL DETECTION TRAINING METHOD, APPARATUS AND ELECTRONIC DEVICE			
<b>G06K 9/62</b> (2006.01)					
Serdar Plastik Sanayi Ve Ticaret Anonim Sirketi	<b>A47L 15/42</b> (2006.01)	3631074	SELF-ADJUSTING LOCK SYSTEM		
	<b>D06F 39/00</b> (2020.01)	3629879	POLLUTION MEASURING SENSOR HOUSING		
	<b>D06F 39/14</b> (2006.01)				
	<b>E05B 15/02</b> (2006.01)				
	<b>E05B 15/04</b> (2006.01)				
	<b>E05B 47/00</b> (2006.01)				
	<b>E05C 3/24</b> (2006.01)				
	<b>E05C 5/02</b> (2006.01)				
	<b>A47L 15/42</b> (2006.01)				
	<b>D06F 34/22</b> (2020.01)				
<b>A47L 15/42</b> (2006.01)	3631253			STATIONARY SEALING GASKET	
Smith, Cédric	<b>A45D 19/02</b> (2006.01)	3799553	DEVICE IN THE FORM OF A PIECE OF FELT CONTAINING A COMPOSITION FOR INSTANTLY		

Podnosilac evropske prijave patenta (71)	MKP (51)	Broj objave evropske prijave patenta (97)	Naziv pronalaska (54)
	<b>A61K 8/92</b> (2006.01)		COLOURING WHITE BEARD HAIRS AND WHITE HAIRS
	<b>A61Q 5/06</b> (2006.01)		
	<b>E01B 29/32</b> (2006.01)	3783151	DEVICE FOR FIXING AND POSITIONING A RAIL MONITORING ELEMENT AND USE OF SAID DEVICE
	<b>B61L 3/00</b> (2006.01)	3782869	TRAIN CONTROL SYSTEM AND METHOD FOR CONTROLLING A TRAIN WITHIN A TRAIN CONTROL SYSTEM
	<b>B61L 27/00</b> (2006.01)		
P & P Industries AG	<b>C01B 17/765</b> (2006.01)	3792220	METHOD AND DEVICE FOR OBTAINING SULPHURIC ACID FROM CONTAMINATED SULPHUR-CONTAINING MEDIA
	<b>C01B 17/775</b> (2006.01)		
	<b>C01B 17/80</b> (2006.01)		
	<b>C01B 17/90</b> (2006.01)		
Grasso, Vincenzo	<b>E21D 9/00</b> (2006.01)	3795797	HIGH EFFICIENCY AND LOW ENVIRONMENTAL IMPACT TUNNELING SYSTEM
	<b>A61K 31/506</b> (2006.01)	3659621	COMBINATION THERAPIES FOR CANCER
	<b>A61K 39/395</b> (2006.01)		
	<b>A61P 35/00</b> (2006.01)		
	<b>C07K 16/28</b> (2006.01)		
Immutep S.A.S.	<b>A61P 35/00</b> (2006.01)	3660050	ANTIBODY MOLECULES TO LAG-3 AND USES THEREOF
	<b>C07K 16/28</b> (2006.01)		
	<b>A61B 17/00</b> (2006.01)	3785642	SPONGE-BASED VARIABLE-STIFFNESS NATURAL ORIFICE SURGERY INSTRUMENT SUPPORT STRUCTURE AND USE METHOD THEREFOR
Hefei Dappworks Technology Co., Ltd.	<b>H04L 29/06</b> (2006.01)	3793157	METHOD AND DEVICE FOR BLOCKCHAIN NODE
	<b>H04L 29/06</b> (2006.01)	3793158	METHOD AND DEVICE FOR REACHING CONSENSUS IN BLOCKCHAIN
	<b>B25J 9/16</b> (2006.01)	3793781	SYSTEM AND METHOD FOR CONTROLLING A ROBOTIC WRIST
Hermi, d.o.o.	<b>H02G 3/06</b> (2006.01)	3681001	CABLE TRAY CONNECTING DEVICE
Gnali Bocia S.r.l.	<b>A01M 15/00</b> (2006.01)	3770498	PORTABLE GAS TOOL
	<b>F23D 14/38</b> (2006.01)		
	<b>F23D 14/46</b> (2006.01)		
	<b>F23Q 3/00</b> (2006.01)		
	<b>G01K 1/14</b> (2021.01)	3795965	SUPPORT SYSTEM FOR SUPPORTING AN ENVIRONMENTAL TEMPERATURE SENSOR IN RAILWAY SECTOR
	<b>G01K 1/16</b> (2006.01)		
	<b>G16H 20/40</b> (2018.01)	3699921	OPTIMIZING CATHETERIZATION LABORATORY THROUGHPUT USING MACHINE LEARNING
	<b>G16H 40/20</b> (2018.01)		
MÁTÉ, Viktor	<b>A61L 2/08</b> (2006.01)	3781216	EQUIPMENT WITH RADIATION SOURCE FOR FACILITATING KILLING HARMFUL MICROORGANISMS, ESPECIALLY FOR FACILITATION OF CONSERVATION OF FOOD
	<b>H01J 61/00</b> (2006.01)		
	<b>A61K 31/517</b> (2006.01)	3762379	IDENTIFICATION AND USE OF ERK5 INHIBITORS
	<b>A61K 31/519</b> (2006.01)		
	<b>A61P 35/00</b> (2006.01)		
	<b>C07D 403/04</b>		

Podnosilac evropske prijave patenta (71)	MKP (51)	Broj objave evropske prijave patenta (97)	Naziv pronalaska (54)
	(2006.01) <b>C07D 403/14</b> (2006.01) <b>C07D 407/14</b> (2006.01) <b>C07D 487/04</b> (2006.01)		
	<b>A61M 5/315</b> (2006.01)	3762074	CONTROLLED DISPENSE SYRINGE
	<b>A61K 47/68</b> (2017.01)	3765493	ANTIBODIES
	<b>C07K 16/10</b> (2006.01)		
	<b>C07K 16/28</b> (2006.01)		
	<b>C07K 16/30</b> (2006.01)		
	<b>A61K 39/395</b> (2006.01)	3765508	TREATMENT OF HEAD AND NECK CANCER
	<b>A61P 35/00</b> (2006.01)		
	<b>C07K 16/28</b> (2006.01)		
Smivet B.V.	<b>C07K 16/12</b> (2006.01)	3765495	SINGLE DOMAIN ANTIBODIES BINDING TO TETANUS NEUROTOXIN
Tokai Carbon Savoie Metsol AG	<b>C25C 3/08</b> (2006.01)	3765657	CATHODE ASSEMBLY FOR ELECTROLYTIC CELL
	<b>C25C 3/16</b> (2006.01)		
	<b>C25C 7/00</b> (2006.01)		
	<b>C25C 7/02</b> (2006.01)		
	<b>A61K 31/7088</b> (2006.01)	3765477	5'-CAP-TRINUCLEOTIDE- OR HIGHER OLIGONUCLEOTIDE COMPOUNDS AND THEIR USES IN STABILIZING RNA, EXPRESSING PROTEINS AND IN THERAPY
	<b>A61K 48/00</b> (2006.01)		
	<b>C07H 21/02</b> (2006.01)		
	<b>C12N 5/07</b> (2010.01)		
	<b>C12N 15/11</b> (2006.01)		
	<b>A61K 31/16</b> (2006.01)	3765439	NOVEL CALCIUM SALT POLYMORPHS AS ANTI-INFLAMMATORY, IMMUNOMODULATORY AND ANTI-PROLIFERATORY AGENTS
	<b>A61P 37/00</b> (2006.01)		
	<b>C07C 233/60</b> (2006.01)		
EFB-Elektronik GmbH	<b>H05K 7/14</b> (2006.01)	3791701	RACK AND SERVER CABINET OR NETWORK CABINET HAVING A RACK
	<b>H05K 7/18</b> (2006.01)		
	<b>A61K 31/4025</b> (2006.01)	3762380	PHENYLPYRROLIDINONE FORMYL PEPTIDE 2 RECEPTOR AGONISTS
	<b>A61K 31/4439</b> (2006.01)		
	<b>A61K 31/506</b> (2006.01)		
	<b>A61P 9/00</b> (2006.01)		
	<b>C07D 207/14</b> (2006.01)		
	<b>C07D 401/10</b> (2006.01)		
	<b>C07D 401/12</b> (2006.01)		
	<b>C07D 403/10</b> (2006.01)		
	<b>C07D 403/12</b>		

Podnosilac evropske prijave patenta (71)	MKP (51)	Broj objave evropske prijave patenta (97)	Naziv pronalaska (54)
	(2006.01) <b>C07D 405/10</b> (2006.01) <b>C07D 409/12</b> (2006.01) <b>C07D 413/10</b> (2006.01) <b>C07D 413/14</b> (2006.01) <b>C07D 417/10</b> (2006.01) <b>C07F 9/02</b> (2006.01)		
KaNdy Therapeutics Limited	<b>A61K 31/5383</b> (2006.01) <b>A61P 25/00</b> (2006.01) <b>C07D 498/04</b> (2006.01)	3765024	NOVEL PHARMACEUTICAL FORMULATION COMPRISING DUAL NK-1/NK-3 RECEPTOR ANTAGONISTS
Electric Glass Fiber America, LLC	<b>C03C 3/087</b> (2006.01) <b>C03C 3/095</b> (2006.01) <b>C03C 3/112</b> (2006.01) <b>C03C 13/00</b> (2006.01) <b>C08J 5/08</b> (2006.01)	3762341	GLASS COMPOSITIONS, FIBERIZABLE GLASS COMPOSITIONS, AND GLASS FIBERS MADE THEREFROM
	<b>B26D 1/00</b> (2006.01) <b>B26D 1/06</b> (2006.01) <b>B26D 1/09</b> (2006.01) <b>B26D 3/08</b> (2006.01) <b>B26D 5/00</b> (2006.01) <b>B26D 5/06</b> (2006.01) <b>B26D 5/08</b> (2006.01) <b>B26D 7/01</b> (2006.01) <b>B65D 75/58</b> (2006.01)	3762195	INCISION STATION FOR PACKAGING MACHINE AND RELATIVE INCISION METHOD
	<b>A61K 31/4985</b> (2006.01) <b>A61P 25/00</b> (2006.01) <b>C07D 487/04</b> (2006.01)	3762389	CRYSTALLINE FORMS OF AN SGC STIMULATOR
	<b>A61M 5/14</b> (2006.01) <b>A61M 5/142</b> (2006.01)	3762067	BACKFLOW PREVENTION MECHANISM FOR DRUG DELIVERY DEVICE
	<b>A61K 31/7088</b> (2006.01) <b>A61P 25/28</b> (2006.01) <b>C07H 21/00</b> (2006.01) <b>C12N 15/113</b> (2010.01)	3765476	MODIFIED OLIGONUCLEOTIDES FOR USE IN TREATMENT OF TAUOPATHIES
Amgen (Europe) GmbH	<b>A61K 31/4035</b> (2006.01) <b>A61P 1/12</b> (2006.01)	3762365	METHODS AND COMPOSITIONS OF ISOINDOLINE-1,3-DIONE AND ISOINDOLE PRODRUGS USEFUL FOR TREATING CANCER, ULCERATIVE COLITIS AND RELATED INFLAMMATORY DISEASES



Podnosilac evropske prijave patenta (71)	MKP (51)	Broj objave evropske prijave patenta (97)	Naziv pronalaska (54)	
LONGCROFT, James Henry Stoddart	<b>C07D 209/48</b> (2006.01)	3768834	NOVEL RNA-PROGRAMMABLE ENDONUCLEASE SYSTEMS AND USES THEREOF	
	<b>C12N 9/22</b> (2006.01)			
	<b>C12N 15/10</b> (2006.01)			
The Trustees of the University of Pennsylvania	<b>C08L 1/02</b> (2006.01)	3765563	BIODEGRADABLE COATINGS FOR BIODEGRADABLE SUBSTRATES	
	<b>C08L 7/02</b> (2006.01)			
	<b>C08L 21/00</b> (2006.01)			
Valitor, Inc.	<b>C07K 14/005</b> (2006.01)	3768695	NOVEL ADENO-ASSOCIATED VIRUS (AAV) VECTORS, AAV VECTORS HAVING REDUCED CAPSID DEAMIDATION AND USES THEREFOR	
	<b>C12N 15/864</b> (2006.01)			
Avrobio, Inc.	<b>A61K 38/00</b> (2006.01)	3762036	MULTIVALENT PEPTIDE CONJUGATES FOR SUSTAINED INTRA-ARTICULAR TREATMENT OF JOINT INFLAMMATION	
	<b>A61K 47/00</b> (2006.01)			
	<b>H01B 5/10</b> (2006.01)	3762949	OVERHEAD ELECTRICAL CABLES AND METHOD FOR FABRICATING SAME	
	<b>H01B 7/18</b> (2006.01)			
	<b>H01B 9/00</b> (2006.01)			
	Avrobio, Inc.	<b>H01B 13/02</b> (2006.01)	3762400	ANTI-CD252 ANTIBODIES, CONJUGATES, AND METHODS OF USE
		<b>A61K 39/395</b> (2006.01)		
<b>C07K 7/64</b> (2006.01)				
<b>C07K 16/28</b> (2006.01)				
<b>A61K 35/28</b> (2015.01)				
Maztech Industries, LLC	<b>A61K 48/00</b> (2006.01)	3762505	COMPOSITIONS AND METHODS FOR TREATING PARKINSON'S DISEASE	
	<b>C12Q 1/34</b> (2006.01)			
	<b>C07K 16/18</b> (2006.01)	3762414	ASSAYS TO DETECT NEURODEGENERATION	
	<b>G01N 33/53</b> (2006.01)			
	<b>G01N 33/58</b> (2006.01)	3762032	ANTI-TISSUE FACTOR ANTIBODY-DRUG CONJUGATES AND THEIR USE IN THE TREATMENT OF CANCER	
	<b>A61K 39/395</b> (2006.01)			
	<b>A61P 35/00</b> (2006.01)			
	<b>C07K 16/28</b> (2006.01)			
	Pliant Therapeutics, Inc.	<b>A61K 38/17</b> (2006.01)	3762015	METHODS OF TREATING CROHN'S DISEASE WITH ANTI-IL23 SPECIFIC ANTIBODY
		<b>A61K 39/395</b> (2006.01)		
<b>A61P 37/02</b> (2006.01)		3762674	FIREARM AMMUNITION AVAILABILITY DETECTION SYSTEM	
<b>C07K 14/54</b> (2006.01)				
<b>C07K 16/24</b> (2006.01)				
<b>F41A 9/62</b> (2006.01)				
<b>G01D 5/12</b> (2006.01)				
<b>A61K 31/4375</b> (2006.01)	3761980	AMINO ACID COMPOUNDS AND METHODS OF USE		
<b>C07D 401/12</b> (2006.01)				

Podnosilac evropske prijave patenta (71)	MKP (51)	Broj objave evropske prijave patenta (97)	Naziv pronalaska (54)
Fundació Privada Institut d'Investigació Oncològica de Vall-Hebron Fundació Privada Institució Catalana de Recerca i Estudis Avançats	<b>A61K 39/395</b> (2006.01) <b>A61P 35/00</b> (2006.01) <b>C07K 16/24</b> (2006.01)	3794031	ANTIBODIES AGAINST LIF AND DOSAGE FORMS THEREOF
	<b>A61K 39/395</b> (2006.01) <b>A61P 35/02</b> (2006.01) <b>C07K 16/28</b> (2006.01) <b>C07K 16/30</b> (2006.01)	3765524	ANTIBODIES THAT BIND CD39 AND USES THEREOF
Intergalactic Therapeutics, Inc.	<b>A61K 31/513</b> (2006.01) <b>A61K 48/00</b> (2006.01) <b>C12N 15/85</b> (2006.01)	3765023	SYNTHETIC DNA VECTORS AND METHODS OF USE
INDIANA UNIVERSITY RESEARCH AND TECHNOLOGY CORPORATION UNITED STATES GOVERNMENT as represented by THE DEPARTMENT OF VETERANS AFFAIRS	<b>C12Q 1/68</b> (2018.01) <b>G01N 33/50</b> (2006.01) <b>G01N 33/68</b> (2006.01)	3765630	PRECISION MEDICINE FOR PAIN: DIAGNOSTIC BIOMARKERS, PHARMACOGENOMICS, AND REPURPOSED DRUGS
	<b>A01N 43/76</b> (2006.01) <b>A01N 43/90</b> (2006.01) <b>A01N 47/02</b> (2006.01) <b>A01P 7/04</b> (2006.01) <b>A61K 31/506</b> (2006.01) <b>A61P 33/00</b> (2006.01) <b>A61P 33/14</b> (2006.01) <b>C07D 413/04</b> (2006.01) <b>C07D 413/14</b> (2006.01) <b>C07D 471/04</b> (2006.01) <b>C07F 7/10</b> (2006.01)	3766881	HETEROARYL PYRIMIDINE COMPOUND AND PEST CONTROL AGENT
Massachusetts Institute of Technology	<b>A61K 31/7088</b> (2006.01) <b>A61K 47/64</b> (2017.01)	3765030	CHIMERIC PEPTIDES FOR ANTISENSE DELIVERY
Escalier Biosciences B.V.	<b>A61K 31/495</b> (2006.01) <b>A61P 17/00</b> (2006.01) <b>C07D 295/04</b> (2006.01)	3765020	SPIROCYCLIC ROR-GAMMA MODULATORS
	<b>A61K 51/04</b> (2006.01) <b>A61P 35/00</b> (2006.01) <b>C07F 13/00</b> (2006.01)	3766893	177LU-DOTA-HYNIC-IPSMAs AS A THERAPEUTIC RADIOPHARMACEUTICAL TARGETING PROSTATE-SPECIFIC MEMBRANE ANTIGEN
	<b>A61K 31/497</b> (2006.01)	3762368	AMINOPYRAZINE DIOL COMPOUNDS AS PI3K-Y INHIBITORS

Podnosilac evropske prijave patenta (71)	MKP (51)	Broj objave evropske prijave patenta (97)	Naziv pronalaska (54)
MEI Pharma, Inc.	<b>A61P 35/00</b> (2006.01)		
	<b>C07D 241/20</b> (2006.01)		
	<b>C07D 241/28</b> (2006.01)		
	<b>C07D 403/04</b> (2006.01)		
	<b>C07D 403/08</b> (2006.01)		
	<b>C07D 403/14</b> (2006.01)		
	<b>C07D 405/12</b> (2006.01)		
	<b>C07D 413/04</b> (2006.01)		
	<b>C07D 413/14</b> (2006.01)		
	<b>C07D 417/04</b> (2006.01)		
	<b>A01K 47/00</b> (2006.01)	3787398	BEE-MOVEMENT REGULATION DEVICE FOR BEEHIVES
	<b>A01K 47/06</b> (2006.01)		
	<b>C12N 5/079</b> (2010.01)	3768841	METHODS OF TREATING TTR AMYLOIDOSIS USING AG10
	<b>C12N 15/113</b> (2010.01)		
	<b>C12Q 1/68</b> (2018.01)		
	<b>A61K 31/4184</b> (2006.01)	3768258	COMBINATION THERAPY
	<b>A61K 31/519</b> (2006.01)		
	<b>A61P 35/00</b> (2006.01)		
	<b>A61K 38/07</b> (2006.01)	3768325	METHODS OF TREATING CANCER WITH A COMBINATION OF A PLATINUM-BASED AGENT AND AN ANTI-TISSUE FACTOR ANTIBODY-DRUG CONJUGATE
	<b>A61K 47/68</b> (2017.01)		
	<b>A61P 35/00</b> (2006.01)		
	<b>C07K 16/36</b> (2006.01)		
	<b>A61K 39/395</b> (2006.01)	3768314	ANTIBODIES AGAINST SIGNAL-REGULATORY PROTEIN ALPHA AND METHODS OF USE
	<b>A61P 29/00</b> (2006.01)		
	<b>A61P 35/00</b> (2006.01)		
	<b>A61P 37/06</b> (2006.01)		
	<b>C07K 16/28</b> (2006.01)		
<b>A61K 31/495</b> (2006.01)	3768269	COMPOUNDS AND USES THEREOF	
<b>C07D 257/02</b> (2006.01)			
<b>A61K 9/10</b> (2006.01)	3769765	PHARMACEUTICAL COMPOSITION INCLUDING SODIUM ALKYL SULFATE	
<b>A61K 9/14</b> (2006.01)			
<b>A61K 9/16</b> (2006.01)			
<b>A61K 9/20</b> (2006.01)			
<b>A61K 9/48</b> (2006.01)			
<b>A61K 31/519</b> (2006.01)			

Podnosilac evropske prijave patenta (71)	MKP (51)	Broj objave evropske prijave patenta (97)	Naziv pronalaska (54)
Cleantech Geomechanics Inc.	<b>A61K 47/20</b> (2006.01)	3768317	ANTI-IL-27 ANTIBODIES AND USES THEREOF
	<b>A61K 47/26</b> (2006.01)		
	<b>A61K 47/32</b> (2006.01)		
	<b>A61K 47/38</b> (2006.01)	3768615	SYSTEM AND METHOD FOR COMPRESSED AIR ENERGY STORAGE
	<b>A61K 38/20</b> (2006.01)		
	<b>A61K 39/395</b> (2006.01)		
	<b>C07K 14/54</b> (2006.01)	3768330	METHODS OF ENHANCING PERSISTENCE OF ADOPTIVELY INFUSED T CELLS
	<b>C07K 16/24</b> (2006.01)		
	<b>B65G 5/00</b> (2006.01)		
	<b>E21F 17/16</b> (2006.01)	3782986	HETEROCYCLIC COMPOUND
	<b>A61K 39/12</b> (2006.01)		
	<b>A61K 48/00</b> (2006.01)		
	<b>C12N 5/09</b> (2010.01)	3782986	HETEROCYCLIC COMPOUND
	<b>C12N 15/86</b> (2006.01)		
	<b>G01N 33/50</b> (2006.01)		
	<b>G01N 33/569</b> (2006.01)	3782986	HETEROCYCLIC COMPOUND
	<b>A61K 31/44</b> (2006.01)		
	<b>A61K 31/443</b> (2006.01)		
	<b>A61K 31/4433</b> (2006.01)	3782986	HETEROCYCLIC COMPOUND
	<b>A61K 31/4439</b> (2006.01)		
	<b>A61K 31/444</b> (2006.01)		
	<b>A61K 31/4545</b> (2006.01)	3782986	HETEROCYCLIC COMPOUND
	<b>A61K 31/496</b> (2006.01)		
	<b>A61K 31/497</b> (2006.01)		
	<b>A61K 31/501</b> (2006.01)	3782986	HETEROCYCLIC COMPOUND
	<b>A61K 31/506</b> (2006.01)		
	<b>A61K 31/517</b> (2006.01)		
	<b>A61K 31/5377</b> (2006.01)	3782986	HETEROCYCLIC COMPOUND
	<b>A61K 31/5383</b> (2006.01)		
	<b>A61K 31/541</b> (2006.01)		
	<b>A61K 31/55</b> (2006.01)	3782986	HETEROCYCLIC COMPOUND
	<b>A61K 31/551</b> (2006.01)		
	<b>A61K 31/553</b> (2006.01)		
<b>A61K 31/554</b> (2006.01)	3782986	HETEROCYCLIC COMPOUND	
<b>A61P 35/00</b> (2006.01)			
<b>A61K 31/554</b> (2006.01)			

Podnosilac evropske prijave patenta (71)	MKP (51)	Broj objave evropske prijave patenta (97)	Naziv pronalaska (54)				
Todo, Tomoki	<b>A61P 43/00</b> (2006.01)	3789489	SWELLING INHIBITOR-TYPE ONCOLYTIC VIRUS				
	<b>C07D 213/85</b> (2006.01)						
	<b>A61K 35/76</b> (2015.01)						
	<b>A61P 35/00</b> (2006.01)						
	<b>C07K 16/22</b> (2006.01)						
	<b>C12N 7/01</b> (2006.01)						
	<b>C12N 15/13</b> (2006.01)						
	<b>A61K 35/17</b> (2015.01)						
	<b>C07K 16/28</b> (2006.01)						
	<b>A61K 31/04</b> (2006.01)						
Promab Biotechnologies, Inc. Forevertex Biotechnology Co., Ltd North Carolina State University	<b>A61K 31/4025</b> (2006.01)	3773630	BCMA-CAR-T CELLS				
	<b>A61K 31/70</b> (2006.01)	3765029	ROS-RESPONSIVE MICRONEEDLE PATCH FOR ACNE VULGARIS TREATMENT				
	<b>A61K 35/763</b> (2015.01)						
	<b>C12N 5/07</b> (2010.01)						
	<b>C12N 5/10</b> (2006.01)						
	<b>C12N 7/00</b> (2006.01)						
	<b>A61K 8/30</b> (2006.01)			3781188	ADOPTIVE CELLULAR THERAPY		
	<b>A61K 8/65</b> (2006.01)						
	<b>A61K 9/06</b> (2006.01)						
	<b>A61K 31/203</b> (2006.01)						
<b>A61K 31/785</b> (2006.01)							
<b>A61K 47/69</b> (2017.01)							
<b>A61P 17/14</b> (2006.01)	3768226	USE OF MICRONEEDLE PATCH TO PROMOTE HAIR GROWTH					
<b>A61K 31/4375</b> (2006.01)							
<b>C07D 207/04</b> (2006.01)							
<b>C07D 471/04</b> (2006.01)							
<b>A61K 31/444</b> (2006.01)			3773573	ANTAGONISTS OF HUMAN INTEGRIN (ALPHA4)(BETA7)			
<b>A61K 31/4545</b> (2006.01)							
<b>A61K 31/4745</b> (2006.01)							
<b>A61K 31/502</b> (2006.01)							
<b>A61P 35/00</b> (2006.01)							
<b>C07D 471/10</b> (2006.01)					3784671	DUAL ATM AND DNA-PK INHIBITORS FOR USE IN ANTI-TUMOR THERAPY	
<b>A61K 31/401</b> (2006.01)							
<b>A61P 25/02</b> (2006.01)							
XRad Therapeutics, Inc.	<b>A61K 31/401</b> (2006.01)	3781157					METHODS OF TREATING NEUROPATHIC PAIN
			<b>A61K 31/401</b> (2006.01)				

Podnosilac evropske prijave patenta (71)	MKP (51)	Broj objave evropske prijave patenta (97)	Naziv pronalaska (54)			
MITSUBISHI GAS CHEMICAL COMPANY, INC.	<b>B32B 15/092</b> (2006.01)	3783043	THERMOSETTING COMPOSITION, PREPREG, LAMINATE, METAL FOIL-CLAD LAMINATE, PRINTED WIRING BOARD, AND MULTILAYER PRINTED WIRING BOARD			
	<b>C08G 59/32</b> (2006.01)					
	<b>C08J 5/24</b> (2006.01)					
	<b>C08K 3/013</b> (2018.01)					
	<b>C08K 5/13</b> (2006.01)					
	<b>C08L 63/00</b> (2006.01)					
	<b>H05K 1/03</b> (2006.01)					
	<b>H05K 3/46</b> (2006.01)					
	<b>A61K 35/17</b> (2015.01)			3781177	REPROGRAMMING CD4 T CELLS INTO CYTOTOXIC CD8 CELLS BY FORCED EXPRESSION OF CD8AB AND CLASS 1 RESTRICTED T CELL RECEPTORS	
	<b>C07K 14/705</b> (2006.01)					
	<b>C07K 14/715</b> (2006.01)					
	<b>C07K 14/725</b> (2006.01)					
	<b>C12N 5/0783</b> (2010.01)					
	<b>C12N 5/10</b> (2006.01)					
	<b>C12N 15/10</b> (2006.01)					
	<b>C12N 15/86</b> (2006.01)					
	<b>C12N 15/867</b> (2006.01)					
<b>A61K 31/4184</b> (2006.01)	3782648	PREVENTATIVE AND THERAPEUTIC AGENTS FOR SARCOPEMIA				
<b>A61K 31/454</b> (2006.01)						
<b>A61K 31/5377</b> (2006.01)						
<b>A61K 45/00</b> (2006.01)						
<b>A61P 21/00</b> (2006.01)						
<b>A61P 43/00</b> (2006.01)						
<b>A61B 6/00</b> (2006.01)			3784132	IMAGING DEVICES		
<b>G01T 1/20</b> (2006.01)						
<b>G01T 1/24</b> (2006.01)						
<b>H01L 25/065</b> (2006.01)						
<b>H01L 27/146</b> (2006.01)						
<b>A61K 31/422</b> (2006.01)	3784234	COMPOUNDS AND USES THEREOF				
<b>A61P 35/00</b> (2006.01)						
<b>C07D 263/48</b> (2006.01)						
<b>A61K 35/28</b> (2015.01)					3784258	ARTIFICIAL EXOSOME COMPOSITION AND RELATED METHODS
<b>C12N 15/861</b> (2006.01)						
<b>C12N 15/88</b> (2006.01)						
<b>C07K 16/18</b> (2006.01)			3784699	OPTIMIZED ANTI-TL1A ANTIBODIES		

Podnosilac evropske prijave patenta (71)	MKP (51)	Broj objave evropske prijave patenta (97)	Naziv pronalaska (54)
pH Pharma Co., Ltd.	<b>C07K 16/28</b> (2006.01)	3784241	TRICYCLIC HETEROCYCLE COMPOUNDS USEFUL AS HIV INTEGRASE INHIBITORS
	<b>A61K 31/4985</b> (2006.01)		
	<b>C07D 487/16</b> (2006.01)		
pH Pharma Co., Ltd.	<b>C07D 239/70</b> (2006.01)	3784657	USE OF NEUTROPHIL ELASTASE INHIBITORS IN LIVER DISEASE
	<b>C07D 401/10</b> (2006.01)		
	<b>C07D 403/10</b> (2006.01)		
Neurimmune AG	<b>C07K 5/06</b> (2006.01)	3797114	HUMAN-DERIVED ANTI-(POLY-GA) DIPEPTIDE REPEAT (DPR) ANTIBODY
	<b>C07K 16/44</b> (2006.01)		
Cyberware Inc.	<b>G06F 21/32</b> (2013.01)	3770780	IDENTIFICATION SYSTEM, METHOD, AND PROGRAM
	<b>G06T 7/00</b> (2017.01)		
Sunsho Pharmaceutical Co., Ltd.	<b>A24D 3/06</b> (2006.01)	3711497	SEAMLESS CAPSULE, AND FILTER AND SMOKING DEVICE INCLUDING SAME
	<b>E05B 19/18</b> (2006.01)		
Salimov, Ildar Ibragimovich	<b>E05B 63/00</b> (2006.01)	3789569	KEY HAVING A CATCH AND A REPLACEABLE BLADE, LOCK, AND OPERATING METHOD THEREOF (VARIANTS)
	<b>B65B 35/30</b> (2006.01)		
Cyberdontics (USA), Inc.	<b>B65G 47/08</b> (2006.01)	3787988	GROUPING STATION FOR GROUPING PALLETS
	<b>B65G 47/54</b> (2006.01)		
	<b>B65G 47/56</b> (2006.01)		
	<b>B65G 47/57</b> (2006.01)		
	<b>A61B 18/20</b> (2006.01)		
	<b>A61B 34/20</b> (2016.01)		
	<b>A61C 1/00</b> (2006.01)		
	<b>A61C 1/02</b> (2006.01)		
	<b>A61K 39/395</b> (2006.01)		
	<b>C07K 16/28</b> (2006.01)		
<b>C07K 16/36</b> (2006.01)	3790492	AUTOMATED DENTAL DRILL	
<b>C12N 15/113</b> (2010.01)			
<b>A61K 31/7088</b> (2006.01)	3790584	METHODS OF TREATING CANCER WITH A COMBINATION OF AN ANTI-PD-1 ANTIBODY AND AN ANTI-TISSUE FACTOR ANTIBODY-DRUG CONJUGATE	
<b>A61P 37/00</b> (2006.01)			
<b>C12N 1/15</b> (2006.01)	3799602	COMPOUNDS AND METHODS FOR REDUCING ATXN3 EXPRESSION	
<b>C12N 1/19</b> (2006.01)			
<b>C12N 1/21</b> (2006.01)			
<b>C12N 5/10</b> (2006.01)			
<b>C12N 15/12</b> (2006.01)			
<b>C12N 15/62</b> (2006.01)			
<b>C12N 15/63</b> (2006.01)			
<b>C12N 15/63</b> (2006.01)			
<b>C12N 15/63</b> (2006.01)			
<b>C12N 15/63</b> (2006.01)			

Podnosilac evropske prijave patenta (71)	MKP (51)	Broj objave evropske prijave patenta (97)	Naziv pronalaska (54)
	<b>A61K 31/7088</b> (2006.01) <b>A61P 37/08</b> (2006.01) <b>C12N 1/15</b> (2006.01) <b>C12N 1/19</b> (2006.01) <b>C12N 1/21</b> (2006.01) <b>C12N 5/10</b> (2006.01) <b>C12N 15/62</b> (2006.01) <b>C12N 15/63</b> (2006.01) <b>A61K 31/506</b> (2006.01) <b>A61P 31/20</b> (2006.01) <b>C07D 239/20</b> (2006.01) <b>C07D 403/04</b> (2006.01) <b>C07D 417/04</b> (2006.01) <b>A61K 31/437</b> (2006.01) <b>A61K 31/444</b> (2006.01) <b>A61K 31/4545</b> (2006.01) <b>A61K 31/46</b> (2006.01) <b>A61K 31/496</b> (2006.01) <b>A61K 31/497</b> (2006.01) <b>A61K 31/551</b> (2006.01) <b>A61P 3/10</b> (2006.01) <b>A61P 13/02</b> (2006.01) <b>A61P 13/10</b> (2006.01) <b>A61P 27/06</b> (2006.01) <b>A61P 43/00</b> (2006.01) <b>C07D 471/04</b> (2006.01) <b>C07D 519/00</b> (2006.01)	3792361	NUCLEIC ACID FOR TREATING CRUSTACEAN ALLERGY
	<b>A61C 1/00</b> (2006.01) <b>A61C 3/04</b> (2006.01) <b>A61C 5/80</b> (2017.01) <b>A61C 19/00</b> (2006.01)	3790866	DIHYDROPYRIMIDINE DERIVATIVES AND USES THEREOF IN THE TREATMENT OF HBV INFECTION OR OF HBV-INDUCED DISEASES
	<b>C07K 14/36</b> (2006.01) <b>C12N 9/00</b> (2006.01) <b>C12N 15/52</b> (2006.01) <b>C12N 15/63</b> (2006.01)	3792260	AZABENZIMIDAZOLE COMPOUNDS AND PHARMACEUTICAL
Cyberdontics Inc.	<b>A61C 1/00</b> (2006.01) <b>A61C 3/04</b> (2006.01) <b>A61C 5/80</b> (2017.01) <b>A61C 19/00</b> (2006.01)	3790493	APPARATUS AND METHOD FOR DENTAL CLAMPING
National University Corporation Hokkaido University	<b>C07K 14/36</b> (2006.01) <b>C12N 9/00</b> (2006.01) <b>C12N 15/52</b> (2006.01) <b>C12N 15/63</b> (2006.01)	3792349	PEPTIDE MACROCYCLASE



Podnosilac evropske prijave patenta (71)	MKP (51)	Broj objave evropske prijave patenta (97)	Naziv pronalaska (54)	
Equisperes Inc.	<b>B22F 1/00</b> (2006.01)	3790692	ADDITIVE MANUFACTURING POWDER AND ADDITIVE MANUFACTURING PART MADE USING SAME	
	<b>B22F 3/00</b> (2021.01)			
	<b>B22F 9/08</b> (2006.01)			
	<b>B33Y 70/00</b> (2020.01)	3799604	COMPOUNDS AND METHODS FOR REDUCING FXI EXPRESSION	
	<b>A61K 31/70</b> (2006.01)			
	<b>C12N 15/113</b> (2010.01)	3790587	METHODS OF TREATING DEPRESSION USING IL-23 ANTIBODIES	
	<b>A61K 39/395</b> (2006.01)			
	<b>A61P 25/00</b> (2006.01)			
	<b>A61P 37/00</b> (2006.01)			
	<b>C07K 16/24</b> (2006.01)			
<b>C12N 15/13</b> (2006.01)	3793974	CRYSTALLINE FORMS OF 1-(ACYLOXY)-ALKYL CARBAMATE DRUG CONJUGATES OF NAPROXEN AND PREGABALIN		
<b>A61K 31/19</b> (2006.01)				
<b>A61P 25/00</b> (2006.01)				
<b>C07C 229/00</b> (2006.01)				
<b>A61K 39/395</b> (2006.01)			3793602	TREATMENT OF AGING-ASSOCIATED DISEASE WITH MODULATORS OF LEUKOTRIENE A4 HYDROLASE
<b>A61P 25/00</b> (2006.01)				
<b>A61P 25/28</b> (2006.01)				
<b>C07K 16/40</b> (2006.01)	3793547	MAGL INHIBITORS		
<b>A61K 31/41</b> (2006.01)				
<b>A61K 31/4164</b> (2006.01)				
Microbix Biosystems Inc.	<b>A61K 31/4192</b> (2006.01)	3794147	QUALITY CONTROL COMPOSITIONS AND WHOLE ORGANISM CONTROL MATERIALS FOR USE IN NUCLEIC ACID TESTING	
	<b>C12Q 1/68</b> (2018.01)			
	<b>C12Q 1/6806</b> (2018.01)			
	<b>C12Q 1/6809</b> (2018.01)			
	<b>C12Q 1/6876</b> (2018.01)			
	<b>C12Q 1/6888</b> (2018.01)			
	<b>A61K 31/423</b> (2006.01)			3793552
<b>A61K 31/424</b> (2006.01)				
Energysource Minerals LLC	<b>A61P 25/28</b> (2006.01)	3793945	PROCESS FOR SELECTIVE ADSORPTION AND RECOVERY OF LITHIUM FROM NATURAL AND SYNTHETIC BRINES	
	<b>C01D 15/02</b> (2006.01)			
	<b>C01D 15/08</b> (2006.01)			
	<b>C22B 3/24</b> (2006.01)	3793606	METHODS OF TREATING CANCERS AND ENHANCING EFFICACY OF T CELL REDIRECTING THERAPEUTICS	
	<b>A61K 39/395</b> (2006.01)			
<b>A61P 35/00</b> (2006.01)				
<b>C07K 16/28</b> (2006.01)				

Podnosilac evropske prijave patenta (71)	MKP (51)	Broj objave evropske prijave patenta (97)	Naziv pronalaska (54)
The University of North Carolina at Chapel Hill	<b>C07K 16/30</b> (2006.01)	3793521	SAFE AND EFFECTIVE METHOD OF TREATING LUPUS WITH ANTI-IL12/IL23 ANTIBODY
	<b>C07K 16/46</b> (2006.01)		
	<b>C07K 19/00</b> (2006.01)		
	<b>A61K 9/00</b> (2006.01)		
	<b>A61P 37/06</b> (2006.01)		
	<b>C07K 16/24</b> (2006.01)		
	<b>C12Q 1/68</b> (2018.01)		
	<b>C12Q 1/6883</b> (2018.01)		
	<b>A61K 45/06</b> (2006.01)		
	<b>C07D 401/14</b> (2006.01)		
University Health Network	<b>C12M 1/00</b> (2006.01)	3794349	DEVICES, SYSTEMS AND APPARATUSES FOR GENERATING SELF-SUSTAINING HYPOXIC CONDITIONS AND GASEOUS AND NON-GASEOUS CHEMICAL GRADIENTS FOR IN VITRO CELL CULTURE
	<b>C12M 3/00</b> (2006.01)	3799570	MODULATORS OF APOL1 EXPRESSION
	<b>C12N 5/00</b> (2006.01)		
	<b>C12N 13/00</b> (2006.01)		
	<b>G01N 33/50</b> (2006.01)		
	<b>A61K 48/00</b> (2006.01)		
	<b>C07H 21/02</b> (2006.01)		
	<b>A61K 31/4184</b> (2006.01)		
	<b>A61K 31/437</b> (2006.01)		
	<b>A61K 31/44</b> (2006.01)		
<b>A61K 31/4985</b> (2006.01)			
Lexent Bio, Inc.	<b>A61K 31/5025</b> (2006.01)	3796914	METHODS OF TREATING CANCERS CHARACTERIZED BY A HIGH EXPRESSION LEVEL OF SPINDLE AND KINETOCHORE ASSOCIATED COMPLEX SUBUNIT 3 (SKA3) GENE
	<b>A61K 31/517</b> (2006.01)		
	<b>A61K 31/519</b> (2006.01)		
	<b>A61K 31/52</b> (2006.01)		
	<b>A61K 31/55</b> (2006.01)		
	<b>A61P 35/00</b> (2006.01)		
	<b>C12Q 1/6809</b> (2018.01)		
	<b>C12Q 1/68</b> (2018.01)		
	<b>C12Q 1/6827</b> (2018.01)		
	<b>C12Q 1/6883</b> (2018.01)		
Fibrobetaon Yapi Elemanlari Sanayi Insaat Ve Ticaret Anonim Sirketi Plustechno Danismanlik ve Yapi Kimyasallari Ticaret Limited Sirketi	<b>C40B 30/00</b> (2006.01)	3781533	RADIATION-IMPERMEABLE AND RADON GAS-TIGHT FIBER-REINFORCED CONCRETES
	<b>C04B 28/04</b> (2006.01)		
	<b>C04B 111/00</b> (2006.01)		

Podnosilac evropske prijave patenta (71)	MKP (51)	Broj objave evropske prijave patenta (97)	Naziv pronalaska (54)
	<b>A61K 39/12</b> (2006.01)	3718565	RESPIRATORY VIRUS VACCINES
	<b>A61P 11/00</b> (2006.01)		
	<b>C07K 16/10</b> (2006.01)		
Antev Limited	<b>A61K 38/09</b> (2006.01)	3701965	A COMPOSITION COMPRISING AT LEAST ONE GNRH ANTAGONIST
	<b>A61K 45/06</b> (2006.01)		
	<b>A61P 5/26</b> (2006.01)		
	<b>A61P 5/30</b> (2006.01)		
	<b>A61P 13/00</b> (2006.01)		
	<b>A61P 13/08</b> (2006.01)		
	<b>A61P 15/00</b> (2006.01)		
	<b>A61P 35/00</b> (2006.01)		
	<b>A61P 43/00</b> (2006.01)		
Kubota Corporation	<b>A01D 87/00</b> (2006.01)	3730701	STRUCTURE FOR DETACHABLE FRONT LOADER, DETACHABLE FRONT LOADER, AND WORK VEHICLE
	<b>E02F 3/627</b> (2006.01)		
	<b>A61K 51/00</b> (2006.01)	3696824	RUBIDIUM ELUTION SYSTEM CONTROL
	<b>A61K 51/12</b> (2006.01)		
	<b>A61M 36/00</b> (2006.01)		
	<b>G21G 1/00</b> (2006.01)		
	<b>A61K 31/519</b> (2006.01)	3699181	CRYSTALLINE FORM OF (S)-N-(5-((R)-2-(2,5-DIFLUOROPHENYL)-PYRROLIDIN-1-YL)-PYRAZOLO[1,5-A]PYRIMIDIN-3-YL)-3-HYDROXYPYRROLIDINE-1-CARBOXAMIDE HYDROGEN SULFATE
	<b>A61P 35/00</b> (2006.01)		
	<b>C07D 487/04</b> (2006.01)		
	<b>A61K 39/00</b> (2006.01)	3725327	PEPTIDES AND COMBINATION THEREOF FOR USE IN THE IMMUNOTHERAPY AGAINST CANCERS
	<b>A61P 35/00</b> (2006.01)		
	<b>C07K 14/47</b> (2006.01)		
	<b>G01N 33/50</b> (2006.01)		
	<b>A61K 39/00</b> (2006.01)	3760225	NOVEL PEPTIDES AND COMBINATION OF PEPTIDES FOR USE IN IMMUNOTHERAPY AGAINST LUNG CANCER, INCLUDING NSCLC AND OTHER CANCERS
	<b>A61P 35/00</b> (2006.01)		
	<b>C07K 14/47</b> (2006.01)		
	<b>C07K 16/00</b> (2006.01)		
	<b>A01N 43/52</b> (2006.01)	3763706	PARASITICIDAL COMPOSITIONS COMPRISING BENZIMIDAZOLE DERIVATIVES, METHODS AND USES THEREOF
	<b>A61K 31/4184</b> (2006.01)		
	<b>C07D 235/10</b> (2006.01)		
	<b>C07D 235/18</b> (2006.01)		
	<b>C07D 235/28</b> (2006.01)		
Meteor Umformtechnik GmbH & Co. KG	<b>B21D 28/02</b> (2006.01)	3797893	DEVICE FOR THE FINE CUTTING / NORMAL STAMPING OF BLANKS MADE FROM A METAL

Podnosilac evropske prijave patenta (71)	MKP (51)	Broj objave evropske prijave patenta (97)	Naziv pronalaska (54)
	<b>B21D 28/16</b> (2006.01)		STRIP AND FOR THE MULTI-STAGE MACHINING OF THE BLANKS BY MEANS OF CUTTING AND MACHINING TOOLS
	<b>B21D 37/08</b> (2006.01)		
	<b>B21D 43/14</b> (2006.01)		
	<b>A61K 31/422</b> (2006.01)	3766491	PARASITICIDAL ORAL VETERINARY COMPOSITIONS COMPRISING SYSTEMICALLY-ACTING ACTIVE AGENTS, METHODS AND USES THEREOF
	<b>A61P 33/00</b> (2006.01)		
	<b>A61K 38/12</b> (2006.01)	3778622	MACROCYCLIC PEPTIDES USEFUL AS IMMUNOMODULATORS
	<b>A61P 37/06</b> (2006.01)		
	<b>C07K 7/08</b> (2006.01)		
	<b>C07K 7/56</b> (2006.01)		
	<b>G01N 33/68</b> (2006.01)		
Nicox Ophthalmics, Inc.	<b>A61K 9/10</b> (2006.01)	3769753	PROCESS FOR THE PREPARATION OF STERILE OPHTHALMIC AQUEOUS FLUTICASONE PROPIONATE FORM A NANOCRYSTALS SUSPENSIONS
	<b>A61K 9/14</b> (2006.01)		
	<b>A61K 31/56</b> (2006.01)		
	<b>A61K 47/02</b> (2006.01)		
	<b>A61K 47/10</b> (2017.01)		
	<b>A61P 27/00</b> (2006.01)		
	<b>C07J 31/00</b> (2006.01)		
	<b>C07J 71/00</b> (2006.01)		
	<b>A61K 39/395</b> (2006.01)	3792281	METHODS OF TREATING PSORIASIS USING IL-17 ANTAGONISTS
	<b>A61P 17/06</b> (2006.01)		
	<b>C07K 16/24</b> (2006.01)		
Amgen Inc.	<b>A61P 3/00</b> (2006.01)	3763734	GROWTH DIFFERENTIATION FACTOR 15 (GDF-15) CONSTRUCTS
	<b>A61P 3/04</b> (2006.01)		
	<b>A61P 3/06</b> (2006.01)		
	<b>A61P 3/08</b> (2006.01)		
	<b>A61P 3/10</b> (2006.01)		
	<b>A61P 3/12</b> (2006.01)		
	<b>A61P 13/12</b> (2006.01)		
	<b>C07K 14/475</b> (2006.01)		
	<b>C07K 14/495</b> (2006.01)		
	<b>C07K 14/765</b> (2006.01)		
	<b>C12N 15/62</b> (2006.01)		
	<b>A01N 25/00</b> (2006.01)	3788874	PARASITICIDAL COMPOSITIONS COMPRISING AN ISOXAZOLINE ACTIVE AGENT, METHOD AND USES THEREOF
	<b>A61K 31/42</b> (2006.01)		
	<b>A61P 33/00</b> (2006.01)		

Podnosilac evropske prijave patenta (71)	MKP (51)	Broj objave evropske prijave patenta (97)	Naziv pronalaska (54)
Astex Therapeutics Limited	<b>A61K 31/4192</b> (2006.01)	3766878	NRF2 REGULATORS
	<b>A61K 31/553</b> (2006.01)		
	<b>A61P 9/10</b> (2006.01)		
	<b>A61P 9/12</b> (2006.01)		
	<b>A61P 11/00</b> (2006.01)		
	<b>A61P 11/06</b> (2006.01)		
	<b>A61P 13/12</b> (2006.01)		
	<b>A61P 17/00</b> (2006.01)		
	<b>A61P 25/00</b> (2006.01)		
	<b>A61P 35/00</b> (2006.01)		
	<b>A61P 37/00</b> (2006.01)		
	<b>C07D 267/14</b> (2006.01)		
	<b>C07D 403/06</b> (2006.01)		
	<b>C07D 413/06</b> (2006.01)		
	<b>C07D 413/10</b> (2006.01)		
	<b>C07D 498/04</b> (2006.01)		
	<b>C07D 519/00</b> (2006.01)		
	<b>A61K 8/04</b> (2006.01)	3799933	COMPOSITION FOR THE TREATMENT OF ACNE
	<b>A61K 8/34</b> (2006.01)		
	<b>A61K 8/36</b> (2006.01)		
	<b>A61K 8/365</b> (2006.01)		
	<b>A61K 8/60</b> (2006.01)		
	<b>A61K 8/9789</b> (2017.01)		
	<b>A61K 9/00</b> (2006.01)		
	<b>A61K 9/107</b> (2006.01)		
	<b>A61K 31/047</b> (2006.01)		
	<b>A61K 36/76</b> (2006.01)		
	<b>A61K 47/10</b> (2017.01)		
	<b>A61P 17/10</b> (2006.01)		
	<b>A61Q 17/04</b> (2006.01)		
	<b>A61Q 19/00</b> (2006.01)		
	<b>A61Q 19/10</b> (2006.01)		
	<b>A61K 31/4174</b> (2006.01)	3770146	PPAR AGONISTS, COMPOUNDS, PHARMACEUTICAL COMPOSITIONS, AND METHODS OF USE THEREOF
	<b>A61K 31/4439</b> (2006.01)		
	<b>A61P 21/00</b> (2006.01)		

Podnosilac evropske prijave patenta (71)	MKP (51)	Broj objave evropske prijave patenta (97)	Naziv pronalaska (54)
	<b>C07D 233/64</b> (2006.01)		
	<b>C07D 401/04</b> (2006.01)		
	<b>C07D 405/10</b> (2006.01)		
	<b>A61K 31/4174</b> (2006.01)	3795566	PPAR AGONISTS, COMPOUNDS, PHARMACEUTICAL COMPOSITIONS, AND METHODS OF USE THEREOF
	<b>A61K 31/4439</b> (2006.01)		
	<b>A61P 21/00</b> (2006.01)		
	<b>A61P 25/00</b> (2006.01)		
	<b>C07D 401/04</b> (2006.01)		
	<b>A61K 31/4188</b> (2006.01)	3778606	CONDENSED IMIDAZOLYLIMIDAZOLES AS ANTIVIRAL COMPOUNDS
	<b>C07D 491/052</b> (2006.01)		
	<b>A61K 31/4188</b> (2006.01)	3778606	CONDENSED IMIDAZOLYLIMIDAZOLES AS ANTIVIRAL COMPOUNDS
	<b>C07D 491/052</b> (2006.01)		
	<b>A01N 43/50</b> (2006.01)	3766871	DIARYLIMIDAZOLE COMPOUND AND PEST CONTROL AGENT
	<b>A01P 7/02</b> (2006.01)		
	<b>A01P 7/04</b> (2006.01)		
	<b>A61K 31/4164</b> (2006.01)		
	<b>A61K 31/4439</b> (2006.01)		
	<b>A61P 31/00</b> (2006.01)		
	<b>A61P 33/00</b> (2006.01)		
	<b>A61P 33/10</b> (2006.01)		
	<b>A61P 33/14</b> (2006.01)		
	<b>C07D 233/64</b> (2006.01)		
	<b>C07D 401/04</b> (2006.01)		
	<b>A61K 31/45</b> (2006.01)	3786160	PYRIDINE DERIVATIVES AND THERAPEUTIC USES THEREOF AS TRPC6 INHIBITORS
	<b>A61K 31/501</b> (2006.01)		
	<b>C07D 213/04</b> (2006.01)		
	<b>C07D 401/14</b> (2006.01)		
	<b>C07D 451/02</b> (2006.01)		
	<b>C07D 487/08</b> (2006.01)		
	<b>C07D 498/08</b> (2006.01)		
	<b>A61K 39/095</b> (2006.01)	3782643	MODIFIED MENINGOCOCCAL FHBP POLYPEPTIDES
	<b>C07K 14/095</b> (2006.01)		
	<b>C07K 14/22</b> (2006.01)		
Axon Neuroscience SE	<b>A61P 25/28</b> (2006.01)	3786182	HUMANIZED TAU ANTIBODIES IN ALZHEIMER'S DISEASE
	<b>C07K 14/435</b> (2006.01)		

Podnosilac evropske prijave patenta (71)	MKP (51)	Broj objave evropske prijave patenta (97)	Naziv pronalaska (54)		
JBPV s.r.o.	<b>C07K 16/18</b> (2006.01)	3789038	HUMANIZED AND CHIMERIC MONOCLONAL ANTIBODIES TO CD47		
	<b>G01N 33/53</b> (2006.01)				
	<b>A61K 39/395</b> (2006.01)				
	<b>A61P 35/00</b> (2006.01)				
	<b>A61P 35/02</b> (2006.01)				
	<b>A61P 37/04</b> (2006.01)				
	<b>C07K 16/28</b> (2006.01)				
	<b>C07K 16/46</b> (2006.01)				
	<b>C12N 5/07</b> (2010.01)				
	<b>C12N 5/16</b> (2006.01)				
	<b>C12P 21/08</b> (2006.01)				
	<b>G01N 33/68</b> (2006.01)				
	<b>A61K 31/5365</b> (2006.01)			3782996	NRF2 REGULATORS
	<b>A61P 9/00</b> (2006.01)				
	<b>A61P 11/00</b> (2006.01)				
	<b>A61P 25/00</b> (2006.01)				
	<b>A61P 27/00</b> (2006.01)				
	<b>A61P 35/00</b> (2006.01)				
	<b>A61P 37/00</b> (2006.01)				
	<b>C07C 15/16</b> (2006.01)				
	<b>C07D 249/04</b> (2006.01)				
	<b>C07D 249/18</b> (2006.01)				
	<b>C07D 403/10</b> (2006.01)				
	<b>C07D 417/10</b> (2006.01)				
	<b>A61K 31/53</b> (2006.01)	3785717	METHODS FOR TREATING CORONAVIRIDAE INFECTIONS		
	<b>A61K 31/664</b> (2006.01)				
	<b>A61K 31/675</b> (2006.01)				
	<b>A61K 31/683</b> (2006.01)				
	<b>A61K 31/685</b> (2006.01)				
	<b>A61P 31/12</b> (2006.01)				
	<b>G06F 9/54</b> (2006.01)	3783576	METHOD FOR DETECTING AND ANALYSING DATA DISPLAYED ON A DISPLAY SCREEN OF AN AUTOMATIC COIN-OPERATED GAMING MACHINE		
	<b>G06F 13/00</b> (2006.01)				
	<b>G07F 17/32</b> (2006.01)				
<b>C07D 487/04</b> (2006.01)	3762390	PROCESS FOR PREPARING SOLUBLE GUANYLATE CYCLASE STIMULATORS			
<b>C08J 11/12</b> (2006.01)	3765559		METHOD OF OBTAINING TEREPHTHALIC ACID FROM WASTE POLYETHYLENE TEREPHTHALATE		

Podnosilac evropske prijave patenta (71)	MKP (51)	Broj objave evropske prijave patenta (97)	Naziv pronalaska (54)
	<b>C08J 11/14</b> (2006.01)		
	<b>C08L 67/02</b> (2006.01)		
	<b>A61K 31/427</b> (2006.01)	3765458	O-GLYCOPROTEIN-2-ACETAMIDO-2-DEOXY-3-D-GLYCOPYRANOSIDASE INHIBITORS
	<b>A61K 31/445</b> (2006.01)		
	<b>A61P 25/28</b> (2006.01)		
	<b>C07D 417/06</b> (2006.01)		
	<b>C07D 417/14</b> (2006.01)		
	<b>C07D 495/04</b> (2006.01)		
	<b>A61K 31/519</b> (2006.01)	3765461	SELECTIVE INHIBITORS OF PROTEIN ARGININE METHYLTRANSFERASE 5 (PRMT5)
	<b>A61P 35/00</b> (2006.01)		
	<b>C07D 487/04</b> (2006.01)		
	<b>C07D 519/00</b> (2006.01)		
	<b>A61P 35/00</b> (2006.01)	3768711	ANTI-CD137 ANTIBODIES FOR COMBINATION WITH ANTI-PD-L1 ANTIBODIES
	<b>C07K 16/28</b> (2006.01)		
	<b>A61K 39/00</b> (2006.01)	3768712	ANTI-CD137 ANTIBODIES FOR COMBINATION WITH ANTI-PD-1 ANTIBODIES
	<b>A61P 35/00</b> (2006.01)		
	<b>C07K 16/28</b> (2006.01)		
	<b>C12M 1/34</b> (2006.01)	3765846	METHODS FOR IMPROVING CELL VIABILITY IN A PRODUCTION BIOREACTOR
	<b>G01N 33/50</b> (2006.01)		
	<b>A61K 35/744</b> (2015.01)	3768284	COMPOSITIONS
	<b>A61K 38/16</b> (2006.01)		
	<b>A61K 48/00</b> (2006.01)		
	<b>A61P 35/00</b> (2006.01)		
	<b>A61P 37/04</b> (2006.01)		
	<b>C07K 14/315</b> (2006.01)		
	<b>B01J 23/02</b> (2006.01)	3768419	METHOD FOR TRANSESTERIFICATION OF CARBOXYLIC ACID ESTERS
	<b>B01J 35/02</b> (2006.01)		
	<b>B01J 35/10</b> (2006.01)		
	<b>B01J 37/08</b> (2006.01)		
	<b>C01F 1/00</b> (2006.01)		
	<b>C01F 11/06</b> (2006.01)		
	<b>C01F 11/18</b> (2006.01)		
	<b>C07C 67/03</b> (2006.01)		
	<b>C10L 1/02</b> (2006.01)		
	<b>C10L 3/00</b> (2006.01)		



Podnosilac evropske prijave patenta (71)	MKP (51)	Broj objave evropske prijave patenta (97)	Naziv pronalaska (54)
DTech - Società a Responsabilità Limitata	<b>C10L 3/10</b> (2006.01)	3768285	COMPOSITIONS COMPRISING BACTERIAL STRAINS
	<b>A23L 33/135</b> (2016.01)		
	<b>A61K 35/744</b> (2015.01)		
	<b>A61K 38/16</b> (2006.01)	3768224	ANTISEPTIC AND/OR ANTI-INFLAMMATORY GEL FOR TREATMENT OF ORAL CAVITY DISEASES COMPRISING POLYVINYL ALCOHOL AND POLYACIDS
	<b>A61P 37/04</b> (2006.01)		
	<b>A61K 6/00</b> (2020.01)		
	<b>A61K 8/04</b> (2006.01)		
	<b>A61K 8/19</b> (2006.01)		
	<b>A61K 8/20</b> (2006.01)		
	<b>A61K 8/22</b> (2006.01)		
	<b>A61K 8/37</b> (2006.01)		
	<b>A61K 8/43</b> (2006.01)		
	<b>A61K 8/73</b> (2006.01)		
	<b>A61K 8/81</b> (2006.01)		
	<b>A61K 31/155</b> (2006.01)		
	<b>A61K 31/192</b> (2006.01)	3762393	ALPHA-HYDROXY PHENYLACETIC ACID PHARMACOPHORE OR BIOISOSTERE MCL-1 PROTEIN ANTAGONISTS
	<b>A61K 31/616</b> (2006.01)		
	<b>A61P 1/02</b> (2006.01)		
	<b>A61Q 11/00</b> (2006.01)		
<b>A61Q 11/02</b> (2006.01)			
<b>A61K 31/553</b> (2006.01)	3761987	COMPOUNDS FOR TREATING ALZHEIMER'S DISEASE	
<b>A61P 35/00</b> (2006.01)			
<b>C07D 498/10</b> (2006.01)			
<b>C07D 498/20</b> (2006.01)	3781321	HYBRID DISC	
<b>C07D 498/22</b> (2006.01)			
Amabiotics	<b>A61K 31/519</b> (2006.01)	3768265	NEW CENTRALLY-ACTIVE GHRELIN AGONIST AND MEDICAL USES THEREOF
	<b>A61K 31/7068</b> (2006.01)		
	<b>A61K 45/06</b> (2006.01)		
	<b>A61P 25/28</b> (2006.01)	3768265	NEW CENTRALLY-ACTIVE GHRELIN AGONIST AND MEDICAL USES THEREOF
	<b>B02C 17/16</b> (2006.01)		
	<b>A61K 31/4468</b> (2006.01)		
	<b>A61P 9/00</b> (2006.01)		
<b>A61P 25/00</b> (2006.01)	3768265	NEW CENTRALLY-ACTIVE GHRELIN AGONIST AND MEDICAL USES THEREOF	
<b>A61P 25/02</b> (2006.01)			
<b>A61P 25/04</b> (2006.01)			

Podnosilac evropske prijave patenta (71)	MKP (51)	Broj objave evropske prijave patenta (97)	Naziv pronalaska (54)
Natisa S.r.l.	<b>A61P 25/16</b> (2006.01)	3765447	TRIAZACYCLODODECANSULFONAMIDE ("TCD")-BASED PROTEIN SECRETION INHIBITORS
	<b>A61P 25/28</b> (2006.01)		
	<b>A61K 31/395</b> (2006.01)		
	<b>A61K 31/675</b> (2006.01)	3768311	TREATMENT AND PROPHYLAXIS OF AMYLOIDOSIS
	<b>C07D 255/02</b> (2006.01)		
	<b>A61K 39/395</b> (2006.01)		
	<b>A61P 43/00</b> (2006.01)	3768715	ANTIBODIES AGAINST MICA AND/OR MICB AND USES THEREOF
	<b>C07K 16/18</b> (2006.01)		
	<b>C07K 16/28</b> (2006.01)		
	<b>A61P 35/00</b> (2006.01)	3761830	FURNISHING COMPONENT AND PRODUCTION METHOD
	<b>C07K 16/28</b> (2006.01)		
	<b>A47B 7/00</b> (2006.01)		
	<b>A47B 13/02</b> (2006.01)	3765069	PEPTIDE VACCINES AGAINST INTERLEUKIN-31
	<b>A61K 39/00</b> (2006.01)		
	<b>A61K 39/385</b> (2006.01)		
	<b>G01N 33/68</b> (2006.01)	3768850	METHODS FOR MEASURING BACTERIA IN BIOLOGICAL SAMPLES
	<b>C12Q 1/06</b> (2006.01)		
	<b>C12Q 1/24</b> (2006.01)		
	<b>A61K 31/165</b> (2006.01)	3768660	MODULATORS OF EUKARYOTIC INITIATION FACTOR 2
	<b>A61K 31/397</b> (2006.01)		
	<b>A61K 31/438</b> (2006.01)		
	<b>A61P 25/00</b> (2006.01)		
	<b>A61P 35/00</b> (2006.01)		
	<b>C07D 205/12</b> (2006.01)		
	<b>C07D 207/09</b> (2006.01)		
	<b>C07D 209/52</b> (2006.01)		
	<b>C07D 211/58</b> (2006.01)		
	<b>C07D 211/74</b> (2006.01)		
	<b>C07D 215/12</b> (2006.01)		
	<b>C07D 221/20</b> (2006.01)		
	<b>C07D 233/32</b> (2006.01)		
	<b>C07D 271/10</b> (2006.01)		
<b>C07D 277/68</b> (2006.01)			
<b>C07D 311/66</b> (2006.01)			
<b>C07D 401/04</b> (2006.01)			

Podnosilac evropske prijave patenta (71)	MKP (51)	Broj objave evropske prijave patenta (97)	Naziv pronalaska (54)
	<b>C07D 401/12</b> (2006.01)		
	<b>C07D 403/04</b> (2006.01)		
	<b>C07D 413/04</b> (2006.01)		
	<b>A61P 35/00</b> (2006.01)	3765474	CYCLOPENTANE-BASED MODULATORS OF STING (STIMULATOR OF INTERFERON GENES)
	<b>C07H 19/213</b> (2006.01)		
	<b>G01N 33/68</b> (2006.01)	3765856	METHODS FOR THE PREPARATION OF TRYPSIN-RESISTANT POLYPEPTIDES FOR MASS SPECTROMETRIC ANALYSIS
OUTOTEC (FINLAND) OY	<b>C01D 15/02</b> (2006.01)	3793943	METHOD FOR RECOVERING LITHIUM HYDROXIDE
	<b>C01D 15/08</b> (2006.01)		
	<b>C22B 26/12</b> (2006.01)		
Etme: Peppas Kai Synergates E.E.	<b>B63B 22/00</b> (2006.01)	3762288	FLOATING PLATFORM FOR MARITIME SURVEILLANCE
	<b>B63B 35/00</b> (2020.01)		
	<b>B63B 35/44</b> (2006.01)		
	<b>G01S 7/00</b> (2006.01)		
	<b>A61K 39/00</b> (2006.01)	3793592	PEPTIDES FOR USE IN IMMUNOTHERAPY AGAINST CANCERS
	<b>C07K 14/47</b> (2006.01)		
	<b>C07K 14/74</b> (2006.01)		
	<b>G01N 33/68</b> (2006.01)	3765857	SEQUENTIAL DIGESTION OF POLYPEPTIDES FOR MASS SPECTROMETRIC ANALYSIS
	<b>A61K 39/395</b> (2006.01)	3768716	ANTIBODIES BINDING TO VISTA AT ACIDIC PH
	<b>C07K 16/28</b> (2006.01)		
	<b>A61K 9/00</b> (2006.01)	3784209	METHOD FOR MAKING INJECTABLE PHARMACEUTICAL COMPOSITIONS
	<b>A61P 7/06</b> (2006.01)		
	<b>A61P 37/04</b> (2006.01)		
	<b>A61P 37/06</b> (2006.01)		
	<b>G01N 15/02</b> (2006.01)		
	<b>G01N 15/10</b> (2006.01)		
	<b>C09C 1/02</b> (2006.01)	3784736	USE OF ADDITIVES CONTAINING PRIMARY ALKANOLAMINES IN AQUEOUS MINERAL SUSPENSIONS
	<b>D21H 17/67</b> (2006.01)		
	<b>A61K 31/437</b> (2006.01)	3784667	HETEROAROMATIC COMPOUNDS HAVING ACTIVITY AGAINST RSV
	<b>A61P 31/16</b> (2006.01)		
	<b>C07D 471/04</b> (2006.01)		
Krupter SRL	<b>H04L 12/28</b> (2006.01)	3769473	MULTI USER DSL METHOD AND SYSTEM FOR THE STATISTICAL MULTIPLEXING OF COPPER LINES
MP Lumber d.o.o. Doctors & Co. d.o.o.	<b>A61F 5/058</b> (2006.01)	3781219	A KIT FOR IN SITU IMMOBILIZATION WITH ANTIFUNGAL AND ANTIMICROBIAL EFFECTS
	<b>A61L 15/08</b> (2006.01)		
	<b>A61L 15/12</b> (2006.01)		

Podnosilac evropske prijave patenta (71)	MKP (51)	Broj objave evropske prijave patenta (97)	Naziv pronalaska (54)	
KWS SAAT SE & Co. KGaA	<b>A61L 15/14</b> (2006.01)	3784030	PLANTS WITH IMPROVED DIGESTIBILITY AND MARKER HAPLOTYPES	
	<b>A01H 1/04</b> (2006.01)			
	<b>C12N 9/14</b> (2006.01)			
	<b>C12N 15/82</b> (2006.01)	3785260	INTEGRATION OF HIGH FREQUENCY AUDIO RECONSTRUCTION TECHNIQUES	
	<b>C12Q 1/68</b> (2018.01)			
	<b>G10L 19/02</b> (2013.01)	3784691	PRODUCTION OF NERVE GROWTH FACTOR (NGF) AND OF MUTEINS THEREOF	
	<b>G10L 19/24</b> (2013.01)			
	<b>G10L 21/0388</b> (2013.01)			
	Children's Hospital Medical Center	<b>A61K 38/18</b> (2006.01)	3781560	PYRAZO-TETRAHYDROISOQUINOLINE DERIVATIVES AS DOPAMINE D1 RECEPTOR POSITIVE MODULATORS
		<b>C07K 14/48</b> (2006.01)		
<b>A61P 25/16</b> (2006.01)		3784212	A THERAPEUTIC COMBINATION COMPRISING A PULMONARY SURFACTANT AND A STEROID FOR THE PROPHYLAXIS OF BPD	
<b>A61P 25/28</b> (2006.01)				
<b>C07D 401/04</b> (2006.01)				
Cartotecnica G. Arici S.r.l.		<b>C07D 405/14</b> (2006.01)	3765131	DOSE CONTROL DEVICE FOR INJECTABLE-DRUG DELIVERY DEVICES
		<b>A61K 9/00</b> (2006.01)		
		<b>A61P 11/06</b> (2006.01)	3765381	THERMAL CONTAINER
		<b>A61M 5/315</b> (2006.01)		
		<b>B65D 81/38</b> (2006.01)	3790873	1H-INDAZOLE-3-CARBOXAMIDE COMPOUNDS AS GLYCOGEN SYNTHASE KINASE 3 BETA INHIBITORS
	<b>A61K 31/454</b> (2006.01)			
	<b>A61K 31/4545</b> (2006.01)			
	<b>A61P 3/00</b> (2006.01)			
	<b>A61P 25/00</b> (2006.01)			
	<b>A61P 29/00</b> (2006.01)			
<b>A61P 35/00</b> (2006.01)				
<b>C07D 405/12</b> (2006.01)				
<b>C07D 405/14</b> (2006.01)				
<b>C07D 409/12</b> (2006.01)				
<b>C07D 409/14</b> (2006.01)	3781674	INDUCTION OF MYELINATING OLIGODENDROCYTES IN HUMAN CORTICAL SPHEROIDS		
<b>C12N 5/079</b> (2010.01)				
Case Western Reserve University		3787605	STABLE PHARMACEUTICAL FORMULATION	
Oryzon Genomics, S.A.	<b>A61K 9/28</b> (2006.01)			
	<b>A61K 9/50</b> (2006.01)			
	<b>A61K 31/00</b> (2006.01)			
Celldex Therapeutics, Inc.	<b>A61P 35/00</b> (2006.01)	3781265	ANTI-CD27 AND ANTI-PD-L1 ANTIBODIES AND BISPECIFIC CONSTRUCTS	
	<b>C07K 16/28</b> (2006.01)			

Podnosilac evropske prijave patenta (71)	MKP (51)	Broj objave evropske prijave patenta (97)	Naziv pronalaska (54)
Agbiome, Inc.	<b>A61K 31/44</b> (2006.01)	3781561	MODULATORS OF METHYL MODIFYING ENZYMES, COMPOSITIONS AND USES THEREOF
	<b>A61P 35/00</b> (2006.01)		
	<b>C07D 405/12</b> (2006.01)		
	<b>C07D 405/14</b> (2006.01)	3781692	PESTICIDAL PROTEINS AND METHODS OF USE
	<b>C07K 14/195</b> (2006.01)		
	<b>C07K 14/325</b> (2006.01)		
	<b>C12N 15/82</b> (2006.01)	3781596	IL-15/IL-15RA HETERODIMERIC FC FUSION PROTEINS AND USES THEREOF
	<b>A61K 38/17</b> (2006.01)		
	<b>A61K 38/20</b> (2006.01)		
	<b>A61P 35/00</b> (2006.01)	3784254	CLOSED PROCESS FOR EXPANSION AND GENE EDITING OF TUMOR INFILTRATING LYMPHOCYTES AND USES OF SAME IN IMMUNOTHERAPY
	<b>C07K 14/54</b> (2006.01)		
	<b>C07K 14/715</b> (2006.01)		
	<b>C07K 16/28</b> (2006.01)	3784272	ANTI-BCMA CAR-T-CELLS FOR PLASMA CELL DEPLETION
	<b>A61K 35/17</b> (2015.01)		
	<b>C12N 5/09</b> (2010.01)		
	<b>C12N 15/90</b> (2006.01)	3788043	SPIROPIPERIDINE ALLOSTERIC MODULATORS OF NICOTINIC ACETYLCHOLINE RECEPTORS
	<b>A61K 38/46</b> (2006.01)		
	<b>A61K 39/00</b> (2006.01)		
	<b>A61K 48/00</b> (2006.01)	3788043	SPIROPIPERIDINE ALLOSTERIC MODULATORS OF NICOTINIC ACETYLCHOLINE RECEPTORS
	<b>A61P 35/00</b> (2006.01)		
	<b>C07K 14/725</b> (2006.01)		
	<b>C07K 16/28</b> (2006.01)	3788043	SPIROPIPERIDINE ALLOSTERIC MODULATORS OF NICOTINIC ACETYLCHOLINE RECEPTORS
	<b>C12N 5/0783</b> (2010.01)		
	<b>C12N 9/22</b> (2006.01)		
	<b>C12N 15/90</b> (2006.01)	3788043	SPIROPIPERIDINE ALLOSTERIC MODULATORS OF NICOTINIC ACETYLCHOLINE RECEPTORS
	<b>A61K 31/438</b> (2006.01)		
	<b>A61K 31/439</b> (2006.01)		
	<b>A61K 31/444</b> (2006.01)	3788043	SPIROPIPERIDINE ALLOSTERIC MODULATORS OF NICOTINIC ACETYLCHOLINE RECEPTORS
	<b>A61K 31/501</b> (2006.01)		
	<b>A61K 31/506</b> (2006.01)		
	<b>A61P 25/00</b> (2006.01)	3788043	SPIROPIPERIDINE ALLOSTERIC MODULATORS OF NICOTINIC ACETYLCHOLINE RECEPTORS
	<b>C07D 401/04</b> (2006.01)		
<b>C07D 413/04</b> (2006.01)			
<b>C07D 413/14</b> (2006.01)	3788043	SPIROPIPERIDINE ALLOSTERIC MODULATORS OF NICOTINIC ACETYLCHOLINE RECEPTORS	
<b>C07D 417/04</b> (2006.01)			
<b>C07D 417/04</b> (2006.01)			

Podnosilac evropske prijave patenta (71)	MKP (51)	Broj objave evropske prijave patenta (97)	Naziv pronalaska (54)		
Tseti, Ioulia	<b>C07D 417/14</b> (2006.01)	3781126	A PHARMACEUTICAL DRY POWDER COMPOSITION FOR INHALATION COMPRISING A THYROID HORMONE		
	<b>C07D 471/04</b> (2006.01)				
	<b>C07D 471/08</b> (2006.01)				
	<b>C07D 487/04</b> (2006.01)				
	<b>C07D 513/04</b> (2006.01)				
	<b>A61K 9/00</b> (2006.01)				
	<b>A61K 9/14</b> (2006.01)				
	<b>A61K 31/198</b> (2006.01)				
	<b>A61K 47/26</b> (2006.01)				
	<b>A61K 31/55</b> (2006.01)			3781170	COMPOUNDS AND THEIR USES FOR ALLEVIATING MENOPAUSE-ASSOCIATED SYMPTOMS
	<b>A61K 31/565</b> (2006.01)				
	<b>A61K 31/57</b> (2006.01)				
	<b>A61K 31/585</b> (2006.01)			3781171	COMPOUNDS AND THEIR USES FOR ALLEVIATING MENOPAUSE-ASSOCIATED SYMPTOMS
	<b>A61P 5/30</b> (2006.01)				
	<b>A61K 31/55</b> (2006.01)				
<b>A61K 31/565</b> (2006.01)					
<b>A61K 31/57</b> (2006.01)					
<b>A61K 31/585</b> (2006.01)	3790060	PHOTOVOLTAIC CELL ARRAY AND PHOTOVOLTAIC ASSEMBLY			
<b>A61P 5/30</b> (2006.01)					
<b>H01L 31/0224</b> (2006.01)					
<b>H01L 31/042</b> (2014.01)					
<b>H01L 31/05</b> (2014.01)					
<b>H01L 31/068</b> (2012.01)	3695864	PALM ACTIVATED DRUG DELIVERY DEVICE			
<b>A61M 5/168</b> (2006.01)					
<b>A61M 5/20</b> (2006.01)					
<b>A61M 5/315</b> (2006.01)					
<b>A61M 5/32</b> (2006.01)					
<b>A61M 5/42</b> (2006.01)					
<b>A61M 5/48</b> (2006.01)					
<b>A61M 5/50</b> (2006.01)					
<b>A61K 39/00</b> (2006.01)			3689911	ANTIBODIES SPECIFIC FOR CLAUDIN 6 (CLDN6)	
<b>A61K 39/395</b> (2006.01)					
<b>A61P 1/04</b> (2006.01)					
<b>A61P 1/16</b> (2006.01)					
<b>A61P 1/18</b> (2006.01)					
Zhejiang Jinko Solar Co., Ltd.					

Podnosilac evropske prijave patenta (71)	MKP (51)	Broj objave evropske prijave patenta (97)	Naziv pronalaska (54)
	<b>A61P 11/00</b> (2006.01)		
	<b>A61P 13/10</b> (2006.01)		
	<b>A61P 13/12</b> (2006.01)		
	<b>A61P 15/00</b> (2006.01)		
	<b>A61P 17/00</b> (2006.01)		
	<b>A61P 21/00</b> (2006.01)		
	<b>A61P 25/00</b> (2006.01)		
	<b>A61P 35/00</b> (2006.01)		
	<b>A61P 35/04</b> (2006.01)		
	<b>C07K 14/705</b> (2006.01)		
	<b>C07K 16/28</b> (2006.01)		
	<b>C07K 16/30</b> (2006.01)		
	<b>A61P 37/06</b> (2006.01)	3693393	ANTIBODIES THAT SPECIFICALLY BIND TO TL1A
	<b>C07K 16/28</b> (2006.01)		
	<b>A61K 31/506</b> (2006.01)	3698795	CERTAIN AMINO-PYRIMIDINES, COMPOSITIONS THEREOF, AND METHODS FOR THEIR USE
	<b>A61K 31/519</b> (2006.01)		
	<b>A61P 21/00</b> (2006.01)		
	<b>A61P 21/04</b> (2006.01)		
	<b>A61P 25/02</b> (2006.01)		
	<b>C07D 239/42</b> (2006.01)		
	<b>C07D 239/48</b> (2006.01)		
	<b>C07D 401/04</b> (2006.01)		
	<b>C07D 401/12</b> (2006.01)		
	<b>C07D 401/14</b> (2006.01)		
	<b>C07D 403/04</b> (2006.01)		
	<b>C07D 403/10</b> (2006.01)		
	<b>C07D 403/14</b> (2006.01)		
	<b>C07D 413/14</b> (2006.01)		
	<b>C07D 417/14</b> (2006.01)		
	<b>C07D 471/04</b> (2006.01)		
	<b>A61K 31/202</b> (2006.01)	3692986	PHARMACEUTICAL COMPOSITIONS COMPRISING DGLA AND USE OF SAME
	<b>B01J 31/02</b> (2006.01)	3680240	ASYMMETRIC PHASE TRANSFER CATALYSIS
	<b>C07D 453/04</b> (2006.01)		
	<b>C12Q 1/6886</b> (2018.01)	3693476	CANCER PATIENT SELECTION FOR ADMINISTRATION OF WNT SIGNALING INHIBITORS USING RNF43 MUTATION STATUS

Podnosilac evropske prijave patenta (71)	MKP (51)	Broj objave evropske prijave patenta (97)	Naziv pronalaska (54)
	<b>G01N 21/03</b> (2006.01)	3690511	MICROSCOPE FOR IMAGING WELLS COMPRISING A DISPENSER AND TEMPERATURE-CONTROLLED ENCLOSURE
	<b>G01N 21/25</b> (2006.01)		
	<b>G01N 21/64</b> (2006.01)		
	<b>G01N 21/76</b> (2006.01)		
	<b>G02B 21/00</b> (2006.01)		
	<b>A61K 31/513</b> (2006.01)	3702352	PYRIMIDINEDIONE COMPOUND AGAINST CARDIAC CONDITIONS
	<b>A61P 9/00</b> (2006.01)		
	<b>A61P 9/04</b> (2006.01)		
	<b>A61P 9/10</b> (2006.01)		
	<b>A61P 9/12</b> (2006.01)		
	<b>C07D 239/545</b> (2006.01)		
	<b>A61K 31/4745</b> (2006.01)	3683220	8-[6-[3-(AMINO)PROPOXY]-3-PYRIDYL]-1-ISOPROPYL-IMIDAZO[4,5-C]QUINOLIN-2-ONE DERIVATIVES AS SELECTIVE MODULATORS OF ATAXIA TELANGIECTASIA MUTATED (ATM) KINASE FOR THE TREATMENT OF HUNTINGTON'S DISEASE
	<b>A61P 25/28</b> (2006.01)		
	<b>A61P 35/00</b> (2006.01)		
	<b>C07D 471/04</b> (2006.01)		
	<b>A61K 31/4355</b> (2006.01)	3670506	THIAZOLECARBOXAMIDES AND PYRIDINECARBOXAMIDE COMPOUNDS USEFUL AS PIM KINASE INHIBITORS
	<b>A61K 31/4365</b> (2006.01)		
	<b>A61K 31/4427</b> (2006.01)		
	<b>A61K 31/4709</b> (2006.01)		
	<b>A61K 31/497</b> (2006.01)		
	<b>A61P 35/00</b> (2006.01)		
	<b>C07D 401/14</b> (2006.01)		
	<b>C07D 417/14</b> (2006.01)		
	<b>C07D 471/04</b> (2006.01)		
	<b>C07D 491/048</b> (2006.01)		
	<b>C07D 495/04</b> (2006.01)		
	<b>A61K 31/437</b> (2006.01)	3674302	1H-PYRROLO[2,3-C]PYRIDIN-7(6H)-ONES AND PYRAZOLO[3,4-C]PYRIDIN-7(6H)-ONES AS INHIBITORS OF BET PROTEINS
	<b>A61P 9/10</b> (2006.01)		
	<b>A61P 11/06</b> (2006.01)		
	<b>A61P 25/24</b> (2006.01)		
	<b>A61P 25/28</b> (2006.01)		
	<b>A61P 31/00</b> (2006.01)		
	<b>A61P 33/00</b> (2006.01)		
	<b>A61P 35/00</b> (2006.01)		
	<b>A61P 37/00</b> (2006.01)		



Podnosilac evropske prijave patenta (71)	MKP (51)	Broj objave evropske prijave patenta (97)	Naziv pronalaska (54)
K-Uni Kunststoffproduktions- und Handels-GmbH	<b>C07D 471/04</b> (2006.01) <b>A61J 7/00</b> (2006.01) <b>A61M 1/02</b> (2006.01) <b>A61M 1/14</b> (2006.01) <b>A61M 1/16</b> (2006.01) <b>A61M 1/18</b> (2006.01) <b>A61M 5/307</b> (2006.01) <b>A61M 5/315</b> (2006.01)	3682915	APPARATUS AND METHODS FOR DISPENSING ORAL TRANSMUCOSAL DOSAGE FORMS
	<b>E04F 13/00</b> (2006.01) <b>E04F 13/06</b> (2006.01) <b>E06B 1/62</b> (2006.01)	3699371	CONNECTION PROFILE FOR COMPONENTS BORDERING PLASTER
	<b>C07K 14/00</b> (2006.01) <b>C07K 14/735</b> (2006.01) <b>C12N 15/85</b> (2006.01)	3693383	MOUSE-HUMAN FC-GAMMA-RI PROTEINS AND ENCODING DNA
	<b>A61K 31/437</b> (2006.01) <b>A61K 31/506</b> (2006.01) <b>A61P 35/00</b> (2006.01) <b>C07D 401/02</b> (2006.01)	3686193	2-(2,4,5-SUBSTITUTED-ANILINO)PYRIMIDINE COMPOUNDS
	<b>C07D 471/04</b> (2006.01) <b>A61K 31/437</b> (2006.01) <b>A61K 31/506</b> (2006.01) <b>A61P 35/00</b> (2006.01) <b>C07D 401/02</b> (2006.01)	3686194	2-(2,4,5-SUBSTITUTED-ANILINO)PYRIMIDINE COMPOUNDS
	<b>C07D 471/04</b> (2006.01) <b>A61K 31/52</b> (2006.01) <b>A61K 47/68</b> (2017.01) <b>A61P 35/00</b> (2006.01) <b>C07D 487/04</b> (2006.01) <b>C07H 15/26</b> (2006.01)	3797797	ANTIBODY CONJUGATES COMPRISING TOLL-LIKE RECEPTOR AGONIST
	<b>A61K 31/4162</b> (2006.01) <b>A61K 31/437</b> (2006.01) <b>A61K 31/4745</b> (2006.01) <b>A61P 25/00</b> (2006.01) <b>A61P 25/14</b> (2006.01) <b>A61P 25/16</b> (2006.01)	3689874	1H-PYRAZOLO[4,3-B]PYRIDINES AS PDE1 INHIBITORS

Podnosilac evropske prijave patenta (71)	MKP (51)	Broj objave evropske prijave patenta (97)	Naziv pronalaska (54)
	<b>A61P 25/18</b> (2006.01)		
	<b>A61P 25/22</b> (2006.01)		
	<b>A61P 25/24</b> (2006.01)		
	<b>A61P 25/28</b> (2006.01)		
	<b>A61P 43/00</b> (2006.01)		
	<b>C07D 305/06</b> (2006.01)		
	<b>C07D 401/04</b> (2006.01)		
	<b>C07D 413/04</b> (2006.01)		
	<b>C07D 471/04</b> (2006.01)		
	<b>C07K 16/24</b> (2006.01)	3683235	ANTI-IL-33 ANTIBODIES AND USES THEREOF
	<b>A61K 35/26</b> (2015.01)	3708579	CLAUDIN-6-SPECIFIC IMMUNORECEPTORS AND T CELL EPITOPES
	<b>A61P 35/00</b> (2006.01)		
	<b>C07K 14/47</b> (2006.01)		
	<b>C07K 14/725</b> (2006.01)		
	<b>A61B 17/00</b> (2006.01)	3679869	SURGICAL STAPLING INSTRUMENT WITH SHAFT RELEASE
	<b>A61B 17/072</b> (2006.01)		
	<b>A61B 17/29</b> (2006.01)		
	<b>A61B 90/00</b> (2016.01)		
	<b>A61B 90/98</b> (2016.01)		
	<b>A61K 39/00</b> (2006.01)	3693395	ST2 ANTIGEN BINDING PROTEINS
	<b>A61P 1/04</b> (2006.01)		
	<b>A61P 7/00</b> (2006.01)		
	<b>A61P 9/00</b> (2006.01)		
	<b>A61P 11/00</b> (2006.01)		
	<b>A61P 11/02</b> (2006.01)		
	<b>A61P 17/00</b> (2006.01)		
	<b>A61P 17/02</b> (2006.01)		
	<b>A61P 19/02</b> (2006.01)		
	<b>A61P 19/08</b> (2006.01)		
	<b>A61P 25/00</b> (2006.01)		
	<b>A61P 27/16</b> (2006.01)		
	<b>A61P 29/00</b> (2006.01)		
	<b>A61P 31/04</b> (2006.01)		
	<b>A61P 35/00</b> (2006.01)		
	<b>A61P 37/00</b> (2006.01)		

Podnosilac evropske prijave patenta (71)	MKP (51)	Broj objave evropske prijave patenta (97)	Naziv pronalaska (54)
	<b>A61P 37/02</b> (2006.01)		
	<b>A61P 37/06</b> (2006.01)		
	<b>A61P 37/08</b> (2006.01)		
	<b>A61P 43/00</b> (2006.01)		
	<b>C07K 16/28</b> (2006.01)		
	<b>A61K 31/445</b> (2006.01)	3682879	PROCESSES AND INTERMEDIATES IN THE PREPARATION OF C5AR ANTAGONISTS
	<b>C07D 211/60</b> (2006.01)		
Nikki Co., Ltd.	<b>F02D 11/10</b> (2006.01)	3708813	ELECTRONICALLY CONTROLLED THROTTLE CONTROL DEVICE
	<b>F02D 41/14</b> (2006.01)		
Fr. Sauter AG	<b>G05B 19/418</b> (2006.01)	3709113	DATA INTEGRITY TESTING METHOD
	<b>G06F 21/64</b> (2013.01)		
	<b>H04L 9/32</b> (2006.01)		
Coherus Biosciences, Inc.	<b>C12N 5/02</b> (2006.01)	3683316	PERFUSION MEDIA
	<b>C12P 21/02</b> (2006.01)		
	<b>A61K 9/48</b> (2006.01)	3689380	CALCIFEDIOL SOFT CAPSULES
	<b>A61K 31/047</b> (2006.01)		
	<b>A61K 47/14</b> (2017.01)		
	<b>A61P 1/00</b> (2006.01)		
	<b>A61P 1/04</b> (2006.01)		
	<b>A61P 3/02</b> (2006.01)		
	<b>A61P 3/12</b> (2006.01)		
	<b>A61P 3/14</b> (2006.01)		
	<b>A61P 5/18</b> (2006.01)		
	<b>A61P 7/00</b> (2006.01)		
	<b>A61P 13/12</b> (2006.01)		
	<b>A61P 19/00</b> (2006.01)		
	<b>A61P 19/02</b> (2006.01)		
	<b>A61P 19/08</b> (2006.01)		
	<b>A61P 19/10</b> (2006.01)		
	<b>A61P 43/00</b> (2006.01)		
	<b>A61K 31/27</b> (2006.01)	3698782	CARBAMATE COMPOUNDS FOR USE IN THERAPY
	<b>A61K 31/325</b> (2006.01)		
	<b>C07C 269/00</b> (2006.01)		
	<b>C07C 271/00</b> (2006.01)		
	<b>C07C 271/62</b> (2006.01)		

Podnosilac evropske prijave patenta (71)	MKP (51)	Broj objave evropske prijave patenta (97)	Naziv pronalaska (54)
Institut Pasteur de Dakar Berthet, François Xavier	<b>C07D 203/20</b> (2006.01)	3788120	NANO ENCODING TECHNOLOGY FOR THE TRACKING OF INFORMATION IN LIQUID SAMPLES
	<b>C09K 11/56</b> (2006.01)		
	<b>C09K 11/88</b> (2006.01)		
	<b>G01N 21/64</b> (2006.01)	3788074	ANTIBODY VARIANT COMBINATIONS AND USES THEREOF
	<b>A61K 39/00</b> (2006.01)		
	<b>A61P 35/00</b> (2006.01)		
	<b>C07K 16/28</b> (2006.01)	3793553	1,3-THIAZOL-2-YL SUBSTITUTED BENZAMIDES FOR THE TREATMENT OF DISEASES ASSOCIATED WITH NERVE FIBER SENSITIZATION
	<b>C07K 16/46</b> (2006.01)		
	<b>A61K 31/427</b> (2006.01)		
	<b>A61P 9/04</b> (2006.01)		
	<b>A61P 9/10</b> (2006.01)		
	<b>A61P 9/12</b> (2006.01)		
	<b>A61P 25/28</b> (2006.01)		
	<b>C07D 401/12</b> (2006.01)		
	<b>C07D 401/14</b> (2006.01)		
	<b>C07D 403/04</b> (2006.01)		
	<b>C07D 403/12</b> (2006.01)	3788040	PYRIDAZINONES AS PARP7 INHIBITORS
	<b>C07D 405/14</b> (2006.01)		
	<b>C07D 413/14</b> (2006.01)		
	<b>C07D 417/12</b> (2006.01)		
<b>C07D 417/14</b> (2006.01)			
<b>C07D 451/02</b> (2006.01)			
<b>C07D 471/04</b> (2006.01)			
<b>C07D 471/08</b> (2006.01)			
<b>C07D 471/10</b> (2006.01)			
<b>C07D 487/04</b> (2006.01)			
<b>C07D 487/08</b> (2006.01)	3784804	SELECTING PATIENTS FOR THERAPY WITH ADENOSINE SIGNALING INHIBITORS	
<b>C07D 487/10</b> (2006.01)			
<b>C12Q 1/6886</b> (2018.01)	3790884	TETRACYCLIC HETEROARYL COMPOUNDS	
CIS Pharma AG	<b>A61K 31/55</b> (2006.01)	3790590	BIOCOMPATIBLE COPOLYMER CONTAINING MULTIPLE ACTIVE AGENT MOLECULES
	<b>A61P 35/00</b> (2006.01)		
	<b>C07D 498/14</b> (2006.01)		
	<b>A61K 47/54</b> (2017.01)		
	<b>A61K 47/58</b> (2017.01)		
	<b>A61K 47/64</b> (2017.01)		

Podnosilac evropske prijave patenta (71)	MKP (51)	Broj objave evropske prijave patenta (97)	Naziv pronalaska (54)		
Centre Hospitalier Régional et Universitaire de Brest Etablissement Français du Sang Institut National de la Santé et de la Recherche Médicale (INSERM) Université de Bretagne Occidentale	<b>A61K 47/65</b> (2017.01)	3794355	BLOOD BIOMARKERS OF STROKE		
	<b>A61K 47/68</b> (2017.01)				
	<b>A61K 51/06</b> (2006.01)				
	<b>A61K 51/10</b> (2006.01)				
	<b>A61P 35/00</b> (2006.01)				
	<b>G01N 33/68</b> (2006.01)				
	<b>A61P 3/00</b> (2006.01)			3788037	SUBSTITUTED PYRIMIDINONES AS AGONISTS OF THE APJ RECEPTOR
	<b>A61P 9/00</b> (2006.01)				
	<b>A61P 13/12</b> (2006.01)				
	<b>C07D 239/545</b> (2006.01)				
<b>C07D 401/12</b> (2006.01)					
<b>C07D 401/14</b> (2006.01)					
<b>C07D 403/14</b> (2006.01)					
<b>C07D 405/14</b> (2006.01)					
<b>A61K 31/427</b> (2006.01)	3793554	1,3-THIAZOL-2-YL SUBSTITUTED BENZAMIDES FOR THE TREATMENT OF DISEASES ASSOCIATED WITH NERVE FIBER SENSITIZATION			
<b>A61P 11/00</b> (2006.01)					
<b>A61P 11/06</b> (2006.01)					
<b>A61P 11/14</b> (2006.01)					
<b>A61P 25/28</b> (2006.01)					
<b>A61K 31/537</b> (2006.01)			3784676	POLYMORPHIC FORMS OF BICTEGRAVIR AND ITS SODIUM SALT	
<b>A61P 31/18</b> (2006.01)					
<b>C07D 498/18</b> (2006.01)					
SAUDI ARAMCO TECHNOLOGIES COMPANY	<b>C08G 64/02</b> (2006.01)	3781609	END-GROUP ISOMERIZATION OF POLY(ALKYLENE CARBONATE) POLYMERS		
	<b>C08G 64/42</b> (2006.01)				
	<b>C08L 69/00</b> (2006.01)				
	<b>A61K 31/553</b> (2006.01)	3788044	RIP1 INHIBITORY COMPOUNDS AND METHODS FOR MAKING AND USING THE SAME		
	<b>A61P 29/00</b> (2006.01)				
	<b>A61P 37/02</b> (2006.01)				
	<b>C07D 413/12</b> (2006.01)				
	<b>C07D 413/14</b> (2006.01)				
	<b>A61K 39/395</b> (2006.01)			3788076	ANTIBODIES WITH MODULATED GLYCAN PROFILES

Podnosilac evropske prijave patenta (71)	MKP (51)	Broj objave evropske prijave patenta (97)	Naziv pronalaska (54)
Kanu, Ifeyinwa Rita	<b>C07K 16/28</b> (2006.01)	3781523	WASTEWATER TREATMENT APPARATUS AND METHOD
	<b>C02F 1/04</b> (2006.01)		
	<b>C02F 3/28</b> (2006.01)	3788045	RIP1 INHIBITORY COMPOUNDS AND METHODS FOR MAKING AND USING THE SAME
	<b>C02F 11/04</b> (2006.01)		
	<b>A61K 31/553</b> (2006.01)	3788046	SALTS OF AN FGFR INHIBITOR
	<b>A61P 29/00</b> (2006.01)		
	<b>A61P 37/02</b> (2006.01)	3788047	SOLID FORMS OF AN FGFR INHIBITOR AND PROCESSES FOR PREPARING THE SAME
	<b>C07D 413/12</b> (2006.01)		
	<b>C07D 413/14</b> (2006.01)	3787599	NEW TREATMENT OF INTERSTITIAL LUNG DISEASES
	<b>A61K 31/519</b> (2006.01)		
INIM PHARMA AB	<b>A61P 35/00</b> (2006.01)	3790564	COMPOSITIONS COMPRISING BACTERIAL STRAINS
	<b>C07D 471/14</b> (2006.01)		
	<b>A61K 31/519</b> (2006.01)	3793559	SUBSTITUTED DIHYDROPYRAZOLO PYRAZINE CARBOXAMIDE DERIVATIVES
	<b>A61P 35/00</b> (2006.01)		
	<b>C07D 471/14</b> (2006.01)	3788053	KRAS G12C INHIBITORS AND METHODS OF USING THE SAME
	<b>A61K 9/12</b> (2006.01)		
	<b>A61K 9/51</b> (2006.01)	3790564	COMPOSITIONS COMPRISING BACTERIAL STRAINS
	<b>A61K 31/454</b> (2006.01)		
	<b>A23L 33/135</b> (2016.01)	3793559	SUBSTITUTED DIHYDROPYRAZOLO PYRAZINE CARBOXAMIDE DERIVATIVES
	<b>A61K 35/74</b> (2015.01)		
<b>A61P 1/00</b> (2006.01)	3793559	SUBSTITUTED DIHYDROPYRAZOLO PYRAZINE CARBOXAMIDE DERIVATIVES	
<b>A61P 3/10</b> (2006.01)			
<b>A61P 11/06</b> (2006.01)	3793559	SUBSTITUTED DIHYDROPYRAZOLO PYRAZINE CARBOXAMIDE DERIVATIVES	
<b>A61P 17/06</b> (2006.01)			
<b>A61P 19/02</b> (2006.01)	3793559	SUBSTITUTED DIHYDROPYRAZOLO PYRAZINE CARBOXAMIDE DERIVATIVES	
<b>A61P 35/00</b> (2006.01)			
<b>A61P 37/00</b> (2006.01)	3793559	SUBSTITUTED DIHYDROPYRAZOLO PYRAZINE CARBOXAMIDE DERIVATIVES	
<b>A61P 43/00</b> (2006.01)			
<b>A61K 31/4985</b> (2006.01)	3793559	SUBSTITUTED DIHYDROPYRAZOLO PYRAZINE CARBOXAMIDE DERIVATIVES	
<b>A61P 7/00</b> (2006.01)			
<b>A61P 27/02</b> (2006.01)	3793559	SUBSTITUTED DIHYDROPYRAZOLO PYRAZINE CARBOXAMIDE DERIVATIVES	
<b>C07D 487/04</b> (2006.01)			
AMGEN INC.	<b>A61K 31/553</b> (2006.01)	3788053	KRAS G12C INHIBITORS AND METHODS OF USING THE SAME
	<b>A61K 45/06</b> (2006.01)		
	<b>C07F 9/6561</b> (2006.01)		

Podnosilac evropske prijave patenta (71)	MKP (51)	Broj objave evropske prijave patenta (97)	Naziv pronalaska (54)	
Regulus Therapeutics Inc.	<b>A61K 31/7125</b> (2006.01)	3790972	GALNAC CONJUGATED MODIFIED OLIGONUCLEOTIDE AS MIR-122 INHIBITOR HAVING HCV ANTIVIRAL ACTIVITY WITH REDUCED HYPERBILIRUBINEMIA SIDE-EFFECT	
	<b>A61P 31/14</b> (2006.01)			
	<b>C12N 15/113</b> (2010.01)	3790899	ANTI-MSR1 ANTIBODIES AND METHODS OF USE THEREOF	
	<b>A61K 47/68</b> (2017.01)			
	<b>C07K 16/28</b> (2006.01)	3790886	KRAS G12C INHIBITORS FOR THE TREATMENT OF CANCER	
	<b>A61K 31/549</b> (2006.01)			
	<b>A61P 35/00</b> (2006.01)	3790877	TETRAHYDRO-IMIDAZO[4,5-C]PYRIDINE DERIVATIVES AS PD-L1 IMMUNOMODULATORS	
	<b>C07D 513/04</b> (2006.01)			
	<b>A61K 31/437</b> (2006.01)	3790897	C3-BINDING AGENTS AND METHODS OF USE THEREOF	
	<b>A61P 35/00</b> (2006.01)			
	<b>A61P 37/00</b> (2006.01)	3797134	SURFACE-TREATED FILLERS FOR POLYESTER FILMS	
	<b>C07D 471/04</b> (2006.01)			
	Cognigni, Walter	<b>A61P 27/02</b> (2006.01)	3781746	IMPROVED LANE SEPARATOR FOR CYCLE PATHS
		<b>C07K 16/18</b> (2006.01)		
<b>B32B 27/36</b> (2006.01)		3784663	SUBSTITUTED 4-AMINOISOINDOLINE-1,3-DIONE COMPOUNDS AND THEIR USE FOR TREATING LYMPHOMA	
<b>C08J 5/18</b> (2006.01)				
<b>C08K 9/02</b> (2006.01)		3784666	ANTIPROLIFERATION COMPOUNDS AND USES THEREOF	
<b>C08K 9/04</b> (2006.01)				
<b>C08K 9/06</b> (2006.01)		3784694	METHODS AND COMPOSITIONS OF CYTOTOXIC T CELL DEPLETION	
<b>C09C 1/02</b> (2006.01)				
Merck Patent GmbH		<b>E01F 9/588</b> (2016.01)	3784666	ANTIPROLIFERATION COMPOUNDS AND USES THEREOF
		<b>A61K 31/454</b> (2006.01)		
	<b>A61P 35/00</b> (2006.01)	3784694	METHODS AND COMPOSITIONS OF CYTOTOXIC T CELL DEPLETION	
	<b>C07D 401/04</b> (2006.01)			
	<b>C07D 401/14</b> (2006.01)	3784666	ANTIPROLIFERATION COMPOUNDS AND USES THEREOF	
	<b>C07D 417/14</b> (2006.01)			
	<b>C07D 491/08</b> (2006.01)	3784694	METHODS AND COMPOSITIONS OF CYTOTOXIC T CELL DEPLETION	
	<b>C07D 491/10</b> (2006.01)			
Merck Patent GmbH	<b>A61K 31/553</b> (2006.01)	3784666	ANTIPROLIFERATION COMPOUNDS AND USES THEREOF	
	<b>A61P 35/00</b> (2006.01)			
	<b>C07D 403/04</b> (2006.01)	3784694	METHODS AND COMPOSITIONS OF CYTOTOXIC T CELL DEPLETION	
	<b>C07D 409/14</b> (2006.01)			
	<b>C07D 413/04</b> (2006.01)	3784694	METHODS AND COMPOSITIONS OF CYTOTOXIC T CELL DEPLETION	
	<b>C07D 413/14</b> (2006.01)			
<b>A61K 39/00</b> (2006.01)	3784694	METHODS AND COMPOSITIONS OF CYTOTOXIC T CELL DEPLETION		

Podnosilac evropske prijave patenta (71)	MKP (51)	Broj objave evropske prijave patenta (97)	Naziv pronalaska (54)						
Temple University - Of The Commonwealth System of Higher Education	<b>A61P 37/06</b> (2006.01)	3790859	NOVEL FUNCTIONALIZED LACTAMS AS MODULATORS OF THE 5-HYDROXYTRYPTAMINE RECEPTOR 7 AND THEIR METHOD OF USE						
	<b>C07K 14/725</b> (2006.01)								
	<b>C07K 14/74</b> (2006.01)								
	<b>C12N 15/113</b> (2010.01)								
	<b>A61K 31/4015</b> (2006.01)			3790548	METHODS FOR ENHANCING THE BIOAVAILABILITY AND EXPOSURE OF A VOLTAGE-GATED POTASSIUM CHANNEL OPENER				
	<b>A61K 31/497</b> (2006.01)								
	<b>A61P 25/00</b> (2006.01)								
	<b>C07D 207/20</b> (2006.01)								
	<b>C07D 209/96</b> (2006.01)								
	<b>C07D 401/06</b> (2006.01)								
	<b>C07D 401/12</b> (2006.01)								
	<b>C07D 471/10</b> (2006.01)								
	<b>C07D 487/04</b> (2006.01)								
	<b>A61K 31/472</b> (2006.01)					3790532	HIGH CONCENTRATION VEGF RECEPTOR FUSION PROTEIN CONTAINING FORMULATIONS		
	<b>A61P 25/08</b> (2006.01)								
	<b>A61K 9/00</b> (2006.01)								
	<b>A61K 9/08</b> (2006.01)								
	<b>A61K 38/17</b> (2006.01)								
	<b>A61K 47/22</b> (2006.01)								
	<b>A61K 47/26</b> (2006.01)								
	<b>A61P 27/02</b> (2006.01)								
	<b>A61K 38/09</b> (2006.01)			3784346	A COMPOSITION FOR TREATING ONE OR MORE ESTROGEN RELATED DISEASES				
	<b>A61P 5/30</b> (2006.01)								
	<b>A61P 35/00</b> (2006.01)					3784664	2-AMINO-PYRIDINE OR 2-AMINO-PYRIMIDINE DERIVATIVES AS CYCLIN DEPENDENT KINASE INHIBITORS		
	<b>C07D 401/14</b> (2006.01)								
	<b>C07D 405/14</b> (2006.01)								
	<b>C07D 487/04</b> (2006.01)								
	<b>C07D 498/04</b> (2006.01)								
	<b>A61K 35/17</b> (2015.01)							3787751	COMBINATION THERAPY OF A CHIMERIC ANTIGEN RECEPTOR (CAR) T CELL THERAPY AND A KINASE INHIBITOR
	<b>A61K 39/00</b> (2006.01)								
<b>A61P 35/00</b> (2006.01)									
<b>C07K 16/18</b> (2006.01)	3790904	BISPECIFIC ANTIBODIES WITH CLEAVABLE C-TERMINAL CHARGE-PAIRED TAGS							
<b>C07K 16/24</b> (2006.01)									
<b>C07K 16/28</b> (2006.01)									
<b>C07K 16/46</b> (2006.01)									



Podnosilac evropske prijave patenta (71)	MKP (51)	Broj objave evropske prijave patenta (97)	Naziv pronalaska (54)	
Centro de Investigación y Desarrollo de Medicamentos (CIDEM)	<b>A61K 31/137</b> (2006.01)	3789020	FIXED DOSE COMPOSITION OF PARACETAMOL: AMITRIPTYLINE AND METHOD FOR THE TREATMENT OF MIXED CANCER PAIN	
	<b>A61K 31/167</b> (2006.01)			
	<b>A61K 31/519</b> (2006.01)	3784670	NLRP3 MODULATORS	
	<b>A61P 35/00</b> (2006.01)			
	<b>C07D 471/04</b> (2006.01)	3790417	DEVICE FOR SMOKING A SMOKEABLE MATERIAL	
	<b>C07D 498/04</b> (2006.01)			
	<b>C07D 513/04</b> (2006.01)			
	<b>C07D 519/00</b> (2006.01)			
	<b>A24D 1/14</b> (2006.01)			
	<b>A24F 1/30</b> (2006.01)			
ARIES	<b>A24D 1/14</b> (2006.01)	3790415	DEVICE FOR SMOKING A SMOKEABLE MATERIAL	
Xtaper Limited	<b>B65H 35/00</b> (2006.01)	3781505	DISPENSER APPARATUS FOR ADHESIVE TAPE	
	<b>A61K 9/127</b> (2006.01)	3794008	RIBOSE CATIONIC LIPIDS	
<b>A61K 47/26</b> (2006.01)				
<b>C07H 13/06</b> (2006.01)				
<b>C07H 13/12</b> (2006.01)				
<b>C07H 15/04</b> (2006.01)				
<b>C07H 15/10</b> (2006.01)				
<b>C07H 15/26</b> (2006.01)				
<b>A61K 38/47</b> (2006.01)	3793591			ANTI-CD63 ANTIBODIES, CONJUGATES, AND USES THEREOF
<b>A61P 43/00</b> (2006.01)				
<b>C07K 16/28</b> (2006.01)				
<b>C12N 9/34</b> (2006.01)				
<b>A61K 39/395</b> (2006.01)	3793607			TREATMENT OF CANCER
<b>A61K 45/06</b> (2006.01)				
<b>A61P 35/00</b> (2006.01)	3765011	CAPSID ASSEMBLY MODULATOR DOSING REGIMEN		
<b>A61K 31/40</b> (2006.01)				
<b>A61K 31/454</b> (2006.01)				
<b>A61K 45/06</b> (2006.01)	3787620	COMBINATIONS FOR TREATING CANCER		
<b>A61K 31/4162</b> (2006.01)				
<b>A61K 31/4985</b> (2006.01)				
<b>A61P 35/00</b> (2006.01)				
<b>A61P 35/02</b> (2006.01)				
ADC Therapeutics SA	<b>A61K 47/68</b> (2017.01)	3796942	MOLECULAR ADJUVANT	
	<b>A61P 35/00</b> (2006.01)			

Podnosilac evropske prijave patenta (71)	MKP (51)	Broj objave evropske prijave patenta (97)	Naziv pronalaska (54)
Università Degli Studi Di Torino Fondazione del Piemonte Per L'Oncologia Manifattura Pri.Ma.Tex S.r.l.	<b>C07K 16/28</b> (2006.01) <b>A61K 9/00</b> (2006.01) <b>A61K 9/19</b> (2006.01) <b>A61K 31/4178</b> (2006.01) <b>A61K 47/10</b> (2017.01)	3796889	DANTROLENE FORMULATIONS AND METHODS OF THEIR USE
	<b>G06T 7/136</b> (2017.01) <b>G06T 7/143</b> (2017.01)	3791361	TUMORAL MASS DETECTION SYSTEM BASED ON MAGNETIC RESONANCE IMAGING
	<b>A41D 31/00</b> (2019.01) <b>D03D 1/00</b> (2006.01) <b>D03D 11/00</b> (2006.01) <b>D03D 13/00</b> (2006.01) <b>D03D 15/00</b> (2021.01) <b>D03D 15/08</b> (2006.01) <b>D03D 15/10</b> (2006.01)	3796802	TEXTILE ARTICLE FOR MOTORCYCLIST PROTECTIVE CLOTHING
	<b>A61K 9/127</b> (2006.01) <b>A61K 9/51</b> (2006.01) <b>A61K 31/7088</b> (2006.01) <b>A61K 31/519</b> (2006.01) <b>A61P 35/00</b> (2006.01) <b>C07D 403/04</b> (2006.01) <b>C07D 403/14</b> (2006.01) <b>C07D 471/04</b> (2006.01) <b>C07D 487/04</b> (2006.01)	3796893	DELIVERY OF DNA
	<b>C07D 211/02</b> (2006.01) <b>C07D 211/34</b> (2006.01)	3788038	KRAS G12C INHIBITORS AND METHODS OF USING THE SAME
	<b>A61K 31/496</b> (2006.01) <b>A61K 39/395</b> (2006.01) <b>A61K 47/68</b> (2017.01) <b>C07K 16/28</b> (2006.01) <b>C07K 16/30</b> (2006.01)	3784655	PROCESS FOR PREPARING 2-(1-(TERT-BUTOXYCARBONYL)PIPERIDINE-4-YL)BENZOIC ACID
	<b>G01N 33/50</b> (2006.01)	3784239	PHARMACEUTICAL COMBINATIONS
	<b>A61K 39/00</b> (2006.01) <b>C07K 14/005</b> (2006.01) <b>C07K 14/19</b> (2006.01)	3785029	COMPOSITIONS AND METHODS FOR EVALUATING POTENCY OF LISTERIA-BASED IMMUNOTHERAPEUTICS
		3784688	HEAT SHOCK PROTEIN-BINDING PEPTIDE COMPOSITIONS AND METHODS OF USE THEREOF

Podnosilac evropske prijave patenta (71)	MKP (51)	Broj objave evropske prijave patenta (97)	Naziv pronalaska (54)
	<b>C07K 14/47</b> (2006.01)		
	<b>A61K 31/53</b> (2006.01)	3793994	INHIBITING AGENTS FOR BRUTON'S TYROSINE KINASE
	<b>A61K 31/55</b> (2006.01)		
	<b>A61P 37/00</b> (2006.01)		
	<b>C07D 403/14</b> (2006.01)		
	<b>C07D 405/14</b> (2006.01)		
	<b>C07D 413/14</b> (2006.01)		
	<b>A61K 31/7034</b> (2006.01)	3794009	BIARYL AMIDES WITH MODIFIED SUGAR GROUPS FOR TREATMENT OF DISEASES ASSOCIATED WITH HEAT SHOCK PROTEIN PATHWAY
	<b>A61P 3/10</b> (2006.01)		
	<b>A61P 25/02</b> (2006.01)		
	<b>C07D 309/06</b> (2006.01)		
	<b>C07H 1/00</b> (2006.01)		
	<b>C07H 15/203</b> (2006.01)		
	<b>A61K 38/36</b> (2006.01)	3793588	METHODS OF TREATING HEMOPHILIA A
	<b>A61K 38/37</b> (2006.01)		
	<b>A61P 7/04</b> (2006.01)		
	<b>A61K 47/60</b> (2017.01)	3796940	SELECTIVE TREG STIMULATOR RUR20KD-IL-2 AND RELATED COMPOSITIONS
	<b>A61P 37/00</b> (2006.01)		
	<b>A61K 38/51</b> (2006.01)	3794126	COMPOSITIONS AND METHODS FOR THE TREATMENT OF PARKINSON'S DISEASE
	<b>A61K 48/00</b> (2006.01)		
	<b>C12N 15/62</b> (2006.01)		
	<b>C12N 15/86</b> (2006.01)		
	<b>B29C 64/106</b> (2017.01)	3784472	METHOD AND APPARATUS FOR ADDITIVE MANUFACTURING
	<b>B29C 64/118</b> (2017.01)		
	<b>B29C 64/245</b> (2017.01)		
	<b>B29C 64/379</b> (2017.01)		
	<b>B29C 64/40</b> (2017.01)		
	<b>B33Y 10/00</b> (2015.01)		
	<b>B33Y 70/00</b> (2020.01)		
	<b>A61K 39/00</b> (2006.01)	3793599	BCMA/CD3 AND GPRDC5D/CD3 BISPECIFIC ANTIBODIES FOR USE IN CANCER THERAPY
	<b>A61K 39/395</b> (2006.01)		
	<b>A61K 45/06</b> (2006.01)		
	<b>C07K 16/28</b> (2006.01)		
	<b>C07K 16/30</b> (2006.01)		
	<b>A01N 25/10</b> (2006.01)	3793358	ANTIMICROBIAL COMPOSITION BASED ON POLYPHENOLS AND POLYSACCHARIDES,

Podnosilac evropske prijave patenta (71)	MKP (51)	Broj objave evropske prijave patenta (97)	Naziv pronalaska (54)
	<b>A01N 25/34</b> (2006.01) <b>A01N 35/04</b> (2006.01) <b>A01N 37/24</b> (2006.01) <b>A01N 65/12</b> (2009.01) <b>A01N 65/20</b> (2009.01) <b>A01N 65/48</b> (2009.01) <b>A01P 1/00</b> (2006.01) <b>A61K 9/20</b> (2006.01) <b>A61K 31/11</b> (2006.01) <b>A61K 31/167</b> (2006.01) <b>A61K 36/28</b> (2006.01) <b>A61K 36/484</b> (2006.01) <b>A61K 36/9062</b> (2006.01)		METHOD FOR PREPARING THEREOF AND USE OF THE SAME
EMMAUS MEDICAL, INC.	<b>A61K 31/365</b> (2006.01) <b>A61K 31/551</b> (2006.01) <b>A61K 45/06</b> (2006.01)	3790545	METHODS AND COMPOSITIONS FOR THE TREATMENT OF SICKLE CELL DISEASES AND THALASSEMIA
Takeda Pharmaceutical Company Limited	<b>A61P 3/00</b> (2006.01) <b>C07K 16/28</b> (2006.01)	3787746	CANNABINOID RECEPTOR TYPE 1 (CB1) BINDING PROTEINS AND USES THEREOF
	<b>A61K 9/28</b> (2006.01) <b>A61K 31/606</b> (2006.01)	3662900	COLONIC DRUG DELIVERY FORMULATION
	<b>A61K 9/20</b> (2006.01) <b>A61K 9/28</b> (2006.01) <b>A61K 31/606</b> (2006.01)	3662898	SOLID COMPOSITION COMPRISING MESALAZINE
	<b>A61K 9/16</b> (2006.01) <b>A61K 9/20</b> (2006.01) <b>A61K 31/606</b> (2006.01)	3662895	A PROCESS FOR MANUFACTURING REDUCING SUGAR-FREE 5-ASA TABLET CORES
	<b>A61K 9/20</b> (2006.01) <b>A61K 9/28</b> (2006.01) <b>A61K 9/48</b> (2006.01) <b>A61K 31/606</b> (2006.01)	3662901	DELAYED RELEASE DRUG FORMULATION COMPRISING AN OUTER LAYER WITH AN ENZYMICALLY DEGRADABLE POLYMER, ITS COMPOSITION AND ITS METHOD OF MANUFACTURING
	<b>A61K 9/28</b> (2006.01) <b>F04C 18/02</b> (2006.01) <b>F04C 27/00</b> (2006.01) <b>F04C 29/00</b> (2006.01)	3662902 3667086	COLONIC DRUG DELIVERY FORMULATION SPIRAL-TYPE DISPLACEMENT MACHINE, IN PARTICULAR A DISPLACEMENT MACHINE FOR A VEHICLE AIR-CONDITIONING SYSTEM



## **ŽIGOVI** **TRADEMARKS**

### **MEĐUNARODNI KODOVI ZA IDENTIFIKACIJU BIBLIOGRAFSKIH PODATAKA O ŽIGOVIMA PREMA WIPO ST 60**

**Recommendation concerning bibliographic data relating to trademarks- WIPO- ST 60**

<b>CRNOGORSKI</b>	<b>MDK</b>	<b>ENGLESKI</b>
REGISTRARSKI BROJ	<b>111</b>	NUMBER OF THE REGISTRATION
DATUM REGISTRACIJE	<b>151</b>	DATE OF THE REGISTRATION
OČEKIVANI DATUM PRESTANKA VAŽENJA ŽIGA	<b>181</b>	EXPECTED EXPIRATION DATE OF THE REGISTRATION
BROJ PRIJAVE	<b>210</b>	NUMBER OF THE APPLICATION
DATUM PODNOŠENJA PRIJAVE	<b>220</b>	DATE OF FILING OF THE APPLICATION
PODACI O IZLOŽBENOM PRAVU PRVENSTVA	<b>230</b>	DATA CONCERNING EXHIBITIONS
PODACI O PRAVU PRVENSTVA NA OSNOVU PARISKE KONVENCIJE	<b>300</b>	DATA RELATING TO PRIORITY UNDER THE PARIS CONVENTION
DATUM OBJAVLJIVANJA PRIJAVE	<b>442</b>	DATA OF PUBLICATION OF APPLICATION
SPISAK ROBA I USLUGA PREMA NIČANSKOJ KLASIFIKACIJI ROBA I USLUGA	<b>511</b>	LIST OF GOODS AND SERVICES ACCORDING THE NICE CLASSIFICATION OF GOODS AND SERVICE
IZJAVA PODNOSIOCA PRIJAVE DA NE TRAŽE EKSKLUZIVNO PRAVO ZA POJEDINE NEDINSTIKTIVNE ELEMENTE ZNAKA	<b>526</b>	DISCLAIMER
IZGLED ZNAKA	<b>540</b>	REPRODUCTION OF THE MARK
NAZNAKA O PRIRODI ILI VRSTI ZNAKA	<b>550</b>	INDICATION RELATING TO THE NATURE OR KIND OF MARK
INFORMACIJA O ZATRAŽENIM BOJAMA NA ZNAKU	<b>591</b>	INFORMATION CONCERNING THE COLORS CLAIMED
PODACI O PODNOSIOCU PRIJAVE	<b>731</b>	NAME AND ADDRESS OF THE APPLICANT
IME I ADRESA NOSIOCA ŽIGA	<b>732</b>	NAME AND ADDRESS OF THE HOLDER OF THE REGISTRATION
INFORMACIJA O ZATRAŽENIM BOJAMA NA ZNAKU	<b>591</b>	INFORMATION CONCERNING THE COLORS CLAIMED

PODACI O PODNOSIOCU PRIJAVE	<b>731</b>	NAME AND ADDRESS OF THE APPLICANT
IME I ADRESA NOSIOCA ŽIGA	<b>732</b>	NAME AND ADDRESS OF THE HOLDER OF THE REGISTRATION
IME I ADRESA PUNOMOĆNIKA	<b>740</b>	NAME AND ADDRESS OF THE REPRESENTATIVE

**OBJAVA PRIJAVA ŽIGOVA**  
**Publication of trademark applications**

(210) **Ž-2017-346**

(220) 28.08.2017.

(731) Movement Brands Limited, Regina House, 124 Finchley Road, NW3 5JS, London, GB

(540)

**TAPE**

(550) I

(740) Jasna Jusić, Marka Radovića 37, 1. sprat, stan br. 4., Podgorica

(511) Klasa 33: Alkoholna pića (izuzev piva); alkoholna vina, kokteli i likeri.

Klasa 43: Obezbjedeње usluga bara, koktel salona, restorana, kafea, vinarskog bara i ketringa; usluge javih mjesta, vinskog bara, bar, hotela, restorana, kafeterija, banketa i ketringa; organizovanje i obezbjeđivanje objekata za konferencije, sastanke i događaje.

---

(210) **Ž-2018-40**

(220) 08.02.2018.

(731) Amicus Pharma d.o.o., Moskovska 63-4, 81000, Podgorica, ME

(540)

**DEFLACORT**

(550) I

(740) Amicus Pharma d.o.o., Moskovska 63-4, 81000, Podgorica

(511) Klasa 5: Farmaceutski, medicinski i veterinarski preparati; sanitarni preparati za upotrebu u medicini; dijetetska hrana i supstance prilagođene za upotrebu u medicini; dijetetska hrana i supstance prilagođene za upotrebu u medicini ili veterinarsku upotrebu, hranu za bebe; dijetetski dodaci ( dodaci ishrani) za ljude i životinje; flasteri, materijali za zavijanje; materijali za plombiranje zuba, zubarska smola; dezinfekciona sredstva; preparati za uništavanje životinjskih štetočina; fungicidi, herbicidi.

---

(210) **Ž-2018-353**

(220) 12.09.2018.

(731) "KAFOTEKA" D.O.O., Vaka Đurovica bb, Podgorica, ME

(540)



(550) I

(511) Klasa 30: ( kafa, čaj, kakao, šećer, riža, tapioka, sago, zamjene za kafu; brašno i proizvodi od žitarica, hljeb, kolači, poslastice, bomboni, sladoled; med, sirup od melase; kvasac, prašak za pecivo; so, senf; sirće, prelive, začini, razni začini, led za hlađenje.)

Klasa 32: (pivo; mineralne i gazirane vade i ostala bezalkoholna pića; pića od voća i voćni sokovi; sirupi i ostali preparati za pripremanje napitaka .)

Klasa 33: ( alkoholna pića (osim piva) )

---

(210) **Ž-2019-109**

(220) 19.03.2019.

(731) Biogen MA Inc., 225 Binney Street, MA 02142, Cambridge, Massachusetts, US

(540)

IMRALDI

(550) I

(740) Vučko Bjelanović, 13. Jula broj 5, 81000, Podgorica

(511) Klasa 5: Farmaceutski preparati za liječenje autoimunih bolesti.

---

(210) **Ž-2019-228**

(220) 19.06.2019.

(731) VETERINARSKA USTANOVA VETERINUM, Ul. Majke Tereze b.b., Ulcinj, ME

(540)



(550) I

(511) Klasa 31: Proizvodnja hrane za pčele; pogače za pčele; tečna hrana za pčele.

Klasa 35: Uvoz-izvoz, distribucija, veleprodaja i maloprodaja hrane za kućne ljubimce, stočne hrane, pesticida-sredstava za zaštitu bilja, sredstava za ishranu bilja, sjemenskog materijala i poljoprivrednog bilja, veterinarskih suplemenata, opreme za kućne ljubimce, insecticida, rodenticida, pčelarske opreme i kompletan poljoprivredni program.

Klasa 37: Usluge dezinfekcije, dezinfekcije i deratizacije objekata iz oblasti veterine, iz oblasti zaštite bilja i biljnih proizvoda i iz oblasti zdravstvene zaštite stanovništva; usluge fumigacije objekata, magacina brodova, vagona itd.; usluge fumigacije biljnih proizvoda.

Klasa 43: Pansion za životinje.

Klasa 44: Pružanje veterinarskih usluga za kućne ljubimce (ambulanta, laboratorija, bolnica, radiologija ultrazvuk, stomatologija, hirurgija, beauty salon); pružanje veterinarskih usluga za ostale životinje.



(210) **Ž-2019-370**

(220) 26.09.2019.

(731) Zoran Đurković, Maršala Tita 24/33, Bar

(540)



(550) I

(511) Klasa 16: Papir, karton i proizvodi od tih materijala koji nisu obuhvaćeni drugim klasama; štamparski proizvodi; proizvodi za uvezivanje knjiga; fotografije; pribor za pisanje; ljepljiva (ljepljive materije za papirnate proizvode ili za kućne potrebe); slikarski pribor; kistovi; pišalice mašine i kancelarijski pribor (osim namještaja); oprema za nastavu i obuku (osim aparata); plastični materijali za ambalažu (koji nisu obuhvaćeni drugim klasama); štamparska slova; klišeji.

Klasa 34: Duvan; pribor za pušače; šibice.

Klasa 36: Osiguranje; finansijski poslovi; monetarni poslovi; upravljanje nekretninama.

---

(210) **Ž-2020-4**

(220) 13.01.2020.

(731) Bosnalijek, farmaceutska i hemijska industrija, dioničko društvo, Jukićeva 53, 71000, Sarajevo, BA

(540)

**REHYDROSOL**

(550) I

(740) Božidar S. Radulović, Studentska bb, Lamela 3/18, 81000, Podgorica

(511) Klasa 5: Farmaceutski proizvodi.

---

(210) **Ž-2020-227**

(220) 02.07.2020.

(731) Merck KGaA, Frankfurter Str. 250, 64293, Darmstadt, DE

(540)

## ROMBIDUX

(550) I

(740) Miladin Popović, Đoka Miraševića 21/III, 81000, Podgorica

(511) Klasa 5: Oralni preparati za kontrolu/upravljanje primarnom hipertenzijom.

---

(210) **Ž-2020-230**

(220) 03.07.2020.

(731) Merck KGaA, Frankfurter Str. 250, 64293, Darmstadt, DE

(540)

## GLYALTON

(550) I

(740) Miladin Popović, Đoka Miraševića 21/III, 81000, Podgorica

(511) Klasa 5: Farmaceutski preparati za liječenje dijabetesa.

---

(210) **Ž-2020-231**

(220) 03.07.2020.

(731) Merck KGaA, Frankfurter Str. 250, 64293, Darmstadt, DE

(540)

## GLYDUZA

(550) I

(740) Miladin Popović, Đoka Miraševića 21/III, 81000, Podgorica

(511) Klasa 5: Farmaceutski preparati za liječenje dijabetesa.

---

(210) **Ž-2020-249**

(220) 15.07.2020.

(731) Merck KGaA, Frankfurter Str. 250, 64293, Darmstadt, DE

(540)

## SUPROVIA

(550) I

(740) Miladin Popović, Đoka Miraševića 21/III, 81000, Podgorica

(511) Klasa 5: Farmaceutski preparati za liječenje dijabetesa.

---

(210) **Ž-2020-259**

(220) 22.07.2020.

(731) FAES FARMA, S.A., MÁXIMO AGUIRRE, 14-48940, LEIOA (BIZKAIA), ES

(540)

## MECOLZINE

(550) I

(740) Jasna Jusić, Marka Radovića 37, 1. sprat, stan br. 4., 81000, Podgorica

(511) Klasa 5: Farmaceutski proizvodi, medicinski i veterinarski preparati; sanitarni preparati za medicinsku upotrebu; dijetetska hrana i supstance prilagođene za medicinsku ili veterinarsku upotrebu, hrana za bebe; dijetetski dodaci prehrani za ljude i životinje; flasteri, materijali za zavijanje; materijal za plombiranje zuba, zubarska smola; dezinfekciona sredstva; preparati za uništavanje štetočina; fungicidi, herbicidi.

---

(210) **Ž-2020-319**

(220) 08.09.2020.

(731) SAMOSTLANO ZANATSKO TRGOVINSKA RADNJA "ASTRA", A. Šantića br. 1, 31300, Prijepolje, RS

(540)



(550) I

(740) AOD MSA IP - Milojević Sekulić Advokati, Karađorđeva 65, 11000, Beograd

(511) Klasa 25: Čarape.

---

(210) **Ž-2020-322**

(220) 13.05.2020.

(731) Beam Suntory UK Limited, 2 Longwalk Road, Stockley Park, UB11 1BA, Uxbridge, Middlesex England, GB

(540)

## BOWMORE

(550) I

(740) AOD MSA IP - Milojević Sekulić Advokati, Karađorđeva 65, 11000, Beograd  
(511) Klasa 33: Alkoholna pića, izuzev piva; viski.

---

(210) **Ž-2020-328**

(220) 18.09.2020.

(731) Donesi doo Podgorica, društvo sa ograničenom odgovornošću, Josipa Broza Tita  
65A, 81000, Podgorica, ME

(540)

## Uvijek u pravom trenutku

(550) I

(740) Ana Zeković, Bulevar Svetog Petra Cetinjskog 130/VII, 81000, Podgorica

(511) Klasa 9: Aplikacija za angažovanje i koordinaciju prevoza, isporuke i usluge kurirske službe za računarske softvere koji se mogu preuzimati.

Klasa 35: Reklamne i promotivne usluge; poslovno upravljanje u oblasti transporta i isporuke; usluge upravljanja poslovima u oblasti transporta i isporuka; kompjuterizovane usluge naručivanja hrane i namirnica; kompjuterizovana usluga naručivanja koja sadrži robu široke potrošnje, hranu i namirnice; usluga naručivanja putem interneta koja sadrži robu široke potrošnje, hranu i namirnice; kancelarijske usluge; usluga maloprodaje koja sadrži proizvode široke potrošnje, hranu i namirnice; usluge upoređivanja proizvoda prilikom kupovine; nadzor, upravljanje i praćenje paketa i pošiljki; nadzor i praćenje paketa i pošiljki radi obezbeđenja blagovremene isporuke za potrebe poslovanja; konsultantske usluge u oblasti poslovnog upravljanja u oblasti transporta i isporuke; "Pružanje usluga putem internet sistema i portala po sistemu poslovnog modela, korisnici prema poslovnom okruženju" radi trgovine kako bi korisnici mogli da unose, upravljaju i menjaju svoje informacije o preferencijama koje trgovci koriste, kreiraju i upravljaju zbog ponuda za isporuku kupcima.

Klasa 39: Pružanje usluga putem internet stranice sa informacijama o uslugama dostave i rezervacijama za uslugu dostave; prevoz; pakovanje i skladištenje robe; dostava hrane; dostava paketa; prevoz i isporuka robe; dostava poruka [kurirska služba]; brza dostava proizvoda putem vozila; pružanje informacija o preuzimanju i dostavi proizvoda u prevozu; usluge dostavljanja; privremeno skladištenje isporuka dobara u tranzitu; usluge isporuke; privremeno skladištenje isporuka; pružanje informacija i informacije o praćenju pošiljki za treća lica o preuzimanju i statusu dostave putem interneta i telefona; pružanje elektronskog praćenja pošiljki drugim licima.

Klasa 42: Omogućavanje privremene upotrebe internet softvera koji nije za preuzimanje, za pružanje usluga prevoza i dostave, rezervacije za usluge prevoza i dostave i otpremanje motornih vozila i kurira do potrošača.

Klasa 43: Pružanje usluge putem internet stranice koja sadrži informacije o uslugama restorana.

---

(210) **Ž-2020-338**

(220) 23.09.2020.

(731) Amazon Tehnologies, Inc., 410 Terry Avenue North, 98109, Seattle, Washington, US  
(540)

## AMAZON ADVERTISING

(550) I

(740) Jasna Jusić, Marka Radovića 37, 1. sprat, stan br. 4., 81000, Podgorica  
(511) Klasa 9: Računarski softver za stvaranje i isporuku digitalnog sadržaja i oglašavanje putem globalnih komunikacionih mreža koji se može preuzimati; računarski softver koji se može preuzimati, odnosno softver koji stiče korisničke preferencije za prilagođavanje predmeta i izgleda digitalnog sadržaja i oglašavanja; računarski softver koji se može preuzimati za praćenje, monitoring i izvještavanje o trendovima za reklamne, marketinške i promotivne svrhe; računarski softver za procjenu i analizu ponašanja kupaca u oblasti oglašavanja i marketinga koji se može preuzimati; računarski softver za kupovinu medija koji se može preuzimati; računarski softver koji se može preuzimati za potrebe praćenja, monitoringa i izvještavanja o trendovima za reklamne, marketinške i promotivne svrhe; računarski softver koji se može preuzimati za potrebe razvoja tehnologije, podataka i analitičkih alata usmjerenih na oglašavanje; računarski softver koji se može preuzimati za potrebe procjene ponašanja kupaca; računarski softver koji se može preuzimati za stvaranje i isporuku digitalnog sadržaja i oglašavanje putem globalnih komunikacionih mreža; računarski softver koji se može preuzimati za prilagođavanje predmeta i izgleda digitalnog sadržaja i oglašavanja.

Klasa 16: Štampani reklamni i promotivni materijali, naime, štampani vizuelni materijali u obliku informativne grafike i promotivnog materijala koji se prodaju drugima za oglašavanje i promociju roba i usluga drugih.

Klasa 35: Usluge oglašavanja i marketinga koje se pružaju putem društvenih medija i usluge marketinga putem pretraživača; objavljivanje reklamnih tekstova; analiza istraživanja tržišta i podataka o oglašavanju radi pružanja reklamnih i marketinških strategija i uvida; usluge poslovnog monitoringa i konsaltinga, naime, upotreba analitičkih i statističkih modela za razumijevanje potrošača i preduzeća i predviđanje tržišnih trendova i akcija; poslovno strateško planiranje u oblasti istraživanja odnosa sa medijima, istraživanja tržišta, istraživanja potrošača i sprovođenja anketa o istraživanju poslovanja i tržišta; kreiranje, pisanje, uređivanje, objavljivanje i distribuiranje reklamnih materijala koji sadrže tekstove, vizuelne elemente i sadržaj; usluge kupovine i planiranja medija, naime savjetovanje klijenata o iznajmljivanju i kupovini vremena za oglašavanje i prostora za oglašavanje za isporuku reklamnih poruka kroz vrijeme emitovanja, prostor za štampu, unutrašnji prostor, otvoreni prostor ili digitalni prostor; oglašavanja na otvorenom; usluge oglašavanja sa plaćanjem po kliku; priprema audiovizuelnih prezentacija za upotrebu u oglašavanju; produkcija, postprodukcija, montaža, objavljivanje / distribucija reklamnih materijala u obliku kinematografskih, video i audio djela; pružanje analitike podataka u vezi sa prikupljanjem i analizom trendova i karakteristika potrošačke kupovine za optimizaciju digitalnih ponuda i promocija; usluge agencija za odnose sa javnošću; iznajmljivanje i kupovina vremena oglašavanja i prostora za oglašavanje na svim komunikacionim sredstvima i medijima.

Klasa 41: Obrazovne usluge, naime, razvoj nastavnog programa za druge u oblasti

oglašavanja i marketinga.

Klasa 42: Provajder usluga aplikacija (ASP) koji sadrži softver za upotrebu u kreiranju reklama za druge; softver kao usluga (SAAS) za stvaranje i isporuku digitalnog sadržaja i oglašavanje putem globalnih komunikacionih mreža; softver kao usluga (SAAS), naime softver koji stiče korisničke preferencije za prilagođavanje predmeta i izgleda digitalnog sadržaja i oglašavanja; softver kao usluga (SAAS) za praćenje, monitoring i izvještavanje o trendovima u reklamne, marketinške i promotivne svrhe; softver kao usluga (SAAS) za procjenu i analizu ponašanja kupaca u oblasti oglašavanja i marketinga; softver kao usluga (SAAS) u svrhu praćenja, monitoringa i izvještavanja o trendovima u reklamne, marketinške i promotivne svrhe; softver kao usluga (SAAS) u svrhu razvoja tehnologije, podataka i analitičkih alata usmjerenih na oglašavanje; softver kao usluga (SAAS) u svrhu procjene ponašanja kupaca; onlajn softver koji se ne može preuzimati za kupovinu medija; onlajn softver koji se ne može preuzimati za stvaranje / isporuku digitalnog sadržaja i oglašavanje putem globalnih komunikacionih mreža; onlajn softver koji se ne može preuzimati za prilagođavanje predmeta i izgleda digitalnog sadržaja i oglašavanja.

---

(210) **Ž-2020-340**

(220) 24.09.2020.

(731) Društvo za telekomunikacije Mtel d.o.o, Bul. Svetog Petra Cetinjskog 143, 81000, Podgorica, ME

(540)



(550) I

(511) Klasa 35: Oglašavanje i reklamiranje; vođenje komercijalnih poslova; komercijalna administracija; kancelarijski poslovi.

Klasa 38: Telekomunikacije.

Klasa 42: Naučne i tehnološke usluge kao i pripadajuće usluge istraživanja i koncepcije; usluge industrijskih analiza i istraživanja; koncepcija i razvoj računara i računarskih programa /hardvera i softvera/.

---

(210) **Ž-2020-347**

(220) 29.09.2020.

(731) Amazon Tehnologies, Inc., 410 Terry Avenue North, 98109, Seattle, Washington, US

(540)



(550) I

(740) Jasna Jusić, Marka Radovića 37, 1. sprat, stan br. 4., 81000, Podgorica

(511) Klasa 9: Računarski softver za stvaranje i isporuku digitalnog sadržaja i oglašavanje putem globalnih komunikacionih mreža koji se može preuzimati; računarski softver koji se može preuzimati, odnosno softver koji stiče korisničke preferencije za prilagođavanje predmeta i izgleda digitalnog sadržaja i oglašavanja; računarski softver koji se može preuzimati za praćenje, monitoring i izvještavanje o trendovima za reklamne, marketinške i promotivne svrhe; računarski softver za procjenu i analizu ponašanja kupaca u oblasti oglašavanja i marketinga koji se može preuzimati; računarski softver za kupovinu medija koji se može preuzimati; računarski softver koji se može preuzimati za potrebe razvoja tehnologije, podataka i analitičkih alata usmjerenih na oglašavanje; računarski softver koji se može preuzimati za potrebe procjene ponašanja kupaca; računarski softver koji se može preuzimati za prilagođavanje predmeta i izgleda digitalnog sadržaja i oglašavanja.

Klasa 16: Štampani reklamni i promotivni materijali, naime, štampani vizuelni materijali u obliku informativne grafike i promotivnog materijala koji se prodaju drugima za oglašavanje i promociju roba i usluga drugih.

Klasa 35: Usluge oglašavanja i marketinga koje se pružaju putem društvenih medija i usluge marketinga putem pretraživača; objavljivanje reklamnih tekstova; analiza istraživanja tržišta i podataka o oglašavanju radi pružanja reklamnih i marketinških strategija i uvida; poslovno strateško planiranje u oblasti istraživanja odnosa sa medijima, istraživanja tržišta, istraživanja potrošača i sprovođenja anketa o istraživanju poslovanja i tržišta; kreiranje, pisanje, uređivanje, objavljivanje i distribuiranje reklamnih materijala koji sadrže tekstove, vizuelne elemente i sadržaj; usluge kupovine i planiranja medija, naime savjetovanje klijenata o iznajmljivanju i kupovini vremena za oglašavanje i prostora za oglašavanje za isporuku reklamnih poruka kroz vrijeme emitovanja, prostor za štampu, unutrašnji prostor, otvoreni prostor ili digitalni prostor; oglašavanja na otvorenom; usluge oglašavanja sa plaćanjem po kliku; priprema audiovizuelnih prezentacija za upotrebu u oglašavanju; produkcija, postprodukcija, uređivanje, objavljivanje i distribucija reklamnih materijala u obliku kinematografskih, video i audio djela; pružanje analitike podataka u vezi sa prikupljanjem i analizom trendova i karakteristika potrošačke kupovine za optimizaciju digitalnih ponuda i promocija; usluge agencija za odnose sa javnošću; iznajmljivanje i kupovina vremena oglašavanja i prostora za oglašavanje na svim komunikacionim sredstvima i medijima; oglašavanje i marketing; usluge reklamnih agencija; usluge digitalnog oglašavanja; usluge onlajn oglašavanja za druge; upravljanje onlajn prodavnicama za prodavce roba i / ili usluga; razvoj koncepata internet oglašavanja; proizvodnja reklamnih materijala i reklama; konsalting u poslovnom upravljanju u vezi sa strategijom, marketingom, prodajom, radom, dizajnom proizvoda, posebno specijalizovan za upotrebu analitičkih i

statističkih modela za razumijevanje i predviđanje potrošača, preduzeća i tržišnih trendova i akcija.

Klasa 41: Obrazovne usluge, naime, razvoj nastavnog programa za druge u oblasti oglašavanja i marketinga.

Klasa 42: Provajder usluga aplikacija (ASP) koji sadrži softver za upotrebu u kreiranju reklama za druge; softver kao usluga (SAAS) za stvaranje i isporuku digitalnog sadržaja i oglašavanje putem globalnih komunikacionih mreža; softver kao usluga (SAAS), naime softver koji stiče korisničke preferencije za prilagođavanje predmeta i izgleda digitalnog sadržaja i oglašavanja; softver kao usluga (SAAS) za praćenje, monitoring i izvještavanje o trendovima u reklamne, marketinške i promotivne svrhe; softver kao usluga (SAAS) za procjenu i analizu ponašanja kupaca u oblasti oglašavanja i marketinga; softver kao usluga (SAAS) u svrhu razvoja tehnologije, podataka i analitičkih alata usmjerenih na oglašavanje; softver kao usluga (SAAS) u svrhu procjene ponašanja kupaca; onlajn softver koji se ne može preuzimati za kupovinu medija; onlajn softver koji se ne može preuzimati za stvaranje i isporuku digitalnog sadržaja i oglašavanje putem globalnih komunikacionih mreža; onlajn softver koji se ne može preuzimati za prilagođavanje predmeta i izgleda digitalnog sadržaja i oglašavanja.

---

(210) **Ž-2020-348**

(220) 29.09.2020.

(731) Amazon Tehnologies, Inc., 410 Terry Avenue North, 98109, Seattle, Washington, US

(540)



(550) I

(740) Jasna Jusić, Marka Radovića 37, 1. sprat, stan br. 4., 81000, Podgorica

(511) Klasa 9: Računarski softver za stvaranje i isporuku digitalnog sadržaja i oglašavanje putem globalnih komunikacionih mreža koji se može preuzimati; računarski softver koji se može preuzimati, odnosno softver koji stiče korisničke preferencije za prilagođavanje predmeta i izgleda digitalnog sadržaja i oglašavanja; računarski softver koji se može preuzimati za praćenje, monitoring i izvještavanje o trendovima za reklamne, marketinške i promotivne svrhe; računarski softver za procjenu i analizu ponašanja kupaca u oblasti oglašavanja i marketinga koji se može preuzimati; računarski softver za kupovinu medija koji se može preuzimati; računarski softver koji se može preuzimati za potrebe razvoja tehnologije, podataka i analitičkih alata usmjerenih na oglašavanje; računarski softver koji se može preuzimati za potrebe procjene ponašanja kupaca; računarski softver koji se može preuzimati za prilagođavanje predmeta i izgleda digitalnog sadržaja i oglašavanja.

Klasa 16: Štampani reklamni i promotivni materijali, naime, štampani vizuelni materijali u



obliku informativne grafike i promotivnog materijala koji se prodaju drugima za oglašavanje i promociju roba i usluga drugih.

Klasa 35: Usluge oglašavanja i marketinga koje se pružaju putem društvenih medija i usluge marketinga putem pretraživača; objavljivanje reklamnih tekstova; analiza istraživanja tržišta i podataka o oglašavanju radi pružanja reklamnih i marketinških strategija i uvida; poslovno strateško planiranje u oblasti istraživanja odnosa sa medijima, istraživanja tržišta, istraživanja potrošača i sprovođenja anketa o istraživanju poslovanja i tržišta; kreiranje, pisanje, uređivanje, objavljivanje i distribuiranje reklamnih materijala koji sadrže tekstove, vizuelne elemente i sadržaj; usluge kupovine i planiranja medija, naime savjetovanje klijenata o iznajmljivanju i kupovini vremena za oglašavanje i prostora za oglašavanje za isporuku reklamnih poruka kroz vrijeme emitovanja, prostor za štampu, unutrašnji prostor, otvoreni prostor ili digitalni prostor; oglašavanja na otvorenom; usluge oglašavanja sa plaćanjem po kliku; priprema audiovizuelnih prezentacija za upotrebu u oglašavanju; produkcija, postprodukcija, uređivanje, objavljivanje i distribucija reklamnih materijala u obliku kinematografskih, video i audio djela; pružanje analitike podataka u vezi sa prikupljanjem i analizom trendova i karakteristika potrošačke kupovine za optimizaciju digitalnih ponuda i promocija; usluge agencija za odnose sa javnošću; iznajmljivanje i kupovina vremena oglašavanja i prostora za oglašavanje na svim komunikacionim sredstvima i medijima; oglašavanje i marketing; usluge reklamnih agencija; usluge digitalnog oglašavanja; usluge onlajn oglašavanja za druge; upravljanje onlajn prodavnicama za prodavce roba i / ili usluga; razvoj koncepata internet oglašavanja; proizvodnja reklamnih materijala i reklama; konsalting u poslovnom upravljanju u vezi sa strategijom, marketingom, prodajom, radom, dizajnom proizvoda, posebno specijalizovan za upotrebu analitičkih i statističkih modela za razumijevanje i predviđanje potrošača, preduzeća i tržišnih trendova i akcija.

Klasa 41: Obrazovne usluge, naime, razvoj nastavnog programa za druge u oblasti oglašavanja i marketinga.

Klasa 42: Provajder usluga aplikacija (ASP) koji sadrži softver za upotrebu u kreiranju reklama za druge; softver kao usluga (SAAS) za stvaranje i isporuku digitalnog sadržaja i oglašavanje putem globalnih komunikacionih mreža; softver kao usluga (SAAS), naime softver koji stiče korisničke preferencije za prilagođavanje predmeta i izgleda digitalnog sadržaja i oglašavanja; softver kao usluga (SAAS) za praćenje, monitoring i izvještavanje o trendovima u reklamne, marketinške i promotivne svrhe; softver kao usluga (SAAS) za procjenu i analizu ponašanja kupaca u oblasti oglašavanja i marketinga; softver kao usluga (SAAS) u svrhu razvoja tehnologije, podataka i analitičkih alata usmjerenih na oglašavanje; softver kao usluga (SAAS) u svrhu procjene ponašanja kupaca; onlajn softver koji se ne može preuzimati za kupovinu medija; onlajn softver koji se ne može preuzimati za stvaranje i isporuku digitalnog sadržaja i oglašavanje putem globalnih komunikacionih mreža; onlajn softver koji se ne može preuzimati za prilagođavanje predmeta i izgleda digitalnog sadržaja i oglašavanja.

---

(210) **Ž-2020-356**

(220) 02.10.2020.

(731) TOYOTA JIDOSHA KABUSHIKI KAISHA (also trading as TOYOTA MOTOR CORPORATION), 1, Toyota-cho, Toyota-shi, Aichi-ken, JP

(540)

**TOYOTA BZ2**

(550) I

(740) Jasna Jusić, Marka Radovića 37, 1. sprat, stan br. 4., 81000, Podgorica

(511) Klasa 12: Automobili i njihovi strukturalni djelovi.

---

(210) **Ž-2020-361**

(220) 07.10.2020.

(731) Hemofarm A.D. farmaceutsko-hemijska industrija Vršac, Beogradski put bb, 26300, Vršac, RS

(540)

## AXONIN

(550) I

(740) AOD MSA IP - Milojević Sekulić Advokati, Karađorđeva 65, 11000, Beograd

(511) Klasa 5: Farmaceutski proizvodi.

---

(210) **Ž-2020-364**

(220) 07.10.2020.

(731) Hemofarm A.D. farmaceutsko-hemijska industrija Vršac, Beogradski put bb, 26300, Vršac, RS

(540)

## XELORAMIN

(550) I

(740) AOD MSA IP - Milojević Sekulić Advokati, Karađorđeva 65, 11000, Beograd

(511) Klasa 5: Farmaceutski proizvodi.

---

(210) **Ž-2020-366**

(220) 13.10.2020.

(731) AKAD General Trading L.L.C, Office 1247, Owned by Abdu Salam Murad Al Ganahi, Business Bay, Dubai, United Arab Emirates, AE

(540)



(550) I

(740) Božidar S.Radulović, Baku 30/5, 81000, Podgorica

(511) Klasa 9: Mobilni telefoni; pametni telefoni; računari; računarski hardver; laptop računari; tablet računari; pametni satovi; prenosivi izvori napajanja (punjive baterije); prenosni punjači (power bank); futrole za pametne telefone, tablete; navlake za pametne telefone, tablete; trake za mobilne telefone; baterije; žice, električne; spojnice za žice; punjači; punjači za električne baterije; baterije, električne.

---

(210) **Ž-2020-367**

(220) 13.10.2020.

(731) AKAD General Trading L.L.C, Office 1247, Owned by Abdu Salam Murad Al Ganahi, Business Bay, Dubai, United Arab Emirates, AE

(540)



(550) I

(740) Božidar S.Radulović, Baku 30/5, 81000, Podgorica

(511) Klasa 9: Mobilni telefoni; pametni telefoni; računari; računarski hardver; laptop računari; tablet računari; pametni satovi; prenosivi izvori napajanja (punjive baterije); prenosni punjači (power bank); futrole za pametne telefone, tablete; navlake za pametne telefone, tablete; trake za mobilne telefone; baterije; žice, električne; spojnice za žice; punjači; punjači za električne baterije; baterije, električne.

---

(210) **Ž-2020-369**

(220) 16.10.2020.

(731) KRAŠ, PREHRAMBENA INDUSTRIJA D.D., Ravnice 48, 10000, Zagreb, HR

(540)



(550) I

(740) AOD MSA IP - Milojević Sekulić Advokati, Karađorđeva 65, 11000, Beograd

(511) Klasa 30: Nugat sa bademom.

---

(210) **Ž-2020-372**

(220) 20.10.2020.

(731) The Procter & Gamble Company, One Procter & Gamble Plaza, 45202, Cincinnati, Ohio, US

(540)



(550) I

(740) AOD "Lutovac & partneri", Bulevar Ivana Crnojevića 93, 81000, Podgorica

(511) Klasa 5: Pelene za jednokratnu upotrebu i gaćice za odvikavanje od pelena.

---

(210) **Ž-2020-382**

(220) 26.10.2020.

(731) ZHENGZHOU YUTONG BUS CO., LTD., YUTONG ROAD, GUANCHENG DISTRICT, ZHENGZHOU, CN

(540)



(550) I

(740) Božidar S. Radulović, Baku 30/5, 81000, Podgorica

(511) Klasa 7: Mašine za bušenje, mešači, valjci [mašine], parni valjci, mašine za mešanje, mašine za izbeljivanje, mašine za mešanje, mašine za mešanje betona, mašine za pravljenje bitumena, buldožeri, kopači, mehanički, bageri, mašine za katranisanje, mašine za postavljanje šina, mašine za pravljenje puteva, mašine za izradu šina, kopači [mašine], hidraulični klipovi [mašine], mašine za pomeranje zemlje, plugovi za kopanje rovova, lopate, mehaničke, mašine i mašinerija koje se koriste u zemljanim radovima u oblasti građevinarstva, mostova i puteva, vibratori za beton, mašine za utovar i istovar, teretne dizalice, kranovi [aparati za podizanje], starteri za motore, klipovi prigušivača [delovi mašina], amortizeri za mašine, mašine za čišćenje puteva, samohodne, pulverizatori otpadnih voda, aparati za pranje, instalacije za pranje vozila, mašine i aparati za čišćenje, električni, drobilice otpada [mašine], drobilice i prese za otpad, drobilice i prese za đubre, mašine za presovanje đubre, mašine za presovanje otpada, bageri za vodu.

---

(210) **Ž-2020-388**

(220) 29.10.2020.

(731) Hangzhou Hikmicro Sensing Technology Co., Ltd., A limited company of the People's Republic of China Building A1, No. 299 Qiushi Road, Tonglu Economic Development Zone, Tonglu County, 311501, Hangzhou , CN

(540)

**HIKMICRO**

(550) I

(740) AOD MSA IP - Milojević Sekulić Advokati, Karađorđeva 65, 11000, Beograd

(511) Klasa 9: Računarska memorija, uređaji; računarski programi, snimljeni; operativni računarski programi, snimljeni; računarski softver, snimljeni; aplikacije za računarske softvere koje se mogu preuzimati; parking metri; aparati za proveru poštanskih maraka; detektori falsifikovanog novca; mehanizmi za aparate koji se pokreću kovanicama; hologrami; uređaji za prepoznavanje lica; uređaji za praćenje prisustva i evidenciju radnog vremena; fototelegrafski aparat; aparati za vaganje; elektronske table za obaveštenja; aparati za intrenu komunikaciju; video telefoni; uređaji za globalno pozicionirajući sistem [GPS]; kompakt diskovi [audio-video]; aparati za snimanje zvuka; video rekorderi; kamere za nadzor; aparati za praćenje, koji nisu za upotrebu u medicini; video monitori za bebe; fotoaparati; filteri za upotrebu u fotografiji; tronošci za kamere; poklopci za fotografska

sočiva; selfi štapovi [ručni monopodi]; merni instrumenti; optička sočiva; kablovi sa optičkim vlaknima; električna žica; kablovi; poluprovodničke pločice za izradu integrisanih kola; čipovi [integrisana kola]; kondenzatori; video ekrani; aparati za daljinsko upravljanje; optička vlakna; električna oprema za daljinsko upravljanje industrijskim procesima; gromobrani; aparati za gašenje vatre; radiološki ekrani za industrijsku upotrebu; zaštitni uređaji za ličnu upotrebu u slučaju nesreće; električne instalacije za sprečavanje provala; protiv provalni upozoravajući aparati; baterije, Celektrične; slajdovi [fotografski]; senzori; detektori; oprema za infracrveno termičko snimanje; oprema za termičko snimanje i merenje temperature.

Klasa 42: Naučna istraživanja; istraživanje i razvoj novih proizvoda za druge; dizajniranje računarskog softvera; razvoj softvera u okviru izdavanja softvera; dizajniranje računarskih sistema; iznajmljivanje računara; iznajmljivanje računarskog softvera; računarsko programiranje; instalacija računarskog softvera; održavanje računarskog softvera; konvertovanje podataka ili dokumenata sa fizičkih na elektronske nosače; konvertovanje računarskih podataka i programa, osim fizičkog konvertovanja; ponovno uspostavljanje računarskih podataka; analize računarskih sistema; izrada i održavanje veb stranica za druge; hosting računarskih sajtova [veb sajtova]; server hosting; zaštita od računarskih virusa; praćenje računarskih sistema daljinskim pristupom; tehničko projektne studije; inženjerske usluge; merenje zemljišta; urbanističko planiranje; istraživanja iz oblasti mehanike; industrijski dizajn; savetovanje u oblasti dizajna i razvoja računarskog hardvera; usluge tehničkih konsultacija iz oblasti računara; softver kao usluga [SaaS]; platforma kao usluga [PaaS].

---

(210) **Ž-2020-389**

(220) 29.10.2020.

(731) Hangzhou Hikmicro Sensing Technology Co., Ltd., A limited company of the People's Republic of China Building A1, No. 299 Qiushi Road, Tonglu Economic Development Zone, Tonglu County, 311501, Hangzhou , CN

(540)



(550) I

(740) AOD MSA IP - Milojević Sekulić Advokati, Karađorđeva 65, 11000, Beograd

(511) Klasa 9: Računarska memorija, uređaji; računarski programi, snimljeni; operativni računarski programi, snimljeni; računarski softver, snimljeni; aplikacije za računarske

softvere koje se mogu preuzimati; parking metri; aparati za proveru poštanskih maraka; detektori falsifikovanog novca; mehanizmi za aparate koji se pokreću kovanicama; hologrami; uređaji za prepoznavanje lica; uređaji za praćenje prisustva i evidenciju radnog vremena; fototelegrafski aparat; aparati za vaganje; elektronske table za obaveštenja; aparati za intrenu komunikaciju; video telefoni; uređaji za globalno pozicionirajući sistem [GPS]; kompakt diskovi [audio-video]; aparati za snimanje zvuka; video rekorderi; kamere za nadzor; aparati za praćenje, koji nisu za upotrebu u medicini; video monitori za bebe; fotoaparati; filteri za upotrebu u fotografiji; tronošci za kamere; poklopci za fotografska sočiva; selfi štapovi [ručni monopodi]; merni instrumenti; optička sočiva; kablovi sa optičkim vlaknima; električna žica; kablovi; poluprovodničke pločice za izradu integrisanih kola; čipovi [integrisana kola]; kondenzatori; video ekrani; aparati za daljinsko upravljanje; optička vlakna; električna oprema za daljinsko upravljanje industrijskim procesima; gromobrani; aparati za gašenje vatre; radiološki ekrani za industrijsku upotrebu; zaštitni uređaji za ličnu upotrebu u slučaju nesreće; električne instalacije za sprečavanje provala; protiv provalni upozoravajući aparati; baterije, električne; slajdovi [fotografski]; senzori; detektori; oprema za infracrveno termičko snimanje; oprema za termičko snimanje i merenje temperature.

Klasa 42: Naučna istraživanja; istraživanje i razvoj novih proizvoda za druge; dizajniranje računarskog softvera; razvoj softvera u okviru izdavanja softvera; dizajniranje računarskih sistema; iznajmljivanje računara; iznajmljivanje računarskog softvera; računarsko programiranje; instalacija računarskog softvera; održavanje računarskog softvera; konvertovanje podataka ili dokumenata sa fizičkih na elektronske nosače; konvertovanje računarskih podataka i programa, osim fizičkog konvertovanja; ponovno uspostavljanje računarskih podataka; analize računarskih sistema; izrada i održavanje veb stranica za druge; hosting računarskih sajtova [veb sajtova]; server hosting; zaštita od računarskih virusa; praćenje računarskih sistema daljinskim pristupom; tehničko projektne studije; inženjerske usluge; merenje zemljišta; urbanističko planiranje; istraživanja iz oblasti mehanike; industrijski dizajn; savetovanje u oblasti dizajna i razvoja računarskog hardvera; usluge tehničkih konsultacija iz oblasti računara; softver kao usluga [SaaS]; platforma kao usluga [PaaS].

---

(210) **Ž-2020-398**

(220) 05.11.2020.

(731) Zhengzhou Yutong Bus Co., Ltd., Yutong Road, Guancheng District, Zhengzhou, CN

(540)



(550) I

(740) Božidar S. Radulović, Baku 30/5, 81000, Podgorica

(511) Klasa 12: Viljuškari; kamioni sa ugrađenim kranom; podizači zadnjih vrata [delovi kopnenih vozila]; kamioni -cisterne za prskanje; autobusi; putnički autobusi; kamioni; kesoni [vozila]; karavani; prikolice [vozila]; kola za creva za polivanje; traktori; prikolice, vagoni; vozila sa točkovima nalik biciklo; električna vozila; dostavna vozila; hladnjače; vojna vozila za transport; sportska kola; kolica sa nagibom; tramvaji; vozila za kretanje po zemlj i, vazduhu, vodi ili šinama; kola; motorna kola; automobili; vozila za mešanje betona; ambulantna kola; kamp vozila; motorne kućice na točkovima; vozila za sneg; vozila sa daljinskim upravljačem, nisu igračke; osovine za vozila; kola za spavanje; kutije menjača za kopnena vozila; školjke za vozila; pretvarači obrtnog momenta za kopnena vozila; kamioni cisterne za ulje; kabine za instaliran kablovski transport [žičare]; livena kola i prikolice; kolica za čišćenje; vozila za kretanje po vodi; vozila na vazdušni jastuk; opruge za ublažavanje udara za vozila; nosači prtljaga za vozila; tčckovi za vozila; centralni rotirajući deo točka vozila; šasije za vozila; branici vozila; kočnice za vozila; vrata za vozila; opruge za vešanje vozila; felne za točkove vozila; sedista za vozila; tapacirunzi za vozila.

Klasa 37: Održavanje i popravka motornih vozila; pranje vozila; usluge servisnih stanica za vozila [benzinskih pumpi]; čišćenje vozila; pomoć vozilima u kvaru [popravka]; vulkanizacija guma [popravka].

---

(210) **Ž-2020-399**

(220) 05.11.2020.

(731) Zhengzhou Yutong Bus Co., Ltd., Yutong Road, Guancheng District, Zhengzhou, CN

(540)

The logo for YUTONG, consisting of the word "YUTONG" in a bold, black, sans-serif font. The letters are closely spaced and the overall appearance is clean and professional.

(550) I

(740) Božidar S.Radulović, Baku 30/5, 81000, Podgorica

(511) Klasa 12: Viljuškari; kamioni sa ugrađenim kranom; podizači zadnjih vrata [delovi kopnenih vozila]; kamioni -cisterne za prskanje; autobusi; putnički autobusi; kamioni; kesoni [vozila]; karavani; prikolice [vozila]; kola za creva za polivanje; traktori; prikolice, vagoni; vozila sa točkovima nalik biciklo; električna vozila; dostavna vozila; hladnjače; vojna vozila za transport; sportska kola; kolica sa nagibom; tramvaji; vozila za kretanje po zemlj i, vazduhu, vodi ili šinama; kola; motorna kola; automobili; vozila za mešanje betona; ambulantna kola; kamp vozila; motorne kućice na točkovima; vozila za sneg; vozila sa daljinskim upravljačem, nisu igračke; osovine za vozila; kola za spavanje; kutije menjača za kopnena vozila; školjke za vozila; pretvarači obrtnog momenta za kopnena vozila; kamioni cisterne za ulje; kabine za instaliran kablovski transport [žičare]; livena kola i prikolice; kolica za čišćenje; vozila za kretanje po vodi; vozila na vazdušni jastuk; opruge za ublažavanje udara za vozila; nosači prtljaga za vozila; tčckovi za vozila; centralni rotirajući deo točka vozila; šasije za vozila; branici vozila; kočnice za vozila; vrata za vozila; opruge za vešanje vozila; felne za točkove vozila; sedista za vozila; tapacirunzi za vozila.

Klasa 37: Održavanje i popravka motornih vozila; pranje vozila; usluge servisnih stanica



za vozila [benzinskih pumpi]; čišćenje vozila; pomoć vozilima u kvaru [popravka]; vulkanizacija guma [popravka].

---

(210) **Ž-2020-400**

(220) 05.11.2020.

(731) ZHENGZHOU YUTONG BUS CO., LTD., YUTONG ROAD, GUANCHENG DISTRICT, ZHENGZHOU, CN

(540)



(550) I

(740) Božidar S.Radulović, Baku 30/5, 81000, Podgorica

(511) Klasa 12: Viljuškari; kamioni sa ugrađenim kranom; podizači zadnjih vrata [delovi kopnenih vozila]; kamioni -cisterne za prskanje; autobusi; putnički autobusi; kamioni; kesoni [vozila]; karavani; prikolice [vozila]; kola za creva za polivanje; traktori; prikolice, vagoni; vozila sa točkovima nalik biciklo; električna vozila; dostavna vozila; hladnjače; vojna vozila za transport; sportska kola; kolica sa nagibom; tramvaji; vozila za kretanje po zemlji i, vazduhu, vodi ili šinama; kola; motorna kola; automobili; vozila za mešanje betona; ambulanta kola; kamp vozila; motorne kućice na točkovima; vozila za sneg; vozila sa daljinskim upravljačem, nisu igračke; osovine za vozila; kola za spavanje; kutije menjača za kopnena vozila; školjke za vozila; pretvarači obrtnog momenta za kopnena vozila; kamioni cisterne za ulje; kabine za instaliran kablovski transport [žičare]; livena kola i prikolice; kolica za čišćenje; vozila za kretanje po vodi; vozila na vazdušni jastuk; opruge za ublažavanje udara za vozila; nosači prtljaga za vozila; točkovi za vozila; centralni rotirajući deo točka vozila; šasijske za vozila; branici vozila; kočnice za vozila; vrata za vozila; opruge za vešanje vozila; felne za točkove vozila; sedista za vozila; tapacirunzi za vozila.

Klasa 37: Održavanje i popravka motornih vozila; pranje vozila; usluge servisnih stanica za vozila [benzinskih pumpi]; čišćenje vozila; pomoć vozilima u kvaru [popravka]; vulkanizacija guma [popravka].

---

(210) **Ž-2020-404**

(220) 27.10.2020.

(731) Philip Morris Products S.A., Quai Jeanrenaud 3, 2000, Neuchâtel, CH

(540)

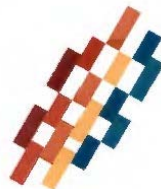

(550) I

(740) Milena Pejović, Cetinjski put 11, The Capital Plaza IV floor, 81000, Podgorica  
(511) Klasa 34: Žičani vaporizatori za elektronske cigarete i elektronske uređaje za pušenje; duvan , sirov ili prerađen; duvanski proizvodi uključujući cigare, cigarete, cigarilose, duvan za uvijanje cigareta, duvan za lule, duvan za žvakanje, duvan za šmrkanje, kretek; snus (duvan u prahu); zamjena za duvan (za nemedicinsku upotrebu); artikli za pušače, uključujući papir za cigarete, tube za cigarete, filtere za cigarete, kutije za duvan, kutije za cigarete, tabakere i pepeljare, lule, džepne mašine za uvijanje cigareta, upaljače; šibice; duvanski štapići, duvanski proizvodi za zagrijavanje, elektronski uređaji i njihovi djelovi koji se koriste za zagrijavanje cigareta ili duvana u cilju oslobađanja aerosola koji sadrži nikotin za inhalaciju; tečni nikotinski rastvori za upotrebu u elektronskim cigaretama; elektronski uređaji za pušenje; elektronske cigarete; elektronske cigarete kao zamjena za tradicionalne cigarete; elektronski uređaji koji sadrže aerosol za inhalaciju nikotina; oralni vaporizatori za pušače, duvanski proizvodi i zamjene za duvan; artikli za pušače elektronskih cigareta; djelovi i oprema za navedene proizvode iz klase 34; uređaji za gašenje cigareta i cigara koji se zagrijevaju i duvanskih štapića koji se zagrijevaju; punjive elektronske kutije za cigarete.

---

(210) **Ž-2020-414**

(220) 13.11.2020.

(731) Jaguar Land Rover Limited, Abbey Road, Whitley, CV3 4LF, Coventry, GB

(540)

**XE**

(550) I

(740) AOD "ĆUPIĆ", Bulevar Džordža Vašingtona 79, 81000, Podgorica

(511) Klasa 9: Računarski hardver; putni računari za vozila; računari za autonomnu vožnju; ugrađeni elektronski sistemi za pružanje pomoći u vožnji i parkiranju; ugrađeni elektronski sistemi za automatsko kočenje; ugrađeni elektronski sistemi za pomoć u održavanju ili promjeni trake tokom vožnje; tempomat za vozila; uređaj za kontrolu brzine vozila; računarski softver; interaktivni multimedijalni softver; softver koji se aktivira glasom; softver za prepoznavanje glasa; softver za obradu glasa; računarski softver za pretraživanje, lociranje, prikupljanje, indeksiranje, korelaciju, čuvanje, dobijanje i organizovanje podataka; softver za pretraživanje intrneta ili baze podataka; automobilski računarski softver i hardver; računarski softver za upotrebu u vezi sa vozilima; telemetrijski uređaji za motorna vozila i motore; električni kontrolni paneli; uređaji, instrumenti i displeji za elektronsko upravljanje; senzori; integrisani elektronski bezbjednosni sistemi za vozila; bezbjednosni i pomoćni sistemi za vožnju vozila; laseri za upotrebu u vezi sa vozilima; LIDAR uređaj za vozila; radarski uređaji za vozila; kamere za vozila; ugrađene kamere; akcione kamere; senzori za parkiranje i kamere za vožnju unazad; kamere za kacigu; kamere na instrument tabli; automobilski mjerni instrumenti; elektronski uređaji za prikupljanje mjerenja i prijem podataka; računarski softver, mobilne aplikacije i oprema za bežični prenos i prijem za upotrebu u vezi sa autonomnom i hendsfri vožnjom, sigurnosnim funkcijama automobila i funkcijama upozorenja ili alarma, sprečavanjem nezgoda i upozorenjima o saobraćaju; upravljačka jedinica za vožnju vozila; kompjuterizovani sistemi pomoći vozaču za motorna vozila; stanice za punjenje električnih vozila; aparati i kablovi za upotrebu pri punjenju

električnih vozila; baterije za vozila; električni konektori za napajanje električnih vozila; električni akumulatori, regulatori napona, antene, električne baterije i nosači; protiv provalni upozoravajući uređaji; alarmni senzori; mjerila; elektronske ili računarske instrument table i sklopovi; odometri; brzinomeri; tahometri; senzori temperature; voltmetri; ampermetri; aparati za ispitivanje za testiranje; mjerači blizine; električni prekidač za strujno kolo; komutatori; električni kondenzatori; električne veze (spojnice); električni kablovi; električni osigurači; kutije za električne osigurače; električni upravljački uređaji i instrumenti za motorna vozila i motore; električni senzori; aparati za gašenje požara; štampana električna kola; električni releji; električni prekidači; svežnjevi električnih kablova; uređaji za snimanje, prenos ili reprodukciju zvuka i slika; daljinski upravljači za motore; uređaji za daljinsko upravljanje za pokretanje vozila; uređaji za daljinsko upravljanje vozilima; glasovno aktivirani kontroleri za vozila; glasovno aktivirani kontroleri za multimedijalne uređaje; daljinski upravljači i glasovno aktivirani kontroleri za kućne uređaje za audiovizuelnu zabavu ili za kućne aparate, sisteme grijanja, ventilacione sisteme, zastore prozora, vrata ili brave; daljinski upravljači i glasovno aktivirani kontroleri za video igre, sisteme za projekciju ili za sisteme virtuelne stvarnosti; svijetla za upozorenje u slučaju opasnosti; elektronski sistem za obavještanje o vanrednim situacijama; uređaji za računarski intelfejs koji čine sastavni dio vozila; displeji za vozila; elektronski sistemi prikaza vozača za vozila; audio, audiovizuelna ili telekomunikaciona oprema; ekrani; radio aparati; audiovizuelni zabavni sistemi u automobilu; oprema za reprodukciju zvuka; televizori; radio; CD plejeri; zvučnici; pametni zvučnici; bežični zvučnici; slušalice; lični digitalni asistenti; tablet računari; multimedijalni uređaji; MP3 ili MP4 uređaji i plejeri; mobilni hard diskovi; USB uređaji; futrole i držači za mobilne telefone, pametne telefone, računare, lične digitalne asistente, laptop-ove, notebook-ove; punjači za mobilne telefone, pametne telefone, laptop-ove i tablet računare; futrole za telefon i nosači prilagođeni za bicikle; nosivi uređaji za praćenje aktivnosti; nosivi digitalni elektronski uređaji koji mogu da obezbjede pristup Internetu; periferni uređaji prilagođeni za upotrebu sa računarima, uključujući više USB portova, računarske miševe, prostirke za miševe, bežične zvučnike, USB fleš diskove, slušalice; telefoni; mobilni telefoni; slušalice i pribor za mobilne telefone i tablet računare; kaiševi/vezice za telefon; telekomunikacioni aparati; čvorišta za telekomunikacione sisteme; skrinsejveri za telefone i tablete; automobilske telefonske instalacije; pametni satovi; računarski uređaji u vidu narukvice; narukvice sa elektronski kodiranim identitetom; mediji za snimanje; oprema za upozoravanje na hitne slučajeve na autoputu; termometri; kompas; kalkulatori; elektronski uređaji i instrumenti za instrukcije i učenje; električni dijagnostički i naučni uređaji za upotrebu u popravci i servisiranju vozila; magneti; trake za mjerenje; optički proizvodi, stakla, sunčane naočare, naočare za vožnju, naočare za skijanje; naočare za bicikliste; futrole za naočare, sunčane naočare ili naočare za skijanje; kacige; kacige za vozače; zastitna odjeća za trkačke vozače; aparati, rukavice i odjeća, sve za zaštitu u slučaju nesreće ili povrede; maske protiv zagađenja za zaštitu disajnih puteva; aksesoari za visoku vidljivost koji se nose na tijelu [sigurnosni uređaji]; reflektori koji se nose na tijelu [sigurnosni uređaji]; sistem globalnog pozicioniranja (GPS); navigacioni sistemi, koji se sastoje od elektronskih predajnika, prijemnika, kola, mikroprocesora, mobilnog telefona i računarskog softvera, svi za upotrebu u navigaciji i svi integrisani u motorno vozilo; elektronske mape koje se mogu download-ovati; oprema za bežični prenos i prijem podataka; bežični kontroleri za daljinsko nadgledanje i upravljanje funkcijom i statusom drugih električnih, elektronskih, signalnih sistema i mehaničkih uređaja za upotrebu u vezi sa vozilima i motorima za vozila; komunikacioni uređaji za prenos i prijem

komunikacija preko vozila; računarski hardver i softver za praćenje ponašanja vozača; senzori, računari i bežični primopredajnici koji omogućavaju povezivanje unutar vozila, između vozila, mobilnih telefona i data centara; računarski hardver i softver za pružanje taktilnih, zvučnih i vizuelnih interfejsa za interakciju sa putnicima u vozilu; oprema za bežični prenos i prijem za upotrebu u vezi sa udaljenim računarima za upotrebu u automobilima za praćenje, nadgledanje i dijagnostikovanje održavanja vozila i za pružanje informacija vozačima; računarski aplikativni softver za upotrebu od strane vozača i putnika vozila za pristup, pregled i interakciju sa informacijama i sadržajem za zabavu i njihova downloadovanje; softver za download-ovanje i ugrađeni računarski softver koji korisnicima omogućava daljinski pristup i pristup unutar vozila funkcijama motornih vozila i funkcijama koje se odnose na sigurnost vozača, udobnost, komunikaciju, zabavu i navigaciju; dijagnostički uređaj koji se sastoji od senzora za upotrebu u ispitivanju funkcije vozila i u dijagnostikovanju električnih i mehaničkih problema vozila; softver i softverske aplikacije koji omogućavaju korisnicima da prate i pronađu ukradena vozila, pune elektroniku i čuvaju i sinhronizuju prikupljene personalizovane informacije o korisnicima i vozilima; moduli elektronskog interfejsa za žičani i bežični interfejs mobilnih telefona i elektronskih medija uređaja sa automobilskim električnim sistemom; računarski sistemi za automatizovanu kontrolu vozila; mobilne aplikacije koje se mogu download-ovati; elektronske publikacije koje se mogu download-ovati; elektronske publikacije; elektronske periodične publikacije; aplikativni softver za upotrebu u vozilima ili u vezi sa njima; računarske igre, softver za računarske igre; baze podataka, skupovi podataka, datoteke podataka i softver koji se odnose na 3D štampu; baze podataka, skupovi podataka, datoteke podataka i softver koji se odnose na dizajn i proizvodnju vozila i njihovih djelova i aksesora; baze podataka, skupovi podataka, datoteke podataka i softver koji se odnose na dizajn i proizvodnju replika ili modela vozila i njihovih djelova i aksesora; softver i datoteke podataka za kompjuterski potpomognuto dizajniranje (CAD); datoteke slika koje se mogu download-ovati; elektronske baze podataka koje sadrže datoteke slika; baze podataka, skupovi podataka, datoteke podataka i softver koji se odnose na šeme dijeljenja automobila; baze podataka, skupovi podataka, datoteke podataka i softver koji se odnose na ponašanje vozača vozila; simulatori za simulaciju rada kopnenih vozila; virtuelni modeli vozila ili unutrašnjosti vozila; softver i hardver za virtuelnu stvarnost; softver i hardver proširene stvarnosti; stakla za lampe, antirefleksna stakla za lampe; djelovi i oprema za bilo koju od gore pomenutih roba.

Klasa 12: Vozila; motorna vozila; uređaji za kretanje kopnom, vazduhom i / ili vodom; motorna kopnena vozila; kopnena vozila; terenska vozila; ATV -ovi; motorna vozila bez vozača; autonomna motorna vozila; trkački automobili; obnovljena klasična vozila; vozila koja se prodaju u obliku djelova za sklapanje; komercijalna vozila; električna vozila; hibridna vozila; vojna vozila; vozila za upotrebu u hitnim službama, službarna traganja i spasavanja; pogonski sklopovi za kopnena vozila; pogonske mašine za kopnena vozila; motori za kopnena vozila; pogonske mašine za motocikle; motori za motocikle; pogonske mašine za bicikle; motori za bicikle; motori za trkačke automobile; prikolice; nasloni za ruke za sjedišta u vozilu; torbe za prtljag posebno prilagođene da stanu u prtljažnik vozila; torbe, mreže i tačne za organizaciju unutrašnjosti automobila posebno prilagođene da stanu u vozilima; oblikovane i uklopljene prostirke i podne obloge za vozila; nasloni za glavu za sjedišta u vozilu; prekrivači naslona za glavu u vozilu; zaštitni i ukrasni poklopci za krilno ogledalo; presvlake za auto sjedišta; navlake za volane vozila; prilagođeni pokrivači za vozila; točkovi za vozila; aluminijske felne; obloge točkova; felne; rezervni točkovi; rotkapne za glavninu točkova; kapice središnjeg dijela glavnine točkova; pokrivači za točkove; lančanici na točkovima; spojleri za vozila; presvlake za vozila; sjedišta za vozila; sigurnosna sjedišta za

vozila; sigurnosni pojasevi za vozila; sigurnosni kaiševi za vozila; sigurnosni signali [zvučni] za vozila; vazdušni jastuci za putnike; uređaji i oprema za zaštitu od krađe, zaštitu i sigurnost; rešetke hladnjaka za vozila; obloge za karoserije vozila; vrata za vozila; prozori vozila; vjetrobranska stakla vozila; prozorsko staklo za prozore i vjetrobranska stakla; krovni prozori za vozila; skylight prozori za vozila; branici za vozila; centralne konzole vozila koje se prodaju kao djelovi vozila i koje sadrže elektronske interfejse; bicikli; tricikli; djelovi, oprema i pribor za bicikle; hover board-ovi; skuteri; kvadricikli; motorizovani monocikli; kartinzi; kolica za bebe i kišobran kolica, kao i njihovi djelovi i dodaci; sjedišta za bebe, dojenčad i dijete za vozila; štitnici od sunca, krovni nosači, nosači prtljaga i mreže, nosači za bicikle, nosači za dasku za jedrenje, nosači skija i lanci za snijeg, sve za vozila; dronovi; bespilotne letilice; lična vazдушna vozila; vozila na vazdušni jastuk, hoverkrafti; podvodna vozila; vozila sa mlaznim pogonom za sportove na vodi; vozila na daljinsko upravljanje, koja nisu igračke; djelovi i oprema za svu pomenutu robu.

Klasa 37: Građevinske usluge; konstrukcione usluge; održavanje, popravka, servisiranje, remont, restauracija, inspekcija [prije popravke ili servisiranja], njega, čišćenje, farbanje i poliranje motornih kopnenih vozila, bicikala, dronova, bespilotnih letilica, građevinskih mašina, mašina za proizvodnju automobila, poljoprivrednih mašina, motora sa unutrašnjim sagorjevanjem ili djelova i opreme za sve ove proizvode; nanošenje spoljnih završnih obloga ili premaza na vozilima; dijagnostičke ili inspeksijske usluge, sve za vozila ili za njihove djelove i priključke ili za motore sa unutrašnjim sagorjevanjem; montaža dodatne opreme za vozila (usluge ugradnje); pomoć pri kvaru vozila [popravka]; pružanje hitne usluge popravke na putu; podešavanje motora i motornih vozila; pružanje pomoći u održavanju i popravci vozila i informacije vozačima u vezi sa njihovim vozilima; usluge održavanja, nadogradnje i dijagnostičke popravke elektroničkih sistema u vozilu ili sistema za zabavu u automobilu; usluge stanica za punjenje električnih vozila; punjenje akumulatora vozila; usluge podešavanja automobila po narudžbi; modifikacija vozila po narudžbi; restauriranje vozila po narudžbi; podešavanje vozila po narudžbi; usluge nadogradnje automobila; informacije, savjetovanje i savjeti u vezi sa bilo kojom od gore pomenutih usluga za popravak i zamjenske djelove za motorna kopnena vozila ili za bicikle.

---

(210) **Ž-2020-421**

(220) 23.11.2020.

(731) Pfizer Inc., 235 East 42nd Street, 10017, New York, New York, US

(540)



(550) I

(740) Jasna Jusić, Marka Radovića 37, 1. sprat, stan br. 4., 81000, Podgorica

(511) Klasa 5: Farmaceutski preparati, sanitarni preparati za medicinske svrhe, vakcine.

---

(210) **Ž-2020-422**

(220) 24.11.2020.

(731) Hemofarm A.D. farmaceutsko-hemijska industrija Vršac, Beogradski put bb, 26300, Vršac, RS

(540)

ALERGOFEN

(550) I

(740) AOD MSA IP - Milojević Sekulić Advokati, Karađorđeva 65, 11000, Beograd

(511) Klasa 5: Farmaceutski proizvodi.

---

(210) **Ž-2020-438**

(220) 14.12.2020.

(300) UK 13.10.2020, broj 00003543759

(731) British American Tobacco (Brands) Limited, Globe House, 4 Temple Place, WC2R 2PG, London, GB

(540)



(550) I

(740) Miladin Popović, Đoka Miraševića 21/III, 81000, Podgorica

(511) Klasa 34: Cigarete; duvan, sirov ili prerađen; duvan za samostalno zamotavanje; duvan za lule; duvanski proizvodi; zamjene za duvan (koje nijesu za upotrebu u medicini); cigare; cigarilosi; upaljači za cigarete; upaljači za cigare; šibice; artikli za pušače; cigaret papir; cigaret tube; filteri za cigarete; džepni aparati za zamotavanje cigareta; ručne mašine za ubrizgavanje duvana u papirne tube; elektronske cigarete; tečnosti za elektronske cigarete; duvanski proizvodi namijenjeni za zagrijavanje.

---

(210) **Ž-2020-440**

(220) 15.12.2020.

(731) SAPONIA kemijska, prehrambena i farmaceutska industrija d.d. Osijek, Matije Gupca 2, 31000, Osijek, HR

(540)

Handysept

(550) I

(740) Božidar S.Radulović, Baku 30/5, 81000, Podgorica

(511) Klasa 1: Hemijski proizvodi koji se upotrebljavaju u industriji, nauci, fotografiji, poljoprivredi, hortikulturi i šumarstvu; neprerađene veštačke smole, neprerađene plastične materije, đubriva; smeše za gašenje vatre; preparati za kaljenje i zavarivanje; hemijske supstance za očuvanje namirnica; materije za štavljenje; lepljive supstance koje se upotrebljavaju u industriji.

Klasa 3: Sredstva za beljenje i druge supstance za upotrebu perionicama; preparati za čišćenje, poliranje, ribanje i nagrizanje; sapuni; parfimerija, eterična ulja, kozmetika, losioni za kosu; paste za zube, maramice impregnirane kozmetičkim losionima.

Klasa 5: Farmaceutski, veterinarski i sanitarni preparati; dietetske supstance prilagođene za upotrebu u medicini, hrana za bebe; flasteri, materijali za zavijanje; materijali za plombiranje zuba, zubarska smola; dezinfekciona sredstva; preparati za uništavanje štetočina; fungicidi, herbicidi.

---

(210) **Ž-2020-441**

(220) 16.12.2020.

(731) Dow AgroSciences LLC, 9330 Zionsville Road, 46268, Indianapolis, Indiana, US

(540)

## SOSDIA

(550) I

(740) Božidar S. Radulović, Baku 30/5, 81000, Podgorica

(511) Klasa 1: Hemikalije koje se koriste u poljoprivredi, naime stimulant rasta biljaka; preparati za ishranu biljaka; mikroorganizmi ili spore za zaštitu biljaka; regulatori rasta biljaka, uključujući biostimulante, feromone i hemikalije za upotrebu u poljoprivredi, hortikulturi i šumarstvu, đubrivo.

---

(210) **Ž-2020-442**

(220) 16.12.2020.

(731) Dow AgroSciences LLC, 9330 Zionsville Road, 46268, Indianapolis, Indiana, US

(540)

## KINSIDRO

(550) I

(740) Božidar S. Radulović, Baku 30/5, 81000, Podgorica

(511) Klasa 1: Hemikalije koje se koriste u poljoprivredi, naime stimulant rasta biljaka; preparati za ishranu biljaka; mikroorganizmi ili spore za zaštitu biljaka; regulatori rasta biljaka, uključujući biostimulante, feromone i hemikalije za upotrebu u poljoprivredi, hortikulturi i šumarstvu, đubrivo.

---

(210) **Ž-2020-443**

(220) 16.12.2020.

(731) The Procter & Gamble Company, One Procter & Gamble Plaza, 45202, Cincinnati, Ohio, US

(540)

FAIRY

(550) I

(740) AOD "Lutovac & partneri", Bulevar Ivana Crnojevića 93, 81000, Podgorica

(511) Klasa 3: Preparati za bijeljenje i druge supstance za upotrebu kod pranja veša; preparati za čišćenje, poliranje, ribanje i odmašćivanje; sapuni; preparati za pranje posuđa, kozmetika, maramice zasićene preparatima za čišćenje.

Klasa 5: Antibakterijski sapun; sapun za dezinfekciju; sredstva za dezinfekciju hemijskih toaleta; sredstva za dezinfekciju za higijenske svrhe; antibakterijska sredstva za pranje ruku; biocidi, fungicidi; herbicidi; germicidi; virucidi; maramice impregnirane dezinfekcionim, antibakterijskim, fungicidnim, germicidnim ili viricidnim preparatima; higijenski sapuni i deterdženti; sredstva za higijenu za upotrebu u domaćinstvu.

---

(210) **Ž-2020-444**

(220) 01.12.2020.

(731) Koncern za proizvodnju i promet konditorskih proizvoda Bambi a.d. Požarevac, Đure Đakovića bb, 12000, Požarevac, RS

(540)



(550) I

(740) dr Ivan Todorović, Zmaj Jovina 8 - 10, 11000, Beograd

(511) Klasa 30: Vafel proizvodi; napolitanke; oblande.

---

(210) **Ž-2020-445**

(220) 01.12.2020.

(731) Koncern za proizvodnju i promet konditorskih proizvoda Bambi a.d. Požarevac, Đure Đakovića bb, 12000, Požarevac, RS

(540)





(550) I

(740) dr Ivan Todorović, Zmaj Jovina 8 - 10, 11000, Beograd

(511) Klasa 30: Vafel proizvodi; napolitanke; oblande.

---

(210) **Ž-2020-447**

(220) 17.12.2020.

(731) GRENDENE S.A., Avenida Pimentel Gomes, 214 , 62040-125, Expectativa - Sobral, CE, BR

(540)

**RIDER**

(550) I

(740) Jasna Jusić, Marka Radovića 37, 1. sprat, stan br. 4., 81000, Podgorica

(511) Klasa 25: Sandale i papuče svih vrsta.

---

(210) **Ž-2020-448**

(220) 17.12.2020.

(731) Borsodi Sörgyár Kft., Böcs Rákóczi u. 81., H-3574, HU

(540)

**WAI MOMENT**

(550) I

(740) Pavle Tripković, City kvart - Cetinjski put 40, L5-1, stan 10, Podgorica

(511) Klasa 33: Alkoholna pića; cider (fermentisana alkoholna pića na bazi jabuke ili kruške); vina, žestoka pića i likeri; gazirana alkoholna pića, gazirana alkoholna pića sa ukusom voća.

---

(210) **Ž-2020-449**

(220) 17.12.2020.

(731) Borsodi Sörgyár Kft., Böcs Rákóczi u. 81., H-3574, HU

(540)



(550) I

(740) Pavle Tripković, City kvart - Cetinjski put 40, L5-1, stan 10, Podgorica

(511) Klasa 33: Alkoholna pića; cider (fermentisana alkoholna pića na bazi jabuke ili kruške); vina, žestoka pića i likeri; gazirana alkoholna pića, gazirana alkoholna pića sa ukusom voća.

---

(210) **Ž-2020-450**

(220) 18.12.2020.

(731) The Procter & Gamble Company, One Procter & Gamble Plaza, 45202, Cincinnati, Ohio, US

(540)

**AMBI-PUR**

(550) I

(740) AOD "Lutovac & partneri", Bulevar Ivana Crnojevića 93, 81000, Podgorica

(511) Klasa 5: Antibakterijski sapun; sapun za dezinfekciju; sredstva za dezinfekciju hemijskih toaleta; sredstva za dezinfekciju za higijenske svrhe; antibakterijska sredstva za pranje ruku; biocidi, fungicidi; herbicidi; germicidi; virucidi; higijenski sapuni i deterdženti; sredstva za higijenu za upotrebu u domaćinstvu.

---

(210) **Ž-2020-452**

(220) 21.12.2020.

(731) Dow AgroSciences LLC, 9330 Zionsville Road, 46268, Indianapolis, Indiana, US

(540)

**SAVIQRESS**

(550) I

(740) Božidar S.Radulović, Baku 30/5, 81000, Podgorica

(511) Klasa 5: Proizvodi za biokontrolu, naime poljoprivredni biopesticidi, bioinsekticidi; insekticidi; biofungicidi, fungicidi; biogermicidi, germicidi; bioherbicidi, herbicidi;

biofumiganti, fumiganti, bionematicidi, nematicidi.

---

(210) **Ž-2020-453**

(220) 21.12.2020.

(731) Dow AgroSciences LLC, 9330 Zionsville Road, 46268, Indianapolis, Indiana, US

(540)

## HOLZEM

(550) I

(740) Božidar S.Radulović, Baku 30/5, 81000, Podgorica

(511) Klasa 5: Proizvodi za biokontrolu, naime poljoprivredni biopesticidi, bioinsekticidi; insekticidi; biofungicidi, fungicidi; biogermicidi, germicidi; bioherbicidi, herbicidi; biofumiganti, fumiganti, bionematicidi, nematicidi.

---

(210) **Ž-2020-454**

(220) 21.12.2020.

(731) Philip Morris Products S.A., Quai Jeanrenaud 3, 2000, Neuchâtel, CH

(540)

## DIMENSIONS

(550) I

(740) Milena Pejović, Cetinjski put 11, The Capital Plaza IV floor, 81000, Podgorica

(511) Klasa 34: Žičani vaporizatori za elektronske cigarete i elektronske uređaje za pušenje; duvan , sirov ili prerađen; duvanski proizvodi uključujući cigare, cigarete, cigarilose, duvan za uvijanje cigareta, duvan za lule, duvan za žvakanje, duvan za šmrkanje, kretek; snus (duvan u prahu); zamjena za duvan (za nemedicinsku upotrebu); artikli za pušače, uključujući papir za cigarete, tube za cigarete, filtere za cigarete, kutije za duvan, kutije za cigarete, tabakere i pepeljare, lule, džepne mašine za uvijanje cigareta, upaljače; šibice; duvanski štapici, duvanski proizvodi za zagrijavanje, elektronski uređaji i njihovi dijelovi koji se koriste za zagrijavanje cigareta ili duvana u cilju oslobađanja aerosola koji sadrži nikotin za inhalaciju; tečni nikotinski rastvori za upotrebu u elektronskim cigaretama; elektronski uređaji za pušenje; elektronske cigarete; elektronske cigarete kao zamjena za tradicionalne cigarete; elektronski uređaji koji sadrže aerosol za inhalaciju nikotina; oralni vaporizatori za pušače, duvanski proizvodi i zamjene za duvan; artikli za pušače elektronskih cigareta; dijelovi i oprema za navedene proizvode iz klase 34; uređaji za gašenje cigareta i cigara koje se zagrijevaju i duvanskih štapića koji se zagrijevaju; punjive elektronske kutije za cigarete;

---

(210) **Ž-2020-455**

(220) 17.12.2020.

(731) Fuad Llunji, Hafiz Ali Ulqinaku br 145, 85360, Ulcinj, ME

(540)



(550) I

(511) Klasa 30: Kafa, čaj, kakao, šećer, riža, tapioka, sago, zamjene za kafu; brašno i proizvodi od žitarica, hleb, kolači, poslastice, bomboni, sladoled; med, sirup od melase; kvasac, prašak za pecivo; so, senf; sirće, prelive; začini; razni začini, led za hlađenje.

Klasa 35: Oglašavanje i reklamiranje, vođenje komercijalnih poslova; komercijalna administracija, kancelarijski poslovi.

Klasa 43: Usluge obezbjeđivanja hrane i pića.

---

(210) **Ž-2020-457**

(220) 22.12.2020.

(300) 80917 od 15.07.2020., JM

(731) Mars, Incorporated, 6885 Elm Street, 22101, McLean, Virginia, US

(540)

**BEN'S ORIGINAL**

(550) I

(740) Jasna Jusić, Marka Radovića 37, 1. sprat, stan br. 4., 81000, Podgorica

(511) Klasa 29: Meso; riba (ne živa); živina; divljač (ne živa); ekstrakti od mesa; svinjska mesna roba; zamjene za meso; smrznuto povrće; konzervisano povrće; povrće, sušeno; povrće kuvano; voće, konzervisano; sušeno voće; kuvano voće; prerađeno voće, gljive i povrće (uključujući orašaste plodove i grahorice); prerađeno povrće; prerađene mahunarke; sočiva; prerađene leblebije; prerađeni pasulj; pečeni pasulj; pasulj u sosu; sojina zrna, konzervirana, za ishranu; tofu; paradajz pire; pire od povrća; sok od paradajza za kuvanje; konzervirani paradajz; povrtni sokovi za kuvanje; ukisiljeno povrće; proizvodi za pravljenje supe; supe; zalihe; proizvodi za pravljenje bujona; bujon; listići od krompira; želei; želei, džemovi, kompoti, voćni i povrtni namazi; jaja; mliječni proizvodi i zamjene za mliječne proizvode; mlijeko; proizvodi od mlijeka; zamjene za mlijeko; kokosovo mlijeko; mlijeko od riže; mlijeko od soje; sir; jogurt; jestiva ulja i masti; kokosovo ulje; ulje od čilija; sojino ulje; kukuruzno ulje; sezamovo ulje; začinjena ulja; aromatična jestiva ulja; kokosova mast; biljne masti za ishranu; umaci; koštunjavi plodovi, obrađeni; namazi od koštunjavih plodova; sjemenke, obrađene; grickalice od voća; grickalice od mahunarki; grickalice od orašastih plodova; grickalice od povrća; gotovi kari gulaš; vegetarijanski čili; čili sa mesom; gotova jela napravljena uglavnom od mesa; gotove salate; gotova jela od povrća; gotova jela napravljena prvenstveno od mesa; gotova jela napravljena prvenstveno od zamjena za meso; gotova jela napravljena prvenstveno od živinskog mesa; gotova jela napravljena prvenstveno od povrća; gotova jela napravljena prvenstveno od ribe; zamrznuta gotova jela napravljena prvenstveno od povrća; zamrznuta gotova jela napravljena prvenstveno od mesa; zamrznuta gotova jela napravljena prvenstveno od zamjena za meso; zamrznuta jela

napravljena prvenstveno od ribe; zamrznuta jela napravljena prvenstveno od živinskog mesa; gotova kuvana jela napravljena prvenstveno od mesa; gotova kuvana jela napravljena prvenstveno od zamjena za meso; gotova kuvana jela napravljena prvenstveno od živinskog mesa; gotova kuvana jela napravljena prvenstveno od povrća; gotova kuvana jela napravljena prvenstveno od ribe.

Klasa 30: Kafa; čaj; kakao; zamjena kafe; pirinač; tapioka; sago; tjestenina; rezanci; njoki; makaroni; kuskus [griz]; brašno; proizvodi od žitarica; prerađene žitarice; prerađene žitarice; integralna riža; dugozrna riža; divlja riža; smeđa riža; basmati riža; barena riža; rižoto; mješavina riže; mješavina riže s povrćem, pilećim ekstraktima, mesnim ekstraktima, sirom, pasuljem, mahunarkama, mirođijama, aromama, začinskim biljem, začinicima; pakovani obroci koji se sastoje uglavnom od pirinča; prerađena kinoa; prerađene žitarice, skrob i proizvodi od njih, pekarski proizvodi i kvasac; prašak za pecivo; tijesto, tijesto i njihove mješavine; hljeb; peciva; poslastice; kolači; torte; keksi; šećer, med, melasa; pice; pite; sladoled; pudinzi; jestivi led; kokice; čips od žitarica; začini; sosevi; sosevi za kuvanje; proizvodi za pravljenje soseva; kari sosevi; sosevi za tjesteninu; sosevi za tjesteninu; čili sosevi; soja sos; ljuti sos; slatko kiseli sos; ljuti sosevi; pikantni sosevi; sosevi za pirinač; sosevi u prahu; mješavine za pripremu soseva; arome u obliku koncentrovanih soseva; gotovi prehrambeni proizvodi u obliku soseva; marinade; prelive za salate; mješavine raznih začina; brašnaste paste za ishranu; prilozii; sok od pečenja; proizvodi za zgušnjavanje kuvane hrane; pesto [sos]; senf; sirće; so; začini; začini; kulinarsko začinsko bilje; prerađeni bijeli luk koji se koristi kao začini; prerađeni đumbir koji se koristi kao začini; mljeveni đumbir; začinske paštete; biber; čili začini; čili pašeta koja se koristi kao začini; aromatični proizvodi za ljudsku ishranu; arome za prehrambene proizvode; ekstrakti koji se koriste kao arome [niju esencijalna ulja]; mješavina začina; začinski proizvodi; ekstrakti začina; začini koji se utrljavaju; mješavine karija; gotova jela na bazi tjestenina; gotova jela na bazi pirinča; gotova jela na bazi rezanaca; instant rezanci; instant pirinač; grickalice (na bazi žitarica); grickalice (na bazi pirinča); grickalice koje se uglavnom sastoje od tjestenine; grickalice koje se uglavnom sastoje od pirinča; jela koja se uglavnom sastoje od tjestenine; jela koji se uglavnom sastoje od pirinča; jela koja se uglavnom sastoje od prerađenih žitarica; jela koja se uglavnom sastoje od žitarica; jela koja se uglavnom sastoje od kine i prerađenih žitarica; jela koja se uglavnom sastoje od rezanaca; smrznuta jela koja se uglavno sastoje od tjestenine; smrznuta jela koja se uglavno sastoje od pirinča; smrznuta jela koja se uglavno sastoje od prerađenih žitarica; smrznuta jela koja se uglavno sastoje od prerađenih žitarica; smrznuta jela koja se uglavnom sastoje od kine i prerađenih žitarica; smrznuta jela koja se uglavnom sastoje od rezanaca; suva i tečna gotova jela, koja se uglavnom sastoje od pirinča; suva i tečna gotova jela, koja se uglavnom sastoje od tjestenine; suva i tečna gotova jela, koja se uglavnom sastoje od rezanaca; prerađene žitarice kombinovane u jedinstvenim pakovanjima sa začinicima i aromama; prerađene žitarice kombinovane u jedinstvenim pakovanjima sa začinicima i aromama; prerađena kinoa i žitarice kombinovani u jedinstvenim pakovanjima sa začinicima i aromama; pirinač kombinovan u jedinstvenim pakovanjima sa začinicima i aromama; prerađene žitarice kombinovane u jedinstvenim pakovanjima sa jestivim sjemenkama, grahoricama, mahunarkama ili povrćem; prerađene žitarice kombinovane u jedinstvenim pakovanjima sa jestivim sjemenkama, grahoricama, mahunarkama ili povrćem; prerađena kinoa i žitarice kombinovani u jedinstvenim pakovanjima sa jestivim sjemenkama, grahoricama, mahunarkama ili povrćem; pirinač kombinovan u jedinstvenim pakovanjima sa jestivim sjemenkama, grahoricama, mahunarkama ili povrćem; tjestenina kombinovana u jedinstvenim pakovanjima sa jestivim

sjemenkama, grahoricama, mahunarkama ili povrćem; rezanci kombinovani u jedinstvenim pakovanjima sa jestivim sjemenkama, grahoricama, mahunarkama ili povrćem.

(210) **Ž-2020-458**

(220) 22.12.2020.

(731) Codingo d.o.o. Podgorica, Ulica II crnogorskog bataljona 2L, 81000, Podgorica, ME

(540)



(550) I

(511) Klasa 35: Ažuriranje i održavanje podataka u računarskim bazama podataka; Ažuriranje i održavanje podataka u registrima; Ciljani marketing; Eksternaliziranje, ERP sistemi; Outsourcing; Fakturisanje; Indeksiranje internetskih stranica za komercijalne ili reklamne potrebe; Istraživanja za poslove; Istraživanje tržišta; Iznajmljivanje bilborda [reklamne table]; Iznajmljivanje kancelarijskih mašina i opreme; Iznajmljivanje kancelarijske opreme u zajedničkim radnim prostorijama; Iznajmljivanje reklamnih prostora; Iznajmljivanje reklamnog materijala; Iznajmljivanje vremena za reklamiranje na komunikacijskim medijima; Izrađivanje profila potrošača za komercijalne ili marketinške potrebe; Izvodi računa; Knjigovodstvo; Konsultantske usluge vezane za komunikacione strategije za reklamiranje; Marketing; Marketing u okviru izdavanja softvera; Nacrt stranica u reklamne svrhe; Objavljivanje reklamnih tekstova; Obrada teksta; Odnosi s javnošću; Oglašavanje; Oglašavanje plaćanjem po kliku; Omogućavanje on-line tržišta za kupce i prodavce roba i usluge; Online maloprodajne usluge za preuzimanje digitalne muzike; Online maloprodajne usluge za preuzimanje melodija za mobilne telefone; Online oglašavanje na računarskim mrežama; Optimizacija pretraživača; Optimizacija prometa na web-stranici; Organizovanje poslova (savjetovanje o organizovanju poslova); Organizovanje trgovačkih sajmova; Pisanje reklamnih tekstova; Presentacija proizvoda putem medija u svrhu prodaje na malo; Promocija roba i usluga kroz sponzorstvo sportskih događaja; Proučavanje tržišta [marketing]; Pružanje poslovnih informacija putem web- stranice; Računarske datoteke (prikupljanje podataka u-); Razvoj reklamnih koncepcija; Reklamiranje dopisnim putem; Reklamna dokumentacija (uređenje reklamne dokumentacije); Sakupljanje indeksa informacija u komercijalne ili reklamne svrhe; Sastavljanje statističkih podataka; Spoljno oglašavanje; Stručne poslovnokonsultacije; Stručne usluge za poslovnu efikasnost; Televizijske reklame; Traženjesponzorstva; Usluge posredovanja u trgovini; Usluge praćenja konkurencije; Usluge spoljne pomoći, outsourcing; Usluge telemarketinga; Vođenje informatičkih kartoteka.

Klasa 38: Bežično emitovanje; Davanje u najam pristupnog vremena globalnim kompjuterskim mrežama; Elektronska pošta; Forumi [sobe za četovanje] za društvene mreže; Iznajmljivanje aparata za prenos poruka; Iznajmljivanje modema; Iznajmljivanje telefona; Iznajmljivanje telekomunikacionih uređaja; Komunikacija kompjuterskim terminalima; Komunikacija mobilnim telefonima; Komunikacija optičkim mrežama; Komunikacija telefonom; Najam pametnih telefona; Omogućavanje pristupa bazama

podataka; Omogućavanje pristupa svjetskim informatičkim mrežama; Prenos čestitki putem Interneta; Prenos digitalnih datoteka;

Prenos podcast sadržaja; Prenos poruka i slika kompjuterom; Prenos digitalnih datoteka; Prenos putem satelita; Prenos video sadržaja na zahtjev; Protok podataka; Pružanje komunikacijskih kanala za telefonsku kupovinu; Pružanje usluga mrežnih foruma; Radio komunikacija; Radiodifuzija; Slanje poruka; Slanje telegrama; Štamparske agencije; Telefonske usluge; Telegrafske usluge; Telekomunikacijsko povezivanje na svjetsku informatičku mrežu; Usluge elektronskih oglasnih panoa; Usluge glasovne pošte; Usluge jednosmjernog poziva [radio, telefonska ili ostala elektronska komunikaciona sredstva]; Usluge videokonferencije; Usluge usmjeravanja i spajanja za telekomunikacije.

Klasa 41: Profesionalna orijentacija (edukacija ili usluge obuke); Elektronsko izdavaštvo; Obuka; Online objavljivanje elektronskih knjiga i online; Organizacija i vođenje individualnih foruma; Podučavanje; Prenos stručnih znanja [osposobljavanje].

Klasa 42: Analiza kompjuterskih sistema; Čuvanje elektronskih podataka; Digitalizacija dokumenata; Dizajn vizit karti; Dupliranje kompjuterskog programa; Elektronski nadzor informacija koje omogućavaju identifikovanje lica radi otkrivanja krađe identiteta putem interneta; Elektronsko praćenje aktivnosti na kreditnoj kartici radi otkrivanja prevare putem interneta; Grafički dizajn promotivnih materijala; Instaliranje kompjuterskih programa; Inženjerske usluge; Istraživanje i razvoj novih proizvoda za druge; Istraživanja u oblasti telekomunikacionih tehnologija; Iznajmljivanje informatičkih softvera; Iznajmljivanje kompjutera; Iznajmljivanje veb servera; Izrada i dizajn internetskih indeksa informacija za druge osobe [usluge informacionih tehnologija]; Izrada softverskog dizajna; Kompjutersko programiranje; Kompjutersko tehnološke konsultacije; Konsultacije u vezi s računarskim programima [softverima]; Konsultantske usluge internet bezbjednosti; Konsultantske usluge zaštite podataka; Kontrola kvaliteta; Konverzija kompjuterskih programa i podataka, izuzev fizičke konverzije; Kreiranje i održavanje web stranica za druge; Nadzor kompjuterskih sistema u cilju otklanjanja pada sistema; Nadzor kompjuterskih sistema u cilju otkrivanja neovlašćenog pristupa ili kršenja privatnosti podataka; Nadzor računarskih sistema na daljinsko upravljanje; Naučna istraživanja; Nuđenje internet pretraživača; Održavanje kompjuterskih softvera; Otključavanje mobilnih telefona; Pisanje tehničkih tekstova; Platforma kao usluga (PaaS); Ponovno uspostavljanje baza podataka; Pretvaranje podataka ili dokumenata s fizičkog na elektronički nosač; Priprema sigurnosnih kopija off-site; Projektovanje kompjuterskog sistema; Pružanje informacija o računarskoj tehnologiji i programiranju putem web-stranice; Računarstvo u oblaku, cloud computing; Razvoj kompjuterskih platformi; Razvoj softvera u okviru izdavanja softvera; Savjetovanje o dizajnu i razvoju kompjuterskog hardvera; Savjetovanje o informatičkoj tehnologiji [IT]; Savjetovanje u vezi sa dizajnom web stranice; Server hosting, pružanje usluga unajmljivanja servera; Sijanje oblaka; Softver kao usluga [SaaS]; Spoljašnji pružaoci usluga u području informacijske tehnologije; Tehnika istraživanja; Telekomunikacione tehnološke konsultacije; Usavršavanje, osavremenjavanje kompjuterskog softvera; Usluge enkripcije podataka; Usluge grafičkog dizajna; Usluge provjere autentičnosti korisnika tehnologijom za transakcije e-trgovanja; Usluge provjere autentičnosti korisnika tehnologijom jedinstvene prijave za mrežne softverske aplikacije; Usluge savjetovanja u vezi sa kompjuterskom sigurnosti; Usluge web stranica za ugošćavanje, hosting; Zaštita informatičkih virusa.

(210) **Ž-2020-459**

(220) 22.12.2020.

(731) Monteberbering DOO, , Budva, ME

(540)



(550) I

(511) Klasa 25: Odjeća, obuća, pokrivala za glavu; muške majice; obuću; odjeću; muške dodatke odjeći.

Klasa 41: Obrazovne usluge; pripremanje obuke; razonoda; sportske i kulturne aktivnosti; usluge koje pružaju lica ili institucije u razvijanju mentalnih sposobnosti drugih lica (obrazovanje) ili životinja (obuka, dresiranje) kao i usluge kojima je cilj zabavljanje drugih lica ili privlačenje pažnje; usluge koje pružaju sve vrste edukacije lica (obrazovanje) ili životinja (obuka, dresiranje); usluge kojima je osnovni cilj zabavljanje drugih lica, rekreacija; organizovanje (priređivanje) i vođenje seminara, konferencija, kongresa; organizovanje izložbi ili prezentacije knjiga (književne večeri) u kulturne i obrazovne svrhe, sportskih takmičenja; izdavanje tekstova i knjiga.

Klasa 44: Medicinske usluge; veterinarske usluge; higijenska zaštita i nega lepote za ljude ili životinje; agrikulturne, hortikulturne i šumarske usluge; medicinske, higijenske i usluge nege lepote koje pružaju lica ili ustanove ljudima i životinjama; usluge na polju agrikulture, hortikulture i šumarstva; usluge medicinske analize koje se odnose na lečenje lica ( kao ispitivanje rengenom i uzimanje krvi radi analize); usluge veštačke oplodnje; farmaceutski saveti; 26 - razmnožavanje životinja; usluge koje se odnose na gajenje biljaka kao sto je vrtlarstvo; usluge koje se odnose na cvetnu umetnost kao sto je ikebana kao vrtna arhitektura I dizajn baste; muško šišanje; dječije šišanje; crna maska; korekcija brade; farbanje kose i brade; manikir; muška kozmetika.

---

(210) **Ž-2020-460**

(220) 22.12.2020.

(731) Secura GmbH, Frohnhofweg 18, 50858, Köln, DE

(540)

(550) I

(740) Milena Pejović, Cetinjski put 11, The Capital Plaza IV floor, 81000, Podgorica

(511) Klasa 32: Osvježavajuća bezalkoholna pića; bezalkoholni preparati za pravljenje napitaka; pivo proizvodi za proizvodnju piva.

Klasa 33: Jabukovača; alkoholni preparati za pravljenje napitaka; alkoholna pića izuzev piva; vino; žestoka pića; pomiješana alkoholna pića; alkoholni želei; aperitivi.

Klasa 35: Usluge maloprodaje u vezi sa bezalkoholnim napicima; usluge veleprodaje u vezi sa bezalkoholnim napicima; usluge onlajn maloprodaje u vezi sa bezalkoholnim napicima;



usluge maloprodaje u vezi sa bezalkoholnim preparatima za pravljenje napitaka; usluge veleprodaje u vezi sa bezalkoholnim preparatima za pravljenje napitaka; usluge onlajn maloprodaje u vezi sa bezalkoholnim preparatima za pravljenje napitaka; usluge maloprodaje u vezi sa pivom i proizvodima za proizvodnju piva; usluge veleprodaje u vezi sa pivom i proizvodima za proizvodnju piva; usluge onlajn maloprodaje u vezi sa pivom i proizvodima za proizvodnju piva; usluge maloprodaje u vezi sa jabukovačom; usluge veleprodaje u vezi sa jabukovačom; usluge onlajn maloprodaje u vezi sa jabukovačom; usluge maloprodaje u vezi sa alkoholnim preparatima za pravljenje napitaka; usluge veleprodaje u vezi sa alkoholnim preparatima za pravljenje napitaka; usluge onlajn maloprodaje u vezi sa alkoholnim preparatima za pravljenje napitaka; usluge maloprodaje u vezi sa alkoholnim pićima izuzev piva; usluge veleprodaje u vezi sa alkoholnim pićima izuzev piva; usluge onlajn maloprodaje u vezi sa alkoholnim pićima izuzev piva; usluge maloprodaje u vezi sa vinom; usluge veleprodaje u vezi sa vinom, usluge onlajn maloprodaje u vezi sa vinom; usluge maloprodaje u vezi sa žestokim pićima; usluge veleprodaje u vezi sa žestokim pićima; onlajn usluge maloprodaje u vezi sa žestokim pićima; usluge maloprodaje u vezi sa pomiješanim alkoholnim pićima; usluge veleprodaje u vezi sa pomiješanim alkoholnim pićima; onlajn usluge maloprodaje u vezi sa pomiješanim alkoholnim pićima; usluge maloprodaje u vezi sa alkoholnim želeima; usluge veleprodaje u vezi sa alkoholnim želeima; onlajn usluge maloprodaje u vezi sa alkoholnim želeima; usluge maloprodaje u vezi sa aperitivima; usluge veleprodaje u vezi sa aperitivima; onlajn usluge maloprodaje u vezi sa aperitivima.

---

(210) **Ž-2020-461**

(220) 23.12.2020.

(731) Marija Ščekić, Ustanička bb, 84300, Berane, ME

(540)

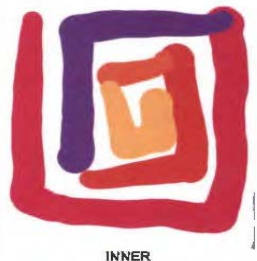

(550) I

(511) Klasa 9: Aplikacijski softver za mobilni uređaj.

Klasa 41: Razonoda; usluge kojima je cilj zabavljanje drugih lica, privlačenje pažnje, rekreacija.

Klasa 45: Individualne i društvene usluge koje pružaju drugi radi zadovoljavanja potreba pojedinaca.

---

(210) **Ž-2020-462**

(220) 23.12.2020.

(731) The Coca-Cola Company, One Coca-Cola Plaza, 30313, Atlanta, Georgia, US  
(540)

COCA-COLA

(550) I

(740) Miladin Popović, Đoka Miraševića 21/III, 81000, Podgorica

(511) Klasa 32: Piva; mineralne i gazirane vode i druga bezalkoholna pića; voćni napici i voćni sokovi; sirupi i drugi preparati za pravljenje napitaka.

---

(210) **Ž-2020-464**

(220) 21.12.2020.

(731) Koncern za proizvodnju i promet konditorskih proizvoda Bambi a.d. Požarevac, Đure Đakovića bb, 12000, Požarevac, RS

(540)

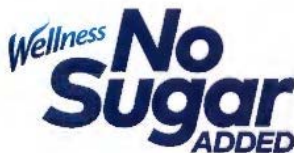

(550) I

(740) dr Ivan Todorović, Zmaj Jovina 8 - 10, 11000, Beograd

(511) Klasa 30: Integralni keks.

---

(210) **Ž-2020-465**

(220) 28.12.2020.

(731) NOBEL ILAC SANAYII VE TICARET ANONIM SIRKETI, Sary Mah., Dr. Adnan Buyukdeniz Cad., No:14, Umraniye, 34768, Istanbul, TR

(540)

Voxaban

(550) I

(740) Vesko Božović, Moskovska 99/II, 81000, Podgorica

(511) Klasa 5: Farmaceutski proizvodi.

(210) **Ž-2020-466**

(220) 28.12.2020.

(731) NOBEL ILAC SANAYII VE TICARET ANONIM SIRKETI, Sary Mah., Dr. Adnan Buyukdeniz Cad., No:14, Umraniye, 34768, Istanbul, TR

(540)

## Nicotinabs

(550) I

(740) Vesko Božović, Moskovska 99/II, 81000, Podgorica

(511) Klasa 5: Farmaceutski proizvodi.

---

(210) **Ž-2020-467**

(220) 28.12.2020.

(731) NOBEL ILAC SANAYII VE TICARET ANONIM SIRKETI, Sary Mah., Dr. Adnan Buyukdeniz Cad., No:14, Umraniye, 34768, Istanbul, TR

(540)

## Tisinon

(550) I

(740) Vesko Božović, Moskovska 99/II, 81000, Podgorica

(511) Klasa 5: Farmaceutski proizvodi.

---

(210) **Ž-2020-468**

(220) 28.12.2020.

(731) NOBEL ILAC SANAYII VE TICARET ANONIM SIRKETI, Sary Mah., Dr. Adnan Buyukdeniz Cad., No:14, Umraniye, 34768, Istanbul, TR

(540)

## NBL

(550) I

(740) Vesko Božović, Moskovska 99/II, 81000, Podgorica

(511) Klasa 3: Kozmetičke kreme; ulja za kozmetičku upotrebu; kozmetički preparati za njegu kože, kozmetički preparati za mršavljenje; fito kozmetički preparati, kozmetika za djecu.

Klasa 5: Ljekovi za medicinsku upotrebu, homeopatski preparati; nutricionistički preparati; farmaceutski i veterinarski preparati, sanitarni preparati za medicinsku upotrebu; dijetetske supstance prilagodjene za upotrebu u medicini, hrana za bebe; dijetetski proizvodi kao dodaci ishrani ( dijetetski suplementi); dijetetski proizvodi kao formule za odojčad; dijetetski proizvodi kao hrana za odojčad i malu djecu; dijetetski proizvodi kao hrana za osobe na dijeti za mršavljenje; dijetetski proizvodi kao hrana za posebne medicinske namjene; dijetetski proizvodi kao hrana za osobe intolerantne na gluten; dijetetski proizvodi kao zamjena za so

za ljudsku ishranu; probiotici; flasteri; materijali za zavijanje; materijali za plombiranje zuba; zubarska smola; dezinfekciona sredstva; preparati za uništavanje štetočina; fungicidi; herbicidi.

Klasa 35: Oglašavanje, oglašavanje na internetu; reklamiranje; prezentacija robe; usluge maloprodaje farmaceutskih, veterinarskih i higijenskih preparata, dijetetskih proizvoda i medicinskog materijala; usluge veleprodaje farmaceutskih, veterinarskih i higijenskih preparata, dijetetskih proizvoda i medicinskog materijala.

---

(210) **Ž-2020-469**

(220) 28.12.2020.

(731) NOBEL ILAC SANAYII VE TICARET ANONIM SIRKETI, Sary Mah., Dr. Adnan Buyukdeniz Cad., No:14, Umraniye, 34768, Istanbul, TR

(540)



(550) I

(740) Vesko Božović, Moskovska 99/II, 81000, Podgorica

(511) Klasa 3: Kozmetičke kreme; ulja za kozmetičku upotrebu; kozmetički preparati za njegu kože, kozmetički preparati za mršavljenje; fito kozmetički preparati, kozmetika za djecu.

Klasa 5: Ljekovi za medicinsku upotrebu, homeopatski preparati; nutricionistički preparati; farmaceutski i veterinarski preparati, sanitarni preparati za medicinsku upotrebu; dijetetske supstance prilagodjene za upotrebu u medicini, hrana za bebe; dijetetski proizvodi kao dodaci ishrani ( dijetetski suplementi); dijetetski proizvodi kao formule za odojčad; dijetetski proizvodi kao hrana za odojčad i malu djecu; dijetetski proizvodi kao hrana za osobe na dijeti za mršavljenje; dijetetski proizvodi kao hrana za posebne medicinske namjene; dijetetski proizvodi kao hrana za osobe intolerantne na gluten; dijetetski proizvodi kao zamjena za so za ljudsku ishranu; probiotici; flasteri; materijali za zavijanje; materijali za plombiranje zuba; zubarska smola; dezinfekciona sredstva; preparati za uništavanje štetočina; fungicidi; herbicidi.

Klasa 35: Oglašavanje, oglašavanje na internetu; reklamiranje; prezentacija robe; usluge maloprodaje farmaceutskih, veterinarskih i higijenskih preparata, dijetetskih proizvoda i medicinskog materijala; usluge veleprodaje farmaceutskih, veterinarskih i higijenskih preparata, dijetetskih proizvoda i medicinskog materijala.

---

(210) **Ž-2021-1**

(220) 09.01.2021.

(731) Rado Arsić, Donja Lastva bb, Tivat, ME

(540)

TEA GALLERY

(550) I

(511) Klasa 21: Stakleni proizvodi, porculansko i keramičko posuđe koje nije obuhvaćeno drugim klasama; pribor i posuđe za domaćinstvo ili za kuhinju.

Klasa 24: Tkanine i tekstilni proizvodi koji nijesu obuhvaćeni drugim klasama.

Klasa 30: Čaj, začini.

---

(210) **Ž-2021-2**

(220) 21.12.2020.

(731) Koncern za proizvodnju i promet konditorskih proizvoda Bambi a.d. Požarevac, Đure Đakovića bb, 12000, Požarevac, RS

(540)



(550) I

(740) dr Ivan Todorović, Zmaj Jovina 8 - 10, 11000, Beograd

(511) Klasa 30: Integralni keks.

---

(210) **Ž-2021-3**

(220) 31.12.2020.

(731) Koncern za proizvodnju i promet konditorskih proizvoda Bambi a.d. Požarevac, Đure Đakovića bb, 12000, Požarevac, RS

(540)

PlazMix

(550) I

(740) dr Ivan Todorović, Zmaj Jovina 8 - 10, 11000, Beograd

(511) Klasa 30: Instant mešavina na bazi keksa i sušenog voća; instant mešavina na bazi keksa i jezgrastog voća; instant mešavina na bazi keksa i čokolade; instant mešavina na bazi keksa, sušenog voća i čokolade; instant mešavina na bazi keksa, jezgrastog voća i čokolade; instant mešavina na bazi keksa, sušenog i jezgrastog voća i čokolade.

---

(210) **Ž-2021-4**

(220) 18.01.2021.

(731) ALKALOID AD Skopje, Blvd. Aleksandar Makedonski 12, 1000, Skopje, MK

(540)

## RUFIXALO

(550) I

(740) Miladin Popović, Đoka Miraševića 21/III, 81000, Podgorica

(511) Klasa 5: Farmaceutski preparati za liječenje kardiovaskularnih bolesti; antikoagulati.

---

(210) **Ž-2021-5**

(220) 19.01.2021.

(731) Bosnalijek, farmaceutska i hemijska industrija, dioničko društvo, Jukićeva 53, 71000, Sarajevo, BA

(540)

## LYMUNIX

(550) I

(740) Božidar S. Radulović, Baku 30/5, 81000, Podgorica

(511) Klasa 5: Farmaceutski proizvodi.

---

(210) **Ž-2021-6**

(220) 18.01.2021.

(731) ALKALOID AD Skopje, Blvd. Aleksandar Makedonski 12, 1000, Skopje, MK

(540)

## LOSMORID

(550) I

(740) Miladin Popović, Đoka Miraševića 21/III, 81000, Podgorica

(511) Klasa 5: Farmaceutski preparati za liječenje epilepsije.

---

(210) **Ž-2021-7**

(220) 21.01.2021.

(731) Crupa Maspex Sp. z.o.o. Sp. k., ul. Legionów 37, 34-100, Wadowice, PL

(540)

Coffeeta - Dodatak za tvoju savršenu kafu!

(550) I

(740) AOD "Lutovac & partneri", Bulevar Ivana Crnojevića 93, 81000, Podgorica  
(511) Klasa 29: Nemliječni kremovi za kafu; nemliječni kremovi za čaj i pića na bazi kakaoa; nemliječni kremovi za supe i sosove; supe, sosovi; kremovi u prahu; kremovi za kafu; krem dodaci za napitke; nemliječne zamjene za mlijeko.

---

(210) **Ž-2021-8**

(220) 21.01.2021.

(731) Moto klub Vitezovi Crna Gora - Dragoje Rajković, Janka Vukotića br 4, 84300, Berane, ME

(540)



(550) I

(511) Klasa 35: Distribuiranje odjeće i pokrivala za glavu, dukseva, majica, kapa i potkapa, kapuljača, pantalona, privesaka i naljepnica.

Klasa 41: Organizacija motorijada, radionica, treninga i stručnih skupova o motociklizmu, humanitarnim radom i akcija, organizovanje aktivnosti iz oblasti kulture, moto sporta, ekologije, turizma i koncerata i festivala.

---

(210) **Ž-2021-9**

(220) 21.01.2021.

(731) HELLENIC PETROLEUM S.A., 8A Chimarras street, 151 25, Maroussi, Athens, GR

(540)



(550) I

(740) Jasna Jusić, Marka Radovića 37, 1. sprat, stan br. 4., 81000, Podgorica

(511) Klasa 4: Energija (električna -).

Klasa 9: Stanice za punjenje električnih vozila.

Klasa 35: Administrativno upravljanje voznim parkom električnih vozila.

Klasa 37: Punjenje akumulatora vozila; instalacijske usluge u vezi s električnom opremom za punjenje električnih vozila; usluge održavanja u vezi s infrastrukturom za punjenje električnih vozila.

Klasa 39: Iznajmljivanje električnih vozila; distribucija energije.

---

(210) **Ž-2021-12**

(220) 26.01.2021.

(731) OFF-WHITE LLC, 360 Hamilton Ave., #100, NY 10601, White Plains, US

(540)

**OFF**

(550) I

(740) Milena Pejović, Cetinjski put 11, The Capital Plaza IV floor, 81000, Podgorica

(511) Klasa 3: Kozmetika; kozmetički preparati; kozmetički losioni; kozmetička mleka; kozmetički gelovi; kozmetička ulja; kozmetičke kreme; kozmetičke maske; kozmetičke olovke; kozmetičke maramice; kozmetički jastučići; kolonjske vode; parfemi; mirisi za ličnu upotrebu; toaletna voda; sapuni, naime, sapuni za kupanje, kozmetički sapuni, sapuni za brijanje, mirisni sapuni, nemedicinski kozmetički sapuni, dezodorantni sapuni, sapun protiv znojenja; šampon za telo; pilinzi za telo; pilinzi za lice; pilinzi za ruke; nemedicinski preparati za kupanje; preparati protiv znojenja i dezodoransi za ličnu upotrebu; losioni i balzami za posle brijanja; losioni za negu kože; nemedicinski preparati za negu kože, kreme i losioni; nemedicinske hidratantne kreme za kožu, tonici, kreme i serumi; ulja za masažu; kreme za masažu; etarska ulja; osveživači prostora; tamjan; potpuri [mirisi]; preparati za parfunisanje vazduha; raspršivači od trske za osvežavanje vazduha; perle za kupanje; preparati za negu noktiju; lak za nokte i sredstvo za odstranjivanje laka za nokte; šminka; nemedicinski toaletni preparati; preparati za negu kose; preparati za oblikovanje kose; losioni za kosu; lak za kosu; šampon; balzam za kosu; gel za kosu; pena za kosu; balzam za usne; kozmetički losion za sunčanje; ulja i losioni za sunčanje; futrole za ruževe za usne; sprejevi za tijelo; lagani mirisni sprejevi za tijelo; sredstva za beljenje i druge supstance za upotrebu u perionicama; preparati za čišćenje, poliranje, ribanje i abrazivni preparati.

Klasa 8: Ručni alati i sprave kojima se ručno upravlja; pribor za jelo; hladno oružje; briači; baštenski alat [ručni], strigači [ručni instrument], alati za graviranje i utiskivanje [ručni alat]; pribor za manikiranje; turpije za nokte; sprave za poliranje noktiju; spravice za sečenje noktiju; potiskivači zanoktica, pincete, makaze, uvijači za kosu; električni uređaji za ispravljanje kose, električni uređaji za kovrdžanje kose, stoni pribor, naime, noževi, viljuške i kašike.

Klasa 9: Aparati instrumenti naučni, istraživački, navigacioni, geodetski, fotografski, kinematografski, audiovizuelni, optički, za vaganje, merenje, signalizaciju, otkrivanje, testiranje, inspekciju, spasavanje i nastavu; aparati i instrumenti za provođenje, prekid, transformaciju, akumulaciju, regulisanje ili kontrolu distribucije ili upotrebe električne energije; aparati i instrumenti za snimanje, prenošenje, reprodukovanje ili obrađivanje zvuka, slike ili podataka; podaci koji su snimljeni i koji se mogu preuzeti, računarski softver, prazni nosači podataka za digitalno ili analogno snimanje i skladištenje; mehanizmi za aparate koji se pokreću novcem; registar kase, uređaji za



računanje; računari i periferni računarski uređaji; odela za ronjenje, maske za ronjenje, čepovi za uši za ronioce, štikaljke za nos za ronioce i plivače, rukavice za ronioce, aparati za disanje za podvodno plivanje; aparati za gašenje požara; optičarski proizvodi, naime, naočare, naočare za sunce i ramovi za naočare i sočiva i dodaci za naočare, naime, futrole i držači; naočare za plivanje; signalne zviždaljke; sportske pištaljke; zviždeći alarmi; magnetni kompasi; merni kompasi; kompasi za određivanje pravca, zaštitne kacige; zaštitne maske za nemedicinsku upotrebu; maske za zaštitu od prašine; industrijski štitnici za lice; zaštitne radne rukavice; zaštitne naočare; torbe, navlake i futrole za nošenje laptopova; futrole, zaštitne navlake, nosači postolja za upotrebu s ručnim digitalnim uređajima, naime, sa pametnim telefonima, tabletima prenosivim zvučnim i video uređajima za reprodukciju; ručke, postolja i nosači za ručne elektronske uređaje, naime, za pametne telefone, tablete i prenosive zvučne i video uređaje za reprodukciju; futrole za bubice (slušalice); futrole za slušalice, prazne USB memorije.

Klasa 10: Hirurški, medicinski, zubarski i veterinarski aparati i instrumenti; veštački udovi, oči i zubi; ortopedski artikli; hirurški materijali za zašivanje; terapijski i pomoćni uređaji za osobe sa invaliditetom; aparati za masažu; aparati, uređaji i proizvodi za odojčad; aparati, uređaji i proizvodi za seksualne aktivnosti; higijenske maske za medicinsku upotrebu; terapijske maske za lice; modne maske koje se koriste kao higijenske maske za zaštitu od virusnih infekcija; aparati za masažu lica; aparati za masažu očiju; aparati za masažu za ličnu upotrebu; ultrazvučni kozmetički aparati za izvođenje estetskih tretmana kože; štitnici za lice za medicinsku upotrebu; zaštitne rukavice za medicinsku upotrebu.

Klasa 14: Dragoceni metali i njihove legure; nakit, drago i poludrago kamenje; časovničarski i hronometrijski instrumenti; narukvice, ogrlice, privesci, igle [nakit], prstenje, minduše, dugmad za manžetne, satovi, kaiševi za satove; umetnička dela od plemenitog metala; kutije za nakit; kutije za nakit od plemenitog metala; privesci za ključeve; prstenovi za ključeve; zidni satovi.

Klasa 16: Hartija i karton; štampane stvari; knjigovezački materijal; fotografije; kancelarijski materijal i kancelarijski pribor, osim nameštaja; lepкови za kancelarijske i kućne potrebe; materijali za crtanje i materijali za umetnike; kičice; materijali za obuku i nastavu; plastični omotači, folije i kese za umotavanje i pakovanje; štamparska slova, klišei; lični organizatori i planeri; adresari; planeri; albumi za slike; kalendari; kancelarijski pribor; beležnice; pribor za radni sto koji sadrži držače za olovke, držače za spajalice, spajalice, štikaljke, futrole za olovke, gumice, olovke i hemijske olovke; notesi; fascikle; obeleživači za knjige; papir za uvijanje poklona; kartonske kutije za poklone; poklon kartice; razglednice; čestitke; krep papir za pakovanje; papirne torbe za kupovinu; papirne salvete; umetničke reprodukcije; štampane reprodukcije na platnu; litografska umetnička dela; umetnička dela od papira; slike i njihove reprodukcije; poster; nalepnice; lepljive trake za papir ili upotrebu u domaćinstvu; nosači lepljivih traka za papir ili upotrebu u domaćinstvu; papirne trake, lenjiri za tehničko crtanje; lenjiri za crtanje.

Klasa 18: Koža i imitacija kože; životinjske kože; prtljažne i torbe za nošenje; kišobrani i suncobrani; štapovi za hodanje; bičevi, saračka i sedlarska oprema; ogrlice, povoci i odeća za životinje, ručne torbe, cegeri, ženske tašne, klač tašne, kozmetičke torbice koje se prodaju prazne, vrećice za kupovinu za višekratnu upotrebu, novčanici, rančevi, pojasne torbice; aktovke, akten tašne, putne torbe, sanduci, prtljag, višenamenske torbe, dačke torbe, školske torbe za knjige, ruksaci; koferčići za kozmetiku koji se prodaju prazni, prazni kovčežići za kozmetiku, futrole za ključeve, držači za kreditne kartice, kutije za vizit karte, kutije za spise u obliku torbe (aktovke), torbe za teretanu, torbe za plažu, sportske torbe.

Klasa 20: Nameštaj; ogledala; ramovi za slike; kontejneri, ne od metala, za skladištenje ili transport; neobrađena ili polu-obrađena kost, rog, kitova kost ili sedef; školjke; morska pena (sepiolit); ćilibar. jastuci; dekorativni jastuci; kreveti; dušeci; identifikacione narukvice, nemetalne; graničnici za vrata, nemetalni i ne od gume; umetnička dela na mešovitim podlogama sastavljena uglavnom od polimera; umetnička dela od plastike, voska, drveta ili od smole nastale hladnim livenjem; figurine od plastike, voska, drveta ili od smole nastale hladnim livenjem.

Klasa 21: Kućne ili kuhinjske sprave i posude; posuđe i pribor za jelo, osim viljušaka, noževa i kašika; češljevi i sunđeri; četke, izuzev kičica; materijali za pravljenje četki; pribor za čišćenje; neprerađeno ili polupreradeno staklo, neobrađeno ili poluobrađeno staklo, osim građevinskog stakla; staklarija, porcelan i grnčarija; pribor za pečenje; poslužavnici s nožicama (stolići); plehovi za torte; stalci za torte; setovi posuda za čuvanje začina, šećera, brašna, kafe; cediljke za citrusne; pribor za posluživanje, sekači za keks; limovi za kolače; posuđe, naime, duboki tiganji, tiganji, lonci, posude za kuvanje na paru, vok tiganji; posuđe; tanjiri; činije; držači za tečni sapun; posude za piće; šolje za piće; čaše za piće; šolje i tacne; posude za poširanje jaja; presa za beli luk; renda za upotrebu u domaćinstvu; kućni pribor, naime, hvataljke za upotrebu u kuhinji, špatule za kuhinju, cediljke, špatula za prevrtanje, viljuške za kuvanje; viljuške za posluživanje, kašike za kuvanje, kašike za serviranje, držači za noževe, žice za mućenje, rende, neelektrične mešalice, kašike, cediljke, sita, đevđiri; kutlače, kuhinjske daske za seckanje i oklagije; poslužavnici za jelo; držači za salvete za upotrebu u domaćinstvu; držači za papirne ubruse za upotrebu u domaćinstvu; bokali; mlinovi za so i biber; slanici i bibernici; tacne za serviranje; posude za serviranje; poslužavnici za serviranje; držači za sapun; posude za sapun; stalci za začine; čajnici; nemetalni poslužavnici za upotrebu u domaćinstvu; vaze; svećnjaci; rukavice za renu; pribor za kupatilo, naime, držači za čaše; otvarači za flaše; boce za parfeme koje se prodaju prazne; kutije za pilule za ličnu upotrebu; prstenovi za salvete; boce za vodu koje se prodaju prazne; četkice za zube; četke za kosu; umetnička dela od stakla, porcelana, terakote ili keramike; plastični podmetači; podmetači od vinila; slamke za piće; kutije prilagođene za kozmetički pribor kao što su četke za šminku i aplikatori u obliku štapića za nanošenje šminke; električni pribori za skidanje šminke; neelektrični pribori za skidanje šminke; aplikatori za kozmetiku; aplikatori za šminku; opremljene kozmetičke torbice; toaletni nesereseri, naime, opremljeni kovčežići za kozmetiku; pudrijere, kutije koje se prodaju prazne; sunđeri za šminkanje; kozmetički sunđeri, kozmetičke četke; četke za piling; držači za sredstva za dezinfekciju ruku; kutije za sredstva za dezinfekciju ruku; raspršivači etarskih ulja, osim trščanih raspršivača, električni i neelektrični.

Klasa 24: Prekrivači za krevet sa karnerima, zamena za jastuk, jastučnice, ukrasna ćebad, pokrivači za dušeke, peškiri, peškiri za kupatila, peškiri za plažu, krpe za sudove; peškirići za lice; krpe za pranje; prekrivači za stolove, zavese, maramice, tapiserije, pamučna tkanina, mebl štofovi za tapaciranje nameštaja i tkanina za zavese, dekorativne reljefne tkanine; stoni podmetači, ćebići za ljubimce, fular (tkanina).

Klasa 25: Odeća, obuća, pokrivala za glavu; gornji i donji delovi odeće; odevni predmeti koji se nose oko vrata; kaiševi; kupaći kostimi; donji veš; korseti; platnene maske za lice; platnena maska u vidu pokrivala za glavu; platnena maska u obliku jakne; dukserice; džemperi; prsluci; kaputi; blejzeri; odela; pantalone; farmerke; šorts; bluze, košulje; haljine; suknje; marame; šalovi; kratke čarape; ženske čarape; tregeri; rukavice; bade mantili; maske za spavanje; manžetne košulja; znojnice; trake za glavu; marame za glavu; tanke svilene marame; bandana marame; kape; šeširi; viziri.

Klasa 27: Tepisi, asure, prostirke i otirači, linoleum i drugi materijali za pokrivanje podova; prekrivači za zidove, netekstilni; prostirke za kupatila; prostirke za jogu; otirači za vrata; tekstilne prostirke za podove za upotrebu u domaćinstvu; tapete; tvrdi materijali za pokrivanje podova; pokrivači za zidove od vinila ili plastike.

Klasa 34: Duvan i zamena za duvan; cigarete i cigare; elektronske cigarete i oralni vaporizatori za pušače; artikli za pušače; šibice; pepeljare, upaljači za cigarete, upaljači za cigare, vaporizatori za bezdimne cigarete, držači cigara, filteri za cigarete, lule, sekači za cigare, kutije za burmut, kese za duvan, tabakere i različiti pribor za lule, naime, čistači za duvanske lule i upijajući papir za duvanske lule.

Klasa 35: Oglašavanje; vođenje, organizovanje upravljanje poslovanjem; kancelarijski poslovi, usluge maloprodaje; usluge internet prodavnice.

---

(210) **Ž-2021-13**

(220) 26.01.2021.

(731) OFF-WHITE LLC, 360 Hamilton Ave., #100, NY 10601, White Plains, US

(540)



(550) I

(740) Milena Pejović, Cetinjski put 11, The Capital Plaza IV floor, 81000, Podgorica

(511) Klasa 3: Kozmetika; kozmetički preparati; kozmetički losioni; kozmetička mleka; kozmetički gelovi; kozmetička ulja; kozmetičke kreme; kozmetičke maske; kozmetičke olovke; kozmetičke maramice; kozmetički jastučići; kolonjske vode; parfemi; mirisi za ličnu upotrebu; toaletna voda; sapuni, naime, sapuni za kupanje, kozmetički sapuni, sapuni za brijanje, mirisni sapuni, nemedicinski kozmetički sapuni, dezodorantni sapuni, sapun protiv znojenja; šampon za telo; pilinzi za telo; pilinzi za lice; pilinzi za ruke; nemedicinski preparati za kupanje; preparati protiv znojenja i dezodoransi za ličnu upotrebu; losioni i balzami za posle brijanja; losioni za negu kože; nemedicinski preparati za negu kože, kreme i losioni; nemedicinske hidratantne kreme za kožu, tonici, kreme i serumi; ulja za masažu; kreme za masažu; etarska ulja; osveživači prostora; tamjan; potpuri [mirisi]; preparati za parfisanje vazduha; raspršivači od trske za osvežavanje vazduha; perle za kupanje; preparati za negu noktiju; lak za nokte i sredstvo za odstranjivanje laka za nokte; šminka; nemedicinski toaletni preparati; preparati za negu kose; preparati za oblikovanje kose; losioni za kosu; lak za kosu; šampon; balzam za kosu; gel za kosu; pena za kosu; balzam za usne; kozmetički losion za sunčanje; ulja i losioni za sunčanje; futrole za ruževe za usne; sprejevi za tijelo; lagani mirisni sprejevi za tijelo; sredstva za beljenje i druge supstance za upotrebu u perionicama; preparati za čišćenje, poliranje, ribanje i abrazivni preparati.

Klasa 4: Industrijska ulja i masti, vosak; maziva; jedinjenja za skupljanje, vlaženje i vezivanje prašine; goriva i materije za osvetljavanje; sveće i fitilji za osvetljavanje.

Klasa 5: Farmaceutski, medicinski i veterinarski preparati; sanitarni preparati za upotrebu u medicini; dijetetska hrana i supstance prilagođene za upotrebu u medicini ili veterinarsku upotrebu, hrana za bebe; dijetetski dodaci (dodaci ishrani) za ljude i životinje; flasteri, materijali za zavijanje; materijali za plombiranje zuba; medicinski preparati za negu kože; medicinski sapuni; preparati za dezinfekciju ruku; sredstvo za dezinfekciju u spreju za ličnu upotrebu; plastične rukavice i krema za ruke za zaštitu od mikroba; kompleti koji se sastoje uglavnom od gela za dezinfekciju i maramica za dezinfekciju uključujući takođe i higijenske maske, plastične rukavice i kremu za ruke koji se koriste za zaštitu od mikroba.

Klasa 8: Ručni alati i sprave kojima se ručno upravlja; pribor za jelo; hladno oružje; briači; baštenski alat [ručni], strigači [ručni instrument], alati za graviranje i utiskivanje [ručni alat]; pribor za manikiranje; turpije za nokte; sprave za poliranje noktiju; spravice za sečenje noktiju; potiskivači zanoktica, pincete, makaze, uvijači za kosu; električni uređaji za ispravljanje kose, električni uređaji za kovrdžanje kose, stoni pribor, naime, noževi, viljuške i kašike.

Klasa 9: Aparati instrumenti naučni, istraživački, navigacioni, geodetski, fotografski, kinematografski, audiovizuelni, optički, za vaganje, merenje, signalizaciju, otkrivanje, testiranje, inspekciju, spasavanje i nastavu; aparati i instrumenti za provođenje, prekid, transformaciju, akumulaciju, regulisanje ili kontrolu distribucije ili upotrebe električne energije; aparati i instrumenti za snimanje, prenošenje, reprodukovanje ili obrađivanje zvuka, slike ili podataka; podaci koji su snimljeni i koji se mogu preuzeti, računarski softver, prazni nosači podataka za digitalno ili analogno snimanje i skladištenje; mehanizmi za aparate koji se pokreću novcem; registar kase, uređaji za računanje; računari i periferni računarski uređaji; odela za ronjenje, maske za ronjenje, čepovi za uši za ronioce, štipaljke za nos za ronioce i plivače, rukavice za ronioce, aparati za disanje za podvodno plivanje; aparati za gašenje požara; optičarski proizvodi, naime, naočare, naočare za sunce i ramovi za naočare i sočiva i dodaci za naočare, naime, futrole i držači; naočare za plivanje; signalne zviždaljke; sportske pištaljke; zviždeći alarmi; magnetni kompasi; merni kompasi; kompasi za određivanje pravca, zaštitne kacige; zaštitne maske za nemedicinsku upotrebu; maske za zaštitu od prašine; industrijski štitnici za lice; zaštitne radne rukavice; zaštitne naočare; torbe, navlake i futrole za nošenje laptopova; futrole, zaštitne navlake, nosači postolja za upotrebu s ručnim digitalnim uređajima, naime, sa pametnim telefonima, tabletima prenosivim zvučnim i video uređajima za reprodukciju; ručke, postolja i nosači za ručne elektronske uređaje, naime, za pametne telefone, tablete i prenosive zvučne i video uređaje za reprodukciju; futrole za bubice (slušalice); futrole za slušalice, prazne USB memorije.

Klasa 10: Hirurški, medicinski, zubarski i veterinarski aparati i instrumenti; veštački udovi, oči i zubi; ortopedski artikli; hirurški materijali za zašivanje; terapijski i pomoćni uređaji za osobe sa invaliditetom; aparati za masažu; aparati, uređaji i proizvodi za odojčad; aparati, uređaji i proizvodi za seksualne aktivnosti; higijenske maske za medicinsku upotrebu; terapijske maske za lice; modne maske koje se koriste kao higijenske maske za zaštitu od virusnih infekcija; aparati za masažu lica; aparati za masažu očiju; aparati za masažu za ličnu upotrebu; ultrazvučni kozmetički aparati za izvođenje estetskih tretmana kože; štitnici za lice za medicinsku upotrebu; zaštitne rukavice za medicinsku upotrebu.

Klasa 14: Dragoceni metali i njihove legure; nakit, drago i poludrago kamenje; časovničarski i hronometrijski instrumenti; narukvice, ogrlice, privesci, igle [nakit], prstenje, minduše, dugmad za manžetne, satovi, kaiševi za satove; umetnička dela od plemenitog metala; kutije za nakit; kutije za nakit od plemenitog metala; privesci za ključeve; prstenovi za ključeve; zidni satovi.

Klasa 16: Hartija i karton; štampane stvari; knjigovezački materijal; fotografije; kancelarijski

materijal i kancelarijski pribor, osim nameštaja; lepkovi za kancelarijske i kućne potrebe; materijali za crtanje i materijali za umetnike; kičice; materijali za obuku i nastavu; plastični omotači, folije i kese za umotavanje i pakovanje; štamparska slova, klišei; lični organizatori i planeri; adresari; planeri; albumi za slike; kalendari; kancelarijski pribor; beležnice; pribor za radni sto koji sadrži držače za olovke, držače za spjalice, spjalice, štikaljke, futrole za olovke, gumice, olovke i hemijske olovke; notesi; fascikle; obeleživači za knjige; papir za uvijanje poklona; kartonske kutije za poklone; poklon kartice; razglednice; čestitke; krep papir za pakovanje; papirne torbe za kupovinu; papirne salвете; umetničke reprodukcije; štampane reprodukcije na platnu; litografska umetnička dela; umetnička dela od papira; slike i njihove reprodukcije; poster; nalepnice; lepljive trake za papir ili upotrebu u domaćinstvu; nosači lepljivih traka za papir ili upotrebu u domaćinstvu; papirne trake, lenjiri za tehničko crtanje; lenjiri za crtanje.

Klasa 18: Koža i imitacija kože; životinjske kože; prtljažne i torbe za nošenje; kišobrani i suncobrani; štapovi za hodanje; bičevi, saračka i sedlarska oprema; ogrlice, povoci i odeća za životinje, ručne torbe, cegeri, ženske tašne, klač tašne, kozmetičke torbice koje se prodaju prazne, vrećice za kupovinu za višekratnu upotrebu, novčanici, rančevi, pojasne torbice; aktovke, akten tašne, putne torbe, sanduci, prtljag, višenamenske torbe, đačke torbe, školske torbe za knjige, ruksaci; koferčići za kozmetiku koji se prodaju prazni, prazni kovčežići za kozmetiku, futrole za ključeve, držači za kreditne kartice, kutije za vizit karte, kutije za spise u obliku torbe (aktovke), torbe za teretanu, torbe za plažu, sportske torbe.

Klasa 20: Nameštaj; ogledala; ramovi za slike; kontejneri, ne od metala, za skladištenje ili transport; neobrađena ili polu-obrađena kost, rog, kitova kost ili sedef; školjke; morska pena (sepiolit); ćilibar. jastuci; dekorativni jastuci; kreveti; dušeci; identifikacione narukvice, nemetalne; graničnici za vrata, nemetalni i ne od gume; umetnička dela na mešovitim podlogama sastavljena uglavnom od polimera; umetnička dela od plastike, voska, drveta ili od smole nastale hladnim livenjem; figurine od plastike, voska, drveta ili od smole nastale hladnim livenjem.

Klasa 21: Kućne ili kuhinjske sprave i posude; posuđe i pribor za jelo, osim viljušaka, noževa i kašika; češljevi i sunđer; četke, izuzev kičica; materijali za pravljenje četki; pribor za čišćenje; neprerađeno ili poluprerađeno staklo, neobrađeno ili poluobrađeno staklo, osim građevinskog stakla; staklarija, porcelan i grnčarija; pribor za pečenje; poslužavnici s nožicama (stolići); plehovi za torte; stalci za torte; setovi posuda za čuvanje začina, šećera, brašna, kafe; cediljke za citruse; pribor za posluživanje, sekači za keks; limovi za kolače; posuđe, naime, duboki tiganji, tiganji, lonci, posude za kuvanje na paru, vok tiganji; posuđe; tanjiri; činije; držači za tečni sapun; posude za piće; šolje za piće; čaše za piće; šolje i tacne; posude za poširanje jaja; presa za beli luk; renda za upotrebu u domaćinstvu; kućni pribor, naime, hvataljke za upotrebu u kuhinji, špatule za kuhinju, cediljke, špatula za prevrtanje, viljuške za kuvanje; viljuške za posluživanje, kašike za kuvanje, kašike za serviranje, držači za noževe, žice za mućenje, rende, neelektrične mešalice, kašike, cediljke, sita, đevđiri; kutlače, kuhinjske daske za seckanje i oklagije; poslužavnici za jelo; držači za salвете za upotrebu u domaćinstvu; držači za papirne ubruse za upotrebu u domaćinstvu; bokali; mlinovi za so i biber; slanici i bibernici; tacne za serviranje; posude za serviranje; poslužavnici za serviranje; držači za sapun; posude za sapun; stalci za začine; čajnici; nemetalni poslužavnici za upotrebu u domaćinstvu; vaze; svećnjaci; rukavice za rernu; pribor za kupatilo, naime, držači za čaše; otvarači za flaše; boce za parfeme koje se prodaju prazne; kutije za pilule za ličnu upotrebu; prstenovi za salвете; boce za vodu koje se prodaju prazne; četkice za zube; četke za kosu; umetnička dela od stakla, porcelana, terakote ili keramike; plastični podmetači; podmetači od vinila; slamke za piće; kutije prilagođene za

kozmetički pribor kao što su četke za šminku i aplikatori u obliku štapića za nanošenje šminke; električni pribori za skidanje šminke; neelektrični pribori za skidanje šminke; aplikatori za kozmetiku; aplikatori za šminku; opremljene kozmetičke torbice; toaletni nesereseri, naime, opremljeni kovčežići za kozmetiku; pudrijere, kutije koje se prodaju prazne; sunderi za šminkanje; kozmetički sunderi, kozmetičke četke; četke za piling; držači za sredstva za dezinfekciju ruku; kutije za sredstva za dezinfekciju ruku; raspršivači etarskih ulja, osim trščanih raspršivača, električni i neelektrični.

Klasa 24: Prekrivači za krevet sa karnerima, zamena za jastuk, jastučnice, ukrasna ćebad, pokrivači za dušeke, peškiri, peškiri za kupatila, peškiri za plažu, krpe za sudove; peškirići za lice; krpe za pranje; prekrivači za stolove, zavese, maramice, tapiserije, pamučna tkanina, mebl štofovi za tapaciranje nameštaja i tkanina za zavese, dekorativne reljefne tkanine; stoni podmetači, ćebići za ljubimce, fular (tkanina).

Klasa 25: Odeća, obuća, pokrivala za glavu; gornji i donji delovi odeće; odevni predmeti koji se nose oko vrata; kaiševi; kupaći kostimi; donji veš; korseti; platnene maske za lice; platnena maska u vidu pokrivala za glavu; platnena maska u obliku jakne; dukserice; džemperi; prsluci; kaputi; blejzeri; odela; pantalone; farmerke; šorts; bluze, košulje; haljine; suknje; marame; šalovi; kratke čarape; ženske čarape; tregeri; rukavice; bade mantili; maske za spavanje; manžetne košulja; znojnice; trake za glavu; marame za glavu; tanke svilene marame; bandana marame; kape; šeširi; viziri.

Klasa 27: Tepisi, asure, prostirke i otirači, linoleum i drugi materijali za pokrivanje podova; prekrivači za zidove, netekstilni; prostirke za kupatila; prostirke za jogu; otirači za vrata; tekstilne prostirke za podove za upotrebu u domaćinstvu; tapete; tvrdi materijali za pokrivanje podova; pokrivači za zidove od vinila ili plastike.

Klasa 34: Duvan i zamena za duvan; cigarete i cigare; elektronske cigarete i oralni vaporizatori za pušače; artikli za pušače; šibice; pepeljare, upaljači za cigarete, upaljači za cigare, vaporizatori za bezdimne cigarete, držači cigara, filteri za cigarete, lule, sekači za cigare, kutije za burmut, kese za duvan, tabakere i različiti pribor za lule, naime, čistači za duvanske lule i upijajući papir za duvanske lule.

Klasa 35: Oglašavanje; vođenje, organizovanje upravljanje poslovanjem; kancelarijski poslovi, usluge maloprodaje; usluge internet prodavnice.

---

(210) **Ž-2021-14**

(220) 26.01.2021.

(731) OFF-WHITE LLC, 360 Hamilton Ave., #100, NY 10601, White Plains, US

(540)



(550) I

(740) Milena Pejović, Cetinjski put 11, The Capital Plaza IV floor, 81000, Podgorica

(511) Klasa 8: Ručni alati i sprave kojima se ručno upravlja; pribor za jelo; hladno oružje; brijajući; baštenski alat [ručni], strigači [ručni instrument], alati za graviranje i utiskivanje [ručni

alat]; pribor za manikiranje; turpije za nokte; sprave za poliranje noktiju; spravice za sečenje noktiju; potiskivači zanoktica, pincete, makaze, uvijači za kosu; električni uređaji za ispravljanje kose, električni uređaji za kovrdžanje kose, stoni pribor, naime, noževi, viljuške i kašike.

Klasa 9: Aparati instrumenti naučni, istraživački, navigacioni, geodetski, fotografski, kinematografski, audiovizuelni, optički, za vaganje, merenje, signalizaciju, otkrivanje, testiranje, inspekciju, spasavanje i nastavu; aparati i instrumenti za provođenje, prekid, transformaciju, akumulaciju, regulisanje ili kontrolu distribucije ili upotrebe električne energije; aparati i instrumenti za snimanje, prenošenje, reprodukovanje ili obrađivanje zvuka, slike ili podataka; podaci koji su snimljeni i koji se mogu preuzeti, računarski softver, prazni nosači podataka za digitalno ili analogno snimanje i skladištenje; mehanizmi za aparate koji se pokreću novcem; registar kase, uređaji za računanje; računari i periferni računarski uređaji; odela za ronjenje, maske za ronjenje, čepovi za uši za ronioce, štipaljke za nos za ronioce i plivače, rukavice za ronioce, aparati za disanje za podvodno plivanje; aparati za gašenje požara; optičarski proizvodi, naime, naočare, naočare za sunce i ramovi za naočare i sočiva i dodaci za naočare, naime, futrole i držači; naočare za plivanje; signalne zviždaljke; sportske pištaljke; zviždeći alarmi; magnetni kompasi; merni kompasi; kompasi za određivanje pravca, zaštitne kacige; zaštitne maske za nemedicinsku upotrebu; maske za zaštitu od prašine; industrijski štitnici za lice; zaštitne radne rukavice; zaštitne naočare; torbe, navlake i futrole za nošenje laptopova; futrole, zaštitne navlake, nosači postolja za upotrebu s ručnim digitalnim uređajima, naime, sa pametnim telefonima, tabletima prenosivim zvučnim i video uređajima za reprodukciju; ručke, postolja i nosači za ručne elektronske uređaje, naime, za pametne telefone, tablete i prenosive zvučne i video uređaje za reprodukciju; futrole za bubice (slušalice); futrole za slušalice, prazne USB memorije.

Klasa 10: Hirurški, medicinski, zubarski i veterinarski aparati i instrumenti; veštački udovi, oči i zubi; ortopedski artikli; hirurški materijali za zašivanje; terapijski i pomoćni uređaji za osobe sa invaliditetom; aparati za masažu; aparati, uređaji i proizvodi za odojčad; aparati, uređaji i proizvodi za seksualne aktivnosti; higijenske maske za medicinsku upotrebu; terapijske maske za lice; modne maske koje se koriste kao higijenske maske za zaštitu od virusnih infekcija; aparati za masažu lica; aparati za masažu očiju; aparati za masažu za ličnu upotrebu; ultrazvučni kozmetički aparati za izvođenje estetskih tretmana kože; štitnici za lice za medicinsku upotrebu; zaštitne rukavice za medicinsku upotrebu.

Klasa 14: Dragoceni metali i njihove legure; nakit, drago i poludrago kamenje; časovničarski i hronometrijski instrumenti; narukvice, ogrlice, privesci, igle [nakit], prstenje, minduše, dugmad za manžetne, satovi, kaiševi za satove; umetnička dela od plemenitog metala; kutije za nakit; kutije za nakit od plemenitog metala; privesci za ključeve; prstenovi za ključeve; zidni satovi.

Klasa 16: Hartija i karton; štampane stvari; knjigovezački materijal; fotografije; kancelarijski materijal i kancelarijski pribor, osim nameštaja; lepkovi za kancelarijske i kućne potrebe; materijali za crtanje i materijali za umetnike; kičice; materijali za obuku i nastavu; plastični omotači, folije i kese za umotavanje i pakovanje; stamparska slova, klišei; lični organizatori i planeri; adresari; planeri; albumi za slike; kalendari; kancelarijski pribor; beležnice; pribor za radni sto koji sadrži držače za olovke, držače za spajalice, spajalice, štipaljke, futrole za olovke, gumice, olovke i hemijske olovke; notesi; fascikle; obeleživači za knjige; papir za uvijanje poklona; kartonske kutije za poklone; poklon kartice; razglednice; čestitke; krep papir za pakovanje; papirne torbe za kupovinu; papirne salvete; umetničke reprodukcije; štampane reprodukcije na platnu; litografska umetnička dela; umetnička dela od papira; slike i njihove reprodukcije; poster; nalepnice; lepljive trake za papir ili upotrebu u domaćinstvu;

nosači lepljivih traka za papir ili upotrebu u domaćinstvu; papirne trake, lenjiri za tehničko crtanje; lenjiri za crtanje.

Klasa 18: Koža i imitacija kože; životinjske kože; prtljažne i torbe za nošenje; kišobrani i suncobrani; štapovi za hodanje; bičevi, saračka i sedlarska oprema; ogrlice, povoci i odeća za životinje, ručne torbe, cegeri, ženske tašne, klač tašne, kozmetičke torbice koje se prodaju prazne, vrećice za kupovinu za višekratnu upotrebu, novčanici, rančevi, pojasne torbice; aktovke, akten tašne, putne torbe, sanduci, prtljag, višenamenske torbe, đačke torbe, školske torbe za knjige, ruksaci; koferčići za kozmetiku koji se prodaju prazni, prazni kovčežići za kozmetiku, futrole za ključeve, držači za kreditne kartice, kutije za vizit karte, kutije za spise u obliku torbe (aktovke), torbe za teretanu, torbe za plažu, sportske torbe.

Klasa 20: Nameštaj; ogledala; ramovi za slike; kontejneri, ne od metala, za skladištenje ili transport; neobrađena ili polu-obrađena kost, rog, kitova kost ili sedef; školjke; morska pena (sepiolit); ćilibar. jastuci; dekorativni jastuci; kreveti; dušeci; identifikacione narukvice, nemetalne; graničnici za vrata, nemetalni i ne od gume; umetnička dela na mešovitim podlogama sastavljena uglavnom od polimera; umetnička dela od plastike, voska, drveta ili od smole nastale hladnim livenjem; figurine od plastike, voska, drveta ili od smole nastale hladnim livenjem.

Klasa 21: Kućne ili kuhinjske sprave i posude; posuđe i pribor za jelo, osim viljušaka, noževa i kašika; češljevi i sunđeri; četke, izuzev kičica; materijali za pravljenje četki; pribor za čišćenje; neprerađeno ili poluprerađeno staklo, neobrađeno ili poluobrađeno staklo, osim građevinskog stakla; staklarija, porcelan i grnčarija; pribor za pečenje; poslužavnici s nožicama (stolići); plehovi za torte; stalci za torte; setovi posuda za čuvanje začina, šećera, brašna, kafe; cediljke za citruse; pribor za posluživanje, sekači za keks; limovi za kolače; posuđe, naime, duboki tiganji, tiganji, lonci, posude za kuvanje na paru, vok tiganji; posuđe; tanjiri; činije; držači za tečni sapun; posude za piće; šolje za piće; čaše za piće; šolje i tacne; posude za poširanje jaja; presa za beli luk; renda za upotrebu u domaćinstvu; kućni pribor, naime, hvataljke za upotrebu u kuhinji, špatule za kuhinju, cediljke, špatula za prevrtanje, viljuške za kuvanje; viljuške za posluživanje, kašike za kuvanje, kašike za serviranje, držači za noževe, žice za mućenje, rende, neelektrične mešalice, kašike, cediljke, sita, đevđiri; kutlače, kuhinjske daske za seckanje i oklagije; poslužavnici za jelo; držači za salvete za upotrebu u domaćinstvu; držači za papirne ubruse za upotrebu u domaćinstvu; bokali; mlinovi za so i biber; slanici i bibernici; tacne za serviranje; posude za serviranje; poslužavnici za serviranje; držači za sapun; posude za sapun; stalci za začine; čajnici; nemetalni poslužavnici za upotrebu u domaćinstvu; vaze; svećnjaci; rukavice za rernu; pribor za kupatilo, naime, držači za čaše; otvarači za flaše; boce za parfeme koje se prodaju prazne; kutije za pilule za ličnu upotrebu; prstenovi za salvete; boce za vodu koje se prodaju prazne; četkice za zube; četke za kosu; umetnička dela od stakla, porcelana, terakote ili keramike; plastični podmetači; podmetači od vinila; slamke za piće; kutije prilagođene za kozmetički pribor kao što su četke za šminku i aplikatori u obliku štapića za nanošenje šminke; električni pribori za skidanje šminke; neelektrični pribori za skidanje šminke; aplikatori za kozmetiku; aplikatori za šminku; opremljene kozmetičke torbice; toaletni neseseri, naime, opremljeni kovčežići za kozmetiku; pudrijere, kutije koje se prodaju prazne; sunđeri za šminkanje; kozmetički sunđeri, kozmetičke četke; četke za piling; držači za sredstva za dezinfekciju ruku; kutije za sredstva za dezinfekciju ruku; raspršivači etarskih ulja, osim trščanih raspršivača, električni i neelektrični.

Klasa 24: Prekrivači za krevet sa karnerima, zamena za jastuk, jastučnice, ukrasna ćebad, pokrivači za dušeke, peškiri, peškiri za kupatila, peškiri za plažu, krpe za sudove; peškirići za lice; krpe za pranje; prekrivači za stolove, zavese, maramice, tapiserije, pamučna



tkanina, mebl štofovi za tapaciranje nameštaja i tkanina za zavese, dekorativne reljefne tkanine; stoni podmetači, čebići za ljubimce, fular (tkanina).

Klasa 25: Odeća, obuća, pokrivala za glavu; gornji i donji delovi odeće; odevni predmeti koji se nose oko vrata; kaiševi; kupaći kostimi; donji veš; korseti; platnene maske za lice; platnena maska u vidu pokrivala za glavu; platnena maska u obliku jakne; dukserice; džemperi; prsluci; kaputi; blejzeri; odela; pantalone; farmerke; šorts; bluze, košulje; haljine; suknje; marama; šalovi; kratke čarape; ženske čarape; tregeri; rukavice; bade mantili; maske za spavanje; manžetne košulja; znojnice; trake za glavu; marama za glavu; tanke svilene marama; bandana marama; kape; šeširi; viziri.

Klasa 27: Tepisi, asure, prostirke i otirači, linoleum i drugi materijali za pokrivanje podova; prekrivači za zidove, netekstilni; prostirke za kupatila; prostirke za jogu; otirači za vrata; tekstilne prostirke za podove za upotrebu u domaćinstvu; tapete; tvrdi materijali za pokrivanje podova; pokrivači za zidove od vinila ili plastike.

Klasa 34: Duvan i zamena za duvan; cigarete i cigare; elektronske cigarete i oralni vaporizatori za pušače; artikli za pušače; šibice; pepeljare, upaljači za cigarete, upaljači za cigare, vaporizatori za bezdimne cigarete, držači cigara, filteri za cigarete, lule, sekači za cigare, kutije za burmut, kese za duvan, tabakere i različiti pribor za lule, naime, čistači za duvanske lule i upijajući papir za duvanske lule.

---

(210) **Ž-2021-15**

(220) 27.01.2021.

(731) Merck Sharp & Dohme Corp., One Merck Drive, 08889, Whitehouse Station, New Jersey, US

(540)

## VAXNEUVANCE

(550) I

(740) Jasna Jusić, Marka Radovića 37, 1. sprat, stan br. 4., 81000, Podgorica

(511) Klasa 5: Preparati za vakcine.

---

(210) **Ž-2021-16**

(220) 27.01.2021.

(731) Merck Sharp & Dohme Corp., One Merck Drive, 08889, Whitehouse Station, New Jersey, US

(540)

## VAXPRUMI

(550) I

(740) Jasna Jusić, Marka Radovića 37, 1. sprat, stan br. 4., 81000, Podgorica

(511) Klasa 5: Preparati za vakcine.

(210) **Ž-2021-17**

(220) 28.01.2021.

(731) Ramada International, Inc., 22 Sylvan Way, 07054, Parsippany, New Jersey, US

(540)

## RAMADA RESIDENCES

(550) I

(740) Jasna Jusić, Marka Radovića 37, 1. sprat, stan br. 4., 81000, Podgorica

(511) Klasa 36: Usluge nekretnina, naime iznajmljivanje, posredovanje i upravljanje apartmana, apartmani sa uslugom i kondominijumima; davanje u zakup komercijalnih nekretnina.

Klasa 43: Usluge kondotela, rizort hotela i hotelske usluge; pravljenje rezervacija za privremeni smještaj za druge.

---

(210) **Ž-2021-18**

(220) 28.01.2021.

(731) Tropicana Products, Inc., 1001 13th Avenue East, 34208, Bradenton, Florida, US

(540)



(550) I

(740) Jasna Jusić, Marka Radovića 37, 1. sprat, stan br. 4., 81000, Podgorica

(511) Klasa 32: Voćni sokovi i pića od voća.

---

(210) **Ž-2021-19**

(220) 28.01.2021.

(731) Tropicana Products, Inc., 1001 13th Avenue East, 34208, Bradenton, Florida, US

(540)



(550) I

(740) Jasna Jusić, Marka Radovića 37, 1. sprat, stan br. 4., 81000, Podgorica

(511) Klasa 32: Voćni sokovi i pića od voća.

---

(210) **Ž-2021-20**

(220) 29.01.2021.

(731) TOYOTA JIDOSHA KABUSHIKI KAISHA (also trading as TOYOTA MOTOR CORPORATION), 1, Toyota-cho, Toyota-shi, Aichi-ken, JP

(540)

## RAV4 ADVENTURE

(550) I

(740) Jasna Jusić, Marka Radovića 37, 1. sprat, stan br. 4., 81000, Podgorica

(511) Klasa 12: Automobili i njihovi strukturalni djelovi.

---

(210) **Ž-2021-21**

(220) 02.02.2021.

(731) ERSTE BANK AD Podgorica, Aresenija Boljevića 2a, 81000, Podgorica, ME

(540)



(550) I

(511) Klasa 35: Agencije za komercijalne oglase; agencije za uvoz-izvoz; analiza proizvodne cijene; aukcionarstvo (prodaja na aukciji); automati (iznajmljivanje automata); cijene (poređenje cijena); daktilografske usluge; ekonomska predviđanja [prognoze]; fakturisanje; fotokopiranje (usluge fotokopiranja); hoteli (administrativno upravljanje hotelima); informacije (kancelarije za komercijalne informacije); informacije (poslovne informacije); informatičke kartoteke (vođenje informatičkih kartoteka); informatički podaci

(pretraživanje podataka u informatičkoj kartoteci za treće lice); isporuka [distribucija] uzoraka; isporuka reklamnih materijala [letaka, prospekata, uzoraka]; isporuka reklamnih oglasa; isprave (umnožavanje isprava); istraživanja za poslove; istraživanje javnog mišljenja; istraživanje za poslove; izlozi (uređivanje izloga); izložbe (organizovanje izložbi) u komercijalne ili reklamne svrhe; iznajmljivanje automata za prodaju sitne robe; iznajmljivanje fotokopirnih uređaja; iznajmljivanje kancelarijskih mašina i aparata; iznajmljivanje reklamnih prostora; iznajmljivanje reklamnog materijala; iznajmljivanje vremena za reklamiranje na svim komunikacionim sredstvima; izvodi iz računa (davanje izvoda sa računa); izvoz-uvoz (agencije za izvoz-uvoz); javno mnijenje (istraživanje javnog mnjenja) [anketiranje]; javnost (odnosi s javnošću) [propaganda]; kancelarije za reklamiranje; kancelarije za zapošljavanje; kancelarijski mašine i aparati (iznajmljivanje kancelarijskih mašina i aparata) \*; kartoteka (prikupljanje podataka u središnju kartoteku); kartoteka (sistemizovanje podataka za središnju kartoteku); knjige (vođenje knjiga); komercijalna administracija u vezi licenci proizvoda i usluga trećih lica; komercijalna ili industrijska preduzeća (pomoć u vođenju komercijalnih ili industrijskih preduzeća); konsultacije u vezi vođenje poslova; lociranje teretnih vagona pomoću kompjutera; manekeni (usluge manekena) za reklamiranje ili podsticaj prodaje; marketing; modne revije za promotivne svrhe (organizovanje); nabava za treće (usluge nabave za treće) [kupovina proizvoda i usluga za druga preduzeća]; nabava za treće osobe (usluge kupovine proizvoda i usluga za druga preduzeća); narudžbine (administrativna obrada narudžbina za kupovinu); novine (usluge pretplate novina) za treće osobe; objavljivanje reklamnih tekstova; odabir osoblja psihotehničkim postupkom; odnosi s javnošću [propaganda]; oglašavanje [reklamiranje]; oglašavanje putem pošte; organizovanje izložbi u komercijalne ili reklamne svrhe; organizovanje poslova (savjetovanje o organiziranju poslova); osoblje (biranje osoblja psihotehničkim postupkom); osoblje (savjetovanje o osoblju); osoblje (zapošljavanje osoblja); plakatiranje [oglašavanje]; platni listovi (izrada platnih listova); podsticaj prodaje za treće osobe; podugovaranje (usluge podugovaranja) [komercijalna pomoć]; pomoć u upravljanju industrijskim ili trgovačkim preduzećima; pomoć u vođenju poslova; porezne prijave (izrada poreznih prijava); poslovi (istraživanja za poslove); poslovi (istraživanje za poslove); poslovi (konsultacije za vođenja poslova); poslovi (obavještenja o poslovima); poslovi (pomoć u vođenju poslova); poslovi (savjetovanje o organizaciji i vođenju poslova); poslovi (vještačenje poslova) [ekspertize]; poslovne informacije; potrošači (pružanje komercijalnih savjeta i informacija potrošačima); predstavljanje proizvoda [demonstracija]; preduzeća (pomoć u vođenju komercijalnih ili industrijskih preduzeća); preduzeća (usluge preseljenja za preduzeća); prelamanje stranica u reklamne svrhe [stavljanje u štampu u reklamne svrhe]; prepis saopštenja; preseljavanje preduzeća (usluge preseljavanja preduzeća); pretplata na novine (usluge pretplate na novine) [za treće osobe]; pretplata na telekomunikacione usluge za treća lica; prezentacija proizvoda na svim komunikacionim sredstvima u svrhu prodaje na malo; procjene komercijalnih poslova; prodaja (podsticaj prodaje) za treće osobe; prodaja na aukciji; proizvodne cijene (analiza proizvodnih cijena); proučavanje tržišta [marketing]; provjera računa; psihotehnički odabir osoblja; računovodstveni poslovi; radio (reklamiranje putem radija); reklamiranje (iznajmljivanje prostora za potrebe reklamiranja); reklamiranje dopisnim putem; reklamiranje on-line na informatičkoj mreži; reklamiranje putem radija; reklamiranje putem televizije; reklamna dokumentacija (uređenje reklamne dokumentacije); reklamna pošta; reklamni fi lmovi (proizvodnja reklamnih fi lмова); reklamni materijal (iznajmljivanje reklamnog materijala); reklamni materijal (razdioba reklamnog materijala); reklamni materijal (raznošenje reklamnog materijala); reklamni oglasi (širenje reklamnih oglasa); reklamni tekstovi

(objavljivanje reklamnih tekstova); reklamni tekstovi (uređenje reklamnih tekstova); sajmovi (organizovanje sajmova u komercijalne ili reklamne svrhe); saopštenja (prepisi, saopštenja); savjeti o organizaciji i vođenju poslova; savjetovanje (stručno savjetovanje o poslovima); savjetovanje o osoblju; sekretarske usluge (sekretarske usluge); sistematizovanje podataka za središnju kartoteku; sponzori (traženje sponzora); statistički podaci (izrada statističkih podataka); stenografske usluge; stručne poslovne konsultacije; štampa (praćenje štampe); štampa (usluge pregleda štampe); tekst (obrada teksta); telefonski odgovori (usluge telefonskih odgovora) za odsutne pretplatnike; telekomunikacione usluge za treće lice (pretplata na telekomunikacione usluge za treće lice); telemarketing (usluge telemarketinga); televizijsko reklamiranje; teretni vagoni (lociranje teretnih vagona pomoću kompjutera); trgovački poslovi (procjene trgovačkih poslova); tržište (proučavanje tržišta); tržište (traženje tržišta); umjetnički poslovi (profesionalno upravljanje umjetničkim poslovima); umnožavanje isprava; uređenje izloga; uvoz-izvoz (agencije za uvoz-izvoz); uzorci (isporuka uzoraka); vođenje informatičkih kartoteka; vođenje knjiga; vođenje poslova (pomoć u vođenju poslova); vođenje poslova (savjetovanje o vođenju poslova); vođenje poslova (usluge savjetovanja u vezi vođenja poslova); vođenje poslova poslovni za sportiste [poslovni menadžment]; zapošljavanje (usluge kancelarije za zapošljavanje); zapošljavanje lica.

Klasa 36: Agencije za kredite; agencije za nekretnine; agencije za stanove [nepokretna imovina]; agencije za utjerivanje potraživanja; bankarske usluge, kućne; bankarski poslovi [transakcije]; bankovne transakcije (obavljanje bankovnih transakcija, kućne) [homebanking]; bolesničko osiguranje; carinske kancelarije [carinarski punktovi]; čekovi (ovjera čekova); depoziti dragocjenosti; dobrotvorne svrhe (skupljanje za dobrotvorne svrhe); dugovanje (službe za kartice dugovanja [debit kartice]); efektna berza [službeno bilježenje kurseva ugovorenih vrijednosti na tržištu]; financije (savjetovanje u vezi financija); finansijska analiza; finansijske procjene [osiguranje, banke, nekretnine]; finansijski [bankarski] poslovi; finansijski oglasi; finansijski poslovi [transakcije]; finansiranje (usluge finansiranja); fiskalne procjene; fondovi (osnivanje fondova); garancije [garancije]; građevinski objekti (upravljanje građevinskim objektima); imovina (upravljanje imovinom); informacije (finansijska obavještenja); informacije o osiguranju; izdavanje putnih čekova; izdavanje vrijednosnih bonova; iznajmljivanje kancelarija [nekretnine]; iznajmljivanje poljoprivrednih imanja; iznajmljivanje stanova; kapital (ulaganje kapitala); kompenzacijski poslovi [mijenjanje]; krediti; kreditne kartice (izdavanje kreditnih kartica); kreditne kartice (službe za kreditne kartice); likvidacija preduzeća (usluge likvidacije preduzeća); marke (procjena poštanskih maraka); mijenjanje novca (usluge mjenjačnica); monetarni poslovi; nakit (procjena nakita); naknada štete (finansijska procjena naknade štete); nekretnine (agencije za nekretnine); nekretnine (davanje u zakup nekretnina) [lizing]; nekretnine (procjena nekretnina); nekretnine (upravljanje nekretninama); nezgode (osiguranje od nezgoda); novčana sredstva (elektronski prijenos novčanih sredstava); numizmatička procjena; osiguranja; osiguranje (informacije o osiguranju); osiguranje (savjetovanje o osiguranju); osiguranje (usluge matematičkih stručnjaka [aktuara] za životno osiguranje); osnivanje kapitala; otplata na rate; ovjeravanje čekova; penzije (usluge blagajni za plaćanje penzija); pokroviteljstvo (finansijsko pokroviteljstvo); poljoprivredna imanja (iznajmljivanje poljoprivrednih imanja); pomorsko osiguranje; posredovanje [mešetarenje] \*; posredovanje [mešetarenje] u trgovini nekretninama; posredovanje na berzi; posredovanje na berzi [mešetarenje]; posredovanje u nekretninama; posredovanje u osiguranju; potraživanja (utjerivanje potraživanja jednog preduzeća posredstvom spoljnog nagodbenog tijela) [faktoring]; povjereničke službe; pozajmljivanje na temelju zaloga; požar (osiguranje od

požara); prijenos elektronskim putem novčanih sredstava; procjena maraka; procjena nakita; procjena nekretnina; procjena stabala u šumi; procjena starina [antikviteta]; procjena umjetnina; procjena vune [finansijska procjena vune]; procjene (fiskalne procjene); procjene (numizmatičke procjene); procjene finansijske procjene [osiguranje, bankarski promet, imovina]; putni čekovi (izdavanje putnih čekova); savjetovanje o finansijskim pitanjima; savjetovanje o osiguranju; sigurnosne blagajne [sefovi] (odlaganje u sigurnosne blagajne); skupljanje priloga; skupljanje za dobrotvorne svrhe; sredstva (stvaranje zajedničkih sredstava); stabla u šumi (procjena stabala u šumi); stanarine (naplata stanarina); stanovi (iznajmljivanje stanova); starine (procjena starina); štedionice [usluge štedionica]; transakcije (finansijske transakcije); ulaganje sredstava; umjetnička djela (procjena umjetničkih djela); upravljanje građevinskim objektima; upravljanje imovinom; upravljanje nekretninama; usluge depozita u sefovima; usluge fondova uzajamne pomoći; utjerivanje dugovanja (agencije za utjerivanje dugovanja); vrijednosni bonovi (izdavanje vrijednosnih bonova); vrijednosti (depoziti vrijednosti); zajam na temelju zalog; zajmovi; zakup [vrsta iznajmljivanja dobara za profesionalne potrebe, koja temeljem ugovora mogu postati vlasništvo iznajmitelja] [lizing]; zakup nekretnina (davanje u zakup nekretnina) [lizing]; zalog (davanje zajma uz zalog); životno osiguranje (potpisivanje polisa za osiguranje života).

Klasa 41: Agencije za modele za slikare i vajar; akademije [obuka]; cirkusi; cirkusi [zabavni parkovi]; dekor za priredbe (iznajmljivanje dekora za priredbe); digitalne slike (usluge digitalnog snimanja); disk džokeji (usluge disk džokeja) usluge; diskoteke (usluge diskoteka); dopisivanje (obuka putem dopisivanja); elektronske publikacije (iskorištavanje elektronskih publikacija koje se ne mogu prenositi on-line); filmovi (prikazivanje igranih filmova); filmovi (proizvodnja filmova); fitnes časovi (vođenje fitnes časova); fizičke vježbe [fizička kultura]; fotografi sanje; fotografske reportaže; gimnastičarska obuka; golf (stavljanje na raspolaganje igrališta za golf); govor pokreta (tumačenje govora pokreta); govor pokretima (tumačenje govora pokretima); igre (usluge hala i dvorana za igre); igre (usluge igara) pružene on-line [s jedne informatičke mreže]; igre za novac; informacije o obrazovanju; informacije o razonodi; informacije u vezi rekreacije; izdavanje knjiga; izložbe (organizovanje izložbi) u kulturne ili obrazovne svrhe; iznajmljivanje audio uređaja; iznajmljivanje dekora za priredbe; iznajmljivanje igrački; iznajmljivanje kinematografskih filmova; iznajmljivanje kinoaparature i pribora; iznajmljivanje magnetoskopa; iznajmljivanje opreme za igranje; iznajmljivanje radio i televizijskih aparata; iznajmljivanje rasvjetnih uređaja za pozorišnu dekoraciju i za televizijske studije; iznajmljivanje ronilačke opreme; iznajmljivanje sportske opreme [osim vozila]; iznajmljivanje sportskih terena; iznajmljivanje stadiona; iznajmljivanje teniskih igrališta; iznajmljivanje videokamera; iznajmljivanje videotraka; iznajmljivanje zvučnih snimaka; javni konkursi (organizovanje javnih konkursa) [obuka ili zabava]; kaligrafija (usluge kaligrafije); kampovi za ljetovanje (usluge kampova za ljetovanje) [zabava]; kampovi za sportsko usavršavanje; karaoke (stavljanje na raspolaganje opreme za karaoke); kinematografski filmovi (iznajmljivanje kinematografskih filmova); kino sale (iskorištavanje kinodvorana); kino studiji; kinoaparatura (iznajmljivanje kinoaparature i pribora); klubovi (usluge klubova) [zabava ili obrazovanje]; knjige (izdavanje knjiga); knjige (posuđivanje knjiga); kockarnice [igre] (usluge kockarnica); komponovanje muzike; komponovanje muzike (usluge komponovanja muzike); koncerti (organizovanje i vođenje koncerata); konferencije (organizovanje i vođenje konferencija); kongresi (organizovanje i vođenje kongresa); kročenje životinja [dresiranje]; lični treneri (usluge ličnih trenera) [fitnes]; lutrija (organizovanje lutrije); ljetovanje (usluge kampova za ljetovanje) [razonoda]; magnetoskopi (iznajmljivanje magnetoskopa); mikrofoni (snimanje na mikrofilmovima); mikroizdavaštvo; mjerenje vremena na sportskim takmičenjima; modne revije za zabavne

svrhe (organizovanje); montaža radio i televizijskih programa; muzejske usluge [predstavljanje, izložbe]; muzičke sale; noćni klubovi; objavljivanje knjiga i časopisa, elektronski on line; objavljivanje tekstova [osim u reklamne svrhe]; obrazovanje (informacije o obrazovanju); obrazovanje [obuka]; obrazovni zavodi [internati]; obuka; obuka [predavanje]; obuka putem dopisivanja; obuka za predškolski uzrast; organizovanje i vođenje koncerata; organizovanje i vođenje konferencija; organizovanje i vođenje kongresa; organizovanje i vođenje radionica za stručno osposobljavanje; organizovanje i vođenje razgovora; organizovanje i vođenje seminara; organizovanje izložba u kulturne i obrazovne svrhe; organizovanje javnih konkursa [obrazovanje ili razonoda]; organizovanje konkursa ljepote; organizovanje plesova; organizovanje spektakla [usluge impresarija]; organizovanje sportskih takmičenja; orkestri (usluge orkestra); pedagoški eksperimenti; pisanje tekstova [ne u reklamne svrhe]; planiranje prijema [razonoda]; posuđivanje knjiga; pozorišne predstave; pozorišni dekor (iznajmljivanje pozorišnog dekora); pozorišni glumci (usluge pozorišnih glumaca); pozorišni preduzetnici [impresariji] (usluge pozorišnih preduzetnika); praktična obuka [demonstriranje]; predškolska obuka; prekvalifikacija (usluge prekvalifikacije); prelamanje slogova [ne u reklamne svrhe]; prevodilačke usluge; prevodioci (usluge prevođenja); prijemi (planiranje prijema) [razonoda]; priredbe (iznajmljivanje dekora za priredbe); priredbe (održavanje priredbi); priredbe (organizovanje priredbi) [usluge impresarija]; priredbe (proizvodnja priredbi); profesionalna orijentacija [savjeti u vezi obrazovanja ili osposobljavanja]; proizvodnja filmova; proizvodnja filmova na video-trakama; proizvodnja muzike; putujuće biblioteke (usluge putujućih biblioteka); radio televizijski programi (montaža radio televizijskih programa); radioaparati i televizori (iznajmljivanje radioaparata i televizora); radiofonija (razonoda putem radiofonije); razgovori (organizovanje i vođenje razgovora); razonoda; razonoda (informacije u vezi razonode); razonoda posredstvom radija; razonoda posredstvom televizije; rekreacija (obavještenja u vezi rekreacije); religiozno obrazovanje; reportaže (fotografske reportaže); reporterske usluge; rezervisanje mjesta za priredbe; ronjenje (iznajmljivanje ronilačke opreme); scenarijumi (izrada scenarijuma); seminari (organizovanje i vođenje seminara); simpozijumi (organizacija i vođenje simpozijuma); simpozijumi (organizovanje i vođenje simpozijuma); sinhronizacija; slobodno vrijeme (usluge za ispunjavanje slobodnog vremena); snimanje na videotrake; sportska oprema (stavljanje na raspolaganje sportske opreme); sportska takmičenja (mjerenje vremena na sportskim takmičenjima); sportska takmičenja (organizovanje sportskih takmičenja); sportska usavršavanja (sportski kampovi za usavršavanje u sportu); sportske oprema (iznajmljivanje sportske opreme osim vozila); stadioni (iznajmljivanje stadiona); studio za snimanje (usluge studija za snimanje); tekstovi (objavljivanje tekstova) [osim u reklamne svrhe]; tekstovi (sastavljanje tekstova) [ne u reklamne svrhe]; televizija (razonoda na televiziji); televizijski programi (montaža radio i televizijskih programa); televizori (iznajmljivanje televizora i radioaparata); titlovanje filmova; treniranje [fizička vježba]; tumačenje govora pokreta; ulaznice za priredbe (agencije za ulaznice za priredbe) [razonoda]; videotrake (iznajmljivanje videotraka); videotrake (montaža videotraka); videotrake (proizvodnja filmova na videotrakama); videotrake (snimanje na videotrake); zabavni parkovi [cirkusi]; zdravstveni klubovi (usluge zdravstvenih klubova) [održavanje zdravlja i fizičke forme]; zoološki vrtovi [usluge zooloških vrtova]; zvučni snimci (iznajmljivanje zvučnih snimaka); životinje (kroćenje životinja) [dresiranje].

(210) **Ž-2021-22**

(220) 02.02.2021.

(731) ERSTE BANK AD Podgorica, Aresenija Boljevića 2a, 81000, Podgorica, ME

(540)



(550) I

(511) Klasa 35: Agencije za komercijalne oglase; agencije za uvoz-izvoz; analiza proizvodne cijene; aukcionarstvo (prodaja na aukciji); automati (iznajmljivanje automata); cijene (poređenje cijena); daktilografske usluge; ekonomska predviđanja [prognoze]; fakturisanje; fotokopiranje (usluge fotokopiranja); hoteli (administrativno upravljanje hotelima); informacije (kancelarije za komercijalne informacije); informacije (poslovne informacije); informatičke kartoteke (vođenje informatičkih kartoteka); informatički podaci (pretraživanje podataka u informatičkoj kartoteci za treće lice); isporuka [distribucija] uzoraka; isporuka reklamnih materijala [letaka, prospekata, uzoraka]; isporuka reklamnih oglasa; isprave (umnožavanje isprava); istraživanja za poslove; istraživanje javnog mišljenja; istraživanje za poslove; izlozi (uređivanje izloga); izložbe (organizovanje izložbi) u komercijalne ili reklamne svrhe; iznajmljivanje automata za prodaju sitne robe; iznajmljivanje fotokopirnih uređaja; iznajmljivanje kancelarijskih mašina i aparata; iznajmljivanje reklamnih prostora; iznajmljivanje reklamnog materijala; iznajmljivanje vremena za reklamiranje na svim komunikacionim sredstvima; izvodi iz računa (davanje izvoda sa računa); izvoz-uvoz (agencije za izvoz-uvoz); javno mnijenje (istraživanje javnog mnjenja) [anketiranje]; javnost (odnosi s javnošću) [propaganda]; kancelarije za reklamiranje; kancelarije za zapošljavanje; kancelarijski mašine i aparati (iznajmljivanje kancelarijskih mašina i aparata) \*; kartoteka (prikupljanje podataka u središnju kartoteku); kartoteka (sistematizovanje podataka za središnju kartoteku); knjige (vođenje knjiga); komercijalna administracija u vezi licenci proizvoda i usluga trećih lica; komercijalna ili industrijska preduzeća (pomoć u vođenju komercijalnih ili industrijskih preduzeća); konsultacije u vezi vođenje poslova; lociranje teretnih vagona pomoću kompjutera; manekeni (usluge manekena) za reklamiranje ili podsticaj prodaje; marketing; modne revije za promotivne svrhe (organizovanje); nabava za treće (usluge nabave za treće) [kupovina proizvoda i usluga za druga preduzeća]; nabava za treće osobe (usluge kupovine proizvoda i usluga za druga preduzeća); narudžbine (administrativna obrada narudžbina za kupovinu); novine (usluge pretplate novina) za treće osobe; objavljivanje reklamnih tekstova; odabir osoblja psihotehničkim postupkom; odnosi s javnošću [propaganda]; oglašavanje [reklamiranje]; oglašavanje putem pošte; organizovanje izložbi u komercijalne ili reklamne svrhe; organizovanje poslova (savjetovanje o organiziranju poslova); osoblje (biranje osoblja psihotehničkim postupkom); osoblje (savjetovanje o osoblju); osoblje (zapošljavanje osoblja); plakatiranje [oglašavanje]; platni listovi (izrada platnih listova); podsticaj prodaje za treće osobe; podugovaranje (usluge podugovaranja) [komercijalna pomoć]; pomoć u upravljanju industrijskim ili trgovačkim preduzećima; pomoć u vođenju poslova; porezne prijave (izrada poreznih prijava); poslovi (istraživanja za poslove); poslovi (istraživanje za poslove); poslovi (konsultacije za vođenja poslova); poslovi (obavještenja o poslovima); poslovi (pomoć u vođenju poslova); poslovi (savjetovanje o organizaciji i vođenju poslova);



poslovi (vještačenje poslova) [ekspertize]; poslovne informacije; potrošači (pružanje komercijalnih savjeta i informacija potrošačima); predstavljanje proizvoda [demonstracija]; preduzeća (pomoć u vođenju komercijalnih ili industrijskih preduzeća); preduzeća (usluge preseljenja za preduzeća); prelamanje stranica u reklamne svrhe [stavljanje u štampu u reklamne svrhe]; prepis saopštenja; preseljavanje preduzeća (usluge preseljavanja preduzeća); pretplata na novine (usluge pretplate na novine) [za treće osobe]; pretplata na telekomunikacione usluge za treća lica; prezentacija proizvoda na svim komunikacionim sredstvima u svrhu prodaje na malo; procjene komercijalnih poslova; prodaja (podsticaj prodaje) za treće osobe; prodaja na aukciji; proizvodne cijene (analiza proizvodnih cijena); proučavanje tržišta [marketing]; provjera računa; psihotehnički odabir osoblja; računovodstveni poslovi; radio (reklamiranje putem radija); reklamiranje (iznajmljivanje prostora za potrebe reklamiranja); reklamiranje dopisnim putem; reklamiranje on-line na informatičkoj mreži; reklamiranje putem radija; reklamiranje putem televizije; reklamna dokumentacija (uređenje reklamne dokumentacije); reklamna pošta; reklamni fi lmovi (proizvodnja reklamnih fi lмова); reklamni materijal (iznajmljivanje reklamnog materijala); reklamni materijal (razdioba reklamnog materijala); reklamni materijal (raznošenje reklamnog materijala); reklamni oglasi (širenje reklamnih oglasa); reklamni tekstovi (objavljivanje reklamnih tekstova); reklamni tekstovi (uređenje reklamnih tekstova); sajmovi (organizovanje sajmova u komercijalne ili reklamne svrhe); saopštenja (prepisi, saopštenja); savjeti o organizaciji i vođenju poslova; savjetovanje (stručno savjetovanje o poslovima); savjetovanje o osoblju; sekretarske usluge (sekretarske usluge); sistematizovanje podataka za središnju kartoteku; sponzori (traženje sponzora); statistički podaci (izrada statističkih podataka); stenografske usluge; stručne poslovne konsultacije; štampa (praćenje štampe); štampa (usluge pregleda štampe); tekst (obrada teksta); telefonski odgovori (usluge telefonskih odgovora) za odsutne pretplatnike; telekomunikacione usluge za treće lica (pretplata na telekomunikacione usluge za treće lica); telemarketing (usluge telemarketinga); televizijsko reklamiranje; teretni vagoni (lociranje teretnih vagona pomoću kompjutera); trgovački poslovi (procjene trgovačkih poslova); tržište (proučavanje tržišta); tržište (traženje tržišta); umjetnički poslovi (profesionalno upravljanje umjetničkim poslovima); umnožavanje isprava; uređenje izloga; uvoz-izvoz (agencije za uvoz-izvoz); uzorci (isporuka uzoraka); vođenje informatičkih kartoteka; vođenje knjiga; vođenje poslova (pomoć u vođenju poslova); vođenje poslova (savjetovanje o vođenju poslova); vođenje poslova (usluge savjetovanja u vezi vođenja poslova); vođenje poslova poslovni za sportiste [poslovni menadžment]; zapošljavanje (usluge kancelarije za zapošljavanje); zapošljavanje lica.

Klasa 36: Agencije za kredite; agencije za nekretnine; agencije za stanove [nepokretna imovina]; agencije za utjerivanje potraživanja; bankarske usluge, kućne; bankarski poslovi [transakcije]; bankovne transakcije (obavljanje bankovnih transakcija, kućne) [homebanking]; bolesničko osiguranje; carinske kancelarije [carinarski punktovi]; čekovi (ovjera čekova); depoziti dragocjenosti; dobrotvorne svrhe (skupljanje za dobrotvorne svrhe); dugovanje (službe za kartice dugovanja [debit kartice]); efektna berza [službeno bilježenje kurseva ugovorenih vrijednosti na tržištu]; financije (savjetovanje u vezi financija); finansijska analiza; finansijske procjene [osiguranje, banke, nekretnine]; finansijski [bankarski] poslovi; finansijski oglasi; finansijski poslovi [transakcije]; finansiranje (usluge finansiranja); fiskalne procjene; fondovi (osnivanje fondova); garancije [garancije]; građevinski objekti (upravljanje građevinskim objektima); imovina (upravljanje imovinom); informacije (finansijska obavještenja); informacije o osiguranju; izdavanje putnih čekova; izdavanje vrijednosnih bonova; iznajmljivanje kancelarija [nekretnine]; iznajmljivanje

poljoprivrednih imanja; iznajmljivanje stanova; kapital (ulaganje kapitala); kompenzacijski poslovi [mijenjanje]; krediti; kreditne kartice (izdavanje kreditnih kartica); kreditne kartice (službe za kreditne kartice); likvidacija preduzeća (usluge likvidacije preduzeća); marke (procjena poštanskih maraka); mijenjanje novca (usluge mjenjačnica); monetarni poslovi; nakit (procjena nakita); naknada štete (finansijska procjena naknade štete); nekretnine (agencije za nekretnine); nekretnine (davanje u zakup nekretnina) [lizing]; nekretnine (procjena nekretnina); nekretnine (upravljanje nekretninama); nezgode (osiguranje od nezgoda); novčana sredstva (elektronski prijenos novčanih sredstava); numizmatička procjena; osiguranja; osiguranje (informacije o osiguranju); osiguranje (savjetovanje o osiguranju); osiguranje (usluge matematičkih stručnjaka [aktuara] za životno osiguranje); osnivanje kapitala; otplata na rate; ovjeravanje čekova; penzije (usluge blagajni za plaćanje penzija); pokroviteljstvo (finansijsko pokroviteljstvo); poljoprivredna imanja (iznajmljivanje poljoprivrednih imanja); pomorsko osiguranje; posredovanje [mešetarenje] \*; posredovanje [mešetarenje] u trgovini nekretninama; posredovanje na berzi; posredovanje na berzi [mešetarenje]; posredovanje u nekretninama; posredovanje u osiguranju; potraživanja (utjerivanje potraživanja jednog preduzeća posredstvom spoljnog nagodbenog tijela) [faktoring]; povjereničke službe; pozajmljivanje na temelju zalog; požar (osiguranje od požara); prijenos elektronskim putem novčanih sredstava; procjena maraka; procjena nakita; procjena nekretnina; procjena stabala u šumi; procjena starina [antikviteta]; procjena umjetnina; procjena vune [finansijska procjena vune]; procjene (fiskalne procjene); procjene (numizmatičke procjene); procjene finansijske procjene [osiguranje, bankarski promet, imovina]; putni čekovi (izdavanje putnih čekova); savjetovanje o finansijskim pitanjima; savjetovanje o osiguranju; sigurnosne blagajne [sefovi] (odlaganje u sigurnosne blagajne); skupljanje priloga; skupljanje za dobrotvorne svrhe; sredstva (stvaranje zajedničkih sredstava); stabla u šumi (procjena stabala u šumi); stanarine (naplata stanarina); stanovi (iznajmljivanje stanova); starine (procjena starina); štedionice [usluge štedionica]; transakcije (finansijske transakcije); ulaganje sredstava; umjetnička djela (procjena umjetničkih djela); upravljanje građevinskim objektima; upravljanje imovinom; upravljanje nekretninama; usluge depozita u sefovima; usluge fondova uzajamne pomoći; utjerivanje dugovanja (agencije za utjerivanje dugovanja); vrijednosni bonovi (izdavanje vrijednosnih bonova); vrijednosti (depoziti vrijednosti); zajam na temelju zalog; zajmovi; zakup [vrsta iznajmljivanja dobara za profesionalne potrebe, koja temeljem ugovora mogu postati vlasništvo iznajmitelja] [lizing]; zakup nekretnina (davanje u zakup nekretnina) [lizing]; zalog (davanje zajma uz zalog); životno osiguranje (potpisivanje polisa za osiguranje života).

Klasa 41: Agencije za modele za slikare i vajar; akademije [obuka]; cirkusi; cirkusi [zabavni parkovi]; dekor za priredbe (iznajmljivanje dekora za priredbe); digitalne slike (usluge digitalnog snimanja); disk džokeji (usluge disk džokeja) usluge; diskoteke (usluge diskoteka); dopisivanje (obuka putem dopisivanja); elektronske publikacije (iskorištavanje elektronskih publikacija koje se ne mogu prenositi on-line); filmovi (prikazivanje igranih filmova); filmovi (proizvodnja filmova); fitnes časovi (vođenje fitnes časova); fizičke vježbe [fizička kultura]; fotografiranje; fotografske reportaže; gimnastičarska obuka; golf (stavljavanje na raspolaganje igrališta za golf); govor pokreta (tumačenje govora pokreta); govor pokretima (tumačenje govora pokretima); igre (usluge hala i dvorana za igre); igre (usluge igara) pružene on-line [s jedne informatičke mreže]; igre za novac; informacije o obrazovanju; informacije o razonodi; informacije u vezi rekreacije; izdavanje knjiga; izložbe (organizovanje izložbi) u kulturne ili obrazovne svrhe; iznajmljivanje audio uređaja; iznajmljivanje dekora za priredbe; iznajmljivanje igrački; iznajmljivanje kinematografskih filmova; iznajmljivanje kinoaparature i pribora; iznajmljivanje magnetoskopa; iznajmljivanje

opreme za igranje; iznajmljivanje radio i televizijskih aparata; iznajmljivanje rasvjetnih uređaja za pozorišnu dekoraciju i za televizijske studije; iznajmljivanje ronilačke opreme; iznajmljivanje sportske opreme [osim vozila]; iznajmljivanje sportskih terena; iznajmljivanje stadiona; iznajmljivanje teniskih igrališta; iznajmljivanje videokamera; iznajmljivanje videotraka; iznajmljivanje zvučnih snimaka; javni konkursi (organizovanje javnih konkursa) [obuka ili zabava]; kaligrafija (usluge kaligrafije); kampovi za ljetovanje (usluge kampova za ljetovanje) [zabava]; kampovi za sportsko usavršavanje; karaoke (stavljanje na raspolaganje opreme za karaoke); kinematografski filmovi (iznajmljivanje kinematografskih filmova); kino sale (iskorištavanje kinodvorana); kino studiji; kinoaparatura (iznajmljivanje kinoaparature i pribora); klubovi (usluge klubova) [zabava ili obrazovanje]; knjige (izdavanje knjiga); knjige (posuđivanje knjiga); kockarnice [igre] (usluge kockarnica); komponovanje muzike; komponovanje muzike (usluge komponovanja muzike); koncerti (organizovanje i vođenje koncerata); konferencije (organizovanje i vođenje konferencija); kongresi (organizovanje i vođenje kongresa); kročenje životinja [dresiranje]; lični treneri (usluge ličnih trenera) [fitness]; lutrija (organizovanje lutrije); ljetovanje (usluge kampova za ljetovanje) [razonoda]; magnetoskopi (iznajmljivanje magnetoskopa); mikrofoni (snimanje na mikrofilmove); mikroizdavaštvo; mjerenje vremena na sportskim takmičenjima; modne revije za zabavne svrhe (organizovanje); montaža radio i televizijskih programa; muzejske usluge [predstavljanje, izložbe]; muzičke sale; noćni klubovi; objavljivanje knjiga i časopisa, elektronski on line; objavljivanje tekstova [osim u reklamne svrhe]; obrazovanje (informacije o obrazovanju); obrazovanje [obuka]; obrazovni zavodi [internati]; obuka; obuka [predavanje]; obuka putem dopisivanja; obuka za predškolski uzrast; organizovanje i vođenje koncerata; organizovanje i vođenje konferencija; organizovanje i vođenje kongresa; organizovanje i vođenje radionica za stručno osposobljavanje; organizovanje i vođenje razgovora; organizovanje i vođenje seminara; organizovanje izložba u kulturne i obrazovne svrhe; organizovanje javnih konkursa [obrazovanje ili razonoda]; organizovanje konkursa ljepote; organizovanje plesova; organizovanje spektakla [usluge impresarija]; organizovanje sportskih takmičenja; orkestri (usluge orkestra); pedagoški eksperimenti; pisanje tekstova [ne u reklamne svrhe]; planiranje prijema [razonoda]; posuđivanje knjiga; pozorišne predstave; pozorišni dekor (iznajmljivanje pozorišnog dekora); pozorišni glumci (usluge pozorišnih glumaca); pozorišni preduzetnici [impresariji] (usluge pozorišnih preduzetnika); praktična obuka [demonstriranje]; predškolska obuka; prekvalifikacija (usluge prekvalifikacije); prelamanje slogova [ne u reklamne svrhe]; prevodilačke usluge; prevodioci (usluge prevođenja); prijemi (planiranje prijema) [razonoda]; priredbe (iznajmljivanje dekora za priredbe); priredbe (održavanje priredbi); priredbe (organizovanje priredbi) [usluge impresarija]; priredbe (proizvodnja priredbi); profesionalna orijentacija [savjeti u vezi obrazovanja ili osposobljavanja]; proizvodnja filmova; proizvodnja filmova na video-trakama; proizvodnja muzike; putujuće biblioteke (usluge putujućih biblioteka); radio televizijski programi (montaža radio televizijskih programa); radioaparati i televizori (iznajmljivanje radioaparata i televizora); radiofonija (razonoda putem radiofonije); razgovori (organizovanje i vođenje razgovora); razonoda; razonoda (informacije u vezi razonode); razonoda posredstvom radija; razonoda posredstvom televizije; rekreacija (obavještenja u vezi rekreacije); religiozno obrazovanje; reportaže (fotografske reportaže); reporterske usluge; rezervisanje mjesta za priredbe; ronjenje (iznajmljivanje ronilačke opreme); scenarijumi (izrada scenarijuma); seminari (organizovanje i vođenje seminara); simpozijumi (organizacija i vođenje simpozijuma); simpozijumi (organizovanje i vođenje simpozijuma); sinhronizacija; slobodno vrijeme (usluge za ispunjavanje slobodnog vremena); snimanje na videotrake; sportska oprema (stavljanje na raspolaganje sportske opreme); sportska

takmičenja (mjerenje vremena na sportskim takmičenjima); sportska takmičenja (organizovanje sportskih takmičenja); sportska usavršavanja (sportski kampovi za usavršavanje u sportu); sportske oprema (iznajmljivanje sportske opreme osim vozila); stadioni (iznajmljivanje stadiona); studio za snimanje (usluge studija za snimanje); tekstovi (objavljivanje tekstova) [osim u reklamne svrhe]; tekstovi (sastavljanje tekstova) [ne u reklamne svrhe]; televizija (razonoda na televiziji); televizijski programi (montaža radio i televizijskih programa); televizori (iznajmljivanje televizora i radioaparata); titlovanje filmova; treniranje [fizička vježba]; tumačenje govora pokreta; ulaznice za priredbe (agencije za ulaznice za priredbe) [razonoda]; videotrake (iznajmljivanje videotraka); videotrake (montaža videotraka); videotrake (proizvodnja filmova na videotrakama); videotrake (snimanje na videotrake); zabavni parkovi [cirkusij]; zdravstveni klubovi (usluge zdravstvenih klubova) [održavanje zdravlja i fizičke forme]; zoološki vrtovi [usluge zooloških vrtova]; zvučni snimci (iznajmljivanje zvučnih snimaka); životinje (kroćenje životinja) [dresiranje].

---

(210) **Ž-2021-23**

(220) 02.02.2021.

(731) ERSTE BANK AD Podgorica, Aresenija Boljevića 2a, 81000, Podgorica, ME

(540)

## Ratka - kartica na rate Erste banke

(550) I

(511) Klasa 35: Agencije za komercijalne oglase; agencije za uvoz-izvoz; analiza proizvodne cijene; aukcionarstvo (prodaja na aukciji); automati (iznajmljivanje automata); cijene (poređenje cijena); daktilografske usluge; ekonomska predviđanja [prognoze]; fakturisanje; fotokopiranje (usluge fotokopiranja); hoteli (administrativno upravljanje hotelima); informacije (kancelarije za komercijalne informacije); informacije (poslovne informacije); informatičke kartoteke (vođenje informatičkih kartoteka); informatički podaci (pretraživanje podataka u informatičkoj kartoteci za treće lice); isporuka [distribucija] uzoraka; isporuka reklamnih materijala [letaka, prospekata, uzoraka]; isporuka reklamnih oglasa; isprave (umnožavanje isprava); istraživanja za poslove; istraživanje javnog mišljenja; istraživanje za poslove; izlozi (uređivanje izloga); izložbe (organizovanje izložbi) u komercijalne ili reklamne svrhe; iznajmljivanje automata za prodaju sitne robe; iznajmljivanje fotokopirnih uređaja; iznajmljivanje kancelarijskih mašina i aparata; iznajmljivanje reklamnih prostora; iznajmljivanje reklamnog materijala; iznajmljivanje vremena za reklamiranje na svim komunikacionim sredstvima; izvodi iz računa (davanje izvoda sa računa); izvoz-uvoz (agencije za izvoz-uvoz); javno mnijenje (istraživanje javnog mnjenja) [anketiranje]; javnost (odnosi s javnošću) [propaganda]; kancelarije za reklamiranje; kancelarije za zapošljavanje; kancelarijski mašine i aparati (iznajmljivanje kancelarijskih mašina i aparata) \*; kartoteka (prikupljanje podataka u središnju kartoteku); kartoteka (sistematizovanje podataka za središnju kartoteku); knjige (vođenje knjiga); komercijalna administracija u vezi licenci proizvoda i usluga trećih lica; komercijalna ili industrijska preduzeća (pomoć u vođenju komercijalnih ili industrijskih preduzeća); konsultacije u vezi vođenje poslova; lociranje teretnih vagona pomoću kompjutera; manekeni (usluge manekena) za reklamiranje ili podsticaj prodaje; marketing; modne revije za promotivne svrhe (organizovanje); nabava za treće (usluge nabave za treće) [kupovina

proizvoda i usluga za druga preduzeća]; nabava za treće osobe (usluge kupovine proizvoda i usluga za druga preduzeća); narudžbine (administrativna obrada narudžbina za kupovinu); novine (usluge pretplate novina) za treće osobe; objavljivanje reklamnih tekstova; odabir osoblja psihotehničkim postupkom; odnosi s javnošću [propaganda]; oglašavanje [reklamiranje]; oglašavanje putem pošte; organizovanje izložbi u komercijalne ili reklamne svrhe; organizovanje poslova (savjetovanje o organiziranju poslova); osoblje (biranje osoblja psihotehničkim postupkom); osoblje (savjetovanje o osoblju); osoblje (zapošljavanje osoblja); plakatiranje [oglašavanje]; platni listovi (izrada platnih listova); podsticaj prodaje za treće osobe; podugovaranje (usluge podugovaranja) [komercijalna pomoć]; pomoć u upravljanju industrijskim ili trgovačkim preduzećima; pomoć u vođenju poslova; porezne prijave (izrada poreznih prijava); poslovi (istraživanja za poslove); poslovi (istraživanje za poslove); poslovi (konsultacije za vođenja poslova); poslovi (obavještenja o poslovima); poslovi (pomoć u vođenju poslova); poslovi (savjetovanje o organizaciji i vođenju poslova); poslovi (vještačenje poslova) [ekspertize]; poslovne informacije; potrošači (pružanje komercijalnih savjeta i informacija potrošačima); predstavljanje proizvoda [demonstracija]; preduzeća (pomoć u vođenju komercijalnih ili industrijskih preduzeća); preduzeća (usluge preseljenja za preduzeća); prelamanje stranica u reklamne svrhe [stavljanje u štampu u reklamne svrhe]; prepis saopštenja; preseljavanje preduzeća (usluge preseljavanja preduzeća); pretplata na novine (usluge pretplate na novine) [za treće osobe]; pretplata na telekomunikacione usluge za treća lica; prezentacija proizvoda na svim komunikacionim sredstvima u svrhu prodaje na malo; procjene komercijalnih poslova; prodaja (podsticaj prodaje) za treće osobe; prodaja na aukciji; proizvodne cijene (analiza proizvodnih cijena); proučavanje tržišta [marketing]; provjera računa; psihotehnički odabir osoblja; računovodstveni poslovi; radio (reklamiranje putem radija); reklamiranje (iznajmljivanje prostora za potrebe reklamiranja); reklamiranje dopisnim putem; reklamiranje on-line na informatičkoj mreži; reklamiranje putem radija; reklamiranje putem televizije; reklamna dokumentacija (uređenje reklamne dokumentacije); reklamna pošta; reklamni fi lmovi (proizvodnja reklamnih fi lмова); reklamni materijal (iznajmljivanje reklamnog materijala); reklamni materijal (razdioba reklamnog materijala); reklamni materijal (raznošenje reklamnog materijala); reklamni oglasi (širenje reklamnih oglasa); reklamni tekstovi (objavljivanje reklamnih tekstova); reklamni tekstovi (uređenje reklamnih tekstova); sajmovi (organizovanje sajmova u komercijalne ili reklamne svrhe); saopštenja (prepisi, saopštenja); savjeti o organizaciji i vođenju poslova; savjetovanje (stručno savjetovanje o poslovima); savjetovanje o osoblju; sekretarske usluge (sekretarske usluge); sistematizovanje podataka za središnju kartoteku; sponzori (traženje sponzora); statistički podaci (izrada statističkih podataka); stenografske usluge; stručne poslovne konsultacije; štampa (praćenje štampe); štampa (usluge pregleda štampe); tekst (obrada teksta); telefonski odgovori (usluge telefonskih odgovora) za odsutne pretplatnike; telekomunikacione usluge za treće lica (pretplata na telekomunikacione usluge za treće lica); telemarketing (usluge telemarketinga); televizijsko reklamiranje; teretni vagoni (lociranje teretnih vagona pomoću kompjutera); trgovački poslovi (procjene trgovačkih poslova); tržište (proučavanje tržišta); tržište (traženje tržišta); umjetnički poslovi (profesionalno upravljanje umjetničkim poslovima); umnožavanje isprava; uređenje izloga; uvoz-izvoz (agencije za uvoz-izvoz); uzorci (isporuka uzoraka); vođenje informatičkih kartoteka; vođenje knjiga; vođenje poslova (pomoć u vođenju poslova); vođenje poslova (savjetovanje o vođenju poslova); vođenje poslova (usluge savjetovanja u vezi vođenja poslova); vođenje poslova poslovni za sportiste [poslovni menadžment]; zapošljavanje (usluge kancelarije za zapošljavanje); zapošljavanje lica.

Klasa 36: Agencije za kredite; agencije za nekretnine; agencije za stanove [nepokretna imovina]; agencije za utjerivanje potraživanja; bankarske usluge, kućne; bankarski poslovi [transakcije]; bankovne transakcije (obavljanje bankovnih transakcija, kućne) [homebanking]; bolesničko osiguranje; carinske kancelarije [carinarski punktovi]; čekovi (ovjera čekova); depoziti dragocjenosti; dobrotvorne svrhe (skupljanje za dobrotvorne svrhe); dugovanje (službe za kartice dugovanja [debit kartice]); efektna berza [službeno bilježenje kurseva ugovorenih vrijednosti na tržištu]; financije (savjetovanje u vezi financija); finansijska analiza; finansijske procjene [osiguranje, banke, nekretnine]; finansijski [bankarski] poslovi; finansijski oglasi; finansijski poslovi [transakcije]; finansiranje (usluge finansiranja); fiskalne procjene; fondovi (osnivanje fondova); garancije [garancije]; građevinski objekti (upravljanje građevinskim objektima); imovina (upravljanje imovinom); informacije (finansijska obavještenja); informacije o osiguranju; izdavanje putnih čekova; izdavanje vrijednosnih bonova; iznajmljivanje kancelarija [nekretnine]; iznajmljivanje poljoprivrednih imanja; iznajmljivanje stanova; kapital (ulaganje kapitala); kompenzacijski poslovi [mijenjanje]; krediti; kreditne kartice (izdavanje kreditnih kartica); kreditne kartice (službe za kreditne kartice); likvidacija preduzeća (usluge likvidacije preduzeća); marke (procjena poštanskih maraka); mijenjanje novca (usluge mjenjačnica); monetarni poslovi; nakit (procjena nakita); naknada štete (finansijska procjena naknade štete); nekretnine (agencije za nekretnine); nekretnine (davanje u zakup nekretnina) [lizing]; nekretnine (procjena nekretnina); nekretnine (upravljanje nekretninama); nezgode (osiguranje od nezgoda); novčana sredstva (elektronski prijenos novčanih sredstava); numizmatička procjena; osiguranja; osiguranje (informacije o osiguranju); osiguranje (savjetovanje o osiguranju); osiguranje (usluge matematičkih stručnjaka [aktuara] za životno osiguranje); osnivanje kapitala; otplata na rate; ovjeravanje čekova; penzije (usluge blagajni za plaćanje penzija); pokroviteljstvo (finansijsko pokroviteljstvo); poljoprivredna imanja (iznajmljivanje poljoprivrednih imanja); pomorsko osiguranje; posredovanje [mešetarenje] \*; posredovanje [mešetarenje] u trgovini nekretninama; posredovanje na berzi; posredovanje na berzi [mešetarenje]; posredovanje u nekretninama; posredovanje u osiguranju; potraživanja (utjerivanje potraživanja jednog preduzeća posredstvom spoljnog nagodbenog tijela) [faktoring]; povjereničke službe; pozajmljivanje na temelju zalog; požar (osiguranje od požara); prijenos elektronskim putem novčanih sredstava; procjena maraka; procjena nakita; procjena nekretnina; procjena stabala u šumi; procjena starina [antikviteta]; procjena umjetnina; procjena vune [finansijska procjena vune]; procjene (fiskalne procjene); procjene (numizmatičke procjene); procjene finansijske procjene [osiguranje, bankarski promet, imovina]; putni čekovi (izdavanje putnih čekova); savjetovanje o finansijskim pitanjima; savjetovanje o osiguranju; sigurnosne blagajne [sefovi] (odlaganje u sigurnosne blagajne); skupljanje priloga; skupljanje za dobrotvorne svrhe; sredstva (stvaranje zajedničkih sredstava); stabla u šumi (procjena stabala u šumi); stanarine (naplata stanarina); stanovi (iznajmljivanje stanova); starine (procjena starina); štedionice [usluge štedionica]; transakcije (finansijske transakcije); ulaganje sredstava; umjetnička djela (procjena umjetničkih djela); upravljanje građevinskim objektima; upravljanje imovinom; upravljanje nekretninama; usluge depozita u sefovima; usluge fondova uzajamne pomoći; utjerivanje dugovanja (agencije za utjerivanje dugovanja); vrijednosni bonovi (izdavanje vrijednosnih bonova); vrijednosti (depoziti vrijednosti); zajam na temelju zalog; zajmovi; zakup [vrsta iznajmljivanja dobara za profesionalne potrebe, koja temeljem ugovora mogu postati vlasništvo iznajmitelja] [lizing]; zakup nekretnina (davanje u zakup nekretnina) [lizing]; zalog (davanje zajma uz zalog); životno osiguranje (potpisivanje polisa za osiguranje života).

Klasa 41: Agencije za modele za slikare i vajare; akademije [obuka]; cirkusi; cirkusi [zabavni

parkovi]; dekor za priredbe (iznajmljivanje dekora za priredbe); digitalne slike (usluge digitalnog snimanja); disk džokeji (usluge disk džokeja) usluge; diskoteke (usluge diskoteka); dopisivanje (obuka putem dopisivanja); elektronske publikacije (iskorištavanje elektronskih publikacija koje se ne mogu prenositi on-line); filmovi (prikazivanje igranih filmova); filmovi (proizvodnja filmova); fitnes časovi (vođenje fitnes časova); fizičke vježbe [fizička kultura]; fotografi sanje; fotografske reportaže; gimnastičarska obuka; golf (stavljanje na raspolaganje igrališta za golf); govor pokreta (tumačenje govora pokreta); govor pokretima (tumačenje govora pokretima); igre (usluge hala i dvorana za igre); igre (usluge igara) pružene on-line [s jedne informatičke mreže]; igre za novac; informacije o obrazovanju; informacije o razonodi; informacije u vezi rekreacije; izdavanje knjiga; izložbe (organizovanje izložbi) u kulturne ili obrazovne svrhe; iznajmljivanje audio uređaja; iznajmljivanje dekora za priredbe; iznajmljivanje igrački; iznajmljivanje kinematografskih filmova; iznajmljivanje kinoaparature i pribora; iznajmljivanje magnetoskopa; iznajmljivanje opreme za igranje; iznajmljivanje radio i televizijskih aparata; iznajmljivanje rasvjetnih uređaja za pozorišnu dekoraciju i za televizijske studije; iznajmljivanje ronilačke opreme; iznajmljivanje sportske opreme [osim vozila]; iznajmljivanje sportskih terena; iznajmljivanje stadiona; iznajmljivanje teniskih igrališta; iznajmljivanje videokamera; iznajmljivanje videotraka; iznajmljivanje zvučnih snimaka; javni konkursi (organizovanje javnih konkursa) [obuka ili zabava]; kaligrafija (usluge kaligrafije); kampovi za ljetovanje (usluge kampova za ljetovanje) [zabava]; kampovi za sportsko usavršavanje; karaoke (stavljanje na raspolaganje opreme za karaoke); kinematografski filmovi (iznajmljivanje kinematografskih filmova); kino sale (iskorištavanje kinodvorana); kino studiji; kinoaparatura (iznajmljivanje kinoaparature i pribora); klubovi (usluge klubova) [zabava ili obrazovanje]; knjige (izdavanje knjiga); knjige (posuđivanje knjiga); kockarnice [igre] (usluge kockarnica); komponovanje muzike; komponovanje muzike (usluge komponovanja muzike); koncerti (organizovanje i vođenje koncerata); konferencije (organizovanje i vođenje konferencija); kongresi (organizovanje i vođenje kongresa); kroćenje životinja [dresiranje]; lični treneri (usluge ličnih trenera) [fitnes]; lutrija (organizovanje lutrije); ljetovanje (usluge kampova za ljetovanje) [razonoda]; magnetoskopi (iznajmljivanje magnetoskopa); mikrofoni (snimanje na mikrofilmove); mikroizdavaštvo; mjerenje vremena na sportskim takmičenjima; modne revije za zabavne svrhe (organizovanje); montaža radio i televizijskih programa; muzejske usluge [predstavljanje, izložbe]; muzičke sale; noćni klubovi; objavljivanje knjiga i časopisa, elektronski on line; objavljivanje tekstova [osim u reklamne svrhe]; obrazovanje (informacije o obrazovanju); obrazovanje [obuka]; obrazovni zavodi [internati]; obuka; obuka [predavanje]; obuka putem dopisivanja; obuka za predškolski uzrast; organizovanje i vođenje koncerata; organizovanje i vođenje konferencija; organizovanje i vođenje kongresa; organizovanje i vođenje radionica za stručno osposobljavanje; organizovanje i vođenje razgovora; organizovanje i vođenje seminara; organizovanje izložba u kulturne i obrazovne svrhe; organizovanje javnih konkursa [obrazovanje ili razonoda]; organizovanje konkursa ljepote; organizovanje plesova; organizovanje spektakla [usluge impresarija]; organizovanje sportskih takmičenja; orkestri (usluge orkestra); pedagoški eksperimenti; pisanje tekstova [ne u reklamne svrhe]; planiranje prijema [razonoda]; posuđivanje knjiga; pozorišne predstave; pozorišni dekor (iznajmljivanje pozorišnog dekora); pozorišni glumci (usluge pozorišnih glumaca); pozorišni preduzetnici [impresariji] (usluge pozorišnih preduzetnika); praktična obuka [demonstriranje]; predškolska obuka; prekvalifikacija (usluge prekvalifikacije); prelamanje slogova [ne u reklamne svrhe]; prevodilačke usluge; prevodioci (usluge prevođenja); prijemi (planiranje prijema) [razonoda]; priredbe (iznajmljivanje dekora za priredbe); priredbe (održavanje priredbi); priredbe (organizovanje priredbi) [usluge

impresarija]; priredbe (proizvodnja priredbi); profesionalna orijentacija [savjeti u vezi obrazovanja ili osposobljavanja]; proizvodnja filmova; proizvodnja filmova na video-trakama; proizvodnja muzike; putujuće biblioteke (usluge putujućih biblioteka); radio televizijski programi (montaža radio televizijskih programa); radioaparati i televizori (iznajmljivanje radioaparata i televizora); radiofonija (razonoda putem radiofonije); razgovori (organizovanje i vođenje razgovora); razonoda; razonoda (informacije u vezi razonode); razonoda posredstvom radija; razonoda posredstvom televizije; rekreacija (obavještenja u vezi rekreacije); religiozno obrazovanje; reportaže (fotografske reportaže); reporterske usluge; rezervisanje mjesta za priredbe; ronjenje (iznajmljivanje ronilačke opreme); scenarijumi (izrada scenarijuma); seminari (organizovanje i vođenje seminara); simpozijumi (organizacija i vođenje simpozijuma); simpozijumi (organizovanje i vođenje simpozijuma); sinhronizacija; slobodno vrijeme (usluge za ispunjavanje slobodnog vremena); snimanje na videotrake; sportska oprema (stavljanje na raspolaganje sportske opreme); sportska takmičenja (mjerjenje vremena na sportskim takmičenjima); sportska takmičenja (organizovanje sportskih takmičenja); sportska usavršavanja (sportski kampovi za usavršavanje u sportu); sportske oprema (iznajmljivanje sportske opreme osim vozila); stadioni (iznajmljivanje stadiona); studio za snimanje (usluge studija za snimanje); tekstovi (objavljivanje tekstova) [osim u reklamne svrhe]; tekstovi (sastavljanje tekstova) [ne u reklamne svrhe]; televizija (razonoda na televiziji); televizijski programi (montaža radio i televizijskih programa); televizori (iznajmljivanje televizora i radioaparata); titlovanje filmova; treniranje [fizička vježba]; tumačenje govora pokreta; ulaznice za priredbe (agencije za ulaznice za priredbe) [razonoda]; videotrake (iznajmljivanje videotraka); videotrake (montaža videotraka); videotrake (proizvodnja filmova na videotrakama); videotrake (snimanje na videotrake); zabavni parkovi [cirkusi]; zdravstveni klubovi (usluge zdravstvenih klubova) [održavanje zdravlja i fizičke forme]; zoološki vrtovi [usluge zooloških vrtova]; zvučni snimci (iznajmljivanje zvučnih snimaka); životinje (kroćenje životinja) [dresiranje].

---

(210) **Ž-2021-24**

(220) 02.02.2021.

(731) ERSTE BANK AD Podgorica, Aresenija Boljevića 2a, 81000, Podgorica, ME

(540)

## Stigla sam! Ratka- kartica na rate Erste banke

(550) I

(511) Klasa 35: Agencije za komercijalne oglase; agencije za uvoz-izvoz; analiza proizvodne cijene; aukcionarstvo (prodaja na aukciji); automati (iznajmljivanje automata); cijene (poređenje cijena); daktilografske usluge; ekonomska predviđanja [prognoze]; fakturisanje; fotokopiranje (usluge fotokopiranja); hoteli (administrativno upravljanje hotelima); informacije (kancelarije za komercijalne informacije); informacije (poslovne informacije); informatičke kartoteke (vođenje informatičkih kartoteka); informatički podaci (pretraživanje podataka u informatičkoj kartoteci za treće lice); isporuka [distribucija] uzoraka; isporuka reklamnih materijala [letaka, prospekata, uzoraka]; isporuka reklamnih oglasa; isprave (umnožavanje isprava); istraživanja za poslove; istraživanje javnog mišljenja; istraživanje za poslove; izlozi (uređivanje izloga); izložbe (organizovanje izložbi) u komercijalne ili reklamne svrhe; iznajmljivanje automata za prodaju sitne robe; iznajmljivanje fotokopirnih uređaja; iznajmljivanje kancelarijskih mašina i aparata;



iznajmljivanje reklamnih prostora; iznajmljivanje reklamnog materijala; iznajmljivanje vremena za reklamiranje na svim komunikacionim sredstvima; izvodi iz računa (davanje izvoda sa računa); izvoz-uvoz (agencije za izvoz-uvoz); javno mnijenje (istraživanje javnog mnjenja) [anketiranje]; javnost (odnosi s javnošću) [propaganda]; kancelarije za reklamiranje; kancelarije za zapošljavanje; kancelarijski mašine i aparati (iznajmljivanje kancelarijskih mašina i aparata) \*; kartoteka (prikupljanje podataka u središnju kartoteku); kartoteka (sistemizovanje podataka za središnju kartoteku); knjige (vođenje knjiga); komercijalna administracija u vezi licenci proizvoda i usluga trećih lica; komercijalna ili industrijska preduzeća (pomoć u vođenju komercijalnih ili industrijskih preduzeća); konsultacije u vezi vođenje poslova; lociranje teretnih vagona pomoću kompjutera; manekeni (usluge manekena) za reklamiranje ili podsticaj prodaje; marketing; modne revije za promotivne svrhe (organizovanje); nabava za treće (usluge nabave za treće) [kupovina proizvoda i usluga za druga preduzeća]; nabava za treće osobe (usluge kupovine proizvoda i usluga za druga preduzeća); narudžbine (administrativna obrada narudžbina za kupovinu); novine (usluge pretplate novina) za treće osobe; objavljivanje reklamnih tekstova; odabir osoblja psihotehničkim postupkom; odnosi s javnošću [propaganda]; oglašavanje [reklamiranje]; oglašavanje putem pošte; organizovanje izložbi u komercijalne ili reklamne svrhe; organizovanje poslova (savjetovanje o organiziranju poslova); osoblje (biranje osoblja psihotehničkim postupkom); osoblje (savjetovanje o osoblju); osoblje (zapošljavanje osoblja); plakatiranje [oglašavanje]; platni listovi (izrada platnih listova); podsticaj prodaje za treće osobe; podugovaranje (usluge podugovaranja) [komercijalna pomoć]; pomoć u upravljanju industrijskim ili trgovačkim preduzećima; pomoć u vođenju poslova; porezne prijave (izrada poreznih prijava); poslovi (istraživanja za poslove); poslovi (istraživanje za poslove); poslovi (konsultacije za vođenja poslova); poslovi (obavještenja o poslovima); poslovi (pomoć u vođenju poslova); poslovi (savjetovanje o organizaciji i vođenju poslova); poslovi (vještačenje poslova) [ekspertize]; poslovne informacije; potrošači (pružanje komercijalnih savjeta i informacija potrošačima); predstavljanje proizvoda [demonstracija]; preduzeća (pomoć u vođenju komercijalnih ili industrijskih preduzeća); preduzeća (usluge preseljenja za preduzeća); prelamanje stranica u reklamne svrhe [stavljanje u štampu u reklamne svrhe]; prepis saopštenja; preseljavanje preduzeća (usluge preseljavanja preduzeća); pretplata na novine (usluge pretplate na novine) [za treće osobe]; pretplata na telekomunikacione usluge za treća lica; prezentacija proizvoda na svim komunikacionim sredstvima u svrhu prodaje na malo; procjene komercijalnih poslova; prodaja (podsticaj prodaje) za treće osobe; prodaja na aukciji; proizvodne cijene (analiza proizvodnih cijena); proučavanje tržišta [marketing]; provjera računa; psihotehnički odabir osoblja; računovodstveni poslovi; radio (reklamiranje putem radija); reklamiranje (iznajmljivanje prostora za potrebe reklamiranja); reklamiranje dopisnim putem; reklamiranje on-line na informatičkoj mreži; reklamiranje putem radija; reklamiranje putem televizije; reklamna dokumentacija (uređenje reklamne dokumentacije); reklamna pošta; reklamni fi lmovi (proizvodnja reklamnih fi lмова); reklamni materijal (iznajmljivanje reklamnog materijala); reklamni materijal (razdioba reklamnog materijala); reklamni materijal (raznošenje reklamnog materijala); reklamni oglasi (širenje reklamnih oglasa); reklamni tekstovi (objavljivanje reklamnih tekstova); reklamni tekstovi (uređenje reklamnih tekstova); sajmovi (organizovanje sajmova u komercijalne ili reklamne svrhe); saopštenja (prepisi, saopštenja); savjeti o organizaciji i vođenju poslova; savjetovanje (stručno savjetovanje o poslovima); savjetovanje o osoblju; sekretarske usluge (sekretarske usluge); sistemizovanje podataka za središnju kartoteku; sponzori (traženje sponzora); statistički podaci (izrada statističkih podataka); stenografske usluge; stručne poslovne konsultacije; štampa (praćenje štampe);

štampa (usluge pregleda štampe); tekst (obrada teksta); telefonski odgovori (usluge telefonskih odgovora) za odsutne pretplatnike; telekomunikacione usluge za treće lice (pretplata na telekomunikacione usluge za treće lice); telemarketing (usluge telemarketinga); televizijsko reklamiranje; teretni vagoni (lociranje teretnih vagona pomoću kompjutera); trgovački poslovi (procjene trgovačkih poslova); tržište (proučavanje tržišta); tržište (traženje tržišta); umjetnički poslovi (profesionalno upravljanje umjetničkim poslovima); umnožavanje isprava; uređenje izloga; uvoz-izvoz (agencije za uvoz-izvoz); uzorci (isporuka uzoraka); vođenje informatičkih kartoteka; vođenje knjiga; vođenje poslova (pomoć u vođenju poslova); vođenje poslova (savjetovanje o vođenju poslova); vođenje poslova (usluge savjetovanja u vezi vođenja poslova); vođenje poslova poslovni za sportiste [poslovni menadžment]; zapošljavanje (usluge kancelarije za zapošljavanje); zapošljavanje lica.

Klasa 36: Agencije za kredite; agencije za nekretnine; agencije za stanove [nepokretna imovina]; agencije za utjerivanje potraživanja; bankarske usluge, kućne; bankarski poslovi [transakcije]; bankovne transakcije (obavljanje bankovnih transakcija, kućne) [homebanking]; bolesničko osiguranje; carinske kancelarije [carinarski punktovi]; čekovi (ovjera čekova); depoziti dragocjenosti; dobrotvorne svrhe (skupljanje za dobrotvorne svrhe); dugovanje (službe za kartice dugovanja [debit kartice]); efektna berza [službeno bilježenje kurseva ugovorenih vrijednosti na tržištu]; financije (savjetovanje u vezi financija); finansijska analiza; finansijske procjene [osiguranje, banke, nekretnine]; finansijski [bankarski] poslovi; finansijski oglasi; finansijski poslovi [transakcije]; finansiranje (usluge finansiranja); fiskalne procjene; fondovi (osnivanje fondova); garancije [garancije]; građevinski objekti (upravljanje građevinskim objektima); imovina (upravljanje imovinom); informacije (finansijska obavještenja); informacije o osiguranju; izdavanje putnih čekova; izdavanje vrijednosnih bonova; iznajmljivanje kancelarija [nekretnine]; iznajmljivanje poljoprivrednih imanja; iznajmljivanje stanova; kapital (ulaganje kapitala); kompenzacijski poslovi [mijenjanje]; krediti; kreditne kartice (izdavanje kreditnih kartica); kreditne kartice (službe za kreditne kartice); likvidacija preduzeća (usluge likvidacije preduzeća); marke (procjena poštanskih maraka); mijenjanje novca (usluge mjenjačnica); monetarni poslovi; nakit (procjena nakita); naknada štete (finansijska procjena naknade štete); nekretnine (agencije za nekretnine); nekretnine (davanje u zakup nekretnina) [lizing]; nekretnine (procjena nekretnina); nekretnine (upravljanje nekretninama); nezgode (osiguranje od nezgoda); novčana sredstva (elektronski prijenos novčanih sredstava); numizmatička procjena; osiguranja; osiguranje (informacije o osiguranju); osiguranje (savjetovanje o osiguranju); osiguranje (usluge matematičkih stručnjaka [aktuara] za životno osiguranje); osnivanje kapitala; otplata na rate; ovjeravanje čekova; penzije (usluge blagajni za plaćanje penzija); pokroviteljstvo (finansijsko pokroviteljstvo); poljoprivredna imanja (iznajmljivanje poljoprivrednih imanja); pomorsko osiguranje; posredovanje [mešetarenje] \*; posredovanje [mešetarenje] u trgovini nekretninama; posredovanje na berzi; posredovanje na berzi [mešetarenje]; posredovanje u nekretninama; posredovanje u osiguranju; potraživanja (utjerivanje potraživanja jednog preduzeća posredstvom spoljnog nagodbenog tijela) [faktoring]; povjereničke službe; pozajmljivanje na temelju zaloga; požar (osiguranje od požara); prijenos elektronskim putem novčanih sredstava; procjena maraka; procjena nakita; procjena nekretnina; procjena stabala u šumi; procjena starina [antikviteta]; procjena umjetnina; procjena vune [finansijska procjena vune]; procjene (fiskalne procjene); procjene (numizmatičke procjene); procjene finansijske procjene [osiguranje, bankarski promet, imovina]; putni čekovi (izdavanje putnih čekova); savjetovanje o finansijskim pitanjima; savjetovanje o osiguranju; sigurnosne blagajne [sefovi] (odlaganje u sigurnosne blagajne);

skupljanje priloga; skupljanje za dobrotvorne svrhe; sredstva (stvaranje zajedničkih sredstava); stabla u šumi (procjena stabala u šumi); stanarine (naplata stanarina); stanovi (iznajmljivanje stanova); starine (procjena starina); štedionice [usluge štedionica]; transakcije (finansijske transakcije); ulaganje sredstava; umjetnička djela (procjena umjetničkih djela); upravljanje građevinskim objektima; upravljanje imovinom; upravljanje nekretninama; usluge depozita u sefovima; usluge fondova uzajamne pomoći; utjerivanje dugovanja (agencije za utjerivanje dugovanja); vrijednosni bonovi (izdavanje vrijednosnih bonova); vrijednosti (depoziti vrijednosti); zajam na temelju zaloga; zajmovi; zakup [vrsta iznajmljivanja dobara za profesionalne potrebe, koja temeljem ugovora mogu postati vlasništvo iznajmitelja] [lizing]; zakup nekretnina (davanje u zakup nekretnina) [lizing]; zalog (davanje zajma uz zalog); životno osiguranje (potpisivanje polisa za osiguranje života).

Klasa 41: Agencije za modele za slikare i vajara; akademije [obuka]; cirkusi; cirkusi [zabavni parkovi]; dekor za priredbe (iznajmljivanje dekora za priredbe); digitalne slike (usluge digitalnog snimanja); disk džokeji (usluge disk džokeja) usluge; diskoteke (usluge diskoteka); dopisivanje (obuka putem dopisivanja); elektronske publikacije (iskorištavanje elektronskih publikacija koje se ne mogu prenositi on-line); filmovi (prikazivanje igranih filmova); filmovi (proizvodnja filmova); fitnes časovi (vođenje fitnes časova); fizičke vježbe [fizička kultura]; fotografi sanje; fotografske reportaže; gimnastičarska obuka; golf (stavljavanje na raspolaganje igrališta za golf); govor pokreta (tumačenje govora pokreta); govor pokretima (tumačenje govora pokretima); igre (usluge hala i dvorana za igre); igre (usluge igara) pružene on-line [s jedne informatičke mreže]; igre za novac; informacije o obrazovanju; informacije o razonodi; informacije u vezi rekreacije; izdavanje knjiga; izložbe (organizovanje izložbi) u kulturne ili obrazovne svrhe; iznajmljivanje audio uređaja; iznajmljivanje dekora za priredbe; iznajmljivanje igrački; iznajmljivanje kinematografskih filmova; iznajmljivanje kinoaparature i pribora; iznajmljivanje magnetoskopa; iznajmljivanje opreme za igranje; iznajmljivanje radio i televizijskih aparata; iznajmljivanje rasvjetnih uređaja za pozorišnu dekoraciju i za televizijske studije; iznajmljivanje ronilačke opreme; iznajmljivanje sportske opreme [osim vozila]; iznajmljivanje sportskih terena; iznajmljivanje stadiona; iznajmljivanje teniskih igrališta; iznajmljivanje videokamera; iznajmljivanje videotraka; iznajmljivanje zvučnih snimaka; javni konkursi (organizovanje javnih konkursa) [obuka ili zabava]; kaligrafija (usluge kaligrafije); kampovi za ljetovanje (usluge kampova za ljetovanje) [zabava]; kampovi za sportsko usavršavanje; karaoke (stavljavanje na raspolaganje opreme za karaoke); kinematografski filmovi (iznajmljivanje kinematografskih filmova); kino sale (iskorištavanje kinodvorana); kino studiji; kinoaparatura (iznajmljivanje kinoaparature i pribora); klubovi (usluge klubova) [zabava ili obrazovanje]; knjige (izdavanje knjiga); knjige (posuđivanje knjiga); kockarnice [igre] (usluge kockarnica); komponovanje muzike; komponovanje muzike (usluge komponovanja muzike); koncerti (organizovanje i vođenje koncerata); konferencije (organizovanje i vođenje konferencija); kongresi (organizovanje i vođenje kongresa); kročenje životinja [dresiranje]; lični treneri (usluge ličnih trenera) [fitnes]; lutrija (organizovanje lutrije); ljetovanje (usluge kampova za ljetovanje) [razonoda]; magnetoskopi (iznajmljivanje magnetoskopa); mikrofoni (snimanje na mikrofilmove); mikroizdavaštvo; mjerenje vremena na sportskim takmičenjima; modne revije za zabavne svrhe (organizovanje); montaža radio i televizijskih programa; muzejske usluge [predstavljanje, izložbe]; muzičke sale; noćni klubovi; objavljivanje knjiga i časopisa, elektronski on line; objavljivanje tekstova [osim u reklamne svrhe]; obrazovanje (informacije o obrazovanju); obrazovanje [obuka]; obrazovni zavodi [internati]; obuka; obuka [predavanje]; obuka putem dopisivanja; obuka za predškolski uzrast; organizovanje i vođenje koncerata; organizovanje i vođenje konferencija; organizovanje i vođenje kongresa;

organizovanje i vođenje radionica za stručno osposobljavanje; organizovanje i vođenje razgovora; organizovanje i vođenje seminara; organizovanje izložba u kulturne i obrazovne svrhe; organizovanje javnih konkursa [obrazovanje ili razonoda]; organizovanje konkursa ljepote; organizovanje plesova; organizovanje spektakla [usluge impresarija]; organizovanje sportskih takmičenja; orkestri (usluge orkestra); pedagoški eksperimenti; pisanje tekstova [ne u reklamne svrhe]; planiranje prijema [razonoda]; posuđivanje knjiga; pozorišne predstave; pozorišni dekor (iznajmljivanje pozorišnog dekora); pozorišni glumci (usluge pozorišnih glumaca); pozorišni preduzetnici [impresariji] (usluge pozorišnih preduzetnika); praktična obuka [demonstriranje]; predškolska obuka; prekvalifikacija (usluge prekvalifikacije); prelamanje slogova [ne u reklamne svrhe]; prevodilačke usluge; prevodioci (usluge prevođenja); prijemi (planiranje prijema) [razonoda]; priredbe (iznajmljivanje dekora za priredbe); priredbe (održavanje priredbi); priredbe (organizovanje priredbi) [usluge impresarija]; priredbe (proizvodnja priredbi); profesionalna orijentacija [savjeti u vezi obrazovanja ili osposobljavanja]; proizvodnja filmova; proizvodnja filmova na video-trakama; proizvodnja muzike; putujuće biblioteke (usluge putujućih biblioteka); radio televizijski programi (montaža radio televizijskih programa); radioaparati i televizori (iznajmljivanje radioaparata i televizora); radiofonija (razonoda putem radiofonije); razgovori (organizovanje i vođenje razgovora); razonoda; razonoda (informacije u vezi razonode); razonoda posredstvom radija; razonoda posredstvom televizije; rekreacija (obavještenja u vezi rekreacije); religiozno obrazovanje; reportaže (fotografske reportaže); reporterske usluge; rezervisanje mjesta za priredbe; ronjenje (iznajmljivanje ronilačke opreme); scenarijumi (izrada scenarijuma); seminari (organizovanje i vođenje seminara); simpozijumi (organizacija i vođenje simpozijuma); simpozijumi (organizovanje i vođenje simpozijuma); sinhronizacija; slobodno vrijeme (usluge za ispunjavanje slobodnog vremena); snimanje na videotrake; sportska oprema (stavljanje na raspolaganje sportske opreme); sportska takmičenja (mjerenje vremena na sportskim takmičenjima); sportska takmičenja (organizovanje sportskih takmičenja); sportska usavršavanja (sportski kampovi za usavršavanje u sportu); sportske oprema (iznajmljivanje sportske opreme osim vozila); stadioni (iznajmljivanje stadiona); studio za snimanje (usluge studija za snimanje); tekstovi (objavljivanje tekstova) [osim u reklamne svrhe]; tekstovi (sastavljanje tekstova) [ne u reklamne svrhe]; televizija (razonoda na televiziji); televizijski programi (montaža radio i televizijskih programa); televizori (iznajmljivanje televizora i radioaparata); titlovanje filmova; treniranje [fizička vježba]; tumačenje govora pokreta; ulaznice za priredbe (agencije za ulaznice za priredbe) [razonoda]; videotrake (iznajmljivanje videotraka); videotrake (montaža videotraka); videotrake (proizvodnja filmova na videotrakama); videotrake (snimanje na videotrake); zabavni parkovi [cirkusi]; zdravstveni klubovi (usluge zdravstvenih klubova) [održavanje zdravlja i fizičke forme]; zoološki vrtovi [usluge zooloških vrtova]; zvučni snimci (iznajmljivanje zvučnih snimaka); životinje (kroćenje životinja) [dresiranje].

---

(210) **Ž-2021-25**

(220) 02.02.2021.

(731) ERSTE BANK AD Podgorica, Aresenija Boljevića 2a, 81000, Podgorica, ME

(540)

Stigla je! Ratka- kartica na rate Erste banke

(550) I

(511) Klasa 35: Agencije za komercijalne oglase; agencije za uvoz-izvoz; analiza proizvodne cijene; aukcionarstvo (prodaja na aukciji); automati (iznajmljivanje automata); cijene (poređenje cijena); daktilografske usluge; ekonomska predviđanja [prognoze]; fakturisanje; fotokopiranje (usluge fotokopiranja); hoteli (administrativno upravljanje hotelima); informacije (kancelarije za komercijalne informacije); informacije (poslovne informacije); informatičke kartoteke (vođenje informatičkih kartoteka); informatički podaci (pretraživanje podataka u informatičkoj kartoteci za treće lice); isporuka [distribucija] uzoraka; isporuka reklamnih materijala [letaka, prospekata, uzoraka]; isporuka reklamnih oglasa; isprave (umnožavanje isprava); istraživanja za poslove; istraživanje javnog mišljenja; istraživanje za poslove; izlozi (uređivanje izloga); izložbe (organizovanje izložbi) u komercijalne ili reklamne svrhe; iznajmljivanje automata za prodaju sitne robe; iznajmljivanje fotokopirnih uređaja; iznajmljivanje kancelarijskih mašina i aparata; iznajmljivanje reklamnih prostora; iznajmljivanje reklamnog materijala; iznajmljivanje vremena za reklamiranje na svim komunikacionim sredstvima; izvodi iz računa (davanje izvoda sa računa); izvoz-uvoz (agencije za izvoz-uvoz); javno mnijenje (istraživanje javnog mnjenja) [anketiranje]; javnost (odnosi s javnošću) [propaganda]; kancelarije za reklamiranje; kancelarije za zapošljavanje; kancelarijski mašine i aparati (iznajmljivanje kancelarijskih mašina i aparata) \*; kartoteka (prikupljanje podataka u središnju kartoteku); kartoteka (sistemizovanje podataka za središnju kartoteku); knjige (vođenje knjiga); komercijalna administracija u vezi licenci proizvoda i usluga trećih lica; komercijalna ili industrijska preduzeća (pomoć u vođenju komercijalnih ili industrijskih preduzeća); konsultacije u vezi vođenje poslova; lociranje teretnih vagona pomoću kompjutera; manekeni (usluge manekena) za reklamiranje ili podsticaj prodaje; marketing; modne revije za promotivne svrhe (organizovanje); nabava za treće (usluge nabave za treće) [kupovina proizvoda i usluga za druga preduzeća]; nabava za treće osobe (usluge kupovine proizvoda i usluga za druga preduzeća); narudžbine (administrativna obrada narudžbina za kupovinu); novine (usluge pretplate novina) za treće osobe; objavljivanje reklamnih tekstova; odabir osoblja psihotehničkim postupkom; odnosi s javnošću [propaganda]; oglašavanje [reklamiranje]; oglašavanje putem pošte; organizovanje izložbi u komercijalne ili reklamne svrhe; organizovanje poslova (savjetovanje o organiziranju poslova); osoblje (biranje osoblja psihotehničkim postupkom); osoblje (savjetovanje o osoblju); osoblje (zapošljavanje osoblja); plakatiranje [oglašavanje]; platni listovi (izrada platnih listova); podsticaj prodaje za treće osobe; podugovaranje (usluge podugovaranja) [komercijalna pomoć]; pomoć u upravljanju industrijskim ili trgovačkim preduzećima; pomoć u vođenju poslova; porezne prijave (izrada poreznih prijava); poslovi (istraživanja za poslove); poslovi (istraživanje za poslove); poslovi (konsultacije za vođenja poslova); poslovi (obavještenja o poslovima); poslovi (pomoć u vođenju poslova); poslovi (savjetovanje o organizaciji i vođenju poslova); poslovi (vještačenje poslova) [ekspertize]; poslovne informacije; potrošači (pružanje komercijalnih savjeta i informacija potrošačima); predstavljanje proizvoda [demonstracija]; preduzeća (pomoć u vođenju komercijalnih ili industrijskih preduzeća); preduzeća (usluge preseljenja za preduzeća); prelamanje stranica u reklamne svrhe [stavljanje u štampu u reklamne svrhe]; prepis saopštenja; preseljavanje preduzeća (usluge preseljavanja preduzeća); pretplata na novine (usluge pretplate na novine) [za treće osobe]; pretplata na telekomunikacione usluge za treća lica; prezentacija proizvoda na svim komunikacionim sredstvima u svrhu prodaje na malo; procjene komercijalnih poslova; prodaja (podsticaj prodaje) za treće osobe; prodaja na aukciji; proizvodne cijene (analiza proizvodnih cijena); proučavanje tržišta [marketing]; provjera računa; psihotehnički odabir osoblja; računovodstveni poslovi; radio (reklamiranje putem radija); reklamiranje (iznajmljivanje

prostora za potrebe reklamiranja); reklamiranje dopisnim putem; reklamiranje on-line na informatičkoj mreži; reklamiranje putem radija; reklamiranje putem televizije; reklamna dokumentacija (uređenje reklamne dokumentacije); reklamna pošta; reklamni fi lmovi (proizvodnja reklamnih fi lмова); reklamni materijal (iznajmljivanje reklamnog materijala); reklamni materijal (razdioba reklamnog materijala); reklamni materijal (raznošenje reklamnog materijala); reklamni oglasi (širenje reklamnih oglasa); reklamni tekstovi (objavljivanje reklamnih tekstova); reklamni tekstovi (uređenje reklamnih tekstova); sajmovi (organizovanje sajmova u komercijalne ili reklamne svrhe); saopštenja (prepisi, saopštenja); savjeti o organizaciji i vođenju poslova; savjetovanje (stručno savjetovanje o poslovima); savjetovanje o osoblju; sekretarske usluge (sekretarske usluge); sistematizovanje podataka za središnju kartoteku; sponzori (traženje sponzora); statistički podaci (izrada statističkih podataka); stenografske usluge; stručne poslovne konsultacije; štampa (praćenje štampe); štampa (usluge pregleda štampe); tekst (obrada teksta); telefonski odgovori (usluge telefonskih odgovora) za odsutne pretplatnike; telekomunikacione usluge za treće lice (pretplata na telekomunikacione usluge za treće lice); telemarketing (usluge telemarketinga); televizijsko reklamiranje; teretni vagoni (lociranje teretnih vagona pomoću kompjutera); trgovački poslovi (procjene trgovačkih poslova); tržište (proučavanje tržišta); tržište (traženje tržišta); umjetnički poslovi (profesionalno upravljanje umjetničkim poslovima); umnožavanje isprava; uređenje izloga; uvoz-izvoz (agencije za uvoz-izvoz); uzorci (isporuka uzoraka); vođenje informatičkih kartoteka; vođenje knjiga; vođenje poslova (pomoć u vođenju poslova); vođenje poslova (savjetovanje o vođenju poslova); vođenje poslova (usluge savjetovanja u vezi vođenja poslova); vođenje poslova poslovni za sportiste [poslovni menadžment]; zapošljavanje (usluge kancelarije za zapošljavanje); zapošljavanje lica.

Klasa 36: Agencije za kredite; agencije za nekretnine; agencije za stanove [nepokretna imovina]; agencije za utjerivanje potraživanja; bankarske usluge, kućne; bankarski poslovi [transakcije]; bankovne transakcije (obavljanje bankovnih transakcija, kućne) [homebanking]; bolesničko osiguranje; carinske kancelarije [carinarski punktovi]; čekovi (ovjera čekova); depoziti dragocjenosti; dobrotvorne svrhe (skupljanje za dobrotvorne svrhe); dugovanje (službe za kartice dugovanja [debit kartice]); efektna berza [službeno bilježenje kurseva ugovorenih vrijednosti na tržištu]; financije (savjetovanje u vezi financija); finansijska analiza; finansijske procjene [osiguranje, banke, nekretnine]; finansijski [bankarski] poslovi; finansijski oglasi; finansijski poslovi [transakcije]; finansiranje (usluge finansiranja); fiskalne procjene; fondovi (osnivanje fondova); garancije [garancije]; građevinski objekti (upravljanje građevinskim objektima); imovina (upravljanje imovinom); informacije (finansijska obavještenja); informacije o osiguranju; izdavanje putnih čekova; izdavanje vrijednosnih bonova; iznajmljivanje kancelarija [nekretnine]; iznajmljivanje poljoprivrednih imanja; iznajmljivanje stanova; kapital (ulaganje kapitala); kompenzacijski poslovi [mijenjanje]; krediti; kreditne kartice (izdavanje kreditnih kartica); kreditne kartice (službe za kreditne kartice); likvidacija preduzeća (usluge likvidacije preduzeća); marke (procjena poštanskih maraka); mijenjanje novca (usluge mjenjačnica); monetarni poslovi; nakit (procjena nakita); naknada štete (finansijska procjena naknade štete); nekretnine (agencije za nekretnine); nekretnine (davanje u zakup nekretnina) [lizing]; nekretnine (procjena nekretnina); nekretnine (upravljanje nekretninama); nezgode (osiguranje od nezgoda); novčana sredstva (elektronski prijenos novčanih sredstava); numizmatička procjena; osiguranja; osiguranje (informacije o osiguranju); osiguranje (savjetovanje o osiguranju); osiguranje (usluge matematičkih stručnjaka [aktuara] za životno osiguranje); osnivanje kapitala; otplata na rate; ovjeravanje čekova; penzije (usluge blagajni za plaćanje

penzija); pokroviteljstvo (finansijsko pokroviteljstvo); poljoprivredna imanja (iznajmljivanje poljoprivrednih imanja); pomorsko osiguranje; posredovanje [mešetarenje] \*; posredovanje [mešetarenje] u trgovini nekretninama; posredovanje na berzi; posredovanje na berzi [mešetarenje]; posredovanje u nekretninama; posredovanje u osiguranju; potraživanja (utjerivanje potraživanja jednog preduzeća posredstvom spoljnog nagodbenog tijela) [faktoring]; povjereničke službe; pozajmljivanje na temelju zalogu; požar (osiguranje od požara); prijenos elektronskim putem novčanih sredstava; procjena maraka; procjena nakita; procjena nekretnina; procjena stabala u šumi; procjena starina [antikviteta]; procjena umjetnina; procjena vune [finansijska procjena vune]; procjene (fiskalne procjene); procjene (numizmatičke procjene); procjene finansijske procjene [osiguranje, bankarski promet, imovina]; putni čekovi (izdavanje putnih čekova); savjetovanje o finansijskim pitanjima; savjetovanje o osiguranju; sigurnosne blagajne [sefovi] (odlaganje u sigurnosne blagajne); skupljanje priloga; skupljanje za dobrotvorne svrhe; sredstva (stvaranje zajedničkih sredstava); stabla u šumi (procjena stabala u šumi); stanarine (naplata stanarina); stanovi (iznajmljivanje stanova); starine (procjena starina); štedionice [usluge štedionica]; transakcije (finansijske transakcije); ulaganje sredstava; umjetnička djela (procjena umjetničkih djela); upravljanje građevinskim objektima; upravljanje imovinom; upravljanje nekretninama; usluge depozita u sefovima; usluge fondova uzajamne pomoći; utjerivanje dugovanja (agencije za utjerivanje dugovanja); vrijednosni bonovi (izdavanje vrijednosnih bonova); vrijednosti (depoziti vrijednosti); zajam na temelju zalogu; zajmovi; zakup [vrsta iznajmljivanja dobara za profesionalne potrebe, koja temeljem ugovora mogu postati vlasništvo iznajmitelja] [lizing]; zakup nekretnina (davanje u zakup nekretnina) [lizing]; zalog (davanje zajma uz zalog); životno osiguranje (potpisivanje polisa za osiguranje života).

Klasa 41: Agencije za modele za slikare i vajara; akademije [obuka]; cirkusi; cirkusi [zabavni parkovi]; dekor za priredbe (iznajmljivanje dekora za priredbe); digitalne slike (usluge digitalnog snimanja); disk džokeji (usluge disk džokeja) usluge; diskoteke (usluge diskoteka); dopisivanje (obuka putem dopisivanja); elektronske publikacije (iskorištavanje elektronskih publikacija koje se ne mogu prenositi on-line); filmovi (prikazivanje igranih filmova); filmovi (proizvodnja filmova); fitnes časovi (vođenje fitnes časova); fizičke vježbe [fizička kultura]; fotografi sanje; fotografske reportaže; gimnastičarska obuka; golf (stavljanje na raspolaganje igrališta za golf); govor pokreta (tumačenje govora pokreta); govor pokretima (tumačenje govora pokretima); igre (usluge hala i dvorana za igre); igre (usluge igara) pružene on-line [s jedne informatičke mreže]; igre za novac; informacije o obrazovanju; informacije o razonodi; informacije u vezi rekreacije; izdavanje knjiga; izložbe (organizovanje izložbi) u kulturne ili obrazovne svrhe; iznajmljivanje audio uređaja; iznajmljivanje dekora za priredbe; iznajmljivanje igrački; iznajmljivanje kinematografskih filmova; iznajmljivanje kinoaparature i pribora; iznajmljivanje magnetoskopa; iznajmljivanje opreme za igranje; iznajmljivanje radio i televizijskih aparata; iznajmljivanje rasvjetnih uređaja za pozorišnu dekoraciju i za televizijske studije; iznajmljivanje ronilačke opreme; iznajmljivanje sportske opreme [osim vozila]; iznajmljivanje sportskih terena; iznajmljivanje stadiona; iznajmljivanje teniskih igrališta; iznajmljivanje videokamera; iznajmljivanje videotraka; iznajmljivanje zvučnih snimaka; javni konkursi (organizovanje javnih konkursa) [obuka ili zabava]; kaligrafija (usluge kaligrafije); kampovi za ljetovanje (usluge kampova za ljetovanje) [zabava]; kampovi za sportsko usavršavanje; karaoke (stavljanje na raspolaganje opreme za karaoke); kinematografski filmovi (iznajmljivanje kinematografskih filmova); kino sale (iskorištavanje kinodvorana); kino studiji; kinoaparatura (iznajmljivanje kinoaparature i pribora); klubovi (usluge klubova) [zabava ili obrazovanje]; knjige (izdavanje knjiga); knjige (posuđivanje knjiga); kockarnice [igre] (usluge kockarnica); komponovanje muzike;

komponovanje muzike (usluge komponovanja muzike); koncerti (organizovanje i vođenje koncerata); konferencije (organizovanje i vođenje konferencija); kongresi (organizovanje i vođenje kongresa); kroćenje životinja [dresiranje]; lični treneri (usluge ličnih trenera) [fitnes]; lutrija (organizovanje lutrije); ljetovanje (usluge kampova za ljetovanje) [razonoda]; magnetoskopi (iznajmljivanje magnetoskopa); mikrofoni (snimanje na mikrofilmovima); mikroizdavaštvo; mjerenje vremena na sportskim takmičenjima; modne revije za zabavne svrhe (organizovanje); montaža radio i televizijskih programa; muzejske usluge [predstavljanje, izložbe]; muzičke sale; noćni klubovi; objavljivanje knjiga i časopisa, elektronski on line; objavljivanje tekstova [osim u reklamne svrhe]; obrazovanje (informacije o obrazovanju); obrazovanje [obuka]; obrazovni zavodi [internati]; obuka; obuka [predavanje]; obuka putem dopisivanja; obuka za predškolski uzrast; organizovanje i vođenje koncerata; organizovanje i vođenje konferencija; organizovanje i vođenje kongresa; organizovanje i vođenje radionica za stručno osposobljavanje; organizovanje i vođenje razgovora; organizovanje i vođenje seminara; organizovanje izložba u kulturne i obrazovne svrhe; organizovanje javnih konkursa [obrazovanje ili razonoda]; organizovanje konkursa ljepote; organizovanje plesova; organizovanje spektakla [usluge impresarija]; organizovanje sportskih takmičenja; orkestri (usluge orkestra); pedagoški eksperimenti; pisanje tekstova [ne u reklamne svrhe]; planiranje prijema [razonoda]; posuđivanje knjiga; pozorišne predstave; pozorišni dekor (iznajmljivanje pozorišnog dekora); pozorišni glumci (usluge pozorišnih glumaca); pozorišni preduzetnici [impresariji] (usluge pozorišnih preduzetnika); praktična obuka [demonstriranje]; predškolska obuka; prekvalifikacija (usluge prekvalifikacije); prelamanje slogova [ne u reklamne svrhe]; prevodilačke usluge; prevodioci (usluge prevođenja); prijemi (planiranje prijema) [razonoda]; priredbe (iznajmljivanje dekora za priredbe); priredbe (održavanje priredbi); priredbe (organizovanje priredbi) [usluge impresarija]; priredbe (proizvodnja priredbi); profesionalna orijentacija [savjeti u vezi obrazovanja ili osposobljavanja]; proizvodnja filmova; proizvodnja filmova na video-trakama; proizvodnja muzike; putujuće biblioteke (usluge putujućih biblioteka); radio televizijski programi (montaža radio televizijskih programa); radioaparati i televizori (iznajmljivanje radioaparata i televizora); radiofonija (razonoda putem radiofonije); razgovori (organizovanje i vođenje razgovora); razonoda; razonoda (informacije u vezi razonode); razonoda posredstvom radija; razonoda posredstvom televizije; rekreacija (obavještenja u vezi rekreacije); religiozno obrazovanje; reportaže (fotografske reportaže); reporterske usluge; rezervisanje mjesta za priredbe; ronjenje (iznajmljivanje ronilačke opreme); scenarijumi (izrada scenarijuma); seminari (organizovanje i vođenje seminara); simpozijumi (organizacija i vođenje simpozijuma); simpozijumi (organizovanje i vođenje simpozijuma); sinhronizacija; slobodno vrijeme (usluge za ispunjavanje slobodnog vremena); snimanje na videotrake; sportska oprema (stavljanje na raspolaganje sportske opreme); sportska takmičenja (mjerenje vremena na sportskim takmičenjima); sportska takmičenja (organizovanje sportskih takmičenja); sportska usavršavanja (sportski kampovi za usavršavanje u sportu); sportske oprema (iznajmljivanje sportske opreme osim vozila); stadioni (iznajmljivanje stadiona); studio za snimanje (usluge studija za snimanje); tekstovi (objavljivanje tekstova) [osim u reklamne svrhe]; tekstovi (sastavljanje tekstova) [ne u reklamne svrhe]; televizija (razonoda na televiziji); televizijski programi (montaža radio i televizijskih programa); televizori (iznajmljivanje televizora i radioaparata); titlovanje filmova; treniranje [fizička vježba]; tumačenje govora pokreta; ulaznice za priredbe (agencije za ulaznice za priredbe) [razonoda]; videotrake (iznajmljivanje videotraka); videotrake (montaža videotraka); videotrake (proizvodnja filmova na videotrakama); videotrake (snimanje na videotrake); zabavni parkovi [cirkusi]; zdravstveni klubovi (usluge zdravstvenih



klubova) [održavanje zdravlja i fizičke forme]; zoološki vrtovi [usluge zooloških vrtova]; zvučni snimci (iznajmljivanje zvučnih snimaka); životinje (kroćenje životinja) [dresiranje].

---

(210) **Ž-2021-26**

(220) 02.02.2021.

(731) ERSTE BANK AD Podgorica, Aresenija Boljevića 2a, 81000, Podgorica, ME

(540)

Karticu provuci, nagradu izvuci! Velika Erste nagradna igra

(550) I

(511) Klasa 35: Agencije za komercijalne oglase; agencije za uvoz-izvoz; analiza proizvodne cijene; aukcionarstvo (prodaja na aukciji); automati (iznajmljivanje automata); cijene (poređenje cijena); daktilografske usluge; ekonomska predviđanja [prognoze]; fakturisanje; fotokopiranje (usluge fotokopiranja); hoteli (administrativno upravljanje hotelima); informacije (kancelarije za komercijalne informacije); informacije (poslovne informacije); informatičke kartoteke (vođenje informatičkih kartoteka); informatički podaci (pretraživanje podataka u informatičkoj kartoteci za treće lice); isporuka [distribucija] uzoraka; isporuka reklamnih materijala [letaka, prospekata, uzoraka]; isporuka reklamnih oglasa; isprave (umnožavanje isprava); istraživanja za poslove; istraživanje javnog mišljenja; istraživanje za poslove; izlozi (uređivanje izloga); izložbe (organizovanje izložbi) u komercijalne ili reklamne svrhe; iznajmljivanje automata za prodaju sitne robe; iznajmljivanje fotokopirnih uređaja; iznajmljivanje kancelarijskih mašina i aparata; iznajmljivanje reklamnih prostora; iznajmljivanje reklamnog materijala; iznajmljivanje vremena za reklamiranje na svim komunikacionim sredstvima; izvodi iz računa (davanje izvoda sa računa); izvoz-uvoz (agencije za izvoz-uvoz); javno mnijenje (istraživanje javnog mnjenja) [anketiranje]; javnost (odnosi s javnošću) [propaganda]; kancelarije za reklamiranje; kancelarije za zapošljavanje; kancelarijski mašine i aparati (iznajmljivanje kancelarijskih mašina i aparata) \*; kartoteka (prikupljanje podataka u središnju kartoteku); kartoteka (sistemizovanje podataka za središnju kartoteku); knjige (vođenje knjiga); komercijalna administracija u vezi licenci proizvoda i usluga trećih lica; komercijalna ili industrijska preduzeća (pomoć u vođenju komercijalnih ili industrijskih preduzeća); konsultacije u vezi vođenje poslova; lociranje teretnih vagona pomoću kompjutera; manekeni (usluge manekena) za reklamiranje ili podsticaj prodaje; marketing; modne revije za promotivne svrhe (organizovanje); nabava za treće (usluge nabave za treće) [kupovina proizvoda i usluga za druga preduzeća]; nabava za treće osobe (usluge kupovine proizvoda i usluga za druga preduzeća); narudžbine (administrativna obrada narudžbina za kupovinu); novine (usluge pretplate novina) za treće osobe; objavljivanje reklamnih tekstova; odabir osoblja psihotehničkim postupkom; odnosi s javnošću [propaganda]; oglašavanje [reklamiranje]; oglašavanje putem pošte; organizovanje izložbi u komercijalne ili reklamne svrhe; organizovanje poslova (savjetovanje o organiziranju poslova); osoblje (biranje osoblja psihotehničkim postupkom); osoblje (savjetovanje o osoblju); osoblje (zapošljavanje osoblja); plakatiranje [oglašavanje]; platni listovi (izrada platnih listova); podsticaj prodaje za treće osobe; podugovaranje (usluge podugovaranja) [komercijalna pomoć]; pomoć u

upravljanju industrijskim ili trgovačkim preduzećima; pomoć u vođenju poslova; porezne prijave (izrada poreznih prijava); poslovi (istraživanja za poslove); poslovi (istraživanje za poslove); poslovi (konsultacije za vođenja poslova); poslovi (obavještenja o poslovima); poslovi (pomoć u vođenju poslova); poslovi (savjetovanje o organizaciji i vođenju poslova); poslovi (vještačenje poslova) [ekspertize]; poslovne informacije; potrošači (pružanje komercijalnih savjeta i informacija potrošačima); predstavljanje proizvoda [demonstracija]; preduzeća (pomoć u vođenju komercijalnih ili industrijskih preduzeća); preduzeća (usluge preseljenja za preduzeća); prelamanje stranica u reklamne svrhe [stavljanje u štampu u reklamne svrhe]; prepis saopštenja; preseljavanje preduzeća (usluge preseljavanja preduzeća); pretplata na novine (usluge pretplate na novine) [za treće osobe]; pretplata na telekomunikacione usluge za treća lica; prezentacija proizvoda na svim komunikacionim sredstvima u svrhu prodaje na malo; procjene komercijalnih poslova; prodaja (podsticaj prodaje) za treće osobe; prodaja na aukciji; proizvodne cijene (analiza proizvodnih cijena); proučavanje tržišta [marketing]; provjera računa; psihotehnički odabir osoblja; računovodstveni poslovi; radio (reklamiranje putem radija); reklamiranje (iznajmljivanje prostora za potrebe reklamiranja); reklamiranje dopisnim putem; reklamiranje on-line na informatičkoj mreži; reklamiranje putem radija; reklamiranje putem televizije; reklamna dokumentacija (uređenje reklamne dokumentacije); reklamna pošta; reklamni fi lmovi (proizvodnja reklamnih fi lмова); reklamni materijal (iznajmljivanje reklamnog materijala); reklamni materijal (razdioba reklamnog materijala); reklamni materijal (raznošenje reklamnog materijala); reklamni oglasi (širenje reklamnih oglasa); reklamni tekstovi (objavljivanje reklamnih tekstova); reklamni tekstovi (uređenje reklamnih tekstova); sajmovi (organizovanje sajmova u komercijalne ili reklamne svrhe); saopštenja (prepisi, saopštenja); savjeti o organizaciji i vođenju poslova; savjetovanje (stručno savjetovanje o poslovima); savjetovanje o osoblju; sekretarske usluge (sekretarske usluge); sistematizovanje podataka za središnju kartoteku; sponzori (traženje sponzora); statistički podaci (izrada statističkih podataka); stenografske usluge; stručne poslovne konsultacije; štampa (praćenje štampe); štampa (usluge pregleda štampe); tekst (obrada teksta); telefonski odgovori (usluge telefonskih odgovora) za odsutne pretplatnike; telekomunikacione usluge za treće lica (pretplata na telekomunikacione usluge za treće lica); telemarketing (usluge telemarketinga); televizijsko reklamiranje; teretni vagoni (lociranje teretnih vagona pomoću kompjutera); trgovački poslovi (procjene trgovačkih poslova); tržište (proučavanje tržišta); tržište (traženje tržišta); umjetnički poslovi (profesionalno upravljanje umjetničkim poslovima); umnožavanje isprava; uređenje izloga; uvoz-izvoz (agencije za uvoz-izvoz); uzorci (isporuka uzoraka); vođenje informatičkih kartoteka; vođenje knjiga; vođenje poslova (pomoć u vođenju poslova); vođenje poslova (savjetovanje o vođenju poslova); vođenje poslova (usluge savjetovanja u vezi vođenja poslova); vođenje poslova poslovni za sportiste [poslovni menadžment]; zapošljavanje (usluge kancelarije za zapošljavanje); zapošljavanje lica.

Klasa 36: Agencije za kredite; agencije za nekretnine; agencije za stanove [nepokretna imovina]; agencije za utjerivanje potraživanja; bankarske usluge, kućne; bankarski poslovi [transakcije]; bankovne transakcije (obavljanje bankovnih transakcija, kućne) [homebanking]; bolesničko osiguranje; carinske kancelarije [carinarski punktovi]; čekovi (ovjera čekova); depoziti dragocjenosti; dobrotvorne svrhe (skupljanje za dobrotvorne svrhe); dugovanje (službe za kartice dugovanja [debit kartice]); efektna berza [službeno bilježenje kurseva ugovorenih vrijednosti na tržištu]; financije (savjetovanje u vezi financija); finansijska analiza; finansijske procjene [osiguranje, banke, nekretnine]; finansijski [bankarski] poslovi; finansijski oglasi; finansijski poslovi [transakcije]; finansiranje (usluge

finansiranja); fiskalne procjene; fondovi (osnivanje fondova); garancije [garancije]; građevinski objekti (upravljanje građevinskim objektima); imovina (upravljanje imovinom); informacije (finansijska obavještenja); informacije o osiguranju; izdavanje putnih čekova; izdavanje vrijednosnih bonova; iznajmljivanje kancelarija [nekretnine]; iznajmljivanje poljoprivrednih imanja; iznajmljivanje stanova; kapital (ulaganje kapitala); kompenzacijski poslovi [mijenjanje]; krediti; kreditne kartice (izdavanje kreditnih kartica); kreditne kartice (službe za kreditne kartice); likvidacija preduzeća (usluge likvidacije preduzeća); marke (procjena poštanskih maraka); mijenjanje novca (usluge mjenjačnica); monetarni poslovi; nakit (procjena nakita); naknada štete (finansijska procjena naknade štete); nekretnine (agencije za nekretnine); nekretnine (davanje u zakup nekretnina) [lizing]; nekretnine (procjena nekretnina); nekretnine (upravljanje nekretninama); nezgode (osiguranje od nezgoda); novčana sredstva (elektronski prijenos novčanih sredstava); numizmatička procjena; osiguranja; osiguranje (informacije o osiguranju); osiguranje (savjetovanje o osiguranju); osiguranje (usluge matematičkih stručnjaka [aktuara] za životno osiguranje); osnivanje kapitala; otplata na rate; ovjeravanje čekova; penzije (usluge blagajni za plaćanje penzija); pokroviteljstvo (finansijsko pokroviteljstvo); poljoprivredna imanja (iznajmljivanje poljoprivrednih imanja); pomorsko osiguranje; posredovanje [mešetarenje] \*; posredovanje [mešetarenje] u trgovini nekretninama; posredovanje na berzi; posredovanje na berzi [mešetarenje]; posredovanje u nekretninama; posredovanje u osiguranju; potraživanja (utjerivanje potraživanja jednog preduzeća posredstvom spoljnog nagodbenog tijela) [faktoring]; povjereničke službe; pozajmljivanje na temelju zalogu; požar (osiguranje od požara); prijenos elektronskim putem novčanih sredstava; procjena maraka; procjena nakita; procjena nekretnina; procjena stabala u šumi; procjena starina [antikviteta]; procjena umjetnina; procjena vune [finansijska procjena vune]; procjene (fiskalne procjene); procjene (numizmatičke procjene); procjene finansijske procjene [osiguranje, bankarski promet, imovina]; putni čekovi (izdavanje putnih čekova); savjetovanje o finansijskim pitanjima; savjetovanje o osiguranju; sigurnosne blagajne [sefovi] (odlaganje u sigurnosne blagajne); skupljanje priloga; skupljanje za dobrotvorne svrhe; sredstva (stvaranje zajedničkih sredstava); stabla u šumi (procjena stabala u šumi); stanarine (naplata stanarina); stanovi (iznajmljivanje stanova); starine (procjena starina); štedionice [usluge štedionica]; transakcije (finansijske transakcije); ulaganje sredstava; umjetnička djela (procjena umjetničkih djela); upravljanje građevinskim objektima; upravljanje imovinom; upravljanje nekretninama; usluge depozita u sefovima; usluge fondova uzajamne pomoći; utjerivanje dugovanja (agencije za utjerivanje dugovanja); vrijednosni bonovi (izdavanje vrijednosnih bonova); vrijednosti (depoziti vrijednosti); zajam na temelju zalogu; zajmovi; zakup [vrsta iznajmljivanja dobara za profesionalne potrebe, koja temeljem ugovora mogu postati vlasništvo iznajmitelja] [lizing]; zakup nekretnina (davanje u zakup nekretnina) [lizing]; zalog (davanje zajma uz zalog); životno osiguranje (potpisivanje polisa za osiguranje života).

Klasa 41: Agencije za modele za slikare i vajara; akademije [obuka]; cirkusi; cirkusi [zabavni parkovi]; dekor za priredbe (iznajmljivanje dekora za priredbe); digitalne slike (usluge digitalnog snimanja); disk džokeji (usluge disk džokeja) usluge; diskoteke (usluge diskoteka); dopisivanje (obuka putem dopisivanja); elektronske publikacije (iskorištavanje elektronskih publikacija koje se ne mogu prenositi on-line); filmovi (prikazivanje igranih filmova); filmovi (proizvodnja filmova); fitness časovi (vođenje fitness časova); fizičke vježbe [fizička kultura]; fotografi sanje; fotografske reportaže; gimnastičarska obuka; golf (stavljanje na raspolaganje igrališta za golf); govor pokreta (tumačenje govora pokreta); govor pokretima (tumačenje govora pokretima); igre (usluge hala i dvorana za igre); igre (usluge igara) pružene on-line [s jedne informatičke mreže]; igre za novac; informacije o

obrazovanju; informacije o razonodi; informacije u vezi rekreacije; izdavanje knjiga; izložbe (organizovanje izložbi) u kulturne ili obrazovne svrhe; iznajmljivanje audio uređaja; iznajmljivanje dekora za priredbe; iznajmljivanje igrački; iznajmljivanje kinematografskih filmova; iznajmljivanje kinoaparature i pribora; iznajmljivanje magnetoskopa; iznajmljivanje opreme za igranje; iznajmljivanje radio i televizijskih aparata; iznajmljivanje rasvjetnih uređaja za pozorišnu dekoraciju i za televizijske studije; iznajmljivanje ronilačke opreme; iznajmljivanje sportske opreme [osim vozila]; iznajmljivanje sportskih terena; iznajmljivanje stadiona; iznajmljivanje teniskih igrališta; iznajmljivanje videokamera; iznajmljivanje videotraka; iznajmljivanje zvučnih snimaka; javni konkursi (organizovanje javnih konkursa) [obuka ili zabava]; kaligrafija (usluge kaligrafije); kampovi za ljetovanje (usluge kampova za ljetovanje) [zabava]; kampovi za sportsko usavršavanje; karaoke (stavljanje na raspolaganje opreme za karaoke); kinematografski filmovi (iznajmljivanje kinematografskih filmova); kino sale (iskorištavanje kinodvorana); kino studiji; kinoaparatura (iznajmljivanje kinoaparature i pribora); klubovi (usluge klubova) [zabava ili obrazovanje]; knjige (izdavanje knjiga); knjige (posuđivanje knjiga); kockarnice [igre] (usluge kockarnica); komponovanje muzike; komponovanje muzike (usluge komponovanja muzike); koncerti (organizovanje i vođenje koncerata); konferencije (organizovanje i vođenje konferencija); kongresi (organizovanje i vođenje kongresa); kroćenje životinja [dresiranje]; lični treneri (usluge ličnih trenera) [fitness]; lutrija (organizovanje lutrije); ljetovanje (usluge kampova za ljetovanje) [razonoda]; magnetoskopi (iznajmljivanje magnetoskopa); mikrofoni (snimanje na mikrofilmove); mikroizdavaštvo; mjerenje vremena na sportskim takmičenjima; modne revije za zabavne svrhe (organizovanje); montaža radio i televizijskih programa; muzejske usluge [predstavljanje, izložbe]; muzičke sale; noćni klubovi; objavljivanje knjiga i časopisa, elektronski on line; objavljivanje tekstova [osim u reklamne svrhe]; obrazovanje (informacije o obrazovanju); obrazovanje [obuka]; obrazovni zavodi [internati]; obuka; obuka [predavanje]; obuka putem dopisivanja; obuka za predškolski uzrast; organizovanje i vođenje koncerata; organizovanje i vođenje konferencija; organizovanje i vođenje kongresa; organizovanje i vođenje radionica za stručno osposobljavanje; organizovanje i vođenje razgovora; organizovanje i vođenje seminara; organizovanje izložba u kulturne i obrazovne svrhe; organizovanje javnih konkursa [obrazovanje ili razonoda]; organizovanje konkursa ljepote; organizovanje plesova; organizovanje spektakla [usluge impresarija]; organizovanje sportskih takmičenja; orkestri (usluge orkestra); pedagoški eksperimenti; pisanje tekstova [ne u reklamne svrhe]; planiranje prijema [razonoda]; posuđivanje knjiga; pozorišne predstave; pozorišni dekor (iznajmljivanje pozorišnog dekora); pozorišni glumci (usluge pozorišnih glumaca); pozorišni preduzetnici [impresariji] (usluge pozorišnih preduzetnika); praktična obuka [demonstriranje]; predškolska obuka; prekvalifikacija (usluge prekvalifikacije); prelamanje slogova [ne u reklamne svrhe]; prevodilačke usluge; prevodioci (usluge prevođenja); prijemi (planiranje prijema) [razonoda]; priredbe (iznajmljivanje dekora za priredbe); priredbe (održavanje priredbi); priredbe (organizovanje priredbi) [usluge impresarija]; priredbe (proizvodnja priredbi); profesionalna orijentacija [savjeti u vezi obrazovanja ili osposobljavanja]; proizvodnja filmova; proizvodnja filmova na video-trakama; proizvodnja muzike; putujuće biblioteke (usluge putujućih biblioteka); radio televizijski programi (montaža radio televizijskih programa); radioaparati i televizori (iznajmljivanje radioaparata i televizora); radiofonija (razonoda putem radiofonije); razgovori (organizovanje i vođenje razgovora); razonoda; razonoda (informacije u vezi razonode); razonoda posredstvom radija; razonoda posredstvom televizije; rekreacija (obavještenja u vezi rekreacije); religiozno obrazovanje; reportaže (fotografske reportaže); reporterske usluge; rezervisanje mjesta za priredbe; ronjenje (iznajmljivanje ronilačke opreme);

scenarijumi (izrada scenarijuma); seminari (organizovanje i vođenje seminara); simpozijumi (organizacija i vođenje simpozijuma); simpozijumi (organizovanje i vođenje simpozijuma); sinhronizacija; slobodno vrijeme (usluge za ispunjavanje slobodnog vremena); snimanje na videotrake; sportska oprema (stavljanje na raspolaganje sportske opreme); sportska takmičenja (mjerjenje vremena na sportskim takmičenjima); sportska takmičenja (organizovanje sportskih takmičenja); sportska usavršavanja (sportski kampovi za usavršavanje u sportu); sportske oprema (iznajmljivanje sportske opreme osim vozila); stadioni (iznajmljivanje stadiona); studio za snimanje (usluge studija za snimanje); tekstovi (objavljivanje tekstova) [osim u reklamne svrhe]; tekstovi (sastavljanje tekstova) [ne u reklamne svrhe]; televizija (razonoda na televiziji); televizijski programi (montaža radio i televizijskih programa); televizori (iznajmljivanje televizora i radioaparata); titlovanje filmova; treniranje [fizička vježba]; tumačenje govora pokreta; ulaznice za priredbe (agencije za ulaznice za priredbe) [razonoda]; videotrake (iznajmljivanje videotraka); videotrake (montaža videotraka); videotrake (produkcija filmova na videotrakama); videotrake (snimanje na videotrake); zabavni parkovi [cirkusi]; zdravstveni klubovi (usluge zdravstvenih klubova) [održavanje zdravlja i fizičke forme]; zoološki vrtovi [usluge zooloških vrtova]; zvučni snimci (iznajmljivanje zvučnih snimaka); životinje (kroćenje životinja) [dresiranje].

---

(210) **Ž-2021-30**

(220) 03.02.2021.

(731) "Apatinska Pivara" Apatin d.o.o., Trg oslobođenja br.5, 25260, Apatin, RS

(540)



(550) I

(740) Ivan Raičević, City kvart - Cetinjski put 40, L5-1, stan 10, Podgorica

(511) Klasa 32: Piva; lager (piva sa donjom fermentacijom ili piva donjeg vrenja).

---

(210) **Ž-2021-31**

(220) 03.02.2021.

(731) "Apatinska Pivara" Apatin d.o.o., Trg oslobođenja br.5, 25260, Apatin, RS

(540)



(550) I

(740) Pavle Tripković, City kvart - Cetinjski put 40, L5-1, stan 10, Podgorica

(511) Klasa 32: Piva; lager (piva sa donjom fermentacijom ili piva donjeg vrenja).

---

(210) **Ž-2021-32**

(220) 03.02.2021.

(731) "Apatinska Pivara" Apatin d.o.o., Trg oslobođenja br.5, 25260, Apatin, RS

(540)



(550) I

(740) Pavle Tripković, City kvart - Cetinjski put 40, L5-1, stan 10, Podgorica

(511) Klasa 32: Piva; lager (piva sa donjom fermentacijom ili piva donjeg vrenja).

---

(210) **Ž-2021-37**

(220) 05.02.2021.

(731) ALKALOID AD Skopje, Blvd. Aleksandar Makedonski 12, 1000, Skopje, MK

(540)

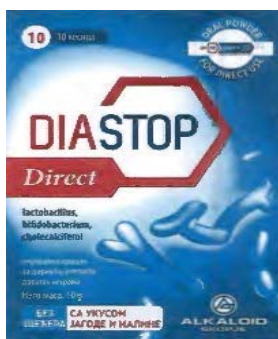

(550) I

(740) Miladin Popović, Đoka Miraševića 21/III, 81000, Podgorica

(511) Klasa 5: Dijetetski dodaci za ljude i životinje; nutritivni dodaci (dodaci prehrani); dijetetski dodaci u prahu.

---

(210) **Ž-2021-38**

(220) 05.02.2021.

(731) ALKALOID AD Skopje, Blvd. Aleksandar Makedonski 12, 1000, Skopje, MK

(540)

DIASTOP Direct

(550) I

(740) Miladin Popović, Đoka Miraševića 21/III, Podgorica

(511) Klasa 5: Dijetetski dodaci za ljude i životinje; nutritivni dodaci (dodaci prehrani); dijetetski dodaci u prahu.

---

(210) **Ž-2021-39**

(220) 06.02.2021.

(731) Shanghai Ramentalk E-Commerce Co., Ltd., Room 2153, Building No.2, Zixing Road No.588, Minhang District, 201100, Shanghai, CN

(540)



(550) I

(740) Dalibor Roćen, ulica 13. Jula br.3, 81000, Podgorica

(511) Klasa 30: Rezanci koji se brzo kuvaju (tzv. Ramen rezanci); rezanci (tzv. Nudle); testenina (tzv. Udon rezanci); instant Udon rezanci; Japanski Ramen; pirinčani rezanci; Sosovi (začini); sos od kuvanih mesnih sokova (tzv. Mesne gravije); seme susama (začini); mešavina seckanog povrća, senfa i ljutih začina (tzv. Pikalili); Čau-čau (začin); Bešamel; Instant pirinač; Instant rezanci; Špageti.

Klasa 35: Oglašavanje; Pomoć u poslovnom upravljanju; Organizovanje izložbi za privredne ili reklamne potrebe; Aranžiranje, raspoređivanje i organizovanje tržišnih promocija za druge; Marketing proizvoda i usluga za druge; prodajne promocije za druge; Marketing; Obezbeđivanje onlajn tržišta za kupce i prodavce roba i usluga; Ciljni marketing; Ažuriranje

i održavanje podataka u računarskim bazama podataka; Indeksiranje internet sajtova za komercijalne namene ili namene oglašavanja; Iznajmljivanje automata za prodaju; Usluge maloprodaje farmaceutskih, veterinarskih i higijenskih preparata i medicinskog materijala.

---

(210) **Ž-2021-40**

(220) 08.02.2021.

(300) US 07.08.2020, broj 90/099,775

(731) Stryten Manufacturing LLC (a Delaware Limited Liability Company), 3700 Mansell Road Suite 400 , 30022, Alpharetta, Georgia, US

(540)

**STRYTEN**

(550) I

(740) Jasna Jusić, Marka Radovića 37, 1. sprat, stan br. 4., 81000, Podgorica

(511) Klasa 9: Baterije; djelovi baterija; punjači baterija; akumulatori; električno napajanje; skladištenje električne energije; aparati, uređaji i instrumenti za električno napajanje; aparati, uređaji i instrumenti za neprekidno napajanje električnom energijom; električni uređaji, aparati i instrumenti; električni sistemi; sistemi za skladištenje električne energije; aparati, uređaji i instrumenti za regulaciju, kontrolu i distribuciju električne energije; aparati, uređaji i instrumenti za skupljanje, regulaciju, kontrolu i distribuciju solarne energije; fotonaponski sistemi, aparati, uređaji, sistemi i instrumenti; elektronički izmjenjivači i regulatori napajanja; skladištenje baterije u jednom sistemu; gorivne ćelije; električne stanice za punjenje; generatori na baterije za proizvodnju električne energije.

---

(210) **Ž-2021-45**

(220) 08.02.2021.

(731) Wells Enterprises, Inc., One Blue Bunny Drive, 51031, Le Mars, US

(540)

**HALO TOP**

(550) I

(740) Miladin Popović, Đoka Miraševića 21/III, Podgorica

(511) Klasa 30: Smrznute poslastice; sladoled; smješe za sladoled; krem od vanile; smrznuti krem od vanile; smrznuti jogurt; smrznuti jogurt kao poslastica; smješe za smrznuti jogurt; osnove za pravljenje milk šejkova; šejkovi sa sladoledom.

---

(210) **Ž-2021-47**

(220) 08.02.2021.



(731) Chips Way d.o.o., Milutina Mandića bb, 32000, Čačak, RS  
(540)



(550) I

(740) Božidar S.Radulović, Baku 30/5, 81000, Podgorica

(511) Klasa 29: Grickalice na bazi krompira; čips.

---

(210) **Ž-2021-48**

(220) 09.02.2021.

(731) Lyle & Scott Ltd., Third Floor, Kent House, 14-17 Market Place, W1W 8AJ, London, GB

(540)



(550) I

(740) Jasna Jusić, Marka Radovića 37, 1. sprat, stan br. 4., 81000, Podgorica

(511) Klasa 18: Koža, imitacije kože, proizvodi od tih materijala koji nisu obuhvaćeni drugim klasama; životinjske kože; koferi i torbe; kišobrani, suncobrani i štapovi za hodanje; bičevi i sedlarsko remenarski proizvodi.

Klasa 25: Odjeća, obuća, pokrivala za glavu.

Klasa 35: Oglašavanje i reklamiranje; vođenje komercijalnih poslova; komercijalna administracija; kancelarijski poslovi.

---

(210) **Ž-2021-49**

(220) 09.02.2021.

(731) Lyle & Scott Ltd., Third Floor, Kent House, 14-17 Market Place, W1W 8AJ, London, GB

(540)

## Lyle & Scott

(550) I

(740) Jasna Jusić, Marka Radovića 37, 1. sprat, stan br. 4., 81000, Podgorica

(511) Klasa 18: Koža, imitacije kože, proizvodi od tih materijala koji nisu obuhvaćeni drugim klasama; životinjske kože; koferi i torbe; kišobrani, suncobrani i štapovi za hodanje; bičevi i sedlarsko remenarski proizvodi.

Klasa 25: Odjeća, obuća, pokrivala za glavu.

Klasa 35: Oglašavanje i reklamiranje; vođenje komercijalnih poslova; komercijalna administracija; kancelarijski poslovi.

---

(210) **Ž-2021-50**

(220) 10.02.2021.

(731) Reckitt Benckiser LLC, 399 Interpace Parkway, 07054, Parsippany, New Jersey, US

(540)

## LYSOL ON THE GO

(550) I

(740) Miladin Popović, Đoka Miraševića 21/III, Podgorica

(511) Klasa 3: Višenamjenski preparati za čišćenje; preparati za čišćenje, poliranje, ribanje i abrazivni preparati; sredstva za čišćenje toaleta; sredstva za čišćenje kupatila; sredstva za čišćenje kuhinje; krpe, vlažne maramice, maramice i sunđeri natopljeni preparatima za čišćenje; preparati za uklanjanje fleka; sprejovi za osvježavanje tkanina; sapuni; preparati za čišćenje ruku; gelovi za čišćenje ruku; sprejovi za čišćenje ruku; pjena za čišćenje ruku; parfimisani preparati za atmosferu; parfimisani sprejovi za prostorije.

Klasa 5: Dezinfekcioni, antibakterijski preparati i preparati za dezodorisanje; sredstva za dezinfekciju; dezinfekcioni sprejovi; sredstva za dezinfekciju tkanina; dezinfekciona sredstva za pranje ruku; sredstva za dezinfekciju ruku; preparati za higijenu; sredstva za higijenu ruku; preparati za dezinfekciju tvrdih površina za upotrebu u domaćinstvu; dezodoransi za upotrebu u domaćinstvu; preparati za dezodorisanje vazduha; preparati za dezodorisanje odjeće i tkanina; krpe, vlažne maramice, maramice i sunđeri natopljeni dezinfekcionim sredstvima; krpe, vlažne maramice, maramice i sunđeri natopljeni antiseptičkim preparatima; krpe, vlažne maramice, maramice i sunđeri natopljeni antibakterijskim preparatima; antibakterijski sapuni; dezinfekcioni sapuni; preparati za osvježavanje vazduha; preparati za neutralisanje mirisa za upotrebu na tekstilu, tepisima i u vazduhu; preparati za neutralisanje mirisa; preparati za prečišćavanje vazduha; preparati za higijenu vazduha; preparati za dezinfekciju vazduha.

---

(210) **Ž-2021-52**

(220) 10.02.2021.

(731) Chips Way d.o.o., Milutina Mandića bb, 32000, Čačak, RS  
(540)



(550) I

(740) Božidar S.Radulović, Baku 30/5, 81000, Podgorica  
(511) Klasa 30: Grickalice na bazi žitarica; grickalice na bazi pšenice; grickalice na bazi kukuruza; kukuruzni flips.

---

(210) **Ž-2021-53**

(220) 12.02.2021.

(731) Mobes Monte d.o.o., Moskovska 139 A, 81000, Podgorica, ME

(540)



(550) I

(511) Klasa 35: Savjetovanje o organizaciji i vođenje poslova; poslovne informacije;savjeti o organizaciji i vođenju poslova; pomoć u vođenju poslova.  
Klasa 42: Savjetivanje u vezi zaštite životne sredine; kontrola kvaliteta.

---

(210) **Ž-2021-54**

(220) 12.02.2021.

(731) British American Tobacco (Brands) Inc., 251 Little Falls Drive, Suite 100, DE 19808-1674, Wilmington, US

(540)



(550) I

(740) Miladin Popović, Đoka Miraševića 21/III, Podgorica

(511) Klasa 34: Cigarete; duvan, sirov ili prerađen; duvan za samostalno zamotavanje; duvan za lule; duvanski proizvodi; zamjene za duvan (koje nijesu za upotrebu u medicini); cigare; cigarilosi; upaljači za cigarete; upaljači za cigare; šibice; artikli za pušače; cigaret papir; cigaret tube; filteri za cigarete; džepni aparati za zamotavanje cigareta; ručne mašine za ubrizgavanje duvana u papirne tube; elektronske cigarete; tečnosti za elektronske cigarete; duvanski proizvodi namijenjeni za zagrijavanje.

---

(210) **Ž-2021-55**

(220) 12.02.2021.

(731) British American Tobacco (Brands) Inc., 251 Little Falls Drive, Suite 100, DE 19808-1674, Wilmington, US

(540)

LOVE THE NOW

(550) I

(740) Miladin Popović, Đoka Miraševića 21/III, Podgorica

(511) Klasa 34: Cigarete; duvan, sirov ili prerađen; duvan za samostalno zamotavanje; duvan za lule; duvanski proizvodi; zamjene za duvan (koje nijesu za upotrebu u medicini); cigare; cigarilosi; upaljači za cigarete; upaljači za cigare; šibice; artikli za pušače; cigaret papir; cigaret tube; filteri za cigarete; džepni aparati za zamotavanje cigareta; ručne mašine za ubrizgavanje duvana u papirne tube; elektronske cigarete; tečnosti za elektronske cigarete; duvanski proizvodi namijenjeni za zagrijavanje.

---

(210) **Ž-2021-57**

(220) 12.02.2021.

(731) Chips Way d.o.o., Milutina Mandića bb, 32000, Čačak, Srbija, RS

(540)



(550) I

(740) Božidar S.Radulović, Baku 30/5, 81000, Podgorica

(511) Klasa 30: Grickalice na bazi žitarica; grickalice na bazi kukuruza; kukuruzni flips.

(210) **Ž-2021-58**

(220) 12.02.2021.

(731) Chips Way d.o.o., Milutina Mandića bb, 32000, Čačak, Srbija, RS

(540)



(550) I

(740) Božidar S.Radulović, Baku 30/5, 81000, Podgorica

(511) Klasa 30: Grickalice na bazi žitarica; grickalice na bazi kukuruza; kokice.

---

(210) **Ž-2021-59**

(220) 12.02.2021.

(731) Chips Way d.o.o., Milutina Mandića bb, 32000, Čačak, Srbija, RS

(540)



(550) I

(740) Božidar S.Radulović, Baku 30/5, 81000, Podgorica

(511) Klasa 29: Grickalice na bazi krompira; čips.

Klasa 30: Slane grickalice; grickalice na bazi žitarica; grickalice na bazi pšenice; grickalice na bazi kukuruza; kukuruzni flips; kokice; slatkiši; biskviti, keksi i kolačići; biskviti od hrskavog tijesta; suvi biskviti; slatkiši od šećera; slatki keksi i kolačići; čokolada.

---

(210) **Ž-2021-60**

(220) 15.02.2021.

(731) Kite Pharma, Inc. (Delaware corporation), 2400 Broadway, 90404, Santa Monica, California, US

(540)

TECARTUS

(550) I

(740) Božidar S. Radulović, Baku 30/5, 81000, Podgorica

(511) Klasa 5: Farmaceutski preparati, naročito, farmaceutski preparati za upotrebu u lečenju kancera; farmaceutski i biološki preparati za imunoterapiju, uključujući imunoterapiju T ćelijama.

---

(210) **Ž-2021-61**

(220) 15.02.2021.

(731) LAWAND GENERAL TRADING FZE, JAFZA LOB19-2603, Jebel Ali, Dubai, AE

(540)



(550) I

(740) Božidar S.Radulović, Baku 30/5, 81000, Podgorica

(511) Klasa 34: Duvan, Cigarete, melasa duvan, Duvan za žvakanje, Tabakere, Upaljači za pušače, kutije šibica, Pepeljare, filteri za cigarete, kutije za cigarete, usnici za cigarete.

---

(210) **Ž-2021-62**

(220) 15.02.2021.

(731) LAWAND GENERAL TRADING FZE, JAFZA LOB19-2603, Jebel Ali, Dubai, AE

(540)

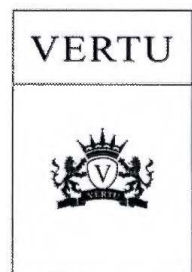

(550) I

(740) Božidar S.Radulović, Baku 30/5, 81000, Podgorica

(511) Klasa 34: Duvan, Cigarete, melasa duvan, Duvan za žvakanje, Tabakere, Upaljači za pušače, kutije šibica, Pepeljare, filteri za cigarete, kutije za cigarete, usnici za cigarete.

(210) **Ž-2021-63**

(220) 18.02.2021.

(731) "ENING" d.o.o, Straševina b.b., 81400, Nikšić, ME

(540)



(550) I

(511) Klasa 6: Armature (metalne armature za cjevovode; cijevi (metalne cijevi); cjevovodi (metalne armature za cjevovode); cjevovodi (metalni cjevovodi za uređaje ventilacije i klimatizac.); čelični lim, klimatizacija (metalne cijevi za ventilaciju i klimatizaciju); konstrukcije (metalne konstrukcije); limovi; matice (metalne matice); metalne rešetke; metalne spojnice. ugaone, metalni omotači [blindaža]; metalni prsteni; prstenovi (metalni prstenovi za pričvršćivanje cijevi); rešetke (metalne rešetke); rešetke (šipke metalnih rešetki); T-cijevi (metalne T -cijevi); ventilacija i klim.(metalne cijevi za postavljanje ventil. I klimat.), ventili (metalni ventili) [nisu dijelovi mašina]; vezice metalne; vezivanje (metalne trake za vezivanje); zavrtnji s maticom (metalni zavrtnji s maticom).

Klasa 11: Grijачi vazduha; grijanje (električni uređaji za grijanje); izmjenjivači (toplinski izmjenjivači); nape za provjetravanje, nape usisne za kuhinje; pročišćavanje vazduha (uređaji i maš. za pročišćavanje vazduha); provjetravanje (nape za provjetravanje); svijetiljke [rasvjeta]; svijetiljke električne; svijetiljke, električne; toplina (sakupljači topline) [rekuperatori]; toplinski izmjenjivači; vazduh (uređaji i mašine za pročišćavanje vazduha); vazduh (uređaji za filtriranje vazduha); venti latori [ dijelovi postrojenja za provjetravanje].

Klasa 17: Boje (izolacione boje); brtve, zaptivke, poklopci spojnice; brtveni materijali, zaptivni materijali, cjevo vodi (brtve, zaptivke za cjevovode), file za izolaciju; filterski materijal [plast.materije ili poluobrađ. pjenast.plastika]; gumeni ili plastični materijali za popunjavanje; isijavanje topline (materijali za spriječavanje isijavanja topline); izolacione materije; izolacione tkanine; izolacioni materijali; izolacioni premazi; kit za spojeve [brtve, zaptivke]; ljepljive trake [ne za medic.,za papirnice ni za kućnu upotrebu]; materijal za punjenje (gumeni ili plastični materijali za punjenje); prigušni umeci gumeni; samoljepljive trake; toplina (materijali za sprečavanje isijavanja topline); toplinska izolacija (proizvodi za toplotnu izolaciju); trake za izolaciju.

Klasa 40: Informacije o obradi materijala; metali ( obrada metala); vazduh ( osvježavanje vazduha); vazduh (pročišćavanje vazduha); vazduh (uklanjanje mirisa iz vazduha [dezodoriranje]); zavarivanje; usluge farbanja; struganje [poliranje]; rezbarenje [graviranje]; poliranje [struganje]; lasersko trasiranje; klimatizacija iznajmljivanje uređaja za klimatizaciju); iznajmljivanje uređaja za klimatizaciju; iznajmljivanje rezervnih uređaja za grijanje; bršenje

---

(210) **Ž-2021-70**

(220) 22.02.2021.

(731) Merck Sharp & Dohme Corp. a New Jersey Corporation, One Merck Drive, 08889, Whitehouse Station, New Jersey, US

(540)

## LAGEVRIO

(550) I

(740) Jasna Jusić, Marka Radovića 37, 1. sprat, stan br. 4., 81000, Podgorica

(511) Klasa 5: Farmaceutski preparati.

---

(210) **Ž-2021-72**

(220) 23.02.2021.

(731) Mihailo Radojičić, 4. jula TS - 2, 81000, Podgorica, ME

(540)



(550) I

(511) Klasa 35: Oglašavanje i reklamiranje.

Klasa 41: Usluge razonode i zaokupljanja pažnje; usluge čiji je osnovni cilj razbibriga, zabava ili rekreacija lica, sve putem sajta, on line.

---

(210) **Ž-2021-73**

(220) 24.02.2021.

(731) KLIN PRODUTOS INFANTIS LTDA., Rua Saulo Wesley G. Peres, 769, Bairro Novo Parque São Vicente, Birigui, CEP:16200-319, São Paulo, Brazil, BR

(540)



(550) I

(740) Božidar S.Radulović, Baku 30/5, 81000, Podgorica

(511) Klasa 25: Obuća, cipele, papuče, sandale, patike i čarape.

---

(210) **Ž-2021-74**



(220) 18.02.2021.

(731) Sanda Strugar, Miločer bb, 85315, Budva, ME

(540)



(550) I

(740) Damjan Milić, Bulevar Džordža Vašingtona 108 A/36 II sprat, 81000, Podgorica

(511) Klasa 14: Agat [drago kamenje];, amajlije [nakit];, biseri [nakit];, biste od plemenitih metala;,, brojčanici [za časovnike i časovničarstvo];, broševi [nakit];, budilnici;,, čilibar (nakit od crnog čilibara);,, čilibar (ukrasi od čilibara);,, čilibar, presovani (perle od presovanog čilibara);,, čilibar, crni (sirovi ili poluobradjeni crni čilibar);,, dijamanti;,, dijamanti (vještački dijamanti);,, drago kamenje;,, draguljarski proizvodi;,, dragulji (prirodni dragulji);,, dugmići za narukvice;,, električni satovi;,, hronografi [satovi];,, hronometri;,, hronometrski instrumenti;,, hronoskopi;,, igle (ukrasne igle);,, igle pribadače [nakit];,, iridijum;,, kazaljke [za časovnike];,, kipovi od plemenitih metala;,, kipovi od plemenitih metala;,, klatna [za časovnike];,, klatna satova;,, klatna za satove i časovnike [ankeri];,, ključevi (ukrasni držači za ključeve) [privjesci];,, kontrolni satovi [glavni satovi];,, kopče za kravate;,, kravate (igle za kravate);,, kravate (kopče za kravate);,, kućišta džepnih satova;,, kućišta opruga satova;,, kućišta zidnih satova;,, kutije s draguljima za mehanizme satova;,, kutije za nakit;,, kutije za satove;,, lančići [nakit];,, lančići za satove;,, legure plemenitih metala;,, manžetne (dugmad za manžetne);,, medalje;,, medaljoni [nakit];,, metalni novac;,, nakit obloženi (optočeni nakit);,, narukvice [nakit];,, narukvice za satove;,, naušnice;,, obuća (ukrasi za obuću, od plemenitih metala);,, ogrlice [nakit];,, olivin [dragi kamen];,, opruge za satove;,, osmijum;,, paladijum;,, perle za izradu nakita;,, platina [metal];,, plemeniti metali (legure plemenitih metala);,, plemeniti metali (odlijevci plemenitih metala);,, plemeniti metali sirovi ili poluobradjeni;,, poluge [lingoti] od plemenitih metala;,, privesci [nakit];,, privesci za ključeve od plemenitih metala, ukrasni;,, prstenje [nakit];,, rodijum;,, rutenijum;,, slonovača [slonovača] (ukrasi od slonovača);,, spinel, blijedocrveni [drago kamenje];,, srebrna žica;,, srebro (ukrasi od srebra);,, srebro (upredena srebrna žica);,, srebro, sirovo ili tučeno;,, ukrasi [bižuterija];,, ukrasi za obuću od plemenitih metala;,, ukrasi za šešire od plemenitih metala;,, ukrasi, srebreni;,, ukrasne igle;,, zlato, sirovo ili kovano;,, značke [amblemi] od plemenitih metala;,, žetoni, bakreni;,, žica (srebrna žica);,, žica od plemenitih metala [nakit];,,

Klasa 16: Albumi;,, ambalaža (papir za ambalažu);,, bakrorezi (noževi za bakroreze);,, bakrorezi [gravure];,, blokovi [notesi];,, blokovi [povezani listovi papira];,, blokovi za crtanje;,, boce (kartonski ili papirni omoti za boce);,, boce (kartonska ili papirna ambalaža za boce);,, brošure;,, crtanje (instrumenti za crtanje);,, crtanje (pribor za crtanje);,, čelična slova;,, čestitke;,, češljevi za pravljenje imitacija mramora;,, dzepići za pasoše;,, fotografije (stalci za fotografije);,, fotografije (uređaji za lijepljenje fotografija) fotografije [štampane];,, globusi [zemaljske kugle];,, građevinske makete;,, grafičke slike;,, gravirani umjetnički predmeti;,, graviranje (ploče za graviranje);,, gravure i drvorezi;,, isprave [dokument] (futrele za isprave);,, ispravljanje (boja za ispravljanje);,, kalendari;,, kalendari [godišnjaci];,, kalendari kojima se listovi trgaju;,, kancelarijski pribor [osim namještaja];,, karte \* ;,, kartice (bušene

kartice za razboje);,karton od drvene piljevine;,,kartonske cijevi;,,kartonske kutije za šešire;,,kartonski proizvodi;,,kaširani papir;,,katalozi;,,kipovi od kaširanog papira [figurice];,,knjige;,,knjižice [pasoši, radne knjižice itd.];,,kreditne kartice (neelektrične prese za kreditne kartice);,,krivuljari [pribor za crtanje krivulja];,,krojačke krede;,,krojevi (navlake za krojeve);,,krojevi za šivenje odjevnih predmeta;,,krunice [čisla];,,kuglice za hemijske olovke;,,kutije za papirne proizvode [kancelarijske potrepštine];,,kutije za pečate;,,kutije za slikarske boje [školski pribor];,,kutije, kartonske ili papirne;,,lenjiri za crtanje;,,letci, flajeri;,,ličilački valjci;,,manžetne za držanje pisaćeg pribora;,,naljepnice (ručne sprave za stavljanje naljepnica);,,naljepnice s adresama;,,naljepnice, štamparski blokovi;,,naprsci, gumeni [kancelarijski pribor];,,natpisi na papiru ili kartonu;,,omotači za boce, papirnati ili kartonski;,,pečati;,,pečati (podloge za stavljanje pečata);,,pečati, marke;,,plastični omotači za pakiranje;,,ploče za graviranje;,,ploče za matrice;,,prospekti;,,registri [knjige];,,slova (štamparska slova);,,srebrni papir;,,sveske za pisanje i crtanje;,,uvezi [korice];,,vrećice [omotnice, džepovi], od papira ili plastike za ambalažu;,,vrećice, papirne.

---

(210) **Ž-2021-75**

(220) 25.02.2021.

(731) Philip Morris Products S.A., Quai Jeanrenaud 3, 2000, Neuchâtel, CH

(540)

## APRICITY

(550) I

(740) Milena Pejović, Cetinjski put 11, The Capital Plaza IV floor, 81000, Podgorica

(511) Klasa 34: Žičani vaporizatori za elektronske cigarete i elektronske uređaje za pušenje; duvan, sirov ili prerađen; duvanski proizvodi uključujući cigare, cigarete, cigarilose, duvan za uvijanje cigareta, duvan za lule, duvan za žvakanje, duvan za šmrkanje, kretek; snus (duvan u prahu); zamjena za duvan (za nemedicinsku upotrebu); artikli za pušače, uključujući papir za cigarete, tube za cigarete, filtere za cigarete, kutije za duvan, kutije za cigarete, tabakere i pepeljare, lule, džepne mašine za uvijanje cigareta, upaljače; šibice; duvanski štapići, duvanski proizvodi za zagrijavanje, elektronski uređaji i njihovi djelovi koji se koriste za zagrijavanje cigareta ili duvana u cilju oslobađanja aerosola koji sadrži nikotin za inhalaciju; tečni nikotinski rastvori za upotrebu u elektronskim cigaretama; elektronski uređaji za pušenje; elektronske cigarete; elektronske cigarete kao zamjena za tradicionalne cigarete; elektronski uređaji koji sadrže aerosol za inhalaciju nikotina; oralni vaporizatori za pušače, duvanski proizvodi i zamjene za duvan; artikli za pušače elektronskih cigareta; djelovi i oprema za navedene proizvode iz klase 34; uređaji za gašenje cigareta i cigara koje se zagrijevaju i duvanskih štapica koji se zagrijevaju; punjive elektronske kutije za cigarete.

---

(210) **Ž-2021-76**

(220) 25.02.2021.

(731) Philip Morris Products S.A., Quai Jeanrenaud 3, 2000, Neuchâtel, CH  
(540)

## YUGEN

(550) I

(740) Milena Pejović, Cetinjski put 11, The Capital Plaza IV floor, 81000, Podgorica

(511) Klasa 34: Žičani vaporizatori za elektronske cigarete i elektronske uređaje za pušenje; duvan, sirov ili prerađen; duvanski proizvodi uključujući cigare, cigarete, cigarilose, duvan za uvijanje cigareta, duvan za lule, duvan za žvakanje, duvan za šmrkanje, kretek; snus (duvan u prahu); zamjena za duvan (za nemedicinsku upotrebu); artikli za pušače, uključujući papir za cigarete, tube za cigarete, filtere za cigarete, kutije za duvan, kutije za cigarete, tabakere i pepeljare, lule, džepne mašine za uvijanje cigareta, upaljače; šibice; duvanski štapići, duvanski proizvodi za zagrijavanje, elektronski uređaji i njihovi djelovi koji se koriste za zagrijavanje cigareta ili duvana u cilju oslobađanja aerosola koji sadrži nikotin za inhalaciju; tečni nikotinski rastvori za upotrebu u elektronskim cigaretama; elektronski uređaji za pušenje; elektronske cigarete; elektronske cigarete kao zamjena za tradicionalne cigarete; elektronski uređaji koji sadrže aerosol za inhalaciju nikotina; oralni vaporizatori za pušače, duvanski proizvodi i zamjene za duvan; artikli za pušače elektronskih cigareta; djelovi i oprema za navedene proizvode iz klase 34; uređaji za gašenje cigareta i cigara koje se zagrijevaju i duvanskih štipica koji se zagrijevaju; punjive elektronske kutije za cigarete.

---

(210) **Ž-2021-77**

(220) 25.02.2021.

(731) V.A.S. INVEST d.o.o Budva, Dositejeva br. 57, Budva, ME

(540)

## Smokva Bay Resort

(550) I

(511) Klasa 36: Finansijski poslovi; Monetarni poslovi; Poslovi vezani za nekretnine.  
Klasa 37: Izgradnja; Popravka; Instalacija.  
Klasa 39: Transport; Pakovanje i skladištenje robe; Organizovanje putovanja.  
Klasa 41: Obrazovanje; obuke; zabava; sportske i kulturne aktivnosti.  
Klasa 43: Usluge snabdjevanja hrane i pića; Privremeni smještaj.

---

(210) **Ž-2021-78**

(220) 25.02.2021.

(731) Corporación Habanos,S.A., Carretera Vieja de Guanabacoa y Línea del Ferrocarril Final, Guanabacoa, La Habana, CU

(540)

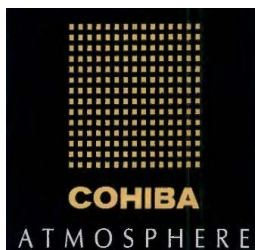

(550) I

(740) Miladin Popović, Đoka Miraševića 21/III, Podgorica

(511) Klasa 18: Prtljag i torbe za nošenje kao: koferi, kovčezi, putne torbe, nosiljke - torbe za nošenje novorođenčadi, školske torbe; futrole za vizitkarte i džepni novčanici.

Klasa 25: Odeća i obuća za ljude, takva koja nije ograničena na: kubanske Guayabera košulje, košulje uopšte, pantalone, odela, haljine, marame i cipele.

Klasa 30: Kafa, čaj; pića na bazi kafe, čaja i kakaoa; čokolada i pića na bazi čokolade.

Klasa 33: Alkoholna pića, osim piva; alkoholni preparati za pravljenje pića.

Klasa 35: Oglašavanje; vođenje poslova; poslovno upravljanje koje se odnosi na duvansku industriju i proizvode za cigare za pušače; kancelarijski poslovi; poslovno upravljanje; usluge prodaje u vezi cigara i proizvoda za cigare za pušače.

Klasa 43: Usluge obezbjeđivanja hrane i pića.

---

(210) **Ž-2021-79**

(220) 25.02.2021.

(731) V.A.S. INVEST d.o.o Budva, Dositejeva br. 57, Budva, ME

(540)



(550) I

(511) Klasa 36: Finansijski poslovi; Monetarni poslovi; Poslovi vezani za nekretnine.

Klasa 37: Izgradnja; Popravka; Instalacija.

Klasa 39: Transport; Pakovanje i skladištenje robe; Organizovanje putovanja.

Klasa 41: Obrazovanje; obuke; zabava; sportske i kulturne aktivnosti.

Klasa 43: Usluge snabdjevanja hrane i pića; Privremeni smještaj.

---

(210) **Ž-2021-80**

(220) 25.02.2021.

(731) V.A.S. INVEST d.o.o Budva, Dositejeva br. 57, Budva, ME

(540)

## Smokva Bay Development

(550) I

(511) Klasa 36: Finansijski poslovi; Monetarni poslovi; Poslovi vezani za nekretnine.

Klasa 37: Izgradnja; Popravka; Instalacija.

Klasa 39: Transport; Pakovanje i skladištenje robe; Organizovanje putovanja.

Klasa 41: Obrazovanje; obuke; zabava; sportske i kulturne aktivnosti.

Klasa 43: Usluge snabdjevanja hrane i pića; Privremeni smještaj.

---

(210) **Ž-2021-81**

(220) 25.02.2021.

(731) Društvo sa ograničenom odgovornošću „Be Found Group“, Budva (Be Found Group d.o.o. Budva), Žrtava fašizma br. 15, Budva, ME

(540)



(550) I

(740) Vanja Vuković, Trg Nikole Kovačevića 13, stan 15, Blok V, 81000, Podgorica

(511) Klasa 35: Informatičke kartoteke (vođenje informatičkih kartoteka); informatički podaci (pretraživanje podataka u informatičkoj kartoteci za treće lice); iznajmljivanje vremena za reklamiranje na svim komunikacionim sredstvima; marketing; reklamiranje on-line na informatičkoj mreži.

Klasa 38: Kompjuter (prijenos poruka i slika uz pomoć kompjutera); poruke (prijenos poruka); prijenos digitalnih datoteka; elektronske poruke.

Klasa 42: Informatičke stranice (ugošćavanje informatičkih stranica); informatički programi (iznajmljivanje informatičkih programa); informatički sistemi (osmišljavanje informatičkih sistema); informatički virusi (zaštita od informatičkih virusa); iznajmljivanje informatičkih programa; iznajmljivanje veb servera; posredovanja [nisu pravna]; web serveri (iznajmljivanje web servera); web stranice (kreiranje i održavanje web stranica za druge); zaštita od informatičkih virusa; analiza kompjuterskih sastava; baze podataka (obnavljanje baza podataka); daljinski nadzor kompjuterskih sistema.

---

(210) **Ž-2021-82**

(220) 26.02.2021.

(731) Apatinska Pivara Apatin d.o.o., Trg oslobođenja br.5, 25260, Apatin, RS

(540)



(550) I

(740) Ivan Raičević, City kvart - Cetinjski put 40, L5-1, stan 10, Podgorica

(511) Klasa 32: Piva, stout, lager (piva sa donjom fermentacijom ili piva donjeg vrenja), tamna piva (porter) i svetla piva, ale piva (piva sa gornjom fermentacijom ili piva gornjeg vrenja); mineralne i gazirane vode i druga bezalkoholna pića; voćni napici i voćni sokovi; sirupi i drugi preparati za pripremanje pića.

---

(210) **Ž-2021-83**

(220) 26.02.2021.

(731) Philip Morris Products S.A., Quai Jeanrenaud 3, 2000, Neuchâtel, CH

(540)

TEREA YELLOW

(550) I

(740) Milena Pejović, Cetinjski put 11/4, The Capital Plaza IV floor , 81000, Podgorica

(511) Klasa 34: Žičani vaporizatori za elektronske cigarete i elektronske uređaje za pušenje; duvan, sirov ili prerađen; duvanski proizvodi uključujući cigare, cigarete, cigarilose, duvan za uvijanje cigareta, duvan za lule, duvan za žvakanje, duvan za šmrkanje, kretek; snus (duvan u prahu); zamjena za duvan (za nemedicinsku upotrebu); artikli za pušače, uključujući papir za cigarete, tube za cigarete, filtere za cigarete, kutije za duvan, kutije za cigarete, tabakere i pepeljare, lule, džepne mašine za uvijanje cigareta, upaljače; šibice; duvanski štapići, duvanski proizvodi za zagrijavanje, elektronski uređaji i njihovi dijelovi koji se koriste za zagrijavanje cigareta ili duvana u cilju oslobađanja aerosola koji sadrži nikotin za inhalaciju; tečni nikotinski rastvori za upotrebu u elektronskim cigaretama; elektronski uređaji za pušenje; elektronske cigarete; elektronske cigarete kao zamjena za tradicionalne cigarete; elektronski uređaji koji sadrže aerosol za inhalaciju nikotina; oralni vaporizatori za pušače, duvanski proizvodi i zamjene za duvan; artikli za pušače elektronskih cigareta; dijelovi i oprema za navedene proizvode iz klase 34; uređaji za gašenje cigareta i cigara koje se zagrijevaju i duvanskih štapića koji se zagrijevaju; punjive elektronske kutije za cigarete.

---

(210) **Ž-2021-84**

(220) 26.02.2021.

(731) Philip Morris Products S.A., Quai Jeanrenaud 3, 2000, Neuchâtel, CH

(540)

## TEREA SILVER

(550) I

(740) Milena Pejović, Cetinjski put 11/4, The Capital Plaza , 81000, Podgorica

(511) Klasa 34: Žičani vaporizatori za elektronske cigarete i elektronske uređaje za pušenje; duvan, sirov ili prerađen; duvanski proizvodi uključujući cigare, cigarete, cigarilose, duvan za uvijanje cigareta, duvan za lule, duvan za žvakanje, duvan za šmrkanje, kretek; snus (duvan u prahu); zamjena za duvan (za nemedicinsku upotrebu); artikli za pušače, uključujući papir za cigarete, tube za cigarete, filtere za cigarete, kutije za duvan, kutije za cigarete, tabakere i pepeljare, lule, džepne mašine za uvijanje cigareta, upaljače; šibice; duvanski štapići, duvanski proizvodi za zagrijavanje, elektronski uređaji i njihovi djelovi koji se koriste za zagrijavanje cigareta ili duvana u cilju oslobađanja aerosola koji sadrži nikotin za inhalaciju; tečni nikotinski rastvori za upotrebu u elektronskim cigaretama; elektronski uređaji za pušenje; elektronske cigarete; elektronske cigarete kao zamjena za tradicionalne cigarete; elektronski uređaji koji sadrže aerosol za inhalaciju nikotina; oralni vaporizatori za pušače, duvanski proizvodi i zamjene za duvan; artikli za pušače elektronskih cigareta; djelovi i oprema za navedene proizvode iz klase 34; uređaji za gašenje cigareta i cigara koje se zagrijevaju i duvanskih štapića koji se zagrijevaju; punjive elektronske kutije za cigarete.

---

(210) **Ž-2021-85**

(220) 26.02.2021.

(731) Philip Morris Products S.A., Quai Jeanrenaud 3, 2000, Neuchâtel, CH

(540)

## TEREA TURQUOISE

(550) I

(740) Milena Pejović, Cetinjski put 11/4, The Capital Plaza , 81000, Podgorica

(511) Klasa 34: Žičani vaporizatori za elektronske cigarete i elektronske uređaje za pušenje; duvan, sirov ili prerađen; duvanski proizvodi uključujući cigare, cigarete, cigarilose, duvan za uvijanje cigareta, duvan za lule, duvan za žvakanje, duvan za šmrkanje, kretek; snus (duvan u prahu); zamjena za duvan (za nemedicinsku upotrebu); artikli za pušače, uključujući papir za cigarete, tube za cigarete, filtere za cigarete, kutije za duvan, kutije za cigarete, tabakere i pepeljare, lule, džepne mašine za uvijanje cigareta, upaljače; šibice; duvanski štapići, duvanski proizvodi za zagrijavanje, elektronski uređaji i njihovi djelovi koji se koriste za zagrijavanje cigareta ili duvana u cilju oslobađanja aerosola koji sadrži nikotin za inhalaciju; tečni nikotinski rastvori za upotrebu u elektronskim cigaretama; elektronski uređaji za pušenje; elektronske cigarete; elektronske cigarete kao zamjena za tradicionalne cigarete; elektronski uređaji koji sadrže aerosol za inhalaciju nikotina; oralni vaporizatori za pušače, duvanski proizvodi i zamjene za duvan; artikli za pušače elektronskih cigareta; djelovi i oprema za navedene proizvode iz klase 34; uređaji za gašenje cigareta i cigara koje se zagrijevaju i duvanskih štapića koji se zagrijevaju; punjive elektronske kutije za cigarete.

(210) **Ž-2021-86**

(220) 26.02.2021.

(731) Philip Morris Products S.A., Quai Jeanrenaud 3, 2000, Neuchâtel, CH

(540)

## TEREA AMBER

(550) I

(740) Milena Pejović, Cetinjski put 11/4, The Capital Plaza , 81000, Podgorica

(511) Klasa 34: Žičani vaporizatori za elektronske cigarete i elektronske uređaje za pušenje; duvan, sirov ili prerađen; duvanski proizvodi uključujući cigare, cigarete, cigarilose, duvan za uvijanje cigareta, duvan za lule, duvan za žvakanje, duvan za šmrkanje, kretek; snus (duvan u prahu); zamjena za duvan (za nemedicinsku upotrebu); artikli za pušače, uključujući papir za cigarete, tube za cigarete, filtere za cigarete, kutije za duvan, kutije za cigarete, tabakere i pepeljare, lule, džepne mašine za uvijanje cigareta, upaljače; šibice; duvanski štapići, duvanski proizvodi za zagrijavanje, elektronski uređaji i njihovi djelovi koji se koriste za zagrijavanje cigareta ili duvana u cilju oslobađanja aerosola koji sadrži nikotin za inhalaciju; tečni nikotinski rastvori za upotrebu u elektronskim cigaretama; elektronski uređaji za pušenje; elektronske cigarete; elektronske cigarete kao zamjena za tradicionalne cigarete; elektronski uređaji koji sadrže aerosol za inhalaciju nikotina; oralni vaporizatori za pušače, duvanski proizvodi i zamjene za duvan; artikli za pušače elektronskih cigareta; djelovi i oprema za navedene proizvode iz klase 34; uređaji za gašenje cigareta i cigara koje se zagrijevaju i duvanskih štapića koji se zagrijevaju; punjive elektronske kutije za cigarete.

---

(210) **Ž-2021-87**

(220) 26.02.2021.

(731) Philip Morris Products S.A., Quai Jeanrenaud 3, 2000, Neuchâtel, CH

(540)

## TEREA BRONZE

(550) I

(740) Milena Pejović, Cetinjski put 11/4, The Capital Plaza , 81000, Podgorica

(511) Klasa 34: Žičani vaporizatori za elektronske cigarete i elektronske uređaje za pušenje; duvan, sirov ili prerađen; duvanski proizvodi uključujući cigare, cigarete, cigarilose, duvan za uvijanje cigareta, duvan za lule, duvan za žvakanje, duvan za šmrkanje, kretek; snus



(duvan u prahu); zamjena za duvan (za nemedicinsku upotrebu); artikli za pušače, uključujući papir za cigarete, tube za cigarete, filtere za cigarete, kutije za duvan, kutije za cigarete, tabakere i pepeljare, lule, džepne mašine za uvijanje cigareta, upaljače; šibice; duvanski štapići, duvanski proizvodi za zagrijavanje, elektronski uređaji i njihovi dijelovi koji se koriste za zagrijavanje cigareta ili duvana u cilju oslobađanja aerosola koji sadrži nikotin za inhalaciju; tečni nikotinski rastvori za upotrebu u elektronskim cigaretama; elektronski uređaji za pušenje; elektronske cigarete; elektronske cigarete kao zamjena za tradicionalne cigarete; elektronski uređaji koji sadrže aerosol za inhalaciju nikotina; oralni vaporizatori za pušače, duvanski proizvodi i zamjene za duvan; artikli za pušače elektronskih cigareta; dijelovi i oprema za navedene proizvode iz klase 34; uređaji za gašenje cigareta i cigara koje se zagrijevaju i duvanskih štapića koji se zagrijevaju; punjive elektronske kutije za cigarete.

---

(210) **Ž-2021-88**

(220) 05.03.2021.

(731) Centrale doo Podgorica, Novaka Miloševa 23, 81000, Podgorica, ME

(540)

## FABRIKA 1936

(550) I

(511) Klasa 35: Oglašavanje i reklamiranje naime informacije (kancelarije za komercijalne informacije); informacije (poslovne informacije); informatički podaci (pretraživanje podataka u informatičkoj kartoteci za treće lice); isporuka reklamnih materijala [letaka, prospekata, uzoraka]; isporuka reklamnih oglas; izvodi iz računa (davanje izvoda sa računa); knjige (vođenje knjiga); marketing; objavljivanje reklamnih tekstova; oglašavanje [reklamiranje]; reklamiranje on-line na informatičkoj mreži; reklamiranje putem radija; reklamiranje putem televizije; reklamna dokumentacija (uređenje reklamne dokumentacije); reklamna pošta; reklamni oglasi (širenje reklamnih oglasa); reklamni tekstovi (objavljivanje reklamnih tekstova).

Klasa 41: Razonoda naime disk džokej (usluge disk džokeja) usluge; diskoteke (usluge diskoteka); filmovi (prikazivanje igranih filmova); fotografisanje; izložbe (organizovanje izložbi) u kulturne ili obrazovne svrhe; iznajmljivanje radio i televizijskih aparata; klubovi (uluge klubova) [zabava ili obrazovanje]; koncerti (organizovanje i vođenje koncerata); organizovanje i vođenje koncerata; prijemi (planiranje prijema) [razonoda].

Klasa 43: Usluge obezbjeđivanja hrane i pića naime barovi (usluge barova); kafane [kafeterije]; kafane-restorani; restorani; restorani sa samoposluživanjem; restorani za brzo i stalno posluživanje [snek-barovi]; ugostitelji (usluge kateringa).

---

(210) **Ž-2021-89**

(220) 04.03.2021.

(731) Preduzetnik Belma Gušmirovičova koja obavlja privrednu djelatnost proizvodnja nakita "Black Madonna", Vasa Raičkovića 13/3, 81000, Podgorica, ME

(540)



(550) I

(511) Klasa 14: Žig će obuhvatiti proizvode od plemenitih materijala, najčešće srebra, ali i ostalih metala po potrebi i želji nosioca žiga i to: prstenje, narukvice, lance, privjeske, minđuše, privjeske za lance i ostali nakit.

Klasa 35: Reklamiranje proizvoda iz klase 14 i ostale reklamne aktivnosti i aktivnosti oglašavanja poput oglašavanje putem medija, novina, web portala, društvenih mreža i ostalo. Prodaja proizvoda iz klase 14 i to prodaja u okviru prodavnica na malo, prodaja na veliko, posredstvom prodajnih kataloga, dopisno ili elektronskim putem, na primjer posredstvom weba ili putem telefona.

---

(210) **Ž-2021-93**

(220) 03.03.2021.

(731) WebLab d.o.o., Jovana Tomaševića 1, 85000, Bar, ME

(540)



(550) I

(511) Klasa 35: Agencije za komercijalne oglase, agencije za uvoz-izvoz, analiza proizvodne cijene, aukcionarstvo (prodaja na aukciji), automati (iznajmljivanje automata), cijene (porecenje cijena), ekonomska predviđanja [prognoze], fakturisanje, informacije (kancelarije za komercijalne informacije), informacije (poslovne informacije), informaticke kartoteke (vodenje informatickih kartoteka), informaticki podaci (pretraživanje podataka u informatickoj kartoteci za treće lice), isporuka [distribucija] uzoraka, isporuka reklamnih materijala [letaka, prospekata, uzoraka], isporuka reklamnih oglasa, isprave (umnožavanje isprava), istraživanja za poslove, istraživanje javnog mišljenja, istraživanje za poslove, izložbe (organizovanje izložbi) u komercijalne ili reklamne svrhe, iznajmljivanje automata za prodaju sitne robe, iznajmljivanje reklamnih prostora, iznajmljivanje reklamnog materijala, iznajmljivanje vremena za reklamiranje na svim komunikacionim sredstvima, izvodi iz racuna (davanje izvoda sa racuna), izvoz-uvoz (agencije za izvoz-uvoz), javno mnijenje (istraživanje javnog mnjenja) [anketiranje], javnost (odnosi s javnošću) [propaganda],

kancelarije za reklamiranje, kancelarije za zapošljavanje, kartoteka (prikupljanje podataka u središnju kartoteku), kartoteka (sistemizovanje podataka za središnju kartoteku), komercijalna administracija u vezi licenci proizvoda i usluga trećih lica, komercijalna ili industrijska preduzeća (pomoć u vođenju komercijalnih ili industrijskih preduzeća), konsultacije u vezi vođenja poslova, lociranje teretnih vagona pomoću kompjutera, marketing, modne revije za promotivne svrhe (organizovanje), nabava za treće (usluge nabave za treće) [kupovina proizvoda i usluga za druga preduzeća], nabava za treće osobe (usluge kupovine proizvoda i usluga za druga preduzeća), narudžbine (administrativna obrada narudžbina za kupovinu), novine (usluge pretplate novina) za treće osobe, objavljivanje reklamnih tekstova, odabir osoblja psihotehničkim postupkom, odnosi s javnošću [propaganda], oglašavanje [reklamiranje], oglašavanje putem pošte, organizovanje izložbi u komercijalne ili reklamne svrhe, organizovanje poslova (savjetovanje o organiziranju poslova), osoblje (biranje osoblja psihotehničkim postupkom), osoblje (savjetovanje o osoblju), osoblje (zapošljavanje osoblja), plakatiranje [oglašavanje], podsticaj prodaje za treće osobe, podugovaranje (usluge podugovaranja) [komercijalna pomoć], pomoć u upravljanju industrijskim ili trgovačkim preduzećima, pomoć u vođenju poslova, poslovi (istraživanja za poslove), poslovi (istraživanje za poslove), poslovi (konsultacije za vođenja poslova), poslovi (obavijestjenja o poslovima), poslovi (pomoć u vođenju poslova), poslovi (savjetovanje o organizaciji i vođenju poslova), poslovi (vještacenje poslova) [ekspertize], poslovne informacije, potrošaci (pružanje komercijalnih savjeta i informacija potrošačima), predstavljanje proizvoda [demonstracija], preduzeća (pomoć u vođenju komercijalnih ili industrijskih preduzeća), preduzeća (usluge preseljenja za preduzeća), prelamanje stranica u reklamne svrhe [stavljanje u štampu u reklamne svrhe], prepis saopštenja, pretplata na novine (usluge pretplate na novine) [za treće osobe], prezentacija proizvoda na svim komunikacionim sredstvima u svrhu prodaje na malo, procjene komercijalnih poslova, prodaja (podsticaj prodaje) za treće osobe, prodaja na aukciji, proizvodne cijene (analiza proizvodnih cijena), proučavanje tržišta [marketing], radio (reklamiranje putem radija), reklamiranje (iznajmljivanje prostora za potrebe reklamiranja), reklamiranje dopisnim putem, reklamiranje on-line na informatičkoj mreži, reklamiranje putem radija, reklamiranje putem televizije, reklamna dokumentacija (urećenje reklamne dokumentacije), reklamna pošta, reklamni filmovi (proizvodnja reklamnih filmova), reklamni materijal (iznajmljivanje reklamnog materijala), reklamni materijal (razdioba reklamnog materijala), reklamni materijal (raznošenje reklamnog materijala), reklamni oglasi (širenje reklamnih oglasa), reklamni tekstovi (objavljivanje reklamnih tekstova), reklamni tekstovi (urećenje reklamnih tekstova), sajmovi (organizovanje sajmova u komercijalne ili reklamne svrhe), saopštenja (prepisi, saopštenja), savjeti o organizaciji i vođenju poslova, savjetovanje (stručno savjetovanje o poslovima), sistemizovanje podataka za središnju kartoteku, sponzori (traženje sponzora), statistički podaci (izrada statističkih podataka), stenografske usluge, stručne poslovne konsultacije, štampa (pracenje štampe), štampa (usluge pregleda štampe), tekst (obrada teksta), telefonski odgovori (usluge telefonskih odgovora) za odsutne pretplatnike, telemarketing (usluge telemarketinga), televizijsko reklamiranje, teretni vagoni (lociranje teretnih vagona pomoću kompjutera), trgovački poslovi (procjene trgovačkih poslova), tržište (proučavanje tržišta), tržište (traženje tržišta), umjetnički poslovi (profesionalno upravljanje umjetničkim poslovima), umnožavanje isprava, uvoz-izvoz (agencije za uvoz-izvoz), uzorci (isporuka uzoraka), vođenje informatičkih kartoteka, vođenje poslova (pomoć u vođenju poslova), vođenje poslova (savjetovanje o vođenju poslova), vođenje

poslova (usluge savjetovanja u vezi vocenja poslova), vocenje poslova poslovni za sportiste [poslovni menadžment], zapošljavanje (usluge kancelarije za zapošljavanje), zapošljavanje lica.

Klasa 38: Agencije za novosti, baze podataka (omogucavanje pristupa bazama podataka), bežicna radiodifuzija, elektronska pošta (omogucavanje elektronske pošte), elektronske peruke, emitiranje televizijskih programa, forumi za vocenje debata (omogucavanje održavanja foruma za vocenje debata), govorna pašta (omogucavanje govorne pošte), informacije o telekomunikacijama, informativne agencije [novosti], iznajmljivanje aparata za prijenos poruka, iznajmljivanje modema, iznajmljivanje telefaks-urecaja, iznajmljivanje telefona, iznajmljivanje telekomunikacijskih urecaja, iznajmljivanje vremena pristupa svjetskim informatickim mrežama, kompjuter (prijenos poruka i slika uz pomoc kompjutera), kompjuterski prijenos poruka i slika, kompjuterski terminali (komunikacije putem kompjuterskih terminala), komuniciranje posredstvom mreža optickih kablova, komunikacije (radiotelefonske komunikacije), komunikacije (telefonske komunikacije), komunikacije (telegrafске komunikacije), komunikacije pomocu kompjuterskih terminala, konferencije na daljinu (omogucavanje vocenja konferencija na daljinu), kupovina putem telefona (pribavljanje komunikacionih kanala za kupovinu putem telefona), otprema pošiljki, plakatiranje (usluge elektronskog plakatiranja) [telekomunikacije], pokretna radiotelefonija, poruke (prijenos poruka), prijenos cestitki putem interneta, prijenos digitalnih datoteka, prijenos poruka, prijenos poruka (iznajmljivanje urecaja za prijenos poruka), prijenos poruka i slika kompjuterom, prijenos putem satelita, prijenos telegrama [telegrama], prijenos televizijskih emisija pretplatnicima putem kabla [kablovska televizija], pristup svjetskim informatickim mrežama (iznajmljivanje vremena pristupa svjetskim informatickim mrežama), pristup svjetskim informatickim mrežama (omogucavanje pristupa svjetskim informatickim mrežama), radio programi (emitovanje radio programa), radiodifuzija, radioelektronsko pozivanje (usluge radioelektronskog pozivanja) [radio, telefon ili ostala elektronska komunikaciona sredstva], radiotelefonski prijenosi, sateliti (prijenos putem satelita), telefaks (prijenos poruka telefaksom), telefonske komunikacije, telefonske usluge, telegrafске komunikacije, telegrafске usluge, telegrami (pošiljka telegrama), telegrami (prijenos telegrama), telekomunikacije (informacije o telekomunikacijama), telekomunikacije (usluge telekomunikacionog rutera), telekomunikaciono prikljucenje na svjetsku informaticku mrežu, teleks (usluge teleksa), televizija (emitiranje televizijskih programa), televizijski programi (emitiranje televizijskih programa), vijesti (agencije za vijesti)

Klasa 42: Ambalaža (usluge dizajniranja ambalaže), analiza kompjuterskih sastava, baze podataka (obnavljanje baza podataka), daljinski nadzor kompjuterskih sistema, digitalizacija dokumenata [skeniranje], dizajneri (usluga modnih dizajnera), dizajniranje ambalaže (usluge dizajniranja ambalaže), dizajniranje graficke umjetnosti (usluge dizajniranja graficke umjetnosti i), dupliciranje informatickih programa, emisija ugljenika (pružanje naucnih informacija i savjeta u vezi smanjenja emisije ugljenika), graficka umjetnost (usluge dizajniranja graficke umjetnosti), informaticke stranice (ugošćavanje informatickih stranica), informaticki programi (dupliciranje informatickih programa), informaticki programi (iznajmljivanje informatickih programa), informaticki sistemi (osmišljavanje informatickih sistema), informaticki virusi (zaštita od informatickih virusa), instaliranje kompjuterskih programa, internet (pružanje alata za pretraživanje na internetu), iznajmljivanje informatickih programa, iznajmljivanje informatickih programa, iznajmljivanje kompjutera, iznajmljivanje veb servera, izrada [koncipiranje] kompjuterskih programa, kalibracija [mjerjenje], kompjuteri (iznajmljivanje kompjutera), kompjuteri (programiranje za

kompjutere), kompjuterski hardver (savjetovanje u vezi dizajna i razvoja kompjuterskog hardvera), kompjuterski programi (instaliranje kompjuterskih programa), kompjuterski programi (održavanje kompjuterskih programa), kompjuterski programi [softver] (izrada kompjuterskih programa), kompjuterski programi [softver] (osavremenjivanje kompjuterskih programa), konsultacije u vezi kompjuterskih programa [softvera ],kontrola kvaliteta, kontrola vozila (tehnicka kontrola vozila i automobila), konverzija infromatickih podataka i programa [nije fi zicka konverzija], konverzija podataka ili dokumenata s jednog fi zickog na elektronski disk, licence za intelektualnu svojinu (ustupanje licenci za intelektualnu svojinu), meteorološki izvještaji (usluge davanja meteoroloških izvjestaja), modni dizajneri (usluge modnih dizajnera), programiranje za kompjuteri, regulisanje autorskih prava, savjetovanje o kompjuterima, tehnicka kontrola automobila, web serveri (iznajmljivanje web servera), web stranice (kreiranje i održavanje web stranica za druge), zaštita od infromatickih virusa.

---

(210) **Ž-2021-100**

(220) 09.03.2021.

(731) OBLUN d.o.o., Džordža Vašingtona 11, 81000, Podgorica, ME

(540)



(550) I

(511) Klasa 29: Voće, konzervisano; povrće (salate od povrća); voće, kuvano; džemovi; masti, jestiva; mast za ishranu.

Klasa 30: Hljeb; pecivo (fino sitno pecivo); kolači; med; kvasac; začini.

Klasa 31: Voće, svježe; povrće, svježe; lješnik; orasi; sjeme; biljke; cvijeće prirodno.

Klasa 32: Pivo; bezalkoholna pića koja sadrže voće; voćni sokovi; sirupi za napitke.

Klasa 33: Vina; alkoholna pića koja sadrže voće; žestoka alkoholna pića; rakija; likeri.

Klasa 35: Isporuka (distribucija) uzoraka; nabava za treće (usluge nabave za treće) [kupovina proizvoda i usluga za druga preduzeća]; nabava za treće osobe (usluge kupovine proizvoda i usluga za druga preduzeća); narudžbine (administrativna obrada narudžbina za kupovinu); oglašavanje (reklamiranje); podsticaj prodaje za treće osobe; predstavljanje proizvoda ( demonstracija); prezentacija proizvoda na svim komunikacionim sredstvima u svrhu prodaje na malo ; prodaja (podsticaj prodaje) za treće lice; reklamiranje on-line na infromatičkoj mreži ; reklamiranje putem televizije; uzorci (isporuka uzoraka); izvoz-uvoz (agencije za izvoz-uvoz).

Klasa 43: Barovi (usluge barova); kafane (kafeterije); kafane-restorani; kampovi za

ljetovanje (usluge kampova za ljetovanje) (smjestaj); kantine; ljetovaliste; restorani; restorani za brzo i stalno posluživanje (nek-barovi); ugostitelji (usluge kateringa); smještaj (agencija za izdavanje smještaja) (hoteli, pansioni).

Klasa 44: Bašte; cvjetni aranžmani (pravljenje cvjetnih aranmana); pejzažna uređenja (koncepcija uređenja pejzaža); povrtlarstvo.

---

(210) **Ž-2021-119**

(220) 18.03.2021.

(731) UNICOM DOO, Ulica Slobode 70, 81000, Podgorica, ME

(540)



(550) I

(511) Klasa 18: Proizvodnja: tašni i kaiševa

Klasa 25: Proizvodnja: obuće i papuča.

---

(210) **Ž-2021-121**

(220) 17.03.2021.

(731) Svetlana Škorić, Jevrema Grujića 21, 11000, Beograd, RS

(540)

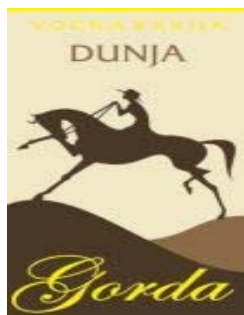

(550) I

(740) Milena Pejović, Cetinjski put 11, The Capital Plaza IV floor., 81000, Podgorica

(511) Klasa 33: Alkoholna pića (izuzev piva).

---

(210) **Ž-2021-122**

(220) 17.03.2021.

(731) Svetlana Škorić, Jevrema Grujića 21, 11000, Beograd, RS

(540)



(550) I

(740) Milena Pejović, Cetinjski put 11, The Capital Plaza IV floor., 81000, Podgorica

(511) Klasa 33: Alkoholna pića (izuzev piva).

---

(210) **Ž-2021-123**

(220) 17.03.2021.

(731) Svetlana Škorić, Jevrema Grujića 21, 11000, Beograd, RS

(540)



(550) I

(740) Milena Pejović, Cetinjski put 11, The Capital Plaza IV floor., 81000, Podgorica

(511) Klasa 33: Alkoholna pića (izuzev piva).

---

(210) **Ž-2021-142**

(220) 31.03.2021.

(731) W2 Company d.o.o., Dalmatinska bb, 81000, Podgorica, ME

(540)

**ALEXSHOP**

(550) I

(740) Miladin Popović, Đoka Miraševića 21/III, Podgorica

(511) Klasa 35: Oglašavanje i reklamiranje; vođenje komercijalnih poslova; komercijalna administracija; kancelarijski poslovi; usluge maloprodaje i veleprodaje kao i usluge on-lajn maloprodaje i/ili veleprodaje u vezi sa hemijskim proizvodima za industriju, nauku, fotografsku djelatnost, hortikulturu, poljoprivredu i šumarstvo, sirovim vještačkim smolama, sirovom plastikom, đubrivom za zemlju, mješavinom za gašenje požara, preparatima za kaljenje, zavarivanje i lemljenje metala; hemijskim proizvodima za konzervisanje hrane; sredstvima za štavljenje kože, ljepilima (ljepljive supstance) namijenjenim za industriju, bojama, lakovima i glazurama za industriju, ručne radove i umjetnost, zaštitom od rđe, od propadanja i truljenja drveta, materijama za bojenje, nagrizaćim materijalima, prirodnom sirovom smolom, metalima u listovima i u prahu za slikare, dekoratere, štampare i umjetnike, preparatima za bijeljenje i ostale materije za pranje rublja, preparatima za čišćenje, poliranje, odmašćivanje i struganje, sapunima, parfimerijskim proizvodima, eteričnim uljima, kozmetičkim proizvodima, losionima za kosu, proizvodima za njegu zuba, industrijskim uljima i mastima, sredstvima za podmazivanje, proizvodima za upijanje, vlaženje i vezivanje prašine, gorivima (uključujući benzin za motore) i rasvjetnim materijama, svijećama, fitiljima za rasvjetu, farmaceutskim i veterinarskim proizvodima, higijenskim proizvodima za upotrebu u medicinske svrhe, dijetalnim materijama za medicinske potrebe, hranom za bebe, flasterima, materijalom za previjanje, materijalima za plombiranje zuba i za zubne otiske, dezinfekcionim sredstvima, proizvodima za uništavanje životinjskih štetočina, fungicidima, herbicidima, običnim metalima i njihovim legurama, metalnim građevinskim materijalima, metalnim prenosivim konstrukcijama, metalnim materijalima za šine, metalnim užadima i neelektričnim metalnim žicama, metalnim bravarskim proizvodima i sitnim metalnim predmetima, metalnim cijevima, metalnim sefovima, metalnim proizvodima, mineralima (rude), mašinama i alatnim mašinama, motorima (osim motora za kopnena vozila), spojnicama, transmisionim uređajima (osim onih za kopnena vozila), poljoprivrednim spravama osim onih koje se pokreću ručno, inkubatorima za jaja, automatskim mašinama, ručnim alatima i spravama sa ručnim pokretanjem, priborom za jelo, hladnim oružjem, mehaničkim i elektronskim spravama za brijanje, aparatima i instrumentima za vaganje, mjerenje, signalizaciju, kontrolu (inspekciju), za pomoć (spašavanje) i za obuku, aparatima i instrumentima za vođenje, distribuciju, transformisanje, akumuliranje, podešavanje ili upravljanje električne struje, aparatima za snimanje, prenos, reprodukciju zvuka ili slika, magnetnim nosačima podataka, diskovima za snimanje, kompaktnim diskovima, DVD i drugim numeričkim nosačima za snimanje, mehanizmima za uređaje koji se pokreću uz prethodno ubacivanje novca ili žetona, registarskim blagajnama, računarima, opremom za obradu podataka i kompjuterima, uređajima za gašenje požara, kompjuterskim programima [softveri], hirurškim, medicinskim, zubarskim, i veterinarskim, aparatima i instrumentima, vještačkim udovima, očima i zubima, ortopedskim proizvodima, hirurškim priborom za zašivanje rana, uređajima za rasvjetu, grijanje, proizvodnju pare, kuvanje, hlađenje, sušenje, ventilaciju, vodosnadbjevanje i za sanitarnu opremu, vozilima, uređajima za kretanje po zemlji, po vodi ili po vazduhu i njihovim djelovima i opremom, vatrenim oružjem, municijom i projektilima, eksplozivima, sredstvima za vatromete, plemenitim metalima i njihovim legurama i proizvodima od tih metala ili obloženih tim metalima, pravim i lažnim nakitom, dragim kamenjem, časovničarskim proizvodima i hronometrijskim instrumentima, muzičkim instrumentima, papirom, kartonom i proizvodima od tih materijala, štamparskim proizvodima, proizvodima za uvezivanje knjiga, fotografijom, priborom za pisanje, ljepilima (ljepljive materije za papirnate proizvode ili za kućne potrebe), slikarskim priborom,



kistovima, pisaćim mašinama i kancelarijskim priborom (osim namještaja), opremom za nastavu i obuku (osim aparata), plastičnim materijalima za ambalažu, štamparskim slovima, klišeima, gumom, gutaperkom, biljnom smolom, azbestom, liskunom i proizvodima od tih materijala, proizvodima od polu obrađene plastike, materijalima za nepropusno zatvaranje, za zaptivanje i za izolaciju, nemetalnim savitljivim cijevima, kožom, imitacijom kože, proizvodima od tih materijala, životinjskom kožom, koferima i torbama, kišobranima, suncobranima i štapovima za hodanje, bičevima i sedlarsko remenarskim proizvodima, nemetalnim građevinskim materijalima, čvrstim nemetalnim cijevima za gradnju, asfaltom, katranom i bitumenom (smola), nemetalnim prenosivim konstrukcijama, nemetalnim spomenicima, namještajem, ogledalima, okvirima, proizvodima od drveta, plute, trske, šiblja, roga, kosti, slonovače, kitove kosti, školjki, ćilibara, sedefa, morske pjene (stive), zamjenama svih tih materijala ili plastičnim proizvodima, priborom i posuđem za domaćinstvo ili za kuhinje, češljevima i sunđerima, četkama (osim kičica), materijalima za četke, priborom za čišćenje, žicom za struganje parketa, sirovim ili polu-obrađenim staklom, staklenim proizvodima, porculanskim i keramičkim posuđem, konopcima, užadima, mrežama, šatorima, ceradama, jedrima, vrećama, materijalom za punjenje madraca (nabijanje), sirovim vlaknastim, tekstilnim materijalima, koncem za tekstilnu upotrebu, tkaninama i tekstilnim proizvodima, pokrivačima za krevete i stolove, odjećom, obućom, pokrivalima za glavu, čipkom, vezom, vrpcama i gajtanima, dugmadima, kopčama i petljama, špenadlama (duple igle) i iglama, vještačkim cvijećem, igrama i igračkama, gimnastičkim i sportskim predmetima, ukrasima za božićne jelke, mesom, ribom, živinom i divljači, mesnim ekstraktima, konzerviranim, sušenim i kuvanim voćem i povrćem, želeima, džemovima, kompotima, jajima, mlijekom i mliječnim proizvodima, jestivim uljima i mastima, kafom, čajem, kakaom, šećerom, rižom, tapiokom, sagom, zamjenom za kafu, brašnom i proizvodima od žitarica, hlebom, kolačima, poslasticama, bombonima, sladoledom, medom, sirupom od melase, kvascem, praškom za pecivo, soli, senfom, sirćetom, prelivom, začинима, raznim začинима, ledom za hlađenje, poljoprivrednim, povrtlarskim, šumskim proizvodima i bobicama, živim životinjama, svježim voćem i povrćem, sjemenjem, prirodnim biljkama i cvijećem, hranom za životinje, sladom, pivom, mineralnim i gaziranim vodama i ostalim bezalkoholnim pićem, pićem od voća i voćnim sokovima, sirupima i ostalim preparatima za pripremanje napitaka, alkoholnim pićima, duvanom, priborom za pušače, šibicama, i ostalom potrošačkom robom.

---

(210) **Ž-2021-143**

(220) 31.03.2021.

(731) Društvo za proizvodstvo, trgovija i uslugi na golemo i malo MULTIPROM DOOEL export-import Skopje, Istočna industrijska zona, Industrijska br.2, Skopje, MK

(540)



(550) I

(740) Sanja Čađenović, Vijenci Danila Kiša 2/24, 810000, Podgorica

(511) Klasa 30: Biskviti, suvi kolačići.

Klasa 35: Prodaja na veliko i prodaja na malo biskvitima.

---

(210) **Ž-2021-144**

(220) 01.04.2021.

(731) British American Tobacco Exports Limited, Globe House, 1 Water Street, WC2R 3LA, London, GB

(540)



(550) I

(740) Miladin Popović, Đoka Miraševića 21/III, Podgorica

(511) Klasa 34: Cigarete; duvan, sirov ili prerađen; duvanski proizvodi; zamjene za duvan (ne u medicinske svrhe); cigare, cigarilosi; upaljači; šibice; artikli za pušače; cigaret papir, cigaret tube, filteri za cigarete; džepni aparati za zamotavanje cigareta; ručne mašine za ubrizgavanje duvana u papirne tube; elektronske cigarete; tečnosti za elektronske cigarete; duvanski proizvodi namijenjeni za zagrijavanje.

---

(210) **Ž-2021-145**

(220) 30.03.2021.

(731) "MERIT MONTENEGRO" DOO PODGORICA, Cetinjska 11, The Capital Plaza, Podgorica, Crna Gora, ME

(540)



(550) I

(740) Luka Popović, Cetinjska 11, The Capital plaza, 81000, Podgorica

(511) Klasa 36: Nekretnine (davanje u zakup nekretnina); posredovanje u nekretninama; upravljanje nekretninama; poslovi vezani za nekretnine.

Klasa 41: Razonoda; sportske i kulturne djelatnosti; kockarnice [igre] (usluge kockarnica).

Klasa 43: Usluge obezbjeđivanja hrane i pića; privremeno primanje na stan; hotelske usluge; restorani.

---

(210) **Ž-2021-147**

(220) 02.04.2021.

(731) Apatinska Pivara Apatin d.o.o., Trg oslobođenja br.5, 25260, Apatin, RS

(540)



(550) I

(740) Pavle Tripković, City kvart - Cetinjski put 40, L5-1, stan 10, Podgorica

(511) Klasa 32: Piva, stout, lager (piva sa donjom fermentacijom ili piva donjeg vrenja), tamna piva (porter) i svijetla piva, ale piva (piva sa gornjom fermentacijom ili piva gornjeg vrenja); aromatizovano pivo; aromatizovano pivo sa ukusom voća; mineralne i gazirane vode i druga bezalkoholna pića; voćni napici i voćni sokovi; sirupi i drugi preparati za pripremanje pića.

---

(210) **Ž-2021-148**

(220) 02.04.2021.

(731) Apatinska Pivara Apatin d.o.o., Trg oslobođenja br.5, 25260, Apatin, RS

(540)



(550) I

(740) Pavle Tripković, City kvart - Cetinjski put 40, L5-1, stan 10, Podgorica

(511) Klasa 32: Piva, stout, lager (piva sa donjom fermentacijom ili piva donjeg vrenja), tamna piva (porter) i svijetla piva, ale piva (piva sa gornjom fermentacijom ili piva gornjeg vrenja); aromatizovano pivo; aromatizovano pivo sa ukusom voća; mineralne i gazirane vode i druga bezalkoholna pića; voćni napici i voćni sokovi; sirupi i drugi preparati za pripremanje pića.

---

(210) **Ž-2021-149**

(220) 02.04.2021.

(731) TOYOTA JIDOSHA KABUSHIKI KAISHA (also trading as TOYOTA MOTOR CORPORATION), 1, Toyota-cho, Toyota-shi, Aichi-ken, JP

(540)



(550) I

(740) Jasna Jusić, Marka Radovića 37, 1. sprat, stan br. 4., 81000, Podgorica

(511) Klasa 12: Automobili i njihovi strukturalni djelovi.

---

(210) **Ž-2021-150**

(220) 02.04.2021.

(731) TOYOTA JIDOSHA KABUSHIKI KAISHA (also trading as TOYOTA MOTOR CORPORATION), 1, Toyota-cho, Toyota-shi, Aichi-ken, JP

(540)

**COROLLA CROSS**

(550) I

(740) Jasna Jusić, Marka Radovića 37, 1. sprat, stan br. 4., 81000, Podgorica

(511) Klasa 12: Automobili i njihovi strukturalni djelovi.

(210) **Ž-2021-155**

(220) 02.04.2021.

(731) Albus AD Novi Sad, Privrednikova 10, 21000, Novi Sad, RS

(540)



(550) I

(740) Dalibor Roćen, ulica 13. Jula, br.3, 81000, Podgorica

(511) Klasa 3: Sredstva za beljenje i druge supstance za upotrebu u perionicama; preparati za čišćenje, poliranje, ribanje i abrazivni preparati; sapuni; parfimerija, eterična ulja, kozmetika, losioni za kosu; paste za zube.

---

(210) **Ž-2021-156**

(220) 02.04.2021.

(731) Albus AD Novi Sad, Privrednikova 10, 21000, Novi Sad, RS

(540)

**ALBUS**

(550) I

(740) Dalibor Roćen, ulica 13. Jula, br.3, 81000, Podgorica

(511) Klasa 3: Nemedicinska kozmetika i toaletni preparati; nemedicinska sredstva za čišćenje zuba; parfimerijski proizvodi, etarska ulja; sredstva za beljenje i druge supstance za upotrebu u perionicama; preparati za čišćenje, poliranje, ribanje i abrazivni preparati;  
Klasa 5: Dezinfekciona sredstva; medicinski šamponi, sapuni, losioni i sredstva za čišćenje zuba.  
Klasa 16: Toaletni papir; higijenski papir.

---

(210) **Ž-2021-157**

(220) 03.04.2021.

(731) Regulatorna agencija za energetiku i regulisane komunalne djelatnosti, Bulevar Svetog Petra Cetinjskog 96, 81000, Podgorica, Crna Gora, ME  
(540)



(550) I

(511) Klasa 35: Usluge komercijalne administracije koje se odnose na energetske subjekte i vršioce regulisanih komunalnih djelatnosti.

Klasa 45: Pravne usluge koje se odnose na pravne djelatnosti za regulaciju energetskog sektora i za regulaciju komunalnih djelatnosti.

---

(210) **Ž-2021-158**

(220) 02.04.2021.

(731) Philip Morris Brands Sàrl, Quai Jeanrenaud 3, 2000, Neuchâtel, CH

(540)

## SOHO

(550) I

(740) Milena Pejović, Cetinjski put 11/4, The Capital Plaza IV floor , 81000, Podgorica

(511) Klasa 34: Duvan, sirov ili prerađen; duvanski proizvodi; cigare, cigarete, cigarilosi, duvan zauvijanje cigareta, duvan za lule, duvan za žvakanje, duvan za šmrkanje, kretek; snus (duvan u prahu); zamjena za duvan (za nemedicinsku upotrebu); elektronske cigarete; duvanski proizvodi za zagrijavanje; elektronski uređaji i njihovi djelovi koji se koriste za zagrijavanje cigareta ili duvana u cilju oslobađanja aerosola koji sadrži nikotin za inhalaciju; tečni nikotinski rastvori za upotrebu u elektronskim cigaretama; artikli za pušaće, papir za cigarete, tube za cigarete, filteri za cigarete, kutije za duvan, kutije za cigarete, tabakere, pepeljare, lule, džepne mašine za uvijanje cigareta, upaljači; šibice.

---

(210) **Ž-2021-159**

(220) 06.04.2021.

(731) "TOMONTENEGRO" d.o.o. Podgorica, Stanka Dragojevića, br. 2 , 81000, Podgorica, Crna Gora, ME

(540)

## AIR MONTENEGRO

(550) I

(740) Pavle Tripković, City kvart - Cetinjski put 40, L5-1, stan 10, Podgorica

(511) Klasa 39: Usluge prevoza putnika i robe u vazdušnom saobraćaju, izdavanje/prodaja avio karata, organizovanje putovanja, davanje informacija o putovanjima ili transportu robe, informacije o tarifama i letovima, špeditorske usluge.

---

(210) **Ž-2021-160**

(220) 06.04.2021.

(731) Jovan Đurđevac, Rubeža, 81400, Nikšić, Crna Gora, ME

(540)



(550) I

(511) Klasa 25: Majice, šorcevi, bermude, kape, torbe, trenerke, jakne, farmerice, prsluci, donji veš.

---

(210) **Ž-2021-161**

(220) 06.04.2021.

(731) Four Seasons Hotels (Barbados) Ltd. , Chancery House, High Street, Bridgetown, BB

(540)



(550) I

(740) Jasna Jusić, Marka Radovića 37, 1. sprat, stan br. 4., 81000, Podgorica

(511) Klasa 25: Odjeća; maske od platna; obuća; pokrivala za glavu; rukavice [odjeća]; bade mantili; kupaći kostimi; marama; kravate.

Klasa 43: Privremeni smještaj; usluge pružanja hrane i pica; iznajmljivanje privremenog smještaja; usluge privremenog smještaja; rezervacije privremenog smještaja; usluge hotela i odmarališta; hotelske rezervacije; usluge restorana; usluge bara; usluge recepcije za privremeni smještaj [upravljanje dolascima i odlascima]; usluge biroa za smještaj [hoteli, pansioni]; iznajmljivanje soba za sastanke; iznajmljivanje uređaja za osvjetljenje; iznajmljivanje stolica, stolova, stolnjaka, staklenog posud; iznajmljivanje aparata za kuvanje; usluge domova za penzionere; iznajmljivanje šatora; iznajmljivanje prenosnih zgrada; obezbjeđivanje konferencijskih sadržaja; ukrcavanje za životinje; usluge jaslica; usluge restorana, kateringa i

banketa; obezbjeđivanje privremenog smještaja na brodu za krstarenje; usluge restorana i barova na brodu za krstarenje; uključujući sve gore pomenute usluge pružene elektronskim putem ili onlajn iz računarske baze podataka ili putem Interneta; informativne, savjetodavne i konsultantske usluge u vezi sa gore navedenim uslugama.

Klasa 44: Medicinske usluge; veterinarske usluge; higijenska zaštita i njega ljepote za ljude ili životinje; agrikulturne, akvakulturne, hortikulturne i šumarske usuge; spa usluge; kozmetički saloni; obezbjeđivanje sadržaja i usluga saune; usluge mršavljenja i oblikovanja figure; konsultacije i savjeti o ljepoti; usluge aromaterapije; usluge njege kućnih ljubimaca; usluge ustanova za oporavak; aranžiranje cvijeća; usluge banje; masaža; usluge baštovana-pejzažista; pejzažna uređenja.

---

(210) **Ž-2021-162**

(220) 06.04.2021.

(731) Legalis DOO Podgorica, Kralja Nikole br.4, 81000, Podgorica, Crna Gora, ME

(540)



(550) I

(511) Klasa 43: Kafane-restorani; hotelske usluge; restorani; restorani sa samoposluživanjem; restorani za brzo i stalno posluživanje [snek-barovi]; smještaj (iznajmljivanje privremenog smještaja); kampovanje (stavljanje na raspolaganje terena za kampovanja); kampovi (iskorištavanje terena za kampiranje); kampovi za ljetovanje (usluge kampova za ljetovanje) [smještaj].

---

(210) **Ž-2021-165**

(220) 08.04.2021.

(731) D.O.O. za vazdušni saobraćaj, turizam i usluge "OKI AIR MONTENEGRO", Ivana Vujoševića 46, 81000, Podgorica, Crna Gora, ME

(540)



(550) I



(511) Klasa 12: Vozila za kretanje po vazduhu; putnički autobusi; avioni; dostavna vozila; kombi vozila; helikopteri; kola; automobili.

Klasa 16: Brošure, publikacije, magazini, pribor za pisanje, nalepnice za označavanje prtljaga, bording karte, ulaznice.

Klasa 39: Usluge prevoza putnika i robe u vazdušnom saobraćaju , izdavanje/prodaja avio karata, organizovanje putovanja, davanje informacija o putovanjima ili transportu robe, informacije o tarifama i letovima, špediterske usluge.

---

**OBJAVA ŽIGOVA**  
**Publication of trademarks**

(111) **14878**

(151) 20.10.2020.

(210) Ž-2019-218

(220) 10.06.2019.

(732) RA Trupo Holdings LLC, c/o Ripplewood Advisors LLC, 920 Broadway, 6th Floor, NY 10010, New York, US

(540)

**SME In A Box**

(550) I

(740) AOD "Ćupić", Bulevar Džordža Vašingtona 79, 81000, Podgorica

(511) Klasa 36: Bankarske usluge, bankarske konsultacije, on-lajn bankarske usluge, bankarski tenderi, elektronsko bankarstvo putem globalne kompjuterske mreže, usluge finansijskog menadžmenta; finansijske konsultacije.

---

(111) **14908**

(151) 30.12.2020.

(210) Ž-2019-199

(220) 20.05.2019.

(300) US, Broj 88/389914 od 17.04.2019

(732) Reign Beverage Company LLC, a Delaware limited liability company, 1547 N. Knowles Ave., 90063, Los Angeles, California, US

(540)

**REFUEL.REFRESH.RECOVER.**

(550) I

(740) Božidar S. Radulović, Studentska bb, Lamela 3/18, 81000, Podgorica

(511) Klasa 32: Bezalkoholna pića.

---

(111) **14945**

(151) 07.04.2021.

(210) Ž-2019-278

(220) 12.07.2019.

(732) Kite Pharma, Inc. (Delaware corporation), 2400 Broadway, 90404, Santa Monica, California, US

(540)



(550) I

(740) Božidar S. Radulović, Studentska bb, Lamela 3/18, 81000, Podgorica

(511) Klasa 5: Farmaceutski preparati, naročito preparati za tretman kancera i tumora; farmaceutski preparati za imunoterapiju, uključujući terapiju T ćelijama.

Klasa 44: Pružanje medicinskih informacija; obezbeđivanje internet sajta na kome se nalaze medicinske informacije; pružanje medicinskih informacija, konsultantskih i savetodavnih usluga; uzimanje i čuvanje bioloških tkiva, krvi i ćelija.

---

(111) **14979**

(151) 17.02.2021.

(210) Ž-2019-358

(220) 18.09.2019.

(732) Bosnalijek, farmaceutska i hemijska industrija, dionicko društvo, Jukićeva 53, 71000, Sarajevo, BA

(540)

## LYSOBACT P SPRAY

(550) I

(740) Božidar S. Radulović, Studentska bb, Lamela 3/18, 81000, Podgorica

(511) Klasa 5: Farmaceutski proizvodi.

---

(111) **15037**

(151) 19.11.2020.

(210) Ž-2019-348

(220) 11.09.2019.

(732) Papoutsanis S.A., 71st klm Ethnikis Odou Athinon Lamias,Vathi Avlidos,(in English 71st klm National Road Athens-Lamia, 34100 Halkida), 34100, Halkida, GR

(540)



(550) I

(740) AOD "Ćupić", Bulevar Džordža Vašingtona 79, 81000, Podgorica

(511) Klasa 3: Šamponi i balzami za kosu; maske za kosu; pjene za kupanje; ulja za kozmetičke svrhe; ulja za kosu i tijelo; sapuni za ličnu upotrebu; sapuni za lice; sapuni za tijelo; piling sapuni; glicerinski sapuni; tečni sapuni; sredstva za čišćenje za intimnu ličnu higijenu, nemedicinski; kozmetičke kreme i kozmetičke emulzije za lice i tijelo; losioni za lice i tijelo; mirisni sprej za ličnu upotrebu; mirisi; preparati za zaštitu od sunca i preparati za sunčanje (ne za medicinske svrhe); gelovi za njegu stopala, nemedicinski; preparati za uklanjanje šminke; preparati prije brijanja i posle brijanja.

---

(111) **15038**

(151) 19.11.2020.

(210) Ž-2019-349

(220) 11.09.2019.

(732) Papoutsanis S.A., 71st klm Ethnikis Odou Athinon Lamias,Vathi Avlidos,(in English 71st klm National Road Athens-Lamia, 34100 Halkida), 34100, Halkida, GR

(540)



(550) I

(740) AOD "Ćupić", Bulevar Džordža Vašingtona 79, 81000, Podgorica

(511) Klasa 3: Šamponi i balzami za kosu; maske za kosu; pjene za kupanje; ulja za kozmetičke svrhe; ulja za kosu i tijelo; sapuni za ličnu upotrebu; sapuni za lice; sapuni za tijelo; piling sapuni; glicerinski sapuni; tečni sapuni; sredstva za čišćenje za intimnu ličnu higijenu, nemedicinski; kozmetičke kreme i kozmetičke emulzije za lice i tijelo; losioni za lice i tijelo; mirisni sprej za ličnu upotrebu; mirisi; preparati za zaštitu od sunca i preparati za sunčanje (ne za medicinske svrhe); gelovi za njegu stopala, nemedicinski; preprati za uklanjanje šminke; preparati prije brijanja i posle brijanja.

---

(111) **15058**

(151) 30.12.2020.

(210) Ž-2018-291

(220) 07.08.2018.

(732) SUNRAF BEACH PROPERTIES DOO, VASA RAIČKOVIĆA 2B, 81000, PODGORICA, ME

(540)

## Sunset caffe

(550) I

(511) Klasa 8: Ručni alati i sprave (kojima se ručno upravlja); pribor za jelo; hladno oružje; žileti; oruđa u odgovarajućim profesijama; sekače (sjeciva - noževi) od dragocjenih metala; električne brijalice i šišalice (ručne naprave).

Klasa 12: Vozila;aparati za kretanje po zemlji1 vazduhu ili vodi; motore i mašine za kopnena vozila; mašinske spojnice i transmisione elemente za kopnena vozila; vozila na vazduši jastuk.

Klasa 16: Hartija,karton i proizvodi od njih1 koji nisu uključeni u druge klase; štampane stvari; knjigovezački materijal; fotografije; kancelarijski materijal; ljepila za kancelarijske i kućne potrebe; umjetnički materijali; kičice; pisaće mašine i kancelarijski rekviziti (izuzev namještaja); materijali za obuku i nastavu (izuzev aparata); plastični materijal za pakovanje (koji nije uključen u druge klase); štamparska slova; klišei; pribor za kancelarije; noževe za papir; aparate za kopiranje; plastične folije, torbe, vreće za uvijanje i pakovanje; ručne alate za umjetnike ( npr. lopatice, spahtle, dlijeta za vajare, karte za igru.

Klasa 18: Koža i imitacija kože, proizvodi izrađeni od ovih materijala koji nisu uključeni u druge klase; životinjska koža, krzno; koferi i putne torbe; kišobrani, suncobrani i štapovi za hodanje; bičevi, saračka i sedlarska oprema.

Klasa 20: Namještaj, ogledala, okviri za slike; proizvodi (koji nisu obuhvaćeni drugim klasama) od drveta, plute, trske, rogoza, vrbovog pruća, roga, kosti, slonovace, kitove kosti, školjki, ćilibara, sedefa, morske pjene i zamjene svih ovih materijala, ili od plastike; metalni nameštaj i namještaj za kampovanje; opremu za krevete (npr. dušeke, dušeke sa federima, jastuke); ogledala, ukrasna ogledala na namještaju i toaletna ogledala; table sa registarskim brojevima koje nisu od metala; poštanske sandučice koji nisu od metala ili zidani.

Klasa 25: Odjeća, obuća, pokrivala za glavu.

Klasa 30: Kafa, čaj, kakao, šećer, pirinač, tapioka, sago, zamjena kafe; brašno i proizvodi od žitarica, hljeb, kolači i poslastice, sladoledi; med, melasa; kvasac, prašak za pecivo; so, senf; sirće, sosovi (kao dodaci); začini; led, pića od kakaoa, kafe ili na bazi čokolade; žitarice pripremljene za ljudsku ishranu ( npr. ovasne pahuljice i druge koje se prave od ostalih žitarica).

Klasa 34: Duvan; artikli za pušače; šibice.

Klasa 43: Usluge obezbjeđivanja hrane i pića; privremeni smještaj; usluge rezervisanja turističkih smještaja, naročito preko turističkih agencija ili brokera; smještaj za životinje.

---

(111) **15059**

(151) 30.12.2020.

(210) Ž-2019-476

(220) 29.11.2019.

(732) "FOOD CONCEPT SOLUTIONS" DOO, VOJNA KASARNA BB, KUMBOR / PORTONOVI LOWER VILLAGE 04, 85340, HERCEG NOVI, ME

(540)



(550) I

(511) Klasa 30: Kafa, čaj, kakao, šećer, riža, tapioka, sago, zamjene za kafu; brašno, proizvodi od žitarica, hleb, kolači, poslastice, bomboni, sladoled; med, sirup od melase; kvasac, prašak za pecivo; so, senf; sirće, prelive; začini; razni začini; led za hladenje; prehrambene namirnice biljnog porijekla pripremljene za potrošnju ili za konzervisanje, kao i dodatke za poboljšanje ukusa hrane; napitke od kave, kakaoa ili čokolade ili čaja; žitarice pripremljene za ljudsku prehranu (na primjer: ovsene pahuljice ili pahuljice od drugih žitarica).

---

(111) **15060**

(151) 30.12.2020.

(210) Ž-2019-325

(220) 30.08.2019.

(732) Montenegro Master Security doo, Herceg Novi, Kucanska bb, 85346, Zelenika, ME  
(540)



(550) I

(511) Klasa 9: Kamere i snimači za video nadzor, protiv požarni uređaji, protiv provalni uređaji, uređaji za kontrolu pristupa i kontrolu radnog vremena, ruteri, ripiteri, svičevi, mjerni uređaji, hard diskovi, Micro SD kartice, Fleš memorije, čitači kartica i tagova, beskontaktna kartice.

Klasa 35: Prodaja na veliko i malo: Analognih i digitalnih kamera za video nadzor, snimača za video nadzor, alarmnih i protiv požarnih uređaja, uređaja za kontrolu pristupa i kontrolu radnog vremena, interfonskih i satelitskih sistema, rutera, access pointa i ripitera, svičeva, Micro SD kartica i Fleš memorija, mjernih uređaja, hard diskova, RFID i Smart čitača, bezkontaktnih kartica.

Klasa 37: Instalacija i podešavanje sistema za video nadzor, alarmnih i protiv požarnih sistema, sistema za kontrolu pristupa i kontrolu radnog vremena, interfonskih i satelitskih sistema, mjernih uređaja, RFID i Smart čitača, popravka i održavanje sigurnosnih sistema, zamjena postojećih sistema sa naprednijim modelima, praćenje događaja u monitoring centru, održavanje računara i računarske opreme, umrežavanje računara, instalacije niske struje, wireless internet, instalacija rutera, access pointa i ripitera.

---

(111) **15062**

(151) 30.12.2020.

(210) Ž-2017-226

(220) 14.06.2017.

(732) Goodyear Tyres UK Limited, 2920 Trident Court, Solihull Parkway Birmingham Business Park, B37 7YN, Birmingham, GB

(540)

**GEOMAX ENDURO**

(550) I

(740) Jasna Jusić, Dalmatinska 2, 81000, Podgorica

(511) Klasa 12: Gume.

---

(111) **15064**

(151) 22.12.2020.

(210) Ž-2019-375

(220) 30.09.2019.

(732) VIVO MOBILE COMMUNICATION CO., LTD., 283#, BBK Road, Wusha, Chang'an, Dongguan, Guangdong, CN

(540)

**NEX**

(550) I

(740) Miladin Popović, Đoka Miraševića 21/III, 81000, Podgorica

(511) Klasa 9: Pametni telefoni; Mobilni telefoni; Futrole za mobilne telefone; Navlake za mobilne telefone; Zaštitne folije prilagođene za ekrane mobilnih telefona; Stalci prilagođeni za mobilne telefone; Slušalice; Setovi za mobilne telefone; Selfi štapovi za upotrebu sa pametnim telefonima; USB kablovi; Ispravljači struje; Baterije, električne; Punjači baterija; Prenosive stanice za punjenje (baterije koje se mogu dopunjavati); Zvučnici; Pametni zvučnici; Bežični setovi za pametne telefone; Bežični punjači; Softver za preuzimanje aplikacija za mobilne telefone; Kompjuteri; Pametne naočare; Pametni satovi; Tablet računari; Noutbuk računari; Televizori; Pametni televizori; Bežične slušalice; Bežični zvučnici;

---

(111) **15063**

(151) 30.12.2020.

(210) Ž-2018-473

(220) 30.11.2018.

(732) Robert Balla, ul.Sent Laslo put 15. 3 sprat / 12 a, 1135, Budimpešta, HU

(540)

**FOLDANA**

(550) I

(740) Valentina Dujović Radulović, ul. Špira Mugoše br. 4, Podgorica

(511) Klasa 35: Usluge oglašavanja, marketinga i promocije; Usluge poslovne analize, istraživanja i poslovnih informacija; Usluge poslovne pomoći, upravljanja i administracije; Iznajmljivanje prodajnih štandova; Veleprodajne usluge vezane uz jednokratne papirne proizvode; Maloprodajne usluge vezane za jednokratne papirne proizvode; Maloprodajne



usluge u vezi s građevinskim materijalom, Veleprodajne usluge u vezi s opremom za informacionu tehnologiju; Maloprodajne usluge u vezi s opremom za informacionu tehnologiju; Maloprodajne usluge narudžbine kozmetičkih proizvoda poštom; Usluge online trgovina za maloprodaju kozmetičkih proizvoda; Maloprodajne usluge u vezi s računarskim softverom; Maloprodajne usluge u vezi sa računarskim hardverom; Maloprodajne usluge u vezi s pametnim telefonima; Maloprodajne usluge u vezi s pametnim satovima; Maloprodajne usluge u vezi s kancelarijskim priborom; Maloprodajne usluge u vezi s kućnim aparatima; Maloprodajne usluge u vezi s kućnom električnom opremom; Maloprodajne usluge povezane s prodajom pretplatničkih kutija koje sadržavaju čokolade; Veleprodajne usluge u vezi s navigacijskim uređajima; Veleprodajne usluge u vezi s računarskim softverom; usluge u vezi s računarskim hardverima; Maloprodajne usluge vezane za štampani materijal; Veleprodajne usluge u vezi s štampanim materijalom; Veleprodajne usluge u vezi s kancelarijskim priborom; Maloprodajne usluge u vezi s kancelarijskim priborom; Maloprodajne usluge vezane uz toaletne proizvode; Online maloprodajne usluge u vezi sa digitalnom muzikom koja se može preuzeti; Veleprodajne usluge u vezi sa školnim priborom; Online maloprodajne usluge u vezi sa zvukovima zvona koji se mogu preuzeti; Online maloprodajne usluge u vezi sa muzikom i filmovima koji se mogu preuzeti i onima koji su unaprijed snimljeni; Maloprodajne usluge u vezi sa gorivima; Veleprodajne usluge u vezi sa gorivima;

Klasa 36: Prikupljanje finansijskih sredstava i finansijsko pokroviteljstvo; Osiguravajuće usluge; Pružanje pripejd kartice i tokena; Usluge agencija za nekretnine, Usluge finansijske procjene; Finansijske i novčane usluge i bankarstvo; Usluge čuvanja u sefu; Prikupljanje finansijskih sredstava i pokroviteljstva;

Klasa 37: Istrebljivanje, dezinfekcija i uklanjanje štetočina; Vađenje prirodnih resursa, Izgradnja, građevinarstvo i rušenje; Iznajmljivanje alata, pogona i opreme za gradnju i rušenje; Usluge ukrasnog bojenja; Postavljanje pločica, cigli i blokova; Obnavljanje enterijera zgrada; Sanacija građevinskih radova; Čišćenje zidnih površina; Održavanje drvenih podova;

Klasa 45: Pravne usluge; Usluge spasavanja, sigurnosti i sprovođenje; Detektivske usluge, Konsultantske usluge u vezi sa sprječavanjem kriminala; Usluge online društvene mreže; Mentorstvo (duhovno); Usluge internetskog društvenog umrežavanja kojima se može pristupiti putem mobilnih aplikacija koje se mogu preuzeti; Stanovi (usluge čuvanja stanova u odsustvu vlasnika); Eskort usluge; Odabir ličnih poklona za druge; Pisanje ličnih pisama; Usluge ličnog predstavljanja; Usluge modnog savjetovanja u vezi sa ličnim stajlingom.

---

(111) **15065**

(151) 22.12.2020.

(210) Ž-2019-409

(220) 25.10.2019.

(732) Alibaba Group Holding Limited, Fourth Floor, One Capital Place, P.O. Box 847, George Town, Grand Cayman, KY

(540)

EWTP

(550) I

(740) Jasna Jusić, Dalmatinska 2, 81000, Podgorica

(511) Klasa 9: Aparati i instrumenti naučni, istraživački, navigacioni, geodetski, fotografski, kinematografski, audiovizuelni, optički, za vaganje, mjerenje, signalizaciju, otkrivanje, testiranje, ispekciju, spasavanje i nastavu; aparati i instrumenti za provodenje, prekid, transformaciju, akumulaciju, regulisanje ili kontrolu distribucije ili upotrebe električne energije; aparati i instrumenti za snimanje, prenošenje, reprodukovanje ili obradivanje zvuka, slike ili podataka; podaci koji su snimljeni i koji se mogu preuzeti, računarski softver, prazni nosači podataka za digitalno ili analogno snimanje i skladištenje; magnetni nosači podataka, diskovi za snimanje; mehanizmi za aparate koji se pokreću novcem; registar kase, uredaji za računanje, oprema i računari za obradu podataka; periferni računarski uredaji; odijela za ronjenje, maske za ronjenje, čepovi za uši za ronioce, štikaljke za nos za ronioce i plivače, rukavice za ronioce, aparati za disanje za podvodno plivanje; računarski programi; računarski programi u obliku aplikacije za mobilne uredaje i računare; softverske aplikacije za korišćenje sa mobilnim uredajima; softver za obradu elektronskih plaćanja za druge i od drugih; softver za autentifikaciju; kompjuterski softver koji se može naći na internetu; onlajn elektronske publikacije (koje se mogu preuzeti sa interneta ili kompjuterske mreže ili iz kompjuterske baze podataka); softver za razmjenu trenutnih poruka; softver za dijeljenje datoteka; komunikacijski softver za elektronsku razmjenu podataka, audio i video sadržaja, slika i grafika putem računarskih, mobilnih, bežičnih i telekomunikacionih mreža; računarski softver za obradu slika, grafike, audio sadržaja, video sadržaja, i teksta; kompjuterski softver koji se može preuzimati koji olakšava elektronski prenos informacija, podataka, dokumenata, glasa i slika preko Interneta; računarske aplikacije za emitovanje audio materijala, video materijala, videa, muzike i slike; uredaji za emitovanje digitalnog sadržaja; računarski softver koji se može preuzimati koji omogućava korisnicima da učestvuju na onlajn sastancima i časovima, sa pristupom podacima, dokumentima, slikama i softverskim aplikacijama kroz internet pretraživač; računarski softver koji se može preuzeti za pristup, pregled, i upravljanje udaljenim računarima i računarskim mrežama; softver za računarstvo u oblaku koji se može preuzimati; softver koji se nalazi u oblaku, a koji se može preuzimati; računarski softver; računarski softver (uključujući softver koji se može preuzimati sa interneta); digitalna muzika (koja se može preuzimati sa interneta); igre, slike, igrani filmovi, filmovi i muzika koji se mogu preuzeti; računari, programi i softveri za elektronske i video igre (uključujući softvere koji se mogu preuzimati sa interneta); elektronske publikacije koje se mogu preuzimati, u obliku časopisa, članaka, brošura, lifleta, tehničkih specifikacija, informacionih materijala, priručnika u oblastima poslovanja, elektronske trgovine, informacionih tehnologija, računarstva u oblaku, telekomunikacija, interneta, obuka u vezi sa poslovanjem i elektronskom trgovinom, upravljanja poslovanjem, prodajom, marketingom i finansijama; poluprovodnici; poluprovodnička integrisana kola; poluprovodnički memorijski čipovi; poluprovodnički memorijski kontroleri; poluprovodnička memorijska integrisana kola; poluprovodnički procesorski čipovi; poluprovodnički procesori; mikrokontroleri; mikrokontrolerske jedinice; mikrokontroleri sa niskim naponom; čipovi za kola; čipovi za računare; CPU (centralna procesorska jedinica); RISC-V računarski čipovi i centralne procesorske jedinice; računarski čipovi i centralnim procesorskim jedinicama sa arhitekturom skupa instrukcija; računarske periferalne jedinice; noutbuk računari; laptop računari; prenosivi računari; ručni računari; tablet

računari; lični digitalni asistenti; lični media plejeri; mobilni telefoni; pametni telefoni; digitalne kamere; baterije, punjaci za baterije; računarske radne stanice; računarski serveri; kompjuterski i telekomunikacioni mrežni hardver; kompjuterski mrežni adapteri, prekidači, ruteri i habovi (razvodnici); bežični i žični modemi i komunikacione kartice i uređaji; držači za laptop, torbe za računare; aparti za gašenje požara; kompjuterski hardver i firmver; automobilski sistemi za navigaciju; kompakt diskovi; telekomunikacijski aparati; podloge za miševе; slušalice za mobilne telefone; dodaci za mobilne telefone; sistemi za alarme; bezbjednosne kamere; mobilne radio i televizijske jedinice za emitovanje; oprema za televizijsko emitovanje; kamere; video kamere; slušalice; telefonske slušalice koje se nose u uvetu; zvučnici; uređaji i oprema za globalno pozicionirajući sistem [GPS]; displeji od tečnih kristala za telekomunikacionu i elektronsku opremu; set top boks; daljinski upravljači; programi za skladištenje podataka; naočare i naočare za sunce; elektronske table sa natpisom; kodirane ili magnetne bankovne kreditne, debitne, gotovinske, platne, telefonske i identifikacione kartice; automatski bankomati, uređaji za podizanje gotovine; računarske softverske aplikacije, koje se mogu preuzimati; čitači elektronskih knjiga; toner kertridži, prazni, za štampače i fotokopire; uređaji za nadgledanje beba; video uređaji za nadgledanje beba; poklopci za fotografska sočiva; kodirane ključ kartice; 3D naočare; memorijske kartice za mašine za video igre.

Klasa 35: Oglašavanje; vođenje poslova; poslovno upravljanje; kancelarijski poslovi; širenje poslovnih informacija o robama i uslugama drugih putem lokalnih i globalnih računarskih mreža; usluge poslovnog savjetovanja koje se odnose na pružanje veb stranica na globalnoj računarskoj mreži putem kojih treće strane mogu ponuditi i dostaviti robe i usluge, plasirati, determinisati ugled i zadovoljiti potencijalnu saradnju i narudžbe, sklapati ugovore i poslovne transakcije; pružanje usluga online naručivanja putem računara; usluge poslovnog savjetovanja u vezi s radom na elektronskom tržištu za kupce i prodavce roba i/ili usluga na globalnoj računarskoj mreži; poslovna pomoć koja se odnosi na olakšavanje poslovne transakcije putem lokalnih i globalnih računarskih mreža; pružanje prodajnih, poslovnih, reklamnih i promotivnih informacija putem globalne računarske mreže i putem interneta; usluge poslovne administracije za obradu prodaje ostvarene na Internetu; usluge trgovanja na mreži u vezi s elektronskim aukcijama i onlajn pružanje poslovnih procjena u vezi s tim; usluge poslovnog upravljanja u vezi s elektronskom trgovinom; organizacija, rukovođenje i nadgledanje programa lojalnosti i podsticajnih programa; proizvodnja televizijskih i radio reklama; računovodstvo; usluge prodaje putem licitacije; sajmovi; ispitivanje javnog mnjenja; obrada podataka; pružanje poslovnih informacija; usluge reklamnih agencija; upravljanje bazama podataka; sakupljanje informacija u kompjuterske baze podataka; usluge poslovnog savjetovanja; usluge upravljanja poslovnim projektima; usluge istraživanja tržišta; usluge međunarodnih agencija za uvoz i izvoz; iznajmljivanje reklamnog prostora na komunikacijskim medijima; obezbjeđivanje direktorijuma Internet stranica trećih strana za olakšavanje poslovnih transakcija; komercijalna administracija za licenciranje roba i usluga drugih; kompjuterska obrada podataka; usluge informisanja o prodaji, poslovanju i promocijama; javljanje na telefon (za druge); upravljanje osobljem; predstavljanje robe na komunikacijskim medijima za maloprodajne svrhe; usluge agencija za kupovinu i prodaju; izbor i nabavka robe za fizička i pravna lica; usluge naručivanja (za druge); sekretarske usluge; organizacija izložbi za komercijalne ili reklamne svrhe; organizacija modnih revija u komercijalne svrhe; organizacija modnih revija u promotivne svrhe; usluge poslovne pomoći u vezi sa sakupljanjem i iznajmljivanjem listi adresa; poslovno istraživanje; usluge poslovnih preporuka i raspoređivanja osoblja; agencije za uvoz-izvoz (usluge agencija za uvoz-

izvoz); agencije za novinske pretplate; iznajmljivanje kancelarijske opreme; upravljanje odnosima sa mušterijama; usluge poslovnog upravljanja i administracije u vezi sa programima sponzorstava; računovodstvene usluge; dobrotvorne usluge, naime organizacija i vodenje volonterskih programa i projekata društvenog servisa; iznajmljivanje štandova za prodaju; pružanje informacija o komercijalnim i poslovnim kontaktima; optimizacija pretraživača; optimizacija saobraćaja sa veb stranice; usluge komercijalnog posredovanja; poslovno upravljanje za nezavisne pružaoce usluga; pregovaranje i zaključivanje trgovinskih transakcija za treća lica; ažuriranje i održavanje podataka u kompjuterskim bazama podataka; usluge maloprodaje i veleprodaje, sve u vezi sa hemikalijama koje se koriste u industriji, nauci i fotografiji, kao i u poljoprivredi, vrtlarstvu i šumarstvu, neobrađenim vještačkim smolama, neobrađenom plastikom, kompostu, stajskim gnojivima, dubrivima; usluge maloprodaje i veleprodaje, sve u vezi sa bojama, firnazima, lakovima, konzervansima protiv rde i protiv propadanja drveta, pigmentima, farbama, mastilima za štampanje, obilježavanje i graviranje, sirovih prirodnih smola, metala u foliji i u prahu za upotrebu u slikarstvu, dekorisanju, štamparstvu i umjetnosti; usluge maloprodaje i veleprodaje, sve u vezi sa nemedicinskom kozmetikom i toaletnim priborom, nemedicinskim zubnim sredstvima, parfimerijom, eteričnim uljima, preparatima za parfimiranje soba, preparatima za bijeljenje i drugim supstancama koje se upotrebljavaju za rublje, preparati za čišćenje, poliranje, ribanje i abrazivni preparati; usluge maloprodaje i veleprodaje, sve u vezi sa farmaceutskim, medicinskim i veterinarskim preparatima, sanitarnim preparatima za medicinske svrhe, dijetalnom hranom i supstancama prilagodjenim za medicinsku ili veterinarsku upotrebu, hranom za bebe, dodacima ishrani za ljude i životinje, zavojima, materijalima za zavijanje, kompletima za prvu pomoć, materijalom za plombiranje zuba, zubnim voskom, dezinfekcionim sredstvima, preparatima za uništavanje štetočina, fungicidima, herbicidima; usluge maloprodaje i veleprodaje, sve u vezi sa običnim metalima i njihovim legurama, rudama, metalnim materijalima za izgradnju i konstrukciju, prenosivim metalnim građevinskim konstrukcijama, neelektričnim kablovima i žicama od običnih metala, sitnim metalnim predmetima, metalnim kontejnerima za skladištenje ili transport, sefovima; usluge maloprodaje i veleprodaje, sve u vezi sa mašinskim alatima, električnim alatima, motorima i pogonskim mašinama (osim za kopnena vozila), mašinskim spojnicama i transmisionim elementima (osim za kopnena vozila); usluge maloprodaje i veleprodaje, sve u vezi sa poljoprivrednim alatima (osim ručnog alata), inkubatorima za jaja, automatskim uredajima za prodaju, električnim aparatima za kuhinju, mašinama za brisanje, čišćenje, pranje i pranje veša; usluge maloprodaje i veleprodaje, sve u vezi s ručnim alatom i spravama (kojima se ručno upravlja), priborom za jelo, hladnim oružjem (osim vatrenog oružja), žiletima, električnim brijačima; usluge maloprodaje i veleprodaje, sve u vezi sa naučnim, nautičkim, geodetskim, fotografskim, kinematografskim, optičkim, za vaganje, za mjerenje, signalnim, kontrolnim (nadzornim), aparatima i instrumentima za spašavanje života i nastavnim uredajima, aparatima i instrumentima za vodenje, skretanje, transformisanje, akumuliranje, regulisanje ili kontrolom električne energije; usluge maloprodaje i veleprodaje, sve u vezi sa uredajima za snimanje, prenos ili reprodukciju zvuka ili slike, magnetnim nosačima podataka, diskovima za snimanje, mehanizmima za aparate koji se pokreću kovanicama, kasama, računskim mašinama; usluge maloprodaje i veleprodaje, sve u vezi s opremom i računarima za obradu podataka, računarskim softverom, softverskim aplikacijama za mobilne uredaje i računare, softverskim aplikacijama za upotrebu sa mobilnim uredajima, softverom za obradu elektronskih plaćanja, softverom za autentifikaciju, elektronskim publikacijama (koje se mogu preuzimati); usluge maloprodaje i

veleprodaje, sve u vezi sa softverom za instant poruke, softverom za dijeljenje datoteka, softverom za elektronsku razmjenu i dijeljenje podataka, audio zapisa, video zapisa, slika i grafike putem računarskih, mobilnih, bežičnih i telekomunikacionih mreža, računarski softver za obradu slika, grafike, audio zapisa, video zapisa i teksta; maloprodajne i veleprodajne usluge, sve u vezi sa računarskim softverom koji se može preuzeti, a koji omogućava korisnicima da učestvuju u sastancima i predavanjima na mreži, računarskim softverom za pristup, gledanje i kontrolu udaljenih računara i računarskih mreža, softverom za računarsko korišćenje u oblaku, računarskom perifernom opremom; usluge maloprodaje i veleprodaje, sve u vezi sa poluprovodnicima, poluprovodničkim integrisanim kolima, poluprovodničkim memorijskim čipovima, poluprovodničkim memorijskim kontrolerima, poluprovodničkim memorijskim integrisanim kolima, poluprovodničkim procesorskim čipovima, poluprovodničkim procesorima, mikrokontrolerima, jedinicama mikrokontrolera, mikrokontrolerima male snage, čipovima kota, računarskim čipovima; usluge maloprodaje i veleprodaje, sve u vezi sa CPU-om (centralnom procesorskom jedinicom), RISC-V računarskim čipovima i centralnim procesorskim jedinicama, računarskim čipovima i centralnim procesorskim jedinicama sa arhitekturom skupa instrukcija; usluge maloprodaje i veleprodaje, sve u vezi sa ličnim digitalnim asistentima, ličnim medijskim plejerima, mobilnim telefonima, pametnim telefonima, digitalnim fotoaparatom, baterijama, punjačima baterija, računarskim serverima, računarskim i telekomunikacionim mrežnim hardverom, računarskim mrežnim adapterima, svičevima (skretnicama), ruterima i habovima (razvodnicima), bežičnim i žičanim modemima i komunikacijskim karticama i uredajima, držačima za laptop; usluge maloprodaje i veleprodaje, sve u vezi sa računarskim torbama, aparatima za gašenje požara, kompakt diskovima, digitalnom muzikom (koja se može preuzimati), telekomunikacionim aparatima, podlogama za miš, dodacima za mobilne telefone, igricama koje se se mogu preuzimati, slikama, igranim filmovima, filmovima i muzikom, alarmnim sistemima, sigurnosnim kamerama; usluge maloprodaje i veleprodaje, sve u vezi sa mobilnim radio i televizijskim emitterskim jedinicama, televizijskom opremom za emitovanje, uredajima i opremom za sistem globalnog pozicioniranja (GPS), programima za čuvanje podataka, naočarima i sunčanim naočarima, elektronskim tablama sa natpisima; usluge maloprodaje i veleprodaje, sve u vezi s kodiranim ili magnetnim bankarskim kreditnim, debitnim, gotovinskim i identifikacionim karticama, automatskim šalter-mašinama, držačima gotovine (u smislu fioke za gotovinu u bankomatima), uredajima za čitanje elektronskih knjiga, praznim kertridžima za štampače i fotokopir uredaje, monitorima za bebe, okvirima i pokolopcima za objektivne, kodiranim ključ karticama, 3D naočarima, memorijskim karticama za mašine za video igre, magnetima, zaštitnom odjećom, zaštitnim kacigama, zaštitnim rukavicama, zaštitnom obućom; usluge maloprodaje i veleprodaje, sve u vezi sa hirurškim, medicinskim, stomatološkim i veterinarskim aparatima i instrumentima, vještačkim udovima, očima i zubima, ortopedskim proizvodima, materijalima za šivenje, terapijskim i pomoćnim uredajima prilagođenim osobama sa invaliditetom, aparatima za masažu, aparatima, uredajima i proizvodima za dojenčad, uredajima i proizvodima za seksualnu aktivnost; usluge maloprodaje i veleprodaje, sve u vezi sa terapijskim aparatima na topli vazduh, električnim pokrivačima za medicinske svrhe, aparatima za testiranje u medicinske svrhe, aparatima za testiranje krvi, slušnim aparatima za gluve, zaštitnim uredajem za sluh, električnim pokrivačima za medicinske svrhe, dijagnostičkim aparatima za medicinsku upotrebu, vještačkim udovima, očima i zubima, potpornim zavojima, dječijim flašicama, cuclama za flašice za hranjenje beba, strugalicama za jezik; usluge maloprodaje i veleprodaje, sve u vezi sa uredajima i instalacijama za osvjjetljenje, grijanje,

hladenje, proizvodnju pare, kuvanje, sušenje, ventilaciju, vodosnabdijevanje i sanitarne svrhe; usluge maloprodaje i veleprodaje, sve u vezi sa vozilima, aparatima za kretanje kopnom, vazduhom ili vodom, biciklima, djelovima i priborom za vozila, djelovima i priborom za bicikla, bezbjednosnim sjedištima za djecu u vozilima, sigurnosnim pojasevima za sjedišta, gumama, zakrpama za gume, navlakama za gume; usluge maloprodaje i veleprodaje, sve u vezi sa vatrenim oružjem, municijom i projektilima, eksplozivima, vatrometom; usluge maloprodaje i veleprodaje, sve u vezi sa plemenitim metalima i njihovim legurama, nakitom, dragim i poludragim kamenjem, horološkim i hronometrijskim instrumentima; usluge maloprodaje i veleprodaje, sve u vezi sa muzičkim instrumentima, muzičkim stalcima i štandovima za muzičke instrumente, dirigent palicama; usluge maloprodaje i veleprodaje, sve u vezi s papirom i kartonom, štampanim stvarima, materijalom za uvezivanje knjiga, fotografijama, kancelarijskim priborom i potrepštinama (izuzev namještaja), ljepilima za kancelarijsku ili kućnu upotrebu, materijalima za crtanje i materijalima za umjetnike, četkama za farbanje; usluge maloprodaje i veleprodaje, sve u vezi sa instruktivnim i nastavnim materijalima, plastičnim listovima, folijama i vrećama za ambalažu i pakovanje, štampačima, blokovima za štampanje, karticama u obliku debitnih kartica, kreditnih kartica, kartica za naplatu, telefonskih kartica i identifikacionih kartica osim kodiranih i magnetnih kartica, priručnicima za korisnike, maramicama od papira, modelima i figuricama od papira, držačima za stranice, papirnim salvetama, papirnim maramicama, ukrasima za zabave od papira; usluge maloprodaje i veleprodaje, sve u vezi sa kožom i imitacijama kože, životinjskom kožom i istegnutom životinjskom kožom, prtljagom i torbama, novčanicima i tašnama, kišobranima i suncobranima, štapovima za hodanje, bičevima, saračkim i sedlarskim stvarima, okovratnicima, povodcima i odjećom za životinje; usluge maloprodaje i veleprodaje, sve u vezi sa namještajem, ogledalima, ramovima za slike, posudama za skladištenje i transport (ne od metala); usluge maloprodaje i veleprodaje, sve u vezi sa priborom i posudama za domaćinstvo ili kuhinju, posudem i priborom za sto (osim viljušaka, noževa i kašika), češljevima i sunderima, četkicama (osim četkica za farbanje), materijalima za izradu četkica, proizvodima za čišćenje, posudem od stakla, porculana i grnačarijom, električnim četkicama za zube; usluge maloprodaje i veleprodaje, sve u vezi sa užadima i konopcima, mrežama, šatorima i ciradama, tendama od tekstilnih ili sintetičkih materijala, jedrima, vrećama za transport i skladištenje materijala u gomilama, postavama, jastucima i materijalima za punjenje (osim papira, kartona, guma ili plastika), sirovi vlaknasti tekstilni materijali i njihove zamjene; usluge maloprodaje i veleprodaje, sve u vezi s predivom i nitima, za tekstilnu upotrebu; usluge maloprodaje i veleprodaje, sve u vezi s tekstilom i zamjenama za tekstil, posteljinom za domaćinstvo, zavjesama od tekstila ili plastike; usluge maloprodaje i veleprodaje, sve u vezi s odjećom, obućom, pokrivalima za glavu; usluge maloprodaje i veleprodaje, sve u vezi s čipkom, pletenicama i vezom, i galanterijskim vrpcama i mašnjama, dugmadima, kopčama, iglama i iglicama, vještačkim cvijećem, ukrasima za kosu, vještačkom kosom; usluge maloprodaje i veleprodaje, sve u vezi sa tepisima, prostirkama, podmetačima i krparama, linoleumom i drugim materijalima za oblaganje postojećih podova, zidova, ne od tekstila; usluge maloprodaje i veleprodaje, sve u vezi sa igrama, igračkama i stvarima za igranje, aparatima za video igre, gimnastičkim i sportskim proizvodima, ukrasima za novogodišnje jelke, svečanim ukrasima i vještačkim novogodišnjim jelkama; usluge maloprodaje i veleprodaje, sve u vezi sa aparatima za elektronske igre i zabavne aparate, osim onih prilagođenih za upotrebu sa spoljnim ekranom ili monitorom, kućnim aparatima za video igre i ručnim aparatima za video igre (nijedna nije za upotrebu sa televizijskim prijemnicima), božićnim čarapama, uredajima koji

se drže u ruci za igranje elektronskih igara, kapama za zabave od papira, kapama za zabave od plastike, priborom za zabavu od papira; usluge maloprodaje i veleprodaje, sve u vezi sa mesom, ribom, živinom, divljači, vještačkim mesom, konzervisanim, smrznutim, sušenim i kuvanim voćem i povrćem, voćnim umacima, tofuom (bean curd), tofuom, supama, bujonima, želeima, džemovima, kompotom, jajaima, pavlakom, mlijekom i mliječnim proizvodima, sojinim mlijekom, zamjenama za mlijeko, proizvodima napravljenim od mliječnih zamjena, jestivim uljima i mastima, očišćenim orašastim plodovima, sušenim orašastim plodovima, grickalicama, pripremljenim jelima, unaprijed spakovanom brzom hranom; usluge maloprodaje i veleprodaje, sve u vezi sa kafom, čajem, kakaom i vještačkom kafom, rižom, tjesteninama i rezancima, tapiokom i sagom, brašnom i preparatima od žitarica, hlebom, pecivima i konditorskim proizvodima, čokoladom, sladoledom, šerbetom, jestivim ledom, šećerom, medom, melasom, kvascem, prašakom za pecivo, solju, začinima, dodacima jelima, konzerviranim biljem, sirćetom, sosovima, začinima, ledom [smrznuta voda]; usluge maloprodaje i veleprodaje, sve u vezi sa zamjenama za kafu, napicima na bazi kafe, čajevcem i proizvodima čaja, napicima na bazi čaja, kakao prahom i proizvodima od kakaa, pićima na bazi čokolade, pekarskim proizvodima, picama, kremama, kolačićima u obliku mjeseca, štanglama koji sadrže mješavinu žitarica, orašastim plodovima i sušenim voćem [konditorski proizvodi], kolačićima, krekerima, kineskim tortama i tortama zapadnog stila, kineskim knedlama, pahuljicama badema; usluge maloprodaje i veleprodaje, sve u vezi sa sirovim i neobrađenim poljoprivrednim, akvakulturnim, hortikulturnim i šumarskim proizvodima, sirovim i neobrađenim žitaricama i sjemenkama, svježim voćem i povrćem, svježim travama, prirodnim biljem i cvijećem, lukovicama, sadnicama i sjemenom za sadnju, živim životinjama, hranom i pićem za životinje, sladom; usluge maloprodaje i veleprodaje, sve u vezi sa pivom, preparatima za pravljenje piva, mineralnim i gaziranim vodama i ostalim bezalkoholnim pićima i napicima, voćnim napicima i voćnim sokovima, sirupima i drugim bezalkoholnim preparatima za pravljenje pića, sokovima od povrća i napicima od povrća; usluge maloprodaje i veleprodaje, sve u vezi sa alkoholnim pićima (osim piva), alkoholnim preparatima za pravljenje napitaka, alkoholnim ekstraktima, alkoholnim esencijama; usluge maloprodaje i veleprodaje, sve u vezi sa duvanskim proizvodima i zamjenom za duvan, cigaretama i cigarama, elektronskim cigaretama i oralnim isparivačima za pušače, artiklima za pušače, šibicama; sve gore pomenute maloprodajne i veleprodajne usluge koje se takode pružaju putem interneta, preko robnih kuća ili supermarketa, a takode omogućavaju kupcima da povoljno pregledaju i kupe ovu robu na opštoj prodajnoj veb stranici i u veleprodajnim outletima, putem opšteg prodajnog kataloga naručivanjem putem pošte ili telekomunikacija, kao i u maloprodajnim outletima; konsultantske, informativne i savjetodavne usluge koje se odnose na gore navedene usluge.

Klasa 36: Osiguranje; finansijski poslovi; novčani poslovi; poslovi vezani za nepokretnosti; kliring i uskladivanje finansijskih transakcija putem globalne računarske mreže; usluge prenosa sredstava; prenos sredstava elektronskim putem za druge; prenos uplata za druge putem interneta; elektronske bankarske usluge; usluge onlajn plaćanja; pružanje usluga elektronskog transfera sredstava; brokerske usluge u vezi sa valutama; finansijske transakcije preko blokčejna; onlajn bankarske usluge i finansijske usluge; pružanje finansijskih informacija putem interneta; onlajn bankarstvo; bankarske usluge pružene onlajn sa računarskih baza podataka ili interneta; usluge finansijskog kliringa; kreditna verifikacija putem globalne računarske informacione mreže; elektronske usluge upravljanja rizikom kredita; usluge elektronskog plaćanja za kupovinu i elektronskog plaćanja računa; informativne usluge u vezi sa finansijama i osiguranjem, pružene onlajn sa računarske

baze podataka ili interneta; usluge kreditnih kartica, obrada i prenos računa i uplata, i pružanje osiguranja za finansijske transakcije; finansijske usluge u oblasti usluga obrade računa i uplata; usluge depozita i usluge izdavanja putničkih vaučera; ulaganje kapitala; finansijske evaluacije [osiguranje, bankarstvo, nepokretnosti]; finansijske i usluge upravljanja aktivom; osiguranje i finansijske usluge; finansijske usluge pružene putem telekomunikacionih sredstava; finansijske konsalting i savjetodavne usluge; usluge posredovanja u prometu sa hartijama od vrijednosti, usluge notiranja cijena na berzi; posredovanje u vezi sa akcijama i obveznicama, finansijske analize; usluge debitnih kartica, usluge platnih kartica i usluge čekovne garancije; bankarske, usluge štednih računa i investicione usluge; zaduživanje finansijskih računa i kreditne usluge; izdavanje pretplatničkih kartica, platnih kartica i debitnih kartica; usluge telefonskih kreditnih kartica; organizovanje finansija za građevinske projekte; organizovanje i upravljanje lizingom i zakupom; iznajmljivanje i lizing nepokretnosti; procjena nepokretnosti; valuacija nepokretnosti; finansijske usluge u vezi sa nepokretnostima, investiranje u nepokretnosti; brokerske usluge u vezi sa nepokretnostima; usluge agencija za nepokretnosti; usluge stambenih agencija; usluge aktuara; upravljanje nepokretnostima i konsalting usluge; ubiranje najamnine; iznajmljivanje kancelarija (nepokretnosti); iznajmljivanje apartmana i stanova; agencija za prikupljanje naknada za gas i električnu energiju; procjena antikviteta; procjena umjetničkih djela; procjena nakita; procjena polovnih vozila; snabdijevanje poreskim informacijama (finansijske usluge); prikupljanje priloga za dobrotvorne fondove; organizovanje dobrotvornog prikupljanja; dobrotvorno prikupljanje; iznajmljivanje mašina za brojenje papirnog novca i kovanica; iznajmljivanje bankomata ili automatizovanih mašina za izdavanje gotovine; izdavanje vaučera; usluge izdavanja gotovine; pružanje pretplatničkih kartica i žetona; usluge mijenjanja novca; usluge prenosa novca; usluge prenosa stranih valuta; usluge promjene strane valute; trgovanje valutama; poslovanje sa valutama; dobrotvorno prikupljanje sredstava; pužanje usluga dobrotvornog prikupljanja sredstava u vezi sa kompenzacijom ugljenika; brokerske usluge u vezi sa kompenzacijom ugljenika; sponzorisanje programa kompenzacije ugljenika; finansiranje i ulaganje u projekte smanjenja emisije; ulaganje u programe i projekte kompenzacije ugljenika; ulaganje u fondove za smanjenje emisija; pružanje zajmova; pružanje privremenih zajmova; uključujući sve navedene usluge pružene elektronskim putem; konsultantske, informativne i savjetodavne usluge u vezi sa naprijed navedenim uslugama.

Klasa 38: Telekomunikacije; telekomunikacione usluge, naime usluge prenosa i prijema podataka putem telekomunikacionih mreža; pružanje usluga multimedijalnih telekonferencija, videokonferencija i sastanaka na web-u koji dozvoljavaju učesnicima da simultano i asinhrono pregledaju, dijele, ureduju i diskutuju dokumenta, podatke i slike putem veb pregledača; omogućavanje pristupa onlajn izvještajima u vezi sa performansama, efikasnošću i statusom Internet aplikacija, telekonferencija, video konferencija i sastanaka za korisnike; omogućavanje korisnicima da bezbjedno pristupaju privatnim kompjuterskim mrežama na daljinu putem Interneta; pružanje onlajn usluga saradnje koje omogućavaju korisnicima da pristupaju aplikacijama, platformama, zajednički dijeljenim dokumentima, podacima, listama zadataka i forumima za diskusiju; pružanje pristupa računarskim bazama podataka na globalnoj računarskoj mreži za pretraživanje i vraćanje informacija, podataka, veb stranica i resursa koji su dostupni na računarskim mrežama; pružanje pristupa za korisnike kompjuterskim bazama podataka koje sadrže elektronske publikacije, biltene, baze podataka i informacije kojima se može pristupiti preko računara; upravljanje pričaonicama (usluge pričaonica); pristup za više korisnika globalnim kompjuterskim informacionim mrežama za transfer i prenos širokog



opsega informacija; pružanje pristupa veb stranicama na globalnoj računarskoj mreži putem koje treća lica mogu da nude robe i usluge, prave i popunjavaju porudžbine, sklapaju ugovore i vrše poslovne transakcije; pružanje pristupa interaktivnoj veb stranici na globalnoj računarskoj mreži za treća lica da postavljaju informacije, odgovaraju na zahtjeve i prave i popunjavaju porudžbine za proizvode, servise i poslovne prilike; elektronske komunikacijske usluge za uspostavljanje virtualnih pričaonica putem tekstualnih poruka; pružanje elektronskih biltena za postavljanje i prenos poruka između računarskih korisnika u vezi sa proizvodima, uslugama i poslovnim prednostima i prilikama; pružanje elektronskih biltena za postavljanje, promociju, prodaju i preprodaju robe putem globalne računarske mreže; pružanje usluga elektronske pošte i prosljeđivanja elektronske pošte; audio i video komunikacija putem računara i računarskih mreža i putem globalne komunikacione mreže; pružanje računarskog pristupa i iznajmljivanje vremena za pristup interaktivnim biltenima i bazama podataka; pružanje pristupa elektronskim biltenima za postavljanje i prenos poruka između računarskih korisnika u vezi sa proizvodima, uslugama i poslovnim prilikama; pružanje pristupa elektronskom kalendaru, adresaru i elektronskoj bilježnici putem lokalne i globalne računarske mreže; pružanje usluga direktne konekcije između korisničkih računara za razmjenu podataka; pružanje telekomunikacionih pristupa i veza sa internetom i računarskim bazama podataka; usluge emitovanja preko interneta; pružanje onlajn baza podataka koje sadrže informacije o internet platformi za podnošenje žalbi u vezi sa emitovanjem programa; pružanje telekomunikacionog pristupa i veze sa računarskom bazom podataka i sa internetom; elektronske komunikacione usluge; interaktivne telekomunikacione usluge; telekomunikacije u vezi sa informacijama (Internet stranice), kompjuterskim programima i podacima; pružanje telekomunikacionih veza sa internetom ili bazama podataka; pružanje telekomunikacionog pristupa objektima i strukturama na internetu; komunikacija putem računarskih terminala; komunikacija putem mreža sa optičkim vlaknima; računarski potpomognut prenos poruka, informacija, podataka, dokumenata i slika; usluge komunikacije podacima elektronskim putem; elektronska razmjena glasa, podataka, audio, video sadržaja, teksta i grafike kojima se može pristupiti putem računara i telekomunikacionih mreža; usluge trenutnog slanja poruka; komunikacione usluge putem mobilnih telefona; sakupljanje, prenos i dostavljanje podataka elektronskim putem; sakupljanje, prenos i dostavljanje elektronskih poruka, informacija u vidu nepomičnih i/ili pokretnih slika kao što su karakteri, poruke, muzika i slike, telegrami, informacije i podaci putem mehaničkih, elektronskih, telefonskih, teleks, kablovskih, računarskih i satelitskih sredstava; prenos, emitovanje i prijem audio, video, nepomičnih i pokretnih slika i podataka u kompresovanom ili nekompresovanom obliku u realnom ili odloženom vremenu; usluge elektronskih poruka, konferencija i prenosa naloga; usluge video konferencija; komunikacija putem elektronskih biltena koji omogućava korisnicima da obavljaju interaktivne razgovore u realnom vremenu između računarskog terminala i elektronskog biltena koji sadrži informacije sa nepomičnim i pokretnim slikama i glasovne informacije kao što su karakteri; pružanje elektronskih biltena i oglasnih tabli za prenos poruka; pružanje usluga onlajn foruma za diskusije; komunikacione usluge, naime, usluge tekstualnih i numeričkih digitalnih poruka; prenos informacija komunikacijom podataka radi pomoći pri donošenju odluka; prenos informacija kroz sisteme za video komunikaciju; usluge veb konferencija; pružanje pristupa i prostora za video i/ili telefonske konferencije na daljinu; savjetodavne usluge u oblasti zaštite podataka i usluge prenosa informacija; pružanje veza za elektronske podatke; prenos putem faksimila; slanje poruka; pejdžing usluge; iznajmljivanje modema; iznajmljivanje telekomunikacione opreme; usluge

elektronskog slanja, primanja i prosljeđivanja poruka; usluge televizijskog emitovanja; emitovanje i prenos radio i televizijskih programa; emitovanje muzike; prenos muzičkih, filmskih, interaktivnih programa, videa, elektronskih računarskih igara; prenos informacija u vezi sa onlajn kupovinom i opštim uslugama maloprodaje; usluge prenosa videa po zahtjevu; usluge novinskih agencija; konsultacije, informacije i savjetodavne usluge u vezi sa gore navedenim uslugama.

Klasa 39: Transport; pakovanje i skladištenje robe; aranžmani putovanja; fizičko skladištenje elektronski pohranjenih podataka ili dokumenata; skladištenje elektronski pohranjenih podataka ili dokumenata; informacije o prevozu; transportno posredovanje; transportna logistika; prevoz robe i putnika; pakovanje; posredovanje u vezi sa brodovima (posredovanje u vezi sa pomorskim transportom); auto prevoz; avio prevoz; prevoz blindiranim automobilima; iznajmljivanje vozila; dostavljanje poruka; transport cjevovodom; dostavljanje robe po porudžbini; kurirske usluge [dostava pošiljki ili robe]; transportne usluge u vezi upravljanja transportom; usluge iznajmljivanja automobila; usluge parkiranja vozila; putovanja jahtom i/ili brodovima; usluge putničkih agencija; usluge putničkih rezervacija i putničkih informacija; usluge agencije u vezi sa putničkim kartama; organizovanje putovanja i informacije za njih, sve pruženo onlajn sa kompjuterske baze podataka ili interneta; pružanje informacija koje se odnose na putovanja i turizam putem interneta ili putem telekomunikacijskih mreža; pružanje uputstava za vožnju za potrebe putovanja; organizovanje krstarenja; organizovanje prevoza za turistička putovanja; rezervacija sjedišta za putovanje; pratnja putnika; usluge prevoza za turistička razgledanja; organizovanje usluga prevoza putika za druge putem onlajn aplikacije; putničke rezervacije; pružanje informacija o putevima i saobraćaju, usluge vozača; utovar i istovar tereta; posredovanje u prevozu robe; selidbene usluge; posredovanje u iznajmljivanju, lizingu; prodaji; kupovini i/ili čarteru brodova i/ili čamaca; spasavanje i podizanje potopljenih brodova i/ili čamaca; pilotiranje; distribucija gasa i snabdijevanje; distribucija električne struje i snabdijevanje; distribucija toplote i snabdijevanje; snabdijevanje vodom; distribucija vode i snabdijevanje; usluge objekata za sidrenje; iznajmljivanje skladišta; pružanje područja za letenje; obezbjeđivanje pristupa putevima na kojima se plaća putarina; iznajmljivanje i/ili lizing invalidskih kolica; usluge parkiranja automobila; upravljanje parking prostorom; iznajmljivanje i/ili lizing aviona; iznajmljivanje i/ili lizing kontejnera; iznajmljivanje i/ili lizing bicikala; iznajmljivanje i/ili lizing automobila; iznajmljivanje i/ili lizing brodova i/ili čamaca; iznajmljivanje i/ili lizing vozila na ljudski pogon; iznajmljivanje i/ili lizing mehaničkih parking sistema; iznajmljivanje i/ili lizing paleta; iznajmljivanje i/ili lizing mašina za pakovanje i umotavanje; iznajmljivanje i/ili lizing komora za hladenje; skupljanje otpada i smeća iz domaćinstva; skupljanje industrijskog otpada i smeća; iznajmljivanje navigacionih sistema; iznajmljivanje vazduhoplova; dopunjavanje bankomata gotovinom; usluge vozača; prikupljanje recikliranih proizvoda [transport]; isporuka robe; dostava novina; isporuka energije; isporuka cvijeća; frankiranje pošte; brodski prevoz robe; iznajmljivanje garaža; pakovanje poklona; iznajmljivanje konja; lansiranje satelita za druge; skladištenje prtljaga; iznajmljivanje putničkih autobusa; isporuka pošiljki; iznajmljivanje parking mjesta; iznajmljivanje prostorija za hladenje; iznajmljivanje zamrzivača; iznajmljivanje trkačkih automobila; iznajmljivanje kontejnera za skladištenje; iznajmljivanje traktora; iznajmljivanje prtljažnika za krov na vozilima; iznajmljivanje invalidskih kolica; dopunjavanje automata za prodaju; spasilačke operacije [u transportu]; usluge spašavanja [transport]; taksi prevoz; tegljenje; informacije o saobraćaju; rezervacija prevoza; pakovanje; konsultantske, informativne i savjetodavne usluge u vezi sa naprijed navedenim uslugama.

Klasa 41: Obrazovanje; pružanje obuke; zabava; sportske i kulturne aktivnosti; izdavanje tekstova, knjiga i časopisa (osim reklamnih tekstova); izdavanje dijagrama, slika i fotografija; izdavanje novina, magazina i periodičnih publikacija; usluge obrazovanja, vežbe i pružanja obuka u vezi sa telekomunikacijama, računarima, računarskim programima, računarstvom u oblaku, dizajnom veb sajtova, elektronskom trgovinom, poslovnim upravljanjem, finansijskim upravljanjem i oglašavanjem; pružanje obrazovanja, rekreacije, instrukcija, podučavanja i obuke interaktivno i neinteraktivno; dizajn obrazovnih kurseva, ispita i kvalifikacija; zabava pružena putem elektronskih i digitalnih interaktivnih medija; usluge elektronskih igara pružene putem interneta; pružanje informacija u vezi sa obrazovanjem, obukom, zabavom, rekreacijom, sportskim, društvenim i kulturnim aktivnostima; pružanje onlajn elektronskih publikacija (koje se ne mogu preuzimati); priređivanje, organizovanje, hosting i vodenje pjevačkih takmičenja; priređivanje, organizovanje, hosting i vodenje koncerta; priređivanje, organizovanje, hosting i vodenje događaja i takmičenja za obrazovne i zabavne potrebe; priređivanje, organizovanje, hosting i vodenje zabavnih igara i potraga; usluge agencija u vezi sa kartama za zabavne događaje; informacije u vezi sa zabavom ili obrazovanjem, koje se pružaju onlajn sa računarske baze podataka ili interneta; pružanje digitalne muzike (koja se ne može preuzimati) sa interneta; pružanje digitalne muzike (koja se ne može preuzimati) sa MP3 (Moving Picture Experts Group1 audio layer 3) Internet veb sajtova; pružanje video igara, računarskih igara, zvuka ili slika, ili filmova putem telekomunikacionih ili računarskih mreža; pružanje onlajn računarskih igara i takmičenja; pružanje onlajn videa, koji se ne mogu preuzimati; pružanje onlajn elektronskih publikacija koje se strimuju sa interneta ili računarske mreže ili računarske baze podataka; zabavne i obrazovne usluge u vezi sa planiranjem, proizvodnjom i distribucijom zvuka, slika, digitalne muzike, filmova, uživo ili snimljenih audio, vizuelnih ili audiovizuelnih materijala za emitovanje na zemaljskim kanalima, satelitskim kanalima, internetu, bežičnim ili sistemima žične veze i drugim vidovima komunikacija; usluge muzičke zabave; iznajmljivanje audio snimaka; pripremanje zabavnih, obrazovnih, dokumentarnih programa i vijesti za emitovanje; usluge reporterskog izveštavanja; informacije u vezi sa sportskim i kulturnim događajima, aktuelnim događajima i najvažnijim vijestima pružene putem televizijskog satelitskog prenosa, interneta ili drugih elektronskih načina; televizijska, radio i filmska produkcija; pripremanje i produkcija televizijskih programa; pružanje informacija, podataka, grafike, zvuka, muzike, videa, animacije i tekstova za zabavne potrebe; usluge igara; pružanje klupske rekreacije, sportskih i gimnastičkih objekata; nastupi muzičkih sastava; klupska zabava, diskoteke, modne revije i usluge noćnih klubova; klupske usluge u vezi sa zabavom, obrazovanjem i kulturnim aktivnostima; organizovanje, vodenje i pružanje konferencija, konvencija, kongresa, seminara i radionica obuke; organizovanje, vodenje i pružanje konferencija, konvencija, kongresa, seminara i radionica obuke u vezi sa telekomunikacijama, računarima, računarskim programima, računarstvom u oblaku, dizajnom veb sajtova, elektronskom trgovinom, poslovnim upravljanjem, finansijskim upravljanjem i oglašavanjem; organizovanje i vodenje izložbi za kulturne i obrazovne potrebe, modnih revija, obrazovnih programa i kulturnih programa i predstava; umjetničke izložbe i usluge galerija; usluge umjetničkih galerija u vezi sa lizingom umjetničkih djela; usluge obuke u vezi sa zdravljem i bezbjednošću na radu i održavanjem okoline; organizovanje časova u vezi sa cigarama, časova degustacije vina; pružanje obrazovnih informacija u vezi sa istraživanjem materijala i agencija za iste; aranžman, organizovanje, planiranje i upravljanje seminarima; obuka životinja; uputstva u produkciji programa za emitovanje; usluge instrukcija u vezi sa upravljanjem mašinama i opremom, uključujući

audiovizuelnu opremu koja se koristi za produkciju programa za emitovanje; pružanje audio i vizuelnih studija; pružanje sportskih objekata; pružanje objekata za filmove, priredbe, predstave, muzičke ili obrazovne treninge; usluge agencija za rezervisanje zabavnih događaja; iznajmljivanje i lizing filmova; iznajmljivanje i lizing muzičkih instrumenata; iznajmljivanje i lizing televizijskih programa; iznajmljivanje i lizing televizijskih setova; usluge biblioteka; arhivske usluge biblioteka; usluge titlovanja; prevodilačke usluge za znakovni jezik; iznajmljivanje prethodno snimljenih video traka; iznajmljivanje i lizing mašina za igru; pozajmljivanje opreme za arkadne igre; pozajmljivanje slika; fotografisanje; prevodenje; usluge tumača; obrazovni i programi obuke u oblasti upravljanja rizikom; obrazovni i programi obuke u vezi sa sertifikacijom; pružanje vijesti; usluge igara na sreću; podučavanje; konsultantske, informativne i savjetodavne usluge u vezi sa prethodno navedenim uslugama.

Klasa 42: Naučne i tehnološke usluge i istraživanja i projektovanja u vezi sa njima, usluge industrijskih analiza i istraživanja; projektovanje i razvoj računarskog hardvera i softvera; istraživanje i razvoj u vezi sa poluprovodnicima, poluprovodničkim integrisanim kolima, poluprovodničkim memorijskim čipovima, poluprovodničkim memorijskim kontrolerima, poluprovodničkim memorijskim integrisanim kolima, poluprovodničkim procesorskim čipovima, poluprovodničkim procesorima, mikrokontrolerima, jedinicama mikrokontrolera, mikrokontrolerima male snage, čipovima kola, kompjuterskim čipovima, CPU (centralnim procesorskim jedinicama), RISC-V kompjuterskim čipovima i centralnim procesorskim jedinicama, kompjuterskim čipovima i centralnim procesorskim jedinicama sa arhitekturom skupa instrukcija; softver u vidu servisa (SaaS); računarske usluge u vezi sa prenosom informacija, podataka, dokumenata, i slika putem interneta; usluge provajdera aplikacija (ASP), naime, hosting računarskih softverskih aplikacija za druge; usluge provajdera aplikacija (ASP) pružanje softvera u oblasti veb zasnovanih konferencija, audio konferencija, elektronskih poruka, kolaboracije dokumenata, video konferencija, i obrade glasa i poziva; pružanje onlajn softvera koji se ne mogu preuzimati za olakšavanje interoperabilnosti više softverskih aplikacija; usluge tehničke podrške (tehničke konsultacije) u vezi sa računarskim softverom i aplikacije pružene onlajn, putem email-a i telefona; računarske usluge, naime kreiranje onlajn zajednice za registrovane korisnike da učestvuju u raspravi, dobiju povratnu informaciju od svojih vršnjaka, formiraju virtuelne zajednice, učestvuju u društvenim mrežama i razmenjuju dokumenta; savjeti o računarskim tehnologijama pruženi internet korisnicima putem telefonske podrške; računarske usluge u vezi sa kreiranjem indeksa informacija, stranica i izvora na računarskoj mreži; pružanje alata za pretraživanje na internetu; dizajn računara, noutbuk računara, laptop računara, prenosivih računara i ručnih računara; dizajn ličnih digitalnih asistenata i ličnih media plejera; dizajn mobilnih telefona i pametnih telefona; dizajn digitalnih kamera; računarske usluge; računarsko programiranje; računarske integracione usluge; usluge računarske analize; računarsko programiranje u vezi sa odbranom od virusa; usluge računarskog sistemskog softvera; dizajn računarskog softvera; dizajn računarskih sistema; dizajn i razvoj veb stranica; hosting veb stranica za druge; hosting softver računarskih aplikacija za pretraživanje i vraćanje informacija iz baze podataka i računarske mreže; pružanje tehničkih informacija po posebnom zahtjevu krajnjih korisnika putem telefona ili globalne računarske mreže; konsultantske usluge u vezi sa računarskim softverom; računarske usluge u vezi sa prilagodenim pretraživanjem računarske baze podataka i veb sajtova; računarsko i elektronsko kodiranje i dekodiranje signala; konverzija fizičkih podataka i dokumenata u elektronske medijske formate; testiranje proizvoda i usluge procjene; arhitektonske i usluge dizajna; dizajn enterijera zgrada, kancelarija i

apartmana; usluge kompjuterskih informacija; usluge mrežnih informacija, naime, pružanje tehničkih informacija u vezi sa računarima i mrežama u oblasti biznisa i elektronske trgovine; pružanje računarskih programa za upravljanje rizikom bezbjednosti; usluge računarskih bezbjednosnih informacija, znanje i usluge testiranja; usluge osiguranja kvaliteta; računarske usluge u vezi sa sertifikacijom poslovnih transakcija i pripremanje izvještaja u vezi sa njima; računarske bezbjednosne usluge u vezi sa kontrolom pristupa računarima, elektronskim mrežama i bazama podataka; obezbjeđivanje prenosa podataka i transakcija putem računarskih mreža; konsultantske usluge u vezi sa područjem bezbjednosti podataka; tehnološke konsultacije u vezi sa bezbjednošću telekomunikacija; bezbjednosne usluge kompjuterizovanih komunikacionih mreža; pružanje informacija u oblasti interneta, svjetske mreže/www i bezbjednosti kompjuterizovanih komunikacionih mreža i bezbjednog prenosa podataka i informacija; konsultantske usluge u oblasti interneta, svjetske mreže/www i bezbjednosti kompjuterizovanih komunikacionih mreža, usluge bezbjednosti informacija; usluge autentifikacije za bezbjednost računara; računarske usluge u vezi sa onlajn autentifikacijom elektronskih potpisa; pohranjivanje rezervnih podataka van glavne lokacije (off-site); pružanje informacija na računarskim tehnologijama i programiranje putem veb sajta; kartografske usluge; računarstvo u oblaku; usluge hosting provajdera oblaka; pružanje privremene upotrebe softvera u oblaku koji se ne može preuzimati i softvera za računarstvo u oblaku; elektronsko skladištenje podataka; pružanje virtuelnih računarskih sistema i virtuelne računarske sredine putem računarstva u oblaku; iznajmljivanje softvera za zabavu; pružanje onlajn kompjuterskih softvera i kompjuterskih aplikacija koje se ne mogu preuzimati za striming audio materijala, video materijala, videa, muzike i slika; konsultantske, informativne i savjetodavne usluge u vezi sa naprijed navedenim uslugama.

---

(111) **15070**

(151) 30.12.2020.

(210) Ž-2019-324

(220) 29.08.2019.

(732) Altunis-Trading, Gestão e Serviços, Sociedade Unipessoal, LDA., Avenida Arriaga n° 73, 1° andar, sala 113, 9000-060, Funchal, Madeira, PT

(540)

## CIPRIANI

(550) I

(740) Jasna Jusić, Dalmatinska 2, 81000, Podgorica

(511) Klasa 43: Usluge obezbjeđivanja hrane i pica; privremeni smještaj.

---

(111) **15071**

(151) 30.12.2020.

(210) Ž-2019-265

(220) 04.07.2019.

(732) PharmaSwiss d.o.o., Batajnicki drum 5A, 11000, Beograd, RS

(540)

## Diosminex

(550) I

(740) Božidar S. Radulović, Baku 30/5, 81000, Podgorica

(511) Klasa 5: Farmaceutski proizvodi, lijekovi za medicinsku upotrebu.

---

(111) **15066**

(151) 22.12.2020.

(210) Ž-2019-413

(220) 29.10.2019.

(732) The Coca-Cola Company, One Coca-Cola Plaza, 30313, Atlanta, Georgia, US

(540)



(550) I

(740) Miladin Popović, Đoka Miraševića 21/III, 81000, Podgorica

(511) Klasa 9: Softver uključujući softver za medije, prijavljivanje i objavljivanje, softver za komunikaciju i umrežavanje; medijski sadržaj; snimljeni sadržaj; baze podataka; elektronske publikacije; mediji, zvuk, slike i podaci snimljeni i koji se mogu preuzimati.

Klasa 32: Pića, uključujući vode za piće, vode sa ukusom, mineralne i gazirane vode; ostala bezalkoholna pića, uključujući osvježavajuća bezalkoholna pića, energetska pića i pića za sportiste; voćni napici i sokovi uključujući kokosovu vodu; sirupi, koncentрати, praškovi i drugi preparati za pripremu pića, uključujući vode sa ukusom, mineralne i gazirane vode, osvježavajuća bezalkoholna pića, energetska pića, pića za sportiste, voćne napitke i sokove; napici i sokovi od povrća.

Klasa 41: Usluge razonode; usluge razonode koje se pružaju on-line putem računarskih baza podataka i / ili putem interneta; elektronske publikacije koje se mogu preuzimati;

elektronske knjige; elektronske baze podataka; usluge razonode; usluge razonode u obliku pružanja elektronskih, računarskih i video igara putem interneta i drugih uređaja za daljinsku komunikaciju; usluge razonode u obliku pružanja virtualnih igara i usluga razonode putem interneta i drugih uređaja za daljinsku komunikaciju; internet igre (koje se ne mogu preuzimati); usluge pružanja elektronskih igara, slagalica i takmičenja putem interneta i drugih uređaja za daljinsku komunikaciju; produkcija audio, video i audio / video zapisa; produkcija filmova, animiranih filmova, crtanih filmova, radio programa i televizijskih programa; usluge razonode uživo; organizovanje i sprovođenje igara, takmičenja i zabavnih događaja; pružanje informacija u vezi sa razonodom i zabavom.

---

(111) **15072**

(151) 30.12.2020.

(210) Ž-2019-266

(220) 04.07.2019.

(732) PharmaSwiss d.o.o., Batajnicki drum 5A, 11000, Beograd, RS

(540)

## Diosminex Max

(550) I

(740) Božidar S. Radulović, Baku 30/5, 81000, Podgorica

(511) Klasa 5: Farmaceutski proizvodi, lijekovi za medicinsku upotrebu.

---

(111) **15073**

(151) 30.12.2020.

(210) Ž-2019-10

(220) 17.01.2019.

(732) Kerzner International Limited, Atlantis Paradise Island, Coral Towers Executive Office, P O Box N4777, Nassau, BS

(540)

## ONE & ONLY

(550) I

(740) Jasna Jusić, Dalmatinska 2, 81000, Podgorica

(511) Klasa 35: Usluge oglašavanja nekretnina; usluge reklamiranja nekretnina, naime, usluge reklamiranja prodaje stambenih jedinica i vila.

Klasa 36: Poslovi sa nekretninama; agencije za nekretnine; agenti za stanove; procjena nepokretnosti; upravljanje nekretninama; upravljanje stanovima; iznajmljivanje stanova; usluge posredovanja u prometu nekretnina; lizing nekretnina za kompleks koji sadrži tržne centre, barove, noćne klubove, kockarnice, restorane, pozorišta i maloprodajne objekte; usluge upravljanja nekretninama i imovinom; usluge u oblasti nekretnina; usluge u vezi s nekretninama, naime popis, lizing, posredovanje, menadžment i upravljanje stambenim jedinicama i vilama; usluge u vezi s nekretninama, naime lizing, iznajmljivanje i upravljanje kućama, kondominijumima i vilama za odmor, i upravljanjem kondominijumima; usluge udruženja vlasnika kuća, naime, upravljanje usklađenošću zajednice u svrhu upravljanja zajedničkim površinama i sadržajima; usluge upravljanja udruženja vlasnika kuća, naime, upravljanje usklađenošću zajednice u svrhu upravljanja zajedničkim površinama i sadržajima.

Klasa 37: Razvoj nekretnina; građevinarstvo; popravak zgrada; postavljanje instalacija i opreme za zgrade; nadgledanje izgradnje objekata; izgradnja; građevinske konsultacije; informacije o izgradnji.

---

(111) **15074**

(151) 24.12.2020.

(210) Ž-2019-486

(220) 11.12.2019.

(732) "PANONKA" D.O.O., ulica Nikšički put broj 7, 81000, Podgorica, ME

(540)



(550) I

(740) AOD "Ćupić", Bulevar Džordža Vašingtona 79, 81000, Podgorica

(511) Klasa 1: Emulgatori, aditivi za prehrambenu industriju, konzervansi, đubriva za zemlju, hemijski proizvodi za industriju, nauku, fotografsku djelatnost, hortikulturu,



poljoprivredu i šumarstvo.

Klasa 8: Ručni alati i sprave s ručnim pokretanjem, koje imaju ulogu alata u raznim profesijama.

Klasa 11: Električni uređaji za kuhanje.

Klasa 21: Pribor i posude za domaćinstvo ili za kuhinju, pribor za čišćenje (metle, džogeri, krpe, sunđer, četke itd.), stakleni proizvodi, porculansko i keramičko posuđe koje nije obuhvaćeno drugim klasama.

Klasa 29: Meso, riba, živina i divljač; mesni ekstrakti; konzervirano, sušeno i kuvano voće i povrće; želei, džemovi, kompoti; jaja, mlijeko i mliječni proizvodi; jestiva ulja i masti.

Klasa 30: Kafa, čaj, kakao, šećer, riža, tapioka, sago, zamjene za kafu; brašno i proizvodi od žitarica, hleb, kolači, poslastice, bomboni, sladoled; med, sirup od melase; kvasac, prašak za pecivo; so, senf; sirće, prelive; začini, razni začini; led za hlađenje.

Klasa 32: Pivo; mineralne i gazirane vode i ostala bezalkoholna pića; pića od voća i voćni sokovi; sirupi i ostali preparati za pripremanje napitaka.

Klasa 33: Alkoholna pića (osim piva).

---

(111) **15067**

(151) 23.12.2020.

(210) Ž-2019-414

(220) 29.10.2019.

(732) The Coca-Cola Company, One Coca-Cola Plaza, 30313, Atlanta, Georgia, US

(540)



(550) I

(740) Miladin Popović, Đoka Miraševića 21/III, 81000, Podgorica

(511) Klasa 9: Softver uključujući softver za medije, prijavljivanje i objavljivanje, softver za komunikaciju i umrežavanje; medijski sadržaj; snimljeni sadržaj; baze podataka; elektronske publikacije; mediji, zvuk, slike i podaci snimljeni i koji se mogu preuzimati.

Klasa 32: Pića, uključujući vode za piće, vode sa ukusom, mineralne i gazirane vode; ostala bezalkoholna pića, uključujući osvježavajuća bezalkoholna pića, energetska pića i pića za sportiste; voćni napici i sokovi uključujući kokosovu vodu; sirupi, koncentracije, praškovi i drugi preparati za pripremu pića, uključujući vode sa ukusom, mineralne i gazirane vode, osvježavajuća bezalkoholna pića, energetska pića, pića za sportiste, voćne napitke i sokove; napici i sokovi od povrća.

Klasa 41: Usluge razonode; usluge razonode koje se pružaju on-line putem računarskih baza podataka i / ili putem interneta; elektronske publikacije koje se mogu preuzimati; elektronske knjige; elektronske baze podataka; usluge razonode; usluge razonode u obliku pružanja elektronskih, računarskih i video igara putem interneta i drugih uređaja za daljinsku komunikaciju; usluge razonode u obliku pružanja virtualnih igara i usluga

razonode putem interneta i drugih uređaja za daljinsku komunikaciju; internet igre (koje se ne mogu preuzimati); usluge pružanja elektronskih igara, slagalica i takmičenja putem interneta i drugih uređaja za daljinsku komunikaciju; produkcija audio, video i audio / video zapisa; produkcija filmova, animiranih filmova, crtanih filmova, radio programa i televizijskih programa; usluge razonode uživo; organizovanje i sprovođenje igara, takmičenja i zabavnih događaja; pružanje informacija u vezi sa razonodom i zabavom.

---

(111) **15075**

(151) 24.12.2020.

(210) Ž-2019-488

(220) 11.12.2019.

(732) "PANONKA" D.O.O., ulica Nikšićki put broj 7, 81000, Podgorica, ME

(540)



(550) I

(740) AOD "Ćupić", Bulevar Džordža Vašingtona 79, 81000, Podgorica

(511) Klasa 1: Emulgatori, aditivi za prehrambenu industriju, konzervansi, đubriva za zemlju, hemijski proizvodi za industriju, nauku, fotografsku djelatnost, hortikulturu, poljoprivredu i šumarstvo.

Klasa 5: Razni higijenski proizvodi za upotrebu u veterini, razna dezinfekciona sredstva kako prostora tako i samih životinja, proizvodi za uništavanje životinjskih štetočina, fungicidi, herbicidi.

Klasa 7: Mašine i alatne mašine, inkubatori za jaja, automatske mašine u poljoprivredi, razne poljoprivredne sprave i uređaji.

Klasa 8: Ručni alati i sprave s ručnim pokretanjem, koje imaju ulogu alata u razniin profesijama.

Klasa 11: Električni uređaji za kuhanje.

Klasa 21: Pribor i posuđe za domaćinstvo ili za kuhinju, pribor za čišćenje (metle, džogeri, krpe, sunđer, četke itd.), stakleni proizvodi, porculansko i keramičko posuđe koje nije obuhvaćeno drugim klasama.

Klasa 22: Konopci i kanapi od prirodnog ili vještačkog vlakna, od papira ili od plastike (rafije, PP veziva itd..)

Klasa 29: Meso, riba, živina i divljač; mesni ekstrakti; konzervirano, sušeno i kuvano voće i povrće; želei, džemovi, kompoti; jaja, mlijeko i mliječni proizvodi; jestiva ulja i masti.

Klasa 30: Kafa, čaj, kakao, šećer, riža, tapioka, sago, zamjene za kafu; brašno i proizvodi od žitarica, hleb, kolači, poslastice, bomboni, sladoled; med, sirup od melase; kvasac, prašak za pecivo; so, senf, sirće, prelive; začini, razni začini; led za hlađenje.

Klasa 31: Poljoprivredni, povrtlarski, šumski proizvodi i bobice, koji nisu obuhvaćeni drugim klasama; žive životinje; svježe voće i povrće; sjeme, prirodne biljke i cvijeće; hrana za životinje; slad.

Klasa 32: Pivo; mineralne i gazirane vode i ostala bezalkoholna pića; pića od voća i voćni sokovi; sirupi i ostali preparati za pripremanje napitaka.

Klasa 33: Alkoholna pića (osim piva).

Klasa 44: Veterinarske usluge; higijenska njega i njega ljepote za ljude ili za životinje; usluge poljoprivrede, povrtlarstva i šumarstva.

---

(111) **15068**

(151) 23.12.2020.

(210) Ž-2019-432

(220) 06.11.2019.

(732) ALBI COMMERCE sh.p.k., Zona e Re Industriale-Veternik p.n., 10000, Prishtinë, Kosovë, RS

(540)

## Grata

(550) I

(740) Dalibor Roćen, 13. jul br. 10, 81000, Podgorica

(511) Klasa 29: Mlijeko; piće u kome dominira mlijeko; mlijeko za kafu; zamjena za mlijeko; mlijeko u prahu; kondenzovano mlijeko; jogurt; maslac; sir; krem(pavlaka); điza; surutka; jestive masti.

---

(111) **15076**

(151) 24.12.2020.

(210) Ž-2019-489

(220) 11.12.2019.

(732) Kentucky Fried Chicken International Holdings LLC, 7100 Corporate Drive, 75024, Plano, Texas, US  
(540)



(550) I

(740) Jasna Jusić, Dalmatinska 2, 81000, Podgorica

(511) Klasa 29: Pripremljeni obroci koji sadrže piletinu.  
Klasa 30: Sendviči sa piletinom.

---

(111) **15069**

(151) 23.12.2020.

(210) Ž-2019-433

(220) 06.11.2019.

(732) ALBI COMMERCE sh.p.k., Zona e Re Industriale-Veternik p.n., 10000, Prishtinë, Kosovë, RS

(540)



(550) I

(740) Dalibor Roćen, ulica 13. jul br. 10, 81000, Podgorica

(511) Klasa 29: Mlijeko; piće u kome dominira mlijeko; mlijeko za kafu; zamjena za mlijeko; mlijeko u prahu; kondenzovano mlijeko; jogurt; maslac; sir; krem(pavlaka); điza; surutka; jestive masti.

---

(111) **15077**

(151) 24.12.2020.

(210) Ž-2020-58

(220) 18.02.2020.

(732) Đorđe Stojović, Moskovska bb, 81000, Podgorica, ME

(540)



(550) I

(511) Klasa 29: Jestiva ulja i masti.

Klasa 30: Med, kafa, kakao, konditorski proizvodi (čokolada).

Klasa 32: Mineralne i negazirane vode i ostala bezalkoholna pića.

Klasa 33: Alkoholna pića.

---

(111) **15078**

(151) 24.12.2020.

(210) Ž-2020-33

(220) 31.01.2020.

(732) DRECUN 1 DOO, ul. Mainski put BB, Budva, ME

(540)



(550) I

(740) Dragan S. Nikolić, Veliše Mugoše I/9, Podgorica

(511) Klasa 16: Papir, karton i proizvodi od tih materijala koji nisu obuhvaćeni drugim klasama; štamparski proizvodi; proizvodi za uvezivanje knjiga; fotografije; pribor za pisanje; ljepila (ljepljive materije za papirne proizvode ili za kućne potrebe); slikarski pribor; kistovi; pisaće mašine i kancelarijski pribor (osim namještaja); oprema za nastavu i obuku (osim aparata); plastični materijali za ambalažu (koji nisu obuhvaćeni drugim klasama); štamparska slova; klišeji.

Klasa 39: Prevoz; ambalažiranje i skladištenje proizvoda; organizovanje putovanja.

(111) **15079**

(151) 24.12.2020.

(210) Ž-2020-39

(220) 07.02.2020.

(732) POSLOVNI SISTEM MERCATOR d.d., Dunajska cesta 107, 1000, Ljubljana, SI

(540)

**Daisy**

(550) I

(740) Božidar S. Radulović, Baku 30/5, 81000, Podgorica

(511) Klasa 3: Preparati za izbjeljivanje i drugi deterdženti; preparati za čišćenje, poliranje, odmaščivanje i brušenje; sapun; parfimerijski proizvodi, eterična ulja, kozmetika, losioni za kosu; zubna sredstva za čišćenje.

Klasa 16: Papir, karton i proizvodi napravljeni od ovih materijala, koji nisu obuhvaćeni drugim klasama; tiskovina; materijal za uvezivanje knjiga; fotografije; tiskanice; ljepila za kancelarijske i kućne potrebe; materijali za umjetnike; četke; pisaće mašine i kancelarijski pribor (osim namještaja); materijali za obuku i nastavu (osim uređaja); plastični materijali za pakovanje (koji nisu obuhvaćeni drugim klasama); štamparska slova; klišeji.

Klasa 35: Oglašavanje; poslovno upravljanje; poslovna administracija; kancelarijski poslovi.

---

(111) **15080**

(151) 24.12.2020.

(210) Ž-2020-53

(220) 14.02.2020.

(732) Omega Enterprises, Sarl, 12C Rue Guillaume J. Kroll, L-1882, Luxembourg, LU

(540)

**Key West**

(550) I

(740) Jasna Jusić, Dalmatinska 2, 81000, Podgorica

(511) Klasa 43: Usluge obezbjeđivanja hrane i pića; privremeni smještaj; usluge hotela, barova i restorana.

(111) **15081**

(151) 24.12.2020.

(210) Ž-2020-16

(220) 23.01.2020.

(732) Lidl Stiftung & Co. KG , Stiftsbergstrasse 1, 74172, Neckarsulm, DE

(540)



(550) I

(740) AOD "Lutovac & partneri", Bulevar Ivana Crnojevića 93, 81000, Podgorica

(511) Klasa 33: Alkoholna pića osim piva, naročito vina.

---

(111) **15082**

(151) 24.12.2020.

(210) Ž-2020-17

(220) 23.01.2020.

(732) Lidl Stiftung & Co. KG , Stiftsbergstrasse 1, 74172, Neckarsulm, DE

(540)



(550) I

(740) AOD "Lutovac & partneri", Bulevar Ivana Crnojevića 93, 81000, Podgorica

(511) Klasa 33: Alkoholna pića (osim piva), naročito vina, pjenušava voćna vina, pjenušava vina, likeri.

---

(111) **15083**

(151) 24.12.2020.

(210) Ž-2020-36

(220) 05.02.2020.

(732) Lidl Stiftung & Co. KG , Stiftsbergstrasse 1, 74172, Neckarsulm, DE

(540)

**PUTINOFF**

(550) I

(740) AOD "Lutovac & partneri", Bulevar Ivana Crnojevića 93, 81000, Podgorica

(511) Klasa 33: Votka.

---

(111) **15084**

(151) 24.12.2020.

(210) Ž-2020-81

(220) 06.03.2020.

(732) Lidl Stiftung & Co. KG , Stiftsbergstrasse 1, 74172, Neckarsulm, DE

(540)



(550) I

(740) AOD "Lutovac & partneri", Bulevar Ivana Crnojevića 93, 81000, Podgorica



(511) Klasa 32: Bezalkoholna pića, naročito piva bez alkohola, mineralne i gazirane vode, gazirana pića, voćna pića i voćni sokovi; piva.

---

(111) **15089**

(151) 25.12.2020.

(210) Ž-2020-18

(220) 23.01.2020.

(732) Kent Gıda Maddeleri Sanayii ve Ticaret Anonim Sirketi, Cumhuriyet Mahallesi 2253, Sokak No.11, 41400, Gebze-Kocaeli, Istanbul, TR

(540)

## TOPITOP

(550) I

(740) Miladin Popović, ul. Capital Plaza, ulica šeika Zajeda 13-IV/68, 81000, Podgorica

(511) Klasa 30: Kakao, kakao u prahu, proizvodi od kakaa, keksi, čokoladni keksi, vafli, kolači, bombone, slatkiši, pastile, čokolada, čokoladni krem, proizvodi od čokolade, napici na bazi čokolade, punjeni čokoladnim proizvodima i šećerom, fondan koji se puni vazuhom, karamelizovani proizvodi, bombone, slatkiši sa prahom od mente, bombone s marmeladom, praline, čokoladni krem, žvakaće gume, žvakaće gume koje prave balone i gume za žvakanje, ne-medicinski konditorski proizvodi; konditorski proizvodi od šećera, uključujući cikoriju, karamelu, žele; smrznuti konditorski proizvodi; rashlađeni konditorski proizvodi; sladoled; led; deserti.

---

(111) **15091**

(151) 25.12.2020.

(210) Ž-2020-61

(220) 19.02.2020.

(732) International Foodstuffs Co LLC, P.O. Box No. 4115, Sharjah, AE

(540)

## TAKE 5

(550) I

(740) Miladin Popović, Đoka Miraševića 21/III, 81000, Podgorica

(511) Klasa 30: Čokolade, slatkiši, bombone, biskviti (sve vrste), kolači, tjestenina, makaroni, rezanci, instant rezanci, špageti, rezanci za supu, kvasac, prašak za pecivo i

ostali pekarski sastojci, prelive za salate, majonez, sirće, kečap i sosovi (začini), polugotovi proizvodi od tijesta, smrznuto tijesto, smrznute parate, sladoledi, smrznuti deserti koji nijesu mliječni, smrznuti voćni deserti, ledeni deserti, kafa, čaj, kakao, šećer, pirinač, tapioka, sago, zamjena za kafu, hleb, pecivo, melasa, so, senf, brašno od žitarica, začini, prehrambena pića (na bazi žitarica i bilja), sosovi (umaci od mesa), biljni čaj, med.

---

(111) **15092**

(151) 25.12.2020.

(210) Ž-2020-73

(220) 27.02.2020.

(732) Kent Gida Maddeleri Sanayii ve Ticaret Anonim Sirketi, Cumhuriyet Mahallesi 2253, Sokak. No.11, 41400, Gebze/Kocaeli,Istanbul, TR

(540)

## TOFITA

(550) I

(740) Miladin Popović, Đoka Miraševića 21/III, 81000, Podgorica

(511) Klasa 30: Nemedicinski konditorski proizvodi; čokolada; čokoladni konditorski proizvodi; slatkiši od šećera, uključujući slatkiše od slatkog korjena (sladića), karamele, žele; smrznuti konditorski proizvodi; rashlađeni konditorski proizvodi; sladoled; led; deserti; kolači, biskviti i napolitanke; žvakaće gume i žvakaće gume za pravljenje balona.

---

(111) **15093**

(151) 25.12.2020.

(210) Ž-2020-19

(220) 24.01.2020.

(732) Intercontinental Great Brands LLC, 100 Deforest Avenue, 07936, East Hanover, NJ, US

(540)

## BELVITA

(550) I

(740) Miladin Popović, Đoka Miraševića 21/III, 81000, Podgorica

(511) Klasa 30: Peciva; poslastice; brašno i proizvodi napravljeni od žitarica; hleb; dvopek; kolačići; keks štanglice; krekeri; čokoladne štanglice i grickalice u obliku štanglica,

naime štanglice od žitarica, štanglice za doručak, slatkiši u oblik u štanglica, štanglice sa koštunjavim voćem, energetske štanglice, proteinske štanglice, štanglice sa niskim sadržajem ugljenih hidrata; štanglice od žitarica sa jogurtom; štanglice od žitarica sa mlijekom; štanglice od žitarica sa voćem; jogurt štanglice i dijetalne štanglice; štanglice od žitarica sa čokoladom; keksi; led; sladoledi; konditorski proizvodi od šećera; smrznuti konditorski proizvodi; sladoled; deserti; smrznuti deserti; rashlađeni deserti; kolači; mrvice od kolača; pekarski proizvodi; svi naprijed navedeni proizvodi nijesu posebno namijenjeni bebama, djeci i odojčadi.

---

(111) **15094**

(151) 25.12.2020.

(210) Ž-2020-20

(220) 24.01.2020.

(732) Intercontinental Great Brands LLC, 100 Deforest Avenue, 07936, East Hanover, New Jersey, US

(540)



(550) I

(740) Miladin Popović, Đoka Miraševića 21/III, 81000, Podgorica

(511) Klasa 30: Peciva; poslastice; brašno i proizvodi napravljeni od žitarica; hleb; dvopek; kolačići; keks štanglice; krekeri; čokoladne štanglice i grickalice u obliku štanglica, naime štanglice od žitarica, štanglice za doručak, slatkiši u oblik u štanglica, štanglice sa koštunjavim voćem, energetske štanglice, proteinske štanglice, štanglice sa niskim sadržajem ugljenih hidrata; štanglice od žitarica sa jogurtom; štanglice od žitarica sa mlijekom; štanglice od žitarica sa voćem; jogurt štanglice i dijetalne štanglice; štanglice od žitarica sa čokoladom; keksi; led; sladoledi; konditorski proizvodi od šećera; smrznuti konditorski proizvodi; sladoled; deserti; smrznuti deserti; rashlađeni deserti; kolači; mrvice od kolača; pekarski proizvodi; svi naprijed navedeni proizvodi nijesu posebno namijenjeni bebama, djeci i odojčadi.

---

(111) **15096**

(151) 26.01.2021.

(210) Ž-2019-493

(220) 13.12.2019.

(732) MONTORA SOFTWARE D.O.O., CRNOGORSKIH SERDARA BB, PODGORICA, ME

(540)



(550) I

(511) Klasa 35: Oglašavanje i reklamiranje; vođenje komercijalnih poslova; komercijalna administracija; kancelarijski poslovi.

Klasa 41: Obuka; stručno osposobljavanje; razonoda; sportske i kulturne djelatnosti.

Klasa 43: Usluge obezbjeđivanja hrane i pića; privremeno primanje na stan.

---

(111) **15097**

(151) 26.01.2021.

(210) Ž-2019-494

(220) 13.12.2019.

(732) MONTORA SOFTWARE D.O.O., CRNOGORSKIH SERDARA BB, PODGORICA, ME

(540)



VISSI D'ARTE

(550) I

(511) Klasa 35: Oglašavanje i reklamiranje; vođenje komercijalnih poslova; komercijalna administracija; kancelarijski poslovi.

Klasa 41: Obuka; stručno osposobljavanje; razonoda; sportske i kulturne djelatnosti.

Klasa 43: Usluge obezbjeđivanja hrane i pića; privremeno primanje na stan.

---

(111) **15098**

(151) 26.01.2021.

(210) Ž-2019-495

(220) 13.12.2019.

(732) MONTORA SOFTWARE D.O.O., CRNOGORSKIH SERDARA BB, PODGORICA,  
ME

(540)



VISSI D'ARTE  
HOTEL

(550) I

(511) Klasa 35: Oglašavanje i reklamiranje; vođenje komercijalnih poslova; komercijalna administracija; kancelarijski poslovi.

Klasa 43: Usluge obezbjeđivanja hrane i pića; privremeno primanje na stan.

---

(111) **15099**

(151) 26.01.2021.

(210) Ž-2019-501

(220) 16.12.2019.

(732) MONTORA SOFTWARE D.O.O., CRNOGORSKIH SERDARA BB, PODGORICA,  
ME

(540)

VISSI D'ARTE

(550) I

(511) Klasa 35: Oglašavanje i reklamiranje; vođenje komercijalnih poslova; komercijalna administracija; kancelarijski poslovi.

Klasa 41: Obuka; stručno osposobljavanje; razonoda; sportske i kulturne djelatnosti.  
Klasa 43: Usluge obezbjeđivanja hrane i pića; privremeno primanje na stan.

---

(111) **15100**

(151) 26.01.2021.

(210) Ž-2020-10

(220) 17.01.2020.

(732) Auberge Resorts LLC, 33 Reed Blvd, 94941-2306, Mill Valley, California, US

(540)

## INAYA

(550) I

(740) Jasna Jusić, Dalmatinska 2, 81000, Podgorica

(511) Klasa 35: Oglašavanje; poslovni menadžment; poslovna administracija; kancelarijski poslovi; upravljanje hotelima, odmaralištima, spa centrima i restoranima za druge; hotelska administracija; pružanje usluga poslovnih centara, naime, iznajmljivanje kancelarijskih uređaja i planiranje poslovnih sastanaka; organizacija konvencija i izložbi za poslovne i komercijalne potrebe; administracija programa lojalnosti klijenata; vođenje poslova u hotelima, odmaralištima, spa centrima i restoranima, lokalima sa prehrambenim proizvodima, lokalima sa pićem, kancelarijama, poslovnim centrima i veleprodajnim lokalima; konsultantske usluge u vezi sa administracijom i upravljanjem hotelima; usluge poslovnog savjetovanja u vezi sa franšizama; obezbjeđivanje programa članstva klijenata, lojalnosti, inicijativa, nagrađivanja i unovčavanja za komercijalne, promotivne i/ili reklamne usluge; promocija stanova, kondominijuma, nekretnina za vremensko dijeljenje, komercijalnih nekretnina, nekretnina svih vrsta i njihovih sadržaja.

Klasa 36: Osiguranje: finansijski poslovi; monetarni poslovi; poslovi sa nekretninama; usluge upravljanja nekretninama; izdavanje stanova; usluge sa nekretninama, naime, iznajmljivanje, unajmljivanje i upravljanja stambenom nekretninom; usluge poslovanja sa nekretninama, naime, usluge upravljanja kondominijumima; usluge nekretnina sa vremenski ograničenim korištenjem; kupovina, prodaja, finansiranje, poslovanje stanovima, kondominijumima, nekretninom sa vremenski ograničenim korištenjem, komercijalnim nekretninama, nekretninama svih vrsta i objekata i sadržaja koji idu uz njih; aranžmani razmjena nekretnina, naime apartmana, kondominijuma, komercijalnih nekretnina, nekretnina svih vrsta i objekata i sadržaja koji idu uz njih; iznajmljivanje i usluge posredovanja sa apartmanima, kodominijumima, komercijalnim nekretninama, nekretninama svih vrsta te objektima i sadržajima koji idu uz njih.

Klasa 37: Izgradnja nekretnina; izgradnja apartmana, kondominijuma, nekretnina sa vremenski ograničenim korištenjem, komercijalnih nekretnina, nekretnina svih vrsta i objekata i sadržaja koji udi uz njih.

Klasa 39: Transport, pakovanje i skladištenje roba; putnički aranžmani i turističke usluge; organizovanje tura, pratnje putnicima, prevoz putnika; vođenje garaža, iznajmljivanje parking mjesta, parkiranje auta; rezervacija mjesta za putnika i putne rezervacije.

Klasa 41: Obazovanje; pružanje obuka; zabava; sportske i kulturne aktivnosti; obezbjeđivanje objekata i informacija za rekreaciju i sport; organizovanje rekreativnih aktivnosti; obezbjeđivanje prostora za rekreaciju; organizovanje rekreativnih događaja; usluge zabave; pružanje informacija o zabavama; pružanje usluga zdravstvenog kluba i sportskih sala; usluge klubova za zabavu; usluge umjetničkih galerija; obezbjeđivanje objekata za kazino i kocku; organizovanje sastanaka, konferencija i izložbi.

Klasa 43: Usluge obezbjeđivanja hrane i pića; privremeni smještaj; usluge hotela i odmarališta, usluge hotelskih rezervacija; usluge restorana, kateringa i banketa; pravljenje rezervacija za duže i kraće boravke u stanovima i kondominijumima; rezervisanje privremenog smještaja; obezbjeđivanje objekata za izložbe; iznajmljivanje i usluge posredovanja u vezi sa nekretninama sa vremenski ograničenim korištenjem; aranžmani razmjene nekretnina sa vremenskim ograničenim korištenjem i drugih nekretnina sa ograničenim intervalima korištenja.

Klasa 44: Higijenska i kozmetička njega za ljude; spa usluge; zdravstvene spa usluge, naime usluge kozmetičke njege tijela; usluge salona za uljepavanje; obezbjeđivanje objekata za saune; usluge aromaterapije; usluge masaže.

---

(111) **15101**

(151) 26.01.2021.

(210) Ž-2020-50

(220) 12.02.2020.

(732) HRA PHARMA RARE DISEASES, 200 avenue de Paris, 92320, Châtillon, FR

(540)

## LYSODREN

(550) I

(740) AOD MSA IP - Milojević Sekulić Advokati, Karađorđeva 65, 11000, Beograd

(511) Klasa 5: Farmaceutski, medicinski i veterinarski preparati; sanitarni preparati za upotrebu u medicini, uključujući simptomatsko lečenje naprednog adrenokortikalnog karcinoma (AKK) i Kušingovog sindroma.

Klasa 44: Medicinske usluge; veterinarske usluge; higijenska i kozmetička njega za ljude ili životinje.

---

(111) **15102**

(151) 26.01.2021.

(210) Ž-2019-473

(220) 02.12.2019.

(732) MULTIFIT Tiernahrungs GmbH, Westpreußenstr. 32-38, 47809, Krefeld, DE

(540)



(550) I

(740) Jasna Jusić, Dalmatinska 2, 81000, Podgorica

(511) Klasa 31: Hrana za životinje; sijeno; kosti za žvakanje; pijesak (piljevina za životinje), posebno ptičji pijesak; piljevina za životinje.

---

(111) **15103**

(151) 26.01.2021.

(210) Ž-2019-386

(220) 11.10.2019.

(732) DOO "HOUSE ESTATE", SVETI STEFAN, POŠTANSKI FAH BR.7, 85310, Budva, ME

(540)

MUSE

(550) I

(740) Goran Velimirović, Serdara Jola Piletića 8/6, 81000, Podgorica

(511) Klasa 43: agencije za smještaj [hotelski, pansionski]; aparati za kuvanje (iznajmljivanje); barovi (usluge barova); hotelske rezervacije (usluge rezervisanja hotela); hotelske usluge; iznajmljivanje aparata za kuvanje; iznajmljivanje prenosivih građevinskih objekata; iznajmljivanje prenosivih građevinskih objekata; iznajmljivanje privremenog smještaja; iznajmljivanje sala, dvorana za sastanke; iznajmljivanje stolaca, stolova, stolnog rublja i staklenog posuđa; iznajmljivanje šatora; iznajmljivanje uređaja za pitku vodu; jaslice [dječije ustanove]; kafane [kafeterije]; kafane-restorani; kampovanje (stavljanje na raspolaganje terena za kampovanja); kampovi (iskorištavanje terena za kampiranje); kampovi za ljetovanje (usluge kampova za ljetovanje) [smještaj]; kantine; ljetovališta; ljetovanje (usluge kampova za ljetovanje); moteli (usluge motela); pansion za životinje; pansioni; pansioni (rezervisanje pansiona); prenosivi građevinski objekti (iznajmljivanje prenosivih građevinskih objekata); privremeni smještaj (rezervisanje privremenog smještaja); restorani; restorani sa samoposluživanjem; restorani za brzo i stalno posluživanje [snek-barovi]; rezervisanje hotela; rezervisanje pansiona; rezervisanje privremenog smještaja; smještaj (agencije za izdavanje smještaja) [hoteli, pansioni]; smještaj (iznajmljivanje privremenog smještaja); starije osobe (ustanove za smještaj starijih osoba) [starački domovi]; ugostitelji (usluge keteringa); ustanove za smještaj starijih



osoba [starački domovi]; životinje (pansioni za životinje).

---

(111) **15104**

(151) 27.01.2021.

(210) Ž-2019-442

(220) 13.11.2019.

(732) Lidl Stiftung & Co. KG , Stiftsbergstrasse 1, 74172, Neckarsulm, DE

(540)

**R&B**

(550) I

(740) Vuk Lutovac, Bulevar Ivana Crnojevića 93, 81000, Podgorica

(511) Klasa 25: Čarape i pletena trikotaža.

---

(111) **15105**

(151) 27.01.2021.

(210) Ž-2019-443

(220) 13.11.2019.

(732) Lidl Stiftung & Co. KG , Stiftsbergstrasse 1, 74172, Neckarsulm, DE

(540)

**ANTICA CASCINA**

(550) I

(740) AOD "Lutovac & partneri", Bulevar Ivana Crnojevića 93, 81000, Podgorica

(511) Klasa 33: Alkoholna pića (osim piva), naročito vina.

---

(111) **15106**

(151) 27.01.2021.

(210) Ž-2019-444

(220) 13.11.2019.

(732) Lidl Stiftung & Co. KG , Stiftsbergstrasse 1, 74172, Neckarsulm, DE

(540)

**ABRACHAN**

(550) I

(740) AOD "Lutovac & partneri", Bulevar Ivana Crnojevića 93, 81000, Podgorica

(511) Klasa 33: Žestoka pića.

---

(111) **15107**

(151) 27.01.2021.

(210) Ž-2019-445

(220) 13.11.2019.

(732) Lidl Stiftung & Co. KG , Stiftsbergstrasse 1, 74172, Neckarsulm, DE

(540)

**BEN BRACKEN**

(550) I

(740) AOD "Lutovac & partneri", Bulevar Ivana Crnojevića 93, 81000, Podgorica

(511) Klasa 33: Alkoholna pića (izuzev piva), naročito viski.

---

(111) **15108**

(151) 27.01.2021.

(210) Ž-2019-446

(220) 13.11.2019.

(732) Lidl Stiftung & Co. KG , Stiftsbergstrasse 1, 74172, Neckarsulm, DE

(540)



(550) I

(740) AOD "Lutovac & partneri", Bulevar Ivana Crnojevića 93, 81000, Podgorica

(511) Klasa 33: Vina.

---

(111) **15109**

(151) 27.01.2021.

(210) Ž-2019-447

(220) 13.11.2019.

(732) Lidl Stiftung & Co. KG , Stiftsbergstrasse 1, 74172, Neckarsulm, DE

(540)

Villa  
**BONAGA**

(550) I

(740) AOD "Lutovac & partneri", Bulevar Ivana Crnojevića 93, 81000, Podgorica

(511) Klasa 33: Alkoholna pića (osim piva), naročito vina.

---

(111) **15110**

(151) 27.01.2021.

(210) Ž-2019-448

(220) 13.11.2019.

(732) Lidl Stiftung & Co. KG , Stiftsbergstrasse 1, 74172, Neckarsulm, DE

(540)

## MEZQUIRIZ

(550) I

(740) AOD "Lutovac & partneri", Bulevar Ivana Crnojevića 93, 81000, Podgorica

(511) Klasa 33: Alkoholna pića (osim piva), naročito vina.

---

(111) **15111**

(151) 27.01.2021.

(210) Ž-2019-449

(220) 13.11.2019.

(732) Lidl Stiftung & Co. KG, Stiftsbergstrasse 1, 74172, Neckarsulm, DE

(540)

## Bitterol

(550) I

(740) AOD "Lutovac & partneri", Bulevar Ivana Crnojevića 93, 81000, Podgorica

(511) Klasa 33: Alkoholna pića (osim piva), naročito votka, tekila, viski, škotski viski, konjak, brendi, rakija, likeri, biteri; alkoholni kokteli na bazi destilovanjih žestokih pića, likera i/ili bitera.

---

(111) **15112**

(151) 27.01.2021.

(210) Ž-2019-450

(220) 13.11.2019.

(732) Lidl Stiftung & Co. KG, Stiftsbergstrasse 1, 74172, Neckarsulm, DE

(540)



(550) I

(740) AOD "Lutovac & partneri", Bulevar Ivana Crnojevića 93, 81000, Podgorica

(511) Klasa 5: Slatkiši za medicinsku upotrebu, naročito bombone.  
Klasa 30: Slatkiši od šećera, naročito bombone, kao i biljne bombone; med.

---

(111) **15113**  
(151) 27.01.2021.  
(210) Ž-2019-451  
(220) 13.11.2019.  
(732) Lidl Stiftung & Co. KG, Stiftsbergstrasse 1, 74172, Neckarsulm, DE  
(540)

## LIBERTARIO

(550) I

(740) AOD "Lutovac & partneri", Bulevar Ivana Crnojevića 93, 81000, Podgorica

(511) Klasa 33: Alkoholna pića (osim piva), naročito vina, pjenušava vina.

---

(111) **15114**  
(151) 27.01.2021.  
(210) Ž-2019-452  
(220) 13.11.2019.  
(732) Lidl Stiftung & Co. KG, Stiftsbergstrasse 1, 74172, Neckarsulm, DE  
(540)

## RENCHTÄLER

(550) I

(740) AOD "Lutovac & partneri", Bulevar Ivana Crnojevića 93, 81000, Podgorica

(511) Klasa 33: Alkoholna pića (osim piva), naročito vina, pjenušava vina, port vina, destilovana žestoka pića, naročito sambuka, vermut, brendi, konjak, viski, rum, tekila, votka; liker; alkoholni kokteli na bazi destilovanih žestokih pića, likera i/ili sambuke, proizvodi za pripremu alkoholnih pića, naročito sirupi i koncentracije za pravljenje alkoholnih koktela; aromatizovana alkoholna pića.

---

(111) **15115**

(151) 27.01.2021.

(210) Ž-2020-77

(220) 04.03.2020.

(732) Xiaomi Inc., No.006, floor 6, building 6, yard 33, middle Xierqi Road, Haidian District, Beijing, CN

(540)

## Redmi

(550) I

(740) Jasna Jusić, Dalmatinska 2, 81000, Podgorica

(511) Klasa 9: Notebook računari; računari; računarski programi, snimljeni; računarski programi koje se mogu preuzeti; računarski softver, snimljen; elektronske publikacije koje se mogu preuzeti; snimljeni programi računarskih igara; prazni kertridži za štampače i fotokopir uređaje; slikovne datoteke koje se mogu preuzimati; humanoidni roboti sa vještačkom inteligencijom; nosivi računari; platforme računarskog softvera, snimljene ili koje se mogu preuzimati; grafike za mobilne telefone koje se mogu preuzimati; računarski periferni uređaji; interaktivni terminali osjetljivi na dodir; softver za čuvanje ekrana računara, snimljen ili koji se može preuzimati; kodirane narukvice za elektronsku identifikaciju; pametni sat; tablet računari; kodirane narukvice za identifikaciju, magnetne; podloge za miš; miš (računarska periferna oprema); foto štampači; torbe za računare; elektronski čitači kartica; računarske tastature; USB uređaji; aplikacijski softver za mobilne telefone, koji se može preuzimati; mlazni štampači; pametni satovi (obrada podataka); melodije zvona za mobilne telefone koje se mogu preuzimati; pametne naočare (obrada podataka); elektronski džepni prevodioci; brojači koraka; aparat za provjeru frankiranja; kase; mehanizmi za aparate koji se pokreću kovanicama; diktafoni; hologrami; markeri za obilježavanje tkanine; mašine za glasanje; mašina za lutriju; uređaj za prepoznavanje lica; fotokopirni uređaji [fotografski, elektrostatički, termički]; vage za kupatilo; vage za mjerenje tjelesne težine za kućnu upotrebu; mjere; elektronske oglasne table; selfi štapovi za mobilne telefone; držači za mobilne telefone; pametni telefoni u obliku sata; interfoni; elektronski uređaji i instrumenti za navigaciju i pozicioniranje; mobilni telefoni; držači mobilnih telefona za vozila; telekomunikacioni aparati u obliku nakita; futrole za mobilne telefone; navlake za mobilne telefone; privjesci za mobilne telefone; zaštitne folije prilagođene mobilnim telefonima; mrežni usmjerivači (ruteri); SIM kartice; kućišta za zvučnike; video monitori; virtuelne naočare; prenosivi medija plejeri; audio i video prijemnici; nosivi monitori; slušalice; kamkorderi; rikverc kamere za vozila; snimač vožnje; olovke za ekrane osjetljive na dodir; mašine za obuku; televizori; uređaji za snimanje zvuka; set-top boks; digitalni okviri za fotografije; selfi štapovi [monopodi koji se drže u ruci]; kamere (fotografija); povezane narukvice (mjerni instrumenti); audiovizuelni nastavni uređaji; nastavni roboti; aparati za analizu vazduha; termometri, koji nisu za medicinsku upotrebu; higrometri; optički aparati i instrumenti; USB kablovi; materijali za električne instalacije [žice, kablovi]; poluprovodnici; provodnici, električni; električne utičnice; senzori; temperaturni senzori; prekidači, električni; adapteri za napajanje; električni adapteri; preklopni prekidači za telekomunikacione uređaje; uređaji za daljinsko upravljanje; daljinski upravljači za kućnu upotrebu; optička vlakna [svjetloprovodna sijalična vlakna]; uređaji za regulaciju toplote; gromobrani; elektrolizatori; protivpožarni aparati; radiološki uređaji za

industrijske svrhe; uređaji za zaštitu od nesreća za ličnu upotrebu; zaštitne maske; zaštitne kacige; zaštitne naočare; električne instalacije za sprječavanje krađe; alarmi; biometrijske brave na otisak prsta; električna zvana na vratima; naočare; naočare za sunce; baterije, električne; punjači za električne baterije; eksterna baterija [baterije koje se mogu puniti]; bežični punjač; animirani crtani filmovi; inkubatori za jaja; pištaljke za pse; dekorativni magneti; električne ograde elektronske ogrlice za dresuru životinja; prenosivi daljinski upravljači za blokatore za točkove vozila koja stoje u mjestu; elektronske trake za praćenje zdravlja koje prenose podatke u stvarnom vremenu na druge elektronske uređaje; nosivi uređaji za komunikaciju; nosivi digitalni elektronski uređaji koji mogu da omoguće pristup internetu; nosivi pametni uređaji; lični digitalni asistenti u obliku sata; nosivi pratioci aktivnosti; magnet za frižider; instrumenti za mjerenje; uređaji za mjerenje, električni; elektronski čipovi; multimedijalni projektori; uređaji i instrumenti za vaganje; brojači; računarski hardver; muzičke datoteke koje se mogu preuzimati; špijunke za vrata; video ekrani; simulatori za upravljanje i kontrolu vozila; automatski indikatori niskog pritiska u gumama automobila; stalci za fotografske aparate; biciklističke kacige; bankomati; spoljna nadzorna kamera; tabla sa prekidačima visokog i niskog napona; instrumenti za ispitivanje nafte; prekidači za svjetlo; uređaji za mjerenje rastojanja; razvodna tabla; električne utičnice; uređaji za punjenje baterija za motorna vozila; USB kablovi za mobilne telefone; ekran sa tačnim kristalima; ekrani televizora; bežične slušalice za upotrebu sa pametnim telefonima; slušalice sa funkcijom potiskivanja buke; slušalice za unutrašnjost uva; mikrofoni; zaštitne kacige za sport; senzori za određivanje nivoa tečnosti.

---

(111) **15116**

(151) 28.01.2021.

(210) Ž-2018-67

(220) 27.02.2018.

(732) "Atlas Media Group" društvo sa ograničenom odgovornošću, Stanka Dragojevića, br. 4, Podgorica, ME

(540)



(550) I

(740) Ivona Čavić, 27. Marta br. 58, 81000, Podgorica

(511) Klasa 35: Agencije za komercijalne oglase; ekonomska predviđanja [prognoze]; fakturisanje; informacije (kancelarije za komercijalne informacije); informacije (poslovne informacije); isporuka reklamnih materijala [letaka, prospekata, uzoraka]; isporuka

reklamnih oglasa; istraživanja za poslove; istraživanje javnog mišljenja; izložbe (organizovanje izložbi) u komercijalne ili reklamne svrhe; iznajmljivanje reklamnih prostora; iznajmljivanje reklamnog materijala; iznajmljivanje vremena za reklamiranje na svim komunikacionim sredstvima; javno mnijenje (istraživanje javnog mnjenja) [anketiranje]; javnost (odnosi s javnošću) [propaganda]; kancelarije za reklamiranje; marketing; objavljivanje reklamnih tekstova; odnosi s javnošću [propaganda]; oglašavanje [reklamiranje]; oglašavanje putem pošte; organizovanje izložbi u komercijalne ili reklamne svrhe; plakatiranje [oglašavanje]; podsticaj prodaje za treće osobe; potrošači (pružanje komercijalnih savjeta i informacija potrošačima); prepis saopštenja; radio (reklamiranje putem radija); reklamiranje (iznajmljivanje prostora za potrebe reklamiranja); reklamiranje dopisnim putem; reklamiranje on-line na informatičkoj mreži; reklamiranje putem radija; reklamiranje putem televizije; reklamna dokumentacija (uređenje reklamne dokumentacije); reklamna pošta; reklamni filmovi (proizvodnja reklamnih filmova); reklamni materijal (iznajmljivanje reklamnog materijala); reklamni materijal (razdioba reklamnog materijala); reklamni materijal (raznošenje reklamnog materijala); reklamni oglasi (širenje reklamnih oglasa); reklamni tekstovi (objavljivanje reklamnih tekstova); reklamni tekstovi (uređenje reklamnih tekstova); saopštenja (prepisi, saopštenja); štampa (praćenje štampe); štampa (usluge pregleda štampe); televizijsko reklamiranje.

Klasa 38: Agencije za novosti; bežična radiodifuzija; elektronska pošta (omogućavanje elektronske pošte); elektronske poruke; emitiranje televizijskih programa; forumi za vođenje debata (omogućavanje održavanja foruma za vođenje debata); informacije o telekomunikacijama; informativne agencije [novosti]; kompjuterski prijenos poruka i slika; komuniciranje posredstvom mreža optičkih kablova; komunikacije (radiotelefonske komunikacije); komunikacije (telefonske komunikacije); komunikacije (telegrafске komunikacije); komunikacije pomoću kompjuterskih terminala; konferencije na daljinu (omogućavanje vođenja konferencija na daljinu); otprema pošiljki; plakatiranje (usluge elektronskog plakatiranja) [telekomunikacije]; poruke (prijenos poruka); prijenos digitalnih datoteka; prijenos poruka i slika kompjuterom; prijenos putem satelita; prijenos televizijskih emisija pretplatnicima putem kabla [kablovska televizija]; radio programi (emitovanje radio programa); radiodifuzija; radioelektronsko pozivanje (usluge radioelektronskog pozivanja) [radio, telefon ili ostala elektronska komunikaciona sredstva]; radiotelefonski prijenosi; sateliti (prijenos putem satelita); televizijski programi (emitiranje televizijskih programa); vijesti (agencije za vijesti).

Klasa 41: Filmovi (prikazivanje igranih filmova); filmovi (proizvodnja filmova); fotografisanje; fotografske reportaže; informacije o obrazovanju; informacije o razonodi; informacije u vezi rekreacije; izložbe (organizovanje izložbi) u kulturne ili obrazovne svrhe; iznajmljivanje kinematografskih filmova; iznajmljivanje kinoaparature i pribora; iznajmljivanje rasvjetnih uređaja za pozorišnu dekoraciju i za televizijske studije; iznajmljivanje zvučnih snimaka; mikrofilmovi (snimanje na mikrofilmove); montaža radio i televizijskih programa; obrazovanje (informacije o obrazovanju); organizovanje i vođenje razgovora; organizovanje spektakla [usluge impresarija]; planiranje prijema [razonoda]; proizvodnja filmova; proizvodnja filmova na video-trakama; proizvodnja muzike; radio televizijski programi (montaža radio televizijskih programa); radiofonija (razonoda putem radiofonije); razonoda (informacije u vezi razonode); razonoda posredstvom radija; razonoda posredstvom televizije; reportaže (fotografske reportaže); reporterske usluge; scenarijumi (izrada scenarijuma); seminari (organizovanje i vođenje seminara); sinhronizacija; slobodno vrijeme (usluge za ispunjavanje slobodnog vremena); snimanje na videotrake; studio za snimanje (usluge studija za snimanje); tekstovi (objavljivanje



tekstova) [osim u reklamne svrhe]; tekstovi (sastavljanje tekstova) [ne u reklamne svrhe]; televizija (razonoda na televiziji); televizijski programi (montaža radio i televizijskih programa); titlovanje filmova; videotrake (montaža videotraka); videotrake (proizvodnja filmova na videotrakama); videotrake (snimanje na videotrake); zvučni snimci (iznajmljivanje zvučnih snimaka).

---

(111) **15117**

(151) 11.02.2021.

(210) Ž-2018-329

(220) 29.08.2018.

(732) Košarkaški klub Budućnost VOLI, Podgorica, Njegošev Park bb, Podgorica, ME

(540)



(550) I

(511) Klasa 35: Oglašavanje i reklamiranje; vođenje komercijalnih poslova; komercijalna administracija; kancelarijski poslovi.

Klasa 41: Obuka; stručno osposobljavanje; razonoda; sportske i kulturne djelatnosti.

---

(111) **15118**

(151) 17.02.2021.

(210) Ž-2019-454

(220) 15.11.2019.

(732) AbbVie Biotechnology Ltd, Clarendon House, 2 Church Street, HM11, Hamilton, BM

(540)

**SKYRIZI**

(550) I

(740) Miladin Popović, Đoka Miraševića 21/III, 81000, Podgorica

(511) Klasa 5: Farmaceutski preparati.

---

(111) **15119**

(151) 18.02.2021.

(210) Ž-2019-516

(220) 27.12.2019.

(732) Društvo za proizvodstvo, promet i usluge VIVAKS Risto i drugi DOO uvoz-izvoz  
Skopje, Pero Nakov br.21, 1000, Skopje, MK

(540)



(550) I

(740) Relja Mirkov, Patrijarha Joanikija 14, Beograd

(511) Klasa 29: Meso, riba, živina i divljač; mesni ekstrakti; konzervirano, sušeno i kuvano voće povrće; želei, džemovi, kompoti; jaja, mlijeko i mliječni proizvodi; jestiva ulja i masti.

Klasa 30: Kafa, čaj, kakao, šećer, riža, tapioka, sago, zamjene za kafu; brašno i proizvodi od žitarica, hleb, kolači, poslastice, bomboni, sladoled; med, sirup od melase; kvasac, prašak za pecivo; so, senf; sirće, prelive; začini, razni začini; led za hlađenje.

Klasa 32: Pivo; mineralne i gazirane vode i ostala bezalkoholna pića; pića od voća i voćni sokovi; sirupi i ostali preparati za pripremanje napitaka.

---

(111) **15120**

(151) 19.02.2021.

(210) Ž-2020-40

(220) 07.02.2020.

(732) Max Rohr, Inc., 300 Delaware Avenue, DE 19801, Wilmington, Delaware, US

(540)



(550) I

(740) AOD "Ćupić", Bulevar Džordža Vašingtona 79, 81000, Podgorica

(511) Klasa 34: Duvan, prerađen ili sirov; duvanski proizvodi; zamjene za duvan (za nemedicinsku upotrebu); cigarete; cigarilosi; cigare; džepne naprave za savijanje cigareta; tube za cigarete; filteri za cigarete; papirići za cigarete; elektronske cigarete; tekući rastvori za upotrebu u elektronskim cigaretama; šibice i pribor za pušače.

---

(111) **15121**

(151) 19.02.2021.

(210) Ž-2019-468

(220) 27.11.2019.

(300) JM, broj 077858 od 11.06.2019.

(732) The Ritz-Carlton Hotel Company, L.L.C., 10400 Fernwood Road, 20817, Bethesda, Maryland, US

(540)

## LUMINARA

(550) I

(740) Jasna Jusić, Dalmatinska 2, 81000, Podgorica

(511) Klasa 39: Prevoz putnika i roba čamcem; pakovanje i skladištenje roba; usluge prevoza putnika kruzerima; usluge kruzera; usluge putničkih agencija, naime, organizovanje, pravljenje i primanje rezervacija za prevoz putnika i roba, usluge krstarenja i kruzera, ekskurzije u vidu prevoza na ture sa vodičem, prevoz za ture sa razgledanjem znamenitosti, godišnji odmori u vidu krstarenja i putničkog prevoza; organizovanje i izvođenje ekskurzija u vidu pružanja prevoza za ekskurzije, ture u vidu obezbjeđivanja prevoza za ture sa razgledanjem znamenitosti, godišnji odmori u vidu krstarenja i organizovanja krstarenja; usluge turističkog vodiča i turističkih informacija; usluge planiranja događaja i rukovođenja, naime, ugovaranje, organizacija, planiranje i osmišljavanje godišnjih odmora u vidu organizovanja putovanja; pružanje informacija i savjeta u vezi sa gorepomenutim uslugama.

Klasa 43: Obezbeđivanje hrane i pića i privremenog smještaja na kruzenu; pružanje usluga rezervacija za druge za privremeni smještaj na kruzenu.

---

(111) **15122**

(151) 19.02.2021.

(210) Ž-2019-467

(220) 27.11.2019.

(300) JM, broj 077854 od 11.06.2019.

(732) The Ritz-Carlton Hotel Company, L.L.C., 10400 Fernwood Road, 20817, Bethesda, Maryland, US

(540)

## ILMA

(550) I

(740) Jasna Jusić, Dalmatinska 2, 81000, Podgorica

(511) Klasa 39: Prevoz putnika i roba čamcem; pakovanje i skladištenje roba; usluge prevoza putnika kruzerima; usluge kruzera; usluge putničkih agencija, naime, organizovanje, pravljenje i primanje rezervacija za prevoz putnika i roba, usluge krstarenja i kruzera, ekskurzije u vidu prevoza na ture sa vodičem, prevoz za ture sa razgledanjem znamenitosti, godišnji odmori u vidu krstarenja i putničkog prevoza; organizovanje i izvođenje ekskurzija u vidu pružanja prevoza za ekskurzije, ture u vidu obezbjeđivanja prevoza za ture sa razgledanjem znamenitosti, godišnji odmori u vidu krstarenja i organizovanja krstarenja; usluge turističkog vodiča i turističkih informacija; usluge planiranja događaja i rukovođenja, naime, ugovaranje, organizacija, planiranje i osmišljavanje godišnjih odmora u vidu organizovanja putovanja; pružanje informacija i savjeta u vezi sa gorepomenutim uslugama.

Klasa 43: Obezbeđivanje hrane i pića i privremenog smještaja na kruzeru; pružanje usluga rezervacija za druge za privremeni smještaj na kruzeru.

---

(111) **15123**

(151) 19.02.2021.

(210) Ž-2017-273

(220) 21.07.2017.

(732) ALLERGAN HOLDINGS France SAS Societe anonyme par actions simplifiee, 12 place de la defense, 4eme etage, 92400, Courbevoie, FR

(540)

## JUVEDERM

(550) I

(740) Miladin Popović, Đoka Miraševića 21/III, 81000, Podgorica

(511) Klasa 3: Kozmetika, natme preparati za tretman glabelarnih bora, bora na licu, asimetrija nedostataka i stanja ljudske kože.

Klasa 5: Farmaceutski preparati za tretman glabelarnih bora, bora na licu, asimetrija i

nedostataka i stanja ljudske kože; biološki dermalni implantati, naime, visko-suplementacioni rastvori za popunjavanje bora.

Klasa 10: Aparati za tretman glabelarnih bora, bora na licu, asimetrija i nedostataka i stanja ljudske kože; biološki dermalni implantati, naime, visko-suplementacioni rastvori za popunjavanje bora.

---

(111) **15124**

(151) 19.02.2021.

(210) Ž-2018-234

(220) 03.07.2018.

(732) DRUŠTVO ZA TELEKOMUNIKACIJE ORION TELEKOM D.O.O. PODGORICA, Ulcinjska 7 d, Gorica C, 81000, Podgorica, ME

(540)



(550) I

(511) Klasa 9: Računarski programi, snimljeni; računarski programi [softveri koji se mogu preuzimati]; aplikacije za računarske softvere koje se mogu preuzimati; telefonski prijemnici; audio i video prijemnici . Računarski programi, snimljeni; računarski programi [softveri koji se mogu preuzimati]; aplikacije za računarske softvere koje se mogu preuzimati; telefonski prijemnici; audio i video prijemnici . Računarski programi, snimljeni; računarski programi [softveri koji se mogu preuzimati]; aplikacije za računarske softvere koje se mogu preuzimati; telefonski prijemnici; audio i video prijemnici .

Klasa 38: Bežično emitovanje; forumi [pričaonice] na društvenim mrežama; usluge telekonferencija; usluge telekomunikacionog usmeravanja i povezivanja; usluge elektronskog biltena [telekomunikacione usluge]; usluge govorne pošte; usluge videokonferencija; telefonske usluge; telefonske komunikacije; striming [protok] podataka; slanje poruka; satelitski prenos; radio komunikacije; emitovanje kablovske televizije; emitovanje televizijskih programa; iznajmljivanje vremena pristupa globalnim računarskim mrežama; iznajmljivanje modema; iznajmljivanje telekomunikacione opreme; iznajmljivanje telefona; iznajmljivanje uređaja za slanje poruka; iznajmljivanje faksimil aparata; informacije o telekomunikacijama; komunikacija preko mreže optičkih vlakana ; komunikacija preko računarskih terminala; komunikacije mobilnim telefonima; obezbjeđenje korisničkog pristupa globalnoj računarskoj mreži; obezbjeđivanje telekomunikacionih veza sa globalnom računarskom mrežom; omogućavanje pristupa računarskim bazama podataka; prenos video sadržaja na zahtev; prenos digitalnih datoteka; prenos elektronske pošte; prenos poruka i slika posredstvom računara; prenos

faksimilom .

Klasa 42: Čuvanje rezervne kopije podataka van mreže; hosting računarskih sajtova [veb sajtova]; savjetodavne usluge iz oblasti telekomunikacione tehnologije; server hosting; softver u vidu servisa [SaaS]; savjetodavne usluge iz oblasti kompjuterske tehnologije; savjetovanje u oblasti računarskog softvera; savjetovanje u oblasti dizajna i razvoja računarskog hardvera; savjetovanje u vezi informacionih tehnologija; savjetovanje o sigurnosti računara; savjetovanje o izradi veb sajtova; računarstvo u oblaku; računarsko programiranje; razvoj softvera u okviru izdavanja softvera; održavanje računarskog softvera; nadgledanje računarskih sistema radi otkrivanja kvarova; nadgledanje računarskih sistema radi otkrivanja neovlašćenog pristupa ili povrede podataka; kreiranje i dizajniranje za druge indeksa informacija zasnovanih na internetu [usluge informacione tehnologije]; konsultacije o sigurnosti podataka; konsultacije o bezbjednosti interneta; konvertovanje računarskih podataka i programa, osim fizičkog konvertovanja; instaliranje računarskog softvera; izrada i održavanje veb stranica za druge; iznajmljivanje računarskog softvera; iznajmljivanje računara; iznajmljivanje veb servera; zaštita od računarskih virusa; elektronsko pohranjivanje podataka; dizajniranje računarskog softvera; dizajniranje računarskih sistema; ažuriranje računarskog softvera; analize računarskih sistema; vođenje studija tehničkog projektovanja; platforma kao usluga (PaaS).

---

(111) **15125**

(151) 19.02.2021.

(210) Ž-2019-238

(220) 25.06.2019.

(732) Zavarovalnica Triglav d.d., Miklošičeva 19, 1000, Ljubljana, SI

(540)



(550) I

(740) Nenad Pavličić, Ul. Novaka Miloševa br. 6/III, 81000, Podgorica

(511) Klasa 16: (Štampane publikacije i štampani materijali); posteri; štampane publikacije; oglasni panoji od papira ili kartona; plakati od papira ili kartona; fascikle (kancelarijske); omoti (kancelarijski); štampani rokovnici.

Klasa 25: (Promo materijali); kape; jakne; majice; rukavice; marama, šalovi.

Klasa 35: Širenje reklamnih sadržaja; pripremanje reklamnih rubrika; oglašavanje putem pošte; ažuriranje oglasnih materijala; iznajmljivanje oglasnih materijala; izdavanje oglasa; izdavanje reklamnih tekstova (oglasa); oglašavanje; reklamiranje; oglašavanje (reklamiranje) putem radija; služba za odnose sa javnošću; televizijske reklame; oglašavanje preko televizije; reklamne agencije; marketinška istraživanja; iznajmljivanje

oglasnog prostora; iznajmljivanje vremena za reklamiranje u svim sredstvima komunikacije; marketing; reklamni filmovi; prezentacija proizvoda putem sredstava komunikacije, u svrhu prodaje.

Klasa 36: Finansijsko upravljanje; analize finansijske; finansijske konsultacije; posredovanje u osiguranju; finansijske informacije; agencija za naplatu dugovanja; davanje garancija, jemstva.

Klasa 38: Elektronska pošta; komunikacije mobilnim telefonima/mobilne aplikacije; prenos poruka i slika pomoću kompjutera; pristup globalnim kompjuterskim mrežama; prenos čestitki putem interneta (on-line); prenos digitalnih datoteka.

Klasa 41: Organizacija sportskih takmičenja; organizovanje (priprema) i vođenje seminara; priprema (organizovanje) i vođenje radionica za obuku; zabave, planiranje.

Klasa 42: Tehničko ispitivanje.

---

(111) **15126**

(151) 19.02.2021.

(210) Ž-2019-95

(220) 12.03.2019.

(732) Sanrio Company, Ltd., 1-6-1, Osaki, Shinagawa-Ku., 141-8603, Tokyo , JP

(540)



(550) I

(740) Jelena Bogetić, Cetinjska 11, The Capital Plaza, 81000, Podgorica

(511) Klasa 3: Proizvodi za izbeljivanje i druge supstance za veš; proizvodi za čišćenje; preparati za poliranje; proizvodi za odstranjivanje i abrazivna sredstva; sapuni, nemedicinski; parfemi; eterična ulja; kozmetika, nemedicinska i toaletni preparat; balsami za kosu, nemedicinski; nemedicinski proizvodi za njegu zuba, nemedicinski; proizvodi za parfimisanje sobe; preparati za manikir; proizvodi i preparati za negu i čišćenje kose i kože; ljepila za kozmetičke potrebe; losioni za upotrebu poslije brijanja; toaletna sredstva protiv znojenja; proizvodi za neutralizovanje statičkog elektriciteta za domaćinstvo; arome [eterična ulja]; kora kvilaje za čišćenje [vrsta biljke]; soli za kupanje; kozmetički preparati za kupanje; maske za ljepotu; soli za izbjeljivanje; soda za bijeljenje rublja; plavila za veš;

aerosol za osvježivanje daha; trake za osvježavanje daha; hemijski proizvodi za oživljavanje boja za upotrebu u domaćinstvu; proizvodi za uklanjanje ličilačkih boja; kozmetički nesereri [torbe s kozmetičkim proizvodima]; kozmetički proizvodi za mršavljenje; kozmetički proizvodi za životinje; vatirani štapići za kozmetičku upotrebu; vata za kozmetičke potrebe; kreme za kozmetičke potrebe; kreme za čišćenje kože; kreme za kožne proizvode; proizvodi za uklanjanje masnih mrlja; preparati za poliranje zubnih proteza; sredstva za čišćenje zubnih proteza; dezodoransi za ljude; dezodoransi za životinje ili za kućne ljubimce; deterdženti; kozmetičke boje; kolonjska voda; toaletne vodice; boje za kosu; kreme za kosu; gel za kosu; šamponi; balzami za kosu; sredstva za vlaženje kose; mirisi [parfemi]; ruž [rumenilo] za usne; kreme i losioni za kožu i lice; vještački nokti; lakovi za nokte; razređivač laka za nokte; krema za sunčanje; izbjeljivači za kozmetičke potrebe; arome za kolače [eterična ulja]; toaletno mlijeko; kozmetički proizvodi za obrve; olovke za obrve; omekšivači; vještačke trepavice; podni vosak; lakovi za kosu; preparati za kovrdžanje kose; proizvodi za bijeljenje rublja; proizvodi za natapanje veša; skrobna apretura [štirak]; kozmetički losioni; šminka;; puder za šminkanje [milovka]; proizvodi za šminkanje; proizvodi za skidanje šminke; maskara; nemedicinski proizvodi za njegu usta; naljepnice za nokte; proizvodi za njegu noktiju; olovke za kozmetičke potrebe; vosak za podove [masti]; pomade za kozmetičke potrebe; potpuri [posudice s mirišljivim suhim laticama cvijeća]; kamen za glačanje [kamen vulkanskog porijekla]; platno za poliranje [peglanje]; brusni papir [šmirgla]; mirišljivo drvo; šamponi za kućne ljubimce; kreme za obuću; lak za obuću; vosak za obuću; sredstva za glačanje (širkanje); sapuni za osvježavanje; skrob za laštenje; kozmetički preparati za sunčanje; maramice namočene u kozmetičke losione; sredstva za skidanje lakova; vosak za uklanjanje dlačica; vosak za veš; vosak za poliranje; vosak za kožne proizvode; proizvodi za uklanjanje dlačica; naftni žele za kozmetičke potrebe; ukrasni detalji za kozmetičku upotrebu; štapići tamjana za kađenje; papir koji upija ulje za kožu; upijajući papir za lice; sredstva za kupanje, ne za medicinske potrebe, mirisni štapići za osvježavanje prostora.

Klasa 9: Naučni uređaji, navigacioni uređaji, uređaji za ispitivanja, istraživanja, fotografiju, kinematografiju, audiovizuelni, optički uređaji, uređaji za vaganje, merenje, signaliziranje, detektovanje, testiranje, pregledanje, spasilački i nastavni uređaji i instrumenti; uređaji i instrumenti za sprovođenje, prijenos, transformisanje, akumuliranje, regulisanje ili kontrolu distribucije ili korišćenja električne energije; uređaji i instrumenti za snimanje, prijenos, reprodukciju ili obradu zvuka, slika ili podataka; snimljena sredstva koja se mogu preuzimati, kompjuterski programi, blanko digitalna ili analogna sredstva za snimanje i skladištenje; mehanizmi za aparate koji se pokreću novcem; kase; uređaji za računanje, kompjuteri i periferni kompjuterski uređaji; ; skafanderi za ronjenje, ronilačke maske, tamponi za uši prilikom ronjenja, štipaljke za nos za ronioce i plivače, ronilačke rukavice, uređaji za disanje pri podvodnom plivanju; uređaji za gašenje požara; računske sprave s kuglicama [računaljke]; uređaji za audiovizuelno učenje; baterije; kućišta akumulatora; transformatori za povećanje napona; dvogled [optika]; aritmetičke mašine; fotografski aparati; kamere [kinematografski uređaji]; delovi i oprema za kamere; objektiv kamere; sprave za mjerenje zapremine; animirani crteži; čitači kasete; lančići za naočare; kinematografski filmovi, snimljeni; uređaji za bilježenje vremena [satovi]; čitači kompaktnih diskova; kompaktni audio-video diskovi; kompaktni optički diskovi; kompjuterski programi [radni]; kompjuterski programi [snimljeni]; kompjuteri; štampači za kompjutere; kontaktna sočiva; torbice za kontaktna sočiva; uređaji za obradu podataka; krojački metri; zvonca, električna za vrata; džepni elektronski prevoditelji; filmske trake [osvijetljene]; alarmi za požare; blicevi [fotografski]; okviri za dijapozitive u fotografiji; uređaji za kontrolu topline;



muzički automati koji se pokreću uz prethodno plaćanje (džuboks); optička sočiva; vage za pisma; pojasevi za spašavanje; pojasevi za spašavanje; prsluci za spašavanje; skele za spašavanje; brave, električne; elektronske brave i ključevi; magnetne kartice [kodirane]; magnetni uređaji za kodiranje; magneti; lupe [optika]; mjerni pribor; električni aparati za mjerenje; mjerni instrumenti; mikrofoni; mikroskopi; svijetleće cijevi za reklamne poruke; kompjuteri, džepni; elektronske olovke za jedinice za vizuelno prikazivanje; gramofonske ploče; fotokopirni uređaji; računске, džepne mašine [digitroni]; projektori; ekrani za projektovanje; T.S.F. uređaji [radiouređaji]; gramofoni; aparati za daljinsko upravljanje; lenjiri [mjerni instrumenti]; vage; kartice za mikroprocesore; detektori dima; električne utičnice; navlake za naočare; okviri za naočare; naočare [optika]; sunčane naočare; električni prekidači; magnetofoni s magnetnim trakama; telefonski uređaji; telefonski predajnici; telefonske žice; dvogled [teleskopi]; televizori; indikatori temperature; električni uređaji protiv krađe; toplomjeri, nemedicinski; termostati; videokasete; kasete za videoigre; video snimci; videotrake; videoekrani; magnetoskopi; programi za obradu teksta; kompaktni audio-video diskovi [diskovi]; DVD-jevi; čitač video kompaktnih diskova i DVD-jeva; audio-vizualni aparati sa karaoke uređajima; držači, nosači i futrole za audio i video kasete, kompaktno diskove, laserske diskove, video diskove i DVD-jeve; podloge za kompjuterske miševе; telefoni; bežični telefoni, mobilni telefoni i delovi, oprema i dodaci za telefone; futrole i navlake za mobilne telefone; radiopejdžeri [dojavnici] i delovi i oprema za radiopejdžere; futrole i navlake za radiopejdžere; torbe, omotači, posude, nosači i držači za mobilne telefone i pejdžere; jastučići za uši za slušalice; slušalice za telefon i mikrofoni/telefonski zvučnici koji se koriste uz mobilne telefone; indikatori poziva za telefone; elektronički podsjetnici [agende]; električna zvonca; alarmni uređaji; čitači bar kodova; barometri; zujalice; električne zujalice; procesori [središnji uređaji za obradu podataka]; čipovi [integrirani krugovi]; hronografi [aparati za bilježenje trajanja]; tastature kompjutera; memorije za kompjutere; pomoćni uređaji kompjutera; akustični spojnice; prekidači s dva položaja [informatika]; optičke nosioci podataka; optički diskovi; magnetne table; aparat za ronioce; ronilačke maske; ronilačka odijela [kombinezoni]; elektronske oglasne table; elektronske olovke za jedinice za vizuelno prikazivanje; uzice za naočare; okulari; viziri [zaštitne naočare]; telefaksi; filteri za fotografske potrebe; flopi diskovi; trake za čišćenje glava za snimanje; higrometri, za mjerenje vlažnosti; integrisani krugovi; uređaji za međukomunikacije; interfejsi za kompjutere [informatika]; mašine za fakturisanje; poklopci za objektiv [kamere]; sklopovi s magnetnom trakom [informatika]; magnetne trake; kašike za doziranje; metronomi; mikroprocesori; modemi; uređaji za brojenje i razvrstavanje novca; monitori [kompjuterska oprema]; monitori [kompjuterski programi]; miš [informatika]; optička vlakna [vodiči za svijetlosne zrake]; optička stakla; optičarski proizvodi; parkometri [uređaji za mjerenje trajanja parkiranja]; uglomjeri [mjerni instrumenti]; radiotelegrafski uređaji; radiotelefonski uređaji; oprema za obradu podataka [skeneri] [informatika]; poluprovodnici; dijapozitivi; trake za snimanje zvuka; uređaji za demagnetizovanje magnetnih traka; telegrafске žice; telegrafi [uređaji]; teleprinteri; telekomunikacioni aktivatori za TV spikere; automatski uređaji za izdavanje karata; predajni telefonski uređaji; odašiljači [telekomunikacije]; vakum-metri; video telefoni; zviždeći alarmi; sportske zviždaljke; ronilački tamponi za uši; pješčani satovi; naočare za sport; disaljke za ronjenje; zaštitne kacige za sport; navigacioni uređaji za vozila [brodski kompjuteri]; kompjuterski programi i softver za igre, snimljen; kompjuterski programi, koje se mogu preuzimati; elektronske publikacije [za skidanje s udaljenijeg na bliži kompjuter ili s jačeg na slabiji kompjuter]; aplikacije za kompjuterske softvere koje se mogu preuzimati; emotikoni za mobilne telefone, koji se mogu preuzeti; vokmeni; sateliti za naučne potrebe;

oslonci za šaku za rad s informatičkom opremom; digitalni ramovi za fotografije; trake za mobilne telefone; stalak za mobilne telefone; stalci prilagođeni za laptopove; poklopci antene za mobilne telefone; futrole za pametne telefone; navlake za pametne telefone; elektronska kola i CD-ROM-ovi koji omogućavaju snimanje automatskog programa reprodukcije za upotrebu elektronskih muzičkih instrumenata; prijenosni multimedijalni čitači; slikovne datoteke koje se mogu preuzimati; grafike za mobilne telefone koje se mogu preuzimati; muzičke datoteke koje se mogu preuzimati; melodije za mobilne telefone koje se mogu preuzimati; čitači DVD-ja; uređaji za globalnu navigaciju [GPS]; USB uređaji [vanjski diskovi, priključci]; mehanizmi za pokretanje diska [informatika]; laptop kompjuteri; svijetleće diode [LED]; organske svijetleće diode [OLED] uređaji za ličnu zaštitu od nesretnih slučajeva; maske, zaštitne za radnike; kompasi [busole]; električne utičnice; zaštite za utičnice; distribucione konzole za elektrodistribuciju; dodaci za telefone za telefoniranje bez ruku, hands free; cijevi, vatrogasne; mlaznice za vatrogasna crijeva; programi za mašine za arkadne video igre; programi za mašine za kućne video igre; lični digitalni pomoćni uređaj; ronilački tamponi za uši; sunčane baterije; tablet kompjuteri; digitalne kamere; elektronski čitači knjiga; pametni telefoni; pametni satovi; pametne naočare; nosivi uređaji za praćenje aktivnosti; pametno prstenje; selfi štapovi [ručni monopodij]; elektronske interaktivne table; uređaji za električne i elektronske efekte za muzičke instrumente; audio interfejsi; zaštitne folije prilagođene za ekrane kompjutera; zaštitne folije prilagođene za pametne telefone; setovi za virtuelnu realnost; laboratorijski roboti; roboti za nastavu, roboti za nadzor bezbednosti, humanoidni roboti sa veštačkom inteligencijom; roboti za telekomunikaciju; torbe za laptopove; specijalne navlake i torbe za fotografske aparate i instrumente; nosivi kompjuteri, džojstici koji se koriste uz kompjuter a nisu za video igre, baterije i punjači za elektronske cigarete; senzorske rukavice.

Klasa 14: Plemeniti metali i njihove legure i poluge od plemenitih metala; kutije od plemenitih metala; dugmad za manžetne, od plemenitih metala; kopče za kravate, od plemenitih metala; igle za kravate, od plemenitih metala; umjetnički predmeti od plemenitih metala; ukrasne igle od plemenitih metala; ukrasi za obuću od plemenitih metala; statue od plemenitih metala; figurine (statuete) od plemenitih metala; nakit; drago i polu-drago kamenje; imitacije nakita i ukrasa; horološki i hronometrijski instrumenti; broševi [nakit]; lančići [nakit]; ukrasi za priveske i lančice za ključeve; privjesci [nakit]; metalni novac; žetoni, naime medalje i/ili novčići; dugmad za manžetne; naušnice; zlatne niti [nakit]; futrole za nakit; ogrlice [nakit]; igle pribadače [nakit]; igla za rever; prstenje [nakit]; kopče za kravate; satovi i zidni satovi, i delovi i oprema za njih; narukvice za satove; lančići za satove; kućišta ručnih satova; satovi, tačni sa zaustavljanjem [štoperice]; ukrasi (nakit); ukrasne igle; igle za kravate; privjesci za ključeve; ukrasni privjesci za ključeve, na uvlačenje; sitni ukrasi i ukrasni privjesci; lanci i futrole za ključeve/nosači plemenitih metala i/ili dragog kamenja; privjesci; narukvice [nakit]; kućišta zidnih satova; električni satovi i zidni satovi; sunčani satovi; dijamanti; vještački dijamanti; budilnici; šanil dugmad za manžetne; značke [amblemi] od plemenitih metala; pehari; komemorativni štitovi; amajlije za sreću; perle za izradu nakita; igle nakit za šešire.

Klasa 16: Papir; karton; štamparski proizvodi; pribor za uveze; fotografije [štampane]; papirni pribor, kancelarijski pribor [osim namještaja]; ljepljive materije za papirnate proizvode i za domaćinstvo; materijal za crtanje i za umjetnike; slikarske četkice; nastavni materijal i materijal za obučavanje; plastične ploče, folije i omotači za pakiranje; štamparska slova; naljepnice, štamparski blokovi; kalendari; knjige; katalozi; poštanski dopisi; plakati [poster]; časopisi [periodični]; publikacije; novine; časopisi [revije]; čestitke; sprave za pisanje; gumeni pečati; pečati; jastučići za pečate; jastučići za mastilo; foto

albumi; podloge za uramljivanje slika i fotografija; slikarski stalci; papir koji upija ulje za kožu; stalci za fotografije; tuš [boja]; papirne maramice; papir, higijenski; papirne maramice za skidanje šminke; ubrusi od papira; stolni kompleti od papira; papirni podmetači za boce; papir za pakovanje, uvijanje i materijali za pakovanje; vodene boje za umetnike; grafičke reprodukcije, portreti; litografije [kamenotisci]; pera [kancelarijski pribor]; olovke; nalivpera; kuglice za hemijske olovke; pera za pisanje; držala za pera; nastavci za olovke; punjenja za olovke i instrumente za pisanje; ulošci za olovke [mine]; olovke u boji; pastele [olovke]; kutije za olovke; pernice; mašine za oštrenje olovaka; oštrila za olovke; kvačice za papire; pritiskači za papir; papirne igle; ekseri s pljosnatom glavom [rajsnegle]; ljepila za papirne proizvode ili za domaćinstvo; papir, kaširani; košare i postolja za pisma; držači za pisma; otvarači pisama; ljepljive trake za papirne proizvode ili za domaćinstvo; table za crtanje; pera za izvlačenje crta; setovi za crtanje; albumi za marke i metalni novac; vreće za smeće; kese za zamrzivač; kese za poklone; papirne kese; poštanske kese, kese za sendviče; kese za sendviče (od papira); papirne kese za žurke; papirne kese za poklone; kese za led, konusne papirne vrećice; plastične kese za sendviče; vrećice za kuvanje u mikrotalasnim pećima; papirne kese za kupovinu; plastične kese za kupovinu; papirne kese za otpad; ojačane kese od kartonskog materijala; omotnice [papirni proizvodi]; upijajuća hartija [bugačice]; stalci za pridržavanje knjiga; obeleživači za knjige; markeri stranica u knjizi; kutije za papirne proizvode [kancelarijske potrepštine]; slikarska platna; blokovi [notesi]; dnevници; fascikle [kancelarijski pribor]; blokovi za pisanje [papirni proizvodi] podsetnici; papir za pisma; papir za crtanje; papirni pribor za pisanje; mape za pisanje; kreda; školske table; tabla za plakate; džepići za pasoše; korice za blokove s čekovima; gumene trakice za povezivanje spisa; slike; matrice za umnožavanje [šablone]; matrice [papirni proizvodi]; proizvodi za brisanje; kancelarijski noževi za brisanje [radiranje]; tečni proizvodi za brisanje; električni otvarači za pisma; štampane muzičke partiture; bele table (koje se mogu brisati); ukrasi i dekoracije od papira i/ili kartona; stolne salвете od papira; papirne kese za užinu; sanduci i torbe od kartona; bojanke; fascikle [papirni proizvodi]; papirno vezivo; džepne sveske; flomasteri; knjige za učenje čitanja (za decu); set grafitnih olovaka; set bojica; lenjiri za crtanje; podmetači za pisanje; autografske knjige; kvačice za papire; heftalice [kancelarijske mašine]; rezač trake [kancelarijski materijal]; znaci upozorenja; kancelarijski mašine za rezanje papira; CD narezivač za kućnu ili kancelarijsku upotrebu; mašine i aparati za oblaganje plastikom; električni aparat za ugradnju zaštitnog omotača za dokumente i fotografije putem toplotnog zaptivanja; držači i futrole za kartice; papirni ukrasi za kutije za ručak i namirnice; korice za neuvezane časopise; kutije, kartonske ili papirne; karte; stalci za pečate; novine sa stripovima; šestari za crtanje; papirne trake ili kartice za upis kompjuterskih programa; papir za kopiranje; korektori, tečni [kancelarijski pribor]; naprsci, gumeni [kancelarijski pribor]; zastavice od papira; fascikle za papir; noževi za savijanje ili rezanje papira [kancelarijski pribor]; trake, gumirane [papirni proizvodi]; džepne maramice, papirne; indeksne kartice; trake natopljene tintom; futrole za isprave; naljepnice [ne od tkanine]; geografske mape [geografske karte]; čestitke s muzikom; okružnice; kutije za slikarske boje [školski pribor]; brošure; kancelarijski mašine za rezanje papira; držači za mine za olovke; poštanske marke; samoljepljivi papirni proizvodi; ulaznice, vozne karte, birački listići i slični proizvodi; trake za pisače mašine; pisače mašine, električni ili neelektrični; papirni omoti [korice]; četkice za pisanje; kreda za pisanje; tableti za pisanje; ukrasne papirne vaze za cvijeće; portikle, papirne [djeci oko vrata protiv prljanja]; papirni filteri za kafu; knjižice [pasoši, radne knjižice itd.]; modeli za izradu veza; noževi za papir [kancelarijski pribor]; prekrivači stolova od papira; stolnjaci od papira; natpisi na papiru ili kartonu; metalni vrh za indeksne

karte; papirni kvadrati; samoljepljivi papirni proizvodi (stikeri) za prenosive telefone; umjetničke slike, uokvirene ili neuokvirene; spravice za plastificiranje isprava [kancelarijski pribor]; kartonske kutije za šešire; ručne sprave za stavljanje naljepnica; markeri [pisaći pribor]; posude za boje; brisači za table za pisanje; papir Xuan [za slikare i kinesku kaligrafiju]; mehaničke olovke; vasi [japanski papir]; matrice za ukrašavanje hrane i pića; značke sa imenom [kancelarijski materijal]; trake za barkod; sjaj za papirnate proizvode; papirne oznake za potvrde za podizanje prtljaga; papirne maramice za čišćenje

Klasa 18: Koža i imitacije kože; životinjska koža; kišobrani; torbe za prtljag i za nošenje; kišobrani, suncobrani i štapovi za hodanje; bičevi, konjska oprema, i sedlarska roba; ogrlice za životinje; kožni povodci; odjeća za životinje; torbe; torbe za novac [vrećice za novce]; novčanici; putne torbe; torbe za isprave (aktovke); futrole za ključeve; vreće [omotači, džepovi], od kože za ambalažu; kutije za isprave; rančevi; torbe-navlake za odijela; torbe za namirnice; remeni, kožni za nošenje preko ramena ili leđa; sedlarski kaiševi; ugrađeni pojasevi za prtljag; štapovi od trske; futrole za podsjetnice; vezice od kože ili imitacije kože; kutije za toaletni pribor; brnjice; torbe za školu; kožni kaiševi; ručke za kofere; koferi, ručni; torbe za putovanja; kovčežići za prtljag; navlake za kišobrane; ručke za kišobrane; stolice-štapovi [stolice koje se po potrebi mogu preinačiti u štapove za šetnju]; kaiševi za prtljag; torbe za plažu; kutije, kožne ili od kartonske kože i kutije od kože i od kože i kartona; ručne torbe; planinarski štapovi; torbe za muzičke partiture; mreže za namirnice; ruksaci; torbe za alat [prazne]; mali koferi; torbe za divljač; vreće [omotači, džepovi], od kože za ambalažu; presvlake za domaćinstvo, od kože ili imitacije kože; okviri ručnih torbi; torbe za nošenje male djece; torbe na točkićima; sportske torbe; odjeća za kućne ljubimce; marama [ešarpe] za nošenje male djece; prekrivači za životinje; zaprežna oprema za životinje i kožni povodci, uzice; navlake za torbe za novac; futrole za poslovne kartice; randele (Japanske školske torbe); uzde za vođenje dece, motorizovani koferi, oznake za prtljag; tkanina od imitacije kože.

Klasa 25: Odjevni predmeti; obuća; pokrivala za glavu; kecelje [odjevni predmeti]; odjeća za plažu; kupaći kostimi; sportska odjeća; kabanice; rukavice; rukavice bez prstiju; rukavice sa svim spojenim prstima, osim palca; pojasevi [odjevni predmeti]; odjevni predmeti za decu, muškarce i žene; odjevni predmeti za bebe; pelene-gaćice za odojčad [odjeća]; portikle, nepapirne [djeci oko vrata protiv prljanja]; donje rublje; pidžame; ogrtači za kupanje; naramenice; šeširi; ženske kape; kačket; kačketai kao pokrivala za glavu; francuske kape; kapice za kupanje i kapice za tuširanje; mufovi [odjevni predmeti]; neelektrične vrećice obložene krznom za grijanje nogu; pokrivači za uši [odjevni predmet]; odjeća za oko vrata; kravate; mašne [vrste kravate]; leptir mašna; kratke čarape [sokne] i čarape; hulahopke; podvezice od elastične tkanine; podvezice za čarape i podvezice [držači] za muške čarape; cipele i sportske cipele; papuče; obuća za plažu; odjeća za maskembale; štitnici za rukave; marama; ešarpe [šalovi]; sandale za kupanje; cipele za kupanje; skijaška obuća; čizme; grudnjaci; gaćice; ženske potkošulje; kaputi; manžetne [odjevni predmeti]; krznjeni šalovi; kratki kaputi [sakoi]; žersej [odjevni predmet]; jakna ili košulja od platna ili serža za mornare; trikoi [odjevni predmeti]; spoljna odjeća; ogrtači [odjevni predmeti]; pantalone; vindjakne [kratki sportski kaputi s kapuljačom]; puloveri bez rukava; sandale; marama; šalovi [fulari]; košulje; slipovi [donji veš]; bluze [radničke bluze]; dokoljenice [gamaše]; sportska obuća; trikoi [gimnastički dresovi, majice]; odela; tee-shirts [majice]; pantalone; odore [uniforme]; prsluci; kombinezoni za skijanje na vodi; potkošulje; gimnastičke papuče; gimnastička odjeća; lente [široki pojasevi]; odjeća za bicikliste; maske za spavanje; odjevni predmeti koji sadrže materije za mršavljenje; pleteni odjevni predmeti; štitnici peta za cipele.

Klasa 28: Igre, igračke i stvari za igru, uređaji za video igre, lutke [igračke]; igračke od pliša; plišani medvjedići; figure igračke; kompleti za igre; gimnastički i sportski artikli; kugle za igru; gumene lopte i baloni; praznične dekoracije i ukrasi; ukrasi i dekoracije za božićna drvca; oprema za ples; vozila [igračke]; električna vozila [igračke]; daske za talase [surfing]; daske za skijanje; roleri; klizaljke za led; skejtbord; zaštitni jastučići za sportsku odjeću; vazdušni pištolji [igračke]; torbe za štapove za golf, sa ili bez točkića; lopte za igru; zvončići za božićna drvca; bilijarske kuglice; bilijarski stolovi; građevinski elementi [igračke]; stolne igre; bomboni, praskavi božićni bomboni; klizaljke s čizmicama, za led; uređaji i mehanizmi za kuglanje; graditeljske igre; držači svjećica za božićna drvca; table za igranje dame; pribor za igru dame; šah [igra]; table za igranje šaha; božićna drvca-novogodišnje jelke od sintetičkog materijala; postolja za božićna drvca; pribor za mađioničare; pehari za nagrade u igrama; strelice; kockice za kockanje; kreveti za lutke; odjeća za lutke; kuće za lutke; sobe za lutke; pribor za igranje domina; tegovi za vežbanje; zaštita za laktove [sportski pribor]; gimnastičke protezaljke, za razvlačenje; jahaonica; flašice za lutke; udice; pribor za pecanje; peraje za plivače; plovci za pecanje; leteći tanjiri [igračke]; automatske igre; reketi; aparati za elektronske igre; mašine za video igre; prenosive video igrice sa zaslonima od tečnih kristala; elektronske mašine za video igre; torbe za štapove za golf; štapovi za golf; rukavice za golf; rukavice za igru i sport; varke [predmeti za prevaru za zabavu]; namotaji za papirne zmajeve; zmajevi, papirni; zaštita za koljena [sportski pribor]; ma-jong [kineska igra]; kuglice za igru [špekule]; pozorišne lutke [marionete]; maske, pozorišne; maske (igračke); mobilni [igračke sastavljene od više elemenata koji trepere uz najmanje strujanje vazduha]; mali modeli vozila; društvene igre; praskavi detonatori [igračke]; igračke za grickanje [kod nicanja zuba]; kolutovi za igru; konji-ljuljaške [igračke]; koturaljke; daske s jedrima, za vodu; skije; saonice za trke [bob sanke]; tobogani [igra]; igračke za pravljenje mjehurića od sapunice; zvrkovi [igračke]; odskočne daske [sportski artikli]; bicikli za treniranje na mjestu; bazeni [predmet za igru]; dušeci na naduvavanje; peraja za plivanje; daske za plivanje; peraja za plivanje za ruke; igračke na naduvavanje za bazene; ljuljaške; stolovi za stolni tenis; igračke za kućne ljubimce; skije za vodu; predmeti za igru za plivanje, igre, sportove i aktivnosti na vodi; lopte za plažu; automatske igre [mašine] uz prethodno plaćanje; navlake za skije i daske za surfovanje; bingo kartice; mrežice za leptire; karte za igru; konfeti; koturaljke s točkicama u nizu; pazle; kaleidoskopi; jarboli za daske s jedrom; vrećaste mreže za pecanje; vozila s daljinskim upravljanjem [igračke]; okretna ploča za rulet; staklene kugle sa snijegom; reketi za snijeg [krplje]; japanske karte za igru; prsluci za plivanje; pojasevi za plivanje; plutajući uređaji za kupanje i plivanje; plovci za plivanje i kupanje; šeširi od papira za zabave; sprave za jačanje mišića; žetoni za kockanje; kartice za struganje za lutriju; kompleti za izradu maketa; pačinko [mašine za igre]; aparati za kockanje [aparati za igre]; roboti igračke; dronovi (igračke); zaštitne folije prilagođene za ekrane prenosnih igara; komandne palice [džojstici za video igre]; sličice za igre; šatori za igru; konzole za video igre; ručne konzole za igranje video igara.

Klasa 29: Meso, riba, živina i divljač; mesni ekstrati; konzervirano, sušeno i kuvano voće i povrće; želei, džemovi, kompoti; jaja, mlijeko, sir, puter, jogurt i drugi mliječni proizvodi; jestiva ulja i masti; supe, čiste, mesne [bujoni]; koncentрати čistih mesnih supa [bujona]; puter; kavijar; sir; mliječni proizvodi; prehrambeni proizvodi pravljeni od ribe; hrana pripremljena od ribe; zašećereno voće; zamrznuto voće; kriške voća; margarin; pekmezi; mesni žele; mesne konzerve; mliječni napitci; konzervisane gljive; pripremljeni orasi; paštete od jetre; puter od kikirikija; obrađeni kikiriki; konzervisani grašak; kora od limuna ili naranče; prženi krompirići [čips]; uštipci od krompira; salate; kiseli kupus; kobasice

[salame]; sezamovo ulje; sastojci za pripremanje supe od povrća; supe od mesnih koncentrata; tofi, grudve zgnječene soje; salate od povrća; pripremanje za supe od zeleniša; mućena pavlaka; jogurt; instant supe; instant varivo; instant pire krompir; instant miso supa; gotova kari jela; gotovo kari varivo; zakuske; alge (za jelo); obrađeno i konzervisano meso, riba, živina i divljač; slanina; sastojci za pripremanje mesnih juha [bujoni]; puter od oraha i čokolade; suhomesnati proizvodi; hrskavci [kroketi]; riblje konzerve; voćni želei [žele]; voćne salate; voćne konzerve; ulje od kukuruza; jestivo maslinovo ulje; grožđice [suvo grožđe]; pire od paradajza; konzerve od povrća; riba i plodovi mora (neživi); riba i plodovi mora, obrađeni i konzervisani; konzerve, riblje i morski plodovi; prehrambeni proizvodi od/napravljeni od bjelančevine morskih plodova za kulinarske potrebe; alginati za kulinarstvo; konzervirani pasulj; mliječni frapei; mliječni napitci u kojima mlijeko prevladava; kimši [fermentisana hrana od povrća]; tahini [tijesto od sezamovog sjemena]; tostirani varek, prženi za jelo [morska trava]; surutka od mlijeka; aloe vera pripremljena za ljudsku ishranu; obrađena riblja ikra; ptičja gnijezda [jestiva]; napici s bakterijom za proizvodnju mliječne kiseline; bademovo mleko [napici]; napici od kikiriki mleka; konac za pravljenje kobasica; yakitori; yuba [tofu listići]; tajine [pripremljeni obrok od mesa, ribe ili povrća];

Klasa 30: Kafa, čaj, kakao i zamjene za kafu; riža; prehrambena tjestenina i rezanci; brašno tapioke za prehranu i sago [skrob iz sjemena palme sago]; brašno i preparati od žitarica; hljeb, slastičarski proizvodi i slatkiši, čokolada; sladoled, šerbet [voćni sladoled] i drugi jestivi smrznuti proizvodi; šećer, med, gusti tamni sirup; pjenica [kvasac]\*, prašak za dizanje; so; začini, mirođije, zelen (konzervisano zelenje) [začini]; sirće; umaci, začinski [i drugi dresinzi]; led, sirovi (smrznuta voda); biskviti [suvi kolačići]; prašak za kolače; jestivi ukrasi za kolače; arome za kolače [osim eteričnih ulja]; kolačići od riže; bomboni; čokolada; mlijeko, čokoladno [napitak]; pića od čokolade; namazi na bazi čokolade; šećerni proizvodi za ukrašavanje božićnih drvca; kakao s mlijekom; proizvodi od kakaoa; pića od kakaoa; arome za kafu; cikorija [zamjena za kafu] i biljni preparati kao zamjena kafe; pića od kafe; kukuruzne kokice [pucanci]; pahuljice, kukuruzne; pavlaka, smrznuta [šlag]; kari [začin]; engleska krema; pahuljice; arome [osim eteričnih ulja]; jogurt, smrznuti [vrsta sladoleda]; voćno tijesto [poslastica]; medenjaci; sirup; čajevi, nemedicinski; kečap [sos]; crni šećer, slatki korjen [poslastica]; mesne pite; proizvodi za omekšavanje mesa u domaćinstvu; palačinke; pastile [bomboni]; biber; pizza; varenci [pudinzi]; ravioli [tjestenina]; matična mlijječ; šećer; wasabi pasta; pikantni umak od soje; tjestenina za prehranu, rezanci i rezanci za supe; udon [nudle na japanski način]; sushi [japansko jelo od riže]; vanila [aroma]; vafel proizvodi; perece; zakuske [mali obroci] od pšenice; mešavine zakuski koje se sastoje od krepera, pereca i kokica; slatkiši od badema; aromatični preparati za prehrambene potrebe; vezivni agensi za sladoled; fino sitno pecivo; pecivo [brioši]; kolači; karamele [bomboni]; žvalaća guma; kukuruzno brašno; krekeri; ledeni sladoledi sirup od melase, šećerni sirup; makaroni [vrsta tjestenine]; marcipan [kolač od badema]; majonez; zobeno brašno; paprika [začin]; voćni kolači; reliš [dodatak jelu]; dvopek [prepečenac]; so, kuhinjska; sendviči; umak od paradajza; začini; šerbet [voćni sladoled]; špageti; torte; brašno od žita; umaci za salatu; mesni sosovi [umaci]; sos za tjesteninu; pripremljeni obroci od rezanaca; zakuske [mali obroci] od žitarica; zakuske [mali brzi obroci] od riže; pahuljice, zobene; glukoza za kulinarstvo; visokoproteinske pločice od žitarica; brašno\*; dezertni musevi [poslastičarski proizvodi]; namirnice od zobi; tijesto od sojinog zrna [začin]; čaj (napitci od čaja); baštenska zelen (konzervisano zelenje) [začini]; gluteinski dodaci za kulinarske svrhe; coulis [voćni prelivi]; prerađeno seme za upotrebu kao začin; ramen (japansko jelo na bazi rezanaca); zakuske

od sira; senbei [krekeri od riže], pepermint za osvežavanje daha.

Klasa 35: Veleprodaja i maloprodaja i usluge naručivanja poštom vezane za prodaju artikala za zabave i prazničnih dekoracija i ukrasa, sapuna, parfimerijskih proizvoda, eteričnih ulja, kozmetičkih proizvoda, losiona za kosu, proizvoda za njegu kose, toaletnih proizvoda, proizvoda za njegu zuba. proizvoda za ličnu higijenu; Veleprodaja, maloprodaja i usluge naručivanja poštom vezane za prodaju proizvoda za čišćenje, poliranje, glačanje, materije za pranje, alata za manikir, proizvoda za njegu noktiju, laka za nokte, vještačkih noktiju; Veleprodaja i maloprodaja i usluge naručivanja poštom vezane za prodaju dijetetskih materija, hrane za bebe, sanitarnih proizvoda, sveća, gaze, traka za paljenje, masti, lubrikanata, ulja za slikanje; Veleprodaja i maloprodaja i usluge naručivanja poštom vezane za prodaju pribora za jelo, posuđa, torbi s priborom za manikiranje; instrumenata za brijanje; britvi, mašina i alata za mašine za domaćinstvo, ručnih alata; Veleprodaja i maloprodaja i usluge naručivanja poštom vezane za prodaju filmova, kamera, foto diskova, magnetoskopa, audio i vizuelnih proizvoda, audio i video traka, ploča i diskova, instrumenata i uređaja za snimanje, prijenos i/ili reprodukciju zvuka i/ili slika, televizora, čitača kasete i/ili magnetofona sa magnetnim trakama, video kasete i/ili čitača diskova i/ili magnetofona, radija; Veleprodaja i maloprodaja i usluge naručivanja poštom vezane za prodaju telefona, bežičnih telefona, mobilnih telefona, futrola za mobilne telefone, dekoracije i remena za telefone, indikatora za pozive, aritmetičkih mašina, digitrona; Veleprodaja i maloprodaja i usluge naručivanja poštom vezane za prodaju elektronskih i kompjuterskih igara, kinematografskih filmova, svijetiljki, ventilatora, sprava za kuvanje, kalupa za kolače i tijesto, toster, rerni, kuhinjskog pribora, pribora i posuda za posluživanje ili skladištenje hrane i/ili napitaka; Veleprodaja i maloprodaja i usluge naručivanja poštom vezane za prodaju kineskih štapića za hranu, instrumenata za sečenje, porculana, predmeta od kristala, emajliranog posuđa, predmeta od srebra, staklarije, predmeta od pečene gline, poluporculana [majolika], keramike; Veleprodaja i maloprodaja i usluge naručivanja poštom vezane za prodaju sušila za kosu, rasvjetnih svijetiljki, sjenila i delova i opreme za sjenila; Veleprodaja i maloprodaja i usluge naručivanja poštom vezane za prodaju dječijih kolica, balona, truba za bicikle, zidnih satova i džepnih ili ručnih satova i dodataka i delova i opreme za njih; Veleprodaja i maloprodaja i usluge naručivanja poštom vezane za prodaju draguljarskih proizvoda i imitacije draguljarskih proizvoda, ukrasa [bižuterija], poluga [lingoti] od plemenitih metala, kutija od plemenitih metala; Veleprodaja i maloprodaja i usluge naručivanja poštom vezane za prodaju dugmića za narukvice od plemenitih metala, kvačica za kravatu od plemenitih metala, igli za kravatu od plemenitih metala; Veleprodaja i maloprodaja i usluge naručivanja poštom vezane za prodaju umjetničkih predmeta od plemenitih metala, ukrasnih igli od plemenitih metala, ukrasa za obuću od plemenitih metala, kipova od plemenitih metala, figurica od plemenitih metala; Veleprodaja i maloprodaja i usluge naručivanja poštom vezane za prodaju glazbenih kutija, glazbenih instrumenata, slika, fotografija, papirnatih proizvoda; Veleprodaja i maloprodaja i usluge naručivanja poštom vezane za prodaju papirnatih vreća za smeće, papirnatih ubrusa za skidanje šminke, ukrasnih papirne vaze za cvijeće, papirnatih traka, papirnatih filtara za kafu; Veleprodaja i maloprodaja i usluge naručivanja poštom vezane za prodaju toaletni peškiri od papira, pelene od papira, portikle, papirne [djeci oko vrata protiv prljanja], oznake za stranice u knjigama od papira; Veleprodaja i maloprodaja i usluge naručivanja poštom vezane za prodaju higijenskog papira, stolnih peškira od papira, papirnatih džepnih maramica, kutija od kartona ili papira, uskih stolnjaka od papira, stolnog rublja od papira; Veleprodaja i maloprodaja i usluge naručivanja poštom vezane za prodaju umjetničkih boja i materijala,

kistova za slikanje, instrumenata za pisanje; Veleprodaja i maloprodaja i usluge naručivanja poštom vezane za prodaju štampanih stvari, knjiga, novina, magazina i periodika, čestitki i božićnih čestitki; Veleprodaja i maloprodaja i usluge naručivanja poštom vezane za prodaju igračkih karata, materijala za ambalažu; Veleprodaja i maloprodaja i usluge naručivanja poštom vezane za prodaju okvira za slike, stalaka za slike, ljepila za papir ili domaćinstvo; Veleprodaja i maloprodaja i usluge naručivanja poštom vezane za prodaju ukrasa od kože ili imitacije kože za nameštaj, kutije od kože ili imitacije kože, futrola za ključeve od kože ili imitacije kože; Veleprodaja i maloprodaja i usluge naručivanja poštom vezane za prodaju obloga od kože ili imitacije kože, ormi, amova, uzdi za životinje od kože ili imitacije kože, trake od kože ili imitacije kože, remenje od kože ili imitacije kože i presvlake za nameštaj od kože ili imitacije kože; Veleprodaja i maloprodaja i usluge naručivanja poštom vezane za prodaju torbi i kofera, vrećica za novac i novčanika, kišobrana, štapova za hodanje; Veleprodaja i maloprodaja i usluge naručivanja poštom vezane za prodaju nameštaja, ogledala, vješalica za odjeću i klinova, kutija i posuda, ploča sa nazivima, malog pribora za domaćinstvo, pribora i posuda za domaćinstvo ili kuhinju, češljeva, sunđera, četki, pribora za čišćenje; Veleprodaja i maloprodaja i usluge naručivanja poštom vezane za prodaju naočara [optika], okvira za naočare i sunčane naočare i navlaka i dodataka za naočare, tekstila i tekstilnih proizvoda, posteljine, stolnog rublja i stolnjaka, salveta, papirnatih kolutova za stolove, nameštaja, ukrasa koji se apliciraju toplim postupkom za tekstilne proizvode [krojački pribor], džepnih maramica; Veleprodaja i maloprodaja i usluge naručivanja poštom vezane za prodaju odjevnih predmeta, obuće, pokrivala za glavu, dugmića, ukrasnih znački, traka i pletenica, čipke i tkanina s ucrtanim motivima za vezenje, igala za kosu i ukrasa, naramenica, ukrasa za obuću, ukrasa za šešire, rajsfešlusa [klizni zatvarači], tepiha i dušeka; Veleprodaja i maloprodaja i usluge naručivanja poštom vezane za prodaju igračaka i igara, lutaka, figurina, sportskih predmeta, dekoracije za božićna drvca; Veleprodaja i maloprodaja i usluge naručivanja poštom vezane za prodaju hrane i napitaka, slatkiša, proizvoda od cveća, šibica, cigara, cigareta i predmeti za pušače; reklamiranje; organizovanje izložbi i sajmovu u komercijalne ili reklamne svrhe; objavljivanje reklamnih tekstova; prodaja (podsticaj prodaje) za treće osobe; kancelarije za reklamiranje; profesionalno upravljanje umjetničkim poslovima; agencije za uvoz-izvoz; prikupljanje podataka za kompjuterske baze podataka; direktno reklamiranje poštom; administrativno upravljanje hotelima; istraživanje tržišta; reklamiranje na otvorenim površinama; zapošljavanje osoblja; reklamiranje putem radija; reklamiranje putem televizije; reklamiranje on-line na informatičkoj mreži; usluge nabave za treće [kupovina proizvoda i usluga za druga preduzeća]; iznajmljivanje vremena za reklamiranje na svim komunikacionim sredstvima; iznajmljivanje kancelarijskih mašina i aparata; iznajmljivanje automata za prodaju sitne robe; reklamiranje dopisnim putem; komercijalna administracija u vezi licenci proizvoda i usluga trećih lica; pružanje komercijalnih savjeta i informacija potrošačima; marketing; prezentacija proizvoda na svim komunikacionim sredstvima u svrhu prodaje na malo; proizvodnja reklamnih filmova; odnosi s javnošću [propaganda]; iznajmljivanje reklamnog materijala; iznajmljivanje reklamnih prostora; iznajmljivanje fotokopirnih uređaja; uređenje izloga; promovisanje dobara i usluga trećih lica putem izdavanja trgovinskih markica; usluge telemarketinga; administracija programa za česte putnike; usluge finansijskog revizora; usluge odnosa sa medijima; usluge korporativne komunikacije; iznajmljivanje kancelarijske opreme u zajedničkom radnom prostoru.

Klasa 41: Razonoda; zabava; cirkusi [zabavni parkovi]; usluge hala i dvorana za igre; obuka [predavanje]; organizovanje, proizvodnja i prikazivanje spektakala, koncerata,



javnih nastupa, pozorišnih nastupa, izložbi, sportskih takmičenja, sportskih i kulturnih aktivnosti; muzičke sale; pozorišne predstave; prikazivanje igranih filmova; kabarei; kino studiji; usluge diskoteka; usluge klubova; izdavanje knjiga, tekstova, magazina, novina i časopisa; posuđivanje knjiga; usluge za ispunjavanje slobodnog vremena, izložbe, koncerti, spektakli, nastupi, sportovi, igre, rekreativne i kulturne aktivnosti; usluge zdravstvenih klubova [održavanje zdravlja i fizičke forme]; usluge kampova za ljetovanje [zabava]; informacije u vezi rekreacije; informacije o obrazovanju; informacije o rasonodi, zabavi, sportu i kulturi; rasonoda posredstvom televizije; rasonoda putem radiofonije; montaža radio i televizijskih programa; proizvodnja filmova i video-a; iznajmljivanje kinematografskih filmova, videotraka, laserskih diskova, video diskova i DVD diskova; iznajmljivanje zvučnih snimaka; iznajmljivanje pozorišnog dekora; obuka za predškolski uzrast; klubovi i saloni sa instaliranim audio i video aparatima sa karaoke uređajima; sobe i sale za igre; organizovanje konkursa ljepote; cirkusi; obuka putem dopisivanja; obuka; igranje igara; gimnastičarska obuka; muzejske usluge [predstavljanje, izložbe]; organizovanje lutrije; usluge orkestra; planiranje prijema [rasonoda]; izrada scenarijuma; pozorišne predstave; usluge zooloških vrtova; mikroizdavaštvo; usluge igara pružene on-line [s jedne informatičke mreže]; tumačenje govora pokreta; profesionalna orijentacija [savjeti u vezi obrazovanja ili osposobljavanja]; snimanje na mikrofilmove; komponovanje muzike; fotografisanje; proizvodnja filmova na video kasetama; stavljanje na raspolaganje opreme za karaoke; iskorištavanje elektronskih publikacija koje se ne mogu prenositi on-line; objavljivanje knjiga i časopisa, elektronski on line; snimanje na videotrake; kuglane; omogućavanje korišćenja fitnes prostorija u oblasti bejzbola; omogućavanje korišćenja zatvorenih terena za bejzbol; rasonoda u oblasti bejzbola (igre); prikazivanje filmova on-line; usluge rasonode, naime omogućavanje korišćenja interaktivnih elektronskih igara putem kompjuterskih mreži; omogućavanje privremenog korišćenja interaktivnih igara koje se ne mogu preuzeti; iznajmljivanje opreme za igranje; iznajmljivanje audio uređaja; iznajmljivanje videokamera; iznajmljivanje rasvjetnih uređaja za pozorišnu dekoraciju i za televizijske studije; iznajmljivanje filmskih projektoru i dodataka; iznajmljivanje radio i televizijskih aparata; iznajmljivanje dekora za priredbe; iznajmljivanje sportske opreme [osim vozila]; iznajmljivanje sportskih terena; iznajmljivanje stadiona; iznajmljivanje magnetoskopa; iznajmljivanje videotraka; iznajmljivanje igrački; kroćenje životinja [dresiranje]; praktična obuka [demonstriranje]; prevodilačke usluge; organizovanje i vođenje radionica za stručno osposobljavanje; usluge rasonode, naime omogućavanje korišćenja audio-vizuelnih materijala, slika, televizijskih programa i kinematografskih filmova preko on-line kompjuterske mreže; omogućavanje korišćenja slika, zvuka i vida preko on-line mreža; omogućavanje korišćenja informacija o fiktivnim likovima; omogućavanje korišćenja on-line muzike i videa koji se ne mogu preuzeti; usluge stavljanja na raspolaganje filmova koji se ne mogu preuzeti, putem prenosa video zapisa na zahtev; usluge stavljanja na raspolaganje televizijskih programa koji se ne mogu preuzeti, putem prenosa video zapisa na zahtev; distribuiranje filmova; obrazovne usluge pružene od strane asistenata za posebne potrebe; obrazovno testiranje za korisnike da bi se kvalifikovali za pilote drona; usluge inženjeringa zvuka na događanjima; usluge tehničara osvjetljenja na događanjima; režiranje filmova, osim reklamnih filmova.

Klasa 42: Naučne i tehnološke usluge i naučna istraživanja, kao i sa tim povezano projektovanje; analiza delatnosti i usluge industrijskog istraživanja; izrada i razvoj kompjuterskog hardvera i softvera; savjetodavne usluge o nadzoru i arhitekturi; savjeti o gradnji; kompjutersko programiranje; održavanje kompjuterskih programa; izrada građevinskih planova; savjetodavne usluge u vezi zaštite okoline; industrijski dizajn;

unutrašnje uređenje [dekoracija]; usluge dizajniranja ambalaže; usluge modnih dizajnera; usluge dizajniranja grafičke umjetnosti; vremenska prognoza; urbanističko planiranje; dupliciranje informatičkih programa; izrada kompjuterskih programa; instaliranje kompjuterskih programa; savjetovanje o kompjuterima; konverzija podataka ili dokumenata s jednog fizičkog na elektronski disk; kreiranje i održavanja web stranica za druge; konverzija informatičkih podataka i programa [nije fizička konverzija]; ugošćavanje informatičkih stranica; cloud computing; iznajmljivanje kompjutera; konsultacije u vezi kompjuterskih programa [softvera]; analiza kompjuterskih sastava; osmišljavanje informatičkih sistema; savjetodavne usluge iz oblasti kompjuterske tehnologije; digitalizacija dokumenata [skeniranje]; savjetovanje o informacionim tehnologijama; čuvanje rezervne kopije podataka van mreže; pružanje poslovnih informacija putem Internet stranice; softver u vidu servisa [SaaS]; savjetovanje o izradi veb sajtova; dizajn enterijera; kompjuterske i tehnološke usluga radi obezbeđivanja kompjuterskih i finansijskih podataka i podataka o ličnosti i za detekciju neovlašćenog pristupa podacima; razvoj kompjuterskih platformi; dizajniranje vizit karti; grafički dizajniranje promotivnih materijala.

Klasa 43: Usluge snabdevanja hranom i pićem; privremeni smeštaj; restorani; kafane-restorani; kafane [kafeterije]; usluge barova; menze; kantine; usluge keteringa; restorani sa samoposluživanjem; restorani za brzo i stalno posluživanje [snek-barovi]; koktel saloni; dekoracija hrane; dekoracija torti; informacije i savjeti u vezi sa pripremanjem obroka; usluge ličnog kuvara; usluge prijema za privremeni smeštaj [upravljanje dolascima i odlascima]; pružanje usluge i rezervisanje smeštaja, hotela, motela, pansiona i pružanje informacija o tome; usluge povezane sa rezervisanjem soba u hotel od strane turističke agencije ili brokera; usluge kampova za ljetovanje; omogućavanje korišćenja prostorija za izložbe; restorani, kafane, kafeterije, barovi, menze, kantine i saloni sa instaliranom audio-vizuelnom opremom sa karaoke uređajima; usluge brige o deci; jaslice [dječije ustanove]; ljetovališta; organizovanje hrane i pića za svadbene prijeme; organizovanje svadbenih prijema [lokacija]; iznajmljivanje električnih tostera, mikrotalasnih, rešoa, aparata i sprava za pripremanje hrane i pića; pansioni za životinje; iskorištavanje terena za kampiranje; iznajmljivanje stolaca, stolova, escajga i staklenog posuđa; iznajmljivanje aparata za kuvanje; iznajmljivanje uređaja za pijeću vodu; iznajmljivanje sala, dvorana za sastanke; iznajmljivanje šatora; iznajmljivanje prenosivih građevinskih objekata.

---

(111) **15127**

(151) 19.02.2021.

(210) Ž-2019-96

(220) 12.03.2019.

(732) Sanrio Company, Ltd., 1-6-1, Osaki, Shinagawa-Ku., 141-8603, Tokyo , JP

(540)



(550) I

(740) Jelena Brajković, Cetinjska 11, The Capital Plaza, 81000, Podgorica

(511) Klasa 3: Proizvodi za izbeljivanje i druge supstance za veš; proizvodi za čišćenje; preparati za poliranje; proizvodi za odstranjivanje i abrazivna sredstva; sapuni, nemedicinski; parfemi; eterična ulja; kozmetika, nemedicinska i toaletni preparat; balsami za kosu, nemedicinski; nemedicinski proizvodi za njegu zuba, nemedicinski; proizvodi za parfimisanje sobe; preparati za manikir; proizvodi i preparati za negu i čišćenje kose i kože; ljepila za kozmetičke potrebe; losioni za upotrebu poslije brijanja; toaletna sredstva protiv znojenja; proizvodi za neutralizovanje statičkog elektriciteta za domaćinstvo; arome [eterična ulja]; kora kvilaje za čišćenje [vrsta biljke]; soli za kupanje; kozmetički preparati za kupanje; maske za ljepotu; soli za izbeljivanje; soda za bijeljenje rublja; plavila za veš; aerosol za osvježivanje daha; trake za osvježavanje daha; hemijski proizvodi za oživljavanje boja za upotrebu u domaćinstvu; proizvodi za uklanjanje ličilačkih boja; kozmetički nesereri [torbe s kozmetičkim proizvodima]; kozmetički proizvodi za mršavljenje; kozmetički proizvodi za životinje; vatirani štapići za kozmetičku upotrebu; vata za kozmetičke potrebe; kreme za kozmetičke potrebe; kreme za čišćenje kože; kreme za kožne proizvode; proizvodi za uklanjanje masnih mrlja; preparati za poliranje zubnih proteza; sredstva za čišćenje zubnih proteza; dezodoransi za ljude; dezodoransi za životinje ili za kućne ljubimce; deterdženti; kozmetičke boje; kolonjska voda; toaletne vodice; boje za kosu; kreme za kosu; gel za kosu; šamponi; balzami za kosu; sredstva za vlaženje kose; mirisi [parfemi]; ruž [rumenilo] za usne; kreme i losioni za kožu i lice; vještački nokti; lakovi za nokte; razređivač laka za nokte; krema za sunčanje; izbeljivači za kozmetičke potrebe; arome za kolače [eterična ulja]; toaletno mlijeko; kozmetički proizvodi za obrve; olovke za obrve; omekšivači; vještačke trepavice; podni vosak; lakovi za kosu; preparati za kovrdžanje kose; proizvodi za bijeljenje rublja; proizvodi za natapanje veša; skrobna apretura [štirak]; kozmetički losioni; šminka;; puder za šminkanje [milovka]; proizvodi za šminkanje; proizvodi za skidanje šminke; maskara; nemedicinski proizvodi za njegu usta; naljepnice za nokte; proizvodi za njegu noktiju; olovke za kozmetičke potrebe; vosak za podove [masti]; pomade za kozmetičke potrebe; potpuri [posudice s mirišljivim suhim laticama cvijeća]; kamen za glačanje [kamen vulkanskog porijekla]; platno za poliranje [peglanje]; brusni papir [šmirgla]; mirišljivo drvo; šamponi za kućne ljubimce; kreme za obuću; lak za obuću; vosak za obuću; sredstva za glačanje (štirkanje); sapuni za osvježavanje; skrob za laštenje; kozmetički preparati za sunčanje; maramice namočene u kozmetičke losione; sredstva za skidanje lakova; vosak za uklanjanje dlačica; vosak za veš; vosak za poliranje; vosak za kožne proizvode; proizvodi za uklanjanje dlačica; naftni žele za kozmetičke potrebe; ukrasni detalji za kozmetičku upotrebu; štapići tamjana za kađenje; papir koji upija ulje za kožu; upijajući papir za lice; sredstva za kupanje, ne za medicinske potrebe, mirisni štapići za osvježavanje prostora.

Klasa 9: Naučni uređaji, navigacioni uređaji, uređaji za ispitivanja, istraživanja, fotografiju, kinematografiju, audiovizuelni, optički uređaji, uređaji za vaganje, merenje, signaliziranje, detektovanje, testiranje, pregledanje, spasilački i nastavni uređaji i instrumenti; uređaji i instrumenti za sprovođenje, prijenos, transformisanje, akumuliranje, regulisanje ili kontrolu distribucije ili korišćenja električne energije; uređaji i instrumenti za snimanje, prijenos, reprodukciju ili obradu zvuka, slika ili podataka; snimljena sredstva koja se mogu preuzimati, kompjuterski programi, blanko digitalna ili analogna sredstva za snimanje i skladištenje; mehanizmi za aparate koji se pokreću novcem; kase; uređaji za računanje,

kompjuteri i periferni kompjuterski uređaji; ; skafanderi za ronjenje, ronilačke maske, tamponi za uši prilikom ronjenja, štikaljke za nos za ronioce i plivače, ronilačke rukavice, uređaji za disanje pri podvodnom plivanju; uređaji za gašenje požara; računске sprave s kuglicama [računaljke]; uređaji za audiovizuelno učenje; baterije; kućišta akumulatora; transformatori za povećanje napona; dvogled [optika]; aritmetičke mašine; fotografski aparati; kamere [kinematografski uređaji]; delovi i oprema za kamere; objektiv kamere; sprave za mjerenje zapremine; animirani crteži; čitači kasete; lančići za naočare; kinematografski filmovi, snimljeni; uređaji za bilježenje vremena [satovi]; čitači kompaktnih diskova; kompaktni audio-video diskovi; kompaktni optički diskovi; kompjuterski programi [radni]; kompjuterski programi [snimljeni]; kompjuteri; štampači za kompjutere; kontaktna sočiva; torbice za kontaktna sočiva; uređaji za obradu podataka; krojački metri; zvonca, električna za vrata; džepni elektronski prevoditelji; filmske trake [osvijetljene]; alarmi za požare; blicevi [fotografski]; okviri za dijapozitive u fotografiji; uređaji za kontrolu topline; muzički automati koji se pokreću uz prethodno plaćanje (džuboks); optička sočiva; vage za pisma; pojasevi za spašavanje; pojasevi za spašavanje; prsluci za spašavanje; skele za spašavanje; brave, električne; elektronske brave i ključevi; magnetne kartice [kodirane]; magnetni uređaji za kodiranje; magneti; lupe [optika]; mjerni pribor; električni aparati za mjerenje; mjerni instrumenti; mikrofoni; mikroskopi; svijetleće cijevi za reklamne poruke; kompjuteri, džepni; elektronske olovke za jedinice za vizuelno prikazivanje; gramofonske ploče; fotokopirni uređaji; računске, džepne mašine [digitroni]; projektori; ekrani za projektovanje; T.S.F. uređaji [radiouređaji]; gramofoni; aparati za daljinsko upravljanje; lenjiri [mjerni instrumenti]; vage; kartice za mikroprocesore; detektori dima; električne utičnice; navlake za naočare; okviri za naočare; naočare [optika]; sunčane naočare; električni prekidači; magnetofoni s magnetnim trakama; telefonski uređaji; telefonski predajnici; telefonske žice; dvogled [teleskopi]; televizori; indikatori temperature; električni uređaji protiv krađe; toplomjeri, nemedicinski; termostati; videokasete; kasete za videoigre; video snimci; videotrake; videoekrani; magnetoskopi; programi za obradu teksta; kompaktni audio-video diskovi [diskovi]; DVD-jevi; čitač video kompaktnih diskova i DVD-jeva; audio-vizualni aparati sa karaoke uređajima; držači, nosači i futrole za audio i video kasete, kompaktni diskove, laserske diskove, video diskove i DVD-jeve; podloge za kompjuterske miševе; telefoni; bežični telefoni, mobilni telefoni i delovi, oprema i dodaci za telefone; futrole i navlake za mobilne telefone; radiopejdžeri [dojavnici] i delovi i oprema za radiopejdžere; futrole i navlake za radiopejdžere; torbe, omotači, posude, nosači i držači za mobilne telefone i pejdžere; jastučići za uši za slušalice; slušalice za telefon i mikrofoni/telefonski zvučnici koji se koriste uz mobilne telefone; indikatori poziva za telefone; elektronički podsjetnici [agende]; električna zvonca; alarmni uređaji; čitači bar kodova; barometri; zujalice; električne zujalice; procesori [središnji uređaji za obradu podataka]; čipovi [integrirani krugovi]; hronografi [aparati za bilježenje trajanja]; tastature kompjutera; memorije za kompjutere; pomoćni uređaji kompjutera; akustični spojnice; prekidači s dva položaja [informatika]; optičke nosioci podataka; optički diskovi; magnetne table; aparat za ronioce; ronilačke maske; ronilačka odijela [kombinezoni]; elektronske oglasne table; elektronske olovke za jedinice za vizuelno prikazivanje; uzice za naočare; okulari; viziri [zaštitne naočare]; telefaksi; filteri za fotografske potrebe; flopi diskovi; trake za čišćenje glava za snimanje; higrometri, za mjerenje vlažnosti; integrisani krugovi; uređaji za međukomunikacije; interfejsi za kompjutere [informatika]; mašine za fakturisanje; poklopci za objektiv [kamere]; sklopovi s magnetnom trakom [informatika]; magnetne trake; kašike za doziranje; metronomi; mikroprocesori; modemi; uređaji za brojenje i razvrstavanje novca; monitori [kompjuterska oprema]; monitori [kompjuterski

programi]; miš [informatika]; optička vlakna [vodiči za svjetlosne zrake]; optička stakla; optičarski proizvodi; parkometri [uređaji za mjerenje trajanja parkiranja]; uglomjeri [mjerni instrumenti]; radiotelegrafski uređaji; radiotelefonski uređaji; oprema za obradu podataka [skeneri] [informatika]; poluprovodnici; dijapozitivi; trake za snimanje zvuka; uređaji za demagnetizovanje magnetnih traka; telegrafске žice; telegrafi [uređaji]; teleprinteri; telekomunikacioni aktivatori za TV spikere; automatski uređaji za izdavanje karata; predajni telefonski uređaji; odašiljači [telekomunikacije]; vakum-metri; video telefoni; zviždeći alarmi; sportske zviždaljke; ronilački tamponi za uši; pješćani satovi; naočare za sport; disaljke za ronjenje; zaštitne kacige za sport; navigacioni uređaji za vozila [brodski kompjuteri]; kompjuterski programi i softver za igre, snimljen; kompjuterski programi, koje se mogu preuzimati; elektronske publikacije [za skidanje s udaljenijeg na bliži kompjuter ili s jačeg na slabiji kompjuter]; aplikacije za kompjuterske softvere koje se mogu preuzimati; emotikoni za mobilne telefone, koji se mogu preuzeti; vokmeni; sateliti za naučne potrebe; oslonci za šaku za rad s informatičkom opremom; digitalni ramovi za fotografije; trake za mobilne telefone; stalak za mobilne telefone; stalci prilagođeni za laptopove; poklopci antene za mobilne telefone; futrole za pametne telefone; navlake za pametne telefone; elektronska kola i CD-ROM-ovi koji omogućavaju snimanje automatskog programa reprodukcije za upotrebu elektronskih muzičkih instrumenata; prijenosni multimedijalni čitači; slikovne datoteke koje se mogu preuzimati; grafike za mobilne telefone koje se mogu preuzimati; muzičke datoteke koje se mogu preuzimati; melodije za mobilne telefone koje se mogu preuzimati; čitači DVD-ja; uređaji za globalnu navigaciju [GPS]; USB uređaji [vanjski diskovi, priključci]; mehanizmi za pokretanje diska [informatika]; laptop kompjuteri; svijetleće diode [LED]; organske svijetleće diode [OLED] uređaji za ličnu zaštitu od nesretnih slučajeva; maske, zaštitne za radnike; kompasi [busole]; električne utičnice; zaštite za utičnice; distribucione konzole za elektrodistribuciju; dodaci za telefone za telefoniranje bez ruku, hands free; cijevi, vatrogasne; mlaznice za vatrogasna crijeva; programi za mašine za arkadne video igre; programi za mašine za kućne video igre; lični digitalni pomoćni uređaj; ronilački tamponi za uši; sunčane baterije; tablet kompjuteri; digitalne kamere; elektronski čitači knjiga; pametni telefoni; pametni satovi; pametne naočare; nosivi uređaji za praćenje aktivnosti; pametno prstenje; selfi štampovi [ručni monopodi]; elektronske interaktivne table; uređaji za električne i elektronske efekte za muzičke instrumente; audio interfejsi; zaštitne folije prilagođene za ekrane kompjutera; zaštitne folije prilagođene za pametne telefone; setovi za virtuelnu realnost; laboratorijski roboti; roboti za nastavu, roboti za nadzor bezbednosti, humanoidni roboti sa veštačkom inteligencijom; roboti za telekomunikaciju; torbe za laptopove; specijalne navlake i torbe za fotografske aparate i instrumente; nosivi kompjuteri, džojstici koji se koriste uz kompjuter a nisu za video igre, baterije i punjači za elektronske cigarete; senzorske rukavice.

Klasa 14: Plemeniti metali i njihove legure i poluge od plemenitih metala; kutije od plemenitih metala; dugmad za manžetne, od plemenitih metala; kopče za kravate, od plemenitih metala; igle za kravate, od plemenitih metala; umjetnički predmeti od plemenitih metala; ukrasne igle od plemenitih metala; ukrasi za obuču od plemenitih metala; statue od plemenitih metala; figurine (statuete) od plemenitih metala; nakit; drago i polu-drago kamenje; imitacije nakita i ukrasa; horološki i hronometrijski instrumenti; broševi [nakit]; lančići [nakit]; ukrasi za priveske i lančiće za ključeve; privjesci [nakit]; metalni novac; žetoni, naime medalje i/ili novčići; dugmad za manžetne; naušnice; zlatne niti [nakit]; futrole za nakit; ogrlice [nakit]; igle pribadače [nakit]; igla za rever; prstenje [nakit]; kopče za kravate; satovi i zidni satovi, i delovi i oprema za njih; narukvice za satove; lančići za satove; kućišta ručnih satova; satovi, tačni sa zaustavljanjem [štoperice]; ukrasi (nakit);

ukrasne igle; igle za kravate; privjesci za ključeve; ukrasni privjesci za ključeve, na uvlačenje; sitni ukrasi i ukrasni privjesci; lanci i futrole za ključeve/nosači plemenitih metala i/ili dragog kamenja; privjesci; narukvice [nakit]; kućišta zidnih satova; električni satovi i zidni satovi; sunčani satovi; dijamanti; vještački dijamanti; budilnici; šanil dugmad za manžetne; značke [emblemi] od plemenitih metala; pehari; komemorativni štitovi; amajlije za sreću; perle za izradu nakita; igle nakit za šešire.

Klasa 16: Papir; karton; štamparski proizvodi; pribor za uveze; fotografije [štampane]; papirni pribor, kancelarijski pribor [osim namještaja]; ljepljive materije za papirne proizvode i za domaćinstvo; materijal za crtanje i za umjetnike; slikarske četkice; nastavni materijal i materijal za obučavanje; plastične ploče, folije i omotači za pakiranje; štamparska slova; naljepnice, štamparski blokovi; kalendari; knjige; katalogi; poštanski dopisi; plakati [poster]; časopisi [periodični]; publikacije; novine; časopisi [revije]; čestitke; sprave za pisanje; gumeni pečati; pečati; jastučići za pečate; jastučići za mastilo; foto albumi; podloge za uramljivanje slika i fotografija; slikarski stalci; papir koji upija ulje za kožu; stalci za fotografije; tuš [boja]; papirne maramice; papir, higijenski; papirne maramice za skidanje šminke; ubrusi od papira; stolni kompleti od papira; papirni podmetači za boce; papir za pakovanje, uvijanje i materijali za pakovanje; vodene boje za umetnike; grafičke reprodukcije, portreti; litografije [kamenotisci]; pera [kancelarijski pribor]; olovke; nalivpera; kuglice za hemijske olovke; pera za pisanje; držala za pera; nastavci za olovke; punjenja za olovke i instrumente za pisanje; ulošci za olovke [mine]; olovke u boji; pastele [olovke]; kutije za olovke; pernice; mašine za oštrenje olovaka; oštrila za olovke; kvačice za papire; pritiskači za papir; papirne igle; ekseri s pljosnatom glavom [rajsnegle]; ljepila za papirne proizvode ili za domaćinstvo; papir, kaširani; košare i postolja za pisma; držači za pisma; otvarači pisama; ljepljive trake za papirne proizvode ili za domaćinstvo; table za crtanje; pera za izvlačenje crta; setovi za crtanje; albumi za marke i metalni novac; vreće za smeće; kese za zamrzivač; kese za poklone; papirne kese; poštanske kese, kese za sendviče; kese za sendviče (od papira); papirne kese za žurke; papirne kese za poklone; kese za led, konusne papirne vrećice; plastične kese za sendviče; vrećice za kuvanje u mikrotalasnim pećima; papirne kese za kupovinu; plastične kese za kupovinu; papirne kese za otpad; ojačane kese od kartonskog materijala; omotnice [papirni proizvodi]; upijajuća hartija [bugačice]; stalci za pridržavanje knjiga; obeleživači za knjige; markeri stranica u knjizi; kutije za papirne proizvode [kancelarijske potrepštine]; slikarska platna; blokovi [notesi]; dnevni; fascikle [kancelarijski pribor]; blokovi za pisanje [papirni proizvodi] podsetnici; papir za pisma; papir za crtanje; papirni pribor za pisanje; mape za pisanje; kreda; školske table; tabla za plakate; džepići za pasoše; korice za blokove s čekovima; gumene trakice za povezivanje spisa; slike; matrice za umnožavanje [šablone]; matrice [papirni proizvodi]; proizvodi za brisanje; kancelarijski noževi za brisanje [radiranje]; tečni proizvodi za brisanje; električni otvarači za pisma; štampane muzičke partiture; bele table (koje se mogu brisati); ukrasi i dekoracije od papira i/ili kartona; stolne salвете od papira; papirne kese za užinu; sanduci i torbe od kartona; bojanke; fascikle [papirni proizvodi]; papirno vezivo; džepne sveske; flomasteri; knjige za učenje čitanja (za decu); set grafitnih olovaka; set bojica; lenjiri za crtanje; podmetači za pisanje; autografske knjige; kvačice za papire; heftalice [kancelarijske mašine]; rezač trake [kancelarijski materijal]; znaci upozorenja; kancelarijski mašine za rezanje papira; CD narezivač za kućnu ili kancelarijsku upotrebu; mašine i aparati za oblaganje plastikom; električni aparat za ugradnju zaštitnog omotača za dokumente i fotografije putem toplotnog zaptivanja; držači i futrole za kartice; papirni ukrasi za kutije za ručak i namirnice; korice za neuvezane časopise; kutije, kartonske ili papirne; karte; stalci za pečate; novine sa stripovima; šestari

za crtanje; papirne trake ili kartice za upis kompjuterskih programa; papir za kopiranje; korektori, tečni [kancelarijski pribor]; naprsci, gumeni [kancelarijski pribor]; zastavice od papira; fascikle za papir; noževi za savijanje ili rezanje papira [kancelarijski pribor]; trake, gumirane [papirnati proizvodi]; džepne maramice, papirnate; indeksne kartice; trake natopljene tintom; futrole za isprave; naljepnice [ne od tkanine]; geografske mape [geografske karte]; čestitke s muzikom; okružnice; kutije za slikarske boje [školski pribor]; brošure; kancelarijski mašine za rezanje papira; držači za mine za olovke; poštanske marke; samoljepljivi papirni proizvodi; ulaznice, vozne karte, birački listići i slični proizvodi; trake za pisače mašine; pisače mašine, električni ili neelektrični; papirni omoti [korice]; četkice za pisanje; kreda za pisanje; tableti za pisanje; ukrasne papirne vaze za cvijeće; portikle, papirne [djeci oko vrata protiv prljanja]; papirni filteri za kafu; knjižice [pasoši, radne knjižice itd.]; modeli za izradu veza; noževi za papir [kancelarijski pribor]; prekrivači stolova od papira; stolnjaci od papira; natpisi na papiru ili kartonu; metalni vrh za indeksne karte; papirni kvadrati; samoljepljivi papirni proizvodi (stikeri) za prenosive telefone; umjetničke slike, uokvirene ili neuokvirene; spravice za plastificiranje isprava [kancelarijski pribor]; kartonske kutije za šešire; ručne sprave za stavljanje naljepnica; markeri [pisači pribor]; posude za boje; brisači za table za pisanje; papir Xuan [za slikare i kinesku kaligrafiju]; mehaničke olovke; vasi [japanski papir]; matrice za ukrašavanje hrane i pića; značke sa imenom [kancelarijski materijal]; trake za barkod; sjaj za papirnate proizvode; papirne oznake za potvrde za podizanje prtljaga; papirne maramice za čišćenje

Klasa 18: Koža i imitacije kože; životinjska koža; kišobrani; torbe za prtljag i za nošenje; kišobrani, suncobrani i štapovi za hodanje; bičevi, konjska oprema, i sedlarska roba; ogrlice za životinje; kožni povodci; odjeća za životinje; torbe; torbe za novac [vrećice za novce]; novčanici; putne torbe; torbe za isprave (aktovke); futrole za ključeve; vreće [omotači, džepovi], od kože za ambalažu; kutije za isprave; rančevi; torbe-navlake za odijela; torbe za namirnice; remeni, kožni za nošenje preko ramena ili leđa; sedlarski kaiševi; ugrađeni pojasevi za prtljag; štapovi od trske; futrole za podsjetnice; vezice od kože ili imitacije kože; kutije za toaletni pribor; brnjice; torbe za školu; kožni kaiševi; ručke za kofere; koferi, ručni; torbe za putovanja; kovčežići za prtljag; navlake za kišobrane; ručke za kišobrane; stolice-štapovi [stolice koje se po potrebi mogu preinačiti u štapove za šetnju]; kaiševi za prtljag; torbe za plažu; kutije, kožne ili od kartonske kože i kutije od kože i od kože i kartona; ručne torbe; planinarski štapovi; torbe za muzičke partiture; mreže za namirnice; ruksaci; torbe za alat [prazne]; mali koferi; torbe za divljač; vreće [omotači, džepovi], od kože za ambalažu; presvlake za domaćinstvo, od kože ili imitacije kože; okviri ručnih torbi; torbe za nošenje male djece; torbe na točkićima; sportske torbe; odjeća za kućne ljubimce; marama [ešarpe] za nošenje male djece; prekrivači za životinje; zaprežna oprema za životinje i kožni povodci, uzice; navlake za torbe za novac; futrole za poslovne kartice; randele (Japanske školske torbe); uzde za vođenje dece, motorizovani koferi, oznake za prtljag; tkanina od imitacije kože.

Klasa 25: Odjevni predmeti; obuća; pokrivala za glavu; kecelje [odjevni predmeti]; odjeća za plažu; kupaći kostimi; sportska odjeća; kabanice; rukavice; rukavice bez prstiju; rukavice sa svim spojenim prstima, osim palca; pojasevi [odjevni predmeti]; odjevni predmeti za decu, muškarce i žene; odjevni predmeti za bebe; pelene-gaćice za odojčad [odjeća]; portikle, nepapirne [djeci oko vrata protiv prljanja]; donje rublje; pidžame; ogrtači za kupanje; naramenice; šeširi; ženske kape; kačket; kačketai kao pokrivala za glavu; francuske kape; kapice za kupanje i kapice za tuširanje; mufovi [odjevni predmeti]; neelektrične vrećice obložene krznom za grijanje nogu; pokrivači za uši [odjevni predmet]; odjeća za oko vrata; kravate; mašne [vrste kravate]; leptir mašna; kratke čarape [sokne] i

čarape; hulahopke; podvezice od elastične tkanine; podvezice za čarape i podvezice [držači] za muške čarape; cipele i sportske cipele; papuče; obuća za plažu; odjeća za maskembale; štitnici za rukave; marame; ešarpe [šalovi]; sandale za kupanje; cipele za kupanje; skijaška obuća; čizme; grudnjaci; gaćice; ženske potkošulje; kaputi; manžetne [odjevni predmeti]; krznjeni šalovi; kratki kaputi [sakoi]; žersej [odjevni predmet]; jakna ili košulja od platna ili serža za mornare; trikoi [odjevni predmeti]; spoljna odjeća; ogrtači [odjevni predmeti]; pantalone; vindjakne [kratki sportski kaputi s kapuljačom]; puloveri bez rukava; sandale; marame; šalovi [fulari]; košulje; slipovi [donji veš]; bluze [radničke bluze]; dokoljenice [gamaše]; sportska obuća; trikoi [gimnastički dresovi, majice]; odela; tee-shirts [majice]; pantalone; odore [uniforme]; prsluci; kombinezoni za skijanje na vodi; potkošulje; gimnastičke papuče; gimnastička odjeća; lente [široki pojasevi]; odjeća za bicikliste; maske za spavanje; odjevni predmeti koji sadrže materije za mršavljenje; pleteni odjevni predmeti; štitnici peta za cipele.

Klasa 28: Igre, igračke i stvari za igru, uređaji za video igre, lutke [igračke]; igračke od pliša; plišani medvjedići; figure igračke; kompleti za igre; gimnastički i sportski artikli; kugle za igru; gumene lopte i baloni; praznične dekoracije i ukrasi; ukrasi i dekoracije za božićna drvca; oprema za ples; vozila [igračke]; električna vozila [igračke]; daske za talase [surfing]; daske za skijanje; roleri; klizaljke za led; skejtbord; zaštitni jastučići za sportsku odjeću; vazdušni pištolji [igračke]; torbe za štapove za golf, sa ili bez točkića; lopte za igru; zvončići za božićna drvca; bilijarske kuglice; bilijarski stolovi; građevinski elementi [igračke]; stolne igre; bomboni, praskavi božićni bomboni; klizaljke s čizmicama, za led; uređaji i mehanizmi za kuglanje; graditeljske igre; držači svjećica za božićna drvca; table za igranje dame; pribor za igru dame; šah [igra]; table za igranje šaha; božićna drvca-novogodišnje jelke od sintetičkog materijala; postolja za božićna drvca; pribor za mađioničare; pehari za nagrade u igrama; strelice; kockice za kockanje; kreveti za lutke; odjeća za lutke; kuće za lutke; sobe za lutke; pribor za igranje domina; tegovi za vežbanje; zaštita za laktove [sportski pribor]; gimnastičke protezaljke, za razvlačenje; jahaonica; flašice za lutke; udice; pribor za pecanje; peraje za plivače; plovci za pecanje; leteći tanjiri [igračke]; automatske igre; reketi; aparati za elektronske igre; mašine za video igre; prenosive video igrice sa zaslonima od tečnih kristala; elektronske mašine za video igre; torbe za štapove za golf; štapovi za golf; rukavice za golf; rukavice za igru i sport; varke [predmeti za prevaru za zabavu]; namotaji za papirne zmajeve; zmajevi, papirni; zaštita za koljena [sportski pribor]; ma-jong [kineska igra]; kuglice za igru [špekule]; pozorišne lutke [marionete]; maske, pozorišne; maske (igračke); mobilni [igračke sastavljene od više elemenata koji trepere uz najmanje strujanje vazduha]; mali modeli vozila; društvene igre; praskavi detonatori [igračke]; igračke za grickanje [kod nicanja zuba]; kolutovi za igru; konji-ljuljaške [igračke]; koturaljke; daske s jedrima, za vodu; skije; saonice za trke [bob sanke]; tobogani [igra]; igračke za pravljenje mjehurića od sapunice; zvrkovi [igračke]; odskočne daske [sportski artikli]; bicikli za treniranje na mjestu; bazeni [predmet za igru]; dušeci na naduvavanje; peraja za plivanje; daske za plivanje; peraja za plivanje za ruke; igračke na naduvavanje za bazene; ljuljaške; stolovi za stolni tenis; igračke za kućne ljubimce; skije za vodu; predmeti za igru za plivanje, igre, sportove i aktivnosti na vodi; lopte za plažu; automatske igre [mašine] uz prethodno plaćanje; navlake za skije i daske za surfovanje; bingo kartice; mrežice za leptire; karte za igru; konfeti; koturaljke s točkićima u nizu; pazle; kaleidoskopi; jarboli za daske s jedrom; vrećaste mreže za pecanje; vozila s daljinskim upravljanjem [igračke]; okretna ploča za rulet; staklene kugle sa snijegom; reketi za snijeg [krplje]; japanske karte za igru; prsluci za plivanje; pojasevi za plivanje; plutajući uređaji za kupanje i plivanje; plovci za plivanje i kupanje; šeširi od papira



za zabave; sprave za jačanje mišića; žetoni za kockanje; kartice za struganje za lutriju; kompleti za izradu maketa; pačinko [mašine za igre]; aparati za kockanje [aparati za igre]; roboti igračke; dronovi (igračke); zaštitne folije prilagođene za ekrane prenosnih igara; komandne palice [džojstici za video igre]; sličice za igre; šatori za igru; konzole za video igre; ručne konzole za igranje video igara.

Klasa 29: Meso, riba, živina i divljač; mesni ekstrati; konzervirano, sušeno i kuvano voće i povrće; želei, džemovi, kompoti; jaja, mlijeko, sir, puter, jogurt i drugi mliječni proizvodi; jestiva ulja i masti; supe, čiste, mesne [bujoni]; koncentri čistih mesnih supa [bujona]; puter; kavijar; sir; mliječni proizvodi; prehrambeni proizvodi pravljeni od ribe; hrana pripremljena od ribe; zašećereno voće; zamrznuto voće; kriške voća; margarin; pekmezi; mesni žele; mesne konzerve; mliječni napitci; konzervisane gljive; pripremljeni orasi; paštete od jetre; puter od kikirikija; obrađeni kikiriki; konzervisani grašak; kora od limuna ili naranče; prženi krompiri [čips]; uštipci od krompira; salate; kiseli kupus; kobasice [salame]; sezamovo ulje; sastojci za pripremanje supe od povrća; supe od mesnih koncentrata; tofi, grudve zgnječene soje; salate od povrća; pripremanje za supe od zeleniša; mućena pavlaka; jogurt; instant supe; instant varivo; instant pire krompir; instant miso supa; gotova kari jela; gotovo kari varivo; zakuske; alge (za jelo); obrađeno i konzervisano meso, riba, živina i divljač; slanina; sastojci za pripremanje mesnih juha [bujoni]; puter od oraha i čokolade; suhomesnati proizvodi; hrskavci [kroketi]; riblje konzerve; voćni želei [žele]; voćne salate; voćne konzerve; ulje od kukuruza; jestivo maslinovo ulje; grožđice [suvo grožđe]; pire od paradajza; konzerve od povrća; riba i plodovi mora (neživi); riba i plodovi mora, obrađeni i konzervisani; konzerve, riblje i morski plodovi; prehrambeni proizvodi od/napravljeni od bjelančevine morskih plodova za kulinarske potrebe; alginati za kulinarstvo; konzervirani pasulj; mliječni frapei; mliječni napitci u kojima mlijeko prevladava; kimši [fermentisana hrana od povrća]; tahini [tijesto od sezamovog sjemena]; tostirani varek, prženi za jelo [morska trava]; surutka od mlijeka; aloe vera pripremljena za ljudsku ishranu; obrađena riblja ikra; ptičja gnijezda [jestiva]; napici s bakterijom za proizvodnju mliječne kiseline; bademovo mleko [napici]; napici od kikiriki mleka; konac za pravljenje kobasica; yakitori; yuba [tofu listići]; tajine [pripremljeni obrok od mesa, ribe ili povrća];

Klasa 30: Kafa, čaj, kakao i zamjene za kafu; riža; prehrambena tjestenina i rezanci; brašno tapioke za prehranu i sago [skrob iz sjemena palme sago]; brašno i preparati od žitarica; hljeb, slastičarski proizvodi i slatkiši, čokolada; sladoled, šerbet [voćni sladoled] i drugi jestivi smrznuti proizvodi; šećer, med, gusti tamni sirup; pjenica [kvasac]\*, prašak za dizanje; so; začini, mirođije, zelen (konzervisano zelenje) [začini]; sirće; umaci, začinski [i drugi dresinzi]; led, sirovi (smrznuta voda); biskviti [suvi kolačići]; prašak za kolače; jestivi ukrasi za kolače; arome za kolače [osim eteričnih ulja]; kolačići od riže; bomboni; čokolada; mlijeko, čokoladno [napitak]; pića od čokolade; namazi na bazi čokolade; šećerni proizvodi za ukrašavanje božićnih drvca; kakao s mlijekom; proizvodi od kakaoa; pića od kakaoa; arome za kafu; cikorija [zamjena za kafu] i biljni preparati kao zamjena kafe; pića od kafe; kukuruzne kokice [pucanci]; pahuljice, kukuruzne; pavlaka, smrznuta [šlag]; kari [začin]; engleska krema; pahuljice; arome [osim eteričnih ulja]; jogurt, smrznuti [vrsta sladoleda]; voćno tijesto [poslastica]; medenjaci; sirup; čajevi, nemedicinski; kečap [sos]; crni šećer, slatki korjen [poslastica]; mesne pite; proizvodi za omekšavanje mesa u domaćinstvu; palačinke; pastile [bomboni]; biber; pizza; varenci [puđinzi]; ravioli [tjestenina]; matična mlijječ; šećer; wasabi pasta; pikantni umak od soje; tjestenina za prehranu, rezanci i rezanci za supe; udon [nudle na japanski način]; sushi [japansko jelo od riže]; vanila [aroma]; vafel proizvodi; perece; zakuske [mali obroci] od pšenice;

mešavine zakuski koje se sastoje od krekeri, pereca i kokica; slatkiši od badema; aromatični preparati za prehrambene potrebe; vezivni agensi za sladoled; fino sitno pecivo; pecivo [brioši]; kolači; karamele [bomboni]; žvalača guma; kukuruzno brašno; krekeri; ledeni sladoledi sirup od melase, šećerni sirup; makaroni [vrsta tjestenine]; marcipan [kolač od badema]; majonez; zobeno brašno; paprika [začin]; voćni kolači; reliš [dodatak jelu]; dvopek [prepečenac]; so, kuhinjska; sendviči; umak od paradajza; začini; šerbet [voćni sladoled]; špageti; torte; brašno od žita; umaci za salatu; mesni sosovi [umaci]; sos za tjesteninu; pripremljeni obroci od rezanaca; zkuske [mali obroci] od žitarica; zkuske [mali brzi obroci] od riže; pahuljice, zobene; glukoza za kulinarsvo; visokoproteinske pločice od žitarica; brašno\*; dezertni musevi [poslastičarski proizvodi]; namirnice od zobi; tijesto od sojinog zrna [začin]; čaj (napitci od čaja); baštenska zelen (konzervisano zelenje) [začini]; gluteinski dodaci za kulinarske svrhe; coulis [voćni preliv]; prerađeno seme za upotrebu kao začin; ramen (japansko jelo na bazi rezanaca); zkuske od sira; senbei [krekeri od riže], pepermint za osvežavanje daha.

Klasa 35: Veleprodaja i maloprodaja i usluge naručivanja poštom vezane za prodaju artikala za zabave i prazničnih dekoracija i ukrasa, sapuna, parfimerijskih proizvoda, eteričnih ulja, kozmetičkih proizvoda, losiona za kosu, proizvoda za njegu kose, toaletnih proizvoda, proizvoda za njegu zuba. proizvoda za ličnu higijenu; Veleprodaja, maloprodaja i usluge naručivanja poštom vezane za prodaju proizvoda za čišćenje, poliranje, glačanje, materije za pranje, alata za manikir, proizvoda za njegu noktiju, laka za nokte, vještačkih noktiju; Veleprodaja i maloprodaja i usluge naručivanja poštom vezane za prodaju dijetetskih materija, hrane za bebe, sanitarnih proizvoda, sveća, gaze, traka za paljenje, masti, lubrikanata, ulja za slikanje; Veleprodaja i maloprodaja i usluge naručivanja poštom vezane za prodaju pribora za jelo, posuđa, torbi s priborom za manikiranje; instrumenata za brijanje; britvi, mašina i alata za mašine za domaćinstvo, ručnih alata; Veleprodaja i maloprodaja i usluge naručivanja poštom vezane za prodaju filmova, kamera, foto diskova, magnetoskopa, audio i vizuelnih proizvoda, audio i video traka, ploča i diskova, instrumenata i uređaja za snimanje, prijenos i/ili reprodukciju zvuka i/ili slika, televizora, čitača kaseti i/ili magnetofona sa magnetnim trakama, video kaseti i/ili čitača diskova i/ili magnetofona, radija; Veleprodaja i maloprodaja i usluge naručivanja poštom vezane za prodaju telefona, bežičnih telefona, mobilnih telefona, futrola za mobilne telefone, dekoracije i remena za telefone, indikatora za pozive, aritmetičkih mašina, digitrona; Veleprodaja i maloprodaja i usluge naručivanja poštom vezane za prodaju elektronskih i kompjuterskih igara, kinematografskih filmova, svijetiljki, ventilatora, sprava za kuvanje, kalupa za kolače i tijesto, tostera, rerni, kuhinjskog pribora, pribora i posuda za posluživanje ili skladištenje hrane i/ili napitaka; Veleprodaja i maloprodaja i usluge naručivanja poštom vezane za prodaju kineskih štapića za hranu, instrumenata za sečenje, porculana, predmeta od kristala, emajliranog posuđa, predmeta od srebra, staklarije, predmeta od pečene gline, poluporculana [majolika], keramike; Veleprodaja i maloprodaja i usluge naručivanja poštom vezane za prodaju sušila za kosu, rasvjetnih svijetiljki, sjenila i delova i opreme za sjenila; Veleprodaja i maloprodaja i usluge naručivanja poštom vezane za prodaju dječijih kolica, balona, truba za bicikle, zidnih satova i džepnih ili ručnih satova i dodataka i delova i opreme za njih; Veleprodaja i maloprodaja i usluge naručivanja poštom vezane za prodaju draguljarskih proizvoda i imitacije draguljarskih proizvoda, ukrasa [bižuterija], poluga [lingoti] od plemenitih metala, kutija od plemenitih metala; Veleprodaja i maloprodaja i usluge naručivanja poštom vezane za prodaju dugmića za narukvice od plemenitih metala, kvačica za kravatu od plemenitih metala, igli za kravatu od plemenitih metala; Veleprodaja i maloprodaja i usluge

naručivanja poštom vezane za prodaju umjetničkih predmeta od plemenitih metala, ukrasnih igli od plemenitih metala, ukrasa za obuću od plemenitih metala, kipova od plemenitih metala, figurica od plemenitih metala; Veleprodaja i maloprodaja i usluge naručivanja poštom vezane za prodaju glazbenih kutija, glazbenih instrumenata, slika, fotografija, papirnatih proizvoda; Veleprodaja i maloprodaja i usluge naručivanja poštom vezane za prodaju papirnatih vreća za smeće, papirnatih ubrusa za skidanje šminke, ukrasnih papirne vaze za cvijeće, papirnatih traka, papirnatih filtara za kafu; Veleprodaja i maloprodaja i usluge naručivanja poštom vezane za prodaju toaletni peškiri od papira, pelene od papira, portikle, papirne [djeci oko vrata protiv prljanja], oznake za stranice u knjigama od papira; Veleprodaja i maloprodaja i usluge naručivanja poštom vezane za prodaju higijenskog papira, stolnih peškira od papira, papirnatih džepnih maramica, kutija od kartona ili papira, uskih stolnjaka od papira, stolnog rublja od papira; Veleprodaja i maloprodaja i usluge naručivanja poštom vezane za prodaju umjetničkih boja i materijala, kistova za slikanje, instrumenata za pisanje; Veleprodaja i maloprodaja i usluge naručivanja poštom vezane za prodaju štampanih stvari, knjiga, novina, magazina i periodika, čestitki i božićnih čestitki; Veleprodaja i maloprodaja i usluge naručivanja poštom vezane za prodaju igračkih karata, materijala za ambalažu; Veleprodaja i maloprodaja i usluge naručivanja poštom vezane za prodaju okvira za slike, stalaka za slike, ljepila za papir ili domaćinstvo; Veleprodaja i maloprodaja i usluge naručivanja poštom vezane za prodaju ukrasa od kože ili imitacije kože za nameštaj, kutije od kože ili imitacije kože, futrola za ključeve od kože ili imitacije kože; Veleprodaja i maloprodaja i usluge naručivanja poštom vezane za prodaju obloga od kože ili imitacije kože, ormi, amova, uzdi za životinje od kože ili imitacije kože, trake od kože ili imitacije kože, remenje od kože ili imitacije kože i presvlake za nameštaj od kože ili imitacije kože; Veleprodaja i maloprodaja i usluge naručivanja poštom vezane za prodaju torbi i kofera, vrećica za novac i novčanika, kišobrana, štapova za hodanje; Veleprodaja i maloprodaja i usluge naručivanja poštom vezane za prodaju nameštaja, ogledala, vješalica za odjeću i klinova, kutija i posuda, ploča sa nazivima, malog pribora za domaćinstvo, pribora i posuda za domaćinstvo ili kuhinju, češljeva, sunđera, četki, pribora za čišćenje; Veleprodaja i maloprodaja i usluge naručivanja poštom vezane za prodaju naočara [optika], okvira za naočare i sunčane naočare i navlaka i dodatka za naočare, tekstila i tekstilnih proizvoda, posteljine, stolnog rublja i stolnjaka, salveta, papirnatih kolutova za stolove, nameštaja, ukrasa koji se apliciraju toplim postupkom za tekstilne proizvode [krojački pribor], džepnih maramica; Veleprodaja i maloprodaja i usluge naručivanja poštom vezane za prodaju odjevnih predmeta, obuće, pokrivala za glavu, dugmića, ukrasnih znački, traka i pletenica, čipke i tkanina s ucrtanim motivima za vezenje, igala za kosu i ukrasa, naramenica, ukrasa za obuću, ukrasa za šešire, rajsfešlusa [klizni zatvarači], tepiha i dušeka; Veleprodaja i maloprodaja i usluge naručivanja poštom vezane za prodaju igračaka i igara, lutaka, figurina, sportskih predmeta, dekoracije za božićna drvca; Veleprodaja i maloprodaja i usluge naručivanja poštom vezane za prodaju hrane i napitaka, slatkiša, proizvoda od cveća, šibica, cigara, cigareta i predmeti za pušače; reklamiranje; organizovanje izložbi i sajmovu u komercijalne ili reklamne svrhe; objavljivanje reklamnih tekstova; prodaja (podsticaj prodaje) za treće osobe; kancelarije za reklamiranje; profesionalno upravljanje umjetničkim poslovima; agencije za uvoz-izvoz; prikupljanje podataka za kompjuterske baze podataka; direktno reklamiranje poštom; administrativno upravljanje hotelima; istraživanje tržišta; reklamiranje na otvorenim površinama; zapošljavanje osoblja; reklamiranje putem radija; reklamiranje putem televizije; reklamiranje on-line na informatičkoj mreži; usluge nabave za treće [kupovina proizvoda i usluga za druga

preduzeća]; iznajmljivanje vremena za reklamiranje na svim komunikacionim sredstvima; iznajmljivanje kancelarijskih mašina i aparata; iznajmljivanje automata za prodaju sitne robe; reklamiranje dopisnim putem; komercijalna administracija u vezi licenci proizvoda i usluga trećih lica; pružanje komercijalnih savjeta i informacija potrošačima; marketing; prezentacija proizvoda na svim komunikacionim sredstvima u svrhu prodaje na malo; proizvodnja reklamnih filmova; odnosi s javnošću [propaganda]; iznajmljivanje reklamnog materijala; iznajmljivanje reklamnih prostora; iznajmljivanje fotokopirnih uređaja; uređenje izloga; promovisanje dobara i usluga trećih lica putem izdavanja trgovinskih markica; usluge telemarketinga; administracija programa za česte putnike; usluge finansijskog revizora; usluge odnosa sa medijima; usluge korporativne komunikacije; iznajmljivanje kancelarijske opreme u zajedničkom radnom prostoru.

Klasa 41: Razonoda; zabava; cirkusi [zabavni parkovi]; usluge hala i dvorana za igre; obuka [predavanje]; organizovanje, proizvodnja i prikazivanje spektakala, koncerata, javnih nastupa, pozorišnih nastupa, izložbi, sportskih takmičenja, sportskih i kulturnih aktivnosti; muzičke sale; pozorišne predstave; prikazivanje igranih filmova; kabarei; kino studiji; usluge diskoteka; usluge klubova; izdavanje knjiga, tekstova, magazina, novina i časopisa; posuđivanje knjiga; usluge za ispunjavanje slobodnog vremena, izložbe, koncerti, spektakli, nastupi, sportovi, igre, rekreativne i kulturne aktivnosti; usluge zdravstvenih klubova [održavanje zdravlja i fizičke forme]; usluge kampova za ljetovanje [zabava]; informacije u vezi rekreacije; informacije o obrazovanju; informacije o razonodi, zabavi, sportu i kulturi; razonoda posredstvom televizije; razonoda putem radiofonije; montaža radio i televizijskih programa; proizvodnja filmova i video-a; iznajmljivanje kinematografskih filmova, videotraka, laserskih diskova, video diskova i DVD diskova; iznajmljivanje zvučnih snimaka; iznajmljivanje pozorišnog dekora; obuka za predškolski uzrast; klubovi i saloni sa instaliranim audio i video aparatima sa karaoke uređajima; sobe i sale za igre; organizovanje konkursa ljepote; cirkusi; obuka putem dopisivanja; obuka; igranje igara; gimnastičarska obuka; muzejske usluge [predstavljanje, izložbe]; organizovanje lutrije; usluge orkestra; planiranje prijema [razonoda]; izrada scenarijuma; pozorišne predstave; usluge zooloških vrtova; mikroizdavaštvo; usluge igara pružene on-line [s jedne informatičke mreže]; tumačenje govora pokreta; profesionalna orijentacija [savjeti u vezi obrazovanja ili osposobljavanja]; snimanje na mikrofilmove; komponovanje muzike; fotografisanje; proizvodnja filmova na video kasetama; stavljanje na raspolaganje opreme za karaoke; iskorištavanje elektronskih publikacija koje se ne mogu prenositi on-line; objavljivanje knjiga i časopisa, elektronski on line; snimanje na videotrake; kuglane; omogućavanje korišćenja fitnes prostorija u oblasti bejzbola; omogućavanje korišćenja zatvorenih terena za bejzbol; razonoda u oblasti bejzbola (igre); prikazivanje filmova on-line; usluge razonode, naime omogućavanje korišćenja interaktivnih elektronskih igara putem kompjuterskih mreži; omogućavanje privremenog korišćenja interaktivnih igara koje se ne mogu preuzeti; iznajmljivanje opreme za igranje; iznajmljivanje audio uređaja; iznajmljivanje videokamera; iznajmljivanje rasvjetnih uređaja za pozorišnu dekoraciju i za televizijske studije; iznajmljivanje filmskih projektoru i dodataka; iznajmljivanje radio i televizijskih aparata; iznajmljivanje dekora za priredbe; iznajmljivanje sportske opreme [osim vozila]; iznajmljivanje sportskih terena; iznajmljivanje stadiona; iznajmljivanje magnetoskopa; iznajmljivanje videotraka; iznajmljivanje igrački; kroćenje životinja [dresiranje]; praktična obuka [demonstriranje]; prevodilačke usluge; organizovanje i vođenje radionica za stručno osposobljavanje; usluge razonode, naime omogućavanje korišćenja audio-vizuelnih materijala, slika, televizijskih programa i kinematografskih filmova preko on-line kompjuterske mreže; omogućavanje korišćenja slika, zvuka i vida

preko on-line mreža; omogućavanje korišćenja informacija o fiktivnim likovima; omogućavanje korišćenja on-line muzike i videa koji se ne mogu preuzeti; usluge stavljanja na raspolaganje filmova koji se ne mogu preuzeti, putem prenosa video zapisa na zahtev; usluge stavljanja na raspolaganje televizijskih programa koji se ne mogu preuzeti, putem prenosa video zapisa na zahtev; distribuiranje filmova; obrazovne usluge pružene od strane asistenata za posebne potrebe; obrazovno testiranje za korisnike da bi se kvalifikovali za pilote drona; usluge inženjeringa zvuka na događanjima; usluge tehničara osvjetljenja na događanjima; režiranje filmova, osim reklamnih filmova.

Klasa 42: Naučne i tehnološke usluge i naučna istraživanja, kao i sa tim povezano projektovanje; analiza delatnosti i usluge industrijskog istraživanja; izrada i razvoj kompjuterskog hardvera i softvera; savjetodavne usluge o nadzoru i arhitekturi; savjeti o gradnji; kompjutersko programiranje; održavanje kompjuterskih programa; izrada građevinskih planova; savjetodavne usluge u vezi zaštite okoline; industrijski dizajn; unutrašnje uređenje [dekoracija]; usluge dizajniranja ambalaže; usluge modnih dizajnera; usluge dizajniranja grafičke umjetnosti; vremenska prognoza; urbanističko planiranje; dupliciranje informatičkih programa; izrada kompjuterskih programa; instaliranje kompjuterskih programa; savjetovanje o kompjuterima; konverzija podataka ili dokumenata s jednog fizičkog na elektronski disk; kreiranje i održavanja web stranica za druge; konverzija informatičkih podataka i programa [nije fizička konverzija]; ugošćavanje informatičkih stranica; cloud computing; iznajmljivanje kompjutera; konsultacije u vezi kompjuterskih programa [softvera]; analiza kompjuterskih sastava; osmišljavanje informatičkih sistema; savjetodavne usluge iz oblasti kompjuterske tehnologije; digitalizacija dokumenata [skeniranje]; savjetovanje o informacionim tehnologijama; čuvanje rezervne kopije podataka van mreže; pružanje poslovnih informacija putem Internet stranice; softver u vidu servisa [SaaS]; savjetovanje o izradi veb sajtova; dizajn enterijera; kompjuterske i tehnološke usluga radi obezbeđivanja kompjuterskih i finansijskih podataka i podataka o ličnosti i za detekciju neovlašćenog pristupa podacima; razvoj kompjuterskih platformi; dizajniranje vizit karti; grafički dizajniranje promotivnih materijala.

Klasa 43: Usluge snabdevanja hranom i pićem; privremeni smeštaj; restorani; kafane-restorani; kafane [kafeterije]; usluge barova; menze; kantine; usluge kateringa; restorani sa samoposluživanjem; restorani za brzo i stalno posluživanje [snek-barovi]; koktel saloni; dekoracija hrane; dekoracija torti; informacije i savjeti u vezi sa pripremanjem obroka; usluge ličnog kuvara; usluge prijema za privremeni smeštaj [upravljanje dolascima i odlascima]; pružanje usluge i rezervisanje smeštaja, hotela, motela, pansiona i pružanje informacija o tome; usluge povezane sa rezervisanjem soba u hotel od strane turističke agencije ili brokera; usluge kampova za ljetovanje; omogućavanje korišćenja prostorija za izložbe; restorani, kafane, kafeterije, barovi, menze, kantine i saloni sa instaliranom audio-vizuelnom opremom sa karaoke uređajima; usluge brige o deci; jaslice [dječije ustanove]; ljetovališta; organizovanje hrane i pića za svadbene prijeme; organizovanje svadbenih prijema [lokacija]; iznajmljivanje električnih tostera, mikrotalasnih, rešoa, aparata i sprava za pripremanje hrane i pića; pansioni za životinje; iskorištavanje terena za kamping; iznajmljivanje stolaca, stolova, escajga i staklenog posuđa; iznajmljivanje aparata za kuvanje; iznajmljivanje uređaja za pijeću vodu; iznajmljivanje sala, dvorana za sastanke; iznajmljivanje šatora; iznajmljivanje prenosivih građevinskih objekata.

(111) **15128**

(151) 22.02.2021.

(210) Ž-2018-29

(220) 06.02.2018.

(732) Miomir Mrvaljević, Bulevar Svetog Petra Cetinjskog br. 54, Podgorica, ME

(540)



(550) I

(511) Klasa 3: Parfimerijski proizvodi, eterična ulja, kozmetički proizvodi, losioni za losu

Klasa 5: Higijenski proizvodi za upotrebu u medicini.

Klasa 14: Časovničarski proizvodi.

Klasa 16: Štamparski proizvodi.

Klasa 18: Proizvodi od kože i imitacije kože, koferi, torbe, kišobrani.

Klasa 20: Proizvodi od drveta, plute, trske, šiblja, roga, kosti i plastični proizvodi koji nijesu obuhvaćeni drugim klasama.

Klasa 21: Pribor i posuđe za domaćinstvo i kuhinju, četke, češljevi, sunđer i proizvodi od stakla.

Klasa 22: Šatori, cerade, jedra.

Klasa 24: Tkanine i tekstilni proizvodi koji nijesu obuhvaćeni drugim klasama, prekrivači za krevete i stolove.

Klasa 25: Odjeća, obuća, pokrivala za glavu.

Klasa 26: Čipka, vez, dugmad, vještačko cvijeće.

Klasa 27: Tepisi, prostirači, ostali prekrivači za podove, zidne tapete koje nijesu od tekstila.

Klasa 28: Igračke, sportski predmeti koji nijesu obuhvaćeni drugim klasama, prekrivači za krevete i stolove.

Klasa 29: Meso, mesni ekstrakti, konzervirano, sušeno i kuvano voće i povrće, džemovi, kompoti, jaja, mlijeko i mliječni proizvodi, jestiva ulja i masti.

Klasa 30: Kafa, čaj, hleb, kolači, med, začini.

Klasa 31: Poljoprivredni, povrtlarski, šumski proizvodi i bobice koji nijesu obuhvaćeni drugim klasama, žive životinje.

Klasa 32: Pivo, mineralne i gazirane vode i ostala bezalkoholna pića, voćni sokovi, sirupi.

Klasa 33: Alkoholna pića (osim piva)

Klasa 34: Duvan, pribor za pušaće, šibice.

Klasa 35: Oglašavanje i reklamiranje.

Klasa 36: Osiguranje, finansijski poslovi, monetarni poslovi, upravljanje nekretninama.

Klasa 38: Telekomunikacije.

Klasa 39: Prevoz, ambalažiranje i skladištenje proizvoda.

Klasa 41: Obuka, stručno osposobljavanje, razonoda, sportske i kulturne djelatnosti.

Klasa 43: Usluge obezbjeđivanja hrane i pića, privremeno primanje na stan.

Klasa 44: Higijenska njega i njega ljepote, usluge poljoprivrede, šumarstva i portlarstva.  
Klasa 45: Pravne usluge, lične i društvene usluge koje pružaju drugi, namjenjene za zadovoljenje ljudskih potreba.

---

(111) **15129**

(151) 22.02.2021.

(210) Ž-2020-95

(220) 06.03.2020.

(732) RELIGIOUS TECHNOLOGY CENTER, 1710 Ivar Avenue, Suite 1100, 90028, Los Angeles, California, US

(540)



(550) I

(740) Božidar S. Radulović, Studentska bb, Lamela 3/18, 81000, Podgorica

(511) Klasa 16: Štampane stvari, naime, knjige, magazini, bilteni, priručnici, informacioni paketi i knjige za kurseve u vezi sa religijom i filozofijom.

Klasa 41: Obrazovne usluge, naime, vođenje kurseva, seminara i predavanja u oblasti religije, filozofije i edukacija u vezi sa religijom i filozofijom.

---

(111) **15130**

(151) 22.02.2021.

(210) Ž-2019-410

(220) 29.10.2019.

(732) DRUŠTVO ZA PROIZVODNJU I PROMET KOZMETIKE LABORATORIJA DOKTOR PAVLOVIĆ, MILŠEVSKA 23, 11000, BEOGRAD, RS

(540)



(550) I

(740) Dejan Raičević, Vojvode Boža br.1, 81250, Cetinje

(511) Klasa 3: Kreme za lice i tijelo, posebno za bebe i decu.

Klasa 5: Farmaceutski proizvodi, masti za medicinsku upotrebu.

Klasa 44: Medicinska i higijenska pomoć i usluge u vezi sa njegom lepote.

---

(111) **15131**

(151) 22.02.2021.

(210) Ž-2019-428

(220) 06.11.2019.

(732) Khayrat Al-Manafa for General Trade and Public Transport Limited Liability company, 27, Saborni str., Varna, BG

(540)

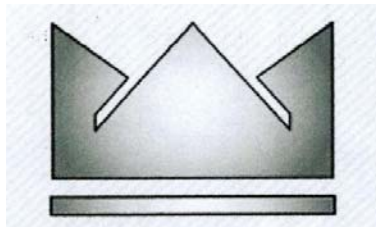

(550) I

(740) Božidar S. Radulović, Studentska bb, Lamela 3/18, 81000, Podgorica

(511) Klasa 34: Duvan; duvan za zamotavanje; zamjena za duvan; proizvodi od duvana; aromatizovani duvan; filteri za duvan; lule za duvan; sirovi duvan; duvan za žvakanje; šibice; sigurnosne šibice; cigarete; proizvodi za pušače; pribor za pušenje; upaljači za pušače; pepeljare za pušače.

---



(111) **15132**

(151) 22.02.2021.

(210) Ž-2019-411

(220) 29.10.2019.

(732) DRUŠTVO ZA PROIZVODNJU I PROMET KOZMETIKE LABORATORIJA DOKTOR PAVLOVIĆ, MILŠEVSKA 23, 11000, BEOGRAD, RS

(540)



(550) I

(740) Dejan Raičević, Vojvode Boža br.1, 81250, Cetinje

(511) Klasa 3: Kreme za lice i tijelo, posebno za bebe i decu.

Klasa 5: Farmaceutski proizvodi, masti za medicinsku upotrebu.

Klasa 44: Medicinska i higijenska pomoć i usluge u vezi sa njegom lepote.

---

(111) **15133**

(151) 22.02.2021.

(210) Ž-2018-321

(220) 23.08.2018.

(732) Kamalaya Co., Ltd., 102/9 Moo 3, Laem Set Road, Na-Muang, Koh Samui, 84140, Suratthani, TH

(540)



(550) I

(740) Božidar S. Radulović, Baku 30/5, 81000, Podgorica

(511) Klasa 43: Agencije za smještaj ( hotelski pansioni); rezervacija privremenog smještaja; usluge barova; katering hrane i pića; hoteli; iznajmljivanje prostorija za sastanke; iznajmljivanje privremenog smještaja; iznajmljivanje soba kao privremenog

smještaja; restorani; usluge zdravstvenog odmarališta, naime, obezbjeđivanje hrane, tretmana i smještaja koji se specijalizuju za promovisanje opšteg zdravlja i blagostanja.

---

(111) **15134**

(151) 22.02.2021.

(210) Ž-2019-453

(220) 13.11.2019.

(732) CP KELCO U.S., Inc., 3100 Cumberland Blvd., Suite 600, 30339, Atlanta, Georgia, US

(540)

## UNLOCKING NATURE-POWERED SUCCESS

(550) I

(740) Jasna Jusić, Dalmatinska 2, 81000, Podgorica

(511) Klasa 1: Hemijski proizvodi koji se upotrebljavaju u industriji, nauci i fotografiji, kao i poljoprivredi, hortikulturi i šumarstvu; neprerađene vještačke smole, neprerađene plastične materije; smješe za sprječavanje i gašenje vatre; preparati za kaljenje i zavarivanje; supstance za štavljenje životinjskih koža i koža krupnih životinja; lijepkovi za upotrebu u industriji; kitovi i druga punila u formi pasti: kompost, stajsko gnojivo, đubriva; biološki preparati za upotrebu u industriji i nauci; biološki preparati za upotrebu u industriji i/ili nauci; citrusna vlakna za industrijsku svrhu; citrusna vlakna za hemijsku i prehrambenu industriju; voćna vlakna koja sadrže pektin za industrijsku svrhu; voćna vlakna koja sadrže pektin za hemijsku i prehrambenu industriju; hemijski aditivi; aditivi za hranu; biljna vlakna za industrijsku svrhu; biljna vlakna za hemijsku i prehrambenu industriju; pektin za prehrambenu industriju; pektin za industrijsku svrhu; celulozni etri za industrijske svrhe; bakterijska celuloza; celuloza i derivati celuloze; sredstva za geliranje; zamjene za masti; sintetički zgušnjivači koji se koriste u proizvodnji; sredstva za zgušnjavanje koja se koriste u industriji; sredstva za zgušnjavanje kao biohemijski proizvodi za industrijsku upotrebu; hemijski stabilizatori; stabilizatori za ulje, boje; emulgatori; površinski aktivna sredstva; sredstva za emulgiranje, raspršivanje, otapanje i vlaženje; aditivi za benzin, gas i motorna goriva; hemikalije za ulje, masti i voskove; hemijski reagensi za upotrebu u proizvodnji hemikalija; hemikalije i hemijski preparati za upotrebu u proizvodnji mirisa, sastojaka mirisa i jedinjenja mirisa; hemikalije koje se koriste u proizvodnji, posebno kozmetičkih i toaletnih preparata, preparata za osvježavanje vazduha i dezodorisanja, preparata za oralnu njegu, sredstava za čišćenje u domaćinstvu, dezodoransa i sredstava za dezinfekciju; hemijski sastojci koji se koriste za stvaranje ili poboljšanje osjećaja, ukusa i teksture hrane u ustima; hemikalije za upotrebu u proizvodnji i očuvanju hrane, dodaci za hranu i piće; hemikalije koje se koriste kao sastojci i aditivi u proizvodnji hrane, dodaci za hranu i piće; hidrokoloide, za upotrebu u proizvodnji i čuvanju hrane, dodaci za hranu i piće; eter od celuloze, neprerađen; hemijski preparati za proizvodnju boja; hemijski preparati za proizvodnju pigmenata; hemijski reagensi [osim za medicinske ili veterinarske svrhe]; hemikalije za impregnaciju tekstila; vodotopljivi polimeri; polimeri koji se koriste u industriji;

prehrambeni protein kao sirovina; protein koji se koristi u industriji; polisaharid koji se koristi u fermentaciji, aromatizaciji, konzervansima i u vezivanju; polisaharid koji se koristi u prehrambenim proizvodima; hemijska priprema i materijali za film, fotografiju, štampu i proizvodnju papira; hemijski sastav za upotrebu u građevinarstvu; konzervansi za beton; sastav za proizvodnju keramike i betona; hemikalije za upotrebu u poljoprivredi, vrtlarstvu i šumarstvu; fermenti za hemijske svrhe; mješavine emulgatora i hidrokoloida, mješavine emulgatora i enzima, stabilizujuće mješavine, desni, rhamsan guma, guma velan, guar guma, guma od rogača, diutanska guma, gelanska guma, ksantanska guma, alginat, karagenan za upotrebu u industriji.

---

(111) **15135**

(151) 22.02.2021.

(210) Ž-2019-455

(220) 15.11.2019.

(732) Balmain S.A., 44, rue Francois 1er, 75008, Paris, FR

(540)

(550) I

(740) Miladin Popović, Đoka Miraševića 21/III, 81000, Podgorica

(511) Klasa 3: Kozmetika; kozmetičke olovke, uključujući olovke za usne i olovke za oči; kozmetičke kreme, uključujući hidratantne i hranjive kreme, toniranu kremu, kremu za izbjeljivanje kože, kremu protiv bora, noćne i dnevne kreme; kozmetički preparati za njegu kože, uključujući mlijeko za čišćenje za toaletne svrhe, losione za kozmetičke svrhe; preparati za sunčanje [kozmetika]; preparati za zaštitu od sunca; preparati za kupanje i tuširanje, ne za medicinsku upotrebu; soli za kupanje, koje nijesu za medicinsku upotrebu; sredstva za čišćenje zuba; dezodoransi za ljude; dezodorantni sapuni; parfimerija, parfem, potpuri [mirisi], mirišljava voda, parfemska voda, toaletna voda, kolonjska voda; eterična ulja; ulja za upotrebu u kozmetici; ulja za čišćenje; toaletna ulja; gelovi za masažu, izuzev onih za upotrebu u medicini, svijeće za masažu za upotrebu u kozmetici; balsami, osim za upotrebu u medicini; preparati za brijanje, sapuni za brijanje, losioni za prije i poslije brijanja; kozmetičke maske; šminka, uključujući podloge za šminku, osnove za šminku na bazi gelova, kreme, i tečnosti, rumenilo, puder za šminku; ruževi za usne, sjajevi za usne; maskara, olovka za oči, sjenka za oči; preparati za uklanjanje šminke, maramice impregnirane preparatima za uklanjanje šminke; toaletni sapun; talk puder, za toaletnu upotrebu; preparati za njegu noktiju i stopala, uključujući lakove za nokte, sredstva za odstranjivanje laka za nokte, vještački nokti; preparati za njegu kose ne za upotrebu u

medicini, uključujući balzame za kosu, losione za kosu, sprejeve za kosu, gelove, kreme, balzame, pjene, šampone, preparati za ispiranje; farbe za kosu; neutralizatori za minival; preparati za lokne; preparati za ispravljanje kose; preparati za depilaciju; preprati za izbjeljivanje [skidanje boje] za kozmetičku upotrebu; kozmetički preparati za mršavljenje; astringentna kozmetička sredstva.

---

(111) **15136**

(151) 22.02.2021.

(210) Ž-2019-456

(220) 15.11.2019.

(732) Pierre Balmain S.A.S. , 44, rue Francois 1er, 75008, Paris, FR

(540)



(550) I

(740) Miladin Popović, Đoka Miraševića 21/III, 81000, Podgorica

(511) Klasa 9: Aparati naučni, pomorski, geodetski, fotografski, kinematografski, za vaganje, merenje, signalizaciju, kontrolu (inspekciju), spasavanje i nastavu; optički aparati i instrumenti, uključujući naočare, optička sočiva, naočare za sunce, ramove za naočare, futrole za naočare; aparati za snimanje, prenos ili reprodukciju zvuka ili slika; magnetni nosači podataka, diskovi za snimanje; mehanizmi za aparate koji se pokreću novcem; registar kase, računске mašine i oprema za obradu podataka; računari, tableti, navlake za tablet računare, laptop računari, notebook računari, nosivi računari; slušalice; mobilni telefoni; štitnici glave za sport, zaštitne kacige, zaštitne kacige za sport, viziri za kacige.

Klasa 14: Plemeniti metali i njihove legure; nakit, uključujući prstenje, naušnice, narukvice, broševe, lančice, ogrlice, igle, alke od plemenitih metala za ključeve, kopče za nakit, nakit za šešire, perle [nakit]; ukrasne igle; privjesci za ključeve [prstenovi za ključeve sa sitnim ukrasima ili ukrasnim privjescima]; dugmad za manžetne; igle za kravate; drago kamenje, polu-drage kamenje; kutije za nakit, kutije za izlaganje nakita.

Klasa 18: Koža i imitacija kože; kutije od kože ili vještačke kože, kutije za šešire od kože; kožni dodaci za namještaj; torbe (kovrte, kese) od kože, za pakovanje; ručne torbe, torbe za alat, prazne, rančevi, torbe za plažu, torbe za kupovinu na točkićima, torbe za nošenje na jednom ramenu, školske torbe i torbe za nošenje na jednoin ramenu, torbe za nošenje oko pojasa; putne torbe za odjeću; putnički setovi [od kože]; kožni kaiševi; ataše torbe, aktovke; ženske tašne; kozmetičke torbice, prazne; džepni novčanici; novčanici od pletenog metala za kovanice; futrole za kreditne kartice [novčanici]; futrole za ključeve; životinjska koža; putnički koferi i torbe; kišobrani, suncobrani i štapovi za hodanje; bičevi i

sedlarsko remenarski proizvodi; ogrlice, povoci i odjeća za životinje.

Klasa 25: Odjeća, uključujući haljine, suknje, podsuknje, suknja-pantalone, odijela, odijelo sa suknjom, večernja odijela, pantalone, šorceve, bermuda šorceve, gaćice za bebe [donji veš], košulje, bluze, bodi [žensko rublje], radne kombinezone, majice, dukserice, prsluke, jakne [odjeća], kardigane, džemperi / puloveri / džempere [puloveri], pelerine, vindjakne, kapute, gabardene [odjeća]; vodootporna odjeća, krzno [odjeća]; krzneni šalovi, ešarpe za nošenje, šalovi, marame, rukavice [odjeća], kravate, kaiševi [odjeća], kratke čarape, ženske čarape, ženske najlonske čarape, žensko rublje, donji veš, pidžame, kućne haljine, odjeća za kupanje / odijela za plivanje, bademantili, tregeri [naramenice], maske za spavanje; obuća, uključujući cipele, sandale, obuću sa platformom, brodarice cipele, čizme, polu-čizme, papuče; pokrivala za glavu, uključujući šešire, beretke; kape [pokrivala za glavu], maske za spavanje.

Klasa 35: Poslovno upravljanje; komercijalna administracija za licenciranje roba i usluga; poslovno upravljanje; poslovno upravljanje za scenske umjetnike; marketing; organizovanje modnih revija za promotivne svrhe; organizovanje sajмова u komercijalne ili reklamne svrhe; prezentacija proizvoda putem sredstava komunikacije, u svrhu prodaje na malo; on-line reklamiranje na računarskoj mreži; usluge maloprodaje ili veleprodaje robe u radnjama u vezi sa aparatima naučnim, pomorskim, geodetskim, fotografskim, kinematografskim, za vaganje, mjerenje, signalizaciju, kontrolu (inspekciju), spasavanje i nastavu; optičkim aparatima i instrumentima, uključujući naočare, optička sočiva, naočare za sunce, ramove za naočare, futrole za naočare; aparatima za snimanje, prenos ili reprodukciju zvuka ili slika; magnetnim nosačima podataka, diskovima za snimanje; mehanizmima za aparate koji se pokreću novcem; registar kasama, računskim mašinama i opremom za obradu podataka; računarima, tabletima, navlakama za tablet računare, laptop računarima, notebook računarima, nosivim računarima; slušalicama; mobilnim telefonima; štitnicima glave za sport, zaštitnim kacigama, zaštitnim kacigama za sport, vizirima za kacige; plemenitim metalima i njihovim legurama; nakitom, uključujući prstenje, naušnice, narukvice, broševe, lančice, ogrlice, igle, alke od plemenitih metala za ključeve, kopče za nakit, nakit za šešire, perle [nakit]; ukrasnim iglama; privjescima za ključeve [prstenovi za ključeve sa sitnim ukrasima ili ukrasnim privjescima]; dugmadima za manžetne; iglama za kravate; dragim kamenjem, polu-dragim kamenjem; kutijama za nakit, kutijama za izlaganje nakita; kožom i imitacijom kože; kutijama od kože ili vještačke kože, kutijama za šešire od kože; kožnim dodacima za namještaj; torbama (koverte, kese) od kože, za pakovanje; ručnim torbama, torbama za alat, praznim, rančevima, torbama za plažu, torbama za kupovinu na točkićima, torbama za nošenje na jednom ramenu, školskim torbama i torbama za nošenje na jednom ramenu, torbama za nošenje oko pojasa; putnim torbama za odjeću; putničkim setovima [od kože]; kožnim kaiševima; ataše torbama, aktovkama; ženskim tašnarna; kozmetičkim torbicama, praznim; džepniin novčanicima; novčanicima od pletenog metala za kovanice; futrolama za kreditne kartice [novčanicu]; futrolama za ključeve; životinjskom kožom; putničkim koferima i torbama; kišobranima, suncobranima i štapovima za hodanje; bičevima i sedlarsko remenarskim proizvodima; ogrlicama, povocima i odjećom za životinje; odjećom, uključujući haljine, suknje, podsuknje, suknja-pantalone, odijela, odijelo sa suknjom, večernja odijela, pantalone, šorceve, bermuda šorceve, gaćice za bebe [donji veš], košulje, bluze, bodi [žensko rublje], radne kombinezone, majice, dukserice, prsluke, jakne [odjeća], kardigane, džempere / pulovere / džempere [puloveri], pelerine, vindjakne, kapute, gabardene [odjeća]; vodootpornom odjećom, krznom [odjeća]; krznenim šalovima, ešarpama za nošenje, šalovima, maramama, rukavicama [odjeća]; kravata, kaiševima [odjeća],

kratkim čarapama, ženskim čarapama, ženskim najlonskim čarapama, ženskim rubljem, donjim vešom, pidžamama, kućnim haljinama, odjećom za kupanje / odijelom za plivanje, bademantilima, tregerima [naramenice]; maskama za spavanje; obućom, uključujući cipele, sandale, obuću sa platformom, brodarice cipele, čizme, polu-čizme, papuče; pokrivalima za glavu, uključujući šešire, beretke; kapama [pokrivala za glavu], maskama za spavanje; on-line usluge maloprodaje ili veleprodaje robe u vezi sa aparatima naučnim, pomorskim, geodetskim, fotografskim, kinematografskim, za vaganje, mjerenje, signalizaciju, kontrolu (inspekciju), spasavanje i nastavu; optičkim aparatima i instrumentima, uključujući naočare, optička sočiva, naočare za sunce, ramove za naočare, futrole za naočare; aparatima za snimanje, prenos ili reprodukciju zvuka ili slika; magnetnim nosačima podataka, diskovima za snimanje; mehanizmima za aparate koji se pokreću novcem; registar kasama, računskim mašinama i opremom za obradu podataka; računarima, tabletima, navlakama za tablet računare, laptop računarima, notebook računarima, nosivim računarima; slušalicama; mobilnim telefonima; štitnicima glave za sport, zaštitnim kacigama, zaštitnim kacigama za sport, vizirima za kacige; plemenitim metalima i njihovim legurama; nakitom, uključujući prstenje, naušnice, narukvice, broševe, lančice, ogrlice, igle, alke od plemenitih metala za ključeve, kopče za nakit, nakit za šešire, perle [nakit]; ukrasnim iglama; privjescima za ključeve [prstenovi za ključeve sa sitnim ukrasima ili ukrasnim privjescima]; dugmadima za manžetne; iglama za kravate; dragim kamenjem, polu-dragim kamenjem; kutijama za nakit, kutijama za izlaganje nakita; kožom i imitacijom kože; kutijama od kože ili vještačke kože, kutijama za šešire od kože; kožnim dodacima za namještaj; torbama (kovrte, kese) od kože, za pakovanje; ručnim torbama, torbama za alat, praznim, rančevima, torbama za plažu, torbama za kupovinu na točkićima, torbama za nošenje na jednom ramenu, školskim torbama i torbama za nošenje na jednom ramenu, torbama za nošenje oko pojasa; putnim torbama za odjeću; putničkim setovima [od kože]; kožnim kaiševima; ataše torbama, aktovkama; ženskim tašnama; kozmetičkim torbicama, praznim; džepnim novčanicima; novčanicima od pletenog metala za kovanice; futrolama za kreditne kartice [novčanici]; futrolama za ključeve; životinjskom kožom; putničkim koferima i torbama; kišobranima, suncobranima i štapovima za hodanje; bičevima i sedlarsko remenarskim proizvodima; ogrlicama, povocima i odjećom za životinje; odjećom, uključujući haljine, suknje, podsuknje, suknja-pantalone, odijela, odijelo sa suknjom, večernja odijela, pantalone, šorceve, bermuda šorceve, gaćice za bebe [donji veš], košulje, bluze, bodi [žensko rublje], radne kombinezone, majice, dukserice, prsluke, jakne [odjeća], kardigane, džempere / pulovere / džempere [puloveri], pelerine, vindjakne, kapute, gabardene [odjeća]; vodootpornom odjećom, krznom [odjeća]; krznenim šalovima, ešarpama za nošenje, šalovima, maramama, rukavicama [odjeća], kravata, kaiševima [odjeća], kratkim čarapama, ženskim čarapama, ženskim najlonskim čarapama, ženskim rubljem, donjim vešom, pidžamama, kućnim haljinama, odjećom za kupanje / odijelom za plivanje, bademantilima, tregerima [naramenice], maskama za spavanje; obućom, uključujući cipele, sandale, obuću sa platformom, brodarice cipele, čizme, polu-čizme, papuče; pokrivalima za glavu, uključujući šešire, beretke; kapama [pokrivala za glavu], maskama za spavanje.

(111) **15137**

(151) 22.02.2021.

(210) Ž-2020-97

(220) 09.03.2020.

(732) Komercijalna Banka AD Podgorica, Ulica Cetinjska br.11, VI sprat, Kula PC1, Poslovni centar The Capital Plaza, 81000, Podgorica, ME

(540)



(550) I

(511) Klasa 16: Brošure, hemijske olovke, kalendari, flajeri, fascikle, kese, rokovnici, koverta, vizit karte, memorandum, kišobrani, svjeske za pisanje, obavještenja.

Klasa 35: Reklamiranje i oglašavanje; vođenje komercijalnih poslova; komercijalna administracija; kancelarijski poslovi.

Klasa 36: Bankarski poslovi i usluge, depozitni poslovi, usluge depozita u sefovima, sigurnosne blagajne [sefovi], odlaganje u sigurnosne blagajne; kreditni poslovi, krediti, otplata na rate, finansijski poslovi [transakcije], garancije [garancijski poslovi], zalog (davanje zajma uz zalog; monetarni poslovi, novčana sredstva (elektronski prijenos novčanih sredstava), poslovi platnog prometa, devizni poslovi, dugovanje (službe za kartice dugovanja (debit kartice]) izdavanje platnih kartica, kreditne kartice (službe za kreditne kartice), kreditne kartice (izdavanje kreditnih kartica), mjenjački poslovi- mijenjanje novca; finansijski poslovi, finansijske transakcije; poslovi sa hartijama od vrijednosti, brokersko-dilerski poslovi; kupovina, prodaja i naplata potraživanja; poslovi osiguranja - zastupanje u osiguranju, informacije o osiguranju.

Klasa 38: Radio i televizija, elektronske poruke, konferencije na daljinu (omogućavanje vođenja konferencija na daljinu), poruke (prijenos poruka).

---

(111) **15138**

(151) 22.02.2021.

(210) Ž-2020-98

(220) 09.03.2020.

(732) Komercijalna Banka AD Podgorica, Ulica Cetinjska br.11, VI sprat, Kula PC1, Poslovni centar The Capital Plaza, 81000, Podgorica, ME

(540)



(550) I

(511) Klasa 16: Brošure, hemijske olovke, kalendari, flajeri, fascikle, kese, rokovnici, koverta, vizit karte, memorandum, kišobrani, svjeske za pisanje, obavještenja.

Klasa 35: Reklamiranje i oglašavanje; vođenje komercijalnih poslova; komercijalna administracija; kancelarijski poslovi.

Klasa 36: Bankarski poslovi i usluge, depozitni poslovi, usluge depozita u sefovima, sigurnosne blagajne [sefovi], odlaganje u sigurnosne blagajne; kreditni poslovi, krediti, otplata na rate, finansijski poslovi [transakcije], garancije [garancijski poslovi], zalog (davanje zajma uz zalog; monetarni poslovi, novčana sredstva (elektronski prijenos novčanih sredstava), poslovi platnog prometa, devizni poslovi, dugovanje (službe za kartice dugovanja (debit kartice)) izdavanje platnih kartica, kreditne kartice (službe za kreditne kartice), kreditne kartice (izdavanje kreditnih kartica), mjenjački poslovi- mijenjanje novca; finansijski poslovi, finansijske transakcije; poslovi sa hartijama od vrijednosti, brokersko-dilerski poslovi; kupovina, prodaja i naplata potraživanja; poslovi osiguranja - zastupanje u osiguranju, informacije o osiguranju.

Klasa 38: Radio i televizija, elektronske poruke, konferencije na daljinu (omogućavanje vođenja konferencija na daljinu), poruke (prijenos poruka).

---

(111) **15139**

(151) 22.02.2021.

(210) Ž-2020-99

(220) 09.03.2020.

(732) Komercijalna Banka AD Podgorica, Ulica Cetinjska br.11, VI sprat, Kula PC1, Poslovni centar The Capital Plaza, 81000, Podgorica, ME

(540)



(550) I

(511) Klasa 16: Brošure, hemijske olovke, kalendari, flajeri, fascikle, kese, rokovnici, koverta, vizit karte, memorandum, kišobrani, svjeske za pisanje, obavještenja.

Klasa 35: Reklamiranje i oglašavanje; vođenje komercijalnih poslova; komercijalna administracija; kancelarijski poslovi.

Klasa 36: Bankarski poslovi i usluge, depozitni poslovi, usluge depozita u sefovima, sigurnosne blagajne [sefovi], odlaganje u sigurnosne blagajne; kreditni poslovi, krediti,



otplata na rate, finansijski poslovi [transakcije], garancije [garancijski poslovi], zalog (davanje zajma uz zalog; monetarni poslovi, novčana sredstva (elektronski prijenos novčanih sredstava), poslovi platnog prometa, devizni poslovi, dugovanje (službe za kartice dugovanja (debit kartice)) izdavanje platnih kartica, kreditne kartice (službe za kreditne kartice), kreditne kartice (izdavanje kreditnih kartica), mjenjački poslovi- mijenjanje novca; finansijski poslovi, finansijske transakcije; poslovi sa hartijama od vrijednosti, brokersko-dilerski poslovi; kupovina, prodaja i naplata potraživanja; poslovi osiguranja - zastupanje u osiguranju, informacije o osiguranju.

Klasa 38: Radio i televizija, elektronske poruke, konferencije na daljinu (omogućavanje vođenja konferencija na daljinu), poruke (prijenos poruka).

---

(111) **15140**

(151) 22.02.2021.

(210) Ž-2020-100

(220) 09.03.2020.

(732) Komercijalna Banka AD Podgorica, Ulica Cetinjska br.11, VI sprat, Kula PC1, Poslovni centar The Capital Plaza, 81000, Podgorica, ME

(540)



(550) I

(511) Klasa 16: Brošure, hemijske olovke, kalendari, flajeri, fascikle, kese, rokovnici, koverta, vizit karte, memorandum, kišobrani, svjeske za pisanje, obavještenja.

Klasa 35: Reklamiranje i oglašavanje; vođenje komercijalnih poslova; komercijalna administracija; kancelarijski poslovi.

Klasa 36: Bankarski poslovi i usluge, depozitni poslovi, usluge depozita u sefovima, sigurnosne blagajne [sefovi], odlaganje u sigurnosne blagajne; kreditni poslovi, krediti, otplata na rate, finansijski poslovi [transakcije], garancije [garancijski poslovi], zalog (davanje zajma uz zalog; monetarni poslovi, novčana sredstva (elektronski prijenos novčanih sredstava), poslovi platnog prometa, devizni poslovi, dugovanje (službe za kartice dugovanja (debit kartice)) izdavanje platnih kartica, kreditne kartice (službe za kreditne kartice), kreditne kartice (izdavanje kreditnih kartica), mjenjački poslovi- mijenjanje novca; finansijski poslovi, finansijske transakcije; poslovi sa hartijama od vrijednosti, brokersko-dilerski poslovi; kupovina, prodaja i naplata potraživanja; poslovi osiguranja - zastupanje u osiguranju, informacije o osiguranju.

Klasa 38: Radio i televizija, elektronske poruke, konferencije na daljinu (omogućavanje vođenja konferencija na daljinu), poruke (prijenos poruka).

---

(111) **15141**

(151) 22.02.2021.

(210) Ž-2020-101

(220) 09.03.2020.

(732) Komercijalna Banka AD Podgorica, Ulica Cetinjska br.11, VI sprat, Kula PC1, Poslovni centar The Capital Plaza, 81000, Podgorica, ME

(540)



(550) I

(511) Klasa 16: Brošure, hemijske olovke, kalendari, flajeri, fascikle, kese, rokovnici, koverta, vizit karte, memorandum, kišobrani, svjeske za pisanje, obavještenja.

Klasa 35: Reklamiranje i oglašavanje; vođenje komercijalnih poslova; komercijalna administracija; kancelarijski poslovi.

Klasa 36: Bankarski poslovi i usluge, depozitni poslovi, usluge depozita u sefovima, sigurnosne blagajne [sefovi], odlaganje u sigurnosne blagajne; kreditni poslovi, krediti, otplata na rate, finansijski poslovi [transakcije], garancije [garancijski poslovi], zalog (davanje zajma uz zalog; monetarni poslovi, novčana sredstva (elektronski prijenos novčanih sredstava), poslovi platnog prometa, devizni poslovi, dugovanje (službe za kartice dugovanja (debit kartice)) izdavanje platnih kartica, kreditne kartice (službe za kreditne kartice), kreditne kartice (izdavanje kreditnih kartica), mjenjački poslovi- mjenjanje novca; finansijski poslovi, finansijske transakcije; poslovi sa hartijama od vrijednosti, brokersko-dilerski poslovi; kupovina, prodaja i naplata potraživanja; poslovi osiguranja - zastupanje u osiguranju, informacije o osiguranju.

Klasa 38: Radio i televizija, elektronske poruke, konferencije na daljinu (omogućavanje vođenja konferencija na daljinu), poruke (prijenos poruka).

---

(111) **15142**

(151) 23.02.2021.

(210) Ž-2019-522

(220) 31.12.2019.

(732) MULTIFIT Tiernahrungs GmbH, Westpreußenstr. 32-38, 47809, Krefeld, DE

(540)



(550) I

(740) Jasna Jusić, Dalmatinska 2, 81000, Podgorica

(511) Klasa 31: Hrana za životinje; sijeno; kosti za žvakanje; pijesak (piljevina za životinje), posebno ptičji pijesak; piljevina za životinje.

---

(111) **15143**

(151) 23.02.2021.

(210) Ž-2019-523

(220) 31.12.2019.

(732) MULTIFIT Tiernahrungs GmbH, Westpreußenstr. 32-38, 47809, Krefeld, DE

(540)



(550) I

(740) Jasna Jusić, Dalmatinska 2, 81000, Podgorica

(511) Klasa 31: Hrana za životinje; sijeno; kosti za žvakanje; pijesak (piljevina za životinje), posebno ptičji pijesak; piljevina za životinje.

---

(111) **15144**

(151) 23.02.2021.

(210) Ž-2019-520  
(220) 30.12.2019.  
(732) Red Bull GmbH, Am Brunnen 1, 5330, Fuschl am See, AT  
(540)

## OKRIJEPLJUJE DUH I TELO

(550) I

(740) Jasna Jusić, Dalmatinska 2, 81000, Podgorica

(511) Klasa 32: Piva; mineralne vode; gazirane vode; bezalkoholna pića; voćna pića i voćni sokovi; sirupi za proizvodnju pića; bezalkoholni preparati za proizvodnju pića; energetska pića.

---

(111) **15145**  
(151) 23.02.2021.  
(210) Ž-2019-466  
(220) 26.11.2019.  
(732) Curiel Limited, RM 1127, 11/F OCEAN CTR 5 CANTON RD TST KL, HK  
(540)

## CURIEL

(550) I

(740) Jasna Jusić, Dalmatinska 2, 81000, Podgorica

(511) Klasa 3: Šamponi; preparati za veš; omekšivači za pranje veša; sapuni za umivanje; preparati za čišćenje; kreme za proizvode od kože; preparati za struganje; eterična ulja; parfimerija; kozmetika; parfemi; paste za zube; potpuri [mirisi]; mirišljavi štapići; kozmetika za životinje; preparati za osvježavanje vazduha.

Klasa 9: Aparat za mjerenje vremena; detektori lažnog novca; markeri za označavanje na tkaninama; aparati za provjeru poštanskih marki; automatski uređaji za izdavanje karata; faksimil mašine; uređaji za vaganje; mjerači; elektronske oglasne table; mobilni telefoni; kinematografske kamere; detektori; transformatori (struja); kalemovi, električni; kristali galenita [detektori]; optička vlakna (filamenti koji provode svjetlost); video ekrani; uređaji za daljinsko upravljanje; štampana kola; gromobrani; elektrodinamički uređaji za daljinsko upravljanje željezničkim skretnicama; elektrolizatori; aparati za gašenje požara; radiološki uređaji za industrijske svrhe; uređaji za ličnu zaštitu od nesrećnih slučajeva; alarmi; krpa za čišćenje; naočare za sunce; naočare; futrole za naočare; okviri za naočare; lanci za naočare; kutije za naočare; baterije, električne; animirani crtani filmovi; električno grijane čarape; ovoskopi; pametni prstenovi (za obradu podataka); pametne naočare (za obradu podataka); pametni satovi (za obradu podataka); nosivi monitori za video prikaz; stereoskopi; kablovi sa optičkim vlaknima.

Klasa 14: Plemeniti metali, neobrađeni ili poluobrađeni; kutije za nakit; narukvice (nakit); kopče za kravate; bižuterija (nakit od bižutelije); privjesci za nakit; broševi (nakit); nakit; prezentacijske kutije za satove; ručni satovi; satovi.

Klasa 18: Krzno; jareća koža; tašne; ruksaci; prazne kozmetičke torbe, aktovke; aktentašne; torbe za kupovinu; držač za pasoš (koža); putne torbe; putni kovčezi; putne navlake za odijela; kožne navlake za namještaj; kožne trake; džepni novčanici; ručne torbe; mali koferi; koferi; kovčezi [prtljag]; futrole za ključeve; suncobrani; kišobrani; štapovi za hodanje; odjeća za kućne ljubimce.

Klasa 25: Vodootporna odjeća; odjeća; haljine; set odjeće za novorođenčad (odjeća); kupaći kostimi; kostimi za maskenbale; obuća; kape kao pokrivala za glavu; nailon čarape; rukavice (odjevni predmeti); marama; steznici; lente; vjenčalice; frizerski ogrtači; maske za spavanje; kape za tuširanje; vjerska odjeća.

Klasa 26: Čipka za porube; vez; ukrasne vrpce; ukrasi za šešir; broševi (odjevni aksesuar); ukrasi za obuću; ukrasni predmeti za kosu; ukrasi za odjeću; perle, osim za izradu nakita; privjesci, osim za nakit, prstenovi za ključeve ili lanci za ključeve; pričvršćivači za odjeću (dugmad i kopče); dugmad; kopče za kaiš; rajsferšlusi; vještačka kosa; perike; igle; setovi za šivenje; vještačko cvijeće; naramenice za odjeću; ukrasi koji se nanose na tekstilne proizvode putem toplote (krojački predmeti); brojke i slova za obilježavanje tkanina.

Klasa 35: Predstavljanje proizvoda; uređivanje izloga; konsultacije u vezi sa vođenjem poslova; komercijalna administracija u vezi licenciranja roba i usluga za druge; usluge agencija koje se bave uvozom i izvozom; podsticaj prodaje za druge; konsultantsko upravljanje kadrovima; usluge preseljenja za preduzeća; kompjuterizovano upravljanje datotekama; obrada riječi; revizija poslovanja; iznajmljivanje prodajnih štandova; traženje sponzorstava; iznajmljivanje automata; usluge maloprodaje ili veleprodaje farmaceutskih, veterinarskih i sanitarnih preparata i sanitetskog materijala.

---

(111) **15146**

(151) 24.02.2021.

(210) Ž-2019-429

(220) 06.11.2019.

(732) Bausch Health Ireland Limited, 3013 Lake Drive, Citywest Business Campus, Dublin 24, IE

(540)

## SIMELAX

(550) I

(740) Božidar S. Radulović, Baku 30/5, 81000, Podgorica

(511) Klasa 5: Medicinski proizvodi, lijekovi protiv zatvora, proizvodi koji sprečavaju zatvor.

---

(111) **15147**

(151) 24.02.2021.

(210) Ž-2019-430

(220) 06.11.2019.

(732) Bausch Health Ireland Limited, 3013 Lake Drive, Citywest Business Campus, Dublin 24, IE

(540)

## SIMEGAS

(550) I

(740) Božidar S. Radulović, Baku 30/5, 81000, Podgorica

(511) Klasa 5: Medicinski proizvodi, farmaceutski preparati protiv nadimanja, proizvodi koji sprečavaju nadimanje.

---

(111) **15148**

(151) 24.02.2021.

(210) Ž-2019-462

(220) 25.11.2019.

(732) DDP Specialty Electronic Materials US 8, LLC, 974 Centre Road, 19805, Wilmington, Delaware, US

(540)

## SILVADUR

(550) I

(740) Božidar S. Radulović, Baku 30/5, 81000, Podgorica

(511) Klasa 1: Hemikalije za upotrebu u proizvodnji biocida, germicida i fungicida za korištenje u ne-poljoprivrednom sektoru, koje nisu preparati za uništavanje gamadi, insekata ili muva.

Klasa 5: Biocidi, germicidi i fungicidi za korištenje u ne-poljoprivrednom sektoru, koji nisu preparati za uništavanje gamadi, insekata ili muva.

Klasa 24: Tekstil i tekstilni proizvodi koji nisu uključeni u druge klase.

(111) **15149**

(151) 24.02.2021.

(210) Ž-2019-344

(220) 15.09.2014.

(300) EM, broj 12689865 13.03.2014.

(732) VanDutch Holding B.V., Schweitzerlaan 62, 1187 JD , Amstelveen, NL

(540)



(550) I

(740) Miladin Popović, ul. Capital Plaza, ulica šeika Zajeda 13-IV/68, 81000, Podgorica

(511) Klasa 12: Brodovi i jahte i dijelovi i oprema za njih, odnosno njihovi rezervni dijelovi uključeni u ovu klasu; aparati za kretanje po zemlji, vazduhu ili vodi.

Klasa 37: Održavanje i opravka djelova i opreme za brodove i jahte, usluge servisa, opravke i punjenja vozila.

---

(111) **15150**

(151) 24.02.2021.

(210) Ž-2019-485

(220) 10.12.2019.

(732) Foshan Haitian Flavouring & Food Co., Ltd., No.16, Wen Sha Road Foshan City, Guangdong Province, CN

(540)



(550) I

(740) Božidar S. Radulović, Baku 30/5, 81000, Podgorica

(511) Klasa 29: Ulja za ishranu; susamovo ulje za ishranu; jestive masti; suncokretovo ulje za ishranu; repino ulje za ishranu; kukuruzno ulje za ishranu; maslinovo ulje za ishranu; konzervisano povrće; kiseli krastavac; fermentirana zrna pasulja; albumen, bjelančevine, za kulinarske namjene; povrće u konzervi; tahini [namaz od susama];

koncentrati za bujon; namirnice na bazi ribe; jaja; puter; prerađen orah; sušene pečurke; konzervisane pečurke; želatin; obrađeni plodovi areka palme; ekstrakti algi za ishranu; crijeva za kobasice, prirodna ili vještačka.

---

(111) **15151**

(151) 24.02.2021.

(210) Ž-2019-296

(220) 26.07.2019.

(732) International Truck Intellectual Property Company, LLC, 2701 Navistar Drive, IL 60532, Lisle, US

(540)



(550) I

(740) Božidar S. Radulović, Baku 30/5, 81000, Podgorica

(511) Klasa 12: Motorna vozila, naročito kamioni, šasije, i njihovi rezervni dijelovi.

---

(111) **15152**

(151) 24.02.2021.

(210) Ž-2019-343

(220) 15.09.2014.

(300) EM, broj 012689279 od 13.03.2014

(732) VanDutch Holding B.V., Schweitzerlaan 62, 1187 JD , Amstelveen, NL

(540)

VanDutch

(550) I

(740) Miladin Popović, ul. Capital Plaza, ulica šeika Zajeda 13-IV/68, 81000, Podgorica

(511) Klasa 12: Brodovi i jahte i dijelovi i oprema za njih, odnosno njihovi rezervni dijelovi uključeni u ovu klasu; aparati za kretanje po zemlji, vazduhu ili vodi.



Klasa 37: Održavanje i opravka djelova i opreme za brodove i jahte, usluge servisa, opravke i punjenja vozila.

---

(111) **15153**

(151) 24.02.2021.

(210) Ž-2019-173

(220) 25.04.2019.

(300) JP, broj 2018-134287 od 29.10.2018.

(732) Monster Energy Company, a Delaware corporation, 1 Monster Way, 92879, Corona, California, US

(540)

**MONSTER MANGO LOCO**

(550) I

(740) Božidar S. Radulović, Baku 30/5, 81000, Podgorica

(511) Klasa 32: Bezalkoholna pića.

---

(111) **15154**

(151) 24.02.2021.

(210) Ž-2020-112

(220) 18.03.2020.

(300) za klasu 36 broj UK 00003432280 od 27.09.2019. UK,

za klasu 43 broj 2019750377 od 08.10.2019. godine, RU

(732) Raffles International Limited, 1 Wallich Street, #17-01 Guoco Tower, 078881, Singapore, SG

(540)



**RAFFLES**

(550) I

(740) AOD "Ćupić", Bulevar Džordža Vašingtona 79, 81000, Podgorica

(511) Klasa 36: Poslovi sa nekretninama; upravljanje nekretninama; administracija nekretnina; upravljanje apartmanima ili vilama; usluge upravljanja apartmanima, zgradama i stambenim objektima; upravljanje zgradama [usluge nekretnina]; upravljanje stambenim zgradama; upravljanje finansijama i nekretninama za apartmane i smješta, kao što su hoteli, moteli, hotelski kompleksi, apartmani, rezidencijalni hoteli, turistički domovi i druge rezidencijalne zgrade za kuće za odmor i kampove za odmor; prodaja i iznajmljivanje smještaja, apartmana, studio apartmana, soba unutar hotelskih objekata, hotelskih kompleksa, rezidencijalnih hotela i drugih rezidencijalnih zgrada za kuće za odmor i kampove za odmor; iznajmljivanje i upravljanje smještajem za druge; iznajmljivanje nekretnina na bazi tajm-šera; usluge upravljanja i izdavanja nekretnina na bazi tajm-šeringa; usluge pomoći i konsultantske usluge u oblasti nekretnina; upravljanje i vođenje brendirantog smještaja; upravljanje i vođenje apartmanima i vilama za duži boravak sa odgovarajućom opremom i poslugom; iznajmljivanje stanova; iznajmljivanje i pružanje kancelarija, kancelarijskog prostora i radnih prostora za kolektivnu ili individualnu upotrebu; iznajmljivanje i pružanje zajedničkih radnih prostora ili radnih prostora koji se dijele; iznajmljivanje namještenih kancelarija; usluge u području finansiranja preduzeća i projekata.

Klasa 43: Usluge pružanja hrane i pića; privremeni smještaj; usluge hotela i odmarališta, usluge hotelskog smještaja; usluge rezervacija za hotelski smještaj; iznajmljivanje soba, rezervacija i buking privremenih smještaja; rezervacija za duži i kraći boravak u apartmanima i kondominiumima; pružanje prostora za konferencije, usluge banketa; usluge barova, kafea, restorana, usluge koktel barova i kafeterija, usluge spremanja hrane; rezervacije restorana i jela, objekata za bankete i društvena okupljanja za posebne prilike; informacije o hotelima, odmaralištima, smještajima i restoranima, dostupne kroz bazu podataka koja se može pretraživati preko interneta; pružanje web stranice koja sadrži usluge online rezervacije za smještaj u hotelima, pružanje prostora za kongrese i izložbe; usluge čuvanja djece [jaslice]; pružanje online rezervacija i bukinga za privremeno prenoćište i smještaj; rezervacija hotela za druge; rezervacija i buking smještaja u hotelima za druge; informativne, savjetodavne i konsultantske usluge koje se odnose na sve gore navedene usluge; uključujući sve gore navedene usluge koje se pružaju elektronskim putem ili onlajn iz kompjuterske baze podataka ili putem interneta; koje sve usluge su obuhvaćene klasom 43.

---

(111) **15155**

(151) 24.02.2021.

(210) Ž-2020-163

(220) 20.05.2020.

(732) Google LLC, 1600 Amphitheatre Parkway, 94043, Mountain View, California, US

(540)

WAZE

(550) I

(740) AOD "Ćupić", Bulevar Džordža Vašingtona 79, 81000, Podgorica

(511) Klasa 9: Računarski programi i računarski softveri za prikupljanje, kompilaciju, obradu, prenos i distribuciju podataka globalnog sastava za pozicioniranje (GPS) za korištenje na fiksnim, mobilnim i ručnim uređajima; elektronske baze podataka koje sadrže putne, geografske, kartografske i informacije o putovanjima zapisane na računarskim medijima i navigacijski softver za izračunavanje i prikaz ruta; satelitski navigacijski sistemi za automobile, naročito sistem za globalno pozicioniranje (GPS) koji sadrži digitalne kartografske prikaze, interaktivne upute i informacije koje generišu korisnici; interaktivni društveni računarski softver koji pruža putne, navigacijske, geografske, kartografske i informacije o putovanjima; interaktivni društveni računarski softver za omogućavanje prenosa informacija o mapiranju, navigaciji, saobraćaju, vremenu i tačkama interesa na telekomunikacijske mreže, mobilne telefone, navigacijske uređaje i druge mobilne i ručne uređaje; interaktivni društveni računarski softver za omogućavanje razmjene informacija među korisnicima.

Klasa 35: Usluge oglašavanja, marketinga i promotivne usluge.

Klasa 39: Praćenje putničkih i teretnih vozila računarskim putem, preko globalnih sistema za pozicioniranje (GPS); interaktivno i društveno online usmjeravanje vozila putem računarskih i podatkovnih mreža; pružanje putnih, geografskih, putničkih, kartografskih, navigacijskih, saobraćajnih informacija te informacija o geografskim interesnim tačkama putem telekomunikacijskih mreža, mobilnih telefona, ručnih uređaja i bežičnih navigacijskih uređaja; pružanje interaktivne online baze podataka koja sadrži putne, geografske, putničke, kartografske, navigacijske, saobraćajne i informacije o geografskim tačkama interesa.

Klasa 42: Naučno istraživanje i razvoj, naročito razvoj algoritama i računarskih metoda za obradu i optimizaciju podataka o navigaciji i putovanjima; naučno istraživanje i razvoj, naročito razvoj algoritama i računarskih metoda za obradu i optimizaciju podataka dobojenih od sistema za globalno pozicioniranje (GPS) i komunikacijskih mreža; projektovanje i razvoj navigacijskih softvera i softvera za planiranje puta; interaktivne društvene navigacijske usluge, naročito pružanje mrežne stranice koja sadrži tehnologiju koja omogućava razmjenu među korisnicima informacija u vezi sa putem, saobraćajem, geografijom, navigacijom, geografskim tačkama interesa, mapiranjem, vremenom te putničkim informacijama; organizovanje online prostora za vođenje interaktivnih rasprava; naučne, tehnološke, istraživačke i usluge projektovanja u vezi sa telekomunikacijama i navigacijskim signalima, naročito projektovanje i razvoj telekomunikacijskog i navigacijskog softvera i opreme.

---

(111) **15156**

(151) 25.02.2021.

(210) Ž-2020-252

(220) 16.07.2020.

(732) DOO "Golden Investment Group", Dobrota, Kotor, ME

(540)

The logo for Palazzo del Mare is written in a blue, cursive script. The word 'Palazzo' is in a standard cursive, while 'del Mare' is more fluid and includes a decorative flourish that loops under the 'e'.

(550) I

(511) Klasa 35: Usluge upravljanja hotelima za druge; usluge franšiznog poslovanja sa hotelima; usluge poslovnog savjetovanja i konsultovanja u vezi sa upravljanjem, radom i franšiznim poslovanjem hotela, poslovno upravljanje hotelima i drugim smještajnim kapacitetima; usluge reklamiranja hotela i nekretnina; vodjenje programa vjernosti klijenata i podsticaja; promotivne usluge u oblasti programa vjernosti klijenata i podsticaja.

Klasa 43: Usluge hotela, smještaja i privremenog smještaja; usluge pružanja informacija o hotelima, smještajima i privremenom smještaju; usluge rezervisanja hotela, smještaja i privremenog smještaja; usluge restorana, bara, koktel bara, kafea, kafica i snek bara; usluge kejtteringa za snabdijevanje hranom i pićem; usluge rezervacije restorana; obezbjedjivanje objekata za održavanje konferencija, sastanaka, događaja, konvencija i izložbi, iznajmljivanje stolica, stolova, stolnjaka i čaša.

---

(111) **15157**

(151) 25.02.2021.

(210) Ž-2020-253

(220) 16.07.2020.

(732) DOO "Golden Investment Group" , Dobrota, Kotor, ME

(540)

The logo for ESSENZA is the word 'ESSENZA' in a bold, orange, sans-serif font. The letters are slightly shadowed, giving it a 3D effect.

(550) I

(511) Klasa 35: Usluge upravljanja hotelima za druge; usluge franšiznog poslovanja sa hotelima; usluge poslovnog savjetovanja i konsultovanja u vezi sa upravljanjem, radom i franšiznim poslovanjem hotela, poslovno upravljanje hotelima i drugim smještajnim kapacitetima; usluge reklamiranja hotela i nekretnina; vodjenje programa vjernosti klijenata i podsticaja; promotivne usluge u oblasti programa vjernosti klijenata i podsticaja.

Klasa 43: Usluge hotela, smještaja i privremenog smještaja; usluge pružanja informacija o hotelima, smještajima i privremenom smještaju; usluge rezervisanja hotela, smještaja i privremenog smještaja; usluge restorana, bara, koktel bara, kafea, kafica i snek bara; usluge kejtteringa za snabdijevanje hranom i pićem; usluge rezervacije restorana; obezbjedjivanje objekata za održavanje konferencija, sastanaka, događaja, konvencija i izložbi, iznajmljivanje stolica, stolova, stolnjaka i čaša.

(111) **15158**

(151) 25.02.2021.

(210) Ž-2019-492

(220) 13.12.2019.

(732) NOVA BRANDS S.A., 24, avenue Emile Reuter, 2420, Luxembourg, LU

(540)

## Novalac Premium Symbiotic

(550) I

(740) AOD "Lutovac & partneri", Bulevar Ivana Crnojevića 93, 81000, Podgorica

(511) Klasa 5: Dijetetske supstance za medicinsku upotrebu; dijetetski dodaci ishrani za upotrebu u medicinske svrhe; hrana za bebe u svim oblicima; dijetetska hrana i supstance za djecu; mliječna formula za bebe.

---

(111) **15159**

(151) 25.02.2021.

(210) Ž-2019-388

(220) 11.10.2019.

(732) BGP Products Operations GmbH, Turmstrasse 24, 6321, Steinhausen, CH

(540)

## Diaclide

(550) I

(740) Miladin Popović, Đoka Miraševića 21/III, 81000, Podgorica

(511) Klasa 5: Farmaceutski proizvodi; lijekovi; medicinski preparati, naime, antidijabetici.

---

(111) **15160**

(151) 25.02.2021.

(210) Ž-2019-481

(220) 09.12.2019.

(732) FCA US LLC, 1000 Chrysler Drive, 48326, Auburn Hills, Michigan, US

(540)

## 4XE

(550) I

(740) Miladin Popović, Đoka Miraševića 21/III, 81000, Podgorica

(511) Klasa 12: Mašine za vozila po zemlji; motori za vozila po zemlji.

---

(111) **15161**

(151) 25.02.2021.

(210) Ž-2019-463

(220) 26.11.2019.

(732) Cadbury UK Limited, P.O. Box 12, Bournville Lane, Bournville, B30 2LU, Birmingham, GB

(540)

## CADBURY BOOST

(550) I

(740) Miladin Popović, ul. Capital Plaza, ulica šeika Zajeda 13-IV/68, 81000, Podgorica

(511) Klasa 30: Kakao; napici na bazi kakaa i čokolade i preparati za pravljenje takvih napitaka; čokolada, konditorski proizvodi, posebno čokoladne poslastice; konditorski šećer; biskviti, vafli, kolači, peciva; pekarski proizvodi; polugotovi proizvodi od tijesta za pečenje; preparati od žitarica; jestivi led, naime proizvodi od sladoleda; smrznute poslastice; čokoladni deserti; deserti od sladoleda; gotovi deserti (konditorski proizvodi); rashlađene poslastice; rashlađeni deserti, naime čokoladni deserti, deserti od sladoleda, gotovi deserti (konditorski proizvodi); čokoladni namazi.

---

(111) **15162**

(151) 25.02.2021.

(210) Ž-2020-169

(220) 26.05.2020.

(732) ALLIANCE D.O.O., CETINJSKI PUT BB, 81000, PODGORICA, ME

(540)

## Brandy Goren

(550) I

(511) Klasa 33: Vina (alkoholna pića).  
Klasa 35: Maloprodaja: vina; Veleprodaja: vina.  
Klasa 41: Učestvovanje na sajmovima.

---

(111) **15163**  
(151) 25.02.2021.  
(210) Ž-2020-170  
(220) 26.05.2020.  
(732) ALLIANCE D.O.O., CETINJSKI PUT BB, 81000, PODGORICA, ME  
(540)

Vinarija Pavićević

(550) I

(511) Klasa 33: Vina (alkoholna pića).  
Klasa 35: Maloprodaja: vina; Veleprodaja: vina.  
Klasa 41: Učestvovanje na sajmovima.

---

(111) **15164**  
(151) 25.02.2021.  
(210) Ž-2020-171  
(220) 26.05.2020.  
(732) ALLIANCE D.O.O., CETINJSKI PUT BB, 81000, PODGORICA, ME  
(540)

Vino Katardo

(550) I

(511) Klasa 33: Vina (alkoholna pića).  
Klasa 35: Maloprodaja: vina; Veleprodaja: vina.  
Klasa 41: Učestvovanje na sajmovima.

---

(111) **15165**

(151) 25.02.2021.

(210) Ž-2019-280

(220) 12.07.2019.

(732) Pharmaceutical chemical cosmetic industry ALKALOID AD Skopje, Blvd. Aleksandar Makedonski 12, 1000, Skopje, MK

(540)

## PYNETRA

(550) I

(740) Miladin Popović, ul. Capital Plaza, ulica šeika Zajeda 13-IV/68, 81000, Podgorica

(511) Klasa 5: farmaceutski preparati.

---

(111) **15166**

(151) 25.02.2021.

(210) Ž-2020-126

(220) 21.04.2020.

(732) Allied Beverages Adriatic d.o.o., Batajnički drum 18, Zemun, 11080, Beograd, RS

(540)



(550) I

(740) Miladin Popović, Đoka Miraševića 21/III, 81000, Podgorica

(511) Klasa 32: Bezalkoholni napici, uključujući vode za piće, izvorsku vodu, vode sa ukusom, mineralne i gazirane vode; bezalkoholna pića, energetska pića i pića za sportiste; voćna pića i sokovi uključujući kokosovu vodu; i drugi bezalkoholni napici uključujući sirupe, koncentrate, praškove i druge preparate za pripremu napitaka

---

(111) **15167**

(151) 26.02.2021.

(210) Ž-2019-464



(220) 26.11.2019.

(732) Cadbury UK Limited, P.O. Box 12, Bournville Lane, Bournville, B30 2LU,  
Birmingham, GB

(540)

## CADBURY BRUNCH BAR

(550) I

(740) Miladin Popović, ul. Capital Plaza, ulica šeika Zajeda 13-IV/68, 81000, Podgorica

(511) Klasa 30: Kakao; napici na bazi kakaa i čokolade i preparati za pravljenje takvih napitaka; čokolada, konditorski proizvodi, posebno čokoladne poslastice; konditorski šećer; biskviti, vafli, kolači, peciva; pekarski proizvodi; polugotovi proizvodi od tijesta za pečenje; preparati od žitarica; jestivi led, naime proizvodi od sladoleda; smrznute poslastice; čokoladni deserti; deserti od sladoleda; gotovi deserti (konditorski proizvodi); rashlađene poslastice; rashlađeni deserti, naime čokoladni deserti, deserti od sladoleda, gotovi deserti (konditorski proizvodi); čokoladni namazi.

---

(111) **15168**

(151) 26.02.2021.

(210) Ž-2019-465

(220) 26.11.2019.

(732) Cadbury UK Limited, P.O. Box 12, Bournville Lane, Bournville, B30 2LU,  
Birmingham, GB

(540)

## CADBURY PICNIC

(550) I

(740) Miladin Popović, Đoka Miraševića 21/III, 81000, Podgorica

(511) Klasa 30: Kakao; napici na bazi kakaa i čokolade i preparati za pravljenje takvih napitaka; čokolada, konditorski proizvodi, posebno čokoladne poslastice; konditorski šećer; biskviti, vafli, kolači, peciva; pekarski proizvodi; polugotovi proizvodi od tijesta za pečenje; preparati od žitarica; jestivi led, naime proizvodi od sladoleda; smrznute poslastice; čokoladni deserti; deserti od sladoleda; gotovi deserti (konditorski proizvodi); rashlađene poslastice; rashlađeni deserti, naime čokoladni deserti, deserti od sladoleda, gotovi deserti (konditorski proizvodi); čokoladni namazi.

---

(111) **15169**

(151) 26.02.2021.

(210) Ž-2020-71

(220) 26.02.2020.

(732) MARSENIĆ D.O.O. KOTOR, KAVAČ B.B., Kotor, ME

(540)



(550) I

(511) Klasa 43: Usluge obezbjeđivanja hrane i pića; privremeno primanje na stan; usluge koje pružaju lica ili preduzeća čiji cilj je priprema jela ili pića za potrošnju kao i usluge ishrane i smještaja, koje pružaju hoteli, pansioni ili druga preduzeća koja osiguravaju privremeni smještaj; usluge rezervisanja smještaja za putnike, koje pružaju putničke agencije ili posrednici; usluge pansiona za životinje.

---

(111) **15170**

(151) 26.02.2021.

(210) Ž-2019-311

(220) 15.08.2019.

(732) Nobel Quest International Limited, P.O.BOX 3152, Road Town, Tortola, VG

(540)

HUNN

(550) I

(740) Dejan Raičević, Vojvode Boža br.1, 81250, Cetinje

(511) Klasa 9: Baterije za elektronske cigarete; baterije za elektronske uređaje koji se koriste za zagrevanje i paljenje duvana; punjači za elektronske uređaje koji se koriste za zagrevanje i paljenje duvana; USB punjači za elektronske uređaje koji se koriste za zagrevanje i paljenje duvana; auto punjači za elektronske cigarete; auto punjači za uređaje koji se koriste za zagrevanje i paljenje duvana; punjači za baterije za elektronske cigarete. Klasa 34: Duvan; aritkli za pušače; šibice; cigarete; kutije za cigarete; filteri za cigarete; muštikle; papir za cigarete; usnici za cigarete; usnici za muštikle; lule; cigarilos; cigare; pepeljare za pušače; upaljači za pušače.

---

(111) **15171**

(151) 26.02.2021.

(210) Ž-2019-412

(220) 29.10.2019.

(732) DRUŠTVO ZA PROIZVODNJU I PROMET KOZMETIKE LABORATORIJA DOKTOR PAVLOVIĆ, MILŠEVSKA 23, 11000, BEOGRAD, RS

(540)



(550) I

(740) Dejan Raičević, Vojvode Boža br.1, 81250, Cetinje

(511) Klasa 3: Kreme za lice i tijelo, posebno za bebe i decu.

Klasa 5: Farmaceutski proizvodi, masti za medicinsku upotrebu.

Klasa 44: Medicinska i higijenska pomoć i usluge u vezi sa njegom lepote.

---

(111) **15172**

(151) 26.02.2021.

(210) Ž-2019-480

(220) 09.12.2019.

(732) Nobel Quest International Limited, P.O. BOX 3152, Road Town, Tortola, VG

(540)

**CHAUFFE**

(550) I

(740) Dejan Raičević, Vojvode Boža br.1, 81250, Cetinje

(511) Klasa 34: Duvan; aritkli za pušače; šibice; cigarete; kutije za cigarete; filteri za cigarete; muštikle; papir za cigarete; usnici za cigarete; usnici za muštikle; lule; cigarilosi; cigare; pepeljare za pušače; upaljači za pušače.

---

(111) **15173**

(151) 26.02.2021.

(210) Ž-2020-173

(220) 26.05.2020.

(732) TOYOTA JIDOSHA KABUSHIKI KAISHA (also trading as TOYOTA MOTOR CORPORATION), 1, Toyota-cho, Toyota-shi, Aichi-ken, JP

(540)

## AYGO X

(550) I

(740) Jasna Jusić, Dalmatinska 2, 81000, Podgorica

(511) Klasa 12: Automobili i njihovi strukturalni djelovi.

---

(111) **15174**

(151) 26.02.2021.

(210) Ž-2020-180

(220) 04.06.2020.

(732) TOYOTA JIDOSHA KABUSHIKI KAISHA (also trading as TOYOTA MOTOR CORPORATION), 1, Toyota-cho, Toyota-shi, Aichi-ken, JP

(540)

## BZ SERIES

(550) I

(740) Jasna Jusić, Dalmatinska 2, 81000, Podgorica

(511) Klasa 12: Automobili i njihovi strukturalni djelovi.

---

(111) **15175**

(151) 26.02.2021.

(210) Ž-2020-48

(220) 21.02.2020.

(732) Obshestvo s Ogranichennoy Otvetstvennostyu "Parapharm" (Parapharm LLC)., ul.Sverdlova, build. 4, 440026, Penza, RU

(540)



(550) I

(740) Dejan Raičević, Vojvode Boža br.1, 81250, Cetinje

(511) Klasa 5: farmaceutski preparati; dodaci ishrani za ljude i životinje; biološki aktivini dodaci ishrani; mineralani dodaci i aditivi za hranu; dijetetska hrana prilagođena za medicinske namene; dijetetske supstance prilagođene za medicinsku upotrebu; tečni dijetetski dodaci ishrani za medicinsku upotrebu; dodaci ishrani; dijetetski dodaci ishrani; enzimi kao dodaci ishrani; biljni dodaci ishrani; mineralni dodaci ishrani; ne-medicinski farmaceutski preparati, odnosno prirodni biljni dodaci ishrani, homopatski dodaci ishrani; nutraceutici kao dijetetski dodaci.

---

(111) **15176**

(151) 26.02.2021.

(210) Ž-2020-201

(220) 11.06.2020.

(732) Colgate-Palmolive Company (a Delaware corporation), 300 Park Avenue, 10022, New York, New York, US

(540)

## PALMOLIVE

(550) I

(740) Jasna Jusić, Dalmatinska 2, 81000, Podgorica

(511) Klasa 5: Antibakterijski sapun, sredstva za dezinfekciju ruku, dezinfekciona sredstva za čišćenje, antibakterijske maramice.

---

(111) **15177**

(151) 26.02.2021.

(210) Ž-2019-352

(220) 12.09.2019.

(732) Domaća trgovina doo Podgorica, Ul.Josipa Broza Tita br.23a, 81000, Podgorica,  
ME  
(540)

## City

(550) I

(511) Klasa 3: Nemedicinska kozmetika i toaletni preparati; nemedicinska sredstva za čišćenje zuba; parfimerijski proizvodi, etarska ulja; sredstva za beljenje i druge supstance za upotrebu u perionicama; preparati za čišćenje, poliranje, ribanje i abrazivni preparati.

Klasa 16: Hartija i karton; štampane stvari; knjigovezački materijal; fotografije; kancelarijski materijal i kancelarijski pribor, osim nameštaja; lepkovi za kancelarijske i kućne potrebe; materijali za crtanje i materijali za umetnike; kičice; materijali za obuku i nastavu; plastični omotači, folije i kese za umotavanje i pakovanje; štamparska slova, klišeji.

Klasa 29: Meso, riba, živina i divljač; mesni ekstrakti; konzervisano, zamrznuto, sušeno i kuvano voće i povrće; želei, džemovi, kompoti; jaja; mleko, sir, puter, jogurt i drugi mlečni proizvodi; ulja i masti za ishranu.

Klasa 30: Kafa, čaj, kakao i zamena kafe; pirinač, testenina i rezanci;; tapioka i sago; brašno i proizvodi od žitarica; hleb, peciva i konditorski proizvodi; čokolada;; sladoledi, sorbei i drugi jestivi led;; šećer, med, melasa; kvasac, prašak za pecivo; so, dodaci jelima, začini, konzervisano začinsko bilje;; sirće, sosovi i drugi dodaci jelu;; led (zamrznuta voda).

Klasa 31: Sirovi i neprerađeni poljoprivredni, akvakulturni, hortikulturni i šumarski proizvodi; sirovo i neprerađeno zrnevlje i semenje; sveže voće i povrće, sveže začinsko bilje; prirodne biljke i cveće; cvetne lukovice, sadnice i seme za sadnju; žive životinje; hrana i pića za životinje; slad.

Klasa 32: Pivo; bezalkoholni napici; mineralne i sodne vode; voćni napici i voćni sokovi; sirupi i drugi bezalkoholni preparati za pravljenje napitaka..

Klasa 33: Alkoholna pića, izuzev piva; alkoholni preparati za pravljenje napitaka..

Klasa 35: Oglašavanje; vođenje poslova; poslovno upravljanje; kancelarijski poslovi.

Klasa 43: Usluge obezbeđivanja hrane i pića; privremeni smeštaj.

---

(111) **15178**

(151) 26.02.2021.

(210) Ž-2019-425

(220) 05.11.2019.

(732) Domaća trgovina doo Podgorica, Ul.Josipa Broza Tita br.23a, 81000, Podgorica,  
ME  
(540)

## SVE ZA TEBE

(550) I

(740) Goran Živković, ul. Petra Zvicera br.11, Podgorica

(511) Klasa 3: Bademovo ulje; bademov sapun; štirak za sjaj veša; štirak za pranje veša; štirak za veš; sapun\*; sapun za izbeljivanje tekstila; plavilo za veš; etarsko ulje anisa; kozmetički preparati za kupanje sapun za brijanje; vatirani štapići za kozmetičke svrhe; pamučni štapići za kozmetičku upotrebu; kozmetičke maske; bergamot ulje; soli za izbeljivanje soda za izbeljivanje belila za veš; mirišljivo drvo; preparati za ispiranje usta, koji nisu medicinski; lak za nokte; preparati za šminkanje; losioni za kosu\*; kreme za cipele; boje za kosu; preparati za kovrdžanje kose; preparati za čišćenje, poliranje; preparati za poliranje; vosak za cipele; sredstva za poliranje nameštaja i podova; preparati za sjaj [poliri]; obučarski vosak; vosak za parket; vosak za poliranje; etarska ulja limuna; kolonjska voda; boje za toaletnu upotrebu; preparati za zaštitu kože [poliranje]; preparati za očuvanje kože [poliranje]; kozmetički setovi; kozmetika; pamučna vuna za kozmetičku upotrebu; kreda za čišćenje; preparati za uklanjanje mrlja; kozmetičke olovke; kreme za poliranje; kozmetičke kreme; soda za pranje, čišćenje; paste za brijanje; kreme za kožne proizvode; vosak za kožne proizvode; deterdženti, koji nisu za upotrebu u proizvodnim procesima i za medicinsku upotrebu; rastvori za čišćenje; proizvodi za odmašćivanje, koji nisu za upotrebu u procesu proizvodnje; preparati za uklanjanje šminke sredstva za čišćenje zuba [paste, gelovi, tečnosti]\*; preparati za uklanjanje kamenca za upotrebu u domaćinstvu; dijamantin, boraks [arbaziv] antistatički preparati za kućnu upotrebu; preparati za uklanjanje laka; preparati za uklanjanje boje odstranjivači laka; mirišljave vode; toaletne vode; preparati za depilaciju; vosak za depilaciju; preparati za natapanje u perionicama; etarske esencije; etarska ulja; etarska ulja; ekstrakti cveća [parfemi]; šminka; preparati za čišćenje; baze za cvetne parfeme; fumigacijska sredstva [parfemi]; arome za kolače [etarska ulja]; ulja za kozmetičku upotrebu; jasminovo ulje; ulje od lavande; ulja za čišćenje; ulja za parfeme i mirise; ružino ulje; toaletna ulja; losioni za kozmetičku upotrebu; mleko za čišćenje za toaletnu upotrebu; preparati za pranje; toaletni proizvodi [sredstva za ličnu higijenu]\*; preparati za štirkanje; mirisna menta [etarsko ulje]; menta za parfimerijske proizvode kozmetika za obrve; šamponi\*; parfemi; preparati za negu noktiju; parfimerija; kozmetički preparati za negu kože; sapun protiv znojenja nogu; kamen za poliranje; pomade za kozmetičku upotrebu; puder za šminkanje; preparati za brijanje; dezodorantni sapun; kesice sa mirisom za rublje; safrol; komadi toaletnog sapuna; komadi sapuna; olovke za izvlačenje obrva; talk puder, za toaletnu upotrebu; kozmetičke boje; krpe za poliranje; stakleno platno [abrazivno platno]; preparati protiv znojenja; sapun protiv znojenja; tripoli kamen za poliranje; abrazivi; bademovo mleko za kozmetičku upotrebu; preparati za uklanjanje rđe; preparati za sunčanje [kozmetički]; aromatična ulja [etarska ulja]; arome za pića [etarska ulja]; hemikalije za osvežavanje boja za upotrebu u domaćinstvu [pranje veša]; soli za kupanje koje nisu za medicinsku upotrebu; kozmetički preparati; preparati za uklanjanje boja; dezodoransi za ljude ili životinje; dekorativne nalepnice za kozmetičku upotrebu; astringentna sredstva; preparati za beljenje [skidanje boje] za kozmetičku upotrebu; oplemenjivači rublja za upotrebu u perionicama; preparati za otčepeljivanje odvodnih cevi; šamponi za kućne ljubimce [nemedicinski preparati za negu]; maramice natopljene sa kozmetičkim losionima; sredstva za lepljenje za kozmetičku upotrebu; losioni posle brijanja; lakovi za kosu; maskare; potpuri [mirisi]; sprejevi za osvežavanje daha; preparati za hemijsko čišćenje; odstranjivači voska sa poda [sredstva za odstranjivanje]; neklizajući vosak za podove; neklizajuće tečnosti za podove; vazduh konzerviran pod pritiskom, za čišćenje i uklanjanje prašine; gelovi za izbeljivanje zuba; krpe namočene deterdžentom za čišćenje; preparati za sjaj; lišća biljaka; mirisni štapići; sredstva za sušenje sudova u mašinama za sudove; preparati za parfimisanje vazduha; trake za osvežavanje daha; dezodoransi za kućne ljubimce; preparati za tuširanje za ličnu higijenu i dezodorisanje

[toaletni proizvodi]; preparati od aloe vere za kozmetičke namene; sjajevi za usne; balzami, osim za medicinske svrhe; šamponi za suvo pranje\*; preparati za sunčanje; etarsko ulje limuna kana [kozmetička boja]; sredstva za čišćenje obuće; preparati za kupanje, ne za medicinske svrhe; balzami za kosu; proizvodi za ispravljanje kose; maramice natopljene preparatima za skidanje šminke; preparati kolagena za kozmetičke svrhe; trake za izbeljivanje zuba; arome za hranu [etarska ulja]; fitokozmetički preparati; sredstva za čišćenje za intimnu ličnu higijenu, nemedicinska; biljni ekstrakti za kozmetičke namene; sredstva za odstranjivanje laka za nokte; sredstva za uklanjanje laka za nokte; vosak za podove; šamponi za životinje [nemedicinski preparati za negu]; sredstva za ispiranje očiju, ne za medicinske namene; sredstva za vaginalno ispiranje za ličnu higijenu ili dezodorisanje; hemijski preparati za čišćenje za upotrebu u domaćinstvu; raspršivači od trske za osvežavanje vazduha; preparati za beljenje [uklanjanje boja] za upotrebu u domaćinstvu; kozmetika za decu; preparati za osvežavanje daha za ličnu higijenu; maramice za bebe natopljene preparatima za čišćenje; basma [kozmetička boja]; gel jastučići za oči za kozmetičke namene.

Klasa 16: Nosači lepljivih traka [kancelarijski pribor]; papir; posteri; oglasni panoi od papira ili kartona; spajalice [kancelarijski pribor]; klipse za olovke heftalice [kancelarijski rekvizit]; beležnice, notesi; albumi; slike; štampani materijal [viskoka štampa]; trake za cigare, za uvijanje cigareta; mašine za oštrenje olovaka, elektronske ili neelektronske podupirači za knjige; vodene boje [slikarske]; vodene boje, slikarske; akvarel boje; fascikle za spise [kancelarijski pribor]; tablice za pisanje; pisaljke za tablice; srebrni papir; olovke; novine; periodične publikacije; atlas; uložne mape sa prstenovima; registratori sa prstenovima; gumirane trake [kancelarijski materijal]; podmetači za pivske čaše; ulaznice; kliše; blokovi za crtanje blokovi [kancelarijski materijal]; klemi za trake sa mastilom; manžetne za držanje pribora za pisanje; pamfleti; špenadle kao kancelarijski materijal; čiode kao kancelarijski materijal; ovlaživači vrhova prstiju [kancelarijski pribor]; jastučići za mastilo; vosak za pečačenje; sveske; obrasci za precrtavanje; paus papir; štamparska slova; karbon papir; papir za mašine za snimanje; beležnice; ugaoni lenjiri za crtanje; karte; materijal za obuku [izuzev aparata]; listovi papira [kancelarijski] karton; tube od kartona; katalozi; metalni vrh za indeksne karte; spojeni ramovi [štamparski]; omoti za papir; košuljice za spise; brojevi [štamparski]; indijsko mastilo; fascikle [kancelarijski materijal]; bušilice za papir [zumba]; higijenski papir; toalet papir; knjige; šestari za crtanje; štamparski brojevi i slova; slova, štamparska; kompozeri za slaganje; posude za pisma; konusne papirne kese; korektivna tečnost [kancelarijski rekvizit]; korektivno mastilo[heliografsko]; grafitne mine za olovke; kreda za pisanje; držači olovaka; olovke sa grafitnom minom [tehničke olovke]; papirne kutije za krem; table za crtanje; materijali za crtanje; instrumenti za crtanje; kutije za olovke; proizvodi za brisanje; materijali za pisanje; štitnici za brisanje; gumice za brisanje; elektrokardiografski papir; probadači [kancelarijski materijal]; mastilo; mastiljave trake; fotografije [štampane]; brisači za naliv pera; pečati; knjigovodstvene knjige; indeks registri; formulari [štampani]; kancelarijski materijal, izuzev nameštaja; štampani rokovnici; ovlaživači za lepljenje koverti [kancelarijski rekviziti]; dopisnice, razglednice; štampane stvari; pribor za ručno lepljenje nalepnica; štampane publikacije priručnici; papir za pisanje; pritiskači za papir; igle za kopiranje za crtačke svrhe; olovke za crtanje; stolnjaci od papira; knjižice; svetleći papir; pelir papir za kopije [kancelarijski materijal]; maramice od papira; indigo papir za umnožavače; prekrivači stolova od papira; spajalice; kancelarijski materijal i kancelarijski pribor, osim nameštaja; pergament; pastelne bojice [krede u boji]; postolja za fotografije; nalivpera; omoti za saksije od papira; aparati i mašine za umnožavanje dokumenata; papirne trake i kartice za beleženje kompjuterskih programa; prospekti; naliv



pera i hemijske olovke [kancelarijski pribor]; vrećice [koverta, kese] od papira ili plastike, za pakovanje; školska oprema [sveske i pribor za pisanje]; markeri za knjige čestitke, razglednice; lepak za papir ili upotrebu u domaćinstvu; lepljive trake za papir ili upotrebu u domaćinstvu; lepljive vrpce za papir ili upotrebu u domaćinstvu; kalendari; slikarske četkice; samolepljive trake za papir ili upotrebu u domaćinstvu; gumice [elastične trake] za kancelarije; portikle od papira; table od drvene pulpe [kancelarijske]; papir od pulpe, drvene mase papirne ili kartonske kutije; postolja za pera i olovke; ambalaža za flaše od papira ili kartona; podmetači za čaše od papira; plastična, mehurasta ambalaža za pakovanje ili umotavanje; lepak za kancelarijsku ili kućnu upotrebu; lepkovi za kancelarijsku ili upotrebu u domaćinstvu; noževi za papir [za otvaranje pisama]; vreće za đubre [od papira ili plastike]; zarezaci za olovke, elektronski i neelektronski; papirne maramice za uklanjanje šminke; stone salvete od papira; podmetači od papira; ugaonici za crtanje; T-lenjiri za crtanje; držači za olovke; nesereri sa priborom za pisanje; omotači za flaše od kartona ili papira; plakati od papira ili kartona; ubrusi od papira; ubrusi za lice od papira; etikete od papira ili kartona; viskozni papir za umotavanje, ukrasni papir; sredstva za lepljenje za papire ili upotrebu u domaćinstvu; vreće za mikrotalasno kuvanje; papirni filteri za kafu; plastična tanka rastegljiva folija za obavljanje paleta; natpisi od papira ili kartona; nalepnice [kancelarijski pribor]; papir za kopiranje; muzičke čestitke, razglednice bilteni; plastifikatori dokumenata za kancelarijsku upotrebu; brisači za table za pisanje; pločice sa hvataljkom za listove papira; papirne mašine, koje nisu pozamanterija i ukrasi za kosu; upijajuće folije od papira ili plastike za pakovanje hrane; folije od papira ili plastike za održavanje vlage za pakovanje hrane; korektorske trake [kancelarijski pribor]; posudice za boje; markeri [pisači pribor]; letci, flajeri; držači spisa, dokumenata [kancelarijski pribor]; držači stranica knjiga; papirni i kartonski materijali za pakovanje [punjenje, oblaganje]; ispunja od papira ili kartona; vaučeri; plastične kese za odlaganje životinjskog izmeta; vaši [japanski papir]; nadstolnjaci od papira; štampane muzičke partiture; transparenti [baneri] od papira; navlake za kartice sa imenom; jo jo držači kartica sa imenom [kancelarijski pribor]; kopče za navlake za kartice sa imenom [kancelarijski pribor]; portikle sa rukavima, papirne sekači papira [kancelarijski pribor]; šabloni za ukrašavanje hrane i napitaka; bedževi sa imenom [kancelarijski pribor]; trake za bar kodove šljokice za kancelarijsku upotrebu; maramice od papira za čišćenje.

Klasa 29: Kulinarske namene ekstrakti algi za ishranu želatin\*; jestive masti; incuni, neživi; kikiriki puter; puter; kakao puter za ishranu; kokosov puter; puter krem; belance od jaja; kobasice krvavice; goveđa supa; goveđa supa, bujon; preparati za pravljenje bujona; kavijar; voće, konzervisano; suhomesnati proizvodi; čips od krompira; listići od krompira; kiseli kupus; kokos, osušeni; ulje repice za ishranu; repino ulje za ishranu; koncentracije za goveđu supu; koncentracije za bujon; džemovi; zaleđeno voće; supe; suvo grožđe; krastavčići; konzervisano povrće; kuvano povrće; sušeno povrće; ulja za ishranu; pavlaka [mlečni proizvod]; sir; smrznuto voće; kristalizovano voće; kroketi; ljuskari, koji nisu živi; urme; mleko; rak, koji nije živ; riblji fileti; sirište, sirilo; voće, kuvano; voćni žele; voćna pulpa; meso; riba, koja nije živa; žele za ishranu; žele od mesa; divljač, koja nije živa; đumbirov džem; konzervisana soja, za ishranu; masne supstance za proizvodnju jestive masti; smeše koje sadrže mast za kriške hleba; haringe, nežive; jastozi, koji nisu živi; kukuruzno ulje za ishranu; ulje palminih koštica za ishranu; susamovo ulje za ishranu; ostrige, koje nisu žive; riblji želatin za ishranu; šunka; žumance od jaja; jogurt; preparati za supu od povrća; sokovi od povrća za kuvanje; mesni ekstrakti; kefir [piće od mleka]; kumis [piće od mleka]; napici od mleka, u kojima mleko preovlađuje; surutka; proizvodi od mleka; bodljikavi jastog, koji nije živ; slanina; konzervisano sočivo; margarin; mermelada; životinjska moždina, srž, za ishranu; školjke, ljuskari, koji nisu živi; školjke, koje nisu žive; palmino ulje za ishranu;

prerađen orah; jaja; jaja u prahu; jetrena pašteta; luk, konzervisan; masline, konzervisane; maslinovo ulje za ishranu; koštano ulje za ishranu; pektin za kulinarske namene; kiseli krastavac; grašak, konzervirani; kobasice; usoljeno meso; sastojci za pripremanje supe; paradajz pire; salate od povrća; svinjska mast; salate od voća; sardine, nežive; losos, neživ; bubrežni loj za ishranu; tunjevina, neživa; sok od paradajza za kuvanje; suncokretovo ulje za ishranu; škembići; konzervisana gomoljika, tartuf živina, koja nije živa; kora od voća; alginati za kulinarske namene; mleveni badem; kikiriki, pripremljen; konzervisane pečurke; kokosova mast; kokosovo ulje za ishranu; konzervisan pasulj; jetra; namirnice na bazi ribe; voćni čips; školjke kapice, koja nisu žive; voće konzervisano u alkoholu; polen pripremljen kao hrana; škampi, račići, koji nisu živi; konzervisana riba; konzervisano meso; morski račići, koji nisu živi; jaja puževa za jelo; tofu; mućena pavlaka, šlag; svinjetina; jestiva ptičja gnezda; riba u konzervi; riblje brašno za ljudsku ishranu; voće u konzervi; meso u konzervi; uštipci, krofne od krompira; usoljena riba; morski krastavac, koji nije živ; čaure svilene bube za ljudsku ishranu; povrće u konzervi; panirane kobasice; pahuljice od krompira; pire od jabuka; kompot od brusnice; tahini [namaz od susama]; humus [namaz od leblebija]; morske (nori) alge, konzervisane; grickalice na bazi voća; kiselo mleko; kimči [jelo od fermentisanog povrća]; sojino mleko; milk šejk; ajvar [konzervisana paprika]; suncokretove semenke, pripremljene; riblji musevi; bezalkoholni punč od žumanaca; musevi od povrća; riblja ikra, pripremljena semenke, pripremljene\*; aloe vera za ljudsku ishranu; konzervisan beli luk; proteinsko mleko; ulje od semena lana za ishranu; niskokalorični čips od krompira; niskokalorični hrskavi krompir; lecitin za kulinarske namene; mlečni fermenti za kulinarske namene; kompoti; kondenzovano mleko; smetana [kisela pavlaka]; raženka [fermentisano pečeno mleko]; fermentisano mleko; paradajz pire; pasta od povrća; pasta od plavog patlidžana; mleko od kikirikija za kulinarske svrhe; bademovo mleko za kulinarske svrhe; pirinčano mleko; artičoke, konzervirane; aranžmani od obrađenog voća; mleko u prahu\*; jakitori [japanski ražnjići od piletine]; bulgogi [koreansko jelo od govedine]; kandirani orasi; začinjeno koštunjavo voće; začinjeni orasi; lešnici, pripremljeni; bobičasto voće, konzervirano; guakamol [pire od avokada]; prstenovi od luka [pohovani luk]; falafel; limunov sok za upotrebu u kulinarstvu; dehidrisano meso; zamrznuto-sušeno meso; liofilizovano meso; ovseno mleko; pavlaka [biljna] na bazi povrća; zamrznuto-sušeno povrće; liofilizovano povrće; dehidrisano povrće; ekstra devičansko maslinovo ulje za ishranu; galbi [jelo od grilovanog mesa]; eskamol [jestive larve mrava]; jestivi insekti, neživi; kukuruz šećerac, prerađen; namazi na bazi orašastih plodova; knedle na bazi krompira; viršle; viršle u kukuruznom testu na štapiću; sojino ulje za ishranu; zamene za mleko; bademovo mleko; mleko od kikirikija; kokosovo mleko; kokosovo mleko za kulinarsku upotrebu; napici na bazi kokosovog mleka; pirinčano mleko za kulinarsku upotrebu; napici na bazi bademovog mleka; napici na bazi mleka od kikirikija; creva za kobasice, prirodna ili veštačka; usoljen i sušeni bakalar; uštipci od svežeg sira; presovana voćna pasta; juba [tofu listići]; pljeskavice od soje; tofu pljeskavice; tadžin [gotovo jelo od mesa, ribe ili povrća];

Klasa 30: Alge [začin]; testenina; bademovo testo; seme anisa; seme zvezdastog anisa; konditorski proizvodi za ukrašavanje novogodišnje jelke; nemedicinski biljni čajevi; arome za kafu; aromatični dodaci za hranu; dodaci jelima; hleb bez kvasca; soli za konzervisanje namirnica; dvopek; biskviti, suvi kolačići keks; sladni biskviti; slatkiši od pepermint; slatkiši [bombone]; vafel proizvodi; slatke zemičke, kolačići kakao; kafa; nepržena kafa; biljni preparati za upotrebu kao zamena za kafu; kolači; cimet [začin]; kapra; karamele [bombone]; kari [začin]; preparati od žitarica; žvakaća guma\*; cikorija [zamena za kafu]; čaj; čokolada; marcipan; karanfilić [začin]; začinski dodaci; slatkiši; slatkiši od šećera; kornfleks; kukuruzne pahuljice; kokice; preparati za učvršćivanje mućene pavlake, šlaga; sladoled; palačinke;

esencije za ishranu, izuzev etarskih esencija i etarskih ulja; kuhinjska so; dodaci za zgušnjavanje hrane za kuvanje; kurkuma\*; prirodni zaslađivači; začini; kolačići od đumbira; piment; brašno\*; brašno od boba; kukuruzno brašno; kukuruzno brašno, krupno brašno od slačice; ječmeno brašno; sojino brašno; pšenično brašno; skrob za jelo; fermenti za testo; fondani [slatkiši]; sitni kolači; šećer\*; arome za kolače, izuzev etarskih ulja; prašak za kolače; testo za kolače; đumbir [začin]; vezivni agensi za sladoled; led, prirodni ili veštački; led za osvežavanje; glukoza za kulinarsku namenu; gluten pripremljen kao hrana; prekrupa za ljudsku ishranu; sirće; kečap [sos]; kakao; napici sa mlekom; pića od kafe sa mlekom; pića od čokolade sa mlekom; sredstva za podizanje testa; kvasac; materijali za vezivanje kobasica; kolačići od badema [slatka peciva]; makaroni; mleveni kukuruz; kukuruz, mleveni kukuruz, prženi kukuruz; hleb\*; maltoza; melasa za ishranu; zlatni sirup [šećerni sirup], melasa; mentol za poslastice; med; oljušteni ječam; senf; orašići rezanci; tanki rezanci; pite; mleveni ječam; sendviči; pastile [bombone]; peciva; peti-ber keks; vekne hleba; začinska paprika; pice; biber; brašno od krompira\*; puding; praline; ravioli; slatki koren [slatkiši]; pirinač šafran [začin]; sago; sosovi [dodaci hrani]; celerova so; griz; šerbet [zaleđeni]; sorbei [ledeni]; špageti; tapioka; brašno tapioke\*; tart [slatka pita bez gornje kore]; aroma vanile za kulinarske namene; vanilin [zamena za vanilu]; rezanci za supu; pite od mesa; vekna sa mesom; sredstva za omekšavanje mesa za upotrebu u domaćinstvu; sladoledi; prašak za pravljenje sladoleda; slatkiši od badema; poslastice od kikirikija; arome, koje nisu etarska ulja; arome za pića, izuzev etarskih ulja; mleveni ovas; oljušteni ovas; hrana na bazi ovsa; ovsene pahuljice; ovseno brašno; štapovi od slatkog korenja [poslastica]; pivsko sirće; pića na bazi kafe; pića na bazi kakaoa; pića na bazi čokolade; zamene za kafu; bombone\*; čips [proizvod od žitarica]; čau-čau [začin]; kus-kus [griz]; sladni ekstrakti za hranu; slad za ljudsku ishranu; propolis [pčelinji proizvod]\*; propolis; reliš [dodatak jelu]; matični mleč\*; morska voda za kuvanje; suši; umak od paradajza; majonez; krekeri; engleski krem; voćni žele [slatkiši]; musli; kolači od pirinča; umak, sos od soje; smrzniti jogurt [poslastičarski]; čatni [dodatak jelima]; prolećne rolnice; tako tortilje; ledeni čaj; napici od čaja; prelive za salatu; hlebne mrvice; tabule, libanska salata; alva; kiš; sosovi za meso [umaci]; pasta od soje [dodatak jelima]; miso [dodatak jelima]; grickalice na bazi žitarica; grickalice na bazi pirinča; suva zrna kukuruza bez ljuske; kukuruzni griz; prašak za pecivo; bikarbona soda za kuvanje; soda bikarbona za kuvanje; konzervisane baštenske trave [začini]; gotovi obroci od rezanaca; glazure za kolače; čokoladni musevi; deserti u obliku musa [slatkiši]; voćni prelive [sosovi]; marinade; sendviči sa sirom [čizburgeri]; pesto [sos]; glazure za šunku; seme lana za kulinarsku upotrebu [začin]; laneno seme za kulinarsku upotrebu [začin]; pšenične klice za ljudsku ishranu; visokoproteinske pločice od žitarica; tartar krem za kuvanje; glutenski dodaci za kulinarske namene; sosovi za testenine; pločice od žitarica; palmin šećer; testo, poluprerađen proizvod; cvetovi ili lišće kao zamena za čaj; testo za slatka peciva; vareniki [punjene knedle]; peljmeni [knedle punjene mesom]; čokoladni ukrasi za torte; ukrasne bombone za torte; koštunjavo voće sa čokoladnim prelivom; sutlijaš; koštunjavo voće u prahu; beli luk u prahu [začin]; baozi [testo sa nadevom]; pirinčana kaša za kulinarske namene; jiaozi [punjene knedle]; ramen [japansko jelo na bazi rezanaca]; okonomijaki [japanske pikantne palačinke]; smese za okonomijaki [japanske pikantne palačinke]; buritosi; gimbap [koreansko jelo od pirinča]; jestivi papir; jestivi papir od pirinča; namazi na bazi čokolade; čokoladni namazi koji sadrže orašaste plodove; knedle na bazi brašna sirup od agave [prirodni zaslađivač]; staklene glazure; dehidrisana jela čiji je glavni sastojak pirinač; liofilizovana jela čiji je glavni sastojak pirinač; zamrznuta-sušena jela čiji je glavni sastojak pirinač; zamrznuta-sušena jela čiji je glavni sastojak testenina; liofilizovana jela čiji je glavni sastojak testenina; dehidrisana jela čiji je

glavni sastojak testenina; napici na bazi kamilice; mlečni karamel krem; bibimbap [mešavina pirinča sa povrćem i junetinom]; onigiri [pirinčane kuglice]; instant pirinač sendvič sa viršlama; kocke leda; prerađeno seme za upotrebu kao začini; susamovo seme [začin]; pikalili; kinoa, prerađena; bulgur; heljda, prerađena brašno od heljde; sos od brusnice [začin]; sos od jabuka [začin]; krutoni; lomper [palačinke na bazi krompira]; zefir [poslastica]; pastila [poslastica]; senbei [pirinčani krekeri]; kimči [palačinke od ukiseljenog povrća]; strugani led sa zaslađenim crvenim pasuljem; mentol bombone za osvežavanje daha; žvakaće gume za osvežavanje daha; udon rezanci soba rezanci.

Klasa 31: Agrumi [južno voće], sveži; alge, neprerađene, za ljudsku ili životinjsku ishranu; morske alge, neprerađene, za ljudsku ili životinjsku ishranu; orašasto voće; životinjska menadžerija; žive životinje; hrana za životinje; drveće; Božićne jelke\*; stabla drveća; žbunje; ovas [zob]; bobičasto voće, sveže; so za stoku; repa, sveža; mekinje; trupci; kokosov orah, sirov; šećerna trska; rogač, sirov; seme žitarica, neprerađeno; gljive, sveže; uljaste pogače; stočne pogače; kesten, svež; kreč za životinjsku ishranu; koren cikorije; cikorija, sveža; biskviti za pse; limun, svež; ljuska kokosovog oraha; kokos; hrana za ptice; pogača od uljane repice za stoku; krastavci, sveži; hmeljne šišarke; kaša od mekinja za ishranu životinja; kopra; školjke [žive] sveže; povrće bundeve, sveže; venci od prirodnog cveća; jaja za uzgoj, oplodena; pomije; uzgajana stoka; preparati za tovljenje životinja; brašno od pirinča za stočnu ishranu; pasulj, svež; cveće, prirodno; cveće, za dekoraciju, osušeno; polen [sirovina]; seno; hrana za jačanje životinja; hrana za stoku; stočna hrana; pšenica voće, sveže; travnjaci, prirodni; trava, prirodna; smrekine bobice; semenske klice za botaničke svrhe; zrnevlje [žitarice]; seme za životinjsku konzumaciju; seme za sadnju; semenje; zobena krupica za živinu; baštenska trava, sveža biljke; sadnice; hmelj; orah biljke kole; zelena salata, sveža; sočivo, sveže; kvasac za ishranu životinja; pluta, sirova; laneno brašno [stočna hrana]; kukuruz; kukuruzna stočna pogača; slad za vrenje i destilaciju komina; ostaci voća [komina]; lešnik, svež; brašno za životinje; riblja ikra; jaja svile bube; lukovice; cvetne lukovice; crni luk, svež; masline, sveže; pomorandže, sveže; ječam; kopriva; sipina kost za ptice; slamene prostirke; slama [stočna hrana]; palme [lišće palminog drveta]; stabla palme; kaša za tovljenje stoke; riba, živa; vinova loza; borova šišarka; biber [biljka]; biljke, sušene, za dekoraciju; praziluk, svež; grašak, svež; krompir, svež; preparati za živinu; nosilje; stajska hrana za životinje; korenje za ishranu životinja; grožđe, sveže; rabarbara, sveža; žbunovi ruža; raž; svilen buba; jestiv susam, neprerađen; tartufi, sveži; talog nakon destilacije; živina, živa; algarovila za životinjsku ishranu; badem [voće]; kikiriki, svež; brašno od kikirikija za životinje; pogače od kikirikija za životinje; nus-proizvodi prerade žitarica za ishranu životinja; ostaci nakon prerade šećerne trske [sirovina]; mamci za pecanje, živi; rakovi, živi; ljuskari, živi; jastozi, živi; dagnje, žive; ostrige, žive; hrana za kućne ljubimce; sirova kora drveta; jastozi obični [živi]; hrana za preživljanje za životinje; napitci za kućne ljubimce; riblje brašno za životinjsku ishranu; pirinač, neprerađen; morski krastavci [živi]; papir sa peskom [prostirka] za kućne ljubimce; mirisni pesak [prostirka] za kućne ljubimce; aloe vera biljke; spanać, svež; laneno seme za ishranu životinja; seme lana za ishranu životinja; brašno od semena lana za ishranu životinja; laneno brašno za ishranu životinja; pšenične klice za ishranu životinja; artičoke, sveže; haringa, živa; losos, živ; sardine, žive; tuna, živa; beli luk, svež; tikvice, sveže; jestivo seme lana, neprerađeno; jestive semenke lana, neprerađene; aranžmani od svežeg voća; incuni, živi; jestivi insekti, živi; neprerađeni klipovi kukuruza šećerca [oljušteni ili neoljušteni]; kinoa, neprerađena; heljda, neprerađena; koi šarani, živi.

Klasa 32: Bezalkoholni voćni ekstrakti; pivo; ale pivo od đumbira; pivo od đumbira; sladno pivo; pivski slad; bezalkoholni voćni napici; pića od surutke; bezalkoholni pripravci za pravljenje napitaka; koncentрати za pravljenje napitaka; voćni sokovi; sirupi za pića vode

[pića]; preparati za pravljenje gazirane vode; litijum voda; mineralna voda [piće]; Seltzer voda; stone vode šira limunade; ekstrakti hmelja za proizvodnju piva; sokovi od povrća [pića]; sirupi za limunade; sladovina šira [nefermentisana]; bademov sirup; soda voda; šerbeti [pića]; sok od paradajza [piće]; bezalkoholna pića; pilule za gaziranje pića; praškovi za gaziranje pića; gazirana voda; sarsaparila [bezalkoholni napitak]; aperitivi, bezalkoholni; kokteli, bezalkoholni; voćni nektar [bezalkoholni]; izotonici; sok od jabuke, bezalkoholni; kvas [bezalkoholni napitak]; bezalkoholni napici na bazi meda; smutis [kašasti napici od voća ili povrća]; bezalkoholna pića od aloe vera; kokteli na bazi piva; napici od soje, osim zamena za mleko; napici za sportiste obogaćeni proteinima; napici na bazi pirinča, koji nisu zamena za mleko; bezalkoholni napici sa ukusom kafe; bezalkoholni napici sa ukusom čaja; osvežavajuća bezalkoholna pića; ječmeno vino [pivo]; energetska pića.

Klasa 33: Liker od pepermintaa; voćni ekstrakti, alkoholni; biteri [gorka alkoholna pića]; liker od anisa; aniset [liker]; aperitivi; arak; destilovana pića; jabukovača; kokteli; kurakao; digestivi [likeri i žestoka pića]; vino; džin; liker; medovina; kiršč, višnjevača; žestoka pića; brendi; piket; kruškovača; sake; viski; alkoholna esencije; alkoholni ekstrakti; alkoholna pića, izuzev piva; alkoholna pića koja sadrže voće; alkohol od pirinča; rum; vodka; pomešana alkoholna pića, koja nisu na bazi piva; nira [alkoholno piće na bazi šećerne trske]; baijiu [kinesko piće od destilovanog alkohola].

Klasa 35: Pomoć u poslovnom upravljanju; obaveštenja o poslovima reklamiranje preko plakata; usluge agencija za uvoz i izvoz; usluge agencija za pružanje poslovnih informacija; analize cena i troškova; distribucija reklamnog materijala; računovodstvo; vođenje knjiga [knjigovodstvo]; revizija poslovanja; poslovno upravljanje i organizaciono savetovanje; konsultacije u poslovnom upravljanju; prezentacija robe; pomoć u poslovnom ili industrijskom upravljanju; ažuriranje oglasnih materijala; distribucija uzoraka; stručne usluge o poslovnoj efikasnosti; istraživanje tržišta; poslovne procene; poslovna ispitivanja; iznajmljivanje oglasnih materijala; konsultacije u vezi sa poslovnim organizovanjem; objavljivanje reklamnih tekstova; oglašavanje; reklamiranje; reklamiranje na radiju; poslovna istraživanja; usluge odnosa sa javnošću; reklamiranje preko televizije; prepisivanje korespondencije [kancelarijske usluge]; uređivanje izloga; usluge reklamnih agencija; savetodavne usluge u poslovnom upravljanju; marketinška istraživanja; kompjutersko upravljanje podacima; profesionalne poslovne konsultacije; organizovanje izložbi za privredne ili reklamne potrebe; poslovne informacije; ispitivanje javnog mnjenja; priprema platnih listi; pronalaženje osoblja; iznajmljivanje oglasnog prostora; obračun poreza; prikupljanje informacija u kompjuterske baze podataka; sistemacija informacija u kompjuterskim bazama podataka; organizovanje sajмова u komercijalne ili reklamne svrhe; onlajn reklamiranje na računarskoj mreži; usluge nabavke za treća lica [kupovina proizvoda i usluga za druge poslovne subjekte]; psihološko testiranje za izbor zaposlenih; usluge poređenja cena; prezentacija proizvoda putem sredstava komunikacije, u svrhu prodaje na malo; pružanje komercijalnih saveta i informacija potrošačima pri izboru roba i usluga; dogovaranje pretplate za usluge telekomunikacija za treća lica; administrativna obrada narudžbenica za kupovinu; komercijalna administracija za licence roba i usluga trećih lica; usluge podugovaranja, autsorsing [pomoć u poslovanju]; fakturisanje; pisanje reklamnih tekstova; prikupljanje statističkih podataka; marketing; usluge maloprodaje farmaceutskih, veterinarskih i higijenskih preparata i medicinskog materijala; iznajmljivanje prodajnih štandova; pružanje komercijalnih i poslovnih kontakt informacija; optimizacija pretraživača za promociju prodaje; optimizacija saobraćaja sa Internet stranice; usluge posredovanja u trgovini; pružanje poslovnih informacija putem Internet stranice; obezbeđivanje onlajn tržišta za kupce i prodavce roba i usluga; dizajniranje reklamnog materijala; angažovanje spoljnih

firmi za administrativno upravljanje kompanijama; usluge prijavljivanja poreza; poslovno upravljanje programima za nadoknadu za druge; iznajmljivanje bilborda [panoa za reklamiranje]; usluge zakazivanja sastanaka [kancelarijske usluge]; upravljanje programima lojalnosti potrošača; pisanje tekstova za reklamne namene; registrovanje pisane komunikacije i podataka ažuriranje i održavanje; informacija u registrima; sastavljanje popisa informacija za komercijalne i reklamne svrhe; poslovno upravljanje za nezavisne pružaoce usluga; pregovaranje i zaključivanje poslovnih transakcija za treća lica; usluge poslovnog posredovanja koje se odnose na povezivanje potencijalnih privatnih ulagača sa preduzetnicima kojima su potrebna finansijska sredstva; promocija robe i usluga kroz sponzorisanje sportskih događaja; usluge praćenja konkurencije; usluge praćenja tržišta; finansijska revizija; ciljni marketing; oglašavanje na otvorenom; usluge odnosa sa medijima usluge korporativne komunikacije; iznajmljivanje kancelarijske opreme u zajedničkim radnim prostorima; usluge komercijalnog lobiranja.

Klasa 43: Usluge agencija za smeštaj [hotelski, pansionski]; katering hrane i pića; usluge kafea; usluge kafeterija; usluge kantina; iznajmljivanje privremenog smeštaja; pansionске usluge; usluge restorana; usluge restorana za samoposluživanje; usluge snek-barova; usluge barova; iznajmljivanje stolova, stolica, stolnjaka i staklenog posuđa; iznajmljivanje prostorija za sastanke; iznajmljivanje aparata za kuvanje; iznajmljivanje automata za vodu za piće; iznajmljivanje aparata za osvetljenje\*; pravljenje skulptura od hrane; usluge vašoku restorana; usluge udon i soba restorana; dekorisanje hrane; dekorisanje kolača; informacije i saveti u vezi sa pripremanjem obroka; usluge ličnog šefa kuhinje.

---

(111) **15179**

(151) 26.02.2021.

(210) Ž-2020-86

(220) 06.03.2020.

(732) Lidl Stiftung & Co. KG , Stiftsbergstrasse 1, 74172, Neckarsulm, DE

(540)



(550) I

(740) Vuk Lutovac, Bulevar Ivana Crnojevića 93, 81000, Podgorica

(511) Klasa 33: Alkoholna pića (osim piva).

---

(111) **15180**

(151) 26.02.2021.

(210) Ž-2020-87

(220) 06.03.2020.

(732) Pharmaceutical chemical cosmetic industry ALKALOID AD Skopje, blvd. Aleksandar Makedonski 12, 1000, Skopje, MK

(540)



(550) I

(740) Miladin Popović, Đoka Miraševića 21/III, 81000, Podgorica

(511) Klasa 3: Nemedicinska kozmetika i toaletni preparati; nemedicinska sredstva za čišćenje zuba; parfimerija; etarska ulja; preparati za bjeljenje i druge supstance za upotrebu u perionicama; preparati za čišćenje, poliranje, ribanje i abrazivni preparati; sapuni; kozmetički preparati; losioni za kosu; maramice natopljene kozmetičkim losionima; preparati za čišćenje zuba; šamponi; parfemi; kozmetika za djecu; tečni deterdženti; kozmetički preparati za kupanje; toaletna voda; preparati za zaštitu od sunca; kozmetičke kreme; kozmetički preparati za njegu kože; losioni za kozmetičku upotrebu; ulja za kozmetičku upotrebu; ulje od jasmína; ulje od lavande; losioni za tijelo; kreme za lice; dezodoransi za tijelo; talk puder za toaletnu upotrebu.

Klasa 5: Farmaceutski, medicinski i veterinarski preparati; sanitarni preparati za upotrebu u medicini; dijetetska hrana i supstance prilagođene za upotrebu u medicini i veterinarstvu; hrana za bebe; pelene za bebe; dijetetski dodaci za ljude i životinje; flasteri; materijali za previjanje; materijali za plombiranje zuba, zubarski vosak; dezinfekciona sredstva; preparati za uništavanje štetočina; fungicidi, herbicidi.

Klasa 35: Oglašavanje; onlajn oglašavanje na kompjuterskoj mreži; poslovno upravljanje; poslovna administracija; kancelarijske usluge; reklamiranje.

---

(111) **15181**

(151) 03.03.2021.

(210) Ž-2019-328

(220) 04.09.2019.

(732) Društvo sa ograničenom odgovornošću "CONCORD LIMOUSINES " doo Herceg Novi, Zemunska 143, Meljine, Herceg Novi, ME

(540)



(550) I

(511) Klasa 39: Usluge prevoza - usluge iznajmljivanja prevoznih sredstava.

---

(111) **15182**

(151) 03.03.2021.

(210) Ž-2019-337

(220) 05.09.2019.

(732) MARCO POLO TRAVEL AGENCY D.O.O. PODGORICA, CITY KVART B.B., 81000, PODGORICA, ME

(540)



(550) I

(511) Klasa 35: Oglašavanje i reklamiranje; Sortiranje izleta za račun drugih osoba kako bi omogućili klijentima lakše informisanje i kupovinu, posredstvom prodajnih flajera (kataloga), dopisno ili elektronskim putem, posredstvom elektronskih uređaja (touch panela), web-a, android aplikacija, društvenih mreža, email-a i putem telefona; Reklamiranje turističke ponude i Crne Gore kao turističke destinacije; Reklamiranje turističkih lokaliteta; Vođenje komercijalnih poslova; poslovi informisanja gostiju o ponudi i prodaji izleta u okviru unaprijed definisanog programa; Komercijalna administracija; Administrativni poslovi, izrada izvještaja, evidencija statističkih podataka, naplata; Kancelarijski poslovi; E-mail i telefonska korespondencija, štampanje i izdavanje izletničkih karata.

Klasa 39: Prevoz; Organizovanje transporta putnika koji je sastavni dio izletničkog programa kod većine ponuđenih turističkih proizvoda, sopstvenim ili iznajmljenim prevoznim sredstvom; Organizovanje putovanja — Organizovanje poludnevni i cjelodnevni izleta; Informisanje i obavještanje o detaljima izleta, cijeni izleta, rasporedu polazaka i sl.; Usluge obavještanja o putovanjima preko posrednika.



Klasa 41: Razonoda — Organizovanje izletničkog programa radi razonode i zabave.  
Klasa 43: Usluge obezbjeđivanja hrane i pića.

---

(111) **15183**

(151) 04.03.2021.

(210) Ž-2019-127

(220) 26.03.2019.

(732) Philip Morris Products S.A., Quai Jeanrenaud 3, 2000, Neuchâtel, CH

(540)



(550) I

(740) Milena Pejović, Cetinjski put 11, The Capital Plaza IV floor., 81000, Podgorica

(511) Klasa 34: Žičani vaporizatori za elektronske cigarete i elektronske uređaje za pušenje; duvan, sirov ili prerađen; duvanski proizvodi, cigare, cigarete, cigarilosi, duvan za uvijanje cigareta, duvan za lule, duvan za žvakanje, duvan za šmrkanje, kretek; snus (duvan u prahu); zamena za duvan (za nemedicinsku upotrebu); artikli za pušače, papir za cigarete, tube za cigarete, filteri za cigarete, kutije za duvan, kutije za cigarete, tabakere i pepeljare, lule, džepne mašine za uvijanje cigareta, upaljači; šibice; duvanski štapići, duvanski proizvodi za zagrevanje, elektronski uređaji, i njihovi delovi, koji se koriste za zagrevanje cigareta ili duvana u cilju oslobađanja aerosola koji sadrži nikotin za inhalaciju; tečni nikotinski rastvori za upotrebu u elektronskim cigaretama; elektronski uređaji za pušenje; elektronske cigarete; elektronske cigarete kao zamena za tradicionalne cigarete; elektronski uređaji koji sadrže aerosol za inhalaciju nikotina; oralni vaporizatori za pušače, duvanski proizvodi i zamene za duvan; artikli za pušače elektronskih cigareta; delovi i oprema za navedene proizvode iz klase 34; uređaji za gašenje cigareta i cigara koje se zagrevaju i duvanskih štapića koji se zagrevaju; punjive elektronske kutije za cigarete.

---

(111) **15184**

(151) 04.03.2021.

(210) Ž-2019-128

(220) 26.03.2019.

(732) Philip Morris Products S.A., Quai Jeanrenaud 3, 2000, Neuchâtel, CH

(540)



(550) I

(740) Milena Pejović, Cetinjski put 11, The Capital Plaza IV floor,, 81000, Podgorica

(511) Klasa 34: Žičani vaporizatori za elektronske cigarete i elektronske uređaje za pušenje; duvan, sirov ili prerađen; duvanski proizvodi, cigare, cigarete, cigarilosi, duvan za uvijanje cigareta, duvan za lule, duvan za žvakanje, duvan za šmrkanje, kretek; snus (duvan u prahu); zamena za duvan (za nemedicinsku upotrebu); artikli za pušače, papir za cigarete, tube za cigarete, filteri za cigarete, kutije za duvan, kutije za cigarete, tabakere i pepeljare, lule, džepne mašinicice za uvijanje cigareta, upaljači; šibice; duvanski štapići, duvanski proizvodi za zagrevanje, elektronski uređaji, i njihovi delovi, koji se koriste za zagrevanje cigareta ili duvana u cilju oslobađanja aerosola koji sadrži nikotin za inhalaciju; tečni nikotinski rastvori za upotrebu u elektronskim cigaretama; elektronski uređaji za pušenje; elektronske cigarete; elektronske cigarete kao zamena za tradicionalne cigarete; elektronski uređaji koji sadrže aerosol za inhalaciju nikotina; oralni vaporizatori za pušače, duvanski proizvodi i zamene za duvan; artikli za pušače elektronskih cigareta; delovi i oprema za navedene proizvode iz klase 34; uređaji za gašenje cigareta i cigara koje se zagrevaju i duvanskih štapića koji se zagrevaju; punjive elektronske kutije za cigarete.

---

(111) **15185**

(151) 04.03.2021.

(210) Ž-2019-497

(220) 13.12.2019.

(732) Philip Morris Products S.A., Quai Jeanrenaud 3, 2000, Neuchâtel, CH

(540)

**TEREA**

(550) I

(740) Milena Pejović, Cetinjski put 11, The Capital Plaza IV floor,, 81000, Podgorica

(511) Klasa 34: Žičani vaporizatori za elektronske cigarete i elektronske uređaje za pušenje; duvan, sirov ili prerađen; duvanski proizvodi uključujući cigare, cigarete, cigarilose, duvan za uvijanje cigareta, duvan za lule, duvan za žvakanje, duvan za šmrkanje, kretek; snus (duvan u prahu); zamena za duvan (za nemedicinsku upotrebu); artikli za pušače, uključujući papir za cigarete, tube za cigarete, filtere za cigarete, kutije za duvan, kutije za cigarete, tabakere i pepeljare, lule, džepne mašine za uvijanje cigareta, upaljače; šibice; duvanski štapići, duvanski proizvodi za zagrevanje, elektronski uređaji, i njihovi delovi, koji se koriste za zagrevanje cigareta ili duvana u cilju oslobađanja aerosola koji sadrži nikotin za inhalaciju; tečni nikotinski rastvori za upotrebu u elektronskim cigaretama; elektronski uređaji za pušenje; elektronske cigarete; elektronske cigarete kao zamena za tradicionalne cigarete; elektronski uređaji koji sadrže aerosol za inhalaciju nikotina; oralni vaporizatori za pušače, duvanski proizvodi i zamene za duvan; artikli za pušače elektronskih cigareta; delovi i oprema za navedene proizvode iz klase 34; uređaji za gašenje cigareta i cigara koje se zagrevaju i duvanskih štapića koji se zagrevaju; punjive elektronske kutije za cigarete.

---

(111) **15186**

(151) 04.03.2021.

(210) Ž-2019-498

(220) 13.12.2019.

(732) Philip Morris Products S.A., Quai Jeanrenaud 3, 2000, Neuchâtel, CH

(540)

## ILUMA

(550) I

(740) Milena Pejović, Cetinjski put 11, The Capital Plaza IV floor, 81000, Podgorica

(511) Klasa 9: Baterije za elektronske cigarete; baterije za elektronske uređaje koji se koriste za zagrevanje duvana, punjači za elektronske uređaje koji se koriste za zagrevanje duvana; USB punjači za elektronske uređaje koji se koriste za zagrevanje duvana; automobilski punjači za elektronske cigarete; automobilski punjači za uređaje koji se koriste za zagrevanje duvana; punjači za baterije za elektronske cigarete.

Klasa 34: Žičani vaporizatori za elektronske cigarete i elektronske uređaje za pušenje; duvan, sirov ili prerađen; duvanski proizvodi uključujući cigare, cigarete, cigarilose, duvan za uvijanje cigareta, duvan za lule, duvan za žvakanje, duvan za šmrkanje, kretek; snus (duvan u prahu); zamena za duvan (za nemedicinsku upotrebu); artikli za pušače, uključujući papir za cigarete, tube za cigarete, filtere za cigarete, kutije za duvan, kutije za cigarete, tabakere i pepeljare, lule, džepne mašine za uvijanje cigareta, upaljače; šibice; duvanski štapići, duvanski proizvodi za zagrevanje, elektronski uređaji, i njihovi delovi, koji se koriste za zagrevanje cigareta ili duvana u cilju oslobađanja aerosola koji sadrži nikotin za inhalaciju; tečni nikotinski rastvori za upotrebu u elektronskim cigaretama; elektronski uređaji za pušenje; elektronske cigarete; elektronske cigarete kao zamena za tradicionalne cigarete; elektronski uređaji koji sadrže aerosol za inhalaciju nikotina; oralni vaporizatori za pušače, duvanski proizvodi i zamene za duvan; artikli za pušače elektronskih cigareta;

delovi i oprema za navedene proizvode iz klase 34; uređaji za gašenje cigareta i cigara koje se zagrevaju i duvanskih štapića koji se zagrevaju; punjive elektronske kutije za cigarete.

---

(111) **15187**

(151) 04.03.2021.

(210) Ž-2020-76

(220) 03.03.2020.

(732) CRIB & BEER D.O.O. PODGORICA, Njegoševa br.34, 81000, Podgorica, ME

(540)



(550) I

(740) Dragan S. Nikolić, Ul. Veliše Mugoše I/9, 81000, Podgorica

(511) Klasa 16: Ambalaža (kartonska ili papirnata za boce); boce (kartonska ili papirna ambalaža za boce); boce (kartonski ili papirni omoti za boce); boce (papirni podmetači za boce); brošure; časopisi [periodični]; časopisi [revije], čestitke fascikle [kancelarijski pribor]; fascikle [papirni proizvodi]; fascikle za papir; fotografije [štampane]; kalendari; kalendari [godišnjaci]; kalendari kojima se listovi trgaju; katalozi; knjige (oznake za stranice u knjigama); knjige sa pjesmama, letci, flajeri; naljepnice, štamparski blokovi; novine; novine sa stripovima; olovke, omotači za boce, papirnati ili kartonski; pakovanje hrane (folije od papira ili plastike za održavanje vlage, za pakovanje hrane); pivske čaše (podmetači za pivske čaše); plakati (papirnat ili kartonske podloge za plakate); plakati [poster]; plakati, papirni ili kartonski; salvete od papira za stolove; slikarska platna; slikarske četkice; slikarski stalci; slike; stripovi (novine sa stripovima); sveske za pisanje i crtanje; vrećice [omotnice, džepovi], od papira ili plastike za ambalažu.

Klasa 41: Dekor za priredbe (iznajmljivanje dekora za priredbe); digitalne slike (usluge digitalnog snimanja); disk džokeji (usluge disk džokeja) usluge ; diskoteke (usluge diskoteka); elektronske publikacije (iskorištavanje elektronskih publikacija koje se ne mogu prenositi on-line); filmovi (prikazivanje igranih filmova); filmovi (proizvodnja filmova); fotografisanje; fotografske reportaže; igre za novac; informacije o obrazovanju; informacije o razonodi; informacije u vezi rekreacije; izdavanje knjiga; izložbe (organizovanje izložbi) u kulturne ili obrazovne svrhe; iznajmljivanje audio uređaja; iznajmljivanje dekora za priredbe; iznajmljivanje igrački; iznajmljivanje kinemato grafskih filmova; iznajmljivanje videokamera; iznajmljivanje videotraka; iznajmljivanje zvučnih snimaka; klubovi (usluge klubova [zabava ili obrazovanje]; knjige (izdavanje knjiga); knjige (posuđivanje knjiga); komponovanje muzike ; komponovanje muzike (usluge komponovanja muzike); koncerti (organizovanje i vođenje koncerata); konferencije (organizovanje i vođenje konferencija); kongresi (organizovanje i

vođenje kongresa); modne revije za zabavne svrhe (organizovanje); montaža radio i televizijskih programa, muzejske usluge [predstavljanje, izložbe]; muzičke sale; noćni klubovi; objavljivanje knjiga i časopisa, elektronski on line; objavljivanje tekstova [osim u reklamne svrhe]; obrazovanje (informacije o obrazovanju); obrazovanje [obuka]; obuka; obuka [predavanje]; obuka putem dopisivanja; organizovanje i vođenje koncerata; organizovanje i vođenje konferencija; organizovanje i vođenje kongresa; organizovanje i vođenje radionica za stručno osposobljavanje; organizovanje i vođenje razgovora; organizovanje i vođenje seminara; organizovanje izložba u kulturne i obrazovne svrhe; organizovanje javnih konkursa [obrazovanje ili rasonoda]; organizovanje konkursa ljepote; organizovanje plesova; organizovanje spektakla [usluge impresarija]; organizovanje sportskih takmičenja; orkestri (usluge orkestra); pisanje tekstova [ne u reklamne svrhe]; planiranje prijema [razonoda]; posuđivanje knjiga; pozorišne predstave; pozorišni dekor (iznajmljivanje pozorišnog dekora); pozorišni glumci (usluge pozorišnih glumaca); pozorišni preduzetnici [impresariji] (usluge pozorišnih preduzetnika); prijemi (planiranje prijema) [razonoda]; priredbe (iznajmljivanje dekora za priredbe); priredbe [održavanje priredbi]; priredbe (organizovanje priredbi) [usluge impresarija]; priredbe (proizvodnja priredbi); proizvodnja filmova; proizvodnja filmova na video- trakama; proizvodnja muzike; putujuće biblioteke (usluge putujućih biblioteka); radio televizijski programi (montaža radio televizijskih programa); radioaparati i televizori (iznajmljivanje radioaparata i televizora); razgovori (organizovanje i vođenje razgovora); rasonoda; rasonoda (informacije u vezi rasonode); rasonoda posredstvom radija; rasonoda posredstvom televizije; rekreacija (obavještenja u vezi rekreacije); reportaže (fotografske reportaže); reporterske usluge; rezervisanje mjesta za priredbe; scenarijumi (izrada scenarijuma); seminari (organizovanje i vođenje seminara); simpozijumi (organizacija i vođenje simpozijuma); simpozijumi (organizovanje i vođenje simpozijuma); slobodno vrijeme (usluge za ispunjavane slobodnog vremena); snimanje na videotrake; sportska takmičenja (organizovanje sportskih takmičenja); sportska usavršavana (sportski kampovi za usavršavanje u sportu); sportske oprema (iznajmljivanje sportske opreme osim vozila); studio za snimanje usluge studija za snimanje); tekstovi (objavljivanje tekstova) [osim u reklamne svrhe]; tekstovi (sastavljanje tekstova) [ne u reklamne svrhe]; televizija (razonoda na televiziji) ;televizijsk programi (montaža radio i televizijskih programa);televizori (iznajmljivanje televizora i radioaparata); titlovanje filmova; ulaznice za priredbe (agencije za ulaznice za priredbe) [razonoda]; videotrake (iznajmljivanje videotraka);- videotrake (montaža videotraka); videotrake (proizvodnja filmova na videotrakama); videotrake (snimanje na videotrake); zabavni parkovi(cirkusi); zdravstveni klubovi (usluge zdravstvenih klubova) [održavanje zdravlja i fizičke forme]; zvučni snimci (iznajmljivanje zvučnih).

Klasa 43: Agencije za smještaj [hotelski,pansionski], barovi (usluge barova); hotelske rezervacije (usluge rezervisanja hotela); hotelske usluge; iznajmljivanje aparata za kuvanje; iznajmljivanje privremenog smještaja; iznajmljivanje sala, dvorana za sastanke; iznajmljivanje stolaca, stolova, stolnog rublja i staklenog posuđa; kafane [kafeterije]; kafane;restorani; kantine; ljetovališta; ljetovanje (usluge kampova za ljetovanje); moteli (usluge motela); pansion za životinje; pansioni; pansioni (rezervisanje pansiona);privremeni smještaj (rezervisanje privremenog smještaja); restorani; restorani sa samoposluživanjem; restorani za brzo i stalno posluživanje [snek-barovi]; rezervisanje hotela; rezervisanje pansiona; rezervisanje privremenog smještaja; smještaj (agencije za izdavanje smještaja) [hoteli, pansioni]; smještaj (iznajmljivanje privremenog smještaja); ugostitelji (usluge kateringa).

(111) **15188**

(151) 04.03.2021.

(210) Ž-2020-80

(220) 06.03.2020.

(732) Milan Golović, Radoja Dakića 5/17 stan 24, Podgorica, ME

(540)



(550) I

(740) Dragan S. Nikolić, Ul. Veliše Mugoše I/9, 81000, Podgorica

(511) Klasa 16: Ambalaža (kartonska ili papirnata za boce); boce (kartonska ili papirna ambalaža za boce); boce (kartonski ili papirni omoti za boce); boce (papirni podmetači za boce); brošure; časopisi [periodični]; časopisi [revije], čestitke fascikle [kancelarijski pribor]; fascikle [papirni proizvodi]; fascikle za papir; fotografije [štampane]; kalendari; kalendari [godišnjaci]; kalendari kojima se listovi trgaju; katalogi; knjige (oznake za stranice u knjigama); knjige sa pjesmama, letci, flajeri; naljepnice, štamparski blokovi; novine; novine sa stripovima; olovke, omotači za boce, papirnati ili kartonski; pakovanje hrane (folije od papira ili plastike za održavanje vlage, za pakovanje hrane); pivske čaše (podmetači za pivske čaše); plakati (papirnat ili kartonske podloge za plakate); plakati [posterij]; plakati, papirni ili kartonski; salвете od papira za stolove; slikarska platna; slikarske četkice; slikarski stalci; slike; stripovi (novine sa stripovima); sveske za pisanje i crtanje; vrećice [omotnice, džepovi], od papira ili plastike za ambalažu.

Klasa 41: Dekor za priredbe (iznajmljivanje dekora za priredbe); digitalne slike (usluge digitalnog snimanja); disk džokeji (usluge disk džokeja) usluge ; diskoteke (usluge diskoteka); elektronske publikacije (iskorištavanje elektronskih publikacija koje se ne mogu prenositi on-line); filmovi (prikazivanje igranih filmova); filmovi (proizvodnja filmova); fotografisanje; fotografske reportaže; igre za novac; informacije o obrazovanju; informacije o razonodi; informacije u vezi rekreacije; izdavanje knjiga; izložbe (organizovanje izložbi) u kulturne ili obrazovne svrhe; iznajmljivanje audio uređaja; iznajmljivanje dekora za priredbe; iznajmljivanje igrački; iznajmljivanje kinemato grafskih filmova; iznajmljivanje videokamera; iznajmljivanje videotraka; iznajmljivanje zvučnih snimaka; klubovi (usluge klubova [zabava ili obrazovanje]; knjige (izdavanje knjiga); knjige (posuđivanje knjiga); komponovanje muzike ; komponovanje muzike (usluge komponovanja muzike); koncerti (organizovanje i vođenje koncerata); konferencije (organizovanje i vođenje konferencija); kongresi (organizovanje i vođenje kongresa); modne revije za zabavne svrhe (organizovanje); montaža radio i televizijskih programa, muzejske usluge [predstavljanje, izložbe]; muzičke sale; noćni

klubovi; objavljivanje knjiga i časopisa, elektronski on line; objavljivanje tekstova [osim u reklamne svrhe]; obrazovanje (informacije o obrazovanju); obrazovanje [obuka]; obuka; obuka [predavanje]; obuka putem dopisivanja; organizovanje i vođenje koncerata; organizovanje i vođenje konferencija; organizovanje i vođenje kongresa; organizovanje i vođenje radionica za stručno osposobljavanje; organizovanje i vođenje razgovora; organizovanje i vođenje seminara; organizovanje izložba u kulturne i obrazovne svrhe; organizovanje javnih konkursa [obrazovanje ili razonoda]; organizovanje konkursa ljepote; organizovanje plesova; organizovanje spektakla [usluge impresarija]; organizovanje sportskih takmičenja; orkestri (usluge orkestra); pisanje tekstova [ne u reklamne svrhe]; planiranje prijema [razonoda]; posuđivanje knjiga; pozorišne predstave; pozorišni dekor (iznajmljivanje pozorišnog dekora); pozorišni glumci (usluge pozorišnih glumaca); pozorišni preduzetnici [impresariji] (usluge pozorišnih preduzetnika); prijemi (planiranje prijema) [razonoda]; priredbe (iznajmljivanje dekora za priredbe); priredbe [održavanje priredbi]; priredbe (organizovanje priredbi) [usluge impresarija]; priredbe (proizvodnja priredbi); proizvodnja filmova; proizvodnja filmova na video- trakama; proizvodnja muzike; putujuće biblioteke (usluge putujućih biblioteka); radio televizijski programi (montaža radio televizijskih programa); radioaparati i televizori (iznajmljivanje radioaparata i televizora); razgovori (organizovanje i vođenje razgovora); razonoda; razonoda (informacije u vezi razonode); razonoda posredstvom radija; razonoda posredstvom televizije; rekreacija (obavještenja u vezi rekreacije); reportaže (fotografske reportaže); reporterske usluge; rezervisanje mjesta za priredbe; scenarijumi (izrada scenarijuma); seminari (organizovanje i vođenje seminara); simpozijumi (organizacija i vođenje simpozijuma); simpozijumi (organizovanje i vođenje simpozijuma); slobodno vrijeme (usluge za ispunjavane slobodnog vremena); snimanje na videotrake; sportska takmičenja (organizovanje sportskih takmičenja); sportska usavršavana (sportski kampovi za usavršavanje u sportu); sportske oprema (iznajmljivanje sportske opreme osim vozila);studio za snimanje usluge studija za snimanje); tekstovi (objavljivanje tekstova) [osim u reklamne svrhe]; tekstovi (sastavljanje tekstova) [ne u reklamne svrhe]; televizija (razonoda na televiziji) ;televizijsk programi (montaža radio i televizijskih programa);televizori (iznajmljivanje televizora i radioaparata); titlovanje filmova; ulaznice za priredbe (agencije za ulaznice za priredbe) [razonoda]; videotrake (iznajmljivanje videotraka);- videotrake (montaža videotraka); videotrake (proizvodnja filmova na videotrakama); videotrake (snimanje na videotrake); zabavni parkovi(cirkusi); zdravstveni klubovi (usluge zdravstvenih klubova) [održavanje zdravlja i fizičke forme]; zvučni snimci (iznajmljivanje zvučnih).

Klasa 43: Agencije za smještaj [hotelski,pansionski], barovi (usluge barova); hotelske rezervacije (usluge rezervisanja hotela); hotelske usluge; iznajmljivanje aparata za kuvanje; iznajmljivanje privremenog smještaja; iznajmljivanje sala, dvorana za sastanke; iznajmljivanje stolaca, stolova, stolnog rublja i staklenog posuđa; kafane [kafeterije]; kafane;restorani; kantine; ljetovališta; ljetovanje (usluge kampova za ljetovanje); moteli (usluge motela); pansion za životinje; pansioni; pansioni (rezervisanje pansiona);privremeni smještaj (rezervisanje privremenog smještaja); restorani; restorani sa samoposluživanjem; restorani za brzo i stalno posluživanje [snek-barovi]; rezervisanje hotela; rezervisanje pansiona; rezervisanje privremenog smještaja; smještaj (agencije za izdavanje smještaja) [hoteli, pansioni]; smještaj (iznajmljivanje privremenog smještaja); ugostitelji (usluge kateringa).

(111) **15189**  
(151) 04.03.2021.  
(210) Ž-2020-215

(220) 18.06.2020.  
(732) "OSMANAGIĆ CO" D.O.O. NIKŠIĆ, HERCEGOVAČKI PUT BROJ: 36, Nikšić, ME  
(540)



(550) I

(511) Klasa 12: Vozila.  
Klasa 35: Trgovina polovnih vozila svih brendova.  
Klasa 37: Održavanje i popravka polovnih vozila svih brendova.

---

(111) **15190**  
(151) 08.03.2021.  
(210) Ž-2020-219  
(220) 25.06.2020.  
(732) NUVARIA GLOBAL SL, P.I. Las Dueñas, A-8,Hinojos, 21740, Huelva, ES  
(540)

**Dicora**  
UrbanFit

(550) I

(740) Milena Pejović, Cetinjski put 11, The Capital Plaza IV floor, 81000, Podgorica

(511) Klasa 3: Parfimerija; kozmetika; preparati za beljenje [uklanjanje boja] za upotrebu u domaćinstvu; preparati za poliranje; proizvodi za odmašćivanje, koji nisu za upotrebu u procesu proizvodnje; abrazivi; preparati za čišćenje; sapun; gelovi za izbeljivanje zuba; etarska ulja; losioni za kosu; sredstva za čišćenje zuba [paste, gelovi, tečnosti]; preparati za pranje; gelovi za kupanje; preparati za čišćenje; preparati za parfimisanje vazduha.

Klasa 21: Kozmetički pribor; raspršivači mirisa/mirisni isparivi raspršivači; instrumenti za čišćenje, ručni; toaletni pribor; sunđeri za upotrebu u domaćinstvu; sunđeri za pranje/ribanje; krpe za čišćenje; četke; materijali za pravljenje četki; četke za obuću;



krpe za prašinu; rukavice za upotrebu u domaćinstvu; mopovi; kućne potrepštine; kutije za upotrebu u domaćinstvu ili kuhinji; češljevi; štipaljke za veš; sušeri za šminkanje; četke; sušeri; krpe za poliranje cipela; rukavice za čišćenje za upotrebu u domaćinstvu; mopovi; krpe za poliranje; krpe za čišćenje; krpe za pranje podova; krpe za prašnu; krpe za brisanje prašine sa nameštaja.

---

(111) **15191**

(151) 08.03.2021.

(210) Ž-2020-296

(220) 19.08.2020.

(732) "Art Port" DOO, Bulevar Revolucije 11b, Bar, ME

(540)



(550) I

(511) Klasa 37: Asfaltiranje; bageri (iznajmljivanje bagera); buldožeri (iznajmljivanje buldožera); bunari (kopanje bunara); bušenje bunara; centralno grijanje (postavljanje i popravak instalacija centralnog grijanja); čišćenje zgrada [spoljnih površina]; građevinski radovi (nadzor građevinskih radova); informacije o graditeljstvu; informacije o popravcima; izgradnja (oglasi o izgradnji), izgradnja \*; iznajmljivanje mašina za gradilišta; izolovanje (usluge izolovanja) [građevinski radovi]; klimatizacija vazduha (postavljanje i popravak uređaja za klimatizaciju); liftovi (postavljanje i popravak liftova); malterisanje; molerske usluge, unutrašnje i spoljašnje [bojanje]; nadzor građevinskih radova [vođenje]; postavljanje skela; prozori i vrata (postavljanje prozora i vrata); putevi (postavljanje slojeva za pokrivanje na ceste); gradilište (iznajmljivanje mašina za gradilište); rušenje građevinskih objekata; skele (postavljanje skela); tapete (postavljanje tapeta); vodoinstalaterski radovi; zaštite građevina od vlage; zgrade (čišćenje zgrada) [spoljnih površina]; zgrade (unutrašnje čišćenje zgrada); zidanje ciglom; zidarski radovi.

Klasa 42: Arhitektura; inženjering; planovi (izrada građevinskih planova); savjeti o gradnji; tehnički projekti (razrada tehničkih projekata); unutrašnje uređenje [dekoracija]; urbanističko planiranje; agencije za smještaj [hotelski, pansioniski].

Klasa 43: Hotelske usluge.

---

(111) **15192**  
(151) 08.03.2021.  
(210) Ž-2020-297  
(220) 19.08.2020.  
(732) "PMTR" DOO, Bulevar Revolucije 11b, Bar, ME

(540)

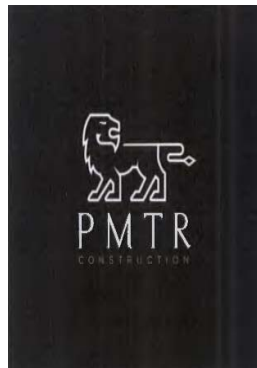

(550) I

(511) Klasa 37: Asfaltiranje; bageri (iznajmljivanje bagera); buldožeri (iznajmljivanje buldožera); bunari (kopanje bunara); bušenje bunara; centralno grijanje (postavljanje i popravak instalacija centralnog grijanja); čišćenje zgrada [spoljnih površina]; građevinski radovi (nadzor građevinskih radova); informacije o graditeljstvu; informacije o popravkama; izgradnja (oglasni o izgradnji), izgradnja \*; iznajmljivanje mašina za gradilišta; izolovanje (usluge izolovanja) [građevinski radovi]; klimatizacija vazduha (postavljanje i popravak uređaja za klimatizaciju); liftovi (postavljanje i popravak liftova); malterisanje; molerske usluge, unutrašnje i spoljašnje [bojanje]; nadzor građevinskih radova [vođenje]; postavljanje skela; prozori i vrata (postavljanje prozora i vrata); putevi (postavljanje slojeva za pokrivanje na ceste); gradilište (iznajmljivanje mašina za gradilište); rušenje građevinskih objekata; skele (postavljanje skela); tapete (postavljanje tapeta); vodoinstalaterski radovi; zaštite građevina od vlage; zgrade (čišćenje zgrada) [spoljnih površina]; zgrade (unutrašnje čišćenje zgrada); zidanje ciglom; zidarski radovi.

Klasa 42: Arhitektura; inženjering; planovi (izrada građevinskih planova); savjeti o gradnji; tehnički projekti (razrada tehničkih projekata); unutrašnje uređenje [dekoracija]; urbanističko planiranje; agencije za smještaj [hotelski, pansioniski].

Klasa 43: Hotelske usluge.

(111) **15193**

(151) 08.03.2021.

(210) Ž-2020-206

(220) 29.05.2020.

(732) DRUŠTVO SA OGRANIČENOM ODGOVORNOŠĆU "COMPANYWALL" DOO  
PODGORICA, Vasa Raičkovića br.4a, Podgorica, ME

(540)



(550) I

(511) Klasa 16: Papir i karton; Štamparski proizvodi; Proizvodi za uvezivanje knjiga; Fotografije; Kancelarijski materijal i potrepštine za kancelariju, osim namještaja; Ljepila (ljepljive materije za papirnate proizvode ili za kućne potrebe); Slikarske četke; Nastavni i obrazovni materijal; Plastične folije, filmovi i kese za umotavanje i pakovanje; Štamparska slova, klišeji.

Klasa 35: Oglašavanje; Vođenje komercijalnih poslova; Komercijalna administracija; Kancelarijski poslovi.

Klasa 36: Osiguranje; Finansijski poslovi; Monetarni poslovi; Upravljanje nekretninama.

Klasa 42: Naučne i tehnološke usluge kao i pripadajuće usluge istraživanja i koncepcije; Usluge industrijskih analiza i istraživanja; Koncepcija i razvoj računara i računarskih programa /hardvera i softvera/.

---

(111) **15194**

(151) 08.03.2021.

(210) Ž-2020-303

(220) 24.08.2020.

(732) "WOOW" D.O.O., 13. JUL, ZGRADA BSP-A, LOKAL 7, BUDVA, ME

(540)



(550) I

(740) AOD "Ćupić", Bulevar Džordža Vašingtona 79, 81000, Podgorica

(511) Klasa 36: Poslovi sa nekretninama; upravljanje nekretninama; obavljanje administrativnih poslova kod nekretnina; upravljanje apartmanima; usluge upravljanja stanovima, zgradama i stambenim objektima; upravljanje zgradama [usluge nekretnina]; upravljanje finansijama i nekretninama apartmana i smještaja, kao sto su hoteli, moteli, hotelski kompleksi, apartmani, condo hoteli; prodaja i iznajmljivanje smještaja, apartmana, studija, soba unutar hotelskih objekata, hotelskih kompleksa, stambenih hotela; iznajmljivanje i upravljanje smještajem za druge; iznajmljivanje nekretnina davanjem u zakup; usluge upravljanja izdavanja smještaja u zakup na određeno vrijeme; pomoćne i konsultantske usluge u oblasti nekretnina za izdavanje; upravljanje i rad sa brendiranim rezidencijama; upravljanje i upravljanje apartmanima sa produženim boravkom; iznajmljivanje stanova, informacijske, savjetodavne i konsultantske usluge koje se odnose na sve gore navedene usluge; uključujući sve gore spomenute usluge koje se pružaju elektronskim putem ili putem interneta iz kompjuterske baze podataka ili putem intemeta; sve uključeno u klasu 36.

Klasa 37: Izgradnja stambenih i poslovnih jedinica.

Klasa 39: Usluge iznajmljivanja vozila; vođenje garaža za parkiranje, iznajmljivanje parking mjesta, obezbjeđivanje prostora za parkiranje, informacijske, savjetodavne i konsultantske usluge koje se odnose na sve gore navedene usluge; uključujući sve gore spomenute usluge koje se pružaju elektronskim putem ili putem interneta iz kompjuterske baze podataka ili putem interneta; sve uključeno u klasu 39.

Klasa 43: Usluge pružanja hrane i pića; privremeni smještaj; hotelske i turističke usluge, usluge hotelskog smještaja; usluge rezervacija za hotelski smještaj; iznajmljivanje soba; rezervacija i rezervacija privremenih smještaja; rezervacija za dugotrajni i kratkotrajni boravak u apartmanima i condo apartmanima; pružanje konferencijskih sadržaja, usluga banketa; bar, kafić, usluge restorana, koktel bar i kafe bar, usluge spremanja hrane; rezervacije za restorane i obroke, bankete i objekte za posebne prilike; informacije o hotelima, odmaralištima, smještajima i restoranima, dostupne kroz bazu podataka na internet pretraživaču; pružanje web stranice koja sadrži usluge online rezervacije za smještaj u hotelima; pružanje sadržaja za kongrese i izložbe; usluge čuvanja djece; pružanje online rezervacija i rezervacija za privremeni smještaj i smještaj; rezervacija hotela za druge; rezervacija i rezervisanje drugima smještaj u hotelima; informacijske, savjetodavne i konsultantske usluge koje se odnose na sve gore navedene usluge; uključujući sve gore spomenute usluge koje se pružaju elektronskim putem ili putem interneta iz kompjuterske baze podataka ili putem interneta; sve uključeno u klasu 43.

---

(111) **15195**

(151) 08.03.2021.

(210) Ž-2020-13

(220) 20.01.2020.

(732) Anja Cosmetics DOO, Radoja Dakića 17, 81000, Podgorica, ME

(540)



(550) I

(511) Klasa 3: preparati za bijeljenje i ostale materije za pranje rublja; preparati za čišćenje, poliranje, odmaščivanje i struganje; sapuni; parfimerijski proizvodi, eterična ulja, kozmetički proizvodi, losioni za kosu; proizvodi za njegu zuba; brijanje; čišćenje (proizvodi za čišćenje); dezinfekcioni [dezinfekcioni] sapuni; dezodoransi za kućne ljubimce; dezodoransi za ljude ili za životinje; dezodoranski sapuni; eterična ulja; eterične esencije; kolonjska voda; korund [abrazivno sredstvo]; kosa (boje za kosu); kosa (sredstva za bojenje kose); kovrdžanje kose (sredstva za kovrdžanje kose); kovrdžava kosa (sredstva za ravnanje prirodno kovrdžave kose); kozmetičke boje; kozmetički losioni (peškirići namočeni u kozmetičke losione); kozmetički nesereri [torbe s kozmetičkim proizvodima]; kozmetički proizvodi; kozmetički proizvodi za mršavljenje; kozmetički proizvodi za životinje; kozmetika (ukrasni detalji za kozmetičku upotrebu); koža (kozmetički proizvodi za njegu kože); koža (kreme za čišćenje kože); kućni ljubimci (šamponi za kućne ljubimce); kupanje (kozmetički preparati za kupanje); kupanje (soli za kupanje) ne za medicinske potrebe; lakovi (proizvodi za uklanjanje lakova); lakovi (sredstva za skidanje lakova); lakovi za kosu; lakovi za nokte; lavandino ulje; losioni (kozmetički losioni); losioni za kosu; losioni za upotrebu poslije brijanja; ljepila za kozmetičke potrebe; ljepota (maske za ljepotu); maramice namočene u kozmetičke losione; maskara; maskare [parfimerijski proizvod]; maske za ljepotu; masti za kozmetičke potrebe; medicinski sapuni; mirisi [parfemi]; mirisne vodice; mlijeko (bademovo za kozmetiku); mlijeko (toaletno mlijeko); mrlje (sredstva za uklanjanje mrlja); ;mršavljenje (kozmetički preparati za mršavljenje); nokti (lak za nokte); nokti (naljepnice za nokte); nokti (proizvodi za njegu noktiju); njega kože (kozmetički proizvodi za njegu kože); njega usta (nemedicinski proizvodi za njegu usta); olovke za kozmetičke potrebe; papir za poliranje [brusni]; parfemi; parfi miranje rublja (proizvodi za parfi miranje rublja); parfi miranje vazduha (preparati za parfi miranje vazduha); paste za brijanje (pasta za brijanje); poliranje (papir za poliranje); poliranje (platno za poliranje); poliranje (preparati za poliranje); pomade za kozmetičke potrebe; pranje (proizvodi za pranje); pranje [bijeljenje] (proizvodi za bijeljenje rublja); pranje [bijeljenje] (proizvodi za pranje rublja utrljavanjem); pribor za brijanje; pribor za brijanje (pasta za brijanje); puder za šminkanje [milovka]; rastvarači boje; ravnanje prirodno kovrdžave kose (sredstva za ravnanje prirodno kovrdžave kose); sapuni; sapuni protiv znojenja; sapuni za dezinfkciju [dezinfekciju]; sapuni za oživljavanje boja tekstila; sapuni za uklanjanje neugodnih mirisa [dezodoransi]; sapuni za umivanje; sjaj (proizvodi za postizanje sjaja); sjajila za usne; soli mineralne vode; soli za izbjeljivanje; soli za nemedicinske kupke; sunčanje (kozmetički preparati za sunčanje); sunčanje, preparati za sunčanje (kozmetički); šminka (proizvodi za skidanje šminke); šminkanje (proizvodi za šminkanje); toaletna sredstva protiv znojenja; toaletna ulja; toaletni proizvodi; trepavice (kozmetički proizvodi za trepavice); trepavice (vještačke trepavice); tuširanje (preparati za tuširanje za ličnu higijensku upotrebu ili lične potrebe) [toaletne potrepštine]; ulja (eterična ulja); ulje (bademovo ulje); ulje za čišćenje; ulje za kozmetičke potrebe; ulje za parfi meriju; usne (rumenilo za usne) [ruž]; usta (nemedicinski proizvodi za njegu usta); vata za kozmetičke potrebe; vještačke trepavice; vještačke trepavice (ljepila za vještačke trepavice); vještački brkovi, brade, kosa (ljepila za učvršćenje vještačkih brkova, brada i kose); vještački nokti;

vosak [vosak]; zanoktice (makaze za zanoktice); vosak za brkove; vosak za uklanjanje dlačica.

Klasa 5: farmaceutski i veterinarski proizvodi; higijenski proizvodi za upotrebu u medicini; dijetalne materije za medicinske potrebe, hrana za bebe; flasteri, materijal za previjanje; materijali za plombiranje zuba i za zubne otiske; dezinfekciona sredstva; proizvodi za uništavanje životinjskih štetočina; fungicidi, herbicidi; dezodoransna sredstva osim onih za ličnu upotrebu ili za životinje; dezodoransna sredstva za odjeću i teksti; fungicidi; kosa (medicinski preparati za rast kose); koža (farmaceutski proizvodi za njegu kože); kupke (medicinske kupke); kupke (soli za medicinske kupke); kupke (terapeutski preparati za kupke); kupke s kiseonikom; kupke, medicinske (morska voda za medicinske kupke); kurje oči (proizvodi protiv stvaranja kurjih očiju); losioni za veterinarsku upotrebu; losioni, farmaceutski (maramice natopljene farmaceutskim losionima); medicinski alkohol; melemi za utrljavanje; mineralne kupke (soli za mineralne kupke); mineralne vode (soli mineralnih voda za kupke); mineralne vode (soli mineralnih voda); mirisne soli protiv nesvjestic; mlijeko od badema za farmaceutske potrebe; mirisni, dimeći štapići; mirođija za medicinske potrebe; mršavljenje (medicinski čaj za mršavljenje); mršavljenje (medicinski preparati za mršavljenje); mršavljenje (tablete za mršavljenje); narukvice protiv reume; njega usta (medicinski proizvodi za njegu usta); olovke za spaljivanje rana, kaustične olovke; olovke za uklanjanje bradavica; olovke za zaustavljanje krvarenja [hemostatske]; osvježavanje vazduha (sredstva za osvježavanje vazduha); perut (farmaceutski proizvodi protiv peruti); peškirići natopljeni farmaceutskim losionom; pranje životinja (proizvodi za pranje životinja); psi (losioni za pse); psi (sredstva za odbijanje insekata kod pasa) [repulzivi]; psi (sredstva za pranje pasa); rashladni sprejevi za medicinske svrhe; ricinusovo ulje za medicinske potrebe; serumi; soli za medicinske kupke; soli za medicinske potrebe; sterilizacija (proizvodi za sterilizaciju); sunčanica (farmaceutski proizvodi protiv sunčanice); terapeutski preparati za kupke; ulje (kamforno ulje za medicinske potrebe); ulje za medicinske potrebe; vazduh (preparati za parfemisanje vazduha); vazduh (proizvodi za osvježavanje vazduha); vitaminski preparati.

Klasa 8: ručni alati i sprave sa ručnim pokretanjem; parati za brijanje; hvataljke [pincete]; mehaničke i elektronske sprave za brijanje; aparati za brijanje; kosa (metalni uvijači za kosu); kosa (ručne sprave za kovrdžanje kose); kosa (sprave za šišanje kose, električne i neelektrične); kovrdžanje kose (ručne sprave za kovrdžanje kose); makaze; makaze za nokte, električne ili neelektrične; makaze za zanoktice; manikirski pribor (električni manikirski pribor); manikirski pribor (torbe za manikirski pribor); nokti (makaze za nokte, električne ili obične); nokti (sjeckalica za nokte); nokti (turpijice za nokte); nožići; oštrice aparata za brijanje; pedikiranje (torbe s priborom za pedikiranje); pincete; pincete za uklanjanje dlačica; poliranje noktiju (električne ili neelektrične sprave za poliranje noktiju); pribor za brijanje; šišanje (ručni pribor za šišanje); šišanje brade (sprave za šišanje brade); šišanje kose (uređaji za šišanje kose, električni ili neelektrični); tetoviranje (aparati za tetoviranje); trepavice (spravica za savijanje trepavica); turpije; turpije [alat]; turpijice (električne turpijice za nokte); turpijice od šmirgle [sitno zrnatog korunda]; uši (aparati za bušenje ušiju); zanoktice (makaze za zanoktice).

Klasa 11: uređaji za rasvjetu, grijanje, proizvodnju pare, kuvanje, hlađenje, sušenje, ventilaciju, vodosnadbjevanje i za sanitarnu opremu; aparati za dezinfekciju; fenovi za kosu [električni uređaji]; grijači za kovrdžanje kose; grijalice za noge, električne; grijalice za noge, električne ili neelektrične; grijalice, neelektrične; grijanje (električni uređaji za grijanje); jastuci, električno grijani za nemedicinske potrebe; kabine, prenosive za turska kupatila; kabine za tuširanje; kosa (sušila za kosu) [uređaji]; kosa (elektrotermičke sprave za

kovrdžanje kose); kupke na kade za sjedenje (kade za kupke na kade za sjedenje); kupke s toplim vazduhom (uređaji za kupke s toplim vazduhom); kupke s vrtložnom vodom; parenje lica (uređaji za parenje lica) [vaporizatori]; pokrivači (električno grijani pokrivači) nisu za medicinske potrebe; sterilizacija (vrećice za sterilizaciju za jednokratnu upotrebu); sterilizatori; sunčanje, aparati za solarijume; sunčani kreveti).

Klasa 21: pribor i posude za domaćinstvo ili za kuhinju; češljeve i sunđere; četke (osim kičica); materijali za četke; pribor za čišćenje; žica za struganje parketa; sirovo ili polu obrađeno staklo (osim građevinskog stakla);

stakleni proizvodi, porculansko i keramičko posuđe koje nije obuhvaćeno drugim klasama; češljevi; češljevi, električni; četke (električne četke) [nisu dijelovi mašina]; četke; kozmetički pribor; mirisne materije (posudice za paljenje mirisnih materija); nokti (četkice za nokte); peškiri, papirnati (kutije za papirnate peškire); puderisanje (jastučići za puderisanje); pudrijere; rukavice za potrebe domaćinstva; sapun (posudice za sapun); šminka (pribor za skidanje šminke).

Klasa 26: čipka, vez, vrpce i gajtane; dugmad, kopče i petlje, špenadle (duple igle) i igle; vještačko cvijeće; kosa (ekstenzije za kosu); kosa (igle za kosu); kosa (ljudska kosa); kosa (mrežice za kosu); kosa (pletence od kose); kosa (trakice za kosu); kosa (ukosnice za kosu); kosa (ukrasni predmeti za kosu); kosa, vještačka; kovrdžanje kose (ukosnice za kovrdžanje kose); papirići za kovrdžanje.

---

(111) **15196**

(151) 08.03.2021.

(210) Ž-2020-14

(220) 22.01.2020.

(732) Bosnalijek, farmaceutska i hemijska industrija, dioničko društvo, Jukićeva 53, 71000, Sarajevo, BA

(540)

**FOLESSA**

(550) I

(740) Božidar S. Radulović, Baku 30/5, 81000, Podgorica

(511) Klasa 5: Farmaceutski proizvodi.

---

(111) **15197**

(151) 08.03.2021.

(210) Ž-2020-15

(220) 22.01.2020.

(732) Bosnalijek, farmaceutska i hemijska industrija, dioničko društvo, Jukićeva 53,  
71000, Sarajevo, BA

(540)

LENOCOR

(550) I

(740) Božidar S. Radulović, Baku 30/5, 81000, Podgorica

(511) Klasa 5: Farmaceutski proizvodi.

---

(111) **15198**

(151) 08.03.2021.

(210) Ž-2020-262

(220) 24.07.2020.

(732) Amgen Inc., One Amgen Center Drive, 91320-1799, Thousand Oaks, California, US

(540)



(550) I

(740) Božidar S.Radulović, Baku 30/5, 81000, Podgorica

(511) Klasa 5: Farmaceutski preparati; farmaceutski preparati za liječenje kardiovaskularnih bolesti i poremećaja.

---

(111) **15199**

(151) 09.03.2021.

(210) Ž-2020-67

(220) 25.02.2020.

(732) Bojan Joković, Petra Lubarde 114, 81000, Podgorica, ME

(540)





(550) I

(511) Klasa 37: Usluge izgradnje zgrada, puteva, mostova, brana, dalekovoda kao i usluge specijalizovanih preduzeća u području izgradnje, kao što su moleri, limari postavljači centralnog grijanja i pokrivači krovova; popravke, to jest usluge obnavljanja bilo kojeg dotrajalog, oštećenog ili djelimično razrušenog objekta (prenamjena ili obnavljanje zgrada ili nekog drugog objekta čije prvobitno stanje ne zadovoljava).

---

(111) **15200**

(151) 09.03.2021.

(210) Ž-2020-304

(220) 24.08.2020.

(732) ALDI Einkauf GmbH & Co. oHG, Eckenbergstr. 16 A, D-45307, Essen, DE

(540)



(550) I

(740) Pavle Tripković, City kvart - Cetinjski put 40, L5-1, stan 10, Podgorica

(511) Klasa 35: Usluge maloprodaje u pogledu poljoprivrednih proizvoda, proizvoda za hortikulturu, proizvoda za šumarstvo, namirnica, preparata za pranje, preparata za čišćenje, proizvoda namenjenih za čišćenje, sredstava za dezinfekciju, kozmetike, sanitarnih proizvoda, lekova koji se izdaju bez recepta, dodataka ishrani (suplemenata), vatrometa, električnih aparata i pribora, elektronskih aparata i pribora za njih, kompjutera i kompjuterskog pribora, kompakt diskova, kompjuterskog hardvera i softvera, uređaja za rasvetu, alata, baštenskih aparata i pribora za njih, bicikala i pribora za njih, pribora za automobile, zidnih satova, ručnih satova i nakita, kancelarijske opreme i rekvizita za kancelarije, knjiga i drugih štampanih stvari, nameštaja i drugih artikala za opremanje enterijera, baštenskog nameštaja, pribora za kuhinju i domaćinstvo i opreme za njih, proizvoda za upotrebu u domaćinstvu, prekrivača za krevete, uključujući jastuke, posteljinu, tekstil za upotrebu u domaćinstvu, odeće, pokrivki za glavu, cipela, proizvoda od kože, sportske opreme, igraćaka, proizvoda za razonodu / slobodno vreme, namirnica za životinje,

biljaka, proizvoda od duvana; Onlajn usluge maloprodaje u pogledu poljoprivrednih proizvoda, proizvoda za hortikulturu, proizvoda za šumarstvo, namirnica, preparata za pranje, preparata za čišćenje, proizvoda namenjenih za čišćenje, sredstava za dezinfekciju, kozmetike, sanitarnih proizvoda, lekova koji se izdaju bez recepta, dodataka ishrani (suplemenata), vatrometa, električnih aparata i pribora, elektronskih aparata i pribora za njih, kompjutera i kompjuterskog pribora, kompakt diskova, kompjuterskog hardvera i softvera, uređaja za rasvetu, alata, baštenskih aparata i pribora za njih, bicikala i pribora za njih, pribora za automobile, zidnih satova, ručnih satova i nakita, kancelarijske opreme i rekvizita za kancelarije, knjiga i drugih štampanih stvari, nameštaja i drugih artikala za opremanje enterijera, baštenskog nameštaja, pribora za

kuhinju i domaćinstvo i opreme za njih, proizvoda za upotrebu u domaćinstvu, prekrivača za krevete, uključujući jastuke, posteljinu, tekstil za upotrebu u domaćinstvu, odeće, pokrivki za glavu, cipela, proizvoda od kože, sportske opreme, igračka, proizvoda za razonodu / slobodno vreme, namirnica za životinje, biljaka, proizvoda od duvana; Usluge veleprodaje u pogledu poljoprivrednih proizvoda, proizvoda za hortikulturu, proizvoda za šumarstvo, namirnica, preparata za pranje, preparata za čišćenje, proizvoda namenjenih za čišćenje, sredstava za dezinfekciju, kozmetike, sanitarnih proizvoda, lekova koji se izdaju bez recepta, dodataka ishrani (suplemenata), vatrometa, električnih aparata i pribora, elektronskih aparata i pribora za njih, kompjutera i kompjuterskog pribora, kompakt diskova, kompjuterskog hardvera i softvera, uređaja za rasvetu, alata, baštenskih aparata i pribora za njih, bicikala i pribora za njih, pribora za automobile, zidnih satova, ručnih satova i nakita, kancelarijske opreme i rekvizita za kancelarije, knjiga i drugih štampanih stvari, nameštaja i drugih artikala za opremanje enterijera, baštenskog nameštaja, pribora za kuhinju i domaćinstvo i opreme za njih, proizvoda za upotrebu u domaćinstvu, prekrivača za krevete, uključujući jastuke, posteljinu, tekstil za upotrebu u domaćinstvu, odeće, pokrivki za glavu, cipela, proizvoda od kože, sportske opreme, igračka, proizvoda za razonodu / slobodno vreme, namirnica za životinje, biljaka, proizvoda od duvana; Usluge u vođenju rada supermarketa, maloprodajnih radnji i diskontnih maloprodajnih radnji; Usluge oglašavanja; usluge oglašavanja putem interneta, za treća lica; Usluge pružanja informacija putem interneta, naime informacija o proizvodima za potrošače, informacija za savetovanje potrošača i servisnih informacija za potrošače; Usluge organizacije komercijalnih transakcija za treća lica, takođe i putem interneta; Usluge pribavljanja / sklapanja ugovora u oblasti mobilne telefonije za treća lica; Usluge poslovnog menadžmenta; Usluge organizacionog planiranja i nadzora poslovnog razvoja; Regrutacija kadrova; Usluge konsultacija u poslovnoj organizaciji; Usluge asistencije u komercijalnom ili industrijskom menadžmentu; Pružanje usluga za treća lica (kupovanje roba i usluga za druga preduzeća).

---

(111) **15201**

(151) 09.03.2021.

(210) Ž-2020-305

(220) 24.08.2020.

(732) ALDI GmbH & Co. KG, Burgstr. 37, D-45476, Mülheim an der Ruhr, DE

(540)

## ALDI

(550) I

(740) Pavle Tripković, City kvart - Cetinjski put 40, L5-1, stan 10, Podgorica

(511) Klasa 35: Usluge maloprodaje u pogledu poljoprivrednih proizvoda, proizvoda za hortikulturu, proizvoda za šumarstvo, namirnica, preparata za pranje, preparata za čišćenje, proizvoda namenjenih za čišćenje, sredstava za dezinfekciju, kozmetike, sanitarnih proizvoda, lekova koji se izdaju bez recepta, dodataka ishrani (suplemenata), vatrometa, električnih aparata i pribora, elektronskih aparata i pribora za njih, kompjutera i kompjuterskog pribora, kompakt diskova, kompjuterskog hardvera i softvera, uređaja za rasvetu, alata, baštenskih aparata i pribora za njih, bicikala i pribora za njih, pribora za automobile, zidnih satova, ručnih satova i nakita, kancelarijske opreme i rekvizita za kancelarije, knjiga i drugih štampanih stvari, nameštaja i drugih artikala za opremanje enterijera, baštenskog nameštaja, pribora za kuhinju i domaćinstvo i opreme za njih, proizvoda za upotrebu u domaćinstvu, prekrivača za krevete, uključujući jastuke, posteljinu, tekstil za upotrebu u domaćinstvu, odeće, pokrivki za glavu, cipela, proizvoda od kože, sportske opreme, igračaka, proizvoda za razonodu / slobodno vreme, namirnica za životinje, biljaka, proizvoda od duvana; Onlajn usluge maloprodaje u pogledu poljoprivrednih proizvoda, proizvoda za hortikulturu, proizvoda za šumarstvo, namirnica, preparata za pranje, preparata za čišćenje, proizvoda namenjenih za čišćenje, sredstava za dezinfekciju, kozmetike, sanitarnih proizvoda, lekova koji se izdaju bez recepta, dodataka ishrani (suplemenata), vatrometa, električnih aparata i pribora, elektronskih aparata i pribora za njih, kompjutera i kompjuterskog pribora, kompakt diskova, kompjuterskog hardvera i softvera, uređaja za rasvetu, alata, baštenskih aparata i pribora za njih, bicikala i pribora za njih, pribora za automobile, zidnih satova, ručnih satova i nakita, kancelarijske opreme i rekvizita za kancelarije, knjiga i drugih štampanih stvari, nameštaja i drugih artikala za opremanje enterijera, bastenskog nameštaja, pribora za kuhinju i domaćinstvo i opreme za njih, proizvoda za upotrebu u domaćinstvu, prekrivača za krevete, uključujući jastuke, posteljinu, tekstil za upotrebu u domaćinstvu, odeće, pokrivki za glavu, cipela, proizvoda od kože, sportske opreme, igračaka, proizvoda za razonodu / slobodno vreme, namirnica za životinje, biljaka, proizvoda od duvana; Usluge veleprodaje u pogledu poljoprivrednih proizvoda, proizvoda za hortikulturu, proizvoda za šumarstvo, namirnica, preparata za pranje, preparata za čišćenje, proizvoda namenjenih za čišćenje, sredstava za dezinfekciju, kozmetike, sanitarnih proizvoda, lekova koji se izdaju bez recepta, dodataka ishrani (suplemenata), vatrometa, električnih aparata i pribora, elektronskih aparata i pribora za njih, kompjutera i kompjuterskog pribora, kompakt diskova, kompjuterskog hardvera i softvera, uređaja za rasvetu, alata, baštenskih aparata i pribora za njih, bicikala i pribora za njih, pribora za automobile, zidnih satova, ručnih satova i nakita, kancelarijske opreme i rekvizita za kancelarije, knjiga i drugih štampanih stvari, nameštaja i drugih artikala za opremanje enterijera, baštenskog nameštaja, pribora za kuhinju i domaćinstvo i opreme za njih, proizvoda za upotrebu u domaćinstvu, prekrivača za krevete, uključujući jastuke, posteljinu, tekstil za upotrebu u domaćinstvu, odeće, pokrivki za glavu, cipela, proizvoda od kože, sportske opreme, igračaka, proizvoda za razonodu / slobodno vreme, namirnica za životinje, biljaka, proizvoda od duvana; Usluge u vođenju rada supermarketa, maloprodajnih radnji i diskontnih maloprodajnih radnji; Usluge oglašavanja; usluge oglašavanja putem interneta, za treća lica; Usluge pružanja informacija putem interneta, naime informacija o proizvodima

za potrošače, informacija za savetovanje potrošača i servisnih informacija za potrošače; Usluge organizacije komercijalnih transakcija za treća lica, takođe i putem interneta; Usluge pribavljanja / sklapanja ugovora u oblasti mobilne telefonije za treća lica; Usluge poslovnog menadžmenta; Usluge organizacionog planiranja i nadzora poslovnog razvoja; Regrutacija kadrova; Usluge konsultacija u poslovnoj organizaciji; Usluge asistencije u komercijalnom ili industrijskom menadžmentu; Pružanje usluga za treća lica (kupovanje roba i usluga za druga preduzeća).

---

(111) **15202**

(151) 09.03.2021.

(210) Ž-2020-306

(220) 28.08.2020.

(732) Bosnalijek, farmaceutska i hemijska industrija, dioničko društvo, Jukićeva 53, 71000, Sarajevo, BA

(540)

RIVER

(550) I

(740) Božidar S.Radulović, Baku 30/5, 81000, Podgorica

(511) Klasa 5: Farmaceutski proizvodi.

---

(111) **15203**

(151) 09.03.2021.

(210) Ž-2020-134

(220) 30.04.2020.

(732) Lidl Stiftung & Co. KG , Stiftsbergstrasse 1, 74172, Neckarsulm, DE

(540)



(550) I

(740) AOD "Lutovac & partneri", Bulevar Ivana Crnojevića 93, 81000, Podgorica

(511) Klasa 33: Alkoholna pića (osim piva), naročito vermut, kokteli.

---

(111) **15204**

(151) 09.03.2021.

(210) Ž-2020-135

(220) 30.04.2020.

(732) Lidl Stiftung & Co. KG , Stiftsbergstrasse 1, 74172, Neckarsulm, DE

(540)



(550) I

(740) AOD "Lutovac & partneri", Bulevar Ivana Crnojevića 93, 81000, Podgorica

(511) Klasa 3: Sredstva za čišćenje zuba, za nemedicinsku upotrebu, preparati za oralnu i zubnu higijenu (osim sredstava za njegu usana), naročito preparati za ispiranje usta, sprejevi za usta, za nemedicinsku upotrebu, tablete za bojanje kamenca, preparati za izbjeljivanje zuba ( za nemedicinsku upotrebu); sva gore navedena roba u klasi 03.

Klasa 5: Ljepila za proteze, ljepila za zubnu i stomatološku upotrebu.

Klasa 21: Četkice za zube, glave za četkice za zube, konac za čišćenje zuba.

---

(111) **15205**

(151) 09.03.2021.

(210) Ž-2020-164

(220) 25.05.2020.

(732) The Procter & Gamble Company, One Procter & Gamble Plaza, 45202, Cincinnati, Ohio, US

(540)

## PAMPERS HARMONIE

(550) I

(740) AOD "Lutovac & partneri", Bulevar Ivana Crnojevića 93, 81000, Podgorica

(511) Klasa 3: Vlažne maramice od papira i/ili celuloze.  
Klasa 5: Pelene od papira i/ili celuloze za jednokratnu upotrebu.

---

(111) **15206**

(151) 09.03.2021.

(210) Ž-2020-165

(220) 25.05.2020.

(732) The Procter & Gamble Company, One Procter & Gamble Plaza, 45202, Cincinnati, Ohio, US

(540)



(550) I

(740) AOD "Lutovac & partneri", Bulevar Ivana Crnojevića 93, 81000, Podgorica

(511) Klasa 3: Vlažne maramice od papira i/ili celuloze.  
Klasa 5: Pelene od papira i/ili celuloze za jednokratnu upotrebu.

---

(111) **15207**

(151) 10.03.2021.

(210) Ž-2020-211

(220) 22.06.2020.

(732) Lidl Stiftung & Co. KG, Stiftsbergstrasse 1, 74172, Neckarsulm, DE

(540)



(550) I

(740) AOD "Lutovac & partneri", Bulevar Ivana Crnojevića 93, 81000, Podgorica

(511) Klasa 29: Mlijeko i mliječni proizvodi, naročito svježi sir, nepasterizovani sir, mocarela, maskarpone sir, tvrdi sir.

---

(111) **15208**

(151) 10.03.2021.

(210) Ž-2020-228

(220) 03.07.2020.

(732) Ferrarelle S.p.A., Via di Porta Pinciana n.4, 00187, Roma RM, IT

(540)

**FERRARELLE**

(550) I

(740) AOD "Lutovac & partneri", Bulevar Ivana Crnojevića 93, 81000, Podgorica

(511) Klasa 32: Bezalkoholni voćni ekstrakti; voćni sokovi; bezalkoholna pića od voćnih sokova; vode [pića]; preparati za pravljenje gazirane vode; mineralna voda [pića]; stonove vode; soda voda; bezalkoholna pića; gazirana voda; bezalkoholni aperitivi; bezalkoholni kokteli; izotonična pića; sportska pića obogaćena proteinima; osvježavajuća bezalkoholna pića; energetska pića.

---

(111) **15209**

(151) 10.03.2021.

(210) Ž-2020-229

(220) 03.07.2020.

(732) Ferrarelle S.p.A., Via di Porta Pinciana n.4, 00187, Roma RM, IT

(540)



(550) I

(740) AOD "Lutovac & partneri", Bulevar Ivana Crnojevića 93, 81000, Podgorica

(511) Klasa 32: Bezalkoholni voćni ekstrakti; voćni sokovi; bezalkoholna pića od voćnih sokova; vode [pića]; preparati za pravljenje gazirane vode; mineralna voda [pića]; stonove vode; soda voda; bezalkoholna pića; gazirana voda; bezalkoholni aperitivi; bezalkoholni kokteli; izotonična pića; sportska pića obogaćena proteinima; osvježavajuća bezalkoholna pića; energetska pića.

---

(111) **15210**

(151) 10.03.2021.

(210) Ž-2020-250

(220) 16.07.2020.

(732) Lidl Stiftung & Co. KG, Stiftsbergstrasse 1, 74172, Neckarsulm, DE

(540)

**CHENE D'ARGENT**

(550) I

(740) AOD "Lutovac & partneri", Bulevar Ivana Crnojevića 93, 81000, Podgorica

(511) Klasa 29: Mlijeko i mliječni proizvodi, sir i proizvodi od sira.

---

(111) **15211**

(151) 10.03.2021.

(210) Ž-2020-251

(220) 16.07.2020.



(732) The Procter & Gamble Company, One Procter & Gamble Plaza, 45202, Cincinnati, Ohio, US

(540)

## PUREZYME

(550) I

(740) AOD "Lutovac & partneri", Bulevar Ivana Crnojevića 93, 81000, Podgorica

(511) Klasa 1: Enzimski preparati za upotrebu u industriji deterdženata.

Klasa 3: Preparati za bieljenje; preparati za čišćenje; etarska ulja; oplemenjivači rublja za upotrebu u perionicama; bjelila za veš; preparati za pranje; ulja za čišćenje; sapun; preparati za uklanjanje mrlja.

---

(111) **15212**

(151) 10.03.2021.

(210) Ž-2020-264

(220) 28.07.2020.

(732) THE GILLETTE COMPANY LLC, One Gillette Park , 02127, Boston, Massachusetts, US

(540)



(550) I

(740) AOD "Lutovac & partneri", Bulevar Ivana Crnojevića 93, 81000, Podgorica

(511) Klasa 3: Preparati za njegu zuba; preparati za oralnu higijenu; preparati za čišćenje zuba; paste za zube; losioni za čišćenje zuba; preparati za čišćenje proteza; tečnosti za ispiranje usta; nemedicinske tečnosti za dentalno ispiranje; nemedicinski sprejevi za usta; osvježivači daha; trake za osvježavanje daha; sprejevi za grlo [nemedicinski]; gelovi za izbjeljivanje zuba; trake za izbjeljivanje zuba impregnirane preparatima za izbjeljivanje zuba [kozmetika]; sredstva za poliranje zuba; sredstva za poliranje proteza; praškovi za zube; navlaženi praškovi za zube; tablete za ličnu upotrebu za otkrivanje zubnog kamenca na zubima.

---

(111) **15213**  
(151) 10.03.2021.  
(210) Ž-2020-72

(220) 27.02.2020.  
(732) Colgate-Palmolive Company (a Delaware corporation), 300 Park Avenue, 10022,  
New York, New York, US  
(540)

## HERBAL SMOOTHIE

(550) I

(740) Jasna Jusić, Marka Radovića 37, 1. sprat, stan br. 4., 81000, Podgorica

(511) Klasa 3: Pasta za zube i tečnost za ispiranje usta.

---

(111) **15214**  
(151) 10.03.2021.  
(210) Ž-2020-141

(220) 06.05.2020.  
(732) Colgate-Palmolive Company (a Delaware Corporation), 300 Park Avenue, 10022,  
New York, New York, US  
(540)

## COLGATE LINK

(550) I

(740) Jasna Jusić, Marka Radovića 37, 1. sprat, stan br. 4., 81000, Podgorica

(511) Klasa 21: Četkice za zube.

---

(111) **15215**  
(151) 10.03.2021.  
(210) Ž-2020-159

(220) 08.05.2020.  
(732) Colgate-Palmolive Company, a Delaware Corporation, 300 Park Avenue, 10022,  
New York, New York, US  
(540)

## COLGATE ELIXIR

(550) I

(740) Jasna Jusić, Marka Radovića 37, 1. sprat, stan br. 4., 81000, Podgorica

(511) Klasa 3: Pasta za zube i tečnost za ispiranje usta.

---

(111) **15216**

(151) 03.03.2021.

(210) Ž-2019-13

(220) 21.01.2019.

(732) Pharmacia & Upjohn Company LLC, 7000 Portage Road, MI 49001, Kalamazoo, Michigan, US

(540)



(550) I

(740) Jasna Jusić, Dalmatinska 2, 81000, Podgorica

(511) Klasa 5: Farmaceutski proizvodi, medicinski i veterinarski preparati; sanitarni preparati za medicinske svrhe; dijetetska hrana i supstance za medicinsku ili veterinarsku upotrebu, hrana za bebe; dijetetski suplementi za ljude i životinje; flasteri, materijali za zavijanje; materijali za plombiranje zuba, zubarska smola; dezinfekciona sredstva; preparati za uništavanje štetočina; fungicidi, herbicidi.

Klasa 10: Hirurški, medicinski, zubarski i veterinarski aparati i instrumenti; vještački udovi, oči i zubi; ortopedski artikli; hirurški materijali za zašivanje; terapijska i pomoćna sredstva prilagođena osobama sa invaliditetom; aparati za masažu; aparati, uređaji i artikli za dojenčad; aparati, uređaji i artikli za seksualne aktivnosti; medicinski uređaji za oftalmološku upotrebu.

Klasa 44: Medicinske usluge; veterinarske usluge; higijenska zaštita i njega ljepote za ljude ili životinje; agrikulturne, hortikulturne i šumarkse usluge.

---

(111) **15217**

(151) 10.03.2021.

(210) Ž-2019-460

(220) 22.11.2019.

(732) "ESSE" OOD, 95 "Hadzhi Dimitar Asenov" str. , 6000, Stara Zagora, BG

(540)

ELLA

(550) I

(740) Božidar S. Radulović, Studentska bb, Lamela 3/18, 81000, Podgorica

(511) Klasa 34: Duvan; cigare; cigarete; artikli za pušače; šibice.

---

(111) **15218**

(151) 12.03.2021.

(210) Ž-2019-474

(220) 04.12.2019.

(732) Lidl Stiftung & Co. KG , Stiftsbergstraße 1, 74172, Neckarsulm, DE

(540)



(550) I

(740) AOD MSA IP - Milojević Sekulić Advokati, Karađorđeva 65, 11000, Beograd

(511) Klasa 29: Meso i mesni proizvodi; riba i proizvodi od ribe; živina i živinski proizvodi; divljač i proizvodi od divljači; kobasice i suhomesnati proizvodi; školjke (nežive), proizvodi napravljeni od školjki (neživih); plodovi mora (neživi), proizvodi napravljeni od plodova mora (neživih); ekstrakti od mesa, ribe, živine, divljači, školjki, povrća i voća; pulpa od voća i povrća; Proizvodi od krompira svih vrsta koji su obuhvaćeni klasom 29; svi gorenavedeni proizvodi u prerađenom, konzerviranom, kivanom, sušenom ili zamrznutom obliku; prerađeno, zmrznuto, sušeno i kuvano voće i povrće; svi gorenavederi proizvodi takođe i u ukiseljenom obliku; želei; džemovi, marmelade, kompoti, slatki namazi napravljeni od voća ili povrća, slatki namazi od orašastih plodova; jaja; sirevi, puter, mleko i mlečni proizvodi, proizvodi od sira, pavlaka, jogurti, beli sveži sirevi, mleko u prahu za ishranu; deserti od voća, orašastih plodova, jogurta, krem sira i/ili pavlake; bademi i orašasti plodovi (pripremljeni), mešavine orašastih plodova, mešavine orašastih plodova svih vrsta koje sadrže sušeno voće; jestiva ulja i masti; maslinovo ulje; predjela koja se uglavnom sastoje od mesa i/ili ribe i/ili od plodova mora i/ili živine i/ili divljači i/ili kobasice i/ili povrća i/ili voća, sve što je obuhvaćeno klasom 29; supe; konzervirano povrće; bujoni; salate koje se

uglavnom sastoje od mesa, ribe, živine, divljači, školjki, povrća, voća i/ili mlečnih proizvoda; gotova jela koja se uglavnom sastoje od mesa, ribe, živine, divljači, školjki, krompira, povrća, voća i/ili mlečnih proizvoda; zamrznuta hrana koja se uglavnom sastoji od mesa, ribe, živine, divljači, školjki, krompira, povrća, voća i/ili mlečnih proizvoda; dijetetska hrana koja nije namenjena za medicinsku upotrebu koja se uglavnom sastoji od mesa, ribe, živine, divljači, školjki, povrća, voća i/ili mlečnih proizvoda; ulja za kuvanje (osim esencijalnih ulja).

Klasa 30: Kafa, čaj, kakao; šećer; pirinač, tapioka, sago; zamene za kafu; pića na bazi kafe, čaja, kakaoa ili čokolade; proizvodi od kafe i kakaoa za pripremu alkoholnih i bezalkoholnih napitaka; brašno, griz i prerađevine od žitarica, prezle, kuglice za supu; žitarice, musli i proizvodi od celog zrna žitarica; testenina, peciva (hrana od brašna), proizvodi od testenine, proizvodi na bazi rezanaca, salate sa testeninom; pice i proizvodi na bazi pice; lazanje, kore za lazanje; suši; buhtle; proizvodi od hleba; gotove smese za pripremu peciva; peciva i poslastice; konditorski proizvodi; čokolada; proizvodi od čokolade; praline; svi gore navedeni proizvodi čiji je sastojak zamena za šećer; gotove smese za pripremu rezanaca svih vrsta; gotovo testo, naročito smese za knedle, kiselo testo, peciva od lisnatog testa; pekarski proizvodi, naime prašak za pecivo, kvasac, filovi za kolače, prelive, glazure, proizvodi za učvršćivanje šlaga, arome za kolače, šećerni posipi, pasta od badema, pasta od orašastih plodova, pekarski vafli, vanila i vanilin šećer, vanila štapići; skrob koji se koristi u prehrambene svrhe, sredstvo za zgušnjavanje sosa; pudinzi, pudinzi u prahu; sladoledi; med, melasa; arome za hranu; so; senf; majonez, kečap, remulad sos, pesto (sos); sirće, sosevi (dodaci hrani), prelive za salatu; začini, ekstrakti začina, sušeno bilje; ren (dodaci hrani); slatka gotova jela, naročito sutlijaš, griz, palačinke, zašećerene palačinke; gotova jela koji se uglavnom sastoje od proizvoda napravljenih od žitarica, žitarica od celog zrna, testenine, rezanaca, pirinča, hleba, peciva i/ili poslastica; smrznuta hrana koja se sastoji uglavnom od žitarica, žitarica od celog zrna, testenina, rezanaca, pirinča, hleba, peciva i/ili poslastica; dijetetska hrana koja nije namenjena za medicinsku upotrebu koja se uglavnom sastoji od žitarica, brašnatih testenina, rezanaca, pirinča, hleba, peciva i/ili poslastica.

Klasa 31: Sveže voće i povrće; sveži bademi i sveži orašasti plodovi svih vrsta.

Klasa 32: Piva, mešavine pića na bazi piva; mineralne i gazirane vode, vode; bezalkoholna pića; limunade; napici od voća; voćni sokovi; sokovi od povrća; smutis (kašasti napici od voća ili povrća); sirupi i drugi proizvodi za pravljenje napitaka.

Klasa 33: Alkoholna pića (izuzev piva); vina; penušava vina; žestoka pića; likeri i likeri sa nižim procentom alkohola; mešavine alkoholnih pića; kokteli; aperitivi; pića koja sadrže vino; alkoholni proizvodi za pravljenje pića.

---

(111) **15219**

(151) 12.03.2021.

(210) Ž-2019-475

(220) 04.12.2019.

(732) DRUŠTVO ZA TRGOVINU I USLUGE YUNIRISK DOO, BEOGRAD, Simina 18,  
11000, Beograd, RS

(540)

# MID-MIX

(550) I

(740) AOD MSA IP - Milojević Sekulić Advokati, Karađorđeva 65, 11000, Beograd

(511) Klasa 40: Sagorevanje smeća i otpada; hemijsko recikliranje otpadnih proizvoda; hemijska obrada otpadnih proizvoda; uništavanje otpada; usluge obrade opasnog otpada; spaljivanje otpada; prerada otpadnog ulja; pružanje informacija koje se odnose na recikliranje otpada; pročišćavanje industrijskih otpadnih voda; recikliranje i tretman otpada i smeća; recikliranje otpadnih materija; recikliranje otpadnih proizvoda; sortiranje, transformacija otpada i materijala koji se može reciklirati; tretman hemijskog otpada; tretman opasnog otpada; tretman toksičnog otpada; tretman otpada; tretman otpadnih voda iz industrijskih procesa; tretman otpadnih voda iz proizvodnih operacija; uništavanje otpada i smeća; spaljivanje otpada i smeća; prerada otpada; usluge reciklaže otpada; hemijska obrada izduvnih gasova izgaranjem fosilnih goriva.

Klasa 41: Obrazovne usluge, pružanje obuke, priprema i vođenje seminara u vezi sa preradom i zbrinjavanjem otpada.

Klasa 42: Praćenje životne sredine u svrhe obrade otpada; istraživanja koja se odnose na analizu otpada; praćenje životne sredine u odlagalištima otpada; usluge tehničkog istraživanja; naučno istraživanje i analize; naučno istraživanje i razvoj; naučna istraživanja koja se odnose na ekologiju; istraživanja vezana za zaštitu životne sredine; savetodavne usluge u vezi sa energetsom efikasnošću; istraživanja u oblasti energije.

---

(111) **15220**

(151) 12.03.2021.

(210) Ž-2019-187

(220) 13.05.2019.

(732) Lidl Stiftung & Co. KG , Stiftsbergstraße 1, 74172, Neckarsulm, DE

(540)



(550) I

(740) AOD MSA IP - Milojević Sekulić Advokati, Karađorđeva 65, 11000, Beograd

(511) Klasa 33: Žestoka pića, mešana alkoholna pića, mešana pića koja sadrže žestoka pića.

---

(111) **15221**  
(151) 12.03.2021.  
(210) Ž-2019-314  
(220) 22.08.2019.  
(732) Novartis AG, Basel, 4002, CH  
(540)

**ETALOPREX**

(550) I

(740) AOD MSA IP - Milojević Sekulić Advokati, Karađorđeva 65, 11000, Beograd

(511) Klasa 5: Farmaceutski preparati za ljudsku upotrebu.

---

(111) **15222**  
(151) 12.03.2021.  
(210) Ž-2020-226  
(220) 01.07.2020.  
(732) KAWAI MUSICAL INSTRUMENTS MANUFACTURING CO., LTD.,, No. 200,  
Terajima-cho, Naka-ku, Hamamatsu-shi, Shizuoka-ken, JP  
(540)

**KAWAI**

(550) I

(740) AOD MSA IP - Milojević Sekulić Advokati, Karađorđeva 65, 11000, Beograd

(511) Klasa 15: Muzički instrumenti.

---

(111) **15223**  
(151) 12.03.2021.  
(210) Ž-2020-240  
(220) 07.07.2020.  
(732) Novartis AG, Basel, 4002, CH  
(540)

## MIKTADUO

(550) I

(740) AOD MSA IP - Milojević Sekulić Advokati, Karadordeva 65, 11000, Beograd

(511) Klasa 5: Farmaceutski preparati za ljudsku upotrebu.

---

(111) **15224**  
(151) 12.03.2021.  
(210) Ž-2020-281  
(220) 03.08.2020.  
(732) Donesi doo Podgorica, društvo sa ograničenom odgovornošću, Josipa Broza Tita 65A, 81000, Podgorica, ME  
(540)



(550) I

(740) Luka Stijepović, Bulevar Svetog Petra Cetinjskog 130/VII, 81000, Podgorica

(511) Klasa 9: Aplikacija za angažovanje i koordinaciju prevoza, isporuke i usluge kurirske službe za računarske softvere koji se mogu preuzimati.

Klasa 35: Reklamne i promotivne usluge; poslovno upravljanje u oblasti transporta i isporuke; usluge upravljanja poslovima u oblasti transporta i isporuka; kompjuterizovane usluge naručivanja hrane i namirnica; kompjuterizovana usluga naručivanja koja sadrži robu široke potrošnje, hranu i namirnice; usluga naručivanja putem interneta koja sadrži robu široke potrošnje, hranu i namirnice; kancelarijske usluge; usluga maloprodaje koja sadrži proizvode široke potrošnje, hranu i namirnice; usluge upoređivanja proizvoda prilikom kupovine; nadzor, upravljanje i praćenje paketa i pošiljki; nadzor i praćenje paketa i pošiljki radi obezbeđenja blagovremene isporuke za potrebe poslovanja; konsultantske usluge u oblasti poslovnog upravljanja u oblasti transporta i isporuke;



pružanje usluga putem internet sistema i portala po sistemu poslovnog modela, "korisnici prema poslovnom okruženju" radi trgovine kako bi korisnici mogli da unose, upravljaju i menjaju svoje informacije o preferencijama koje trgovci koriste, kreiraju i upravljaju zbog ponuda za isporuku kupcima.

Klasa 39: Pružanje usluga putem internet stranice sa informacijama o uslugama dostave i rezervacijama za uslugu dostave; prevoz; pakovanje i skladištenje robe; dostava hrane; dostava paketa; prevoz i isporuka robe; dostava poruka (kurirska služba); brza dostava proizvoda putem vozila; pružanje informacija o preuzimanju i dostavi proizvoda u prevozu; usluge dostavljanja; privremeno skladištenje isporuka dobara u tranzitu; usluge isporuke; privremeno skladištenje isporuka; pružanje informacija i informacije o praćenju pošiljki za treća lica o preuzimanju i statusu dostave putem interneta i telefona; pružanje elektronskog praćenja pošiljki drugim licima.

Klasa 42: Omogućavanje privremene upotrebe internet softvera koji nije za preuzimanje, za pružanje usluga prevoza i dostave, rezervacije za usluge prevoza i dostave i otpremanje motornih vozila i kurira do potrošača.

Klasa 43: Pružanje usluge putem internet stranice koja sadrži informacije o uslugama restorana.

---

(111) **15225**

(151) 15.03.2021.

(210) Ž-2020-274

(220) 05.08.2020.

(732) HYUNDAI MOTOR COMPANY, 12, Heolleung-ro, Seocho-gu, Seoul, KR

(540)

## PALISADE

(550) I

(740) AOD MSA IP - Milojević Sekulić Advokati, Karađorđeva 65, 11000, Beograd

(511) Klasa 12: Automobili; sportska terenska vozila; točkovi; delovi i dodatna oprema za automobile.

---

(111) **15226**

(151) 15.03.2021.

(210) Ž-2020-275

(220) 05.08.2020.

(732) HYUNDAI MOTOR COMPANY, 12, Heolleung-ro, Seocho-gu, Seoul, KR

(540)



(550) I

(740) AOD MSA IP - Milojević Sekulić Advokati, Karađorđeva 65, 11000, Beograd

(511) Klasa 12: Automobili; sportska terenska vozila, koja ne uključuju kolica sa jednim točkom, teretna kolica, ručna kolica na dva točka, kolica za čišćenje, točkove za kolica, delove kočnica za vozila, mreže za prtljag za vozila.

---

(111) **15227**

(151) 15.03.2021.

(210) Ž-2020-276

(220) 05.08.2020.

(732) HYUNDAI MOTOR COMPANY and HYUNDAI HEAVY INDUSTRIES HOLDINGS CO., LTD., 12, Heolleung-ro, Seocho-gu, Seoul, KR and 75 Yulgok-ro Jongno-gu, Seoul, KR

(540)

**HYUNDAI**

(550) I

(740) AOD MSA IP - Milojević Sekulić Advokati, Karađorđeva 65, 11000, Beograd

(511) Klasa 9: Reostati; električni releji; električni zatvarači srtujnog kola; transformatori; električni pretvarači; visokonaponski prekidači; mašine za distribuciju električne energije; niskonaponski i srednjenaponski prekidači; prekidači strujnog kola; senzori za motore; merači (instrumenti za merenje); senzori pritiska u gumama; razvodne table; razvodni ormani; solarne baterije; solarni paneli; solarni moduli; solarni moduli za proizvodnju električne energije; solarni generator za proizvodnju električne energije; robotski električni upravljački aparati; laboratorijski roboti; roboti; softver za kontrolu robota; računarski programi za brodove koji se mogu preuzimati i koji se upotrebljavaju za kontrolu kretanja brodova; radarski odašiljači; radarski prijemnici; radarski sistemi; brodski radari i komponente; sateliti za prenos signala; uređaji za globalno pozicionirajući sistem; komunikacijski aparati i instrumenti za brodove; komunikacijski uređaji za brodove; uređaji za prenos komunikacije; sistem automatskog upravljanja za brodove; električne i elektronske instalacije za video nadzor; instrumenti za globalno pozicioniranje; uređaji za skladištenje energije koji se sastoje od baterija; aplikacijski softveri za pametne telefone;

navigacioni uređaji za vozila; senzori, računarski hardver za automobile; računarski softver za automobile; uređaji za upozoravanje na sudar koji se nalaze sa prednje strane vozila; elektronske kontrolne jedinice; kamere za automobile; senzori za detektovanje pokreta; senzori akceleracije (ubrzanja); senzori akceleracije za automobile; senzori za merenje udaljenosti; merni instrumenti koji se upotrebljavaju za određivanje rastojanja između automobila; senzori za automobile koji određuju bočno rastojanje; bočni sigurnosni senzor za automobile; uređaji za kontrolu elektronskih senzora u automobilu; radarski senzori za signalni procesor senzora i kontrolnog aparata automobila; elektronski kočioni uređaji za automobile koji se koriste u slučaju opasnosti za automobile; elektronski uređaji za kontrolu brzine kretanja za automobile; elektronski uređaji za asistiranje pri vožnji automobila; elektronski uređaji za pomoć pri parkiranju automobila; električni sigurnosni uređaji za nadzor; AVN (Audio Video Navigacioni) softver koji se upotrebljava za jednostavno plaćanje u vozilu; aplikacija (softver) za pametni telefon koja se upotrebljava za jednostavno plaćanje u vozilu; aplikacija (softver) za pametni telefon koja se može povezati sa sistemima u vozilu; punjači za električne baterije; baterije; crna kutija za automobile (uređaj za snimanje podataka); računarska softverska platforma koja se koristi za integrisanu samopokretnu kontrolu samostalne vožnje automobila; aplikacijski programi za pametne telefone koji se upotrebljavaju za deljenje vožnje automobilom; aplikacijski softver za pametne telefone za rezervaciju automobila za iznajmljivanje; aplikacijski softver za pametne telefone koji se upotrebljava za pružanje informativnih usluga koje se odnose na istoriju informacija o vožnji, upravljanje lokacijama za parkiranje, informacije o vožnji, upravljanje statusom vozila i trgovinski materijal; kompjuterska oprema; komponente za računarske sisteme; digitalizatori.

---

(111) **15228**

(151) 15.03.2021.

(210) Ž-2020-277

(220) 06.08.2020.

(732) SYNGENTA LIMITED, Syngenta Jealott's Hill International Research Centre, RG42 6EY, Bracknell, Berkshire, GB

(540)

## FUSILADE

(550) I

(740) AOD MSA IP - Milojević Sekulić Advokati, Karađorđeva 65, 11000, Beograd

(511) Klasa 5: Herbicidi.

---

(111) **15229**

(151) 15.03.2021.

(210) Ž-2020-62

(220) 20.02.2020.

(732) Predrag Šćepanović, Branka Miljkovića 46/10, 81000, Podgorica, ME

(540)

## enemove

(550) I

(511) Klasa 12: Vozila; uređaji za kretanje po zemlji, po vodi ili vazduhu; alarmni uređaji protiv krađe vozila; amfibije (hidroavioni); amortizeri (ublaživači udara u vozila); amortizujuće opruge za vozila; autobusi za međugradski prevoz; autokaravani; autobili; automobili (amortizeri za automobile); automobili (branici za automobile); automobili (cerade automobilskih motora); automobili (lanci za automobile); automobili (zavjesice za automobile) (roletne); automobilske spoljašnje gume (točkovi); automobilski kosturi (šasijske); automobilske školjke (karoserije); avioni; baloni kojima se može upravljati (letjelice); baloni, vazdušni; betonjerke (vozila mješalice za beton); bicikli; bicikli (gume za točkove za bicikla); bicikli (gumeni djelovi točka bicikla); bicikli (indikatori smjera kretanja za bicikle); bicikli (kočnice bicikla); bicikli (mrežice za bicikle); bicikli (okviri za bicikle) (rame); bicikli (osnove točka bicikla); bicikli (postolja bicikala); bicikli (postolja za bicikle); bicikli (pumpe za bicikle); bicikli (sjedišta za bicikle); bicikli (tamovi za bicikle) (felge); bicikli (točkovi bicikla); bicikli (upravljači bicikla); bicikli (zupčanici za bicikle); bicikli (zvonca za bicikle); blatobrani; blatobrani za bicikla; bokobrani za brodove; branici na željezničkim vagonima; branici vozila; brisači automobilskih stakala; brisači farova; brodovi; brodovi (upravljački uređaji za brodove); brodovi (uređaji za izvlačenje brodova); brodovi (utovarne brodske rampe); brodska rebra; brodske kuke; brodski dimnjaci; brodski propeleri elise; brodski propeleri, elise; brodski prozorčići; brodski spoljašnji propeleri, elise; brodski trupovi; brzina (mjenjačke kutije za kopnena vozila); centriranje točkova na vozilima (olovo za centriranje točkova); cigare (automatski upaljači za cigare) za automobile; cijevi (kola za crijeva za polivanje); čamci; čamci (vesla za čamce); dimnjaci lokomotiva; dimnjaci, brodski; dizalice (sohe) za utovar na brodove; dječija kolica; ekseri za gume; električna vozila; električni motori za kopnena vozila; gazišta, gusjenice vozila; gepek vozila; golf (kolica za golf); gradski autobusi; guma (okrugli komadi ljepljive gume za popravku guma); gume (ljepljive gumene zakrpe za šivenje pneumatika); gume (torbe s proborom za šivenje pneumatika); gume za točkove bicikala; gume za točkove vozila; gumeni točkovi (spoljni omotači gumenih točkova); gumeni točkovi vozila (trake za izmjenu gumenih točkova na vozilima); hidraulični sastavi vozila; hidroavioni; hidroglišeri; hidrotransformatori; hladnjače (vozila); indikatori smjera kretanja vozila; jahte; jarboli (jarboli za brodove); jarboli (brodarstvo); jarboli za brodove; jastuci za napuvavanje; kabine za žičare; kaiševi za mehaničke prenosnike; kaiševi za mehaničke prenosnike (naplaci glavina) (obodi); kamioneri; kamioni; kamioni (utovarne površine kamiona); karavani; karoserije (djelovi automobila); kočne obloge vozila; kočne papuče vozila; kočne pločice za automobile; kočni segmenti za vozila; kočnice bicikala; kočnice vozila; kola za crijeva za polivanje; kolica (krov dječijih kolica); kolica (seoska kolica bez osovine); kolica sa nagibom; kolica za crijeva za polivanje; kolica za čišćenje; kolica za golf-opremu; kolica za lijev; kolica za namirnice; kolica, dječija; kolica, okretna za istovar (kipper-kolica); kolica, utovarna sa podizačem; kormila; korpe (specijalne korpe prilagođene za motocikle); kosturi vozila (šasijske); košare posebno proizvedene za bicikle; krađa vozila

(alarmni uređaji protiv krađe vozila); krađa vozila (uređaji za zaštitu protiv krađe vozila); krajevi osovina (rukavci); krovici dječijih kolica; krovici, platneni za dječija kolica; kućišta za mehanizme kopnenih vozila (ne za motore); kuke za čamce (brodarstvo); kuke za vuču vozila; kuke, brodske; kvačila točkova vozila; kvačila za kopnena vozila; kvačila za kopnena vozila (mjenjači); lanci protiv klizanja; lanci za bicikle; lanci, pogonski za kopnena vozila; letjelice (vazdušne lađe); ležaji (kreveti u vozilima); lokomotive; lokomotive (dimnjaci lokomotiva); lokomotive željezničkih vagona; mehanički prenosnici za bicikle; mjenjačke kutije za kopnena vozila; mopedi; mopedi s prikolicom; motocikli; motocikli sa prikolicom; motori (poklopci motora); motori za dvokolice; motori za kopnena vozila; municija (kola za municija); nagibna plastična kolica; navlake za sjedišta bicikla ili motocikla; navlake za sjedišta za vozila; navlake za upravljače (volane) za vozila; nosači za skije na vozilima; obloge, kočne za vozila; obloge, unutrašnje za vozila (tapecirung); ogledala za gledanje unatrag (retrovizori); okviri bicikla; olovni tegovi za uravnoteženje točkova vozila (balansiranje); omnibusi; opruge vješanje za vozila; osovine na točkovima vozila; osovine vozila; padobrani; pedale bicikla; plovna vozila; pogonske mašine (lanci pogonskih mašina za kopnena vozila); pogonske mašine za kopnena vozila; pogonski mašine za pogonska vozila; pogonski mehanizmi za kopnena vozila; poklopci za motore vozila; poklopci, preklopni za vozila; poklopci, ukrasni na vozilima; pokretni bifei (vozila); pokrivači za vozila; pontoni; pretvarači zakretnog momenta za kopnena vozila; prevoz, kablovski (uređaji i postrojenja za kablovski prevoz); prijenosne osovine za kopnena vozila; prikolice (vozila); protivklizne sprave za točkove vozila; protivzasljepljujući uređaji za vozila; prskalice, vozila; pumpe, vazdušne (pribor za vozila); radilice za kopnena vozila; rašlje za vesla (ušice); reakcijski motori za kopnena vozila; reduktori za kopnena vozila (uređaji za smanjenje broja obrtaja); rezervni točkovi (zaštitni pokrivači rezervnih točkova); rezervoari za gorivo na vozilima (čepovi rezervoara za gorivo); ručke bicikla; ručna kolica (drezine); ručna kolica (tačke); sanke na nožno pokretanje; saonice (vozila); signalizatori za kretanje vozila unatrag; sigurnosna sjedišta za djecu u vozilima; sigurnosni kaiševi za sjedišta u vozilima; sigurnosni pojasevi za sjedišta u vozilima; sjedišta (navlake za sjedišta) za bicikle i motorbicikle; sjedišta u vozilima; sjedišta u vozilima (navlaek za sjedišta u vozilima); sjedišta u vozilima (oslonci za glavu na sjedištima u vozilima); sjedišta za bicikle i motorbicikle; sjedišta, za avione; skale za ulaz u vozila; skele (plovila); skele (tegljanice); skijaški liftovi; skijaški liftovi; spojleri za vozila; spojnice osovina za točkove; spoljne gume vozila (uređaji protiv klizanja spoljnih guma vozila); spoljni rubovi željezničkih točkova; sportska vozila; sprava za održavanje bicikla u zaustavljenom položaju; stakla (brisači stakala); stubići za vezivanje plovila uz obalu (pomorstvo); svemirske letilice; šalupe (barke s 4-8 vesala); šasije za vozila; štitnici od sunca za automobile; teretne dvokolice (kubikaška kolica); točkići za kolica; točkovi (spojnice osovina na točkovima); točkovi (spoljašnje gume za točkove vozila); točkovi (unutrašnje gume za točkove vozila); točkovi vozila (felge za točkove vozila) (felge); točkovi vozila (glavine za vozila); točkovi vozila (osovine na točkovima vozila); točkovi vozila (slobodni točkovi za kopnena vozila); točkovi vozila (šarafi za gumene točkove); točkovi željezničkih vozila (unutrašnji rubovi točkova željezničkih vagona ili tramvaja); točkovi, spojnice osovina točkova (uređaji); torbe sa priborom za krpljenje guma; torzione za poluge za vozila; trake za izmjenu spoljašnjeg sloja automobilskih guma; tramvajska kola; tricikli; trupovi brodova; turbine za kopnena vozila; upravljači bicikla (ručice); upravljači vozila (volani); upravljački lanci za kopnena vozila; upravljački uređaji za brodove; uređaji za istovar, djelovi kamiona i vagona (djelovi vagona); utovar (dizalice za utovar za brodove); utovarne ograde (pokretne utovarne ograde) (djelovi na kopnenih vozila); utovarne površine kamiona; vagon restorani; vagoneti (točkići za vagonete); vagoni; vagoni; vagoni (postolja

željezničkih vagona); vagoni hladnjače; vagoni sa ležajevima za spavanje (spavaći vagoni); vagonске spojnice za šine (uređaji za priključak vagona); vazduhoplovstvo (aeronautika) (aparati, mašine i uređaji za vazduhoplovstvo); vazdušna vozila; vazdušni baloni; vazdušni transporteri; ventili za gumene točkove vozila; vesla za čamce; vesla, kratka; viseći amortizeri vozila; vješanje (opruge za vješanje vozila); vjetrobranska stakla; vojna vozila za prevoz; vozila; vozila (alarmni uređaji protiv krađe vozila); vozila (amortizujuće opruge za vozila); vozila (branici vozila)vozila (cerade na vozila); vozila (električna vozila); vozila (felne točkova vozila) (obruč); vozila (gazišta vozila); vozila (gepeci vozila); vozila (glavine točkova vozila)vozila (gumeni točkovi vozila); vozila (hidraulini sistemi vozila); vozila (indikatori smjera vozila); vozila (kočnice vozila); vozila (kosturi vozila) (šasije); vozila (kuke za vuču vozila); vozila (ležaji u vozilima); vozila (motori za kopnena vozila); vozila (olovni tegovi za balansiranje vozila); vozila (osovine za točkove vozila); vozila (poklopci za vozila); vozila (pokrivači za vozila); vozila (protiv klizne sprave za točkove vozila); vozila (protiv zasljepljujući uređaji na vozilima); vozila (prozori vozila); vozila (sigurnosni pojasevi za sjedišta vozila); vozila (sjedišta u vozilima); vozila (spojnice za kopnena vozila) nijesu djelovi mašina; vozila (spoljne gume za točkove vozila); vozila (svemirska vozila); vozila (točkovi vozila); vozila (trube vozila); vozila (unutrašnje obloge vozila) (tapecirung); vozila (upravljači vozila) (volani); vozila (ventili za gumene točkove vozila); vozila (viseći amortizeri vozila); vozila (vrata vozila); vozila hitne pomoći; vozila hladnjače; vozila sa daljinskim upravljanjem (igračke); vozila sa daljinskim upravljanjem (nijesu igračke); vozila sa vazdušnim jastukom; vozila za kretanje po zemlji, po vazduhu, po vodi i na šinama; vozila za snijeg; vozila, vojna za prevoz; vrta vozila; vuča (kuke za vuču vozila); vučni motori; zatvarači za benzinske rezervoare na vozilima; zavjesice za automobile (štitnici od sunca); zupčanici za bicikle; zupčanici za kopnena vozila; zvonca za bicikle; željeznički točkovi (unutrašnji rubovi na točkovima željezničkih vagona ili tramvaja) (oplatnice); željeznički vagoni (postolja za željezničke vagone); željeznički vozni park; žičare; žičare; žičare (vozni park za žičare); žičare sa sjedištima.

Klasa 18: Odjeća, obuća, pokrivala za glavu; amovi za životinje (orma); bebe (nosiljke beba); bičevi; brnjice; brnjice kod duplih uzdi; crijeva za suhomesnate proizvode; djeca (torbe za nošenje djece sa naramenicama); domaćinstvo (kožne presvlake za domaćinstvo); drške štapova za hodanje; hamovi (metalni okovi na hamovima); isprave (dokumenti) (torbe za isprave); jahaća sedla (podmetači za jahaća sedla); jareća koža (koža); kampisti (torbe za kampiste); karton – koža; klizaljke (kaiševi za klizaljke); ključevi (futrole za ključeve); kobasice (crijeva za kobasice); konji (navlake za konjska sedla); konji (pokrivači za konje); konji (povoci za konje); konji (sedla za konje); konji (ulari i povoci za konje); konjska oprema; korbači (bičevi); korpice za podsjetnice; kostur na sedlima; kovčezi od vulkanizovanih vlakana; kovčezi, ručni; kovčežići za prtljag; koža (imitacija kože); koža (štavljena koža) nije za čišćenje; koža (uzice od kože); koža (vještačka koža); koža (životinjska koža); koža, sirova ili poluobrađena; kože od klaoničke stoke; kožice (opnice dobijene od debelog govedeg crijeva); kožne niti; kožni povoci, uzice; kožni ukrasi za namještaj; krzna (životinjske kože); kutije; kutije od kože i od kože i kartona; kutije od kože za šešire; kutije od vulkanizovanih vlakana; kutije za isprave; kutije za toaletni pribor; kutije, kožne ili od kartonske kože; lovačke torbe; mala djeca (marame (ešarpe) za nošenje male djece); marame (ešarpe) za nošenje male djece; mreže za nošenje namirnica; mreže, ručne; muzičke partiture (torbe za muzičke partiture); namirnice (mreže za namirnice); namirnice (torbe za namirnice); namještaj (kožni ukrasi za namještaj); naočnjaci za konje (orma); navlake za kišobrane; navlake za ključeve (kožna galanterija); novčanici; obloge za opruge, kožne; obruči (alkice) za kišobrane; odijela (torbe-navlake za odijela) (za putovanja); odjeća

za životinje; okovi za ormu; okviri ručnih torbi; opruge (kožne obloge za opruge); orma, am, uzde (oprema za amove); orma, am, uzde (armatura za amove); orma, am, uzde za životinje; pkošce na sedlima; planinarske torbe; planinarski štapovi; plaža (torbe za plažu); podbradnici (kožne trake); podsjetnice (futrole za podsjetnice); pokrivači od krzna; pokrivači za konje; povodci (kaiševi); povodci (kožni povodci); presvlake, kožne za domaćinstvo; psi (ogrlice za pse); putni kovčežići; putni neseseri (kožna galanterija); putovanje (torbe za putovanje); rebra za kišobrane i suncobrane; remeni za vuču (sedlarstvo); remeni, kožni za nošenje preko ramena ili leđa; remenje od kože (remenarstvo); remenje za ormu; ručke za kišobrane; ručke za kovčege; ruksaci (ranci); ruksaci; sedla (konjska sedla); sedla (pritege na sedlima); sedlarski proizvodi; stočna hrana (zobnice (torbe) za stočnu hranu); stolice-štapovi (stolice koje se po potrebi mogu preinačiti u štapove za šetnju); suncobrani; šeširi (kožne kutije za šešire); šipke za kišobrane i suncobrane; školske torbe; štapovi od trske; štapovi za hodanje (ručke štapova za hodanje); štapovi za kišobrane; štapovi, planinarski; štavljena koža; štavljena koža (ne za čišćenje); štitnici za konska koljena; točkići (torbe na točkićima); torbe (ručne torbe); torbe (sportske torbe); torbe (kožna galanterija); torbe sa točkićima; torbe za alat (prazne); torbe za divljač; torbe za hranjenje, zobnice; torbe za kampovanje; torbe za namirnice; torbe za nošenje male djece; torbe za note; torbe za novac (vrećice za novce); torbe za novac, pletene; torbe za plažu; torbe za putovanja (kožna galanterija); torbe za spise (aktovke); torbe za školu; torbe, planinarske; torbe-navlake za odijela (za putovanja); trake kožne; trake od kože; ulari i povodci; uzde (konjska oprema); uzde; uzengije; uzengije (gumeni djelovi za uzengije); uzengije (metalne uzengije) (ostruge); uzice, kožne; ventili (ventili) od kože; vezice (kožne vezice); vojnička oprema od kože; vreće (omotači, džepovi), od kože za ambalažu; zaprežna oprema za životinje; životinje (orglice za životinje); životinjske kože pripremljene za izradu krznarskih proizvoda; životinjske kože

Klasa 24: Tkanine i tekstilni proizvodi koji nijesu obuhvaćeni drugim klasama; pokrivači za krevete i stolove; baloni (tkanine nepropustljive za plin za aeronautičke balone); bilijarski stolovi (uski pokrivači za bilijarske stolove); brokat (vrsta tkanine); damast (tkanina); damast za stolnjake (vrsta fino tkanog platna); domaćinstvo (presvlake od plastike za domaćinstvo; domaćinstvo (tkanine za domaćinstvo); domaćinstvo (zaštitne navlake za domaćinstvo); droget (vrsta poluvunene tkanine); dušeci (navlake za dušeke); dušeci (tkanina za dušeke); esparto (biljka) tkanine od esparta; filc od konoplje (pust); filterske tekstilne tkanine; filter-tkanine za štamparstvo, tekstilne; flanel (tkanina); flaner za sanitarne potrebe; flaše (podloge za flaše); friz (vunena tkanina); gaza (tkanina); grubo tkanje od konoplje; gumirano platno (ne za papirnate proizvode); jaka pamučna tkanina za zavjese (vrsta tkanine); jastuci (navlake za jastuke); jastučnice; juta platna za tapiserije ili za vezenje; jutene tkanine; konoplja (platno od konoplje); konoplja (tkanine od konoplje); krep (tkanina); krepon (tkanina); kreveti (gornji prekrivači za krevete); kreveti (papirni pokrivači za krevete); kreveti (pokrivači za krevete); kupanje (veš za kupanje, osim odjevnih predmeta); lanene tkanine; ljepljive tkanine koje se lijepe toplim postupkom; marabut (tkanina); maramice od tekstila za skidanje šminke; maramice od tekstila, toaletne; maramice džepne od tekstila; moleskin (tkanina); mrežice za kosu; naljepnice od tkanine; navlake lanene (platno); navlake za jastuke (jastučnice); navlake za zaštitu namještaja; obuća (tkanina za obuću); obuća (tkanina za postavljanje obuće); omotači za dušeke; pamučne tkanine; pamučno platno; peškiri, tekstilni; palstični materijali (zamjene za tkanine); platno za dušeke; platno za posteljину; platno za sir; platno, gumirano (ne za papirnate proizvode); platno navoštено (stolnjajci); podmetači za boce (stono rublje); pokrivači za krevete; pokrivači za krevete (popluni); pokrivači za putovanje; pokrivači, papirni za krevete; postave (tkanine); postave za šešire; posteljina; posteljina; prekrivači za krevet od perja (prekrivači od perja za noge);

presvlake, plastične za domaćinstvo; presvlake tekstilne za domaćinstvo; putni prekrivači; ramija (kineska trava) (tkanine od ramije); rastegljive tkanine; rublje (kućno rublje); rublje (tkanina za rublje); rublje za kupanje (osim odjevnih predmeta); rukavice za toaletne potrebe; salвете od tekstila za stolove; setovi za stol, nepapirnati; sir (platno za pravljenje sira); sita (rijetka tkanina za sita); skidanje šminke (tekstilni peškiri za skidanje šminke); somot (tkanina); somotska tkanina; spavanje (vreće za spavanje) (sašiveni omotači koji zamjenjuju posteljinu); staklena vlakna (tkanina od staklenih vlakna za tekstil); staklo (tkanina za brisanje stakla); stolni peškiri, tekstilni; stolno rublje (nepapirnatostolno rublje); stolnjaci (uski dugački); stolnjaci, nepapirnati; stolovi, bilijarski (pokrivači za bilijarske stolove); svilena tkanina; svilena tkanina za štamparske šablone; šeširi (postave za šešire); ševiot (vunena tkanina); štampane pamučne tkanine (tkanina); štamparstvo (filter-tkanina za štamparstvo); štamparstvo (svilena tkanina za štamparske matrice); taft (svila); tapete (tekstilne, zidne tapete); tekstil, netkani; tekstilni materijal (štofovi); til (tkanina); tkanina; tkanina koja imitira kožu životinja; tkanina koja se lijepi toplim postupkom; tkanina od konjske dlake; tkanina od staklenih vlakana za tekstil; tkanina sa ucrtanim motivima za vezenje; tkanina za brisanje stakla; tkanina za obuću; tkanina za postave; tkanina za tekstilne potrebe; tkanine sa rijetnim nitima; tkanine sa rijetnim nitima za velika sita; tkanine, rastegljive; toaletne daske (presvlake za toaletne daske); toaletne rukavice; toaletni peškiri, tekstilni; trake, tekstilne za zavjese; triko (tkanina); vezenje (tkanina sa ucrtanim motivima za vezenje); vještačka svila (tkanina od vještačke svile) (sintetika); voštana platna (stolnjaci od voštanog platna); vreće za spavanje (sašiveni omotači koji zamjenjuju posteljinu); vunene tkanine; zastave (barjaci); zastavice, nepapirne; zastirači za krevete; zavjese, plastične za tuširanje; zavjese od tekstila ili pamučne; zavjese, tekstilne na vratima; zefir, vrsta tkanine; zidne tapete, tekstilne; žersej, vrsta tkanine; životinjska koža (tkanine koje imitiraju životinjsku kožu)

Klasa 25: Odjeća, obuća, pokrivala za glavu; automobilisti (odjeća za automobiliste); biciklisti (odjeća za bicikliste); bluže (radničke bluže); bodi (žensko donje rublje); boe (okovratnici od perja ili krzna); cilindri (pokrivala za glavu); cipele; čarape; čarape (pete čarapa); čarape (podvezice čarapa) (držači); čarape sa gaćicama (hulahopke); čizme (gornji dio čizama) (sare); čizme; čizmice; dodaci na košuljama; dokoljenice (gamaše); dokoljenice (odjevni predmeti); donji veš; donji veš za upijanje znoja; džemperi (puloveri); džepne maramice (odjevni predmeti); džepovi na odjeći; đonovi (đonovi); esparto cipele ili sandale (obuća od platna i šage); ešarpe (šalovi); francuske kape; fudbal (obuća za fudbal) (kopačke); gabardeni (odjevni predmeti); gaćice; gimnastička odjeća; gimnastičke papuče; grijanje nogu (neelektrične vrećice obložene krznom za grijanje nogu); grudnjaci; haljine; haljine na tregere; imitacija kože (odjeća od imitacije kože); jakna ili košulja od platna ili serža za mornare; kabanice; kaljače (galoše); kape, okrugle; kape za glavu; kapice za tuširanje; kapuljače (odjevni predmeti); kaputi; kecelje (odjevni predmeti); klobučarski proizvodi; klompe; kombinezoni (odjeća); kombinezoni za skijanje na vodi; konfekcijska odjeća; košulje; košulje (umeci na košuljama); košulje (zasebno načinjena prsa na košuljama) (plastroni); košulje sa kratkim rukavima); kožna odjeća; kožne trake za obrub (kožnate trake koje obučari uživaju između dvije deblje kože na obući); kramponi za obuću za fudbal; kratke bluže; kratke čarape (sokne); kratki kaputi (sakoi); kravate; kravate (umjetničke kravate); krzna (odjevni predmeti od krzna); krzneni ogrtači (kaputi); krzneni šalovi (ženski šalovi od krzna); kućne haljine; kućni kupaći ogrtači; kupaći kostimi; kupanje (cipele za kupanje); kupanje (kapice za kupanje); kupanje (muške kupaće gaćice); kupanje (orgtači za kupanje); kupanje (sandale za kupanje); lente (široki pojasevi); livreje (odore); manžetne (odjevni predmeti); marama za pokrivanje vrata; marama, šalovi (fulari); marama,



šalovi za glavu; metalni djelovi za obuću; mitre, biskupske kape (odjevni predmeti); mornarske bluze (kaputi); mufovi (odjevni predmeti); muške gaće; muške kupaće gaće; muški ogrtači; naramenice; naručnici (ukrasi od tkanine koje sveštenici nose na ruci za vrijeme liturgije); narukvice vunene (pletene); nazuvci, grijači nogu; nošnje; novac (pojasevi za nošenje novca) (odjevni predmeti); obuća (gornji djelovi obuće); obuća (kožne trake za obrub, koje postolari ušivaju između dvije deblje kože na obući); obuća (metalni djelovi za obuću); obuća (potpetice za obuću); obuća (sprave protiv klizanja obuće); obuća (sredstva protiv klizanja za obuću); obuća (vrhovi obuće); obuća; obuća za fudbal; obuća za fudbal (kramponi za obuću za fudbal); obuća za plažu; obuća za skijanje; odjeća (džepovi za odjeću); odjeća (gornja odjeća) (ogrtači); odjeća; odjeća za maskenbale; odjevni predmeti; odore (uniforme); ogrtači (odjevni predmeti); okovratnici koji se skidaju (lažni okovratnici); okovratnici na odjeći; okovratnici, lažni; okviri za šešire; pantalone; papirna odjeća; papuče; pelene od tekstila; pelene od tekstila, u obliku četvorougla za previjanje male djece; pelene za novorođenčad (povoji); pelene-gaćice za odojčad (odjeća); pelerine; pelerine sa kapuljačom; pete za obuću; pidžame; planinarske cipele; plaža (obuća za plažu); plaža (odjeća za plažu); podsuknje; podvezice (držači) za muške čarape; podvezice od elastične tkanine; podvezice za čarape; pojasevi (odjevni predmeti); pokrivači za uči (odjevni predmeti); pončo (vrsta ogrtača); portikle za bebe (nisu od papira); portikle, nepapirne (djeci oko vrata protiv prljanja); postave sašivene (dio odjeće); potkošulje; potkošulje za žene; potpetice; potpetice za čarape; potpetice za obuću; prsluci; prsluci uz tijelo; puloveri; puloveri bez rukava; ribarske bluze; rublje (donje rublje za upijanje znoja); rublje (donje rublje); rukavice (odjevni predmeti); rukavice bez prstiju (radničke rukavice); rukavice za skijanje; sandale; sare (gornji dio čizama); sari (ženski odjevni predmeti); sarong (odjevni predmeti); sjenila za kape; skijanje na vodi (kombinezoni za skijanje na vodi); skijaška obuća; slipovi (donji veš); spavanje (maske za spavanje); sportska obuća; sportske cipele; sportske gaćice; steznici; steznici od struka do kukova; suknje; suknje – pantalone; šeširi; šeširi (okviri za šešire); šeširi od papira; štitnici za kragne; tee-shirts (majce); toge; trake za glavu (odjevni predmeti); tregeri; trikoi (gimnastički dresovi, majce); trikoi (odjevni predmeti); trikotažni odjevni predmeti; turbani; tuširanje (kapice za tuširanje); unutrašnji donovi (donovi); vindjakne (kratki sportski kaputi sa kapuljačom); znojnice za pazuh; ženske kape; ženske potkošulje; žersez (odjevni predmet).

---

(111) **15230**

(151) 15.03.2021.

(210) Ž-2020-261

(220) 20.07.2020.

(732) "DIRECT BOOKER- MONTENEGRO" D.O.O. HERCEG NOVI , Kamenari bb,  
Herceg Novi, ME

(540)

direct booker

(550) I

(511) Klasa 41: Obuka; stručno osposobljavanje; razonoda; sportske i kulturne djelatnosti.  
Klasa 43: Usluge obezbjeđivanja hrane i pića; barovi (usluge barova); hotelske rezervacije (usluge rezervisanja hotela); hotelske usluge; iznajmljivanje privremenog smještaja, iznajmljivanje sala, dvorana za sastanke; moteli (usluge motela); pansioni; pansioni (rezervisanje pansiona); privremeni smještaj (rezervisanje privremenog smještaja); restorani; restorani sa samoposluživanjem; restorani za brzo i stalno posluživanje [snek-barovi]; rezervisanje hotela; rezervisanje pansiona; rezervisanje privremenog smještaja; smještaj (agencije za izdavanje smještaja) [hoteli, pansioni]; smještaj (iznajmljivanje privremenog smještaja); ugostitelji (usluge kateringa).

Klasa 44: Medicinske usluge; higijenska zaštita i nega lepote za ljude ili životinje; masaža.

---

(111) **15231**

(151) 15.03.2021.

(210) Ž-2020-260

(220) 20.07.2020.

(732) "DIRECT BOOKER- MONTENEGRO" D.O.O. HERCEG NOVI , Kamenari bb,  
Herceg Novi, ME

(540)



(550) I

(511) Klasa 41: Obuka; stručno osposobljavanje; razonoda; sportske i kulturne djelatnosti.  
Klasa 43: Usluge obezbjeđivanja hrane i pića; barovi (usluge barova); hotelske rezervacije (usluge rezervisanja hotela); hotelske usluge; iznajmljivanje privremenog smještaja, iznajmljivanje sala, dvorana za sastanke; moteli (usluge motela); pansioni; pansioni (rezervisanje pansiona); privremeni smještaj (rezervisanje privremenog smještaja); restorani; restorani sa samoposluživanjem; restorani za brzo i stalno posluživanje [snek-barovi]; rezervisanje hotela; rezervisanje pansiona; rezervisanje privremenog smještaja; smještaj (agencije za izdavanje smještaja) [hoteli, pansioni]; smještaj (iznajmljivanje privremenog smještaja); ugostitelji (usluge kateringa).

Klasa 44: Medicinske usluge; higijenska zaštita i nega lepote za ljude ili životinje; masaža.

---

(111) **15232**

(151) 15.03.2021.

(210) Ž-2020-32

(220) 31.01.2020.

(732) London Group, LLC, 8 Pinetree Lane, 11568, Old Westbury, New York, US

(540)

## NUVO

(550) I

(740) Jasna Jusić, Marka Radovića 37, 1. sprat, stan br. 4., 81000, Podgorica

(511) Klasa 33: Alkoholna pića izuzev piva.

---

(111) **15233**

(151) 15.03.2021.

(210) Ž-2019-239

(220) 25.06.2019.

(732) Zavarovalnica Triglav d.d., Miklošičeva cesta 19, 1000, Ljubljana, SI

(540)



(550) I

(740) Nenad Pavličić, Ul. Novaka Miloševa br. 6/III, 81000, Podgorica

(511) Klasa 16: (Štampane publikacije i štampani materijali); posteri; štampane publikacije; oglasni panoji od papira ili kartona; plakati od papira ili kartona; fascikle (kancelarijske); omoti (kancelarijski); štampani rokovnici.

Klasa 25: (Promo materijali); kape; jakne; majice; rukavice; marame, šalovi.

Klasa 35: Širenje reklamnih sadržaja; pripremanje reklamnih rubrika; oglašavanje putem pošte; ažuriranje oglasnih materijala; iznajmljivanje oglasnih materijala; izdavanje oglasa; izdavanje reklamnih tekstova (oglasa); oglašavanje; reklamiranje; oglašavanje (reklamiranje) putem radija; služba za odnose sa javnošću; televizijske reklame; oglašavanje preko televizije; reklamne agencije; marketinška istraživanja; iznajmljivanje oglasnog prostora; iznajmljivanje vremena za reklamiranje u svim sredstvima komunikacije; marketing; reklamni filmovi; prezentacija proizvoda putem sredstava komunikacije, u svrhu prodaje.

Klasa 36: Osiguranje; procjena nepokretnosti; investicije kapitala; davanje garancija (jemstva); finansijske procjene (osiguranje); usluge finansiranja; finansijsko upravljanje; upravljanje nepokretnostima; zaključivanje osiguranja od požara; zdravstveno osiguranje, zaključivanje; pomorsko osiguranje; bankarske hipoteke; finansiranje zakupa, lizinga;

posredovanje u prometu akcijama i obveznicama; analize finansijske; finansijske konsultacije; konsultacije o osiguranju; konsultacije u vezi osiguranja; elektronski prenos sredstava; finansijske informacije; informacije o osiguranju; izdavanje poslovnog prostora (nepokretnosti); finansijska procjena naknade štete; obavještenja o osiguranju; usluge fondova uzajamne pomoći; osiguranje od nesreća na osnovu polise.

Klasa 38: Elektronska pošta; komunikacije mobilnim telefonima/mobilne aplikacije; prenos poruka i slika pomoću kompjutera; pristup globalnim kompjuterskim mrežama; prenos čestitki putem interneta (on-line); prenos digitalnih datoteka.

Klasa 41: Organizacija sportskih takmičenja; organizovanje (priprema) i vođenje seminara; priprema (organizovanje) i vođenje radionica za obuku; zabave, planiranje.

---

(111) **15234**

(151) 15.03.2021.

(210) Ž-2019-240

(220) 25.06.2019.

(732) Zavarovalnica Triglav d.d., Miklošičeva cesta 19, 1000, Ljubljana, SI

(540)



**lovćen**

Lovćen osiguranje AD

(550) I

(740) Nenad Pavličić, Ul. Novaka Miloševa br. 6/III, 81000, Podgorica

(511) Klasa 16: (Štampane publikacije i štampani materijali); posteri; štampane publikacije; oglasni panoji od papira ili kartona; plakati od papira ili kartona; fascikle (kancelarijske); omoti (kancelarijski); štampani rokovnici.

Klasa 25: (Promo materijali); kape; jakne; majice; rukavice; marame, šalovi.

Klasa 35: Širenje reklamnih sadržaja; pripremanje reklamnih rubrika; oglašavanje putem pošte; ažuriranje oglasnih materijala; iznajmljivanje oglasnih materijala; izdavanje oglasa; izdavanje reklamnih tekstova (oglasa); oglašavanje; reklamiranje; oglašavanje (reklamiranje) putem radija; služba za odnose sa javnošću; televizijske reklame; oglašavanje preko televizije; reklamne agencije; marketinška istraživanja; iznajmljivanje oglasnog prostora; iznajmljivanje vremena za reklamiranje u svim sredstvima komunikacije; marketing; reklamni filmovi; prezentacija proizvoda putem sredstava komunikacije, u svrhu prodaje.

Klasa 36: Osiguranje; procjena nepokretnosti; investicije kapitala; davanje garancija (jemstva); finansijske procjene (osiguranje); usluge finansiranja; finansijsko upravljanje; upravljanje nepokretnostima; zaključivanje osiguranja od požara; zdravstveno osiguranje, zaključivanje; pomorsko osiguranje; bankarske hipoteke; finansiranje zakupa, lizinga; posredovanje u prometu akcijama i obveznicama; analize finansijske; finansijske

konsultacije; konsultacije o osiguranju; konsultacije u vezi osiguranja; elektronski prenos sredstava; finansijske informacije; informacije o osiguranju; izdavanje poslovnog prostora (nepokretnosti); finansijska procjena naknade štete; obavještenja o osiguranju; usluge fondova uzajamne pomoći; osiguranje od nesreća na osnovu polise

Klasa 38: Elektronska pošta; komunikacije mobilnim telefonima/mobilne aplikacije; prenos poruka i slika pomoću kompjutera; pristup globalnim kompjuterskim mrežama; prenos čestitki putem interneta (on-line); prenos digitalnih datoteka.

Klasa 41: Organizacija sportskih takmičenja; organizovanje (priprema) i vođenje seminara; priprema (organizovanje) i vođenje radionica za obuku; zabave, planiranje.

(111) **15235**

(151) 15.03.2021.

(210) Ž-2019-241

(220) 25.06.2019.

(732) Zavarovalnica Triglav d.d., Miklošičeva cesta 19, 1000, Ljubljana, SI

(540)



Lovćen životna osiguranja AD

(550) I

(740) Nenad Pavličić, Ul. Novaka Miloševa br. 6/III, 81000, Podgorica

(511) Klasa 16: (Štampane publikacije i štampani materijali); posteri; štampane publikacije; oglasni panoji od papira ili kartona; plakati od papira ili kartona; fascikle (kancelarijske); omoti (kancelarijski); štampani rokovnici.

Klasa 25: (Promo materijali); kape; jakne; majice; rukavice; marame, šalovi.

Klasa 35: Širenje reklamnih sadržaja; pripremanje reklamnih rubrika; oglašavanje putem pošte; ažuriranje oglasnih materijala; iznajmljivanje oglasnih materijala; izdavanje oglasa; izdavanje reklamnih tekstova (oglasa); oglašavanje; reklamiranje; oglašavanje (reklamiranje) putem radija; služba za odnose sa javnošću; televizijske reklame; oglašavanje preko televizije; reklamne agencije; marketinška istraživanja; iznajmljivanje oglasnog prostora; iznajmljivanje vremena za reklamiranje u svim sredstvima komunikacije; marketing; reklamni filmovi; prezentacija proizvoda putem sredstava komunikacije, u svrhu prodaje.

Klasa 36: Osiguranje; procjena nepokretnosti; investicije kapitala; davanje garancija (jemstva); finansijske procjene (osiguranje); usluge finansiranja; finansijsko upravljanje; upravljanje nepokretnostima; zaključivanje osiguranja od požara; zdravstveno osiguranje, zaključivanje; pomorsko osiguranje; bankarske hipoteke; finansiranje zakupa, lizinga; posredovanje u prometu akcijama i obveznicama; analize finansijske; finansijske konsultacije; konsultacije o osiguranju; konsultacije u vezi osiguranja; elektronski prenos

sredstava; finansijske informacije; informacije o osiguranju; izdavanje poslovnog prostora (nepokretnosti); finansijska procjena naknade štete; obavještenja o osiguranju; usluge fondova uzajamne pomoći; osiguranje od nesreća na osnovu polise.

Klasa 38: Elektronska pošta; komunikacije mobilnim telefonima/mobilne aplikacije; prenos poruka i slika pomoću kompjutera; pristup globalnim kompjuterskim mrežama; prenos čestitki putem interneta (on-line); prenos digitalnih datoteka.

Klasa 41: Organizacija sportskih takmičenja; organizovanje (priprema) i vođenje seminara; priprema (organizovanje) i vođenje radionica za obuku; zabave, planiranje.

---

(111) **15236**

(151) 16.03.2021.

(210) Ž-2020-43

(220) 12.02.2020.

(732) NewCo Minex L.L.C., rr. e Prizrenit, 70000, Ferizaj, Republic of Kosovo, RS

(540)



(550) I

(740) Dejan Ćosović, 13. jul 9, 85310, Budva

(511) Klasa 30: Kafa, čaj, kakao, šećer, pirinač, tapioka, sago, vještačka kafa; brašno i proizvodi napravljeni od žitarica, hljeb, pecivo i konditorski proizvodi, poslastice od leda; med, sirup; kvasac, prašak za pecivo; so, senf; sirće, sosevi (začini); začini; led.

Klasa 32: Bezalkoholna osvježavajuća pića i gazirana pića.

---

(111) **15237**

(151) 16.03.2021.

(210) Ž-2018-330

(220) 30.08.2018.

(732) TELENOR DOO PODGORICA, Rimski trg br.4, 81000, Podgorica, ME

(540)

Zamisli sve

(550) I

(511) Klasa 1: Hemijski proizvodi koji se upotrebljavaju u industriji , nauci , fotografiji , poljoprivredi , hortikulturi i šumarstvu ; neprerađene vještačke smole , neprerađene plastične materije ; đubriva ; smješe za gašenje vatre ; preparati za kaljenje i zavarivanje ; hemijske supstance za očuvanje namirnica ; materije za štavljenje ; ljepljive supstance koje se upotrebljavaju u industriji.

Klasa 2: Boje, firnajzi, lakovi; sredstva za zaštitu od rđe i truljenja drveta; materije za bojenje; sredstva za nagrivanje; sirove prirodne smole; metali u obliku listova i praha za slikare, dekoratere, štampane i umjetnike.

Klasa 3: Sredstva za bijeljenje i druge supstance za upotrebu u perionicama; preparati za čišćenje, poliranje, ribanje i nagrivanje; sapuni; parfimerija, eterična ulja, kozmetika, losioni za kosu; paste za zube.

Klasa 4: Industrijska ulja i masti; maziva; jedinjenja za skupljanje prašine vlaženjem i vezivanjem; goriva (uključujući motorna tečna goriva) i materije za osvjetljavanje; svijeće i fitilji za osvjetljavanje.

Klasa 5: Farmaceutski i veterinarski preparati ; sanitarni preparati za medicinsku upotrebu ; dijetetske supstance prilagođene za upotrebu u medicini , hrana za bebe ; flasteri , materijali za zavijanje ; materijali za plombiranje zuba , zubarska smola ; dezinfekciona sredstva ; preparati za uništavanje štetočina ; fungicidi , herbicidi.

Klasa 6: Obični metali i njihove legure; metalni građevinski materijali; metalne prenosne građevine; materijali od metala za željezničke šine; ne-električne kablove i žice od običnog metala; bravarski proizvodi, mali metalni gvoždarski proizvodi; cjevčice i cijevi od metala; sefovi; proizvodi od običnih metala koji nisu uključeni u druge klase; rude.

Klasa 7: Mašine i mašinski alati; motori i pogonske mašine (osim za suvozemna vozila); mašinske spojnice i transmisioni elementi (osim za suvozemna vozila); poljoprivredne sprave osim onih kojima se ručno upravlja; inkubatori za jaja; automatske mašine za prodaju.

Klasa 8: Ručni alati i sprave (kojima se ručno upravlja); pribor za jelo; hladno oružje; žileti.

Klasa 9: Aparati i instrumenti naučni, pomorski, geodetski, fotografski, kinematografski, optički, za vaganje, mjerenje, signalizaciju, kontrolu (inspekciju), spašavanje i nastavu; aparati i instrumenti za provođenje, prekid, transformaciju, akumulaciju, regulisanje ili kontrolu električne energije; aparati za snimanje, prenos i reprodukovanje zvuka ili slike; magnetni nosioci podataka, diskovi za snimanje; kompakt diskovi, DVD i drugi digitalni nosači podataka; mehanizmi za aparate koji se pokreću novcem ili žetonom; registar kase, računске mašine, oprema za obradu podataka i kompjuteri; računarski softver; aparati za gašenje požara.

Klasa 10: Hirurški , medicinski , zubarski i veterinarski aparati i instrumenti ; vještački udovi , oči i zubi; ortopedski artikli ; hirurški materijali za zašivanje.

Klasa 11: Aparati za osvjetljavanje, grijanje, proizvodnju pare, kuvanje, hlađenje, sušenje, ventilaciju, snabdijevanje vodom i za sanitarne svrhe.

Klasa 12: Vozila; aparati za kretanje po zemlji, vazduhu ili vodi.

Klasa 13: Vatreno oružje; municija i projektili; eksplozivi; sredstva za vatromet.

Klasa 14: Dragocjeni metali i njihove legure i proizvodi od dragocjenih metala ili sa prevlakom od njih, koji nisu uključeni u druge klase; nakit, drago kamenje; časovničarski i hronometrijski instrumenti.

Klasa 15: Muzički instrumenti.

Klasa 16: Hartija, karton i proizvodi od njih, koji nisu uključeni u druge klase; štampane

stvari; knjigovezački materijal; fotografije; kancelarijski materijal; ljepila za kancelarijske i kućne potrebe; umjetnički materijali; kičice; pisaće mašine i kancelarijski rekviziti (izuzev namještaja); materijali za obuku i nastavu (izuzev aparata); plastični materijal za pakovanje (koji nije uključen u druge klase); štamparska slova; klišeji.

Klasa 17: Guma, gutaperka, kaučuk, azbest, liskun i proizvodi napravljeni od ovih materijala koji nisu uključeni u druge klase; polupreradeni plastični proizvodi koji se koriste u proizvodnji; materijali za podbijanje (podloške), zaptivanje i izolovanje; savitljive nemetalne cijevi.

Klasa 18: Koža i imitacija kože, proizvodi izrađeni od ovih materijala koji nisu uključeni u druge klase; životinjska koža, krzno; koferi i putne torbe; kišobrani, suncobrani i štapovi za hodanje; bičevi, saračka i sedlarska oprema.

Klasa 19: Građevinski materijali (nemetalni); čvrste nemetalne cijevi za građevine; asfalt, cma smola i bitumen; nemetalne prenosne građevine; spomenici, koji nisu od metala.

Klasa 20: Namještaj, ogledala, okviri za slike; proizvodi (koji nisu obuhvaćeni drugim klasama) od drveta, plute, trske, rogoza, vrbovog pruča, roga, kosti, slonovače, kitove kosti, školjki, ćilibara, sedefa, morske pjene i zamjene svih ovih materijala, ili od plastike.

Klasa 21: Kućne ili kuhinjske sprave i posuđe češljevi i suđeri; četke (izuzev kičica); materijali za pravljenje četki; artikli koji se koriste pri čišćenju; čelična vuna; nepreradeni ili polupreradeni staklo (osim stakla koje se koristi u građevinarstvu); staklarija, porcelan, fajans, grnčarija i lončarija koja nije uključena u druge klase.

Klasa 22: Užad, kanapi, mreže, šatori, nadstrešnice od cirade, cirade, jedra, vreće (džakovi) i torbe (koje nisu uključene u druge klase); materijali za punjenje madraca (osim od gume ili plastike); sirove vlaknaste tekstilne materije.

Klasa 23: Pređa i konac, za tekstilnu upotrebu.

Klasa 24: Tekstil i tekstilni proizvodi koji nisu obuhvaćeni drugim klasama; prekrivači za krevete i stolove.

Klasa 25: Odjeća, obuća, pokrivala za glavu.

Klasa 26: Čipka i vez, trake (pantljike) i gajtani; dugmad, kopče i petlje, špenadle i igle; vještačko cvijeće.

Klasa 27: Tepisi, asure, prostirke i otirači, linoleum i drugi materijali za pokrivanje podova; prekrivači za zidove (netekstilni).

Klasa 28: Igre i igračke; gimnastički i sportski artikli koji nisu obuhvaćeni drugim klasama; ukrasi za jelke.

Klasa 29: Meso, riba, živina i divljač; mesne prerađevine; konzervisano, zamrznuto, sušeno i kuvano voće i povrće; želei, džemovi, kompoti; jaja, mlijeko i mliječni proizvodi; jestiva ulja i masti.

Klasa 30: Kafa, čaj, kakao, šećer, pirinač, tapioka, sago, zamjena kafe; brašno i proizvodi od žitarica, hljeb, kolači i poslastice, sladoledi; med, melasa; kvasac, prašak za pecivo; so, senf; sirće, sosovi (kao dodaci); začini; led.

Klasa 31: Poljoprivredni, vrtlarski i šumarski proizvodi i zrnavlje koji nisu uključeni u druge klase; žive životinje; svježe voće i povrće; sjeme, prirodne biljke i cvijeće; hrana za životinje, slad.

Klasa 32: Pivo; mineralne i sodne vode i druga bezalkoholna pića; pića od voća i voćni sokovi; sirupi i drugi preparati za proizvodnju pića.

Klasa 33: Alkoholna pića (izuzev piva).

Klasa 34: Duvan; artikli za pušače; šibice.

Klasa 35: Oглаšavanje; vođenje poslova; poslovno upravljanje; kancelarijski poslovi.

Klasa 36: Osiguranje; finansijski poslovi; novčani (monetami) poslovi; poslovi vezani za



nepokretnosti.

Klasa 37: Građevinsko konstruisanje; popravljanje; usluge instaliranja (instalacione usluge).

Klasa 38: Telekomunikacije.

Klasa 39: Transportne usluge; pakovanje i skladištenje robe; organizovanje putovanja.

Klasa 40: Obradivanje materijala.

Klasa 41: Obrazovne usluge; pripremanje obuke; razonoda; sportske i kulturne aktivnosti.

Klasa 42: Naučne i tehnološke usluge i istraživanje i projektovanje u vezi navedenih usluga; usluge industrijske analize i istraživanja; projektovanje i razvoj kompjuterskog hardvera i softvera.

Klasa 43: Usluge obezbjeđivanja hrane i pića; privremeni smeštaj.

Klasa 44: Medicinske usluge; veterinarske usluge; higijenska zaštita i njega ljepote za ljude ili životinje; agrikulturne, hortikulturne i šumarske usluge.

Klasa 45: Pravne usluge; usluge obezbjeđenja radi zaštite imovine i lica; individualne i društvene usluge koje pružaju drugi, radi zadovoljavanja potreba pojedinaca.

---

(111) **15238**

(151) 16.03.2021.

(210) Ž-2020-44

(220) 12.02.2020.

(732) NewCo Minex L.L.C., rr. e Prizrenit, 70000, Ferizaj, Republic of Kosovo, RS

(540)



(550) I

(740) Dejan L. Čosović, 13. jul 9, 85310, Budva

(511) Klasa 32: Bezalkoholna osvježavajuća pića i gazirana pića.

---

(111) **15239**

(151) 16.03.2021.

(210) Ž-2020-45

(220) 12.02.2020.

(732) NewCo Minex L.L.C., rr. e Prizrenit, 70000, Ferizaj, Republic of Kosovo, RS

(540)



(550) I

(740) Dejan L. Ćosović, 13. jul 9, Budva

(511) Klasa 30: Kafa, čaj, kakao, šećer, pirinač, tapioka, sago, vještačka kafa; brašno i proizvodi napravljeni od žitarica, hljeb, pecivo i konditorski proizvodi, poslastice od leda; med, sirup; kvasac, prašak za pecivo; so, senf; sirće, sosevi (začini); začini; led.

---

(111) **15240**

(151) 16.03.2021.

(210) Ž-2020-46

(220) 12.02.2020.

(732) NewCo Minex L.L.C., rr. e Prizrenit, 70000, Ferizaj, Republic of Kosovo, RS

(540)



(550) I

(740) Dejan L. Ćosović, 13. jul 9, Budva

(511) Klasa 30: Kafa, čaj, kakao, šećer, pirinač, tapioka, sago, vještačka kafa; brašno i proizvodi napravljeni od žitarica, hleb, pecivo i konditorski proizvodi, poslastice od leda; med, sirup; kvasac, prašak za pecivo; so, senf; sirće, sosevi (začini); začini; led.

---

(111) **15241**

(151) 16.03.2021.

(210) Ž-2019-108

(220) 19.03.2019.

(732) "PAUNOVIĆ & CO" DRUŠTVA SA OGRANIČENOM ODGOVORNOŠĆU  
PODGORICA, Lužnica, Nikšički put b.b. (bivša veleprodaja namještaja Đurovic), 81000,  
Podgorica, ME

(540)



(550) I

(740) Dragić Sava, Kragujevačka broj 5, 81000, Podgorica

(511) Klasa 32: Pivo

---

(111) **15242**

(151) 16.03.2021.

(210) Ž-2020-47

(220) 12.02.2020.

(732) NewCo Minex L.L.C., rr. e Prizrenit, 70000, Ferizaj, Republic of Kosovo, RS

(540)



(550) I

(740) Dejan L. Ćosović, 13. jul 9, Budva

(511) Klasa 30: Kafa, čaj, kakao, šećer, pirinač, tapioka, sago, vještačka kafa; brašno i proizvodi napravljeni od žitarica, hljeb, pecivo i konditorski proizvodi, poslastice od leda; med, sirup; kvasac, prašak za pecivo; so, senf; sirće, sosevi (začini); začini; led.

---

(111) **15243**

(151) 16.03.2021.

(210) Ž-2019-179

(220) 07.05.2019.

(732) DRUŠTVO SA OGRANIČENOM ODGOVORNOŠĆU "DECOM MONTENEGRO"

D.O.O. PODGORICA, , 81000, Podgorica, ME

(540)



(550) I

(511) Klasa 35: Konsultacije u poslovnom upravljanju; Poslovne procjene; Prepisivanje korespondencije (kancelarijske usluge); Usluge upravljanja poslovnim projektima za građevinske projekte.

Klasa 37: Konstruisanje; Građevinski nadzor; Informacije u vezi sa izgradnjom; Konsultacije o građenju.

Klasa 42: Savjetovanje iz oblasti arhitekture; Građevinsko projektovanje; Tehnička ispitivanja; Dizajn enterijera; Inženjerske usluge; Kontrola kvaliteta.

---

(111) **15244**

(151) 16.03.2021.

(210) Ž-2020-284

(220) 13.08.2020.

(732) DAILY PRESS d.o.o. Podgorica, Trg Nezavisnosti bb, Podgorica, ME

(540)



(550) I

(740) Jelena Vujisić, Bulevar Ivana Crnojevića 56/2, 81000, Podgorica

(511) Klasa 35: Reklamiranje dopisnim putem, reklamiranje on-line na informatičkoj mreži, reklamiranje putem radija, reklamiranje putem televizije, reklamna dokumentacija (uređenje reklamne dokumentacije), reklamni filmovi (proizvodnja reklamnih filmova), reklamni tekstovi (uređenje reklamnih tekstova).

Klasa 38: Bežična radiodifuzija, emitovanje radio programa, emitovanje televizijskih programa, komuniciranje posredstvom mreža optičkih kablova, konferencije na daljinu (omogućavanje vođenja konferencija na daljinu), prenos digitalnih datoteka, prenos putem satelita, prenos poruka, prenos televizijskih emisija pretplatnicima putem kablova (kablovska televizija), prenos videosadržaja na zahtjev, radijska komunikacija, radiodifuzija, streaming podataka, usluge agencija za vijesti.

Klasa 41: Elektronske publikacije (iskorišćavanje elektronskih publikacija koje se ne mogu prenositi on line), fotografisanje, fotografske reportaže, iznajmljivanje radijskih i televizijskih aparata, iznajmljivanje rasvjetnih uređaja za pozorišnu dekoraciju i za televizijske studije, iznajmljivanje videokamera, iznajmljivanje videotraka, iznajmljivanje zvučnih snimaka, izrada scenarija, osim za potrebe oglašavanja, mikrofimovi (snimanje na mikrofimove), mikroizdavaštvo, montaža radijskih i televizijskih programa, obavještenja o vaspitanju, obavještenja o razonodi, organizovanje i provođenje obrazovnih foruma uživo, pisanje scenarija, pisanje tekstova, prikazivanje igranih filmova, pružanje filmova koji se ne mogu preuzeti putem usluga prenosa videozapisa na zahtjev, pružanje televizijskih programa koji se ne mogu preuzeti putem usluga prenosa videozapisa na zahtjev, razonoda posredstvom radija, razonoda posredstvom televizije, reporterske usluge, sinhronizacija, slobodno vrijeme (usluge za ispunjavanje slobodnog vremena), snimanje na videotrake, studio za snimanje (usluge studija za snimanje), titlovanje filmova, usluge razonode, videotrake (montaža videotraka).

---

(111) **15245**

(151) 16.03.2021.

(210) Ž-2019-399

(220) 17.10.2019.

(732) Fareed Khalaf Sons Company (Khalaf Stores), P.O.Box 586, 11118, Amman, JO

(540)



(550) I

(740) Dejan Ćosović, 13. jula br. 1/5, 85310, Budva

(511) Klasa 29: Meso, riba, živina i divljač; ekstrati mesa; konzervisano, sušeno ili kuvano voće i povrće; želei, džemovi, kompoti; jaja, mlijeko i mliječni proizvodi; jestiva ulja i masti.

---

(111) **15246**

(151) 16.03.2021.

(210) Ž-2020-285

(220) 13.08.2020.

(732) DAILY PRESS d.o.o. Podgorica, Trg Nezavisnosti bb, Podgorica, ME

(540)



(550) I

(740) Jelena Vujisić, Bulevar Ivana Crnojevića 56/2, 81000, Podgorica

(511) Klasa 41: Akademije [obuka], elektronske publikacije (iskorišćavanje elektronskih publikacija koje se ne mogu prenositi on line), fotografisanje, fotografske reportaže, informacije o obrazovanju, informacije o razonodi, izdavanje knjiga, izložbe (organizovanje izložbi) u kulturne ili obrazovne svrhe, javni konkursi (organizovanje javnih konkursa) [obuka ili zabava], konferencije (organizovanje i vođenje konferencija), kongresi (organizovanje i vođenje kongresa), objavljivanje knjiga i časopisa, elektronski on line, objavljivanje tekstova [osim u reklamne svrhe], obrazovanje [obuka], obrazovni zavodi [internati], obuka, obuka [predavanje], obuka putem dopisivanja, pisanje tekstova [ne u reklamne svrhe], praktična obuka [demonstriranje], razonoda (informacije u vezi razonode), rekreacija (obavještenja u vezi rekreacije), seminari (organizovanje i vođenje seminara), slobodno vrijeme (usluge za ispunjavanje slobodnog vremena).

---

(111) **15247**  
(151) 16.03.2021.  
(210) Ž-2019-149  
(220) 04.04.2019.  
(732) W2 Company d.o.o., Dalmatinska bb, 81000, Podgorica, ME  
(540)

## ALEXSHOP

(550) I

(740) Miladin Popović , Đoka Miraševića 21/III, Podgorica

(511) Klasa 35: Usluge maloprodaje, i online/internet maloprodaje u vezi sa satovima, nakitom, naočarima za sunce, naočarima za vid, futrolama za naočare i ostalom potrošačkom robom.

---

(111) **15248**  
(151) 16.03.2021.  
(210) Ž-2020-286  
(220) 13.08.2020.  
(732) DAILY PRESS d.o.o. Podgorica, Trg Nezavisnosti bb, Podgorica, ME  
(540)



(550) I

(740) Jelena Vujisić, Bulevar Ivana Crnojevića 56/2, 81000, Podgorica

(511) Klasa 16: Albumi, ambalaža (papir za ambalažu), blokovi [notesi], blokovi [papirnati proizvodi], blokovi [povezani listovi papira], blokovi za crtanje, časopisi [periodični], časopisi [revije], čelična slova, čestitke, čestitke sa muzikom, fascikle [kancelarijski pribor], fascikle [papirni proizvodi], fascikle za papir, fotografije (stalci za fotografije), fo tografije (uređaji za lijepljenje fotografija), fotografije [štampane], fotograavure, grafičke slike, hektografi, mašine za umnožavanje, isprave (spravice za plastificiranje isprava) [kancelarijski pribor], isprave [dokument] (futrole za isprave), kalendari, kalendari [godišnjaci], kalendari kojima se listovi trgaju, kancelarijski pribor [osim namještaja], karte\*,kartonski proizvodi, kaširani papir, katalozi, kistovi, knjige, knjige (oznake za stranice u knjigama), knjige sa pjesmama, kompjuterski programi (papirne trake ili kartice za upis kompjuterskih programa),kompjuterski štampači (trake natopljene bojom

za štampače), korice za neuvezane časopise, kutije, kartonske ili papirne, listovi [papirnati proizvodi], manžetne za držanje pisaćeg pribora, marke, poštanske, mašine, pisaće [električni ili neelektrični], matrice [papirni proizvodi], matrice za umnožavanje [šablone], nacrti, nacrti (sprave za izradu nacrti), naljepnice (ručne sprave za stavljanje naljepnica), naljepnice [ne od tkanine], naljepnice s adresama, naljepnice, štamparski blokovi, novine, novine sa stripovima, obavještenja [papirnati proizvodi], obrasci, obrasci za precrtavanje [kopije], olovke, omoti [korice], papirni, omotnice [papirnati proizvodi], omotnice (uredski strojevi za zatvaranje omotnica), papir \*, papirni pribor, pisaće mašine, električni ili neelektrični, pisma (papir za pisma), plakati [poster], plakati, papirni ili kartonski, priručnici, prospekti, publikacije, registri [knjige], reprodukcije, grafičke, slike, spisi (držači spisa) [kancelarijski pribor], sveske za pisanje i crtanje, školska oprema, štampane materije [štampane materije], štamparska slova, štamparski proizvodi, ulaznice, vozne karte, birački listići i slični proizvodi, umnožavanje (uređaji za ručno umnožavanje), zastavice od papira, znakovi [brojke i slova].

Klasa 35: Agencije za komercijalne oglase, ekonomska predviđanja [prognoze], fotokopiranje (usluge fotokopiranja), isporuka reklamnih materijala [letaka, prospekata, uzoraka], isporuka reklamnih oglasa, isprave (umnožavanje isprava), istraživanje javnog mišljenja, iznajmljivanje reklamnih prostora, iznajmljivanje vremena za reklamiranje na svim komunikacionim sredstvima, javno mnijenje (istraživanje javnog mnjenja) [anketiranje], javnost (odnosi s javnošću) [propaganda], marketing, novine (usluge pretplate novina) za treće osobe, objavljivanje reklamnih tekstova, oglašavanje [reklamiranje], plakatiranje [oglašavanje], predstavljanje proizvoda [demonstracija], prelamanje stranica u reklamne svrhe [stavljanje u štampu u reklamne svrhe], prepis saopštenja, reklamiranje dopisnim putem, reklamiranje on-line na informatičkoj mreži, reklamna dokumentacija (uređenje reklamne dokumentacije), reklamni materijal (raznošenje reklamnog materijala), sajmovi (organizovanje sajmova u komercijalne ili reklamne svrhe), štampa (praćenje štampe), tekst (obrada teksta).

Klasa 38: Agencije za novosti, informativne agencije [novosti], kompjuter (prijenos poruka i slika uz pomoć kompjutera), kompjuterski prijenos poruka i slika, kompjuterski terminali (komunikacije putem kompjuterskih terminala), konferencije na daljinu (omogućavanje vođenja konferencija na daljinu), telekomunikacije (informacije o telekomunikacijama), vijesti (agencije za vijesti).

---

(111) **15249**

(151) 16.03.2021.

(210) Ž-2020-288

(220) 13.08.2020.

(732) TELEVIZIJA VIJESTI d.o.o. Podgorica, Trg Nezavisnosti bb, Podgorica, ME

(540)

## BOJE JUTRA

(550) I



(740) Jelena Vujisić, Bulevar Ivana Crnojevića 56/2, 81000, Podgorica

(511) Klasa 35: Reklamiranje dopisnim putem, reklamiranje on-line na informatičkoj mreži, reklamiranje putem radija, reklamiranje putem televizije, reklamna dokumentacija (uređenje reklamne dokumentacije), reklamni filmovi (proizvodnja reklamnih filmova), reklamni tekstovi (uređenje reklamnih tekstova).

Klasa 38: Bežična radiodifuzija, emitovanje radio programa, emitovanje televizijskih programa, komuniciranje posredstvom mreža optičkih kablova, konferencije na daljinu (omogućavanje vođenja konferencija na daljinu), prenos digitalnih datoteka, prenos putem satelita, prenos poruka, prenos televizijskih emisija pretplatnicima putem kablova (kablovska televizija), prenos videosadržaja na zahtjev, radijska komunikacija, radiodifuzija, streaming podataka, usluge agencija za vijesti.

Klasa 41: Elektronske publikacije (iskorišćavanje elektronskih publikacija koje se ne mogu prenositi on line), fotografisanje, fotografske reportaže, iznajmljivanje radijskih i televizijskih aparata, iznajmljivanje rasvjetnih uređaja za pozorišnu dekoraciju i za televizijske studije, iznajmljivanje videokamera, iznajmljivanje videotraka, iznajmljivanje zvučnih snimaka, izrada scenarija, osim za potrebe oglašavanja, mikrofilmovi (snimanje na mikrofilmove), mikroizdavaštvo, montaža radijskih i televizijskih programa, obavještenja o vaspitanju, obavještenja o razonodi, organizovanje i provođenje obrazovnih foruma uživo, pisanje scenarija, pisanje tekstova, prikazivanje igranih filmova, pružanje filmova koji se ne mogu preuzeti putem usluga prenosa videozapisa na zahtjev, pružanje televizijskih programa koji se ne mogu preuzeti putem usluga prenosa videozapisa na zahtjev, razonoda posredstvom radija, razonoda posredstvom televizije, reporterske usluge, sinhronizacija, slobodno vrijeme (usluge za ispunjavanje slobodnog vremena), snimanje na videotrake, studio za snimanje (usluge studija za snimanje), titlovanje filmova, usluge razonode, videotrake (montaža videotraka).

---

(111) **15250**

(151) 16.03.2021.

(210) Ž-2020-289

(220) 13.08.2020.

(732) TELEVIZIJA VIJESTI d.o.o. Podgorica, Trg Nezavisnosti bb, Podgorica, ME

(540)

## REFLEKTOR

(550) I

(740) Jelena Vujisić, Bulevar Ivana Crnojevića 56/2, 81000, Podgorica

(511) Klasa 35: Reklamiranje dopisnim putem, reklamiranje on-line na informatičkoj mreži, reklamiranje putem radija, reklamiranje putem televizije, reklamna dokumentacija (uređenje reklamne dokumentacije), reklamni filmovi (proizvodnja reklamnih filmova), reklamni tekstovi (uređenje reklamnih tekstova).

Klasa 38: Bežična radiodifuzija, emitovanje radio programa, emitovanje televizijskih programa, komuniciranje posredstvom mreža optičkih kablova, konferencije na daljinu (omogućavanje vođenja konferencija na daljinu), prenos digitalnih datoteka, prenos putem satelita, prenos poruka, prenos televizijskih emisija pretplatnicima putem kablova (kablovska televizija), prenos videosadržaja na zahtjev, radijska komunikacija, radiodifuzija, streaming podataka, usluge agencija za vijesti.

Klasa 41: Elektronske publikacije (iskorišćavanje elektronskih publikacija koje se ne mogu prenositi on line), fotografisanje, fotografske reportaže, iznajmljivanje radijskih i televizijskih aparata, iznajmljivanje rasvjetnih uređaja za pozorišnu dekoraciju i za te levizijske studije, iznajmljivanje videokamera, iznajmljivanje videotraka, iznajmljivanje zvučnih snimaka, izrada scenarija, osim za potrebe oglašavanja, mikrofilmovi (snimanje na mikrofilmove), mikroizdavaštvo, montaža radijskih i televizijskih programa, obavještenja o vaspitanju, obavještenja o razonodi, organizovanje i provođenje obrazovnih foruma uživo, pisanje scenarija, pisanje tekstova, prikazivanje igranih filmova, pružanje filmova koji se ne mogu preuzeti putem usluga prenosa videozapisa na zahtjev, prutanje televizijskih programa koji se ne mogu preuzeti putem usluga prenosa videozapisa na zahtjev, razonoda posredstvom radija, razonoda posredstvom televizije, reporterske usluge, sinhronizacija, slobodno vrijeme (usluge za ispunjavanje slobodnog vremena), snimanje na videotrake, studio za snimanje (usluge studija za snimanje), titlovanje filmova, usluge razonode, videotrake (montaža videotraka).

---

(111) **15251**

(151) 16.03.2021.

(210) Ž-2020-168

(220) 25.05.2020.

(732) TOYOTA JIDOSHA KABUSHIKI KAISHA (also trading as TOYOTA MOTOR CORPORATION), 1, Toyota-cho, Toyota-shi, Aichi-ken, JP

(540)

## TOYOTA BZ

(550) I

(740) Jasna Jusić, Marka Radovića 37, 1. sprat, stan br. 4., 81000, Podgorica

(511) Klasa 12: Automobili i njihovi strukturalni djelovi.

---

(111) **15252**

(151) 16.03.2021.

(210) Ž-2020-133

(220) 30.04.2020.

(732) TMH Worldwide, LLC, 22 Sylvan Way, 07054, Parsippany, New Jersey, US

(540)

## TRADEMARK COLLECTION

(550) I

(740) Jasna Jusić, Marka Radovića 37, 1. sprat, stan br. 4., 81000, Podgorica

(511) Klasa 43: Usluge smještaja u hotel rizortima, hotelima, motelima i restoranske usluge; pravljenje rezervacija smještaja u ime drugih; ugostiteljske usluge, naime, pružanje smještaja, hrane i pića; hotel, smeštaj i prenoćište.

---

(111) **15253**

(151) 17.03.2021.

(210) Ž-2020-267

(220) 31.07.2020.

(732) Monster Energy Company, a Delaware corporation, 1 Monster Way, 92879, Corona, California, US

(540)

## MONSTER ASSAUL

(550) I

(740) Božidar S.Radulović, Baku 30/5, 81000, Podgorica

(511) Klasa 32: Bezalkoholna pića, uključujući gazirana pića i energetska pića; sirupi, koncentрати, praškasti preparati i drugi preparati za proizvodnju pića, uključujući gazirana pića i energetska pića.

---

(111) **15254**

(151) 17.03.2021.

(210) Ž-2020-268

(220) 31.07.2020.

(732) Monster Energy Company, a Delaware corporation, 1 Monster Way, 92879, Corona, California, US

(540)

## RIPPER

(550) I

(740) Božidar S.Radulović, Baku 30/5, 81000, Podgorica

(511) Klasa 32: Bezalkoholna pića, uključujući gazirana pića i energetska pića; sirupi, koncentрати, praškasti preparati i drugi preparati za proizvodnju pića, uključujući gazirana pića i energetska pića.

---

(111) **15255**

(151) 17.03.2021.

(210) Ž-2020-269

(220) 31.07.2020.

(732) Monster Energy Company, a Delaware corporation, 1 Monster Way, 92879, Corona, California, US

(540)

## KHAOS

(550) I

(740) Božidar S.Radulović, Baku 30/5, 81000, Podgorica

(511) Klasa 32:

---

(111) **15256**

(151) 17.03.2021.

(210) Ž-2020-270

(220) 03.08.2020.

(732) Shenzhen Netis Technology Co., Ltd., 801, Building B, TongFang Information Harbor, No.11 Langshan Road, Nanshan District, Shenzhen, CN

(540)

The logo for 'stonet' features a stylized 'i' icon on the left, followed by the word 'stonet' in a lowercase, sans-serif font.

(550) I

(740) Božidar S.Radulović, Baku 30/5, 81000, Podgorica

(511) Klasa 9: Električne žice; električni kablovi; modemi; električni terminali; razvodne kutije (za struju); instalacije za razmenu kod telefona koji se mogu programirati; telefonske žice; materijali za električne vodove (žice, kablovi); kontakti za električne linije; antene; prenosivi multimedijalni plejeri; mrežna komunikaciona oprema; bežični ruteri; konektori (strujni); razvodne table; mrežne kartice (adapteri); strujni adapteri; kamere za vožnju unazad; računarski terminali; radio aparati.

---

(111) **15257**

(151) 17.03.2021.

(210) Ž-2020-143

(220) 07.05.2020.

(732) KT & G Corporation , 71, Beotkkot-gil, Daedeok-gu, Daejeon, KR

(540)

**KT&G EDGE GRIP**

(550) I

(740) Miladin Popović, Đoka Miraševića 21/III, 81000, Podgorica

(511) Klasa 34: Duvan; cigarete; cigare; burmut; papir za cigarete; lule za duvan; filteri za cigarete; kutije za cigarete (ne od plemenitih metala); kesice za duvan; upaljači za cigarete (ne metala); rezači za cigare.od plemenitih metala); šibice; sredstva za čišćenje lula za duvan; pepeljare za pušače (ne od plemenitih metala); rezači za cigare.

---

(111) **15258**

(151) 17.03.2021.

(210) Ž-2020-144

(220) 07.05.2020.

(732) KT & G Corporation , 71, Beotkkot-gil, Daedeok-gu, Daejeon, KR

(540)

**KT&G EDGE POP**

(550) I

(740) Miladin Popović, Đoka Miraševića 21/III, 81000, Podgorica

(511) Klasa 34: Duvan; cigarete; cigare; burmut; papir za cigarete; lule za duvan; filteri za cigarete; kutije za cigarete (ne od plemenitih metala); kesice za duvan; upaljači za cigarete (ne od plemenitih metala); šibice; sredstva za čišćenje lula za duvan; pepeljare za pušače (ne od plemenitih metala); rezači za cigare.

---

(111) **15259**

(151) 17.03.2021.

(210) Ž-2020-145

(220) 07.05.2020.

(732) KT & G Corporation , 71, Beotkkot-gil, Daedeok-gu, Daejeon, KR

(540)

**KT&G RAISON**

(550) I

(740) Miladin Popović, Đoka Miraševića 21/III, 81000, Podgorica

(511) Klasa 34: Duvan; cigarete; cigare; burmut; papir za cigarete; lule za duvan; filteri za cigarete; kutije za cigarete (ne od plemenitih metala); kesice za duvan; upaljači za cigarete (ne od plemenitih metala); šibice; sredstva za čišćenje lula za duvan; pepeljare za pušače (ne od plemenitih metala); rezači za cigare.

---

(111) **15260**

(151) 17.03.2021.

(210) Ž-2020-146

(220) 07.05.2020.

(732) KT & G Corporation, 71, Beotkkot-gil, Daedeok-gu, Daejeon, KR

(540)

**KT&G THIS**

(550) I

(740) Miladin Popović, Đoka Miraševića 21/III, 81000, Podgorica

(511) Klasa 34: Duvan; cigarete; cigare; burmut; papir za cigarete; lule za duvan; filteri za cigarete; kutije za cigarete (ne od plemenitih metala); kesice za duvan; upaljači za cigarete

(ne od plemenitih metala); šibice; sredstva za čišćenje lula za duvan; pepeljare za pušaće (ne od plemenitih metala); rezači za cigare.

---

(111) **15261**

(151) 17.03.2021.

(210) Ž-2020-147

(220) 07.05.2020.

(732) KT & G Corporation , 71, Beotkkot-gil, Daedeok-gu, Daejeon, KR

(540)

## KT&G TIME

(550) I

(740) Miladin Popović, Đoka Miraševića 21/III, 81000, Podgorica

(511) Klasa 34: Duvan; cigarete; cigare; burmut; papir za cigarete; lule za duvan; filteri za cigarete; kutije za cigarete (ne od plemenitih metala); kesice za duvan; upaljači za cigarete (ne od plemenitih metala); šibice; sredstva za čišćenje lula za duvan; pepeljare za pušaće (ne od plemenitih metala); rezači za cigare.

---

(111) **15262**

(151) 17.03.2021.

(210) Ž-2019-110

(220) 19.03.2019.

(732) OTP Bank Nyrt., Nádor u. 16, 1051, Budapest, HU

(540)



(550) I

(740) Luka Stijepović, Bulevar Svetog Petra Cetinjskog 130/VII, 81000, Podgorica

(511) Klasa 35: Promocija roba i usluga kroz sponzorisanje sportskih događaja; privremeno poslovno upravljanje; ciljni marketing; upravljanje programima lojalnosti potrošača; oglašavanje; organizovanje izložbi za privredne ili reklamne potrebe; optimizacija pretraživača za promociju prodaje; marketing; oglašavanje plaćanjem po kliku (pay per click oglašavanje); ažuriranje oglasnih materijala; iznajmljivanje vremena za reklamiranje u

sredstvima komunikacije; oglašavanje na otvorenom.

Klasa 36: Osiguranje (informacije o osiguranju); bolesničko osiguranje; usluge osiguranja; osiguranje (savjetovanje o osiguranju); životno osiguranje (potpisivanje polisa za osiguranje života); monetarni poslovi; dugovanje (službe za kartice dugovanja [debit kartice]); novčana sredstva (elektronski prijenos novčanih sredstava); faktoring; kreditne kartice (izdavanje kreditnih kartica); kreditne kartice (službe za kreditne kartice); zalog (davanje zajma uz zalog); zajmovi; bankovne transakcije (obavljanje bankovnih transakcija, kućne) [home-banking]; otplata na rate; sigurnosne blagajne [sefovi] (odlaganje u sigurnosne blagajne); štedionice [usluge štedionica]; usluge menjačnica; pozajmljivanje na temelju zaloga.

---

(111) **15263**

(151) 17.03.2021.

(210) Ž-2019-111

(220) 19.03.2019.

(732) OTP Bank Nyrt., Nádor u. 16, 1051, Budapest, HU

(540)



(550) I

(740) Luka Stijepović, Bulevar Svetog Petra Cetinjskog 130/VII, 81000, Podgorica

(511) Klasa 35: Promocija roba i usluga kroz sponzorisanje sportskih događaja; privremeno poslovno upravljanje; ciljni marketing; upravljanje programima lojalnosti potrošača; oglašavanje; organizovanje izložbi za privredne ili reklamne potrebe; optimizacija pretraživača za promociju prodaje; marketing; oglašavanje plaćanjem po kliku (pay per click oglašavanje); ažuriranje oglasnih materijala; iznajmljivanje vremena za reklamiranje u sredstvima komunikacije; oglašavanje na otvorenom.

Klasa 36: Osiguranje (informacije o osiguranju); bolesničko osiguranje; usluge osiguranja; osiguranje (savjetovanje o osiguranju); životno osiguranje (potpisivanje polisa za osiguranje života); monetarni poslovi; dugovanje (službe za kartice dugovanja [debit kartice]); novčana sredstva (elektronski prijenos novčanih sredstava); faktoring; kreditne kartice (izdavanje kreditnih kartica); kreditne kartice (službe za kreditne kartice); zalog (davanje zajma uz zalog); zajmovi; bankovne transakcije (obavljanje bankovnih transakcija, kućne) [home-banking]; otplata na rate; sigurnosne blagajne [sefovi] (odlaganje u sigurnosne blagajne); štedionice [usluge štedionica]; usluge menjačnica; pozajmljivanje na temelju zaloga.



(111) **15264**

(151) 17.03.2021.

(210) Ž-2020-148

(220) 07.05.2020.

(732) KT & G Corporation , 71, Beotkkot-gil, Daedeok-gu, Daejeon, KR

(540)

## KT&G TIMELESS TIME

(550) I

(740) Miladin Popović, Đoka Miraševića 21/III, 81000, Podgorica

(511) Klasa 34: Duvan; cigarete; cigare; burmut; papir za cigarete; lule za duvan; filteri za cigarete; kutije za cigarete (ne od plemenitih metala); kesice za duvan; upaljači za cigarete (ne od plemenitih metala); šibice; sredstva za čišćenje lula za duvan; pepeljare za pušaće (ne od plemenitih metala); rezači za cigare.

---

(111) **15265**

(151) 17.03.2021.

(210) Ž-2020-150

(220) 07.05.2020.

(732) KT & G Corporation , 71, Beotkkot-gil, Daedeok-gu, Daejeon, KR

(540)

## EDGE

(550) I

(740) Miladin Popović, Đoka Miraševića 21/III, 81000, Podgorica

(511) Klasa 34: Duvan; cigarete; cigare; burmut; papir za cigarete; lule za duvan; filteri za cigarete; kutije za cigarete (ne od plemenitih metala); kesice za duvan; upaljači za cigarete (ne od plemenitih metala); šibice; sredstva za čišćenje lula za duvan; pepeljare za pušaće (ne od plemenitih metala); rezači za cigare.

---

(111) **15266**

(151) 17.03.2021.

(210) Ž-2020-151

(220) 07.05.2020.

(732) KT & G Corporation , 71, Beotkkot-gil, Daedeok-gu, Daejeon, KR

(540)

## EDGE GRIP

(550) I

(740) Miladin Popović, Đoka Miraševića 21/III, 81000, Podgorica

(511) Klasa 34: Duvan; cigarete; cigare; burmut; papir za cigarete; lule za duvan; filteri za cigarete; kutije za cigarete (ne od plemenitih metala); kesice za duvan; upaljači za cigarete (ne od plemenitih metala); šibice; sredstva za čišćenje lula za duvan; pepeljare za pušače (ne od plemenitih metala); rezači za cigare.

---

(111) **15267**

(151) 17.03.2021.

(210) Ž-2020-152

(220) 07.05.2020.

(732) KT & G Corporation , 71, Beotkkot-gil, Daedeok-gu, Daejeon, KR

(540)

## EDGE POP

(550) I

(740) Miladin Popović, Đoka Miraševića 21/III, 81000, Podgorica

(511) Klasa 34: Duvan; cigarete; cigare; burmut; papir za cigarete; lule za duvan; filteri za cigarete; kutije za cigarete (ne od plemenitih metala); kesice za duvan; upaljači za cigarete (ne od plemenitih metala); šibice; sredstva za čišćenje lula za duvan; pepeljare za pušače (ne od plemenitih metala); rezači za cigare.

---

(111) **15268**

(151) 17.03.2021.

(210) Ž-2020-153

(220) 07.05.2020.

(732) KT & G Corporation , 71, Beotkkot-gil, Daedeok-gu, Daejeon, KR

(540)

## KT&G BOHEM

(550) I

(740) Miladin Popović, Đoka Miraševića 21/III, 81000, Podgorica

(511) Klasa 34: Duvan; cigarete; cigare; burmut; papir za cigarete; lule za duvan; filteri za cigarete; kutije za cigarete (ne od plemenitih metala); kesice za duvan; upaljači za cigarete (ne od plemenitih metala); šibice; sredstva za čišćenje lula za duvan; pepeljare za pušaće (ne od plemenitih metala); rezači za cigare.

---

(111) **15269**

(151) 17.03.2021.

(210) Ž-2019-389

(220) 11.10.2019.

(732) Mylan Healthcare GmbH, Lütticher Straße 5, 53842, Troisdorf, DE

(540)

## Brufenex

(550) I

(740) Miladin Popović, ul. Capital Plaza, ulica šeika Zajeda 13-IV/68, 81000, Podgorica

(511) Klasa 5: Farmaceutski preparati posebno za liječenje prehlade, rinitisa, rinofaringitisa i gripa.

---

(111) **15270**

(151) 17.03.2021.

(210) Ž-2019-185

(220) 09.05.2019.

(732) Hemofarm A.D. farmaceutsko-hemijska industrija Vršac, Beogradski put bb, 26300, Vršac, RS

(540)

## ZANIDA

(550) I

(740) AOD MSA IP - Milojević Sekulić Advokati, Karađorđeva 65, 11000, Beograd

(511) Klasa 5: Farmaceutski preparati namijenjeni liječenju epilepsije.

---

(111) **15271**

(151) 17.03.2021.

(210) Ž-2019-279

(220) 12.07.2019.

(732) Allied Beverages Adriatic d.o.o., Batajnički drum 18, Zemun, 11080, Beograd, RS

(540)

UVIJEK UZ TEBE

(550) I

(740) Miladin Popović, Đoka Miraševića 21/III, 81000, Podgorica

(511) Klasa 32: Pića, uključujući vode za piće, vode sa ukusom, mineralne i gazirane vode; ostala bezalkoholna pića, uključujući osvježavajuća bezalkoholna pića, energetska pića i pića za sportiste; voćni napici i sokovi uključujući kokosovu vodu; sirupi, koncentрати, praškovi i drugi preparati za pripremu pića, uključujući vode sa ukusom, mineralne i gazirane vode, osvježavajuća bezalkoholna pića, energetska pića, pića za sportiste, voćne napitke i sokove; napici i sokovi od povrća.

---

(111) **15272**

(151) 17.03.2021.

(210) Ž-2019-323

(220) 29.08.2019.

(732) Philip Morris Products S.A., Quai Jeanrenaud 3, 2000, Neuchâtel, CH

(540)



(550) I

(740) Milena Pejović, Cetinjski put 11/4, The Capital Plaza , 81000, Podgorica

(511) Klasa 9: Mobilne aplikacije, aplikacije za mobilne uređaje koje se mogu preuzimati.  
Klasa 34: Duvan, sirov ili prerađen; duvanski proizvodi; cigare, cigarete, cigarilosi, duvan za uvijanje cigareta, duvan za lule, duvan za žvakanje, duvan za šmrkanje, kretek; snus (duvan u prahu); zamena za duvan (za nemedicinsku upotrebu); elektronske cigarete; duvanski proizvodi za zagrevanje; elektronski uređaji, i njihovi delovi, koji se koriste za zagrevanje cigareta ili duvana u cilju oslobađanja aerosola koji sadrži nikotin za inhalaciju; tečni nikotinski rastvori za upotrebu u elektronskim cigaretama; artikli za pušače, papir za cigarete, tube za cigarete, filteri za cigarete, kutije za duvan, kutije za cigarete, tabakere, pepeljare, lule, džepne mašine za uvijanje cigareta, upaljači; šibice.

Klasa 35: Usluge promovisanja trgovine, oglašavanje; distribucija reklamnog materijala; usluge marketinga i promocije; marketinške usluge koje se pružaju putem digitalnih mreža; upravljanje programima lojalnosti potrošača.

---

(111) **15273**

(151) 17.03.2021.

(210) Ž-2019-78

(220) 05.03.2019.

(300) FR, broj 4480404 od 05.09.2018.

(732) Philip Morris Products S.A., Quai Jeanrenaud 3, 2000, Neuchâtel, CH

(540)

## UNSMOKE YOUR WORLD

(550) I

(740) Milena Pejović, Cetinjski put 11, The Capital Plaza IV floor,, 81000, Podgorica

(511) Klasa 35: Saopštavanje za javnost o izjavama ili najavama bilo kojim sredstvima za širenje vesti i u vezi sa svim vrstama roba ili usluga, uključujući one koje se odnose na javno zdravlje, životni stil, duvan, zaštitu životne sredine; upravljanje programima lojalnosti pacijenata i potrošača. Usluge agencija za pružanje informacija, usluge oglašavanja; prezentacija robe; usluge demonstracije i veleprodaja ili maloprodaja proizvoda za negu, prirodnih prehrambenih proizvoda, kozmetike, higijene, proizvoda za prestanak pušenja. Usluge institucionalne kampanje, uključujući pomoć pušačima i nepušačima u pogledu duvana, nusproizvoda i zamene duvana.

Klasa 38: Telekomunikacije; usluge novinskih agencija; pružanje usluga internet foruma za diskusiju; emitovanje televizijskih programa; usluge koje omogućavaju pušačima i nepušačima da razgovaraju sa specijalistima.

Klasa 41: Obrazovne usluge; pružanje usluge treniranja; usluge razonode; sportske i kulturne aktivnosti. Usluge iznajmijivanja iz biblioteke; usluge razonode, sportske, obrazovne klupske usluge; organizacija i vođenje sportskih takmičenja, kolokvijuma,

konferencija, kongresa, predstava; nastavna ispitivanja, praktična nastava [obuka putem demonstracije]; časovi fitnesa; objavljivanje knjiga i magazina. Iznajmljivanje kinematografskih filmova; Podučavanje.

Klasa 44: Zdravstvene usluge, usluge savetovanja o zdravlju; medicinske usluge; veterinarske usluge; usluge održavanja higijene i usluge nege lepote za ljude ili životinje; usluge savetovanja o zdravlju; savetovanje, lečenje i terapijska ili informativna podrška za prestanak pušenja; usluge detoksikacije . Usluge u poljoprivredi, hortikulturi šumarstvu. Medicinske usluge; veterinarske usluge; usluge održavanja higijene usluge nege lepote za ljude ili životinje; usluge u poljoprivredi, hortikulturi šumarstvu. Usluge u vezi sa uzgojem biljaka. Iznajmljivanje medicinske opreme.

---

(111) **15274**

(151) 18.03.2021.

(210) Ž-2020-154

(220) 07.05.2020.

(732) KT & G Corporation , 71, Beotkkot-gil, Daedeok-gu, Daejeon, KR

(540)

**KT&G EDGE**

(550) I

(740) Miladin Popović, Đoka Miraševića 21/III, 81000, Podgorica

(511) Klasa 34: Duvan; cigarete; cigare; burmut; papir za cigarete; lule za duvan; filteri za cigarete; kutije za cigarete (ne od plemenitih metala); kesice za duvan; upaljači za cigarete (ne od plemenitih metala); šibice; sredstva za čišćenje lula za duvan; pepeljare za pušače (ne od plemenitih metala); rezači za cigare.

---

(111) **15275**

(151) 18.03.2021.

(210) Ž-2020-155

(220) 07.05.2020.

(732) KT & G Corporation , 71, Beotkkot-gil, Daedeok-gu, Daejeon, KR

(540)

**THIS PLUS**

(550) I

(740) Miladin Popović, Đoka Miraševića 21/III, 81000, Podgorica

(511) Klasa 34: Duvan; cigarete; cigare; burmut; papir za cigarete; lule za duvan; filteri za cigarete; kutije za cigarete (ne od plemenitih metala); kesice za duvan; upaljači za cigarete (ne od plemenitih metala); šibice; sredstva za čišćenje lula za duvan; pepeljare za pušače (ne od plemenitih metala); rezači za cigare.

---

(111) **15276**

(151) 18.03.2021.

(210) Ž-2020-156

(220) 07.05.2020.

(732) KT & G Corporation , 71, Beotkkot-gil, Daedeok-gu, Daejeon, KR

(540)

THIS

(550) I

(740) Miladin Popović, Đoka Miraševića 21/III, 81000, Podgorica

(511) Klasa 34: Duvan; cigarete; cigare; burmut; papir za cigarete; lule za duvan; filteri za cigarete; kutije za cigarete (ne od plemenitih metala); kesice za duvan; upaljači za cigarete (ne od plemenitih metala); šibice; sredstva za čišćenje lula za duvan; pepeljare za pušače (ne od plemenitih metala); rezači za cigare.

---

(111) **15277**

(151) 18.03.2021.

(210) Ž-2020-157

(220) 07.05.2020.

(732) KT & G Corporation , 71, Beotkkot-gil, Daedeok-gu, Daejeon, KR

(540)

RAISON

(550) I

(740) Miladin Popović, Đoka Miraševića 21/III, 81000, Podgorica

(511) Klasa 34: Duvan; cigarete; cigare; burmut; papir za cigarete; lule za duvan; filteri za cigarete; kutije za cigarete (ne od plemenitih metala); kesice za duvan; upaljači za cigarete

(ne od plemenitih metala); šibice; sredstva za čišćenje lula za duvan; pepeljare za pušaće (ne od plemenitih metala); rezači za cigare.

---

(111) **15278**

(151) 18.03.2021.

(210) Ž-2020-8

(220) 15.01.2020.

(732) Pharmaceutical chemical cosmetic industry ALKALOID AD Skopje, Blvd. Aleksandar Makedonski 12, 1000, Skopje, MK

(540)

## FELKARID

(550) I

(740) Miladin Popović, ul. Capital Plaza, ulica šeika Zajeda 13-IV/68, 81000, Podgorica

(511) Klasa 5: Farmaceutski preparati.

---

(111) **15279**

(151) 18.03.2021.

(210) Ž-2020-136

(220) 30.04.2020.

(732) Alvogen Pharma Trading Europe EOOD (Bulgaria), 86A Bulgaria Blvd, 1st Floor., 1680, Sofia, BG

(540)

## VARLOTA

(550) I

(740) Miladin Popović, Đoka Miraševića 21/III, 81000, Podgorica

(511) Klasa 5: Farmaceutski preparati, naročito za liječenje kancera, svi u klasi 05.

---

(111) **15280**

(151) 18.03.2021.



(210) Ž-2020-158

(220) 08.05.2020.

(732) BONIFAR d.o.o., Omladinskih brigada 80/1, 11070, Novi Beograd, RS

(540)

## RESPILONG

(550) I

(740) Miladin Popović, Đoka Miraševića 21/III, 81000, Podgorica

(511) Klasa 5: Dijetetski proizvodi; farmaceutski preparati; sanitarni preparati za medicinsku upotrebu.

---

(111) **15281**

(151) 18.03.2021.

(210) Ž-2020-65

(220) 25.02.2020.

(732) Montenegro Adventures d.o.o., Ulica Jovana Tomaševića broj 35, Podgorica, ME

(540)



(550) I

(740) AOD Durutović, Vuksanović & Kraljević, Trg Nezavisnosti 1, 81000

(511) Klasa 39: Organizovanje putovanja.

---

(111) **15282**

(151) 18.03.2021.

(210) Ž-2020-221

(220) 26.06.2020.

(732) PFIZER INC., 235 East 42nd Street, 10017, New York, New York, US

(540)

## TRAZIMERA

(550) I

(740) Jasna Jusić, Marka Radovića 37, 1. sprat, stan br. 4., 81000, Podgorica

(511) Klasa 5: Farmaceutski preparati za liječenje raka.

---

(111) **15283**

(151) 19.03.2021.

(210) Ž-2020-212

(220) 22.06.2020.

(732) Pharmaceutical chemical cosmetic industry ALKALOID AD Skopje, Blvd. Aleksandar Makedonski 12, 1000, Skopje, MK

(540)

## GLOFTRINID

(550) I

(740) Miladin Popović, Đoka Miraševića 21/III, 81000, Podgorica

(511) Klasa 5: Farmaceutski preparati.

---

(111) **15284**

(151) 19.03.2021.

(210) Ž-2020-94

(220) 06.03.2020.

(732) Pharmalys Laboratories SA, Siedereistrasse 9, Hochdorf, CH-6280, CH

(540)



(550) I

(740) Božidar S. Radulović, Studentska bb, Lamela 3/18, 81000, Podgorica

(511) Klasa 5: Farmaceutski i veterinarski proizvodi; dijetetska hrana i supstance za medicinsku ili veterinarsku upotrebu, hranu za bebe; dodaci ishrani za ljude i životinje; mlijeko u prahu za bebe; hrana za bebe; dijetetski dodaci ishrani.

---

(111) **15285**

(151) 19.03.2021.

(210) Ž-2020-191

(220) 07.05.2020.

(732) Društvo za proizvodstvo, promet i uslugi VIVAKS DOO uvoz-izvoz Skopje, Pero Nakov br.21, 1000, Skopje, MK

(540)



(550) I

(740) Milena Pejović, Cetinjski put 11, The Capital Plaza IV floor, 81000, Podgorica

(511) Klasa 32:

---

(111) **15286**

(151) 19.03.2021.

(210) Ž-2020-192

(220) 07.05.2020.

(732) Društvo za proizvodstvo, promet i uslugi VIVAKS DOO uvoz-izvoz Skopje, Pero Nakov br.21, 1000, Skopje, MK

(540)



(550) I

(740) Milena Pejović, Cetinjski put 11, The Capital Plaza IV floor, 81000, Podgorica

(511) Klasa 32: Pivo; mineralne i gazirane vode i ostala bezalkoholna pića; pića od voća i voćni sokovi; sirupi i ostali preparati za pripremanje napitaka.

---

(111) **15287**

(151) 19.03.2021.

(210) Ž-2020-193

(220) 07.05.2020.

(732) Društvo za proizvodstvo, promet i usluge VIVAKS DOO uvoz-izvoz Skopje, Pero Nakov br.21, 1000, Skopje, MK

(540)



(550) I

(740) Milena Pejović, Cetinjski put 11, The Capital Plaza IV floor, 81000, Podgorica

(511) Klasa 32: Pivo; mineralne i gazirane vode i ostala bezalkoholna pića; pića od voća i voćni sokovi; sirupi i ostali preparati za pripremanje napitaka.

(111) **15288**

(151) 22.03.2021.

(210) Ž-2020-167

(220) 25.05.2020.

(732) British American Tobacco (Brands) Inc., 251 Little Falls Drive, Suite 100, DE 19808-1674, Wilmington, US

(540)

## LUCKY STRIKE SLOW CURED

(550) I

(740) Miladin Popović, Đoka Miraševića 21/III, 81000, Podgorica

(511) Klasa 34: Cigarete; duvan, sirov ili prerađen; duvan za samostalno zamotavanje; duvan za lule; duvanski proizvodi; zamjene za duvan ( koji nijesu za upotrebu u medicini); cigare; cigarilos; upaljači za cigarete; upaljači za cigare; šibice; artikli za pušače; cigaret papir; cigaret tube; filteri za cigarete; džepni aparati za zamotavanje cigareta; ručne mašine za ubrizgavanje duvana u papirne tube; elektronske cigarete; tečnosti za elektronske cigarete; duvanski proizvodi namijenjeni za zagrijavanje.

---

(111) **15289**

(151) 22.03.2021.

(210) Ž-2020-222

(220) 29.06.2020.

(732) HELLENIC PETROLEUM S.A., 8A, Chimarras Street, GR-151 25, Maroussi, Athens, GR

(540)



(550) I

(740) Jasna Jusić, Marka Radovića 37, 1. sprat, stan br. 4., 81000, Podgorica

(511) Klasa 4: Energija (električna -).

Klasa 9: Stanice za punjenje električnih vozila.

Klasa 35: Administrativno upravljanje voznim parkom električnih vozila.

Klasa 37: Punjenje akumulatora vozila; instalacijske usluge u vezi s električnom opremom za punjenje električnih vozila; usluge održavanja u vezi s infrastrukturom za punjenje električnih vozila.

Klasa 39: Iznajmljivanje električnih vozila; distribucija energije.

---

(111) **15290**

(151) 22.03.2021.

(210) Ž-2020-223

(220) 29.06.2020.

(732) HELLENIC PETROLEUM S.A., 8A, Chimarras Street, GR-151 25, Maroussi, Athens, GR

(540)



(550) I

(740) Jasna Jusić, Marka Radovića 37, 1. sprat, stan br. 4., 81000, Podgorica

(511) Klasa 4: Energija (električna -).

Klasa 9: Stanice za punjenje električnih vozila.

Klasa 35: Administrativno upravljanje voznim parkom električnih vozila.

Klasa 37: Punjenje akumulatora vozila; instalacijske usluge u vezi s električnom opremom za punjenje električnih vozila; usluge održavanja u vezi s infrastrukturom za punjenje električnih vozila.

Klasa 39: Iznajmljivanje električnih vozila; distribucija energije.

---

(111) **15291**

(151) 22.03.2021.

(210) Ž-2020-139

(220) 05.05.2020.

(732) Benson & Hedges (Overseas) Limited, Globe House, 4 Temple Place, WC2R 2PG, London, GB  
(540)

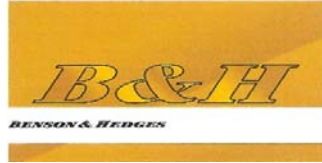

(550) I

(740) Miladin Popović, Đoka Miraševića 21/III, 81000, Podgorica

(511) Klasa 34: Cigarete; duvan, sirov ili prerađen; duvan za samostalno zamotavanje; duvan za lule; duvanski proizvodi; zamjene za duvan (koje nijesu za upotrebu u medicini); cigare; cigarilosi; upaljači za cigarete; upaljači za cigare; šibice; artikli za pušače; cigaret papir, cigaret tube, filteri za cigarete; džepni aparati za zamotavanje cigareta; ručne mašine za ubrizgavanje duvana u papirne tube; elektronske cigarete; tečnosti za elektronske cigarete; duvanski proizvodi namijenjeni za zagrijavanje.

---

(111) **15292**

(151) 22.03.2021.

(210) Ž-2020-140

(220) 05.05.2020.

(732) American-Cigarette Company (Overseas) Limited, Route de France 17, 2926, Boncourt, CH

(540)

**PETER STUYVESANT**

(550) I

(740) Miladin Popović, Đoka Miraševića 21/III, 81000, Podgorica

(511) Klasa 34: Cigarete; duvan, sirov ili prerađen; duvan za samostalno zamotavanje; duvan za lule; duvanski proizvodi; zamjene za duvan (koje nijesu za upotrebu u medicini); cigare; cigarilosi; upaljači za cigarete; upaljači za cigare; šibice; artikli za pušače; cigaret papir, cigaret tube, filteri za cigarete; džepni aparati za zamotavanje cigareta; ručne mašine za ubrizgavanje duvana u papirne tube; elektronske cigarete; tečnosti za elektronske cigarete; duvanski proizvodi namijenjeni za zagrijavanje.

---

(111) **15293**

(151) 22.03.2021.

(210) Ž-2020-293

(220) 19.08.2020.

(732) Merck Sharp & Dohme B.V., Waarderweg 39, 2031 BN, Haarlem, NL

(540)

## ONCOTICE

(550) I

(740) AOD "ĆUPIĆ", Bulevar Džordža Vašingtona 79, 81000, Podgorica

(511) Klasa 5: Farmaceutski preparati i supstance.

---

(111) **15294**

(151) 22.03.2021.

(210) Ž-2020-295

(220) 19.08.2020.

(732) "MOT DESIGN" DOO, Bulevar Revolucije 11b, Bar, ME

(540)



(550) I

(511) Klasa 37: Asfaltiranje; bageri (iznajmljivanje bagera); buldožeri (iznajmljivanje buldožera); bunari (kopanje bunara); bušenje bunara; centralno grijanje (postavljanje i popravak instalacija centralnog grijanja); čišćenje zgrada [spoljnih površina]; građevinski radovi (nadzor građevinskih radova); informacije o graditeljstvu; informacije o popravcima; izgradnja (oglasi o izgradnji), izgradnja \*; iznajmljivanje mašina za gradilišta; izolovanje (usluge izolovanja) [građevinski radovi]; klimatizacija vazduha (postavljanje i popravak uređaja za klimatizaciju); liftovi (postavljanje i popravak liftova); malterisanje; molerske usluge, unutrašnje i spoljašnje [bojanje]; nadzor građevinskih radova [vođenje]; postavljanje skela; prozori i vrata (postavljanje prozora i vrata); putevi (postavljanje slojeva za pokrivanje na ceste); gradilište (iznajmljivanje mašina za gradilište); rušenje građevinskih objekata; skele (postavljanje skela); tapete (postavljanje tapeta); vodoinstalaterski radovi; zaštite građevina od vlage; zgrade (čišćenje zgrada) [spoljnih površina]; zgrade (unutrašnje čišćenje zgrada); zidanje ciglom; zidarski radovi.

Klasa 42: Arhitektura; inženjering; planovi (izrada građevinskih planova); savjeti o gradnji; tehnički projekti (razrada tehničkih projekata); unutrašnje uređenje [dekoracija]; urbanističko



planiranje; agencije za smještaj [hotelski, pansionski].  
Klasa 43: Hotelske usluge.

---

(111) **15295**

(151) 22.03.2021.

(210) Ž-2020-204

(220) 15.06.2020.

(732) TOYOTA JIDOSHA KABUSHIKI KAISHA (also trading as Toyota Motor Corporation), 1, Toyota-cho, Toyota-shi, Aichi-ken, JP

(540)

**BZ4X**

(550) I

(740) Jasna Jusić, Marka Radovića 37, 1. sprat, stan br. 4., 81000, Podgorica

(511) Klasa 12: Automobili i njihovi strukturalni djelovi.

---

(111) **15296**

(151) 24.03.2021.

(210) Ž-2020-137

(220) 04.05.2020.

(732) Reign Beverage Company LLC, a Delaware limited liability company, 1547 N. Knowles Ave., 90063, Los Angeles, California, US

(540)



(550) I

(740) Božidar S. Radulović, Baku 30/5, 81000, Podgorica

(511) Klasa 32: Bezalkoholna pića, uključujući gazirana pića i energetska pića; sirupi, koncentрати, praškasti preparati i drugi preparati za proizvodnju pića, uključujući gazirana pića i energetska pića; pivo.

---

(111) **15297**

(151) 24.03.2021.

(210) Ž-2020-70

(220) 25.02.2020.

(732) Vans, Inc., 1588 South Coast Drive, 92626, Costa Mesa, California, US

(540)

The logo for VANS, featuring the word "VANS" in a bold, black, sans-serif font. The letter "V" is stylized with a horizontal bar extending to the left, creating a distinctive shape.

(550) I

(740) Božidar S. Radulović, Baku 30/5, 81000, Podgorica

(511) Klasa 25: Obuća, sportska obuća, patike, čizme, sandale, čizme za skijanje na dasci, majice, košulje, majice bez rukava, puloveri, dukserice, džemperi, pantalone, farmerke, helanke, donji delovi trenerki, šorcevi, dugački šorcevi za kupanje, haljine, suknje, jakne, prsluci, odeća za skijanje, odeća za skijanje na dasci, odeća za kupanje, jakne za kišu, pantalone za kišu, čarape, donji veš, kaiševi, rukavice, rukavice sa jednim prstom, šalovi i marama, gamašne, štitnici za uši, pokrivala za glavu, šeširi, kape, vunene kape, bandana marama.

---

(111) **15298**

(151) 24.03.2021.

(210) Ž-2020-246

(220) 08.07.2020.

(732) Pharmaceutical chemical cosmetic industry ALKALOID AD Skopje, blvd. Aleksandar Makedonski 12, 1000, Skopje, MK

(540)

The logo for "KIDS VITS Becutan". It features the words "KIDS" and "VITS" in a colorful, playful font. "KIDS" is in blue, "VITS" is in yellow, and there is a red heart between them. Below this, the word "Becutan" is written in a blue, rounded font inside a white rounded rectangle with a blue border.

(550) I

(740) Miladin Popović, Đoka Miraševića 21/III, 81000, Podgorica

(511) Klasa 5: Farmaceutski preparati; vitaminski i mineralni dodaci ishrani za djecu; vitaminski preparati za djecu; kapi za nos u medicinske svrhe; medicinski sprejevi za nos; sprejevi za nos za smanjivanje kongestije; preparati za smanjivanje kongestije; dijetetski dodaci prehrani; dodaci ishrani koji se sastoje od aminokiselina.

Klasa 10: Medicinski aparati i instrumenti; nosni aspiratori.

Klasa 35: Oglašavanje; usluge oglašavanja u vezi sa lijekovima; pružanje komercijalnih informacija i savjeta potrošačima u pogledu izbora proizvoda i usluga.

---

(111) **15299**

(151) 24.03.2021.

(210) Ž-2020-247

(220) 08.07.2020.

(732) Pharmaceutical chemical cosmetic industry ALKALOID AD Skopje, blvd. Aleksandar Makedonski 12, 1000, Skopje, MK

(540)

## Becutan

(550) I

(740) Miladin Popović, Đoka Miraševića 21/III, 81000, Podgorica

(511) Klasa 5: Farmaceutski preparati; vitaminski i mineralni dodaci ishrani za djecu; vitaminski preparati za djecu; kapi za nos u medicinske svrhe; medicinski sprejevi za nos; sprejevi za nos za smanjivanje kongestije; preparati za smanjivanje kongestije; dijetetski dodaci prehrani; dodaci ishrani koji se sastoje od aminokiselina.

Klasa 10: Medicinski aparati i instrumenti; nosni aspiratori.

Klasa 35: Oglašavanje; usluge oglašavanja u vezi sa lijekovima; pružanje komercijalnih informacija i savjeta potrošačima u pogledu izbora proizvoda i usluga.

---

(111) **15300**

(151) 24.03.2021.

(210) Ž-2020-280

(220) 06.08.2020.

(732) Goodyear Tyres UK Limited, 2920 Trident Court, Solihull Parkway Birmingham Business Park, B37 7YN, Birmingham, GB

(540)

## QUALIFIER CORE

(550) I

(740) Jasna Jusić, Marka Radovića 37, 1. sprat, stan br. 4., 81000, Podgorica

(511) Klasa 12: Gume.

---

(111) **15301**

(151) 24.03.2021.

(210) Ž-2020-235

(220) 07.07.2020.

(732) Kent Gıda Maddeleri Sanayii ve Ticaret Anonim Şirketi, Cumhuriyet Mahallesi 2253, Sokak. No.11, 41400, Gebze, Kocaeli, TR

(540)

## JELIBON

(550) I

(740) Miladin Popović, Đoka Miraševića 21/III, 81000, Podgorica

(511) Klasa 30: Nemedicinski konditorski proizvodi, konditorski proizvodi od šećera, slatkiši i žvakaće gume.

---

(111) **15302**

(151) 24.03.2021.

(210) Ž-2020-52

(220) 14.02.2020.

(732) Kraft Foods Sverige Intellectual Property AB, Smedbyvaegen 8, 19486, Upplands-Vaesby, SE

(540)



(550) I

(740) Miladin Popović, Đoka Miraševića 21/III, 81000, Podgorica

(511) Klasa 29: Meso, riba, živina i divljač; mesni ekstrakti; konzervisano, sušeno i kuvano voće i povrće; želei, džemovi, mermelada, kompoti; jaja; mleko i mliječni proizvodi, jogurt; jestiva ulja i masti; paradajz pire i sok od paradajza; čips i grickalice na bazi krompira, povrća ili voća; orašasti plodovi pečeni, sušeni, usoljeni, začinjani i sa dodacima.

Klasa 30: Kafa, zamjene za kafu, čaj i kakao, uključujući napitke od njih; šećer i zaslađivači (prirodni); brašno i prehrambeni proizvodi od žitarica, žitarice za doručak, tjestenine i ostali proizvodi od tijesta, pice, ruske piroške, pite, hleb, peciva i konditorski proizvodi, uključujući čokolade i slatkiše; sladoled, sladoled od jogurta, smrznuti jogurt i led; so, senf, kečap, sirće, sosovi [dodaci hrani], začini, grickalice u obliku kokica i kukuruznog čipsa kao i grickalice na bazi kukuruza, pirinča, ječma, raži ili peciva.

---

(111) **15303**

(151) 24.03.2021.

(210) Ž-2020-225

(220) 29.06.2020.

(732) The Coca-Cola Company, One Coca-Cola Plaza, 30313, Atlanta, Georgia, US

(540)



(550) I

(740) Miladin Popović, Đoka Miraševića 21/III, 81000, Podgorica

(511) Klasa 5: Farmaceutski, medicinski i veterinarski preparati; sanitarni preparati za medicinske svrhe; dijetetska hrana i supstance prilagođene medicinskoj i veterinarskoj upotrebi, hrana za bebe; dijetetski suplementi za ljudsku upotrebu za ljude i životinje; flasteri, materijali za previjanje; materijali za plombiranje zuba, zubarska smola; dezinfektanti; preparati za uništavanje štetočina; fungicidi, herbicidi. Klasa 32: Piva; bezalkoholni napici; mineralne i gazirane vode; voćna pića i voćni sokovi; sirupi i drugi bezalkoholni preparati za pripremu napitaka.

---

(111) **15304**

(151) 25.03.2021.

(210) Ž-2020-241

(220) 07.07.2020.

(732) Mliječna industrija d.o.o, Sarajevska bb, Gradačac, BA

(540)



(550) I

(740) Ana Zeković, Bulevar Svetog Petra Cetinjskog 130/7, 81000, Podgorica

(511) Klasa 29: Jogurt, pića od mlijeka (mlijeko preovladava), proizvodi od mlijeka, kiselo mlijeko.

Klasa 30: Smrznuti jogurt.

---

(111) **15305**

(151) 25.03.2021.

(210) Ž-2020-242

(220) 07.07.2020.

(732) Mliječna industrija d.o.o, Sarajevska bb, Gradačac, BA

(540)



(550) I

(740) Ana Zeković, Bulevar Svetog Petra Cetinjskog 130/7, 81000, Podgorica

(511) Klasa 29: Jogurt, pića od mlijeka (mlijeko preovladava), proizvodi od mlijeka, kiselo mlijeko.

Klasa 30: Smrznuti jogurt.

---

(111) **15306**

(151) 25.03.2021.

(210) Ž-2020-243

(220) 07.07.2020.

(732) Mliječna industrija d.o.o, Sarajevska bb, Gradačac, BA

(540)



(550) I

(740) Ana Zeković, Bulevar Svetog Petra Cetinjskog 130/7, 81000, Podgorica

(511) Klasa 29: Mlijeko.

---

(111) **15307**

(151) 25.03.2021.

(210) Ž-2020-244

(220) 07.07.2020.

(732) Mliječna industrija d.o.o, Sarajevska bb, Gradačac, BA

(540)



(550) I

(740) Ana Zeković, Bulevar Svetog Petra Cetinjskog 130/7, 81000, Podgorica

(511) Klasa 29: Pavlaka (mliječni proizvod), kisela pavlaka, kefir, kumis (piće od mlijeka), pića od mlijeka (mlijeko preovladava), surutka, proizvodi od mlijeka, kiselo mlijeko, fermenti (mliječni) za kulinarske namjene.

---

(111) **15308**

(151) 25.03.2021.

(210) Ž-2020-245

(220) 07.07.2020.

(732) Mliječna industrija d.o.o, Sarajevska bb, Gradačac, BA

(540)





(550) I

(740) Ana Zeković, Bulevar Svetog Petra Cetinjskog 130/7, 81000, Podgorica

(511) Klasa 29: Pavlaka (mliječni proizvod), kisela pavlaka, kefir, kumis (piće od mlijeka), surutka, proizvodi od mlijeka, kiselo vrhnje za svjež sir, kiselo mlijeko, fermenti (mliječni) za kulinarske namjene, sir.

---

(111) **15309**

(151) 25.03.2021.

(210) Ž-2020-273

(220) 05.08.2020.

(732) ADD INDUSTRY (ZHEJIANG) CO.,LTD., No. 88 SHUANGGANG ROAD, 317600, YUHUAN CITY, ZHEJIANG, CN

(540)



(550) I

(740) Jasna Jusić, Marka Radovića 37, 1. sprat, stan br. 4., 81000, Podgorica

(511) Klasa 7: Uređaji za paljenje motora sa unutrašnjim sagorijevanjem; brizgaljke za motore; spojevi [djelovi motora]; glave cilindra za motore; klipovi za motore; pumpe [djelovi mašina, uređaja ili motora]; hidraulične komande za mašine, uređaje i motore; ležajevi [djelovi strojeva]; jastučići protiv trenja za mašine; kuglageri.

Klasa 12: Amortizeri za automobile; amortizeri (ublaživaci udara za vozila); opruge za ublažavanje udara za vozila; automobilske šasije; električna vozila; kvačila za kopnena vozila; pumpe za gume [oprema za vozila]; gume za točkove vozila; šasije vozila; kvačila za

kopnena vozila.

Klasa 17: Cilindrične spojnice; azbestni papir; prstenovi od gume; prstenovi za punjenje; gumeni čepovi; gume za ublažavanje udara; muf cijevi, ne od metala; zaptivke; zaptivna sredstva za spojeve; gumeni naglavci za zaštitu djelova mašina.

---

(111) **15310**

(151) 25.03.2021.

(210) Ž-2020-294

(220) 19.08.2020.

(732) H K Wentworth Limited, Ashby Business Park, Coalfield Way, Ashby-De-La-Zouch, LE65 1JR, Leicestershire, GB

(540)

The logo for ELECTROLUBE features the brand name in a bold, sans-serif font. Below the text is a horizontal bar with a rainbow color gradient from blue on the left to red on the right.

(550) I

(740) Jasna Jusić, Marka Radovića 37, 1. sprat, stan br. 4., 81000, Podgorica

(511) Klasa 2: Konzervansi protiv rđe; masti, ulja i preparati protiv rđe; sredstva protiv tamnjenja metala; zaštitna sredstva za metale; sredstva za sprječavanje korozije ili tamnjenja metala.

---

(111) **15311**

(151) 26.03.2021.

(210) Ž-2020-290

(220) 14.08.2020.

(732) BEIGENE, LTD.

C/O MOURANT OZANNES CORPORATE SERVICES, 94 SOLARIS AVE, CAMANA BAY, KY1-1108, GRAND CAYMAN, KY

(540)

The Brukinsa logo consists of a stylized graphic on the left, resembling a mountain peak or a sail, followed by the brand name "Brukinsa" in a bold, sans-serif font.

(550) I

(740) Miladin Popović, Đoka Miraševića 21/III, 81000, Podgorica

(511) Klasa 5: Lijekovi za ljudsku upotrebu; kapsule za farmaceutsku upotrebu; kapsule za lijekove; farmaceutski preparati; hemijsko-farmaceutski preparati; lijekovi za medicinsku upotrebu; hemijski preparati za farmaceutsku upotrebu; biološki preparati za medicinsku upotrebu; hemijski preparati za medicinsku upotrebu; dijagnostički biomarker reagensi za medicinsku upotrebu.

---

(111) **15312**

(151) 26.03.2021.

(210) Ž-2020-291

(220) 14.08.2020.

(732) BEIGENE, LTD. C/O MOURANT OZANNES CORPORATE SERVICES, 94 SOLARIS AVE, CAMANA BAY, KY1-1108, GRAND CAYMAN, KY

(540)

## BRUKINSA

(550) I

(740) Miladin Popović, Đoka Miraševića 21/III, 81000, Podgorica

(511) Klasa 5: Lijekovi za ljudsku upotrebu; kapsule za farmaceutsku upotrebu; kapsule za lijekove; farmaceutski preparati; hemijsko-farmaceutski preparati; lijekovi za medicinsku upotrebu; hemijski preparati za farmaceutsku upotrebu; biološki preparati za medicinsku upotrebu; hemijski preparati za medicinsku upotrebu; dijagnostički biomarker reagensi za medicinsku upotrebu.

---

(111) **15313**

(151) 26.03.2021.

(210) Ž-2020-202

(220) 12.06.2020.

(732) Netflix, Inc. , 100 Winchester Circle, 95032, Los Gatos, California, US

(540)

The logo for Netflix, consisting of the word "NETFLIX" in a bold, red, sans-serif font.

(550) I

(740) Jasna Jusić, Marka Radovića 37, 1. sprat, stan br. 4., 81000, Podgorica

(511) Klasa 9: Softver za striming audiovizuelnog i multimedijalnog sadržaja putem interneta i globalne komunikacione mreže; softver za striming audiovizuelnog i multimedijalnog sadržaja na mobilne digitalne elektronske uređaje; softver za pretraživanje, organizovanje, i preporučivanje multimedijalnog sadržaja; oprema za razvoj softvera za kreiranje softverskih i mobilnih aplikacija; računarski softver; računarski programi; računarske softverske aplikacije koje se mogu preuzimati; mobilne aplikacije koje se mogu preuzimati; softver za video igre; računarski softver za igre; interaktivni programi za video igre; kertridži i diskovi za računarske igre; programi i softveri za elektronske igre; softveri za elektronske igre za mobilne telefone, tablete, lične računare, i ručne elektronske uređaje; hardver i softver za igre virtuelne realnosti i proširene stvarnosti; igrani program i televizijske emisije koje se mogu preuzimati putem usluge video na zahtev; grafika koja sadrži setove digitalnih slika i ikona koja se može preuzimati za upotrebu na računarima, tabletima, i mobilnim telefonima; CD-ovi i DVD-ovi; igrani program i televizijske emisije koje se mogu preuzimati; audio knjige; melodije zvona i snimljeni zvuci koji se mogu preuzimati; audio i vizuelni snimci; muzički snimci; aparati za snimanje, prenos ili reprodukciju zvuka ili slike; audio i video snimci sa muzikom, muzičkim nastupima, i muzičkim spotovima koji se mogu preuzimati; podkastovi koji se mogu preuzimati; kodirane elektronske čip kartice; magnetno kodirane poklon kartice; elektronske publikacije; daljinski upravljači; uređaji za striming digitalnih medija; digitalni video rekorderi; DVD i plejeri za video diskove visoke rezolucije; sistemi za kućni bioskop koji se sastoje od audio i video resivera; disk plejeri; televizori; televizijski set top boksovi; računarski hardver i periferni uređaji; podloge za miš; oslonci za zglob i ruku koji se koriste sa računarima; stalci prilagođeni za mobilne telefone, tablet računare; digitroni; kamere; digitalne kamere; radio; USB fleš uređaji; zvučnici; vezice za mobilni telefon; maske za mobilni telefon; futrole za mobilni telefon; tastature za tablete; maske za tablet računare; futrole za tablet računare; maske na preklop za tablet računare; zaštitne maske i futrole za elektronske uređaje naime, računare, tablet računare, mobilne telefone, digitalne kamere, digitalne medija plejere, elektronske čitače knjiga, konzole za video igre, i lične digitalne asistente; zaštitne maske za displej; adapteri; slušalice; slušalice koje se stavljaju u uši; voki-toki; mobilni telefoni; pametni satovi; naočare; sunčane naočare; futrole za naočare i sunčane naočare; binokulari; ukrasni magneti; merni lenjiri; uveličavajuće staklo; mikrofoni; sportske kacige; kacige za bicikliste.

Klasa 38: Usluge prenosa audio i video sadržaja na zahtev; striming audio i video sadržaja; usluge prenosa glasa, podataka, slika, signala, poruka i informacija; usluge audio i vizuelnog emitovanja; usluge prenosa i isporuke audio i vizuelnog sadržaja; usluge prenosa videa na zahtev; pružanje onlajn foruma na kojima korisnici mogu da objavljuju ocene, recenzije i preporuke za filmove i televizijske emisije kao i za događaje i aktivnosti u oblasti zabave i edukacije.

Klasa 41: Usluge zabave; informacije u vezi sa zabavom; usluge filmske produkcije, osim reklamnih filmova; usluge pružanja filmova i televizijskih emisija, koji se ne mogu preuzeti, putem servisa za prenos videa na zahtev; pružanje informacija iz oblasti zabave putem veb-stranice; usluge zabavnih parkova; usluge zabave u smislu televizijskih serija i filmova u žanrovima akciona avantura, animacija, anime, biografija, klasik, komedija, kriminalistički, dokumentarni, drama, religijski, porodični, fantazija, film noar, istorija, horor, međunarodni, mjuzikl, misterija, romantični, naučna fantastika, sportski, triler, ratni i vestern; usluge

zabave u smislu vođenja izložbi i konvencija koje se tiču televizije i filma i televizijskih i filmskih likova; usluge zabave u smislu razvoja, kreiranja, produkcije, distribucije i post-produkcije igranih filmova, televizijskih emisija, posebnih događaja i multimedijalnog zabavnog sadržaja; usluge zabave u smislu pozorišnih, muzičkih ili komičarskih nastupa uživo; usluge klubova obožavalaca; usluge produkcije i distribucije igranih filmova i televizijskih emisija; pružanje usluga zabave putem globalne komunikacijske mreže u obliku onlajn igara i veb-stranica koje nude širok spektar informacija za zabavu od opšteg interesa u vezi sa igranim filmovima, televizijskim emisijama i programima, muzičkim videima, povezanim isečcima iz filmova, fotografijama i drugim multimedijalnim materijalima; usluge pružanja video klipova i drugog multimedijalnog sadržaja koji se ne može preuzeti, a koji sadrži audio, video, umetnička dela i tekst iz i u vezi sa zabavom, filmom, televizijom, televizijskim i filmskim likovima, muzikom i poznatim ličnostima; pružanje informacija iz oblasti zabave putem veb-sajta; usluge zabave, naime pružanje onlajn računarskih, elektronskih i video igara; usluge pružanja privremene upotrebe interaktivnih igara koje se ne mogu preuzeti; usluge pružanja informacija, recenzija i preporuka u vezi sa filmovima i televizijskim emisijama putem veb-sajta i servisa prenosa videa na zahtev; edukativne i zabavne usluge, naime pružanje interaktivnih onlajn televizijskih serija i filmova; usluge interaktivne zabave; usluge onlajn interaktivne zabave; usluge vođenja zabavnih događaja i aktivnosti; usluge interaktivnih, iskustvenih i duboko prožimajućih događaja za učešće publike i rekreativnih aktivnosti; usluge zabave u smislu organizacije i vođenja izložbi, konferencija i konvencija iz oblasti zabave, filma, televizije, televizijskih i filmskih likova, muzike i poznatih ličnosti; organizovanje i vođenje društvenih festivala koji promovišu muziku, umetnost, hranu, film, televiziju, pozorište, dramu, ples, muzičke nastupe uživo, govornike, pojavljivanja poznatih ličnosti i kulturne izložbe i aktivnosti; usluge pružanja onlajn stripova i grafičkih romana koji se ne mogu preuzeti; usluge radijske zabave; usluge produkcije i distribucije radio programa i zvučnih zapisa; usluge pružanja podkasta u oblasti zabave; usluge produkcije podkasta; usluge pružanja onlajn muzike koja se ne može preuzeti.

---

(111) **15314**

(151) 26.03.2021.

(210) Ž-2020-213

(220) 22.06.2020.

(732) GENERAL HOTEL MANAGEMENT LTD., P.O. BOX 71 CRAIGMUIR CHAMBERS,  
ROAD TOWN, TORTOLA, VG

(540)

THE CHEDI  
HOTELS & RESIDENCES

(550) I

(740) Jasna Jusić, Marka Radovića 37, 1. sprat, stan br. 4., 81000, Podgorica

(511) Klasa 43: Usluge biroa za smještaj (hoteli, pansioni); agencijske usluge za rezervaciju hotelskog smještaja; pružanje onlajn pregleda hotelskih smještaja; uređenje hotelskog smještaja; organizovanje hotelskih rezervacija; rezervacija hotelskog smještaja; usluge rezervacije hotela; usluge rezervacije hotelskog smještaja; usluge hotelskog smještaja; usluge kateringa za hotele; informacije o hotelima; usluge rezervacije hotela; usluge rezervacije hotela koje se pružaju putem interneta; rezervacije hotela; usluge bukiranja hotelskih soba; usluge rezervacije hotelskih soba; hotelske usluge; hotelske usluge za preferirane mušterije; hoteli; pravljenje hotelskih rezervacija za druge; pružanje smještaja u hotelima i motelima; obezbjeđivanje izložbenih objekata u hotelima; obezbjeđivanje hotelskog smještaja; pružanje onlajn informacija u vezi sa rezervacijama hotela; pružanje hotelskog smještaja; pružanje informacija koje se odnose na hotele; usluge prijema za privremeni smještaj (upravljanje dolascima i odlascima); katering za hranu i piće; priprema hrane i pića; obezbjeđivanje hrane i pića; pružanje usluga restorana; serviranje hrane i pića u restoranima i barovima; rezervacija hotelskog smještaja; usluge odmarališa; priređivanje svadbenih prijema (obezbjeđivanje hrane i pića); priređivanje svadbenih prijema (iznajmljivanje funkcionalnih soba).

---

(111) **15315**

(151) 26.03.2021.

(210) Ž-2020-255

(220) 17.07.2020.

(732) Caesars License Company, LLC (Nevada limited liability company), One Caesars Palace Drive, 89109, Las Vegas, NV, US

(540)



(550) I

(740) Božidar S.Radulović, Baku 30/5, 81000, Podgorica

(511) Klasa 35: Oglašavanje; konsultantske usluge u vezi sa vođenjem poslova i poslovnim upravljanjem; pomoć u poslovnom upravljanju; konsultantske usluge u vezi sa organizacijom poslovanja; poslovna prezentacija robe i usluga u sredstvima komunikacije, u svrhu maloprodaje; administriranje programa nagrađivanja koji omogućava učesnicima da dobiju popuste i besplatne nagrade za robu i usluge putem članstva; organizacija programa podsticanja članstva u komercijalne ili reklamne svrhe; pomoć u industrijskom ili komercijalnom upravljanju; uslužna administracija licenciranja robe i usluga drugih; unapređenje prodaje za druge; konsultantske usluge u vezi sa upravljanjem osobljem; usluge preseljenja za poslovne subjekte; prikupljanje informacija u kompjuterske baze podataka; obrada (administrativna) naloga za kupovinu; usluge računovodstva; iznajmljivanje mašina za prodaju; usluge maloprodajnih objekata i tržnih centara; usluge upravljanja i administriranja tržnih centara i maloprodajnih objekata.

Klasa 41: Usluge razonode; usluge kockarnica; usluge u vezi sa igranjem igara; usluge kockanja; obezbeđivanje objekata za kockanje; usluge u vezi sa igranjem interaktivnih igara; obezbeđivanje internet websajt portala u oblasti kompjuterskih igrica i igranja igara; usluge televizijske razonode; organizovanje i obezbeđivanje igara i takmičenja u svrhu razonode; obezbeđivanje virtuelnih okruženja u kojima korisnici mogu da stupe u interakciju putem društvenih igara u svrhu rekreacije, razonode ili zabave; organizovanje razonode za proslave venčanja; obezbeđivanje objekata za zabavu; usluge noćnih klubova; usluge diskoteka; usluge kabarea; usluge pozorišta i razonode koje uključuju muziku, ples, komediju, dramu i magiju; usluge zdravstvenih klubova; usluge klubova za rekreaciju i sportskih klubova; usluge klubova na plaži i bazenu; usluge golf klubova; obezbeđivanje objekata za golf; organizovanje golf turnira; usluge kantri klubova; obezbeđivanje sportskih objekata; usluge zabavnih parkova; usluge tematskih parkova; usluge objekata sa arkadnim igrama; usluge centara za razonodu; rezervacija nastupa koji uključuju muziku, komediju, ples, dramu i magiju; obezbeđivanje objekata za rekreativne aktivnosti; obezbeđivanje objekata za nastupe koji uključuju muziku, komediju, ples, dramu i magiju; organizovanje i sprovođenje atletskih događaja, atletskih takmičenja i sportskih događaja; organizovanje i promovisanje sportskih aktivnosti i takmičenja; usluge produkcije radijskog i televizijskog programa; usluge produkcije videa, filmova, audio kasete i elektronskih igara i opreme; obezbeđivanje onlajn publikacija; onlajn publikacija

elektronskih knjiga i časopisa; sprovođenje konjskih trka; upravljanje sportskim objektima i sportskim događajima; obezbeđivanje fizičkog vaspitanja i gimnastičkih objekata; usluge produkcije priredbi; usluge agencija za prodaju karata za pozorišta; organizovanje sastanaka i konferencija; obrazovne usluge; obezbeđivanje instrukcija i treninga u oblasti kockanja, sporta i razonode; usluge obuke za upravljanje hotelima; usluge kockarnica koje uključuju davanje popusta i besplatnih usluga za česte klijente putem korišćenja identifikacijske kartice; usluge informisanja, konsultantske i savetodavne usluge koje se odnose na sve napred navedeno.

Klasa 43: Usluge hotela, motela i odmarališta; usluge privremenog smeštaja; usluge brendiranih rezidencija; usluge uslužnih apartmana; usluge pansiona i kuća za goste; usluge smeštaja za odmor, usluge hostela i turističkih domova; usluge kampova za odmor; usluge staračkih domova; usluge rezervacije smeštaja u hotelima, motelima i odmaralištima; usluge rezervacije u svrhu iznajmljivanja privremenog smeštaja; usluge rezervacije za pansioni, kuće za goste, smeštaje za odmor, hostele i turističke domove; usluge rezervacije za brendirane rezidencije i uslužne apartmane; usluge agencije za

privremene smeštaje; usluge kantri kluba (pružanje smeštaja, hrane i pića); obezbeđivanje objekata i pratećih sadržaja za sastanke, konferencije, seminare, specijalne događaje (svadbe, slavlja) i bankete; obezbeđivanje izložbenih objekata i pratećih sadržaja; usluge restorana; usluge koktel barova; usluge barova; usluge privremenih soba za ručavanje; usluge samouslužnih restorana; usluge kafea; usluge restorana brze hrane; usluge kafića; usluge kateringa; usluge samouslužnih kantina; usluge dnevnog boravka za decu; usluge pansiona za životinje; iznajmljivanje soba za sastanke; obezbeđivanje kampova i iznajmljivanje prenosivih građevinskih objekata.

---

(111) **15316**

(151) 26.03.2021.

(210) Ž-2020-256

(220) 17.07.2020.

(732) Caesars License Company, LLC (Nevada limited liability company), One Caesars Palace Drive, 89109, Las Vegas, NV, US

(540)



(550) I

(740) Božidar S.Radulović, Baku 30/5, 81000, Podgorica

(511) Klasa 35: Oglašavanje; konsultantske usluge u vezi sa vođenjem poslova i poslovnim upravljanjem; pomoć u poslovnom upravljanju; konsultantske usluge u vezi sa organizacijom poslovanja; poslovna prezentacija robe i usluga u sredstvima komunikacije, u svrhu maloprodaje; administriranje programa nagrađivanja koji omogućava učesnicima da dobiju popuste i besplatne nagrade za robu i usluge putem članstva; organizacija programa podsticanja članstva u komercijalne ili reklamne svrhe; pomoć u industrijskom ili komercijalnom upravljanju; uslužna administracija licenciranja robe i usluga drugih; unapređenje prodaje za druge; konsultantske usluge u vezi sa upravljanjem osobljem; usluge preseljenja za poslovne subjekte; prikupljanje informacija u kompjuterske baze podataka; obrada (administrativna) naloga za kupovinu; usluge računovodstva; iznajmljivanje mašina za prodaju; usluge maloprodajnih objekata i tržišnih centara; usluge upravljanja i administriranja tržišnih centara i maloprodajnih objekata.

Klasa 41: Usluge razonode; usluge kockarnica; usluge u vezi sa igranjem igara; usluge kockanja; obezbeđivanje objekata za kockanje; usluge u vezi sa igranjem interaktivnih igara; obezbeđivanje internet websajt portala u oblasti kompjuterskih igrica i igranja igara; usluge televizijske razonode; organizovanje i obezbeđivanje igara i takmičenja u svrhu razonode;



obezbeđivanje virtuelnih okruženja u kojima korisnici mogu da stupe u interakciju putem društvenih igara u svrhu rekreacije, razonode ili zabave; organizovanje razonode za proslave venčanja; obezbeđivanje objekata za zabavu; usluge noćnih klubova; usluge diskoteka; usluge kabarea; usluge pozorišta i razonode koje uključuju muziku, ples, komediju, dramu i magiju; usluge zdravstvenih klubova; usluge klubova za rekreaciju i sportskih klubova; usluge klubova na plaži i bazenu; usluge golf klubova; obezbeđivanje objekata za golf; organizovanje golf turnira; usluge kantri klubova; obezbeđivanje sportskih objekata; usluge zabavnih parkova; usluge tematskih parkova; usluge objekata sa arkadnim igrama; usluge centara za razonodu; rezervacija nastupa koji uključuju muziku, komediju, ples, dramu i magiju; obezbeđivanje objekata za rekreativne aktivnosti; obezbeđivanje objekata za nastupe koji uključuju muziku, komediju, ples, dramu i magiju; organizovanje i sprovođenje atletskih događaja, atletskih takmičenja i sportskih događaja; organizovanje i promovisanje sportskih aktivnosti i takmičenja; usluge produkcije radijskog i televizijskog programa; usluge produkcije videa, filmova, audio kasete i elektronskih igara i opreme; obezbeđivanje onlajn publikacija; onlajn publikacija elektronskih knjiga i časopisa; sprovođenje konjskih trka; upravljanje sportskim objektima i sportskim događajima; obezbeđivanje fizičkog vaspitanja i gimnastičkih objekata; usluge produkcije priredbi; usluge agencija za prodaju karata za pozorišta; organizovanje sastanaka i konferencija; obrazovne usluge; obezbeđivanje instrukcija i treninga u oblasti kockanja, sporta i razonode; usluge obuke za upravljanje hotelima; usluge kockarnica koje uključuju davanje popusta i besplatnih usluga za česte klijente putem korišćenja identifikacijske kartice; usluge informisanja, konsultantske i savetodavne usluge koje se odnose na sve napred navedeno. Klasa 43: Usluge hotela, motela i odmarališta; usluge privremenog smeštaja; usluge brendiranih rezidencija; usluge uslužnih apartmana; usluge pansiona i kuća za goste; usluge smeštaja za odmor, usluge hostela i turističkih domova; usluge kampova za odmor; usluge staračkih domova; usluge rezervacije smeštaja u hotelima, motelima i odmaralištima; usluge rezervacije u svrhu iznajmljivanja privremenog smeštaja; usluge rezervacije za pansiona, kuće za goste, smeštaje za odmor, hostele i turističke domove; usluge rezervacije za brendirane rezidencije i uslužne apartmane; usluge agencije za privremene smeštaje; usluge kantri kluba (pružanje smeštaja, hrane i pića); obezbeđivanje objekata i pratećih sadržaja za sastanke, konferencije, seminare, specijalne događaje (svadbe, slavlja) i bankete; obezbeđivanje izložbenih objekata i pratećih sadržaja; usluge restorana; usluge koktel barova; usluge barova; usluge privremenih soba za ručavanje; usluge samouslužnih restorana; usluge kafea; usluge restorana brze hrane; usluge kafica; usluge kateringa; usluge samouslužnih kantina; usluge dnevnog boravka za decu; usluge pansiona za životinje; iznajmljivanje soba za sastanke; obezbeđivanje kampova i iznajmljivanje prenosivih građevinskih objekata.

---

(111) **15317**

(151) 31.03.2021.

(210) Ž-2020-7

(220) 15.01.2020.

(732) Luka Bešić, Vuka Karadžića 9, 81000, Podgorica, ME

(540)



(550) I

(511) Klasa 33: Alkoholna pića i vina.

Klasa 35: Maloprodaja i veleprodaja alkoholnih pića i vina.

---

(111) **15318**

(151) 31.03.2021.

(210) Ž-2020-51

(220) 13.02.2020.

(732) Marta Petrović, Škaljari br.20, 85330, Kotor, ME

(540)



(550) I

(511) Klasa 43: Usluge obezbjeđivanja hrane i pića; privremeno primanje na stan; usluge koje pružaju lica ili preduzeća čiji cilj je priprema jela ili pića za potrošnju kao i usluge ishrane i smještaja, koje pružaju hoteli, pansioni ili druga preduzeća koja osiguravaju privremeni smještaj; usluge rezervisanja smještaja za putnike, koje pružaju putničke agencije ili posrednici; usluge pansiona za životinje.

---

(111) **15319**

(151) 02.04.2021.

(210) Ž-2020-287

(220) 13.08.2020.

(732) TELEVIZIJA VIJESTI d.o.o. Podgorica, Trg Nezavisnosti bb, Podgorica, ME

(540)



(550) I

(740) Jelena Vujisić, Bulevar Ivana Crnojevića 56/2, 81000, Podgorica

(511) Klasa 9: USB uređaji [vanjski diskovi, priključci], videoekrani, videokamere, zvučni snimci (nosači zvučnih snimaka), zvuk (filmovi [trake] za snimanje zvuka), zvuk (uređaji za prijenos zvuka).

Klasa 35: Reklamiranje dopisnim putem, reklamiranje on-line na informatičkoj mreži, reklamiranje putem radija, reklamiranje putem televizije, reklamna dokumentacija (uređenje reklamne dokumentacije), reklamni filmovi (produkcija reklamnih filmova), reklamni tekstovi (uređenje reklamnih tekstova).

Klasa 38: Bežična radiodifuzija, emitovanje radio programa, emitovanje televizijskih programa, komuniciranje posredstvom mreža optičkih kablova, konferencije na daljinu (omogućavanje vođenja konferencija na daljinu), prenos digitalnih datoteka, prenos putem satelita, prenos poruka, prenos televizijskih emisija pretplatnicima putem kablova (kablovska televizija), prenos videosadržaja na zahtjev, radijska komunikacija, radiodifuzija, streaming podataka, usluge agencija za vijesti.

Klasa 41: Elektronske publikacije (iskorišćavanje elektronskih publikacija koje se ne mogu prenositi on line), fotografisanje, fotografske reportaže, iznajmljivanje radijskih i televizijskih aparata, iznajmljivanje rasvjetnih uređaja za pozorišnu dekoraciju i za televizijske studije, iznajmljivanje videokamera, iznajmljivanje videotraka, iznajmljivanje zvučnih snimaka, izrada scenarija, osim za potrebe oglašavanja, mikrofilmovi (snimanje na mikrofilmove), mikroizdavaštvo, montaža radijskih i televizijskih programa, obavještenja o vaspitanju, obavještenja o razonodi, organizovanje i provođenje obrazovnih foruma uživo, pisanje scenarija, pisanje tekstova, prikazivanje igranih filmova, pružanje filmova koji se ne mogu preuzeti putem usluga prenosa videozapisa na zahtjev, pružanje televizijskih programa koji se ne mogu preuzeti putem usluga prenosa videozapisa na zahtjev, razonoda posredstvom radija, razonoda posredstvom televizije, reporterske usluge, sinhronizacija, slobodno vrijeme (usluge za ispunjavanje slobodnog vremena), snimanje na videotrake, studio za snimanje (usluge studija za snimanje), titlovanje filmova, usluge razonode, videotrake (montaža videotraka).

---

(111) **15320**

(151) 06.04.2021.

(210) Ž-2018-353

(220) 12.09.2018.

(732) "KAFOTEKA" D.O.O., Vaka Đurovića bb, Podgorica, ME

(540)



(550) I

(511) Klasa 30: ( kafa, čaj, kakao, šećer, riža, tapioka, sago, zamjene za kafu; brašno i proizvodi od žitarica, hljeb, kolači, poslastice, bomboni, sladoled; med, sirup od melase; kvasac, prašak za pecivo; so, senf; sirće, prelive, začini, razni začini, led za hlađenje.)

Klasa 32: (pivo; mineralne i gazirane vade i ostala bezalkoholna pića; pića od voća i voćni sokovi; sirupi i ostali preparati za pripremanje napitaka .)

Klasa 33: ( alkoholna pića (osim piva) )

---

(111) **15321**

(151) 06.04.2021.

(210) Ž-2020-88

(220) 06.03.2020.

(732) Pharmaceutical chemical cosmetic industry ALKALOID AD Skopje, blvd. Aleksandar Makedonski 12, 1000, Skopje, MK

(540)



(550) I

(740) Miladin Popović, Đoka Miraševića 21/III, 81000, Podgorica

(511) Klasa 3: Nemedicinska kozmetika i toaletni preparati; nemedicinska sredstva za čišćenje zuba; parfimerija; etarska ulja; preparati za bijeljenje i druge supstance za upotrebu u perionicama; preparati za čišćenje, poliranje, ribanje i abrazivni preparati; sapuni; kozmetički preparati; losioni za kosu; maramice natopljene kozmetičkim losionima; preparati za čišćenje zuba; šamponi; parfemi; kozmetika za djecu; tečni deterdženti; kozmetički preparati za kupanje; toaletna voda; preparati za zaštitu od sunca; kozmetičke kreme; kozmetički preparati za njegu kože; losioni za kozmetičku upotrebu; ulja za kozmetičku upotrebu; ulje od jasmína; ulje od lavande; losioni za tjelo; kreme za lice; dezodoransi za tjelo; talk puder za toaletnu upotrebu.

Klasa 5: Farmaceutski, medicinski i veterinarski preparati; sanitarni preparati za upotrebu u medicini; dijetetska hrana i supstance prilagođene za upotrebu u medicini i veterinarstvu; hrana za bebe; pelene za bebe; dijetetski dodaci za ljude i životinje; flasteri; materijali za previjanje; materijali za plombiranje zuba, zubarski vosak; dezinfekciona sredstva; preparati za uništavanje štetočina; fungicidi, herbicidi.

Klasa 35: Oglašavanje; onlajn oglašavanje na kompjuterskoj mreži; poslovno upravljanje; poslovna administracija; kancelarijske usluge; reklamiranje.

---

(111) **15322**

(151) 06.04.2021.

(210) Ž-2020-89

(220) 06.03.2020.

(732) Pharmaceutical chemical cosmetic industry ALKALOID AD Skopje, blvd. Aleksandar Makedonski 12, 1000, Skopje, MK

(540)



(550) I

(740) Miladin Popović, Đoka Miraševića 21/III, 81000, Podgorica

(511) Klasa 3: Nemedicinska kozmetika i toaletni preparati; nemedicinska sredstva za čišćenje zuba; parfimerija; etarska ulja; preparati za bijeljenje i druge supstance za upotrebu u perionicama; preparati za čišćenje, poliranje, ribanje i abrazivni preparati; sapuni;

kozmetički preparati; losioni za kosu; maramice natopljene kozmetičkim losionima; preparati za čišćenje zuba; šamponi; parfemi; kozmetika za djecu; tečni deterdženti; kozmetički preparati za kupanje; toaletna voda; preparati za zaštitu od sunca; kozmetičke kreme; kozmetički preparati za njegu kože; losioni za kozmetičku upotrebu; ulja za kozmetičku upotrebu; ulje od jasmína; ulje od lavande; losioni za tjelo; kreme za lice; dezodoransi za tjelo; talk puder za toaletnu upotrebu.

Klasa 5: Farmaceutski, medicinski i veterinarski preparati; sanitarni preparati za upotrebu u medicini; dijetetska hrana i supstance prilagođene za upotrebu u medicini i veterinarstvu; hrana za bebe; pelene za bebe; dijetetski dodaci za ljude i životinje; flasteri; materijali za previjanje; materijali za plombiranje zuba, zubarski vosak; dezinfekciona sredstva; preparati za uništavanje štetočina; fungicidi, herbicidi.

Klasa 35: Oglašavanje; onlajn oglašavanje na kompjuterskoj mreži; poslovno upravljanje; poslovna administracija; kancelarijske usluge; reklamiranje.

---

(111) **15323**

(151) 06.04.2021.

(210) Ž-2020-90

(220) 06.03.2020.

(732) Pharmaceutical chemical cosmetic industry ALKALOID AD Skopje, blvd. Aleksandar Makedonski 12, 1000, Skopje, MK

(540)



(550) I

(740) Miladin Popović, Đoka Miraševića 21/III, 81000, Podgorica

(511) Klasa 3: Nemedicinska kozmetika i toaletni preparati; nemedicinska sredstva za čišćenje zuba; parfimerija; etarska ulja; preparati za bijeljenje i druge supstance za upotrebu u perionicama; preparati za čišćenje, poliranje, ribanje i abrazivni preparati; sapuni; kozmetički preparati; losioni za kosu; maramice natopljene kozmetičkim losionima; preparati za čišćenje zuba; šamponi; parfemi; kozmetika za djecu; tečni deterdženti; kozmetički preparati za kupanje; toaletna voda; preparati za zaštitu od sunca; kozmetičke kreme; kozmetički preparati za njegu kože; losioni za kozmetičku upotrebu; ulja za kozmetičku

upotrebu; ulje od jasmina; ulje od lavande; losioni za tjelo; kreme za lice; dezodoransi za tjelo; talk puder za toaletnu upotrebu.

Klasa 5: Farmaceutski, medicinski i veterinarski preparati; sanitarni preparati za upotrebu u medicini; dijetetska hrana i supstance prilagođene za upotrebu u medicini i veterinarstvu; hrana za bebe; pelene za bebe; dijetetski dodaci za ljude i životinje; flasteri; materijali za previjanje; materijali za plombiranje zuba, zubarski vosak; dezinfekciona sredstva; preparati za uništavanje štetočina; fungicidi, herbicidi.

Klasa 35: Oglašavanje; onlajn oglašavanje na kompjuterskoj mreži; poslovno upravljanje; poslovna administracija; kancelarijske usluge; reklamiranje.

---

(111) **15324**

(151) 07.04.2021.

(210) Ž-2020-91

(220) 06.03.2020.

(732) KT & G Corporation , 71, Beotkkot-gil, Daedeok-gu, Daejeon, KR

(540)

**ESSE GOLDEN LEAF**

(550) I

(740) Miladin Popović, Đoka Miraševića 21/III, 81000, Podgorica

(511) Klasa 34: Duvan; cigarete; cigare; burmut; papir za cigarete; lule za duvan; filteri za cigarete; kutije za cigarete (ne od plemenitih metala); vrećice za duvan; upaljači za cigarete (ne od plemenitih metala); šibice; sredstva za čišćenje lula za duvan; pepeljare (ne od plemenitih metala); rezači za cigare.

---

(111) **15325**

(151) 07.04.2021.

(210) Ž-2020-125

(220) 16.04.2020.

(732) BÜROTIME MOBILYA SANAYI VE TICARET ANONIM ŞİRKETİ , Konya Organize Sanayi Bölgesi, Evrenköy Caddesi, No:5, Selçuklu-Konya, TR

(540)

**bürotime**

(550) I

(740) Miladin Popović, Đoka Miraševića 21/III, 81000, Podgorica

(511) Klasa 20: Namještaj, izrađen od bilo koje vrste materijala; dušeci, jastuci, vazdušni dušeci i jastuci, koji nijesu za medicinsku upotrebu, vodeni kreveti, koji nijesu za medicinsku upotrebu; ogledala; košnice, vještačka saća i dijelovi od drveta za saće; stolice za ljuljanje beba, ogradice za bebe, kolijevke, šetalice za bebe; oglasne table, okviri za slike i slikarske radove, identifikacione pločice, koje nijesu od metala; identifikacione oznake, koje nijesu od metala. pločice za ime, koje nijesu od metala; identifikacione oznake od drveta ili sintetičkog materijala; posude za pakovanje od drveta ili plastike, burad za upotrebu u transportu ili za skladištenje, bačve, bubnjevi za skladištenje, tankovi, kutije, kontejneri za skladištenje, kontejneri za transport, sanduci, palete za utovar i zatvarači za gore navedenu robu, sve od drveta ili plastike; sitno oruđe od drveta ili sintetičkih materijala koji su obučeni ovom klasom, oprema za namještaj, od drveta ili sintetičkih materijala, ukrasi i ukrasna roba od drveta, plute, trske za pletenje, trske, pruća, roga, kosti, slonovače, kitove kosti, školjke, ćilibara, sedefa, morske pjene, pčelinjeg voska, plastike ili gipsa, obuhvaćeni ovom klasom, naime figurine, praznični ornamenti za zidove i skulpture, sve izrađeno od drveta, plute, trske za pletenje, trske, pruća, roga, kosti, slonovače, kitove kosti, školjke, ćilibara, sedefa, morske pjene, pčelinjeg voska, plastike ili gipsa; korpe, koje nijesu od metala; korpe za ribolov; kućice, legla i kreveti za kućne ljubimce; prenosive merdevine i pokretne stepenice od drveta ili sintetičkih materijala; zavjese od bambusa, valjci za unutrašnje roletne od letvica [za enterijere], pločaste unutrašnje roletne, zavjese od perli za dekoraciju, kuke za zavjese, prstenovi za zavjese, omče i petlje za zavjese, šipke za zavjese; klinovi za točkiće, koji nijesu od metala.

---

(111) **15326**

(151) 07.04.2021.

(210) Ž-2020-107

(220) 13.03.2020.

(732) Mika Montenegro DOO, Miloja Pavlovića br.5, 81000, Podgorica, ME

(540)



(550) I

(511) Klasa 29: Zakuske [mali obroci od voća pripremljeni na brzinu]; voćna kaša [pulpa]; voćne kriške; voćne salate; voće, kuvano; voće (konzervisano u alkoholu); uštipci od



krompira; supe od mesnih koncentrata; supe od povrća (sastojci za pripremanje supe od povrća); supe od zeleniša; supe, čiste, mesne [bujoni]; salate od povrća; salate od voća; povrće (salate od povrća); pekmezi; mliječni frapei; meso; krompirići (prženi krompirići) [čips]; kobasice [salame]; džemovi.

Klasa 30: Zakuske [mali brzi obroci] od riže, zakuske [mali obroci] od žitarica, voćno tijesto [poslastica]; voćni kolači; visokoproteinske pločice od žitarica; vafel proizvodi; ukrasi za kolače, jestivi; torte; tortilje; tijesto za kolače; špageti; šerbet [voćni sladoled]; šećerni proizvodi; suvi kolačići; sushi [japansko jelo od riže]; sladoled; sendviči; sendviči od sira [cheeseburgeri]; salata (umaci za salatu); riža; riža (kolačići od riže); ravioli [tjestenina]; prehrambena tjestenina; praline; pizza; pića od čokolade; pića od kafe; pića od kakaoa; pecivo (fi no sitno pecivo)pecivo [brioši]; palačinke; panceroate; mlijeko, čokoladno [napitak]; mesne pite; makaroni [vrsta tjestenine]; krekeri; kolači; krofna - obična / sa šećerom; krofne sa raznim voćnim / čokoladnim punjenjima i glazurom; jela od brašna; medenjaci; hljeb; čokolada; čokoladne figurice (srce, jaje, slovo, broj i razni predmeti); čokolada (piće od čokolade); čokoladni musevi [pjenice]; čajni kolačići [minjoni].

Klasa 35: Iznajmljivanje reklamnih prostora; marketing, objavljivanje reklamnih tekstova; odnosi s javnošću [propaganda]; oglašavanje [reklamiranje]; pomoć u vođenju poslova; poslovne informacije; preduzeća (pomoć u vođenju komercijalnih ili industrijskih preduzeća); reklamiranje on-line na informatičkoj mreži; reklamni tekstovi (objavljivanje reklamnih tekstova); sajmovi (organizovanje sajmova u komercijalne ili reklamne svrhe); savjeti o organizaciji i vođenju poslova; tržište (traženje tržišta).

Klasa 41: Seminari (organizovanje i vođenje seminara); organizovanje i vođenje seminara; organizovanje i vođenje radionica za stručno osposobljavanje; objavljivanje tekstova [osim u reklamne svrhe]; obuka [predavanje]; obuka putem dopisivanja; planiranje prijema [razonoda]; priredbe (održavanje priredbi); priredbe (organizovanje priredbi) [usluge impresarija]; priredbe (proizvodnja priredbi).

Klasa 43: Ugostitelji (usluge kateringa); restorani; restorani sa samoposluživanjem, restorani za brzo i stalno posluživanje [snek-barovi]; kafane [kafeterije]; kafane-restorani.

---

(111) **15327**

(151) 07.04.2021.

(210) Ž-2020-108

(220) 13.03.2020.

(732) Mika Montenegro DOO, Miloja Pavlovića br.5, 81000, Podgorica, ME

(540)

**Šik&Šiz, LJUBAV NA PRVI GRIZ**

(550) I

(511) Klasa 29: Zakuske [mali obroci od voća pripremljeni na brzinu]; voćna kaša [pulpa]; voćne kriške; voćne salate; voće, kuvano; voće (konzervisano u alkoholu); uštipci od krompira; supe od mesnih koncentrata; supe od povrća (sastojci za pripremanje supe od povrća); supe od zeleniša; supe, čiste, mesne [bujoni]; salate od povrća; salate od voća; povrće (salate od povrća); pekmezi; mliječni frapei; meso; krompirići (prženi krompirići)

[čips]; kobasice [salame]; džemovi.

Klasa 30: Zakuske [mali brzi obroci] od riže, zakuske [mali obroci] od žitarica, voćno tijesto [poslastica]; voćni kolači; visokoproteinske pločice od žitarica; vafel proizvodi; ukrasi za kolače, jestivi; torte; tortilje; tijesto za kolače; špageti; šerbet [voćni sladoled]; šećerni proizvodi; suvi kolačići; sushi [japansko jelo od riže]; sladoled; sendviči; sendviči od sira [cheeseburgeri]; salata (umaci za salatu); riža; riža (kolačići od riže); ravioli [tjestenina]; prehrambena tjestenina; praline; pizza; pića od čokolade; pića od kafe; pića od kakaoa; pecivo (fi no sitno pecivo) pecivo [brioši]; palačinke; panceroate; mlijeko, čokoladno [napitak]; mesne pite; makaroni [vrsta tjestenine]; krekeri; kolači; krofna - obična / sa šećerom; krofne sa raznim voćnim / čokoladnim punjenjima i glazurom; jela od brašna; medenjaci; hljeb; čokolada; čokoladne figurice (srce, jaje, slovo, broj i razni predmeti); čokolada (piće od čokolade); čokoladni musevi [pjenice]; čajni kolačići [minjoni].

Klasa 35: Iznajmljivanje reklamnih prostora; marketing, objavljivanje reklamnih tekstova; odnosi s javnošću [propaganda]; oglašavanje [reklamiranje]; pomoć u vođenju poslova; poslovne informacije; preduzeća (pomoć u vođenju komercijalnih ili industrijskih preduzeća); reklamiranje on-line na informatičkoj mreži; reklamni tekstovi (objavljivanje reklamnih tekstova); sajmovi (organizovanje sajmova u komercijalne ili reklamne svrhe); savjeti o organizaciji i vođenju poslova; tržište (traženje tržišta).

Klasa 41: Seminari (organizovanje i vođenje seminara); organizovanje i vođenje seminara; organizovanje i vođenje radionica za stručno osposobljavanje; objavljivanje tekstova [osim u reklamne svrhe]; obuka [predavanje]; obuka putem dopisivanja; planiranje prijema [razonoda]; priredbe (održavanje priredbi); priredbe (organizovanje priredbi) [usluge impresarija]; priredbe (proizvodnja priredbi).

Klasa 43: Ugostitelji (usluge kateringa); restorani; restorani sa samoposluživanjem, restorani za brzo i stalno posluživanje [snek-barovi]; kafane [kafeterije]; kafane-restorani.

---

(111) **15328**

(151) 07.04.2021.

(210) Ž-2020-92

(220) 06.03.2020.

(732) Khayrat Al-Manafa for General Trade and Public Transport Limited Liability company, 27, Saborni str., Varna, BG

(540)



(550) I

(740) Božidar S. Radulović, Studentska bb, Lamela 3/18, 81000, Podgorica

(511) Klasa 34: Duvan; duvan za zamotavanje; zamjena za duvan; proizvodi od duvana; aromatizovani duvan; filteri za duvan; lule za duvan; sirovi duvan; duvan za žvakanje; šibice; sigurnosne šibice; cigarete; cigare; proizvodi za pušače; pribor za pušenje; upaljači za pušače; pepeljare za pušače.

---

(111) **15329**

(151) 07.04.2021.

(210) Ž-2020-93

(220) 06.03.2020.

(732) Khayrat Al-Manafa for General Trade and Public Transport Limited Liability company, 27, Saborni str., Varna, BG

(540)



(550) I

(740) Božidar S. Radulović, Studentska bb, Lamela 3/18, 81000, Podgorica

(511) Klasa 34: Duvan; duvan za zamotavanje; zamjena za duvan; proizvodi od duvana; aromatizovani duvan; filteri za duvan; lule za duvan; sirovi duvan; duvan za žvakanje; šibice; sigurnosne šibice; cigarete; cigare; proizvodi za pušače; pribor za pušenje; upaljači za pušače; pepeljare za pušače.

---

(111) **15330**

(151) 07.04.2021.

(210) Ž-2020-214

(220) 16.06.2020.

(732) SINDIKALNA ORGANIZACIJA KLINIČKOG CENTRA CRNE GORE, DŽONA DŽEKSONA 6, 81000, PODGORICA, ME

(540)



(550) I

(511) Klasa 35: Oglašavanje i reklamiranje, vođenje komercijalnih poslova, komercijalna administracija, kancelarijski poslovi.

Klasa 41: Obuka, stručno osposobljavanje, razonoda, sportske i kulturne djelatnosti.

Klasa 42: Naučne i tehnološke usluge kao i pripadajuće usluge istraživanja i koncepcije, usluge industrijskih analiza i istraživanja koncepcija i razvoj računara i računarskih programa -hardvera i softvera.

Klasa 45: Pravne usluge sigurnosne usluge za zaštitu imovine i lica, lične i društvene usluge koje pružaju drugi, namijenjene za zadovoljenje ljudskih potreba.

---

(111) **15331**

(151) 07.04.2021.

(210) Ž-2020-109

(220) 17.03.2020.

(732) Intercontinental Great Brands LLC, 100 Deforest Avenue, 07936, East Hanover, New Jersey, US

(540)

HALLS Udahni i tamo si

(550) I

(740) Miladin Popović, Đoka Miraševića 21/III, 81000, Podgorica

(511) Klasa 5: Medicinski konditorski proizvodi.

Klasa 30: Ne-medicinski konditorski proizvodi, čokolade, šećerni konditorski proizvodi, konditorski proizvodi uključujući sladić, karamele, slatkiše, žele, bombone, žvakaće gume, smrznute poslastice, ohlađene poslastice, sladoled, kolače, kekse i deserte.

---

(111) **15332**

(151) 07.04.2021.

(210) Ž-2020-185

(220) 23.03.2020.

(732) TAIYAKI FACTORY DOO BEOGRAD - STARI GRAD, Žorža Klemansoa 18, 11000, Beograd - Stari Grad, RS

(540)



(550) I

(740) Ana Vukčević, Bulevar Džordža Vašingtona br. 98, The Capital Plaza VIII sprat, 81000, Podgorica

(511) Klasa 30: Sladoled na točenje; kafa; zeleni čaj; palačinke; vafel proizvodi; desertni sufleji; korneti za sladoled.

Klasa 32: Voćni napici i sokovi;

Klasa 43: Usluge obezbeđivanja hrane i pića.

---

(111) **15333**

(151) 07.04.2021.

(210) Ž-2020-117

(220) 24.03.2020.

(732) Tav-Tech Ltd., Haatzmaut Street, Top Rasco Building 40, PO Box 1167, 56000, Yehud, IL

(540)

**JETPEEL**

(550) I

(740) Miladin Popović, Đoka Miraševića 21/III, 81000, Podgorica

(511) Klasa 10: Hirurški, medicinski i zubarski aparati i instrumenti; aparati za estetsku masažu; gore navedena roba nije u vezi sa aparatima i instrumentima za piling.

---

(111) **15334**

(151) 07.04.2021.

(210) Ž-2019-17

(220) 29.01.2019.

(732) ERSTE BANK AD, Aresenija Boljevića 2A, 81000, Podgorica, ME

(540)

The future is yours.

(550) I

(511) Klasa 36: Osiguranje, finansijski poslovi; novčani (monetarni) poslovi; poslovi vezani za nepokretnosti.

---

(111) **15335**

(151) 07.04.2021.

(210) Ž-2019-267

(220) 08.07.2019.

(732) "Roberto's Company" doo, Sunčana obala 152, Zelenika, H.Novi, ME

(540)

Roberto's

(550) I

(511) Klasa 43: Kafane [kafeterije]; kafane-restorani; restorani; restorani sa samoposluživanjem; restorani za brzo i stalno posluživanje [snek-barovi]; barovi (usluge barova).

---

(111) **15336**

(151) 07.04.2021.

(210) Ž-2018-273

(220) 25.07.2018.

(732) Košarkaški klub Budućnost VOLI, Podgorica, Njegošev Park bb, Podgorica, ME

(540)



(550) I

(511) Klasa 35: Oglašavanje i reklamiranje; vođenje komercijalnih poslova; komercijalna administracija; kancelarijski poslovi; vođenje poslova poslovnici za sportiste [poslovni menadžment]; televizijsko reklamiranje; sajmovi ( organizovanje sajmova u komercijalne ili reklamne svrhe ); reklamiranje putem televizije; marketing; javno mnijenje (istraživanje javnog mnjenja) [anketiranje]; javnost (odnosi s javnošću) [propaganda]; isporuka reklamnih materijala [letaka, prospekata, uzoraka].

Klasa 37: Izgradnja; popravke; usluge postavljanja (instaliranja); čišćenje zgrada [spoljnih površina]; izgradnja \*; zaštite građevina od vlage [izgradnja]; zgrade (čišćenje zgrada) [spoljnih površina]; zgrade (unutrašnje čišćenje zgrada).

Klasa 41: Obuka; stručno osposobljavanje; razonoda; sportske i kulturne djelatnosti; objavljivanje knjiga i časopisa, elektronski on line; zdravstveni klubovi (usluge zdravstvenih klubova) [održavanje zdravlja i fizičke forme]; videotrake (montaža videotraka); videotrake (proizvodnja filmova na videotrakama); treniranje [fizička vježba]; sportska oprema (stavljanje na raspolaganje sportske opreme ); sportska takmičenja (mjerjenje vremena na sportskim takmičenjima); sportska takmičenja ( organizovanje sportskih takmičenja); razonoda; rekreacija ( obavještenja u vezi rekreacije ); seminari ( organizovanje i vođenje seminara); sportska usavršavanja (sportski kampovi za usavršavanje u sportu); sportske oprema (iznajmljivanje sportske opreme osim vozila); -stadioni (iznajmljivanje stadiona); priredbe ( održavanje priredbi); organizovanje sportskih takmičenja; lični treneri (usluge ličnih trenera) [fitnes]; kampovi za sportsko usavršavanje; iznajmljivanje sportskih terena; fizičke vježbe [fizička kultura]; informacije u vezi rekreacije.

---

(111) **15337**

(151) 09.04.2021.

(210) Ž-2020-172

(220) 26.05.2020.

(732) ALLIANCE D.O.O., CETINJSKI PUT BB, 81000, PODGORICA, ME

(540)



(550) I

(511) Klasa 35: Maloprodaja:automobila, rezervnih djelova, vina, sokova, sladoleda, toplih, napitaka (kafa, čaj). Veleprodaja:automobila, rezervnih djelova, vina.

Klasa 37: Oправка i održavanje motornih vozila (zamjena ulja, opravka i zamjena dotrajalih djelova na vozilu, limarsko-lakirerski radovi); Tehnički pregled i registracija motornih vozila.

Klasa 41: Učestvovanje na sajmovima.

Klasa 42: Tehnički pregled i registracija motornih vozila.

---

(111) **15338**

(151) 09.04.2021.

(210) Ž-2020-142

(220) 06.05.2020.

(732) Lambda Group d.o.o. Bar, Bulevar revolucije 10-B, 85000, Bar, ME

(540)



(550) I

(511) Klasa 36: Finansijski poslovi; Monetarni poslovi;Usluge u vezi sa finansijskim i monetarnim poslovima; Usluge u vezi sa izdavanjem faktura; usluge vođenja računovodstvene dokumentacije: usluge administriranja finansijskom dokumentacijom; usluge izrade finansijskih izvještaja; usluge elektronske fiskalizacije izdatih faktura/računa.

Klasa 42: Naučne i tehnološke usluge kao i pripadajuće usluge istraživanja i koncepcije; usluge industrijskih analiza i istraživanja; koncepcija i razvoj računara i računarskih programa/ hardvera i softvera/; usluge koje pružaju lica, individualno ili kolektivno, u vezi s teorijskim ili praktičnim vidovima složenih područja djelatnosti; usluge inženjera koji se bave procjenama, ocjenama, istraživanjima i izvještajima u području nauke i tehnologije; usluge naučnih istraživanja u statističke svrhe.

---



(111) **15339**

(151) 12.04.2021.

(210) Ž-2020-149

(220) 07.05.2020.

(732) KT & G Corporation , 71, Beotkkot-gil, Daedeok-gu, Daejeon, KR

(540)

## TIME

(550) I

(740) Miladin Popović, Đoka Miraševića 21/III, 81000, Podgorica

(511) Klasa 34: Duvan; cigarete; cigare; burmut; papir za cigarete; lule za duvan; filteri za cigarete; kutije za cigarete (ne od plemenitih metala); kesice za duvan; upaljači za cigarete (ne od plemenitih metala); šibice; sredstva za čišćenje lula za duvan; pepeljare za pušače (ne od plemenitih metala); rezači za cigare.

---



## ***INDUSTRIJSKI DIZAJN***

## ***INDUSTRIAL DESIGN***

**MEĐUNARODNI KODOVI ZA IDENTIFIKACIJU BIBLIOGRAFSKIH  
PODATAKA O DIZAJNU PREMA WIPO CT.80  
RECOMMENDATION CONCERNING BIBLIOGRAPHIC DATA RELATING TO  
INDUSTRIAL DESIGNS WIPO CT.80**

<b>CRNOGORSKI</b>	<b>MDK</b>	<b>ENGLESKI</b>
Registarski broj	<b>11</b>	Number of registration
Datum registracije	<b>15</b>	Date of the registration
Očekivani datum isteka registracije	<b>18</b>	Expected expiration date of the registration
Broj prijave	<b>21</b>	Number of the application
Datum podnošenja prijave	<b>22</b>	Date of filing of the application
Podaci o izložbenom pravu prvenstva	<b>23</b>	Exhibition priority data
Broj prijavljenih dizajna	<b>28</b>	Number of industrial designs included in the application
Podaci o pravu prvenstva na osnovu Pariske konvencije	<b>30</b>	Data relating to priority under the Paris Convention
Klasa i podklasa Lokarnske klasifikacije	<b>51</b>	Class and subclass of the Locarno Classification
Naziv dizajna	<b>54</b>	Title of the industrial design
Prikaz	<b>55</b>	Reproduction of the industrial design (e.g., drawing, photograph) and explanations relating to the reproduction
Ime autora dizajna	<b>72</b>	Name of the creator
Ime i adresa nosioca prava	<b>73</b>	Name and address of the owner
Ime i adresa punomoćnika	<b>74</b>	Name and address of the representative

**OBJAVE OBNOVE VAŽENJA INDUSTRIJSKOG DIZAJNA**  
PUBLICATION OF INDUSTRIAL DESIGN RENEWAL

(11) 00035

(18) 07.08.2023. godine

(21) D-2008-5

(73) Allied Domecq Spirits & Wine Limited, Chivas House, 72 Chancellors Road, London W6  
9RS, United Kingdom

CIP – Katalogizacija u publikaciji  
Nacionalna biblioteka Crne Gore „Đurđe Crnojević“  
347.77/78 (497.16)  
Crnogorski glasnik intelektualne svojine: Službeni glasnik  
Ministarstva ekonomskog razvoja Crne Gore = Official  
Gazete of the Ministry of Economic Development  
Glavni i odgovorni urednik: Dragana Ranitović  
2021, br.38 -740 - Podgorica  
(Bulevar Mihaila Lalića broj 1): Ministarstvo ekonomskog  
razvoja, 2021. - 30 cm  
Tromjesečno.  
ISSN 1800-8003 = Crnogorski glasnik intelektualne svojine  
(Podgorica)  
COBISS.CG-ID 15168784